

FEATURES

Low Cost
 Direct Interface to AD590 or AC2626 Sensors
 Large 0.56" Red Orange LED Display
 Accuracy to $\pm 1.0^\circ \pm 1$ Digit
 Either ac Line or +5V dc Powered
 Temperature Range: -55°C to $+150^\circ\text{C}$
 -67°F to $+302^\circ\text{F}$

1000V rms Isolation (ac)
 Terminal Block Interface
 Small Size, Panel Mount

APPLICATIONS

Temperature Monitoring in Design, Laboratory,
 Manufacturing and Quality Control for Both
 +5V dc or Line Powered Applications

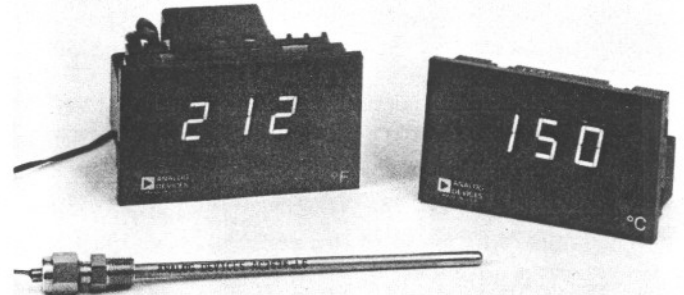

GENERAL DESCRIPTION

The AD2040 is a low-cost 3 digit temperature indicator. Based on the highly successful AD2026 low-cost DPM and designed to be used in conjunction with Analog Devices' AC2626 general purpose probe or the AD590 temperature transducer, the AD2040 is available in both 5V logic-powered, or ac line-powered versions.

The 5V powered AD2040-12 reads out directly in $^\circ\text{C}$, $^\circ\text{F}$, $^\circ\text{R}$ or K. A precision voltage reference, resistor network, and span and zero adjusts, needed to implement display of the different temperature scales, are all self-contained. User selectable degree readout, as well as all other connections, i.e., +5V power and sensor or probe interface, are all made via a terminal block on the rear.

For many stand-alone temperature measurement applications, i.e., in factories, labs; ovens, inspection stations, etc., +5V dc power is not available. For these applications, the AD2040 is available in an ac version. The ac-powered version retains all of the features of the 5V version, with exception of the user selectable degree readout. $^\circ\text{C}$ or $^\circ\text{F}$ must be specified when ordering (see Ordering Guide, page 2).

If required, calibration adjustments are easily accessible. No mounting hardware of any kind is used.

The AD2040 and AC2626 or AD590 will measure and display temperatures on large 0.56" orange LED displays from -55°C to $+150^\circ\text{C}$ (-67°F to $+302^\circ\text{F}$) with accuracy to $\pm 1.0^\circ \pm 1$ digit. Reliability is assured with the inherent simplicity and accuracy of the sensor, combined with the highly efficient design of the AD2040.

THE SENSOR

The AD590 is a laser-calibrated, two terminal IC temperature

transducer. Its output is a current ($1\mu\text{A}$ per K) linearly proportional to absolute temperature, thus eliminating the need for costly linearization and cold junction compensation.

Due to the AD590's high impedance current output, it is insensitive to voltage drops over long lines thus enabling remote monitoring with no need for costly transmitters or special wire.

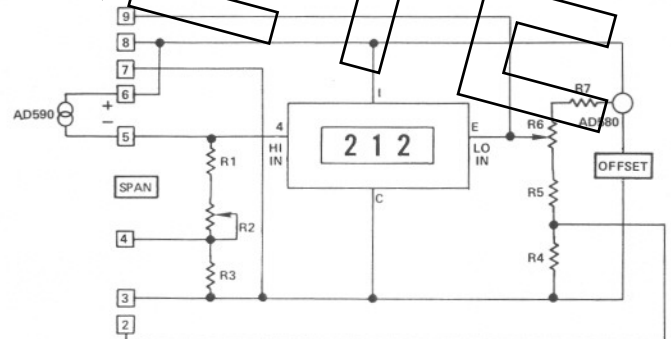

AD2040-12 (dc) Block Diagram

Above is a block diagram of the AD2040-12, showing the AD2026 DPM input, the current-to-voltage conversion resistors (R1, R2, R3), the offsetting resistance network (R4, R5, R6, R7), and the connections to the terminal strip. Attenuated voltage from the AD580, 2.5V reference, provides the offsets for readout on the $^\circ\text{F}$ and $^\circ\text{C}$ scales. On the AD2040-12 dc version, jumpers are connected by the user at the terminal strip to select the appropriate units of temperature for display. $^\circ\text{C}$ or $^\circ\text{F}$ must be specified when ordering the ac version (see Ordering Guide, page 2).

Information furnished by Analog Devices is believed to be accurate and reliable. However, no responsibility is assumed by Analog Devices for its use; nor for any infringements of patents or other rights of third parties which may result from its use. No license is granted by implication or otherwise under any patent or patent rights of Analog Devices.

P.O. Box 280; Norwood, Massachusetts 02062 U.S.A.
 Tel: 617/329-4700
 Telex: 924491
 Twx: 710/394-6577
 Cables: ANALOG NORWOODMASS

SPECIFICATIONS (typical @ +25°C and nominal supply unless otherwise specified)

ACCURACY

- Resolution: 1°
- Range: -55°C to +150°C
-67°F to 302°F
218K to 423K
425°R to 793°R
- Accuracy: (±1 digit)¹
Calibration Error @ +25°C
Absolute Error (overrated performance temperature range)
Without External Calibration Adjustment
With +25°C Calibration Error Set to Zero
Nonlinearity
- Temperature Coefficient:
Offset: 0.03 degrees/degree
Span: 70ppm/°C
- Common Mode Rejection (ac)
117dB, 1000V rms max Common Mode Voltage
- Normal Mode Rejection
30dB @ 50-60Hz

AC2626J/ AD590J	AC2626K/ AD590K	AC2626L/ AD590L	AC2626M/ AD590M
±5.0°C max	±2.5°C max	±1.0°C max	±0.5°C max
±10.0°C max	±5.5°C max	±3.0°C max	±1.7°C max
±3.0°C	±2.0°C max	±1.6°C max	±1.0°C max
±1.5°C	±0.8°C max	±0.4°C max	±0.3°C max

DISPLAY OUTPUT²

- 7 Segment, Red Orange, LED 0.56" (13mm) High for 7 Data Digits
- Sensor Disconnect Indication: --- (for °C and °F only)
- DPM Positive Overload: EEE
- DPM Negative Overload: ---
- No Indication of Out of Sensor Range

INPUT IMPEDANCE

- °C, K: 1.0KΩ
- °F, °C: 1.8KΩ

CONVERSION RATE

- 4 Conversions Per Second

POWER INPUT

- +5.0V ±5%; 160mA (dc version)
- AC Line 50-400Hz; See Voltage Options Below

ORDERING GUIDE

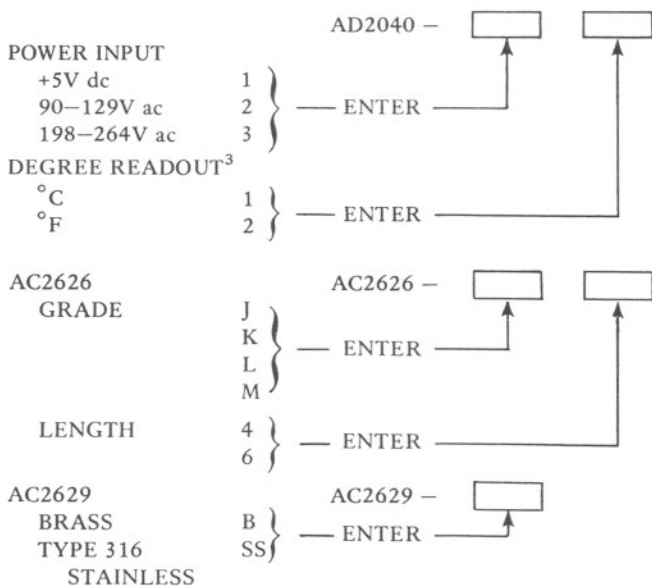

POWER INPUT (ac Line Power)

- AC Line Power, 50-60Hz, 1.5 Watts

CALIBRATION ADJUSTMENTS

- Span
- Zero
- Gain
- Offset
- Recommended Recalibration Interval: Six Months

SIZE

- 3.43" W × 2.0" H × 1.65" D (87 × 52 × 42mm)
- Panel Cutout Required: 3.175 ±0.015" × 1.810 ±0.015" (80.65 ±0.38 × 45.97 ±0.38mm)

WEIGHT

- 3 ounces (88 grams) (+5V dc)
- 7 ounces (198 grams) (ac Line Powered)

NOTES:

- Overall accuracy of meter plus sensor over entire range.
- Leading zero cannot be blanked.
- Select Degree Readout when ordering ac version only. (+5V dc version offers user selectable temperature scales—see Table 1. For +5V dc version enter 2, e.g., AD2040-12.)

Specifications subject to change without notice.

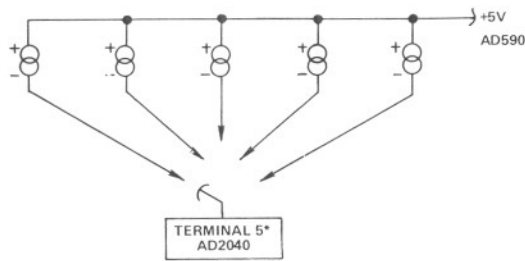

*TERMINAL 5 IS -SENSOR INPUT ON THE +5V DC VERSION. THIS TERMINAL IS TERMINAL #2 ON THE AC VERSION.

Figure 1. Manual Switching with Multiple Inputs

MULTIPLE SENSOR INPUTS

Expansion to multiple sensors via manual switching is shown in Figure 1. The sensor selected will pass a signal current through the current measuring circuitry, internal to the AD2040. Similarly automatic switching, shown in Figure 2 is accomplished. A low level input on an inverter input will allow selection of the appropriate AD590.

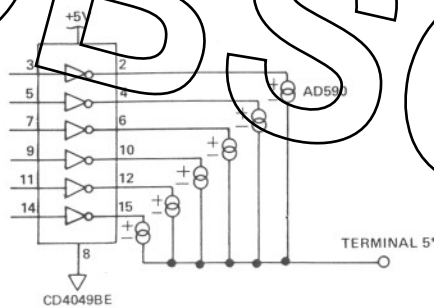

*TERMINAL 5 IS -SENSOR INPUT ON THE +5V DC VERSION. THIS TERMINAL IS TERMINAL #2 ON THE AC VERSION.

Figure 2. Automatic Switching

SCALE	TERMINAL 2	TERMINAL 3	TERMINAL 4	TERMINAL 9
°C	X	X	X	
°F				
K		X	X	X
°R		X		X

Table 1. Temperature Scale Selection (+5V dc Only)

TEMPERATURE SCALE SELECTION

As shown in Table 1 any of the standard temperature scales may be displayed using the +5V dc AD2040-12.

The AD2040-12dc version is factory calibrated in degrees Fahrenheit. Readout in degrees Celsius, Rankine or Kelvin are achieved via simple jumper connections on the terminal block, listed in the above table. (Connect terminals marked X.)

Figure 3 shows how the AD2040, in conjunction with 4 resistors, 2 trim pots, and a dual comparator, can be used to control as well as monitor particular applications via high and low set points. When the voltage at the AD2040 sense terminal (terminal 5) goes higher than the Hi Limit Set Voltage, the

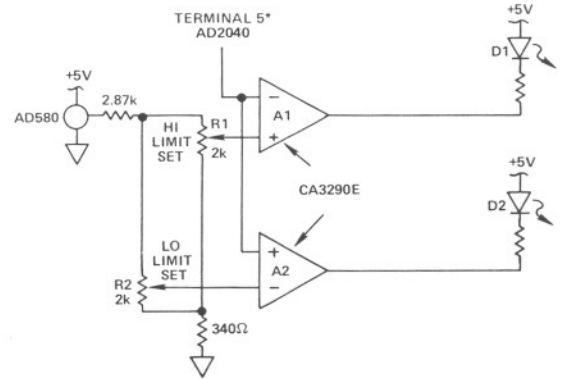

*TERMINAL 5 IS -SENSOR INPUT ON THE +5V DC VERSION. THIS TERMINAL IS TERMINAL #2 ON THE AC VERSION.

Figure 3. Hi and Low Set Points

output of A1 goes low and D1 is illuminated. Similarly when the voltage at terminal 5 goes below the Lo Limit Set Voltage, the output of A2 goes low illuminating D2.

To set the high limit, replace the AD590 with a variable resistor. Adjust the resistor until the desired high temperature set point is displayed on the meter. Adjust R1 until D1 is just turning on. Repeat procedure for R2 (Lo Limit Set).

CALIBRATION PROCEDURE

The AD2040 is factory calibrated using an ideal sensor. The dc version is calibrated in °F and the ac version is calibrated to order. If sensor accuracy is adequate, no calibration is required (see note). If a lower grade sensor is used (i.e., J) and calibration is required, adjust Span Adjust on the rear with sensor at a known temperature for that temperature, e.g. for °F place sensor in Ice Bath at 32° F and adjust span for reading of 32.

Recalibration may be required after six (6) months; if so, proceed as follows:

1. With AD590 disconnected, short input of AD2040 (terminal 5 to 9 on dc version, or 2 to 3 on ac version). Remove AD2040 lens and adjust Front Panel **[ZERO]** Adjust to display 000.
2. Attach AD590 sensor and stabilize at a known Reference Temperature; i.e., Ice Bath. Connect terminal 9 to terminal 3 (on dc version) or terminal 3 to access port (on ac version) and adjust Rear **[SPAN]** Adjust for a display of 273 plus Reference Temperature for °C or 460 plus Reference Temperature for °F.
3. Remove jumper between terminals 9 and 3 (dc version) or 3 and access port (ac version). Adjust the Rear **[OFFSET]** Adjust for Reference Temperature. (For K or °R omit step 3.)

For optimum linearity calibration, for °C, repeat steps two (2) and three (3) with Reference Temperature at 0. Then with sensor at 100°C adjust Front Panel **[GAIN]** Adjust for a meter display of 100. Other high end temperatures may be used with this procedure as long as they are known to be accurate.

For °F repeat steps two and three with Reference Temperature at 32° F. Then with sensor at the high temperature, adjust Front Panel **[GAIN]**. Adjust for readout equal to high temperature. The above temperature can be selected for optimum linearity over users temperature range.

NOTE: If other than °F readout on the dc version is desired, follow step 2 and 3 of Recalibration Procedure.

OUTLINE DIMENSIONS

Dimensions shown in inches and (mm).

AD2040 (ac)

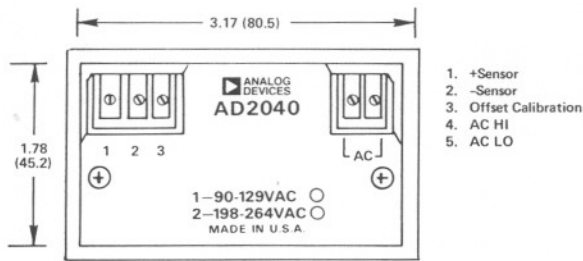

REAR VIEW

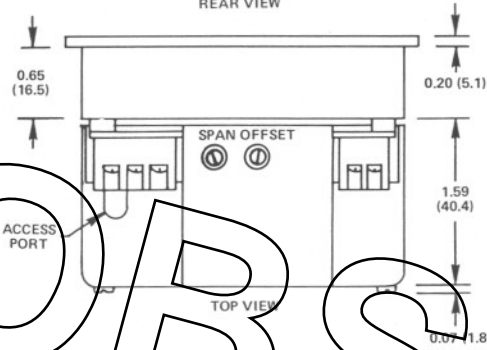

AD2040 (dc)

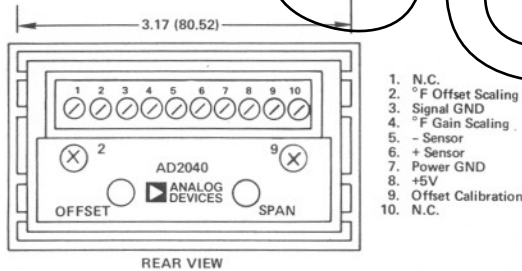

REAR VIEW

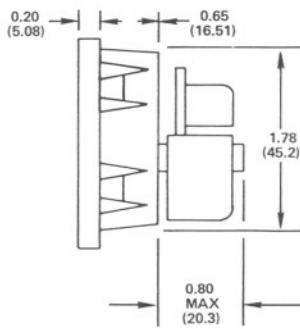

THE AC2626

The AC2626 is a stainless steel tubular probe measuring 3/16 inch (4.76mm) in outside diameter and is available in 6 inch (152.4mm) or 4 inch (101.6mm) lengths. Based on the new AD590F, the probe is available in linearity grades of 0.3°C, 0.4°C, 0.8°C or 1.5°C.

The probe is designed for both liquid and gaseous immersion applications as well as temperature measurements in refrigeration or any general temperature monitoring application.

For taking measurements in pipes or other closed vessels, the AD2629 compression fitting is available. The AC2629 may be applied anywhere along the probe and is supplied in two materials. The low cost AC2629B is constructed of brass and the higher priced AC2629SS is made of stainless steel.

AC2626

3/16 STAINLESS STEEL TUBING TYPE 316
FILLED WITH THERMALLY CONDUCTIVE EPOXY

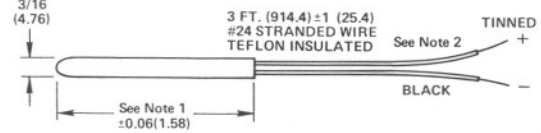

AC2629

COMPRESSION FITTING (See Note 3)
STAINLESS STEEL TYPE 316

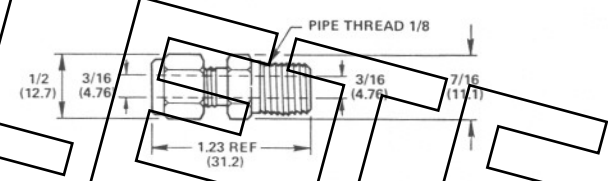

NOTE 1 Probes are available in 4-inch or 6-inch lengths.

NOTE 2 + lead wire is color coded: J, yellow; K, orange; L, blue; M, green.

NOTE 3 When assembling compression fitting (AC2629) to probe, tighten the 1/2" nut 3/4's of a turn from finger tight.

The AD590 temperature transducer is available in two packages—the "H" package (TO-52) and the "F" package (ceramic flat pack).

AD590 F PACKAGE

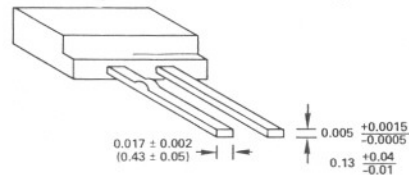
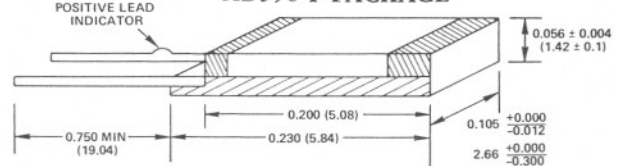

AD590H (TO-52)

