

16-Bit, 33 MUPS, Multispan, Multi-IO SPI DAC

FEATURES

- ▶ 16-bit resolution
- ▶ 33 MUPS single channel rate in fast mode
- ▶ 22 MUPS single channel rate in precision mode
- ▶ 65 ns small signal settling time to 0.1% accuracy
- ▶ 100ns large signal settling time to 0.1% accuracy
- ▶ Ultra small glitch: < 50 pV_{xs}
- ▶ Ultra low latency: 5 ns
- ▶ THD: -105 dB at 1 kHz
- ▶ Highly configurable output voltage span and offset
- ▶ 1.2 V and 1.8 V logic level compatible
- ▶ Single (classic), dual, and quad SPI modes
- ▶ Multiple error detectors, both analog and digital domains
- ▶ 2.5 V internal voltage reference, 10 ppm/°C maximum temperature coefficient
- ▶ 5 mm × 5 mm LFCSP

APPLICATIONS

- ▶ Instrumentation
- ▶ Hardware in the loop
- ▶ Process control equipment
- ▶ Medical devices
- ▶ Automated test equipment
- ▶ Data acquisition system
- ▶ Programmable voltage sources
- ▶ Optical communications

FUNCTIONAL BLOCK DIAGRAM

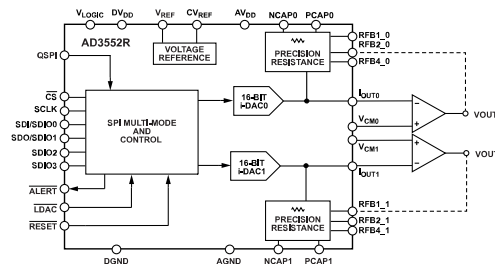

Figure 1.

GENERAL DESCRIPTION

The AD3552R is a low drift, ultra-fast, 16-bit accuracy, current output digital-to-analog converter (DAC) that can be configured in multiple voltage span ranges. The AD3552R operates with a fixed 2.5 V reference.

The device incorporates three drift compensating feedback resistors for the required external transimpedance amplifier (TIA) that scales the output voltage. Offset and gain scaling registers allow for generation of multiple output span ranges, such as 0 V to 2.5 V, 0 V to 5 V, 0 V to 10 V, -5 V to +5 V, and -10 V to +10 V, and custom intermediate ranges with full 16-bit resolution.

The DAC can operate in fast mode for maximum speed or precision mode for maximum accuracy.

The SPI interface can be configured in single SPI (classic SPI) mode, dual SPI mode, synchronous dual SPI mode, and quad SPI mode with single data rate (SDR) or double data rate (DDR), with logical levels from 1.2 V to 1.8 V.

To improve device robustness, cyclic redundancy check (CRC) can be enabled. Multiple error checkers have also been integrated to detect V_{REF} failures or memory map corruption.

The AD3552R is specified over the extended industrial temperature range (-40°C to +105°C).

Table 1. Related Devices

Part No.	Description
AD8675	36 V precision, 2.8 nV/√Hz rail-to-rail output operational amplifier
AD8065	High performance, 145 MHz FastFET™ operational amplifiers
ADA4807-1	3.1 nV/√Hz, 1 mA, 180 MHz, rail-to-rail input/output amplifier
ADR4525	Ultralow noise, high accuracy, 2.5 V voltage reference

Analog Devices is in the process of updating documentation to provide terminology and language that is culturally appropriate. This is a process with a wide scope and will be phased in as quickly as possible. Thank you for your patience.

TABLE OF CONTENTS

Features.....	1	SPI Register Map Access.....	25
Applications.....	1	Serial Interface.....	32
General Description.....	1	DAC Update Modes.....	35
Functional Block Diagram.....	1	Power-Down.....	36
Specifications.....	3	Reset.....	36
Electrical Characteristics.....	3	Error Detection.....	36
AC Characteristics.....	4	Alert Pin.....	38
Timing Characteristics.....	5	Device ID.....	38
Absolute Maximum Ratings.....	10	Summary of Interface Access Modes.....	38
Thermal Resistance.....	10	Registers.....	40
ESD Caution.....	10	Register Summary.....	40
Pin Configuration and Function Descriptions.....	11	Interface Register Details.....	43
Typical Performance Characteristics.....	13	DAC Register Details.....	52
Terminology.....	22	Applications Information.....	66
Theory of Operation.....	24	Power Supply Recommendations.....	66
Product Description.....	24	Combining DAC Channels.....	66
DAC Architecture.....	24	Layout Guidelines.....	66
Predefined Output Voltage Spans.....	24	Outline Dimensions.....	68
Custom Output Voltage Span.....	25	Ordering Guide.....	68
Transfer Function.....	25	Evaluation Boards.....	68
V _{REF}	25		

REVISION HISTORY**2/2022—Rev. 0 to Rev. A**

Changes to Figure 13 and Table 7.....	11
Changes to Figure 92.....	66

1/2022—Revision 0: Initial Version

SPECIFICATIONS

ELECTRICAL CHARACTERISTICS

$V_{DD} = 5.0\text{ V} \pm 5\%$, $DV_{DD} = 1.8\text{ V} \pm 5\%$, $1.1\text{ V} \leq V_{\text{LOGIC}} \leq 1.9\text{ V}$, $V_{\text{REF}} = 2.5\text{ V}$, $-40^\circ\text{C} \leq T_A \leq +105^\circ\text{C}$, output amplifier [AD8675](#), unless otherwise noted.

Table 2.

Parameter ¹	Symbol	Min	Typ	Max	Unit	Test Conditions/Comments
STATIC PERFORMANCE						
Resolution		16			Bits	
Relative Accuracy (INL)		-2		+2	LSB	5 V range only
		-4		+4	LSB	All other ranges ²
Differential Nonlinearity (DNL)		-1		+1	LSB	Precision mode: -40°C to $+105^\circ\text{C}$, fast mode: 0°C to 85°C
		-2		+2	LSB	Fast mode: -40°C to $+105^\circ\text{C}$
		-2		+2	LSB	0 V to 2.5 V range, fast or precision modes ²
Offset Error			0.03		%FSR	Midscale, 25°C
Offset Error Drift ²			2	8	ppm FSR/ $^\circ\text{C}$	0 V to 5 V and 0 V to 10 V ranges
			4	16	ppm FSR/ $^\circ\text{C}$	All other ranges
Full-Scale Error			0.04		%FSR	25°C
Full-Scale Error Drift ²			1	5	ppm FSR/ $^\circ\text{C}$	0 V to 5 V and 0 V to 10 V ranges
			4	12	ppm FSR/ $^\circ\text{C}$	All other ranges
Zero-Scale Error ³			0.05		%FSR	25°C
Zero-Scale Error Drift ²			3.5	8	ppm FSR/ $^\circ\text{C}$	0 V to 5 V and 0 V to 10 V ranges
			7	16	ppm FSR/ $^\circ\text{C}$	All other ranges
Total Unadjusted Error (TUE)		-0.5		+0.5	%FSR	
DC Power Supply Rejection Ratio (PSRR)			0.6		mV/V	DAC code = midscale
DC Crosstalk			3		$\mu\text{V/V}$	Full-scale step
OUTPUT CHARACTERISTICS						
Output Current	I_{OUTX}		1.6		mA	Absolute value
REFERENCE OUTPUT						
Output Voltage		2.492	2.5	2.508	V	At 25°C , over lifetime
Voltage Reference Temperature Coefficient (TC) ⁴			3	10	ppm/ $^\circ\text{C}$	
Output Impedance			50		m Ω	
Output Voltage Noise			2.7		$\mu\text{V rms}$	0.1 Hz to 10 Hz
Output Voltage Noise Density			173		$\text{nV}/\sqrt{\text{Hz}}$	$f = 1\text{ kHz}$, no load on V_{REF}
			164		$\text{nV}/\sqrt{\text{Hz}}$	$f = 10\text{ kHz}$, no load on V_{REF}
Capacitive Load Stability ²				10	μF	
Load Regulation			50		$\mu\text{V}/\text{mA}$	At 25°C
Output Current Load Capability			± 8		mA	
Line Regulation			135		$\mu\text{V/V}$	At 25°C
REFERENCE INPUT						
Reference Current			1		μA	
Reference Input Range ²	V_{REF}	2.4	2.5	2.6	V	
Reference Input Impedance			3		M Ω	
LOGIC INPUTS						
Input Current	I_{IN}	-1		+1	μA	Per pin
Input Low Voltage	V_{INL}			$0.35 \times V_{\text{LOGIC}}$	V	
Input High Voltage	V_{INH}	$0.65 \times V_{\text{LOGIC}}$			V	

SPECIFICATIONS

Table 2.

Parameter ¹	Symbol	Min	Typ	Max	Unit	Test Conditions/Comments
Pin Capacitance	C _{IN}		4		pF	
LOGIC OUTPUTS						
Output Low Voltage	V _{OL}			0.20 × V _{LOGIC}	V	I _{SINK} = 100 μA
Output High Voltage	V _{OH}	0.80 × V _{LOGIC}			V	I _{SOURCE} = 100 μA
Pin Capacitance	C _{IN}		4		pF	
POWER REQUIREMENTS						
V _{LOGIC} Pin		1.1	1.8	1.89	V	
V _{LOGIC} Current	I _{LOGIC}		1	7.5	μA	V _{INH} = V _{LOGIC} × 0.9, V _{INL} = V _{LOGIC} × 0.1
V _{LOGIC} Dynamic Current	I _{LOGIC_DYNAMIC}		3	5	mA	SCLK = 66 MHz, quad SPI DDR, V _{INH} = V _{LOGIC} × 0.65, V _{INL} = V _{LOGIC} × 0.35
DV _{DD} Pin		1.71	1.8	1.89	V	
DV _{DD} Current	I _{DVDD}		0.5	0.8	mA	
DV _{DD} Dynamic Current	I _{DVDD_DYNAMIC}		42	60	mA	SCLK = 66 MHz, quad SPI DDR
AV _{DD} Pin		4.75	5	5.25	V	
AV _{DD} Current	I _{DD}		22	28.5	mA	Channel 0 and Channel 1 zero-scale, 0 V to ±5 V range
AV _{DD} Power-Down Current	I _{DD}		0.6		mA	After reset, DACs powered down
AV _{DD} Reset Current	I _{DD}		120		μA	RESET asserted

¹ See the [Terminology](#) section.

² Guaranteed by design and characterization, not production tested.

³ Measured at zero code.

⁴ Reference temperature coefficient is calculated as per the box method.

AC CHARACTERISTICS

AV_{DD} = 5.0 V ± 5%, DV_{DD} = 1.8 V ± 5%, 1.1 V ≤ V_{LOGIC} ≤ 1.9 V, -40°C ≤ T_A ≤ +105°C, measured with the [ADA4807-1](#) external amplifier, unless otherwise noted.

Table 3.

Parameter ¹	Min	Typ	Max	Unit	Test Conditions/Comments
DYNAMIC PERFORMANCE					
Output Voltage Settling Time		100		ns	2 V step, 0.1% error, 0 V to 5 V range
		75		ns	2 V step, 1% error, 0 V to 5 V range
		65		ns	60 mV step, 0.1% error, 0 V to 5 V range
		15		ns	60 mV step, 1% error, 0 V to 5 V range
Slew Rate		100		V/μs	Full-scale step, 0 V to 2.5 V range
Digital-to-Analog Glitch Impulse		50		pV×s	0 V to 5 V range, ±1 LSB change around major carry
Digital Feedthrough		25		pV×s	50 MHz clock, RFB2_x
DAC to DAC Crosstalk		6.5		pV×s/V	Full-scale step, RFB2_x
AC PSRR		80		dB	1 kHz, RFB1_x
		43		dB	1 MHz, RFB1_x
Output Noise Spectral Density		15		nV/√Hz	DAC code = midscale, external reference, 10 kHz, NCAPx = 1.2 μF, PCAPx = none, RFB1_x
		30		nV/√Hz	RFB2_x
		60		nV/√Hz	RFB4_x
Output Noise		3.8		μV _{RMS}	DAC code = midscale, external reference, 1 Hz to 10 kHz, NCAPx = 1.2 μF, PCAPx = none, RFB1_x

SPECIFICATIONS

Table 3.

Parameter ¹	Min	Typ	Max	Unit	Test Conditions/Comments
Total Harmonic Distortion		7.6		μV_{RMS}	RFB2_x
		15.4		μV_{RMS}	RFB4_x
		-105		dB	0 V to 5 V range, $f_{\text{OUT}} = 1 \text{ kHz}$
		-101		dB	$f_{\text{OUT}} = 10 \text{ kHz}$
SFDR		-84		dB	$f_{\text{OUT}} = 100 \text{ kHz}$
		-105		dB	0 V to 5 V range, $f_{\text{OUT}} = 1 \text{ kHz}$

¹ See the Terminology section.

TIMING CHARACTERISTICS

$V_{\text{DD}} = 5.0 \text{ V} \pm 5\%$, $DV_{\text{DD}} = 1.8 \text{ V} \pm 5\%$, $1.1 \text{ V} \leq V_{\text{LOGIC}} \leq 1.9 \text{ V}$, $-40^\circ\text{C} \leq T_{\text{A}} \leq +105^\circ\text{C}$, unless otherwise noted.

Table 4.

Parameter ^{1,2}	Description	Min	Typ	Max	Unit	Test Conditions / Comments
f_{SCLK}	SCLK frequency			66	MHz	
t_1	SCLK cycle time	15.2			ns	
$t_{\text{SCLK}2}$	SCLK half period	7.6			ns	
t_2	$\overline{\text{CS}}$ falling edge to first SCLK rising edge	5			ns	
t_3	Last SCLK sampling edge ³ to $\overline{\text{CS}}$ rising edge	10			ns	
t_4	$\overline{\text{CS}}$ falling edge from SCLK sampling edge ignored	5			ns	
t_5	$\overline{\text{CS}}$ rising edge to SCLK rising edge ignored	5			ns	
t_6	Minimum $\overline{\text{CS}}$ high time	10			ns	
t_7	Data setup time	2			ns	
t_8	Data hold time	2			ns	
t_9	SCLK falling edge to SDO data valid			15	ns	$1.7 < V_{\text{LOGIC}} < 1.9$
				25	ns	$1.1 < V_{\text{LOGIC}} < 1.7$
t_{10}	SCLK sampling edge to $\overline{\text{LDAC}}$ falling edge	7.6			ns	
t_{11}	$\overline{\text{LDAC}}$ pulse width low	7.6			ns	
t_{12}	$\overline{\text{CS}}$ rising edge to SDO disabled		50		ns	
t_{13}	$\overline{\text{LDAC}}$ rising edge to $\overline{\text{CS}}$ falling edge	5			ns	
t_{14}	RESET pulse width low	10			ns	t_{14} to t_{19} shown in Figure 12
t_{15}	RESET pulse activation time			100	ns	
t_{16}	V_{OUT} Update from CHx_DAC Register Write		12.6		ns	
t_{17}	V_{OUT} update from $\overline{\text{LDAC}}$ falling edge		5		ns	
t_{18}^4	Wait time before DAC register access	100			ms	
t_{19}^5	Shutdown exit time		5		ms	
Update Rate	Quad SPI mode, DDR and streaming enabled, precision mode			22	MUPS ⁶	
	Quad SPI mode, DDR and streaming enabled, fast mode			33	MUPS ⁶	

¹ All input signals are specified with $t_{\text{R}} = t_{\text{F}} = 1 \text{ ns/V}$ (10% to 90%) and timed from a voltage level of $(V_{\text{IL}} + V_{\text{IH}})/2$.

² Guaranteed by design and characterization, not production tested.

³ The SCLK sampling edge refers to the SCLK edge where the data is read in (sampled)

⁴ Same timing must be expected at power-up from the instant that $AV_{\text{DD}} = 4 \text{ V}$ or $DV_{\text{DD}} = 0.8 \text{ V}$.

⁵ Time required to exit power-down to normal mode.

⁶ MUPS is mega updates per second.

SPECIFICATIONS

Timing Diagrams

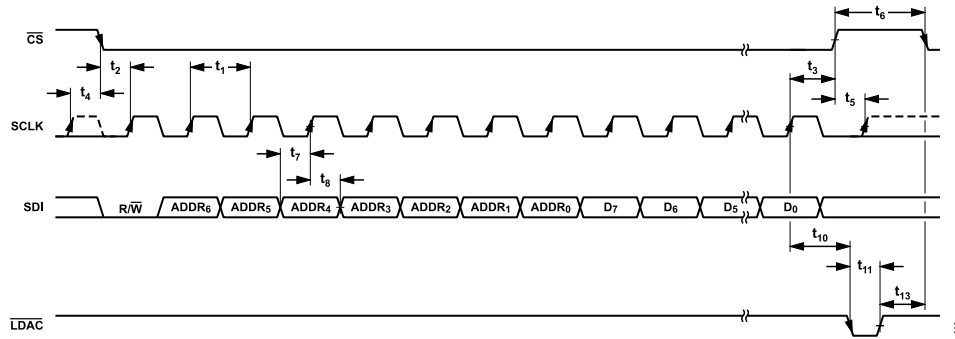

Figure 2. Classic SPI Write Operation with Single Data Rate

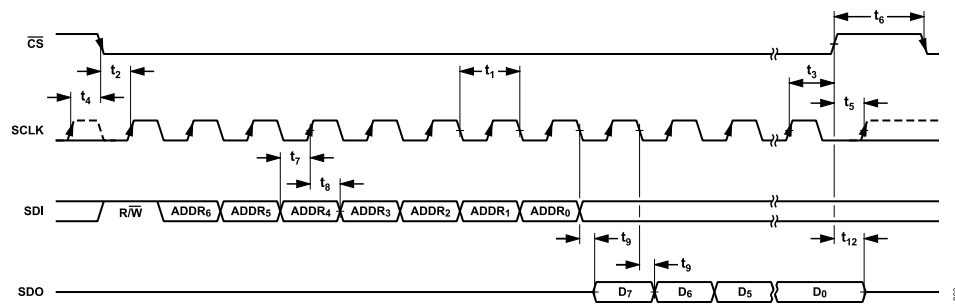

Figure 3. Classic SPI Read Operation with Single Data Rate

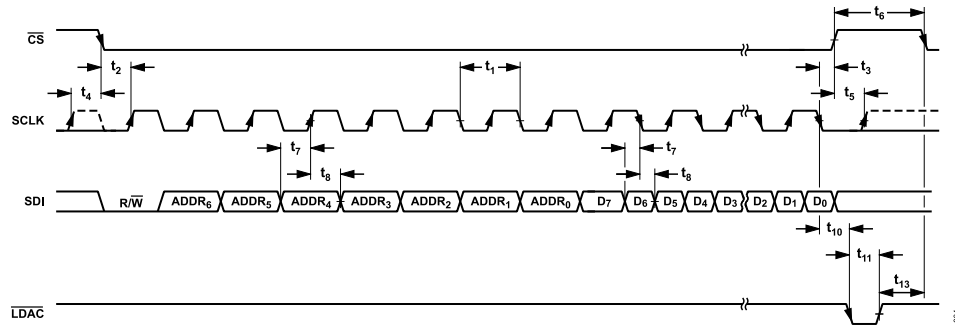

Figure 4. Classic SPI Write Operation with Double Data Rate

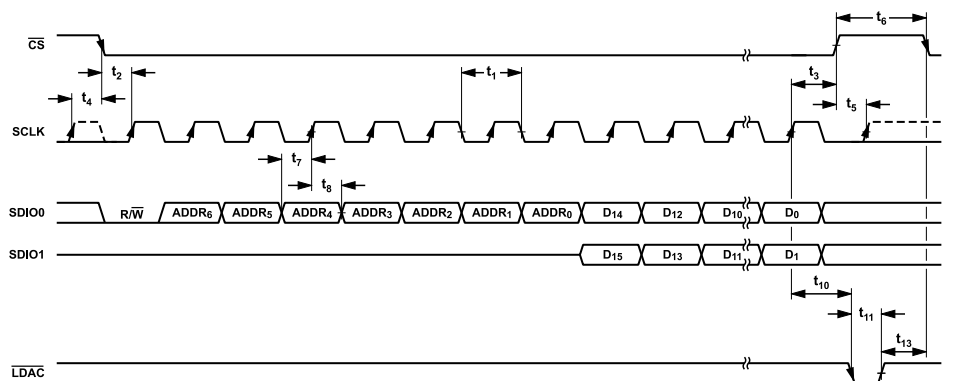

Figure 5. Dual SPI Write Operation with Single Data Rate

SPECIFICATIONS

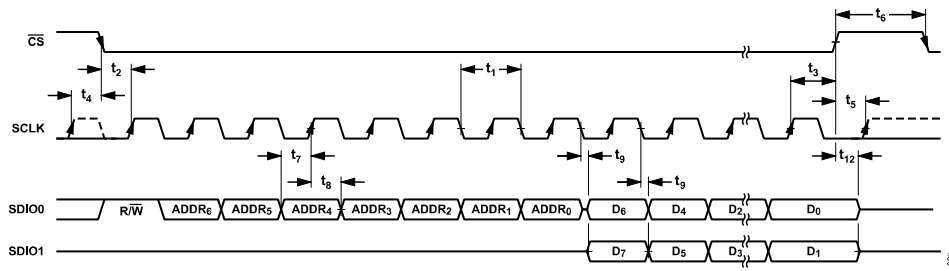

Figure 6. Dual SPI Read Operation with Single Data Rate

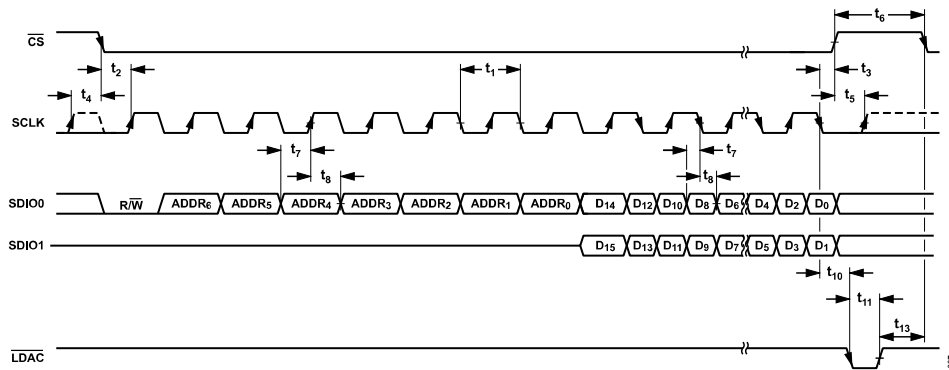

Figure 7. Dual SPI Write Operation with Double Data Rate

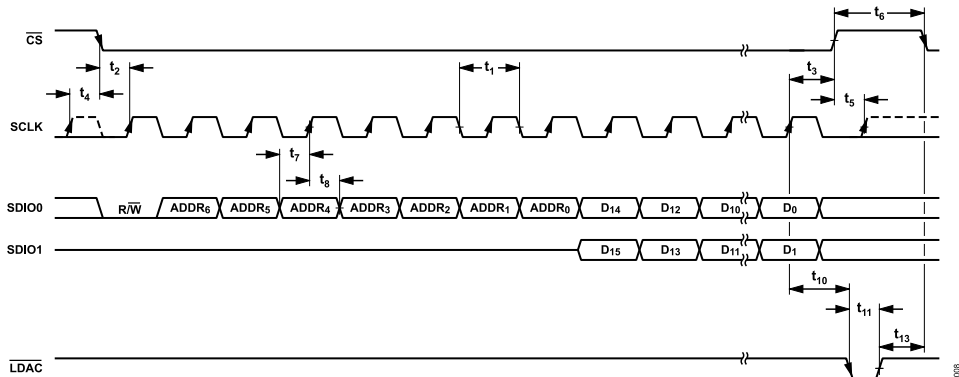

Figure 8. Dual Synchronous SPI Write Operation with Single Data Rate

SPECIFICATIONS

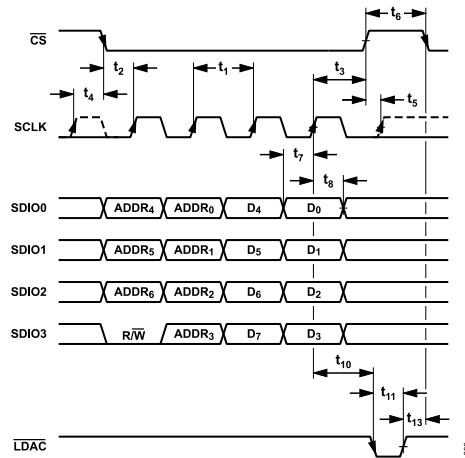

Figure 9. Quad SPI Write Operation with Single Data Rate

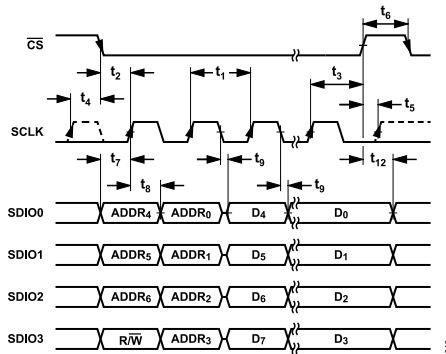

Figure 10. Quad SPI Read Operation with Single Data Rate

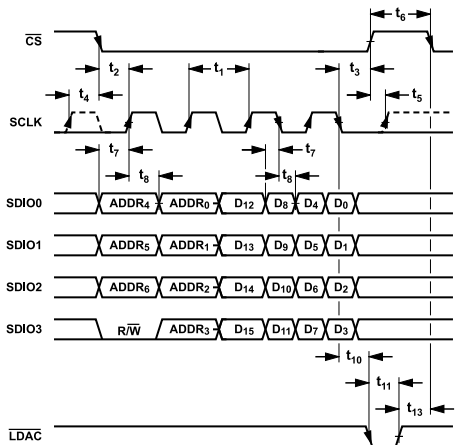

Figure 11. Quad SPI Write Operation with Double Data Rate

SPECIFICATIONS

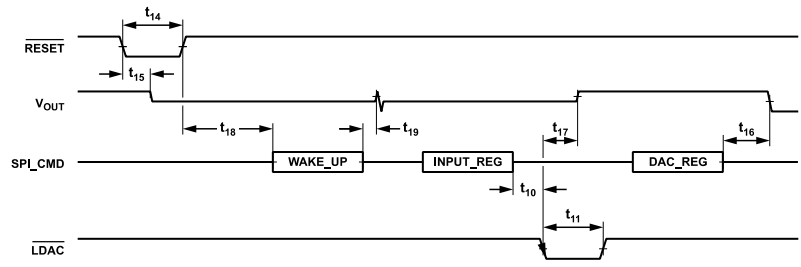

Figure 12. Start-Up Sequence Timing

ABSOLUTE MAXIMUM RATINGS

$T_A = 25^\circ\text{C}$, unless otherwise noted.

Table 5.

Parameter	Rating
AV_{DD} to AGND	-0.3 V to +6 V
DV_{DD} to DGND	-0.3 V to +2.1 V
AGND to DGND	-0.3 V to +0.3 V
V_{LOGIC} to DGND	-0.3 V to $DV_{DD} + 0.3$ V or +2.1 V (whichever is less)
V_{REF} to AGND	-0.3 V to +3 V
$RFB_{x,y}$ to AGND	-18 V to +18 V
Digital Input Voltage to DGND	-0.3 V to $V_{LOGIC} + 0.3$ V or +2.1 V (whichever is less)
Operating Temperature Range	
Industrial	-40°C to +105°C
Storage Temperature Range	-65°C to +150°C
Maximum Junction Temperature (T_J)	125°C
Power Dissipation	$(\text{Maximum } T_J - T_A)/\theta_{JA}$

Stresses at or above those listed under Absolute Maximum Ratings may cause permanent damage to the product. This is a stress rating only; functional operation of the product at these or any other conditions above those indicated in the operational section of this specification is not implied. Operation beyond the maximum operating conditions for extended periods may affect product reliability.

THERMAL RESISTANCE

Thermal performance is directly linked to printed circuit board (PCB) design and operation environment. Careful attention to PCB thermal design is required.

θ_{JA} is the natural convection junction to ambient thermal resistance.

θ_{JC} is the junction to case thermal resistance. Both θ_{JA} and θ_{JC} are defined by the JEDEC JESD51 standard, and their values are dependent on the test board and test environment.

Table 6. Thermal Resistance¹

Package Type	θ_{JA}	θ_{JC}	Unit
CP-32-30	43.5	23.6	°C/W

¹ Simulation values on JEDEC 2S2P board with 9 thermal vias, still air (0 m/sec airflow).

ESD CAUTION



ESD (electrostatic discharge) sensitive device. Charged devices and circuit boards can discharge without detection. Although this product features patented or proprietary protection circuitry, damage may occur on devices subjected to high energy ESD. Therefore, proper ESD precautions should be taken to avoid performance degradation or loss of functionality.

PIN CONFIGURATION AND FUNCTION DESCRIPTIONS

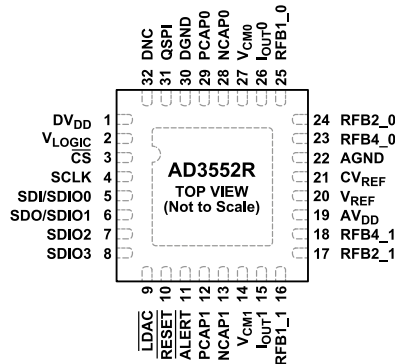

NOTES
 1, DNC = DO NOT CONNECT, DO NOT CONNECT TO THIS PIN.
 2, ANALOG GROUND REFERENCE, IT IS RECOMMENDED TO CONNECT DGND AND AGND TO THE SAME GROUND PLANE UNDER THE DEVICE.

013

Figure 13. Pin Configuration

Table 7. Pin Function Descriptions

Pin No.	Mnemonic	Type	Description
1	DV _{DD}	S	Digital Core Power Supply. 1.8 V ± 5%.
2	V _{LOGIC}	S	Digital Interface Power Supply. 1.2 V to 1.8 V.
3	\overline{CS}	DI	Chip Select, Active Low Logic Input. This is the frame synchronization signal for the input data.
4	SCLK	DI	Serial Clock Input.
5	SDI/SDIO0	DI/O	Serial Data Input in Classic SPI Mode.
6	SDO/SDIO1	DI/O	Serial Bidirectional Input/Output Bit 0 in Dual or Quad SPI Modes.
7	SDIO2	DI/O	Serial Bidirectional Input/Output Bit 1 in Dual or Quad SPI Modes.
8	SDIO3	DI/O	Serial Bidirectional Input/Output Bit 2 in Quad SPI Mode. Pull down if not used.
9	\overline{LDAC}	DI	Load DAC, Active Low Logic Input. \overline{LDAC} can be operated in synchronous mode or asynchronous mode. Pulsing this pin low causes the DAC register to be updated if the input register has new data. If this pin is tied permanently low, the DAC is automatically updated when new data is written to the input register.
10	\overline{RESET}	DI	Asynchronous Reset Input. Active low logic input. When \overline{RESET} is low, all registers are reset to their default values and the activity on the digital interface is ignored. The AD3552R incorporates a power-on reset (POR) circuit. If this pin is not used it must be tied to V _{LOGIC} .
11	\overline{ALERT}	DO	Alert Pin. Active low logic output. This pin is driven low if an alert condition is detected and it is not masked by the corresponding bit in the mask register. This pin has an internal configurable pull-up resistor.
12	PCAP1	AI/O	Noise Reduction Capacitor for DAC1, Optional.
13	NCAP1	AI/O	Noise Reduction Capacitor for DAC1, Optional.
14	V _{CM1}	AO	Common Mode Voltage for DAC1. Analog input/output.
15	I _{OUT1}	AI/O	DAC1 Output Current.
16	RFB1_1	AI/O	Hardware Gain Selection for DAC1, Gain = 1.
17	RFB2_1	AI/O	Hardware Gain Selection for DAC1, Gain = 2.
18	RFB4_1	AI/O	Hardware Gain Selection for DAC1, Gain = 4.
19	AV _{DD}	S	Analog Power Supply. 5 V ± 5%.
20	V _{REF}	AI/O	Voltage Reference, 2.5 V. Input when using external reference, output or floating when using internal reference.
21	CV _{REF}	AI/O	Decoupling Capacitor for Internal Reference, Optional.
22	AGND	S	Analog Ground Reference. It is recommended to connect DGND and AGND to the same ground plane under the device.
23	RFB4_0	AI/O	Hardware Gain Selection for DAC0, Gain = 4.
24	RFB2_0	AI/O	Hardware Gain Selection for DAC0, Gain = 2.
25	RFB1_0	AI/O	Hardware Gain Selection for DAC0, Gain = 1.
26	I _{OUT0}	AI/O	DAC0 Output Current.

PIN CONFIGURATION AND FUNCTION DESCRIPTIONS**Table 7. Pin Function Descriptions**

Pin No.	Mnemonic	Type	Description
27	V _{CM0}	AO	Common Mode Voltage for DAC0 External TIA.
28	NCAP0	AI/O	Noise Reduction Capacitor for DAC0, Optional.
29	PCAP0	AI/O	Noise Reduction Capacitor for DAC0, Optional.
30	DGND	S	Digital Ground Reference. It is recommended to connect DGND and AGND to the same ground plane under the device.
31	QSPI	DI	QSPI Mode Enable. Digital input. A high level enables quad SPI interface mode.
32	DNC	DNC	Do Not Connect. Leave pin floating.
EPAD			Exposed Pad. Connect this pad to AGND and provide thermal vias, as explained in the Layout Guidelines section.

TYPICAL PERFORMANCE CHARACTERISTICS

VDD = 5 V, DVDD = IOVDD = 1.8 V, external voltage reference, temperature = 25°C (ambient), decoupling as outlined in the [Power Supply Recommendations](#) section, unless otherwise noted.

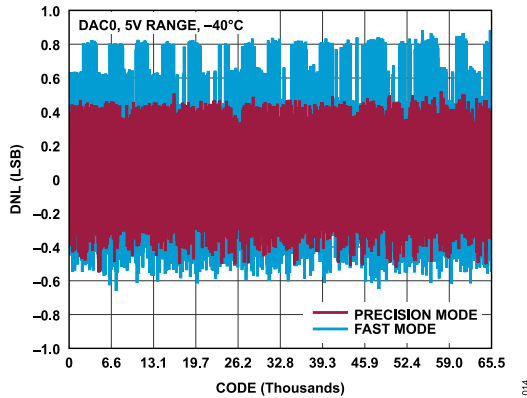

Figure 14. DNL vs. Code, 0 V to 5 V Range, -40°C, Fast Mode and Precision Mode

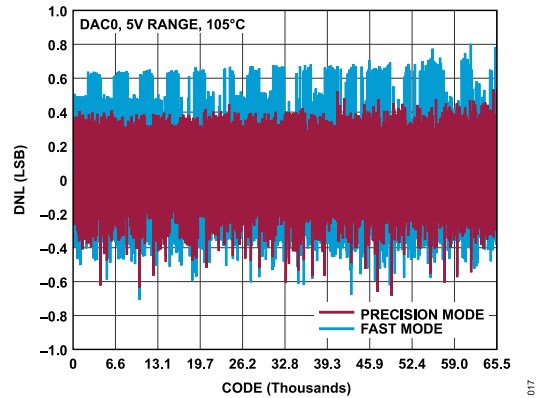

Figure 17. DNL vs. Code, 0 V to 5 V Range, 105°C, Fast Mode and Precision Mode

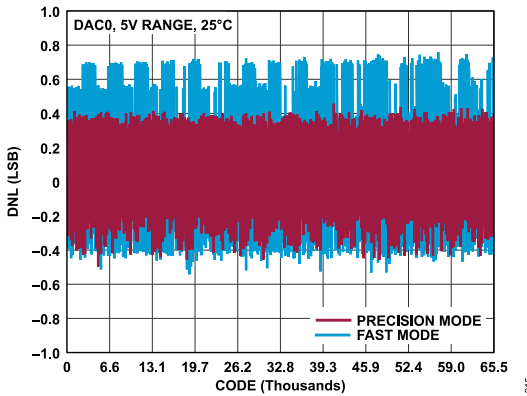

Figure 15. DNL vs. Code, 0 V to 5 V Range, 25°C, Fast Mode and Precision Mode

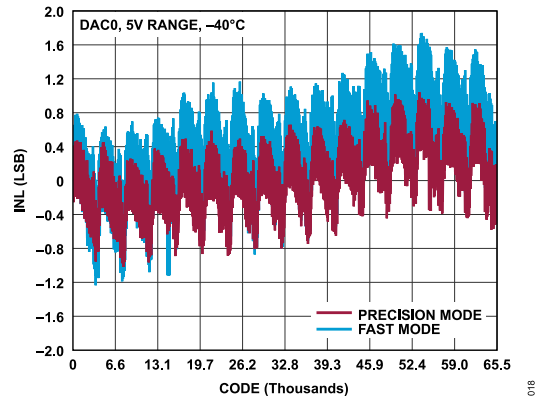

Figure 18. INL vs. Code, 0 V to 5 V Range, -40°C, Fast Mode and Precision Mode

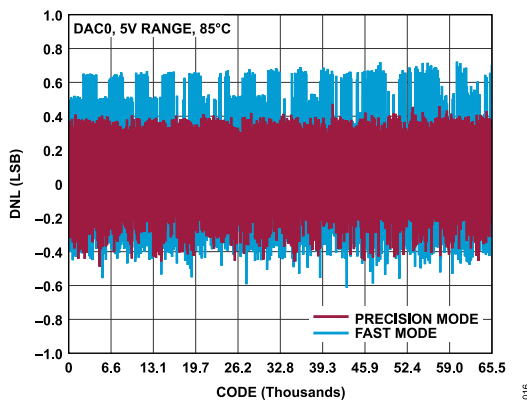

Figure 16. DNL vs. Code, 0 V to 5 V Range, 85°C, Fast Mode and Precision Mode

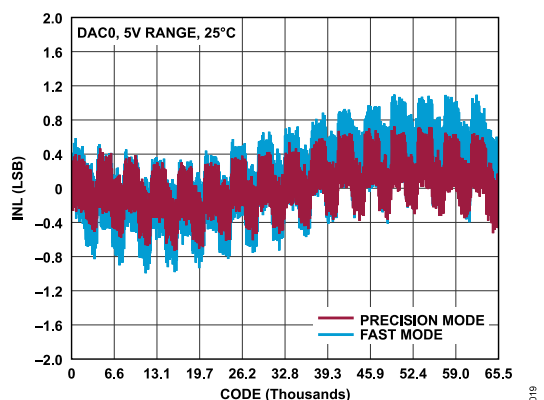

Figure 19. INL vs. Code, 0 V to 5 V Range, 25°C, Fast Mode and Precision Mode

TYPICAL PERFORMANCE CHARACTERISTICS

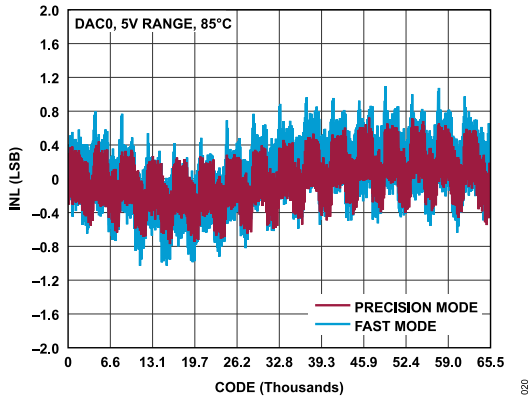

Figure 20. INL vs. Code, 0 V to 5 V Range, 85°C, Fast Mode and Precision Mode

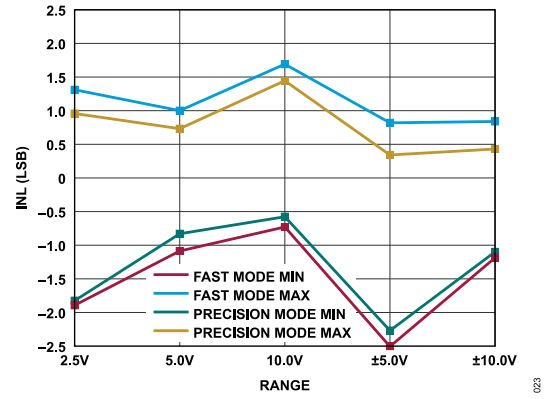

Figure 23. INL vs. Range, Fast Mode and Precision Mode

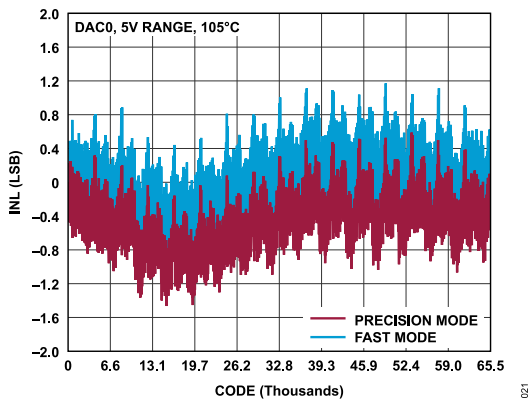

Figure 21. INL vs. Code, 0 V to 5 V Range, 105°C, Fast Mode and Precision Mode

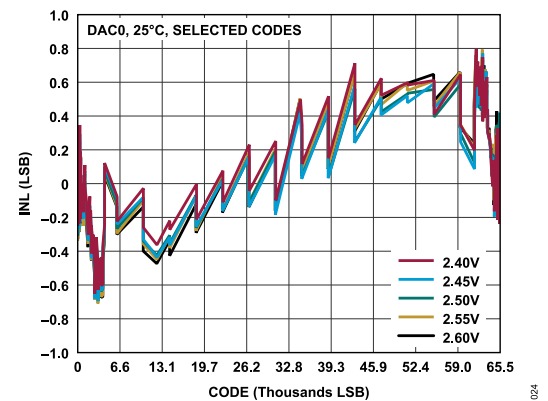

Figure 24. INL vs. Code, Reference Voltage

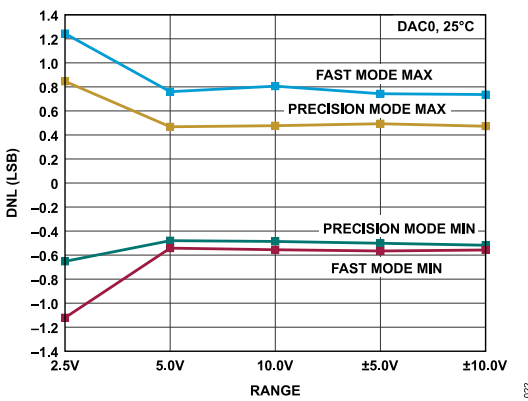

Figure 22. DNL vs. Range, Fast Mode and Precision Mode

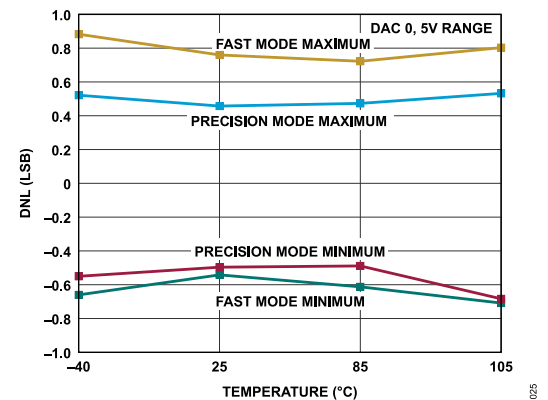

Figure 25. DNL vs. Temperature

TYPICAL PERFORMANCE CHARACTERISTICS

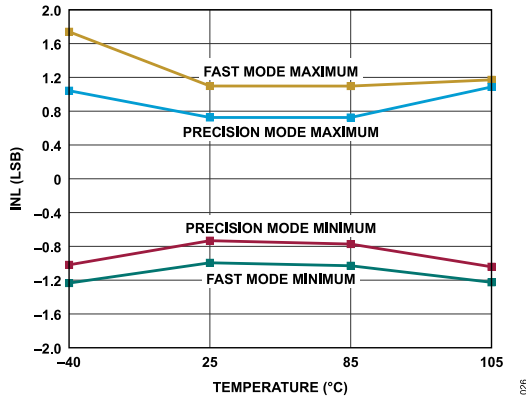

Figure 26. INL vs. Temperature

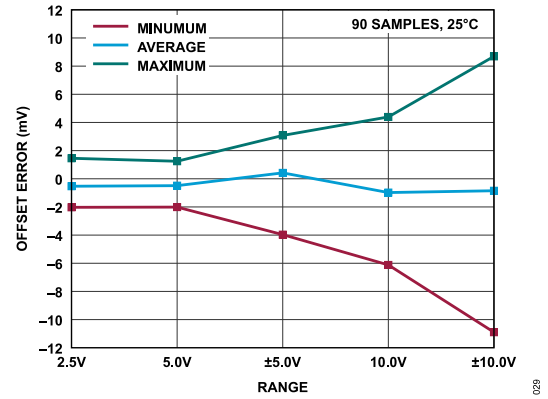

Figure 29. Offset Error vs. Range

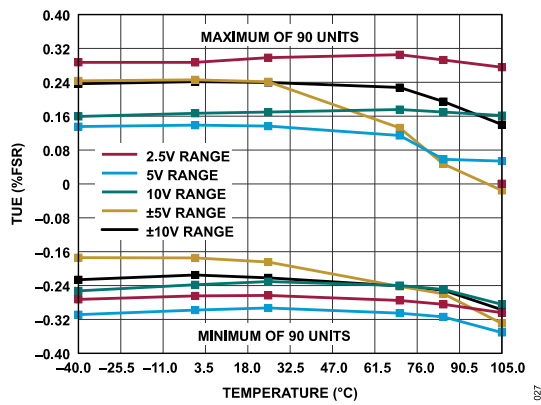

Figure 27. TUE vs. Temperature

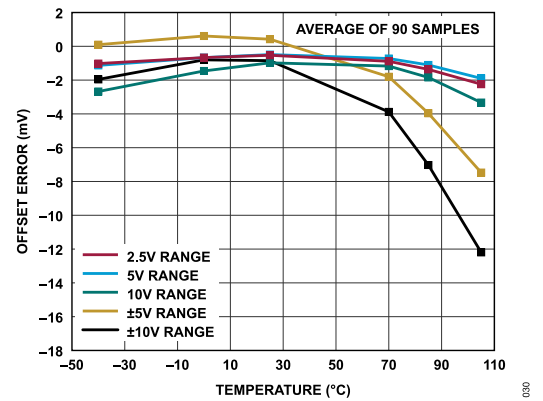

Figure 30. Offset Error vs. Temperature

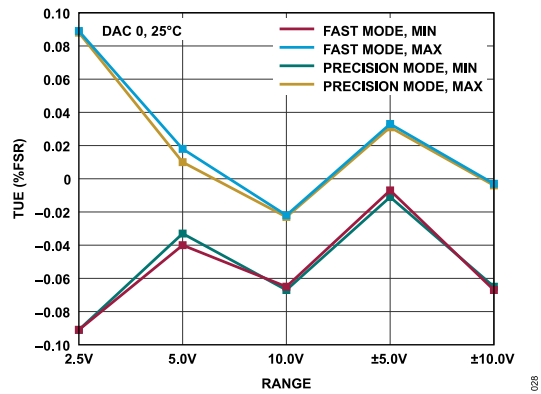

Figure 28. TUE vs. Range

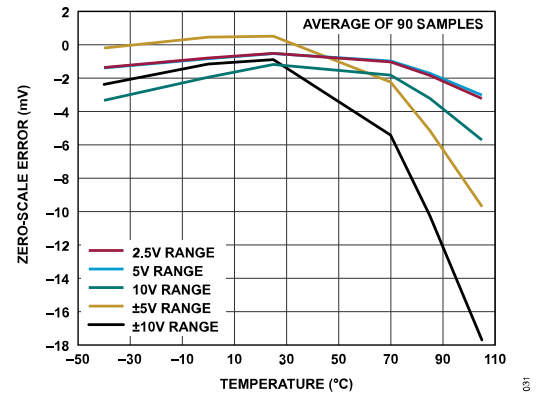

Figure 31. Zero-Scale Error vs. Temperature

TYPICAL PERFORMANCE CHARACTERISTICS

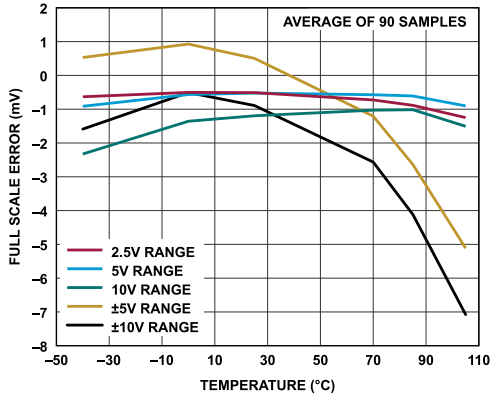

Figure 32. Full-Scale Error vs. Temperature

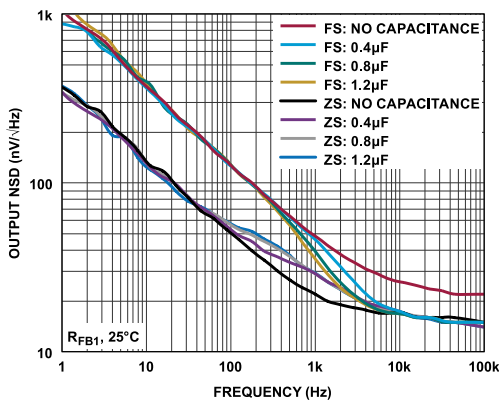

Figure 33. Output NSD vs. Frequency, PCAPx and NCAPx Capacitor Values

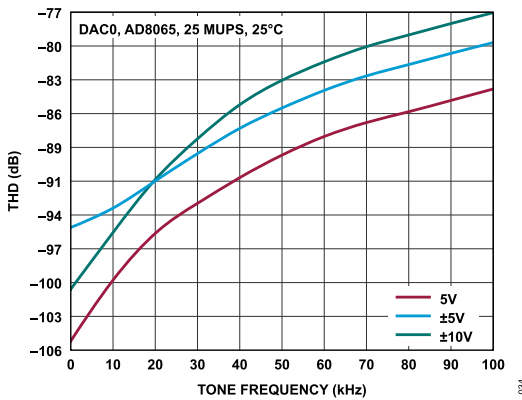

Figure 34. Total Harmonic Distortion (THD) vs. Tone Frequency

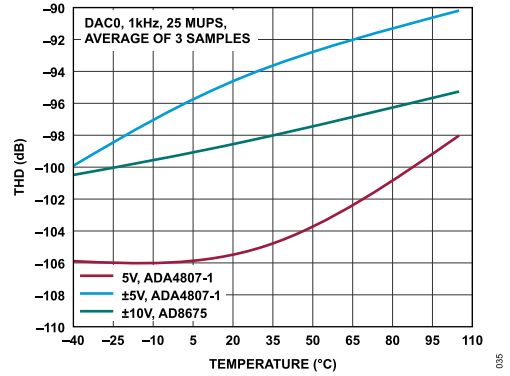

Figure 35. THD vs. Temperature

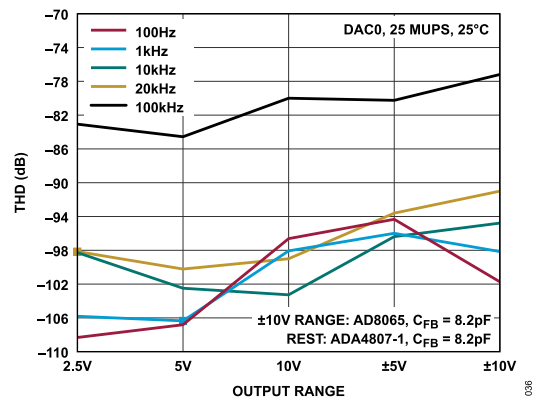

Figure 36. THD vs. Output Range

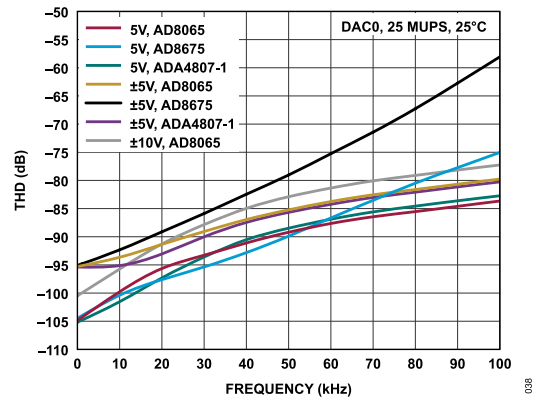

Figure 37. THD vs. Frequency, Amplifier

TYPICAL PERFORMANCE CHARACTERISTICS

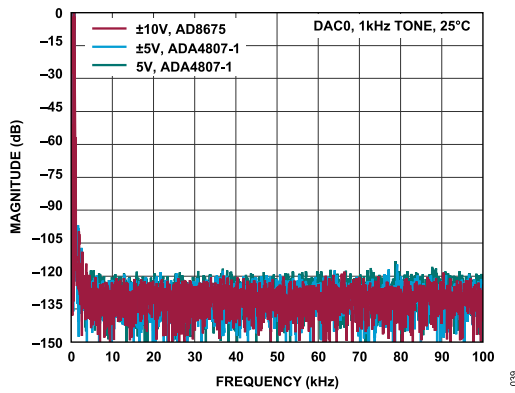

Figure 38. Fast Fourier Transform (FFT) with 1 kHz Sinewave, 25 MUPS

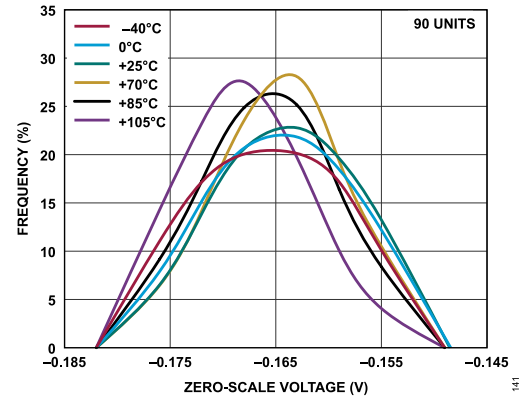

Figure 41. Zero-Scale Voltage Distribution, 0 V to 10 V Range

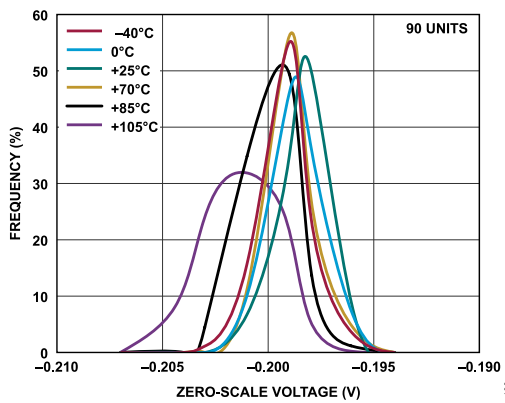

Figure 39. Zero-Scale Voltage Distribution, 0 V to 2.5 V Range

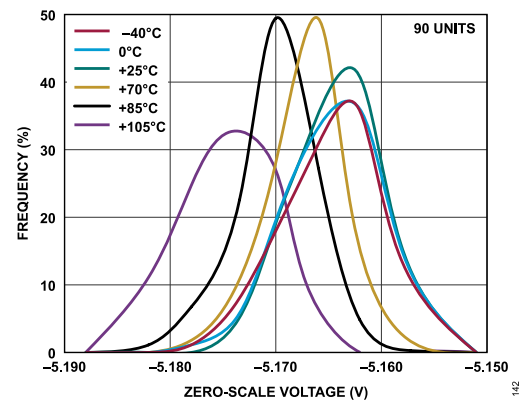

Figure 42. Zero-Scale Voltage Distribution, -5 V to +5 V Range

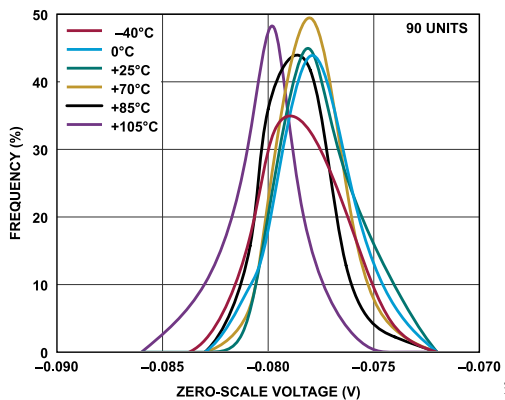

Figure 40. Zero-Scale Voltage Distribution, 0 V to 5 V Range

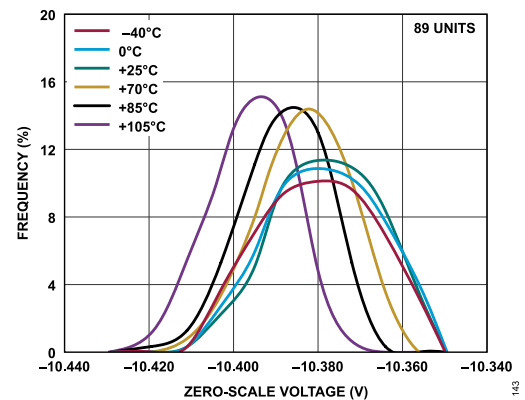

Figure 43. Zero-Scale Voltage Distribution, -10 V to +10 V Range

TYPICAL PERFORMANCE CHARACTERISTICS

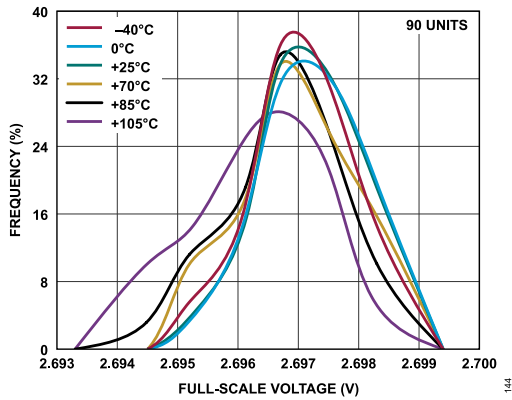

Figure 44. Full-Scale Voltage Distribution, 0 V to 2.5 V Range

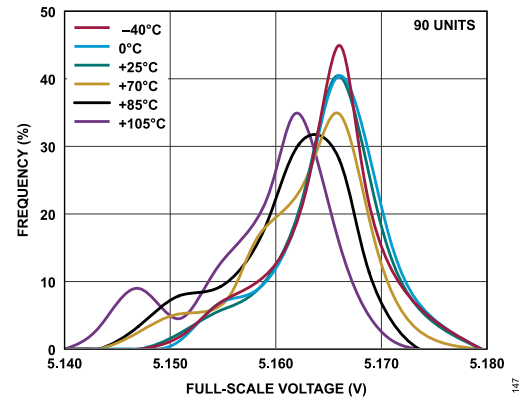

Figure 47. Full-Scale Voltage Distribution, -5 V to +5 V Range

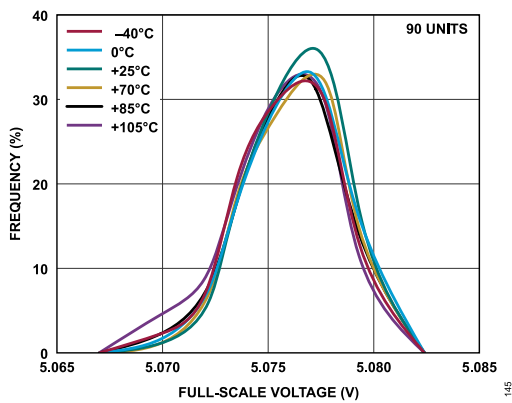

Figure 45. Full-Scale Voltage Distribution, 0 V to 5 V Range

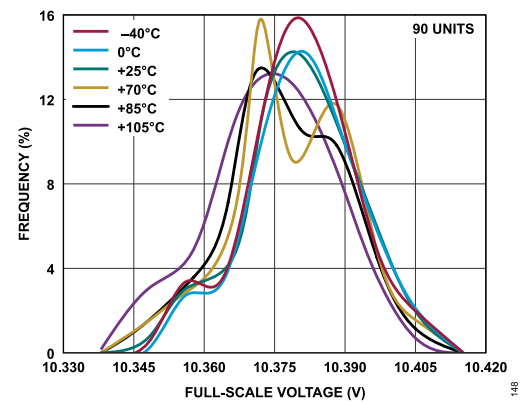

Figure 48. Full-Scale Voltage Distribution, -10 V to +10 V Range

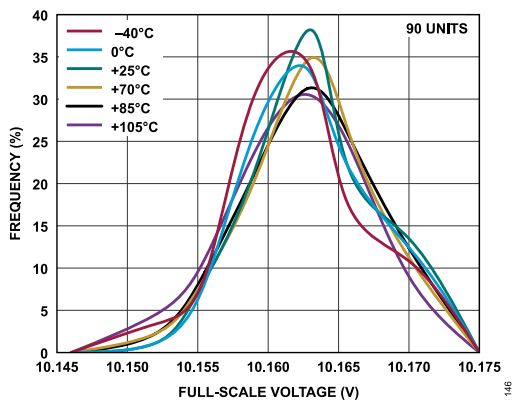

Figure 46. Full-Scale Voltage Distribution, 0 V to 10 V Range

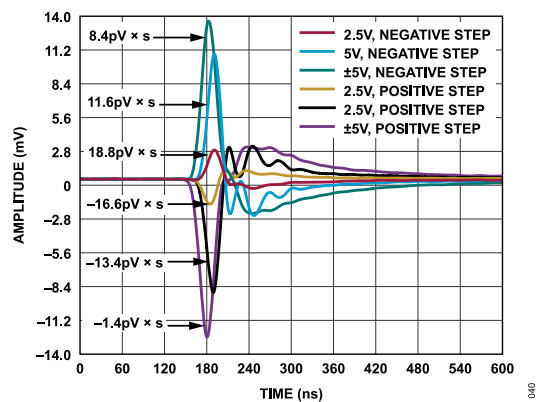

Figure 49. Digital to Analog Glitch

TYPICAL PERFORMANCE CHARACTERISTICS

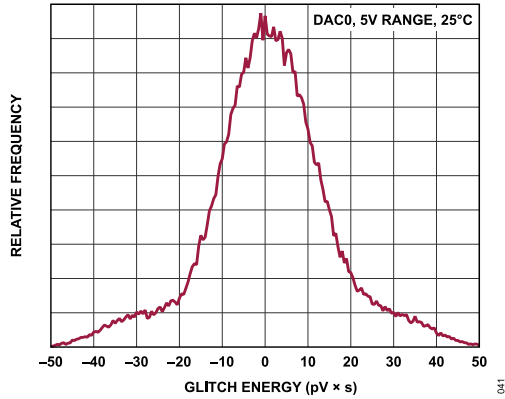

Figure 50. Digital to Analog Glitch Energy Histogram

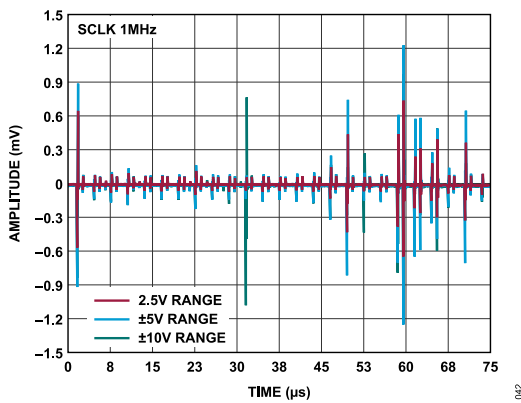

Figure 51. Digital Feedthrough

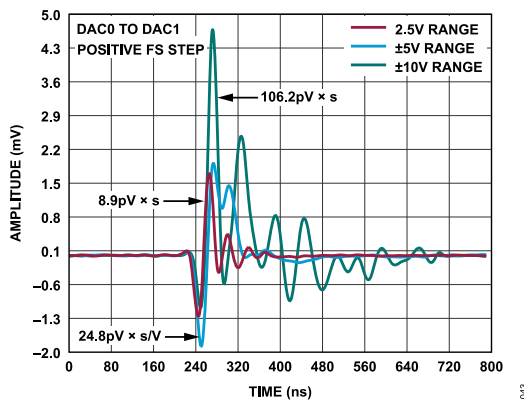

Figure 52. DAC-to-DAC Crosstalk

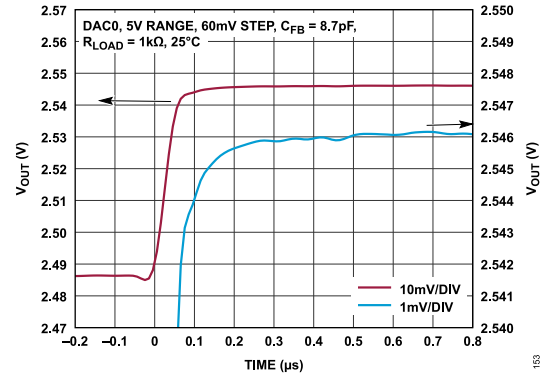

Figure 53. Small Signal Settling Time, 0 V to 5 V Range

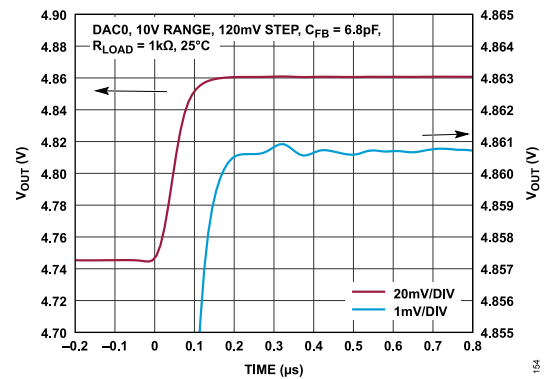

Figure 54. Small Signal Settling Time, 0 V to 10 V Range

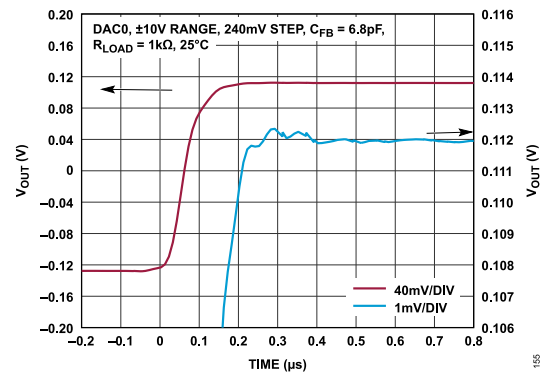

Figure 55. Small Signal Settling Time, -10 V to +10 V Range

TYPICAL PERFORMANCE CHARACTERISTICS

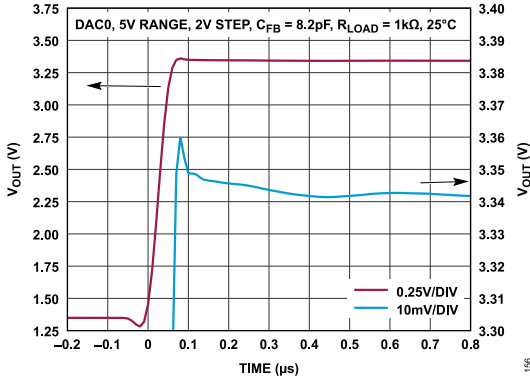

Figure 56. Large Signal Settling Time, 0 V to 5 V Range

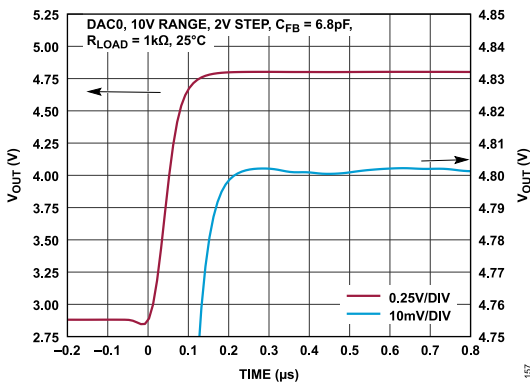

Figure 57. Large Signal Settling Time, 0 V to 10 V Range

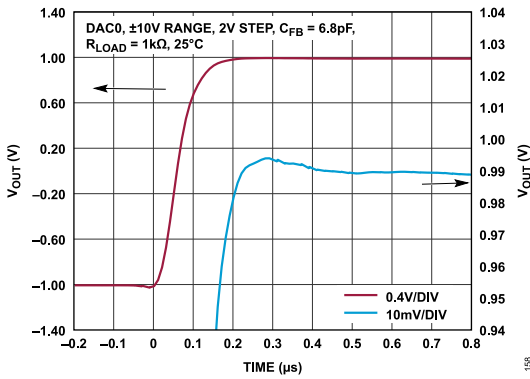

Figure 58. Large Signal Settling Time, -10 V to +10 V Range

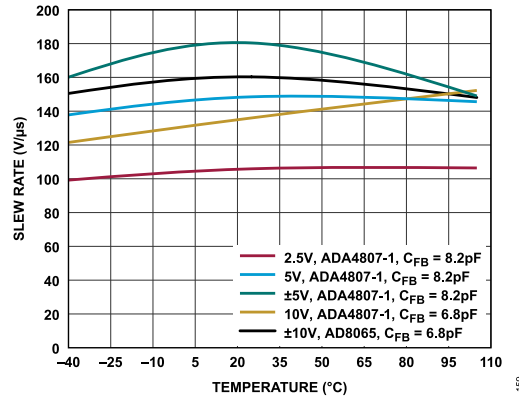

Figure 59. Slew Rate vs. Temperature

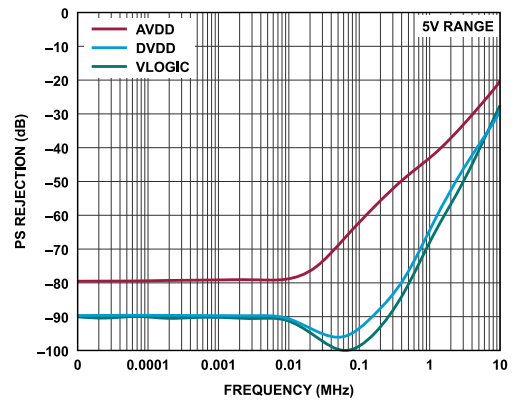

Figure 60. AC PSRR

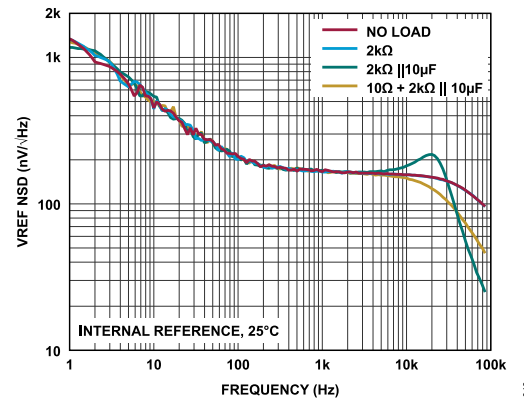

Figure 61. Reference Voltage (V_{REF}) NSD vs. Frequency, Load Impedance

TYPICAL PERFORMANCE CHARACTERISTICS

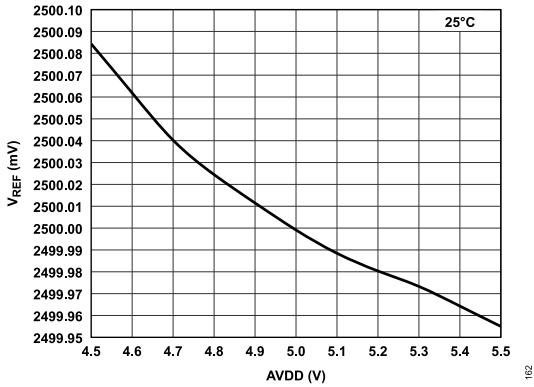

Figure 62. V_{REF} vs. Supply (AVDD)

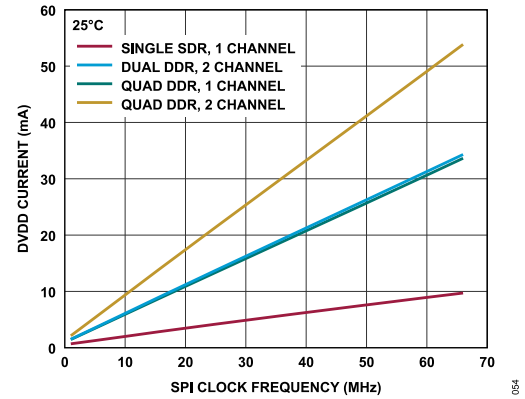

Figure 65. DVDD Current vs. SPI Clock Frequency, SPI Mode

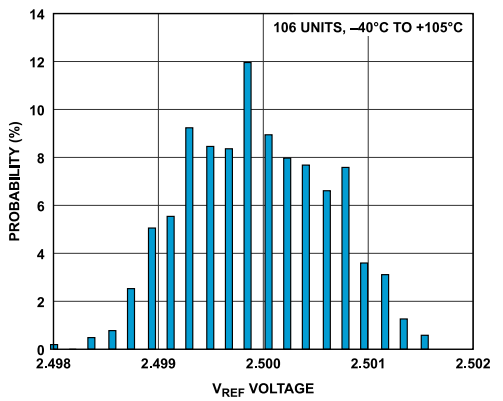

Figure 63. Reference Voltage Spread

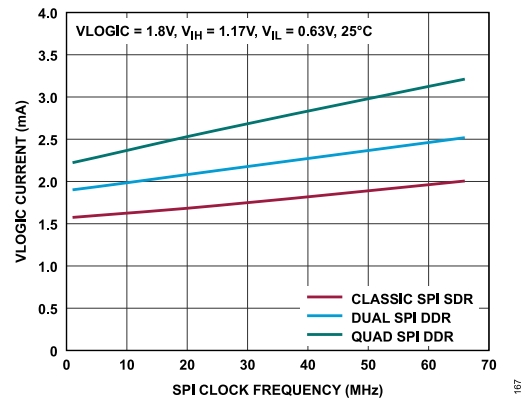

Figure 66. VLOGIC Current vs. SPI Clock Frequency, SPI Mode

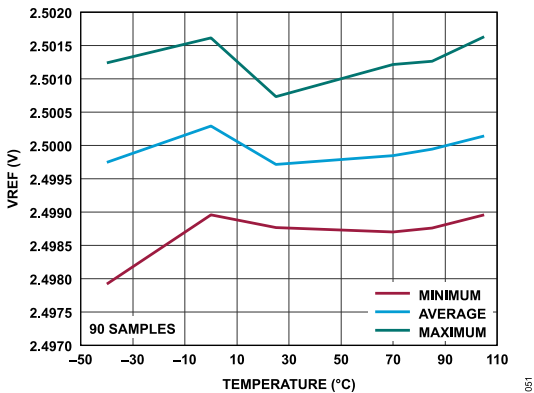

Figure 64. V_{REF} vs. Temperature

TERMINOLOGY

Relative Accuracy or Integral Nonlinearity (INL)

For the DAC, relative accuracy or integral nonlinearity is a measurement of the maximum deviation, in LSBs, from a straight line passing through the endpoints of the DAC transfer function. See [Figure 14](#) for a typical INL vs. code plot.

Differential Nonlinearity (DNL)

Differential nonlinearity is the difference between the measured change and the ideal 1 LSB change between any two adjacent codes. See [Figure 15](#) for a typical DNL vs. code plot.

Offset Error

Offset error is the vertical deviation from the ideal transfer function after the gain error has been compensated. Offset error is expressed in mV. In the AD3552R, offset error is measured at midscale. The comparison between the ideal output and the actual output is performed at midscale.

Offset Error Drift

The offset error drift is a measurement of the relative variation of the offset with temperature. It is expressed in ppm/°C. Total offset at a given temperature is calculated as

$$Offset_T = Offset_{25^\circ C} + \frac{TC \times (T - 25) \times V_{RANGE}}{10^6}$$

Full-Scale and Zero-Scale Error

These errors measure the deviation from the ideal value at full scale and zero scale, at 25°C. The error is expressed as % of full-scale range (FSR). In the case of the AD3552R, the ideal value is calculated as the average of a sufficiently high number of samples.

Full-Scale and Zero-Scale Error Drift

These parameters measure the variation of the zero-scale and full-scale voltage as a function of the temperature, relative to the ideal zero-scale and full-scale voltages. They are expressed in ppm/°C. The total deviation over temperature is calculated using the same formula used for the offset.

DC PSRR and AC PSRR

PSRR indicates how the output of the DAC is affected by changes in the supply voltage. PSRR is the ratio of the change in V_{OUT} to a change in the supplies for midscale output of the DAC. It is measured in dB. V_{REF} is held at 2.5 V, and the supplies are varied by ± 200 mV p-p.

Output Voltage Settling Time

Output voltage settling time is the amount of time it takes for the output of a DAC to settle to a specified level for a given step change. See [Figure 53](#) through [Figure 58](#) for typical plots of small and large signal settling, respectively.

Digital-to-Analog Glitch Impulse

Digital-to-analog glitch impulse is the impulse injected into the analog output when the input code in the DAC register changes state. It is normally specified as the area of the glitch in nV × sec and is measured when the digital input code is changed by 1 LSB. See [Figure 49](#) for a typical glitch impulse plot.

Digital Feedthrough

Digital feedthrough is a measure of the impulse injected into the analog output of the DAC from the digital inputs of the DAC, but it is measured when the DAC output is not updated. Digital feedthrough is specified in nV × sec and measured with a full-scale code change on the data bus, which means from all 0s to all 1s and vice versa. See [Figure 51](#) for a typical digital feedthrough plot.

Output Noise Spectral Density

Noise spectral density is a measurement of the internally generated random noise. Noise is measured at the DAC output when it is loaded with the midscale code. It is measured in nV/√Hz. See [Figure 33](#) for a plot of noise spectral density. The noise of the internal reference is also characterized in [Figure 61](#).

Total Harmonic Distortion (THD)

THD is the difference between an ideal sine wave and the attenuated version using the DAC. The sine wave is used as the reference for the DAC, and the THD is a measurement of the harmonics present on the DAC output. It is measured in dB.

Voltage Reference Temperature Coefficient (TC)

Voltage reference TC is a measure of the change in the reference output voltage with a change in temperature. The reference TC is calculated using the box method, which defines the TC as the maximum change in the reference output over a given temperature range expressed in ppm/°C, as shown in the following equation:

$$TC = \left(\frac{V_{REF_MAX} - V_{REF_MIN}}{V_{REF_NOM} \times TEMP_RANGE} \right) \times 10^6 \quad (1)$$

where:

V_{REF_MAX} is the maximum reference output measured over the total temperature range.

V_{REF_MIN} is the minimum reference output measured over the total temperature range.

V_{REF_NOM} is the nominal reference output voltage, 2.5 V.

TEMP_RANGE is the specified temperature range, -40°C to +105°C.

DC Crosstalk

DC crosstalk is the dc change in the output level of one DAC in response to a change in the output of another DAC. It is measured with a full-scale output change on one DAC (or soft power-down and power-up) while monitoring another DAC kept at midscale. It

TERMINOLOGY

is expressed in μV . DC crosstalk due to load current change is a measure of the impact that a change in load current on one DAC has to another DAC kept at midscale. It is expressed in $\mu\text{V}/\text{mA}$.

THEORY OF OPERATION

PRODUCT DESCRIPTION

The AD3552R is a 16-bit, 33 MUPS dual DAC with programmable output ranges and a 2.5 V internal reference.

The AD3552R has the following two update modes:

- ▶ **Fast Mode:** data written in this mode is 16 bits long, resulting in a single-channel update rate of 33 MUPS. The DNL specification is valid for the reduced temperature range defined in [Table 2](#). The data for this mode is written in the registers ending in `_16B`.
- ▶ **Precision Mode:** data written in this mode is 24 bits long, resulting in a single-channel update rate of 22 MUPS. The DNL specification is guaranteed over the full operating temperature range. The data for this mode is written in the registers ending in `_24B`.

The AD3552R offers a versatile SPI interface capable of operating in classic, dual, and quad SPI modes with single or double data rate. The AD3552R features multiple error checkers, both in the analog and digital domains to guarantee a safe operation.

DAC ARCHITECTURE

The AD3552R uses a current steering DAC architecture with a V_{REF} voltage of 2.5 V. The DAC current is converted to voltage by means of an external TIA.

[Figure 67](#) shows the internal block diagram.

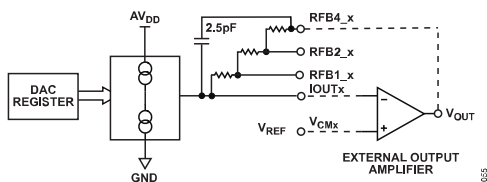

Figure 67. DAC Channel Architecture Block Diagram

Table 8. Predefined Output Span Ranges and Corresponding Feedback Resistor

RFBx_y	CH0_CH1_OUTPUT_RANGE	Output Span	CHx_GAIN_SCALING_P	CHx_GAIN_SCALING_N	CHx_OFFSET
RFB1_y	0x000	2.5 V	0	3	-24
	0x001	5 V	0	0	0
RFB2_y	0x010	10 V	0	0	248
	0x011	±5 V	0	0	-248
RFB4_y	0x100	±10 V	0	0	-123

The TIA feedback loop is closed by hardwiring the V_{OUT} pin to any of the available RFBx_y pins. The RFBx_y value sets the maximum voltage span that can be achieved. These voltage spans can be decreased using the gain scaling registers and repositioned within the supply rails of the TIA using the offset registers.

PREDEFINED OUTPUT VOLTAGE SPANS

The AD3552R comes with five predefined voltage spans that are selected using the CH0_CH1_OUTPUT_RANGE register. The selected span must be in accordance with the feedback resistor being used, as shown in [Table 8](#). The CHx_GAIN_SCALING_P, CHx_GAIN_SCALING_N, and CHx_OFFSET parameters do not have to be set because their preset values are provided only as starting points for the user to create custom range values. Setting a voltage span that is not achievable with the current RFBx_y resistor results in an incorrect voltage value.

There is approximately a 3% overrange equally split on each end of the span to ensure that the nominal range is covered in any condition.

If the predefined voltage spans do not fit the intended application, custom spans can be defined using the gain scaling and offset registers as described in the [Custom Output Voltage Span](#) section.

THEORY OF OPERATION

CUSTOM OUTPUT VOLTAGE SPAN

In addition to the predefined output span ranges configured via the CH0_CH1_OUTPUT_RANGE register, the output span range can be customized by programming the offset and gain registers in conjunction with the external feedback resistor. The CHx_RANGE_OVERRIDE bit must be set in the CH0_GAIN register or CH1_GAIN register to override the predefined range and offset values. Gain is configured as a combination of two parameters, CHx_GAIN_SCALING_P and CHx_GAIN_SCALING_N in the CH0_GAIN register or CH1_GAIN register. The absolute value of the offset is configured in the CH0_OFFSET register or CH1_OFFSET register and the sign is configured with the CHx_OFFSET_POLARITY bit in the CH0_GAIN register or CH1_GAIN register.

The bounds of the output span are defined in the following equations:

$$\text{Zero - Scale Output Voltage } (V_{OUT_ZS}) = 2.5 - 1.6 \times R_F \times (\text{Gain}_P - \text{Offset})$$

$$\text{Full - Scale Output Voltage } (V_{OUT_FS}) = 2.5 + 1.6 \times R_F \times (\text{Gain}_N + \text{Offset})$$

where:

$R_F = 1.610938$ for RFB1_x, 3.228125 for RFB2_x, and 6.488125 for RFB4_x

$$\text{Gain}_P = \frac{1}{2^{CHx_GAIN_SCALING_P}}$$

$$\text{Gain}_N = \frac{1}{2^{CHx_GAIN_SCALING_N}}$$

$$\text{Offset} = \frac{\text{OFFSET_POLARITY} \times \text{CHx_OFFSET}}{512}$$

OFFSET_POLARITY = 1 if CHx_OFFSET_POLARITY = 0 and -1 if CHx_OFFSET_POLARITY = 1

Note that a given output span range can be configured in multiple ways, by combining a larger RFBx_y value with a smaller Gain_N and Gain_P value or the other way around. A smaller Gain_N or Gain_P value results in lower power consumption, but a larger RFBx_y value is required to achieve the same output, which results in higher noise density.

TRANSFER FUNCTION

The conversion of the digital code to the DAC output current follows a linear relation with the code in plain binary. The ideal output current, in mA, is given by the following equation:

$$I_{OUTx} = 1.6 \times \left(\text{Gain}_P - \text{Offset} - \frac{D}{2^{16}} \times (\text{Gain}_P + \text{Gain}_N) \right)$$

where:

D is the decimal equivalent of the binary code that is loaded in the

DAC register

Offset, Gain_P, and Gain_N are according to the definitions given in the [Custom Output Voltage Span](#) section

The conversion of current to voltage is performed in the external TIA. If the internal feedback resistor is used, the output voltage follows the following equation:

$$V_{OUTx} = V_{CMx} - R_F \times I_{OUTx}$$

where:

V_{CMx} is the common-mode voltage at the V_{CMx} pin that is connected to the noninverting input of the TIA, nominally 2.5 V

R_F is according to the definition given in the [Custom Output Voltage Span](#) section.

V_{REF}

The AD3552R has an internal 2.5 V voltage reference with a 3 ppm/°C temperature coefficient that is enabled at power-up. The V_{REF} pin is in high impedance at power-up to avoid electrical problems. If the internal reference must be used externally, the REFERENCE_VOLTAGE_SEL bits in the REFERENCE_CONFIG register must be written to enable the V_{REF} output as described in [Table 9](#).

When the external reference is selected, the V_{REF} pin behaves as an input.

Table 9. Voltage Reference Selection

REFERENCE_VOLTAGE_SEL	Source	V _{REF} I/O
00	Internal	Floating
01	Internal	2.5 V
10	External	Input
11	External	Input

SPI REGISTER MAP ACCESS

SPI Frame Synchronization

The $\overline{\text{CS}}$ signal frames data during an SPI transaction. A falling edge on $\overline{\text{CS}}$ enables the digital interface and initiates an SPI transaction. Each SPI transaction consists of at least one instruction phase and data phase, as described in the [Instruction Phase](#) section and the [Data Phase](#) section. For all SPI transactions, data is aligned MSB first. Deasserting $\overline{\text{CS}}$ during an SPI transaction terminates part or all of the data transfer and disables the digital interface. If $\overline{\text{CS}}$ is deasserted (returned high) after one or more register addresses are issued, those registers are written or read, but any partially addressed register is ignored. [Figure 68](#) and [Figure 69](#) outline the stages of a basic SPI write and read frame, respectively, for the AD3552R in register mode.

Detailed timing diagrams for register read and write operations are shown in [Figure 2](#) and [Figure 11](#). The timing specification is given in the [Timing Characteristics](#) section.

THEORY OF OPERATION

The AD3552R SPI protocol is flexible and can be configured to suit the needs of a variety of digital hosts. Data from multiple registers can be accessed in a single SPI frame, enabling efficient device configuration. All the different access modes are described in the [Single Instruction Mode](#) section and the [Streaming Mode](#) section.

Instruction Phase

Every SPI frame starts with an instruction phase. The instruction phase immediately follows the falling edge of \overline{CS} that initiates the SPI transaction.

The instruction phase consists of a read/write bit (R/\overline{W}) followed by a register address word. Setting R/\overline{W} low initiates a write instruction, whereas setting R/\overline{W} high initiates a read instruction. The register address word specifies the address of the register to be accessed. The register address word is 7 bits in length (7-bit addressing) by default. If required, 15-bit addressing can be enabled by setting the SHORT_INSTRUCTION bit to 0 in the INTERFACE_CONFIG_B register. If the user is using single instruction mode, each register read or write transaction in a single SPI frame also begins with an instruction phase. If the user is using streaming mode, only one instruction phase is required per SPI frame to access a set of consecutive registers. See the [Single Instruction Mode](#) section and the [Streaming Mode](#) section for instructions on selecting and using these modes.

Data Phase

The data phase immediately follows the instruction phase, as shown in [Figure 68](#) and [Figure 69](#). The data phase can include the data for a single-byte register, a multibyte register, or multiple registers depending on the selected registers and access modes. See the [Single Instruction Mode](#) section, [Streaming Mode](#) section, and [Address Direction](#) section for descriptions of how these modes affect the read and write data in the data phase.

In a write operation, the content of the addressed register is updated immediately after the SCLK edge, which shifts in the last bit of the register data, regardless if it is a one-byte, two-byte, or three-byte register. Multibyte registers cannot be written partially, as explained in the [Multibyte Registers](#) section.

In a read operation, the content of the addressed register starts shifting out on the first SCLK edge of the data phase.

Data must be written to the AD3552R configuration registers in full bytes to ensure they are updated. If the data phase of an SPI write transaction does not include the entire byte of data for the register being updated, the contents of the register are not updated, and the CLOCK_COUNTING_ERROR bit in the INTERFACE_STATUS_A register is set.

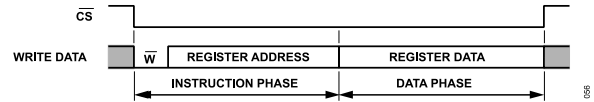

Figure 68. Basic SPI Write Frame

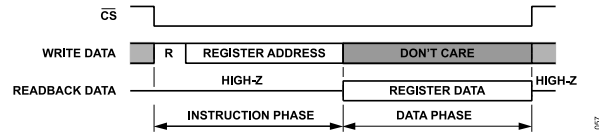

Figure 69. Basic SPI Read Frame

Multibyte Registers

Some AD3552R registers consist of 2 or 3 bytes of data stored in adjacent addresses and are referred to as multibyte registers. Multibyte registers end with a 16B or 24B suffix when they are 2 bytes or 3 bytes, respectively.

When writing to a multibyte register of the AD3552R, all bytes must be transferred in a single SPI transaction. For this reason, the STRICT_REGISTER_ACCESS bit in the INTERFACE_CONFIG_C register is read only and set to 1. If an SPI write transaction to a multibyte register is attempted on a per byte basis, the register contents are not updated and the PARTIAL_REGISTER_ACCESS bit in the INTERFACE_STATUS_A register is set. A write transaction to a multibyte register of the AD3552R takes effect after the 24th or 16th SCLK edge of the data phase, which shifts in the last bit of the register data.

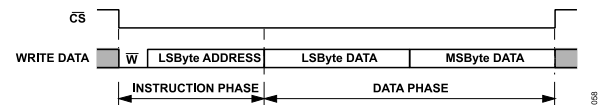

Figure 70. Multibyte Register Write with Ascending Addressing

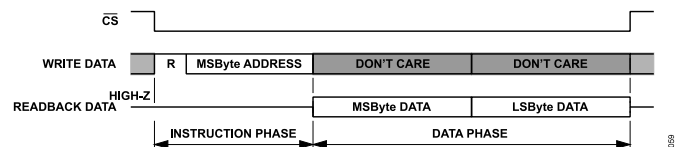

Figure 71. Multibyte Register Read with Descending Addressing

The address of a multibyte register always depends on the ADDR_ASCENSION bit in the INTERFACE_CONFIG_A register (see the [Address Direction](#) section for more details). With descending addressing, the first byte accessed in the data phase must be the most significant byte of the multibyte register, and each subsequent byte corresponds to the data in the next lower address. With ascending addressing, the first byte accessed in the data phase must be the least significant byte of the multibyte register, and each subsequent byte corresponds to the data in the next higher address.

Multibyte registers can be read in a single SPI transaction or each byte can be addressed separately. If an SPI read transaction to

THEORY OF OPERATION

a multibyte register is attempted on a per byte basis, the `PARTIAL_REGISTER_ACCESS` bit in the `INTERFACE_STATUS_A` register is set. For example, the `VENDOR_ID` register is 2 bytes long, and the addresses of its least significant byte and most significant byte are `0x0C` and `0x0D`, respectively. [Figure 70](#) and [Figure 71](#) show write and read transactions to a multibyte register (2 bytes) for address ascending and descending mode, respectively. See the [Address Direction](#) section for more information on selecting address descending (auto-decrementing) or ascending (auto-incrementing).

Address Direction

The address direction option is used to control whether the register address is set to automatically increment (address ascending) or decrement (address descending) when transferring multiple bytes of data in a single data phase (for example, when accessing multibyte registers, as shown in [Figure 70](#) and [Figure 71](#), or when accessing multiple registers with streaming mode, as shown in [Figure 73](#)).

Address direction is selected with the `ADDR_ASCENSION` bit in the `INTERFACE_CONFIG_A` register. If `ADDR_ASCENSION` is set to 0, the address decrements after each byte is accessed. If `ADDR_ASCENSION` is set to 1, the address increments after each byte is accessed.

When accessing multibyte registers, use descending addresses to shift in the most significant byte first.

Multibyte registers from Address `0x29` onwards can only be accessed in descending mode.

Single Instruction Mode

When the `SINGLE_INSTRUCTION` bit in the `INTERFACE_CONFIG_B` register is set to 1, streaming mode is disabled, and single instruction mode is enabled. In single instruction mode, the data phase only contains data for a single register, and each data phase must be followed by a new instruction phase, even if \overline{CS} remains low. Single instruction mode allows the digital host to quickly read from and write to registers with nonadjacent addresses in a single SPI frame, whereas streaming mode only allows either reading or writing to contiguous registers without pulsing \overline{CS} high to initiate a new instruction phase.

[Figure 72](#) shows an example of an SPI transaction in single instruction mode with the following register accesses:

- ▶ Sets the output range.
- ▶ Enables the output stage.
- ▶ Reads the `CHIP_TYPE` register.

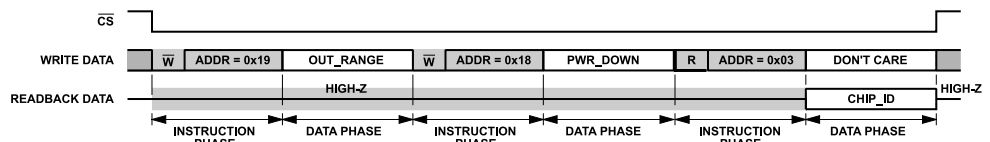

Figure 72. Single Instruction Mode Register Access Example with Address Descending

THEORY OF OPERATION

Streaming Mode

When the SINGLE_INSTRUCTION bit in the INTERFACE_CONFIG_B register is set to 0, single instruction mode is disabled and streaming mode is enabled. In streaming mode, multiple registers with adjacent addresses can be accessed with a single instruction phase and data phase, allowing efficient access of contiguous regions of memory (for example, during initial device configuration). The AD3552R is configured in streaming mode by default.

When in streaming mode, each SPI frame consists of a single instruction phase and the following data phase contains data for multiple registers with adjacent addresses. A starting register address is specified by the digital host in the instruction phase, and this address is automatically incremented or decremented (based on the address direction setting) after each byte of data is accessed. The data phase can, therefore, be multiple bytes long, and each consecutive byte of read or write data corresponds to the next higher or lower register address (for ascending and descending address direction, respectively).

When writing or reading from a multibyte register in streaming mode with address ascending, the user must address the least significant byte of the register in the instruction phase. The data phase starts transferring data from the least significant byte in first place.

When writing or reading from a multibyte register in streaming mode with the address descending, the user must start addressing the most significant byte of the register in the instruction phase. The data phase starts transferring the most significant byte in first place.

Figure 73 shows the instruction and data phase when using streaming mode with address descending to write some registers of the AD3552R starting from Address 0x16. The length of the data phase determines the number of data bytes to be transferred to consecutive addresses. CS is brought high at the end of the write transaction (in Figure 73, the end of the write transaction occurs after Address 0x02).

Figure 74 shows the instruction and data phase when using streaming mode with address ascending to read some registers of the AD3552R starting from Address 0x16. The length of the data

phase determines the number of data bytes to be transferred to consecutive addresses. CS is brought high at the end of the read transaction (in Figure 74, the end of the read transaction occurs after Address 0x02).

The STREAM_MODE register can be used to specify a range of consecutive registers to loop through in the data phase. Looping allows the digital host to repeatedly read from or write to a set of registers (for example, CHx_DAC_16B register at Address 0x29 to Address 0x2C) as efficiently as possible. When accessing register addresses after and including Address 0x29, the address direction must always be set as descending.

If STREAM_MODE is set to 0, looping is disabled and the following occurs:

- ▶ If address direction is set to descending, the address decrements until it reaches 0x00. On the subsequent byte accesses, the address is set to the top of the addressable space (Address 0x4B). Note that restrictions may apply in terms of SPI mode access depending on the register address.
- ▶ If address direction is set to ascending, the address increments until it reaches the top of the addressable space (Address 0x4B). On the subsequent byte access, the address is reset to 0x00. Note that restrictions may apply in terms of SPI mode access depending on the register address. Multibyte registers greater than 0x28 do not update in ascending mode.

If STREAM_MODE is set to a value other than 0, looping is enabled and the value corresponds to the number of bytes to be accessed in the data phase before the address loops back to the value specified in the address phase. An example is shown in Figure 75.

The value of the STREAM_MODE register can be preserved or reset to 0 at the end of the transaction (when CS returns high) depending on the value of the STREAM_LENGTH_KEEP_VALUE bit in the TRANSFER_REGISTER, as shown in Table 10.

Table 10. Stream Mode Autoreset

STREAM_LENGTH_KEEP_VALUE	STREAM_MODE Register
0	Autoreset
1	Keeps previous value

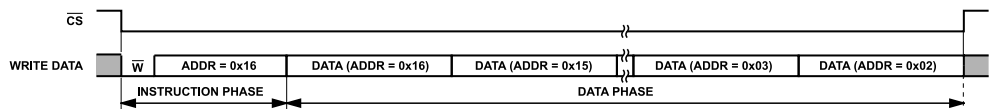

Figure 73. Streaming Mode Register Write with Address Descending

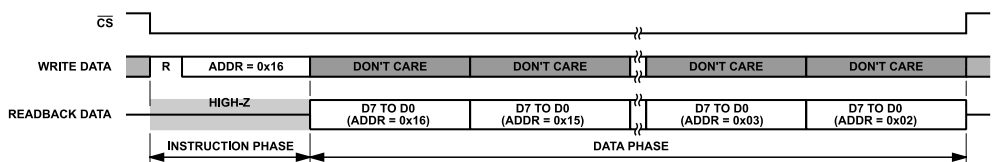

Figure 74. Streaming Mode Register Read with Looping Disabled

THEORY OF OPERATION

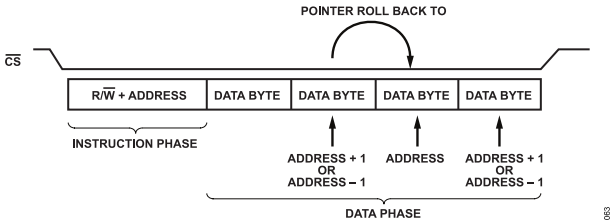

Figure 75. Looping Enabled with *STREAM_MODE* = 2

THEORY OF OPERATION

CRC Error Detection

The AD3552R features an optional CRC to provide error detection for SPI transactions between the digital host (master) and the AD3552R (slave).

CRC error detection allows SPI masters and slaves to detect bit transfer errors with significant reliability. The CRC algorithm involves using a seed value and polynomial division to generate a CRC code. The master and slave both calculate the CRC code independently and compare it to determine the validity of the transferred data.

The AD3552R uses the CRC-8 standard with the following polynomial:

$$x^8 + x^2 + x + 1 \text{ (Equation 1)}$$

CRC error detection is enabled with the `CRC_EN` and `CRC_EN_B` bits in the `INTERFACE_CONFIG_C` register. The value of `CRC_EN` is only updated if `CRC_EN_B` is set to the `CRC_EN` inverted value in the same register write instruction. Therefore, to enable the CRC, `CRC_EN` must be set to 0b01 while `CRC_EN_B` is set to 0b10 in the same write transaction.

To disable the CRC, `CRC_ENABLE` must be set to 0b00 while `CRC_ENABLE_B` is set to 0b11 in the same write transaction. Writing inverted values to two separate fields reduces the chances of CRC being enabled by mistake. \overline{CS} must be brought high at the end of the enable or disable write. The transaction following the enabling of the CRC must already include the CRC byte, regardless if it is a write or read operation. A register write transaction that disables CRC must still include the CRC code at the end, but the transaction following the disabling of the CRC does not have to include the CRC byte.

Figure 76 and Figure 77 show how a CRC code is appended at the end of a write or read transaction, respectively, in single SPI mode (classic mode). For register writes, the digital host must generate the CRC by performing the calculation described in Equation 1 on the seed, the address, and the data. The AD3552R performs the

same calculation and shifts out the CRC code on SDO at the same time as the host. The transaction is free of error if both CRC codes match. For register reads, the host calculates the CRC on the seed, the address, and a zero padding while the AD3552R calculates the CRC on the seed, the address, and the readout data. Both nodes then shift out the CRC code at the same time so that it can be checked on both sides.

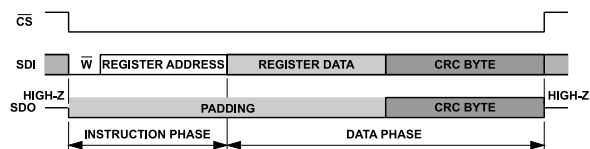

Figure 76. Basic SPI Write Frame with CRC

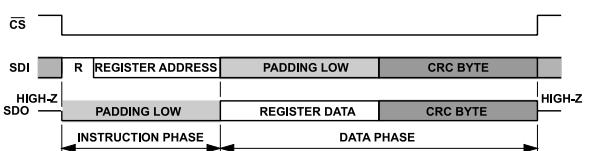

Figure 77. Basic SPI Read Frame with CRC

When accessing multibyte registers with CRC error detection enabled, the CRC code is placed after all of the bytes of register data.

When CRC error detection is enabled, the AD3552R does not update its register contents in response to a register write transaction unless it receives a valid CRC code at the end of the register data. If the CRC code is invalid, or if the digital host fails to transmit the CRC code, the AD3552R does not update its register contents, and the `INVALID_OR_NO_CRC` flag in the `INTERFACE_STATUS_A` register is set. The `INVALID_OR_NO_CRC` flag is cleared when 1 is written to this bit, and the correct CRC is required for the write to clear the bit to take effect.

Table 11 shows the seed value used in the CRC code calculation and how it is calculated for both single instruction mode and streaming mode.

Table 11. CRC Seed Values and Extent of CRC Calculation

SPI Transaction Type	Pin	Single Instruction Mode	Streaming Mode, First Data Phase	Streaming Mode, Subsequent Data Phases
Read	SDI	0xA5, instruction phase, padding	0xA5, instruction phase, padding	No CRC sent
	SDO	0xA5, instruction phase, read data	0xA5, instruction phase, read data	Least significant byte of address, read data
Write	SDI	0xA5, instruction phase, write data	0xA5, instruction phase, write data	Least significant byte of address, write data
	SDO	0xA5, instruction phase, write data	0xA5, instruction phase, write data	Least significant byte of address, write data

THEORY OF OPERATION

When using single instruction mode, every CRC code in an SPI frame uses 0xA5 as the seed value to prevent stuck at fault conditions for Address 0x00.

When using streaming mode, the first CRC code in an SPI frame also uses 0xA5 as the seed value, but subsequent CRC codes in the same frame are calculated using the least significant byte of the register address being accessed in the SPI transaction as the seed value.

Because enabling the CRC in single SPI (classic) mode requires that the SDO pin shifts out the CRC calculated by the AD3552R,

the transaction must respect the limitations of a read operation, which is that DDR is disabled. CRC is not allowed in synchronous dual SPI mode.

In dual and quad SPI modes, the CRC is appended at the end of the byte or multibyte register transaction but the CRC is generated only by the controller (write) or by the AD3552R (read), as shown in [Figure 78](#) and [Figure 79](#).

When CRC error detection is enabled, do not use streaming mode, including looping, if the range of registers being addressed includes unused or reserved registers.

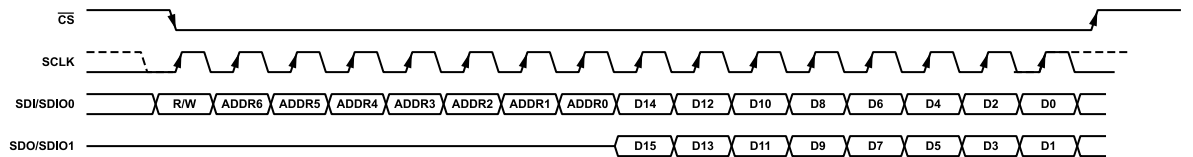

Figure 78. Dual SPI Transaction with CRC

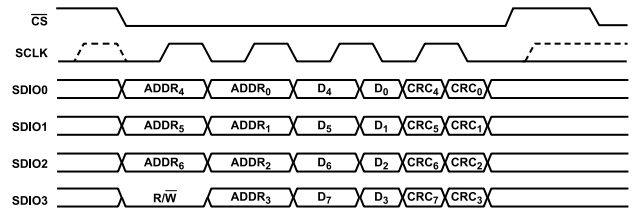

Figure 79. Quad SPI Transaction with CRC

THEORY OF OPERATION

SERIAL INTERFACE

The AD3552R implements a versatile serial interface that is compatible with several SPI modes. When the QSPI pin is tied low, the interface is configured in single SPI (classic SPI) mode by default and can be switched to dual SPI or synchronous dual SPI mode by acting on the configuration registers. When the QSPI pin is pulled high, the interface is configured in quad SPI mode. DDR can be enabled in any of the modes to duplicate the transfer speed in the data phase.

Clock polarity (CPOL) can be 1 or 0, but clock phase (CPHA) must be always 0. These combinations correspond to SPI Mode 0 and Mode 3, which are applicable when the SPI interface is in single data rate (SDR) mode.

Single SPI (Classic) Mode

In single SPI (classic) mode, the SDI/SDIO0 and SDO/SDIO1 data lines are unidirectional. The SDI signal behaves as an input to transfer data from master to slave and the SDO signal behaves as an output to transfer data from slave to master, as shown in Figure 80. Single SPI (classic) mode is compatible with SPI Mode 0 and Mode 3, as well as with completely synchronous interfaces, such as synchronous serial port (SPORT™). See Figure 2 for a timing diagram of a typical write sequence. See the AN-1248 Application Note, *SPI Interface*, for more information about the classic SPI mode.

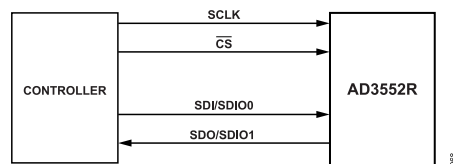

Figure 80. Single SPI (Classic SPI) Connection

Dual SPI Mode

In dual SPI mode, the SDI/SDIO0 and SDO/SDIO1 data lines are bidirectional, as shown in Figure 81. During the data phase, the R/W bit of the instruction phase defines the direction of the data lines. During the instruction phase, the data lines are always configured as inputs. In dual SPI mode, consecutive bits are serialized in groups of two, as shown in Figure 82.

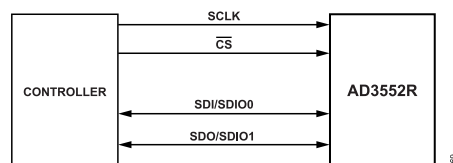

Figure 81. Dual SPI Connection

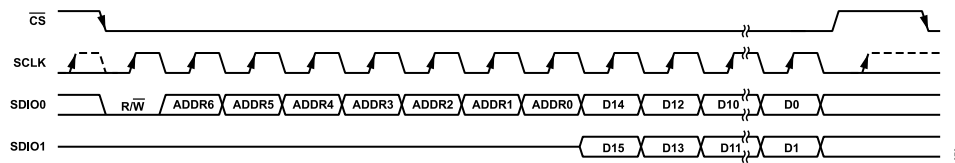

Figure 82. Dual SPI Mode

THEORY OF OPERATION

Synchronous Dual SPI Mode

In synchronous dual SPI mode, similar to dual SPI mode, the SDI/SDIO0 and SDO/SDIO1 data lines are bidirectional, as shown in [Figure 81](#). During the data phase, the R/\bar{W} bit of the instruction phase defines the direction of the data lines. During the instruction phase, the data lines are always configured as inputs. In contrast to dual SPI mode, in synchronous dual SPI mode each SDIO line serializes the data of one DAC, as shown in [Figure 83](#).

In this mode, the data transferred on the SDIO0 line is loaded to the register addressed in the instruction phase, while the data transferred on the SDIO1 line is loaded to the register at the address given in the instruction phase that is incremented by 3

bytes in precision mode or the address given in the instruction phase that is incremented by 2 bytes in fast mode.

Synchronous dual SPI mode can only be used to write the CHx_DAC_16B, CHx_DAC_24B, CHx_INPUT_16B, and CHx_INPUT_24B registers. To write other registers within the secondary region, classic SPI must be used.

This transfer mode is useful when the controller is made up of two entities, each one addressing one DAC with a single bit stream, or when the CPU cannot serialize the data in groups of two bits. This mode also allows the simultaneous update of both channels without any time skew when the \bar{LDAC} signal is not used.

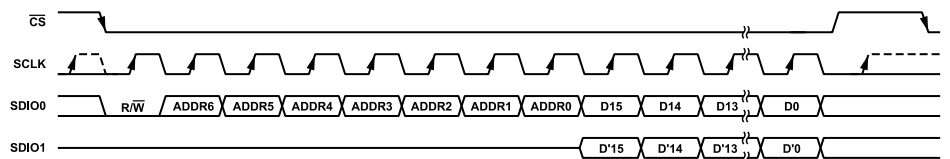

Figure 83. Synchronous Dual SPI Mode

THEORY OF OPERATION

Quad SPI Mode

In quad SPI mode, the SDI/SDIO0, SDO/SDIO1, SDIO2, and SDIO3 data lines are bidirectional, as shown in Figure 84. During the data phase, the R/W bit of the instruction phase defines the direction of the data lines. During the instruction phase, the data lines are always configured as inputs. In quad SPI mode, consecutive bits are serialized in groups of four, as shown in Figure 85.

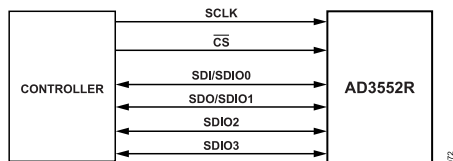

Figure 84. Quad SPI Connection

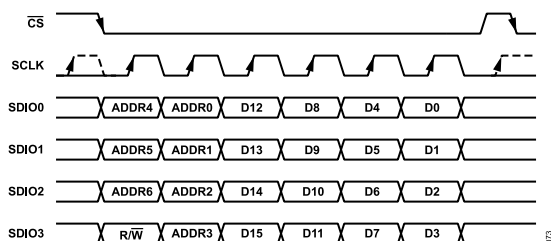

Figure 85. Quad SPI Mode

Double Data Rate (DDR)

Irrespective of the SPI mode being used, DDR can be enabled by setting the SPI_CONFIG_DDR bit in the INTERFACE_CONFIG_D register, which allows sampling data during the data phase on both clock edges, as shown in Figure 86. After this mode is enabled, all data must be written using DDR.

DDR is only usable in the data phase during write operations. In readback operations, the SPI_CONFIG_DDR bit is ignored, and data is transferred from the AD3552R to the controller in single data rate, as shown in Figure 2, Figure 6, and Figure 10.

After changing the SPI mode or the SPI_CONFIG_DDR bit, CS must be brought high and a new access cycle must be started in the appropriate mode.

All valid SPI mode combinations are listed in Table 12.

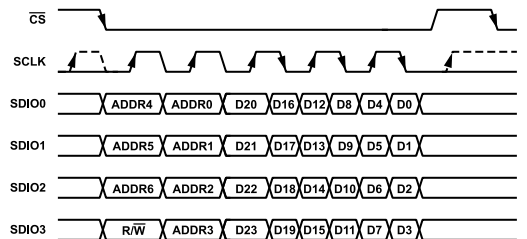

Figure 86. Quad SPI Mode DDR on a 24-Bit Register

Table 12. SPI Mode Combinations

SPI Mode	MULTI_IO_MODE	DUAL_SPI_SYNCHRONOUS_EN	SPI_CONFIG_DDR
Single SPI SDR	00	0	0
Single SPI DDR	00	0	1
Dual SPI SDR	01	0	0
Dual SPI DDR	01	0	1
Synchronous Dual SPI SDR	01	1	0
Synchronous Dual SPI DDR	01	1	1
Quad SPI SDR ¹	Not applicable	0	0
Quad SPI DDR ¹	Not applicable	0	1

¹ Enabled by the QSPI pin only.

THEORY OF OPERATION

Register Map SPI Access Modes

The register map is divided in two regions, primary and secondary.

The registers related to interface configuration, DAC configuration, and error flags are comprised in the primary region from Address 0x0 to Address 0x1E. If the QSPI pin is low, this region can only be accessed in classic SPI mode with or without DDR, regardless of the value of MULTI_IO_MODE in the TRANSFER_REGISTER.

The registers affecting the output value of the DAC are comprised in the secondary region from Address 0x28 to Address 0x4B. This region can be accessed in any of the SPI modes, with or without DDR.

If the QSPI pin is high, the interface is configured in full quad SPI mode for any communication to primary or secondary region registers.

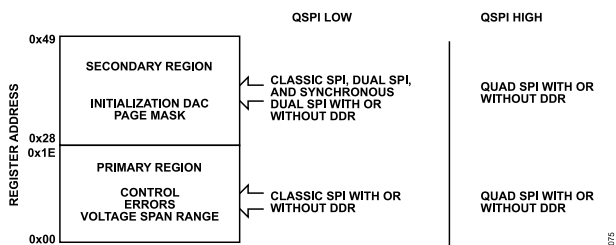

Figure 87. Register Access Modes

SDIO Drive Strength

The driving strength of the SDIO lines on Pins 5, 6, 7 and 8 can be configured to four different levels by setting the SDIO_DRIVE_STRENGTH bits in the INTERFACE_CONFIG_D register.

Higher drive strength value corresponds to a faster signal slew rate, as shown in Figure 88. However, higher slew rate means higher peak current and higher digital noise in the system. The default value is medium low strength.

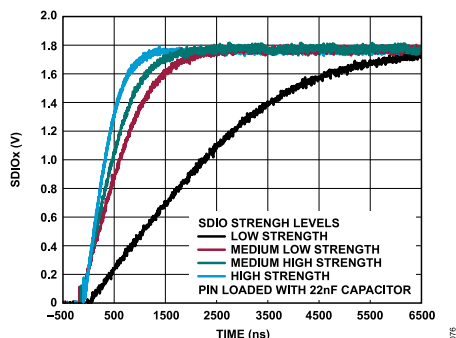

Figure 88. Driving Strength Options

DAC UPDATE MODES

There are several ways to update the DAC outputs, synchronously or asynchronously, simultaneously, or individually.

A synchronous update occurs when the change of the DAC output is triggered by an external signal, such as LDAC, which can be common to many devices. In this case, the controller loads a value in the input register that is later transferred to the DAC register on the falling edge of the LDAC signal, causing the simultaneous update of all V_{OUT} signals.

If the synchronous update is only required in one of the DACs, the LDAC signal can be masked using the HW_LDAC_MASK_CHx bits in the HW_LDAC_16B or the HW_LDAC_24B registers depending on the precision mode.

An asynchronous update occurs when the change of the DAC output follows an operation on the register set. In this case, the change is aligned with the SCLK edge that shifts the last register bit in. The update can be on one DAC or both DACs simultaneously following the several combinations described in Table 13.

Page mask registers can be used to transfer the same data to one or both channels, according to the value of the SEL_CHx bits in the CH_SELECT_16B or CH_SELECT_24B registers. Writing to the DAC_PAGE register transfers the data to the CHx_DAC registers and writing to the INPUT_PAGE register transfers the data to the CHx_INPUT registers. The data flow between registers is summarized in Figure 89.

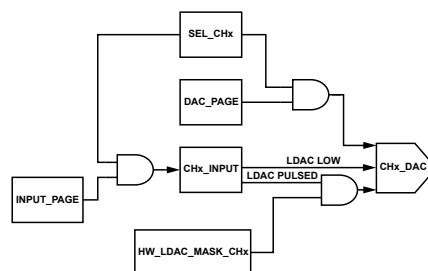

Figure 89. DAC Data Flow Between Registers

THEORY OF OPERATION

Table 13. DAC Update Modes

SPI Mode	Register Written	LDAC Pin	Synchronous	Simultaneous	Notes
Single, Dual, and Quad SPI	CHx_INPUT	Falling edge	Yes	Yes	No $\overline{\text{LDAC}}$ mask applied
Single, Dual, and Quad SPI	CHx_INPUT	Falling edge	Yes	No	$\overline{\text{LDAC}}$ mask applied, HW_LDAC register
Single, Dual, and Quad SPI	CHx_INPUT	High	No	Yes	Write to SW_LDAC triggers the update
Single, Dual, and Quad SPI	CHx_INPUT	Low	No	No	Output updates automatically
Single, Dual, and Quad SPI	CHx_DAC	Not applicable	No	No	Output updates immediately
Single, Dual, and Quad SPI	DAC_PAGE	Not applicable	No	Yes	Same data written to the DAC registers selected using the SEL_CHx bits in the CH_SELECT_16B register or the CH_SELECT_24B register
Single, Dual, and Quad SPI	INPUT_PAGE	Not applicable	No	No	Same data written to input registers selected using the SEL_CHx bits in the CH_SELECT_16B register or the CH_SELECT_24B register
Synchronous SPI	CHx_INPUT	Falling edge	Yes	Yes	No $\overline{\text{LDAC}}$ mask applied
Synchronous SPI	CHx_INPUT	Falling edge	Yes	No	$\overline{\text{LDAC}}$ mask applied, HW_LDAC register
Synchronous SPI	CHx_INPUT	Low	No	Yes	No $\overline{\text{LDAC}}$ mask applied
Synchronous SPI	CHx_DAC	Not applicable	No	Yes	Output updates immediately

POWER-DOWN

Each of the two DACs in the AD3552R can be individually disabled to reduce power consumption when the channel is not in use. Control is performed using the CHx_DAC_POWERDOWN bits in the POWERDOWN_CONFIG register.

RESET

The AD3552R implements three different ways to reset the device. All three methods trigger the same reset procedure internally, except for the difference explained in the [Software Reset](#) section.

Power-On Reset

The device integrates a power-on reset (POR) circuit that monitors AV_{DD} and DV_{DD} . Whenever AV_{DD} falls below 4 V or DV_{DD} falls below 1.3 V, an internal reset pulse is generated. This circuit ensures that the chip is correctly initialized at power-up or after a power dip.

Reset Pin

A low level on the $\overline{\text{RESET}}$ pin sets the chip in default mode, clearing the values of all registers, setting the DAC and V_{CM} outputs to 0 V, and keeping the SPI lines in high impedance. When the $\overline{\text{RESET}}$ line is released (returns high), the device starts executing the initialization procedure that can take up to 100 ms (t_{18} time). After reset, the DACs are in power-down mode and the DAC and V_{CM} outputs are still at 0 V.

During reset, the external transimpedance amplifier is still powered up and it may produce some oscillation in the V_{OUT} signal.

Software Reset

The device can be reset from the SPI interface by setting the SW_RESET_MSB and SW_RESET_LSB bits in the INTERFACE_CONFIG_A register. The main difference between the software reset and the hardware reset using the $\overline{\text{RESET}}$ pin is that the former does not affect the INTERFACE_CONFIG_A register. The SW_RESET_MSB and SW_RESET_LSB bits clear after the reset operation has concluded.

ERROR DETECTION

The AD3552R can detect abnormal conditions both in the analog and digital domains. These errors are reported in the INTERFACE_STATUS_A and ERR_STATUS registers. The list of the errors mapped to the ERR_ALARM_MASK register and its corresponding source is shown in [Table 14](#). The errors listed in [Table 14](#) can assert the $\overline{\text{ALERT}}$ pin if it is not masked in the ERR_ALARM_MASK register. The $\overline{\text{ALERT}}$ pin is also asserted after reset and in case of initialization failure.

The error bits in the INTERFACE_STATUS_A and ERR_STATUS registers are sticky and keep their value until cleared with a write 1 operation. That is, to clear an error bit, write 1 on that specific bit location.

THEORY OF OPERATION

Table 14. Alarm Mask Register and Corresponding Error Source

Bit Number	Alarm Mask Register Bit Name	Error Source Register Name	Error Source Bit Name
6	REF_RANGE_ALARM_MASK	ERR_STATUS	REF_RANGE_ERR_STATUS
5	CLOCK_COUNT_ALARM_MASK	INTERFACE_STATUS_A	CLOCK_COUNTING_ERROR
4	MEM_CRC_ALARM_MASK	ERR_STATUS	MEM_CRC_ERR_STATUS
3	SPI_CRC_ERR_ALARM_MASK	INTERFACE_STATUS_A	INVALID_OR_NO_CRC
2	WRITE_TO_READ_ONLY_ALARM_MASK	INTERFACE_STATUS_A	WRITE_TO_READ_ONLY_REGISTER
1	PARTIAL_REGISTER_ACCESS_ALARM_MASK	INTERFACE_STATUS_A	PARTIAL_REGISTER_ACCESS
0	REGISTER_ADDRESS_INVALID_ALARM_MASK	INTERFACE_STATUS_A	REGISTER_ADDRESS_INVALID

ERR_STATUS Register

V_{REF} Detection

The REF_RANGE_ERR_STATUS bit in the ERR_STATUS register is set when the reference voltage drops below 1 V for more than 5 ms. Regardless, it is generated internally or provided externally via the V_{REF} pin. This feature is useful to detect an interruption in the external reference voltage or an overload condition on the V_{REF} pin when the internal reference is shared with another device.

SPI Mode Error

The SPI mode error is produced during streaming when the address pointer crosses the boundary between the secondary and the primary region with the SPI interface configured in dual SPI mode or synchronous SPI mode because this region can only be accessed in classic SPI mode or quad SPI mode. The DUAL_SPI_STREAM_EXCEEDS_DAC_ERR_STATUS bit is set in the ERR_STATUS register.

Register CRC

The AD3552R includes an internal CRC for the register map and the read only memory (ROM). The CRC is executed every 4.1 μs, and only includes the primary region of the register map because the secondary region is expected to be continuously written. The CRC can be disabled by clearing the MEM_CRC_EN bit in the INTERFACE_CONFIG_D register. If a CRC error is detected, the MEM_CRC_ERR_STATUS bit is set in the ERR_STATUS register. It is advisable to reset the device if this error occurs.

Reset Status

The RESET_STATUS bit in the ERR_STATUS register indicates that the AD3552R has been reset, either internally (POR or SW reset) or externally (via the RESET pin). The RESET_STATUS bit is set when the POR completes correctly. It is useful to detect unexpected reset conditions, such as a dip in power supply, and take corrective actions.

The RESET_STATUS bit causes the assertion of the ALERT pin and it is not maskable. Therefore, it must be cleared after reset or power-up to be able to detect new events via the ALERT signal.

INTERFACE_STATUS_A Register

Device Busy

The INTERFACE_NOT_READY bit in the INTERFACE_STATUS_A register is not an error, but a status bit. This bit can be polled to know when the device is ready to receive data from the controller.

SPI Clock Counter

The error reported in the CLOCK_COUNTING_ERR bit is produced when the number of SCLK cycles is not in accordance with the amount required to shift a multiple of 8 bits, taking into account the SPI mode (single, dual, or quad) and the DDR mode. The CLOCK_COUNTING_ERR bit is set in the ERR_STATUS register.

Valid combinations are shown in Table 15.

Table 15. Clock Cycles Required to Transfer One Byte

SPI Mode	DDR	Clock Cycles for 1 Byte
Single SPI	No	8
Single SPI	Yes	4
Dual SPI	No	4
Dual SPI	Yes	2
Quad SPI	No	2
Quad SPI	Yes	1

SPI CRC

The INVALID_OR_NO_CRC bit in the INTERFACE_STATUS_A register is set when the CRC is enabled and the CRC byte in the SPI transaction is missing or it does not match the calculated value. To clear this error, write 1 to this bit. Note that because CRC is enabled, this SPI transaction must have a valid CRC code to succeed.

Write to Read Only Register

If the host tries to write to a read only register, the WRITE_TO_READ_ONLY_REGISTER bit field is asserted in the INTERFACE_STATUS_A register. To clear this error, write 1 to the WRITE_TO_READ_ONLY_REGISTER bit.

THEORY OF OPERATION

Partial Register Access

The PARTIAL_REGISTER_ACCESS bit in the INTERFACE_STATUS_A register is set when a multibyte register is accessed for read or write partially, which means that the transaction ends before all the bytes of a multibyte register have been accessed. To clear this error, write 1 to the PARTIAL_REGISTER_ACCESS bit.

Invalid Access

When the host tries to access an invalid register address, the REGISTER_ADDRESS_INVALID bit is set in the INTERFACE_STATUS_A register. To clear this error, write 1 to this bit.

ALERT PIN

When one of the errors listed in Table 14 is detected and its corresponding bit in the ERR_ALARM_MASK register is set to 0, the ALERT pin is asserted. This pin can be used as an interrupt line for the CPU to take action when an error condition arises.

In addition, the $\overline{\text{ALERT}}$ pin is asserted when the RESET_STATUS bit is asserted in the ERR_STATUS register. This condition is not maskable. Therefore, the RESET_STATUS bit must be cleared after initialization to use the $\overline{\text{ALERT}}$ pin. If the pin remains asserted after clearing all the error sources, it means that there has been an error during the initialization of the device and it must be power cycled.

The $\overline{\text{ALERT}}$ pin requires a pull-up resistor that can be provided externally or internally. The chip incorporates an internal 2.5 k Ω

pull-up resistor that can be enabled by setting the ALERT_ENABLE_PULLUP bit in the INTERFACE_CONFIG_D register.

The $\overline{\text{ALERT}}$ pin is deasserted when all the errors are cleared in their corresponding registers.

DEVICE ID

The AD3552R includes numerous registers providing silicon related information. The following registers can be used to identify that the correct chip type and version are assembled:

- ▶ CHIP_TYPE
- ▶ PRODUCT_ID_L
- ▶ PRODUCT_ID_H
- ▶ CHIP_GRADE
- ▶ SPI_REVISION
- ▶ VENDOR_L
- ▶ VENDOR_H

SUMMARY OF INTERFACE ACCESS MODES

Finding the correct SPI mode can be difficult given the number of modes and the restrictions on specific registers or memory regions, specially when not using QSPI. To facilitate the implementation of the driver in the CPU, a decision tree is presented in Figure 90. Figure 90 depicts how the driver must proceed depending on the configuration of the interface and the registers being accessed when the QSPI pin is low. The decision tree is much simpler when QSPI is high, as shown in Figure 91.

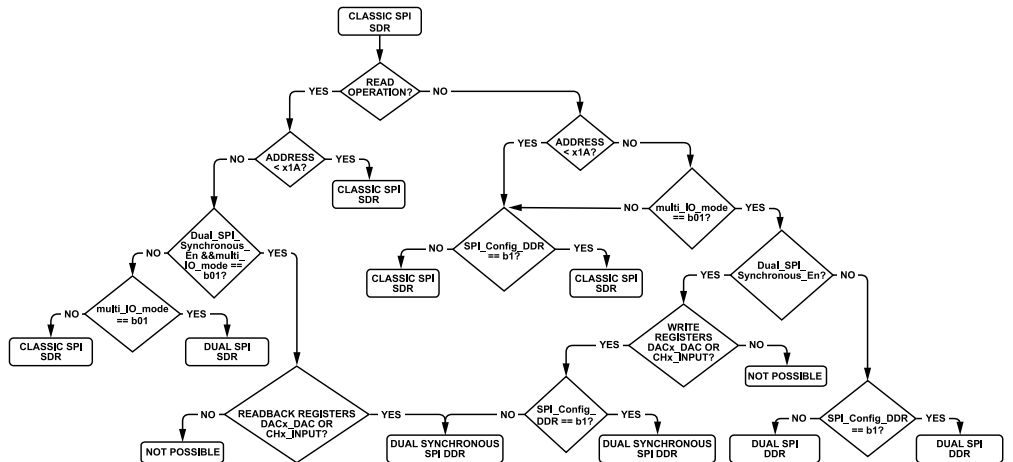

Figure 90. Register Access Modes when QSPI Pin is Low

THEORY OF OPERATION

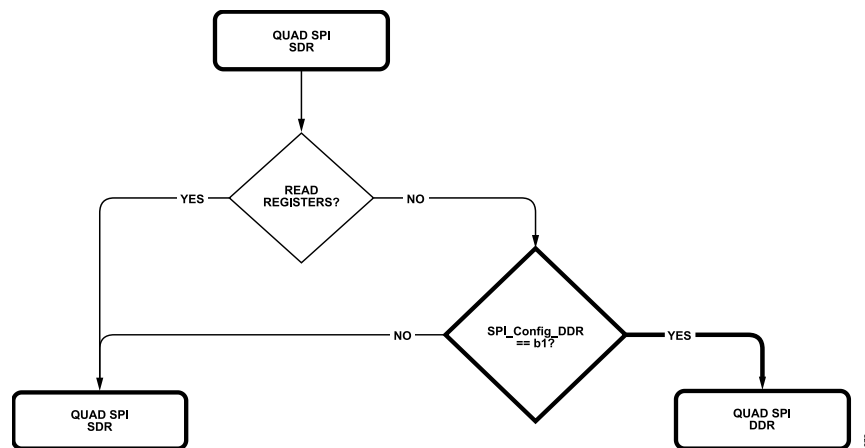

Figure 91. Register Access Modes when QSPI Pin is High

REGISTERS

REGISTER SUMMARY

Register List

Table 16. Register Summary

Address	Name	Description	Reset	Access
0x00	INTERFACE_CONFIG_A	Interface Configuration A Register.	0x10	R/W
0x01	INTERFACE_CONFIG_B	Interface Configuration B Register.	0x08	R/W
0x02	DEVICE_CONFIG	Device Configuration Register.	0x00	R
0x03	CHIP_TYPE	Chip Type Register.	0x04	R
0x04	PRODUCT_ID_L	Product ID Low Register.	0x08	R
0x05	PRODUCT_ID_H	Product ID High Register.	0x40	R
0x06	CHIP_GRADE	Chip Grade Register.	0x05	R
0x0A	SCRATCH_PAD	Scratch Pad Register.	0x00	R/W
0x0B	SPI_REVISION	SPI Revision Register.	0x83	R
0x0C	VENDOR_L	Vendor ID Low Register.	0x56	R
0x0D	VENDOR_H	Vendor ID High Register.	0x04	R
0x0E	STREAM_MODE	Stream Mode Register.	0x00	R/W
0x0F	TRANSFER_REGISTER	Transfer Configuration Register.	0x00	R/W
0x10	INTERFACE_CONFIG_C	Interface Configuration C Register.	0x23	R/W
0x11	INTERFACE_STATUS_A	Interface Status A Register.	0x00	R/W
0x14	INTERFACE_CONFIG_D	Interface Configuration D Register.	0x04	R/W
0x15	REFERENCE_CONFIG	Reference Configuration Register.	0x00	R/W
0x16	ERR_ALARM_MASK	Error Alarm Mask Register.	0x00	R/W
0x17	ERR_STATUS	Error Status Register.	0x01	R/W
0x18	POWERDOWN_CONFIG	Power-Down Configuration Register.	0x00	R/W
0x19	CH0_CH1_OUTPUT_RANGE	Output Range Register.	0x00	R/W
0x1B	CH0_OFFSET	Channel 0 Offset Register.	0x00	R/W
0x1C	CH0_GAIN	Channel 0 Gain Register.	0x00	R/W
0x1D	CH1_OFFSET	Channel 1 Offset Register.	0x00	R/W
0x1E	CH1_GAIN	Channel 1 Gain Register.	0x00	R/W
0x28	HW_LDAC_16B	Hardware LDAC Mask Register, Fast Mode.	0x00	R/W
0x29	CH0_DAC_16B	DAC Register for Channel 0, Fast Mode.	0x0000	R/W
0x2B	CH1_DAC_16B	DAC Register for Channel 1, Fast Mode.	0x0000	R/W
0x2D	DAC_PAGE_16B	DAC Page Register, Fast Mode.	0x0000	R/W
0x2F	CH_SELECT_16B	Channel Select for Page Registers, Fast Mode.	0x00	R/W
0x30	INPUT_PAGE_16B	Input Page Register, Fast Mode.	0x0000	R/W
0x32	SW_LDAC_16B	Software LDAC Register, Fast Mode.	0x00	W
0x33	CH0_INPUT_16B	Input Register for Channel 0, Fast Mode.	0x0000	R/W
0x35	CH1_INPUT_16B	Input Register for Channel 1, Fast Mode.	0x0000	R/W
0x37	HW_LDAC_24B	Hardware LDAC Mask Register, Precision Mode.	0x00	R/W
0x38	CH0_DAC_24B	DAC Register for Channel 0, Precision Mode.	0x000000	R/W
0x3B	CH1_DAC_24B	DAC Register for Channel 1, Precision Mode.	0x000000	R/W
0x3E	DAC_PAGE_24B	DAC Page Register, Precision Mode.	0x000000	R/W
0x41	CH_SELECT_24B	Channel Select for Page Registers, Precision Mode.	0x00	R/W
0x42	INPUT_PAGE_24B	Input Page Register, Precision Mode.	0x000000	R/W
0x45	SW_LDAC_24B	Software LDAC Register, Precision Mode.	0x00	W
0x46	CH0_INPUT_24B	Input Register for Channel 0, Precision Mode.	0x000000	R/W
0x49	CH1_INPUT_24B	Input Register for Channel 1, Precision Mode.	0x000000	R/W

REGISTERS

Detailed Register Map

Table 17. Detailed Register Summary

Reg	Name	Bits	Bit 7	Bit 6	Bit 5	Bit 4	Bit 3	Bit 2	Bit 1	Bit 0	Reset	RW
0x00	INTERFACE_CONFIG_A	[7:0]	SW_RESET_MSB	RESERVED	ADDR_DIRECTION	SDO_ACTIVE	RESERVED			SW_RESET_LSB	0x10	R/W
0x01	INTERFACE_CONFIG_B	[7:0]	SINGLE_INSTRUCTION	RESERVED			SHORT_INSTRUCTION	RESERVED			0x08	R/W
0x02	DEVICE_CONFIG	[7:0]	DEVICE_STATUS_3	DEVICE_STATUS_2	DEVICE_STATUS_1	DEVICE_STATUS_0	CUSTOM_MODES		OPERATING_MODES		0x00	R
0x03	CHIP_TYPE	[7:0]	RESERVED				CLASS				0x04	R
0x04	PRODUCT_ID_L	[7:0]	PRODUCT_ID[7:0]								0x08	R
0x05	PRODUCT_ID_H	[7:0]	PRODUCT_ID[15:8]								0x40	R
0x06	CHIP_GRADE	[7:0]	DEVICE_GRADE				DEVICE_REVISION				0x05	R
0x0A	SCRATCH_PAD	[7:0]	VALUE								0x00	R/W
0x0B	SPI_REVISION	[7:0]	VERSION								0x83	R
0x0C	VENDOR_L	[7:0]	VID[7:0]								0x56	R
0x0D	VENDOR_H	[7:0]	VID[15:8]								0x04	R
0x0E	STREAM_MODE	[7:0]	LENGTH								0x00	R/W
0x0F	TRANSFER_REGISTER	[7:0]	MULTI_IO_MODE		RESERVED			STREAM_LENGTH_KEEP_VALUE	RESERVED		0x00	R/W
0x10	INTERFACE_CONFIG_C	[7:0]	CRC_ENABLE		STRICT_REGISTER_ACCESS	RESERVED			CRC_ENABLE_B		0x23	R/W
0x11	INTERFACE_STATUS_A	[7:0]	INTERFACE_NOT_READY	RESERVED	CLOCK_COUNTING_ERROR	RESERVED	INVALID_OR_NO_CRC	WRITE_TO_READ_ONLY_REGISTER	PARTIAL_REGISTER_ACCESS	REGISTER_ADDRESS_INVALID	0x00	R/W
0x14	INTERFACE_CONFIG_D	[7:0]	RESERVED	ALERT_ENABLE_PULLUP	RESERVED	MEM_CRC_EN	SDIO_DRIVE_STRENGTH		DUAL_SPI_SYNCHRONOUS_EN	SPI_CONFIG_DDR	0x04	R/W
0x15	REFERENCE_CONFIG	[7:0]	RESERVED	IDUMP_FASTMODE	RESERVED				REFERENCE_VOLTAGE_SEL		0x00	R/W
0x16	ERR_ALARM_MASK	[7:0]	RESERVED	REF_RANGE_ALARM_MASK	CLOCK_COUNT_ERROR_ALARM_MASK	MEM_CRC_ERROR_ALARM_MASK	SPI_CRC_ERROR_ALARM_MASK	WRITE_TO_READ_ONLY_ALARM_MASK	PARTIAL_REGISTER_ACCESS_ALARM_MASK	REGISTER_ADDRESS_INVALID_ALARM_MASK	0x00	R/W
0x17	ERR_STATUS	[7:0]	RESERVED	REF_RANGE_ERROR_STATUS	DUAL_SPI_STREAM_EXCEEDS_DAC_ERROR_STATUS	MEM_CRC_ERROR_STATUS	RESERVED			RESET_STATUS	0x01	R/W
0x18	POWERDOWN_CONFIG	[7:0]	RESERVED		CH1_DAC_POWERDOWN	CH0_DAC_POWERDOWN	RESERVED				0x00	R/W
0x19	CH0_CH1_OUTPUT_RANGE	[7:0]	CH1_OUTPUT_RANGE_SEL				CH0_OUTPUT_RANGE_SEL				0x00	R/W
0x1B	CH0_OFFSET	[7:0]	CH0_OFFSET								0x00	R/W
0x1C	CH0_GAIN	[7:0]	CH0_RANGE_OVERRIDE	CH0_GAIN_SCALING_N		CH0_GAIN_SCALING_P		CH0_OFFSET_POLARITY	RESERVED		0x00	R/W
0x1D	CH1_OFFSET	[7:0]	CH1_OFFSET								0x00	R/W

REGISTERS

Table 17. Detailed Register Summary

Reg	Name	Bits	Bit 7	Bit 6	Bit 5	Bit 4	Bit 3	Bit 2	Bit 1	Bit 0	Reset	RW
0x1E	CH1_GAIN	[7:0]	CH1_RANGE_OVERRIDE	CH1_GAIN_SCALING_N		CH1_GAIN_SCALING_P		CH1_OFFSET_POLARITY	RESERVED		0x00	R/W
0x28	HW_LDAC_16B	[7:0]	RESERVED						HW_LDAC_MASK_CH1	HW_LDAC_MASK_CH0	0x00	R/W
0x2A	CH0_DAC_16B	[15:8]	DAC_DATA0[15:8]								0x00	R/W
0x29		[7:0]	DAC_DATA0[7:0]								0x00	
0x2C	CH1_DAC_16B	[15:8]	DAC_DATA1[15:8]								0x00	R/W
0x2B		[7:0]	DAC_DATA1[7:0]								0x00	
0x2E	DAC_PAGE_16B	[15:8]	DAC_PAGE[15:8]								0x00	R/W
0x2D		[7:0]	DAC_PAGE[7:0]								0x00	
0x2F	CH_SELECT_16B	[7:0]	RESERVED						SEL_CH1	SEL_CH0	0x00	R/W
0x31	INPUT_PAGE_16B	[15:8]	INPUT_PAGE[15:8]								0x00	R/W
0x30		[7:0]	INPUT_PAGE[7:0]								0x00	
0x32	SW_LDAC_16B	[7:0]	RESERVED						SW_LDAC_CH1	SW_LDAC_CH0	0x00	W
0x34	CH0_INPUT_16B	[15:8]	INPUT_DATA0[15:8]								0x00	R/W
0x33		[7:0]	INPUT_DATA0[7:0]								0x00	
0x36	CH1_INPUT_16B	[15:8]	INPUT_DATA1[15:8]								0x00	R/W
0x35		[7:0]	INPUT_DATA1[7:0]								0x00	
0x37	HW_LDAC_24B	[7:0]	RESERVED						HW_LDAC_MASK_CH1	HW_LDAC_MASK_CH0	0x00	R/W
0x3A	CH0_DAC_24B	[23:16]	DAC_DATA0[15:8]								0x00	R/W
0x39		[15:8]	DAC_DATA0[7:0]								0x00	
0x38		[7:0]	RESERVED								0x00	
0x3D	CH1_DAC_24B	[23:16]	DAC_DATA1[15:8]								0x00	R/W
0x3C		[15:8]	DAC_DATA1[7:0]								0x00	
0x3B		[7:0]	RESERVED								0x00	
0x40	DAC_PAGE_24B	[23:16]	DAC_PAGE[15:8]								0x00	R/W
0x3F		[15:8]	DAC_PAGE[7:0]								0x00	
0x3E		[7:0]	RESERVED								0x00	
0x41	CH_SELECT_24B	[7:0]	RESERVED						SEL_CH1	SEL_CH0	0x00	R/W
0x44	INPUT_PAGE_24B	[23:16]	INPUT_PAGE[15:8]								0x00	R/W
0x43		[15:8]	INPUT_PAGE[7:0]								0x00	
0x42		[7:0]	RESERVED								0x00	
0x45	SW_LDAC_24B	[7:0]	RESERVED						SW_LDAC_CH1	SW_LDAC_CH0	0x00	W
0x48	CH0_INPUT_24B	[23:16]	INPUT_DATA0[15:8]								0x00	R/W
0x47		[15:8]	INPUT_DATA0[7:0]								0x00	
0x46		[7:0]	RESERVED								0x00	
0x4B	CH1_INPUT_24B	[23:16]	INPUT_DATA1[15:8]								0x00	R/W
0x4A		[15:8]	INPUT_DATA1[7:0]								0x00	
0x49		[7:0]	RESERVED								0x00	

REGISTERS

INTERFACE REGISTER DETAILS

Interface Configuration A Register

Address: 0x00, Reset: 0x10, Name: INTERFACE_CONFIG_A

Interface configuration settings.

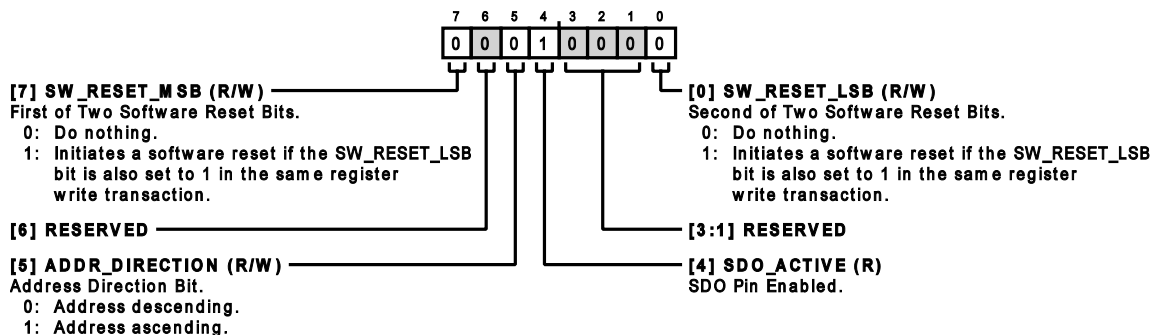

Table 18. Bit Descriptions for INTERFACE_CONFIG_A

Bits	Bit Name	Settings	Description	Reset	Access
7	SW_RESET_MSB		First of Two Software Reset Bits. Setting both software reset bits (SW_RESET_MSB and SW_RESET_LSB) in a single SPI write performs a software device reset, returning all registers (except the INTERFACE_CONFIG_A register) to the default power-up state. 0 Do nothing. 1 Initiates a software reset if the SW_RESET_LSB bit is also set to 1 in the same register write transaction.	0x0	R/W
6	RESERVED		Reserved.	0x0	R
5	ADDR_DIRECTION		Address Direction Bit. Determines sequential addressing behavior when performing register reads and writes on multiple bytes of data in a single data phase. 0 Address descending. Address accessed is automatically decremented by one for each data byte when streaming or addressing multibyte registers. 1 Address ascending. Address accessed is automatically incremented by one for each data byte when streaming or addressing multibyte registers.	0x0	R/W
4	SDO_ACTIVE		SDO Pin Enabled.	0x1	R
[3:1]	RESERVED		Reserved.	0x0	R
0	SW_RESET_LSB		Second of Two Software Reset Bits. Setting both software reset bits (SW_RESET_MSB and SW_RESET_LSB) in a single SPI write performs a software device reset, returning all registers (except the INTERFACE_CONFIG_A register) to the default power-up state. 0 Do nothing. 1 Initiates a software reset if the SW_RESET_LSB bit is also set to 1 in the same register write transaction.	0x0	R/W

REGISTERS

Interface Configuration B Register

Address: 0x01, Reset: 0x08, Name: INTERFACE_CONFIG_B

Additional interface configuration settings.

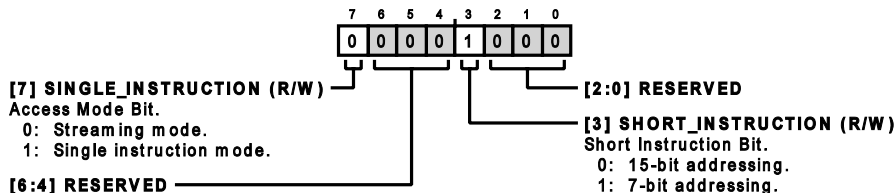

Table 19. Bit Descriptions for INTERFACE_CONFIG_B

Bits	Bit Name	Settings	Description	Reset	Access
7	SINGLE_INSTRUCTION		Access Mode Bit. Select streaming mode or single instruction mode. 0 Streaming mode. The address increments/decrements as successive data bytes are received according to the ADDR_DIRECTION bit setting in the INTERFACE_CONFIG_A register and the LENGTH bits setting in the STREAM_MODE register. 1 Single instruction mode.	0x0	R/W
[6:4]	RESERVED		Reserved.	0x0	R
3	SHORT_INSTRUCTION		Short Instruction Bit. Sets the length of the address in the instruction phase to 7 bits or 15 bits. 0 15-bit addressing. 1 7-bit addressing.	0x1	R/W
[2:0]	RESERVED		Reserved.	0x0	R

Device Configuration Register

Address: 0x02, Reset: 0x00, Name: DEVICE_CONFIG

This register is intended for compatibility with the standardized register map and it has no effect on this device.

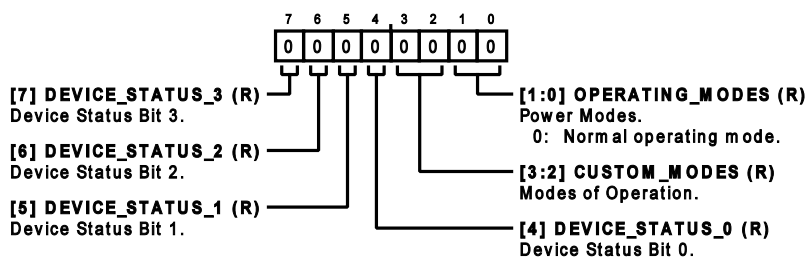

Table 20. Bit Descriptions for DEVICE_CONFIG

Bits	Bit Name	Settings	Description	Reset	Access
7	DEVICE_STATUS_3		Device Status Bit 3.	0x0	R
6	DEVICE_STATUS_2		Device Status Bit 2.	0x0	R
5	DEVICE_STATUS_1		Device Status Bit 1.	0x0	R
4	DEVICE_STATUS_0		Device Status Bit 0.	0x0	R
[3:2]	CUSTOM_MODES		Modes of Operation.	0x0	R
[1:0]	OPERATING_MODES		Power Modes. 0 Normal operating mode.	0x0	R

REGISTERS

Chip Type Register

Address: 0x03, Reset: 0x04, Name: CHIP_TYPE

The chip type register contains the identifier of the precision DAC family, which includes the [AD3552R](#). This register must be used in conjunction with the product ID to uniquely identify the [AD3552R](#).

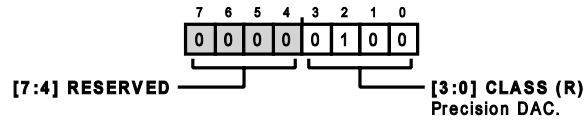

Table 21. Bit Descriptions for CHIP_TYPE

Bits	Bit Name	Settings	Description	Reset	Access
[7:4]	RESERVED		Reserved.	0x0	R
[3:0]	CLASS		Precision DAC.	0x4	R

Product ID Low Register

Address: 0x04, Reset: 0x08, Name: PRODUCT_ID_L

Low byte of the product ID.

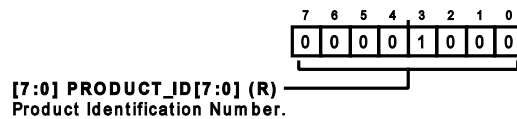

Table 22. Bit Descriptions for PRODUCT_ID_L

Bits	Bit Name	Settings	Description	Reset	Access
[7:0]	PRODUCT_ID[7:0]		Product Identification Number.	0x8	R

Product ID High Register

Address: 0x05, Reset: 0x40, Name: PRODUCT_ID_H

High byte of the product ID.

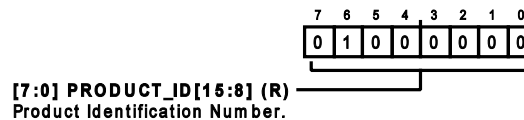

Table 23. Bit Descriptions for PRODUCT_ID_H

Bits	Bit Name	Settings	Description	Reset	Access
[7:0]	PRODUCT_ID[15:8]		Product Identification Number.	0x40	R

REGISTERS

Chip Grade Register

Address: 0x06, Reset: 0x05, Name: CHIP_GRADE

Identifies product variations and device revisions. The device revision refers to the version of the silicon and the device grade refers to the version of the test procedure.

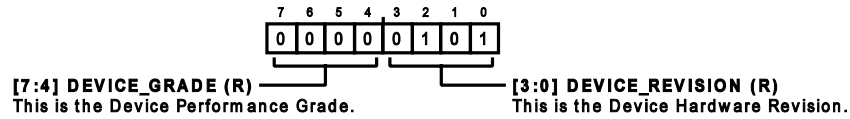

Table 24. Bit Descriptions for CHIP_GRADE

Bits	Bit Name	Settings	Description	Reset	Access
[7:4]	DEVICE_GRADE		This is the Device Performance Grade.	0x0	R
[3:0]	DEVICE_REVISION		This is the Device Hardware Revision.	0x5	R

Scratch Pad Register

Address: 0x0A, Reset: 0x00, Name: SCRATCH_PAD

This register has no functional purpose. It is provided to test write and read operations.

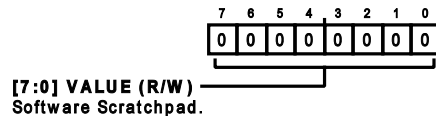

Table 25. Bit Descriptions for SCRATCH_PAD

Bits	Bit Name	Settings	Description	Reset	Access
[7:0]	VALUE		Software Scratchpad.	0x0	R/W

SPI Revision Register

Address: 0x0B, Reset: 0x83, Name: SPI_REVISION

Indicates the SPI interface revision.

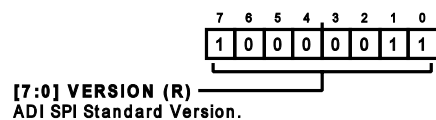

Table 26. Bit Descriptions for SPI_REVISION

Bits	Bit Name	Settings	Description	Reset	Access
[7:0]	VERSION		ADI SPI Standard Version.	0x83	R

REGISTERS

Vendor ID Low Register

Address: 0x0C, Reset: 0x56, Name: VENDOR_L

Low byte of the vendor ID.

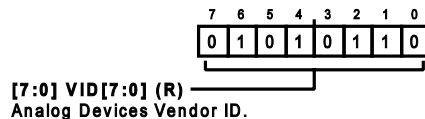

Table 27. Bit Descriptions for VENDOR_L

Bits	Bit Name	Settings	Description	Reset	Access
[7:0]	VID[7:0]		Analog Devices Vendor ID.	0x56	R

Vendor ID High Register

Address: 0x0D, Reset: 0x04, Name: VENDOR_H

High byte of the vendor ID.

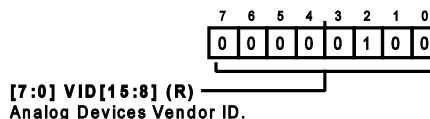

Table 28. Bit Descriptions for VENDOR_H

Bits	Bit Name	Settings	Description	Reset	Access
[7:0]	VID[15:8]		Analog Devices Vendor ID.	0x4	R

Stream Mode Register

Address: 0x0E, Reset: 0x00, Name: STREAM_MODE

Defines the length of the loop when streaming data.

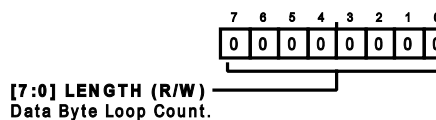

Table 29. Bit Descriptions for STREAM_MODE

Bits	Bit Name	Settings	Description	Reset	Access
[7:0]	LENGTH		Data Byte Loop Count. Specifies the data byte count before looping back to the start address. Only valid in streaming mode. A nonzero value sets the number of data bytes written or read before the address loops back to the start address. A maximum of 255 bytes can be transmitted using this approach. A value of 0x00 disables the loopback so that addressing wraps around at the upper and lower limits of memory.	0x0	R/W

REGISTERS

Transfer Configuration Register

Address: 0x0F, Reset: 0x00, Name: TRANSFER_REGISTER

This register configures the SPI mode used to transfer data and enables looping over the same register section when streaming data.

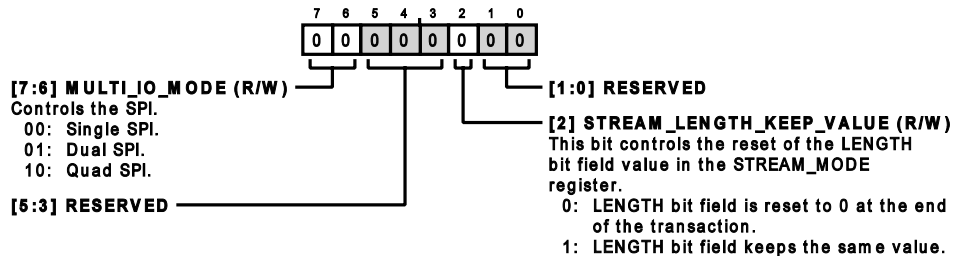

Table 30. Bit Descriptions for TRANSFER_REGISTER

Bits	Bit Name	Settings	Description	Reset	Access
[7:6]	MULTI_IO_MODE		Controls the SPI. 00 Single SPI. 01 Dual SPI. 10 Quad SPI.	0x0	R/W
[5:3]	RESERVED		Reserved.	0x0	R
2	STREAM_LENGTH_KEEP_VALUE		This bit controls the reset of the LENGTH bit field value in the STREAM_MODE register. 0 LENGTH bit field is reset to 0 at the end of the transaction. 1 LENGTH bit field keeps the same value.	0x0	R/W
[1:0]	RESERVED		Reserved.	0x0	R

Interface Configuration C Register

Address: 0x10, Reset: 0x23, Name: INTERFACE_CONFIG_C

Additional interface configuration settings.

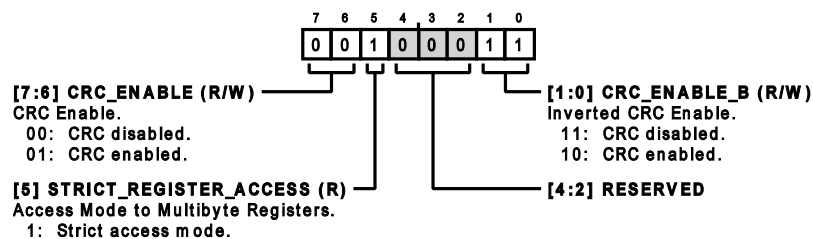

Table 31. Bit Descriptions for INTERFACE_CONFIG_C

Bits	Bit Name	Settings	Description	Reset	Access
[7:6]	CRC_ENABLE		CRC Enable. This field is written to enable/disable the use of the CRC error detection on the interface (when the device is in register mode). The CRC_ENABLE_B bits must also be written with the inverted value of the CRC_ENABLE bits in the same SPI write transaction for the CRC status to be changed. 00 CRC disabled. 01 CRC enabled.	0x0	R/W
5	STRICT_REGISTER_ACCESS		Access Mode to Multibyte Registers. This bit is read only. Register write transactions to multibyte registers must include data for	0x1	R

REGISTERS

Table 31. Bit Descriptions for INTERFACE_CONFIG_C

Bits	Bit Name	Settings	Description	Reset	Access
			each of its individual bytes for the register to be updated. Failure to write data to the entire multibyte register (entity) results in the register contents not being updated in memory, and the PARTIAL_REGISTER_ACCESS flag in the INTERFACE_STATUS_A register being set. 1 Strict access mode. Multibyte registers require all bytes to be read/written in full to avoid the PARTIAL_REGISTER_ACCESS bit being flagged.		
[4:2]	RESERVED		Reserved.	0x0	R
[1:0]	CRC_ENABLE_B		Inverted CRC Enable. This field must be written with the complementary value of the CRC_ENABLE field. 11 CRC disabled. 10 CRC enabled.	0x3	R/W

Interface Status A Register

Address: 0x11, Reset: 0x00, Name: INTERFACE_STATUS_A

This register flags several error conditions related to SPI communication and register addressing.

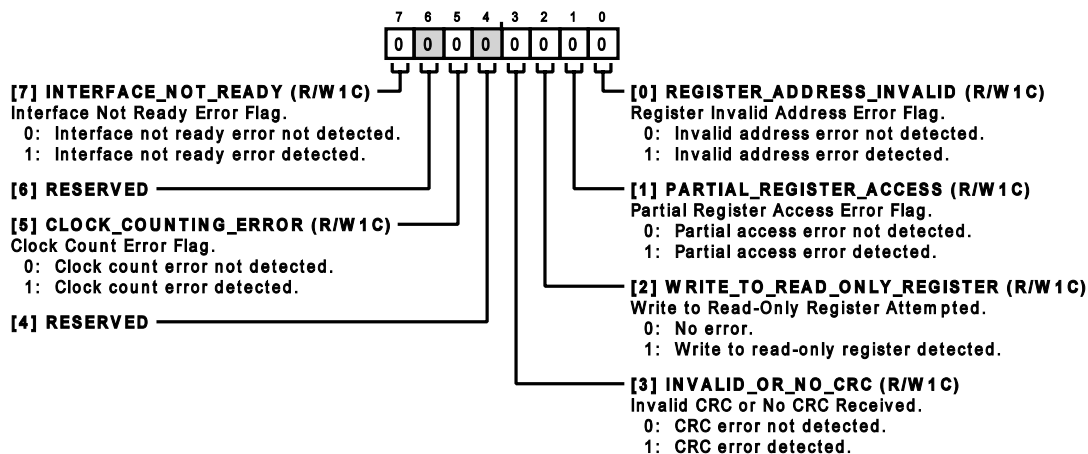

Table 32. Bit Descriptions for INTERFACE_STATUS_A

Bits	Bit Name	Settings	Description	Reset	Access
7	INTERFACE_NOT_READY		Interface Not Ready Error Flag. Indicates if the device interface was not ready for a transaction when an SPI read or write transaction was requested by the digital host (master). This flag bit is set if an SPI frame begins before the device is ready after a power-on reset. This error flag is write-1-to-clear (when this error flag is set, it can only be reset by writing a 1 to this bit). 0 Interface not ready error not detected. 1 Interface not ready error detected.	0x0	R/W1C
6	RESERVED		Reserved.	0x0	R
5	CLOCK_COUNTING_ERROR		Clock Count Error Flag. Indicates if the incorrect number of serial clock edges was detected in an SPI read or write transaction (for example, if the transaction was terminated in the middle of a byte). This error flag is write-1-to-clear	0x0	R/W1C

REGISTERS

Table 32. Bit Descriptions for INTERFACE_STATUS_A

Bits	Bit Name	Settings	Description	Reset	Access
			(when this error flag is set, it can only be reset by writing a 1 to this bit). 0 Clock count error not detected. 1 Clock count error detected.		
4	RESERVED		Reserved.	0x0	R
3	INVALID_OR_NO_CRC		Invalid CRC or No CRC Received. This is set when the master fails to send a CRC or when the device calculates and checks the CRC and finds its value is incorrect. This error flag is write-1-to-clear (when this error flag is set, it can only be reset by writing a 1 to this bit). 0 CRC error not detected. 1 CRC error detected.	0x0	R/W1C
2	WRITE_TO_READ_ONLY_REGISTER		Write to Read-Only Register Attempted. This bit indicates if the digital host attempts an SPI write to a register that contains exclusively read only fields. This error flag is write-1-to-clear (when this error flag is set, it can only be reset by writing a 1 to this bit). 0 No error. 1 Write to read-only register detected.	0x0	R/W1C
1	PARTIAL_REGISTER_ACCESS		Partial Register Access Error Flag. This bit is asserted when there are not enough bytes of data in a transaction addressed to a multibyte register. This error flag is write-1-to-clear (when this error flag is set, it can only be reset by writing a 1 to this bit). 0 Partial access error not detected. 1 Partial access error detected.	0x0	R/W1C
0	REGISTER_ADDRESS_INVALID		Register Invalid Address Error Flag. Indicates if an SPI read or write transaction was attempted on an invalid register address. This error flag is write-1-to-clear (when this error flag is set, it can only be reset by writing a 1 to this bit). 0 Invalid address error not detected. 1 Invalid address error detected.	0x0	R/W1C

REGISTERS

Interface Configuration D Register

Address: 0x14, Reset: 0x04, Name: INTERFACE_CONFIG_D

This register contains miscellaneous configuration bits affecting SPI communication and electrical parameters of digital signals.

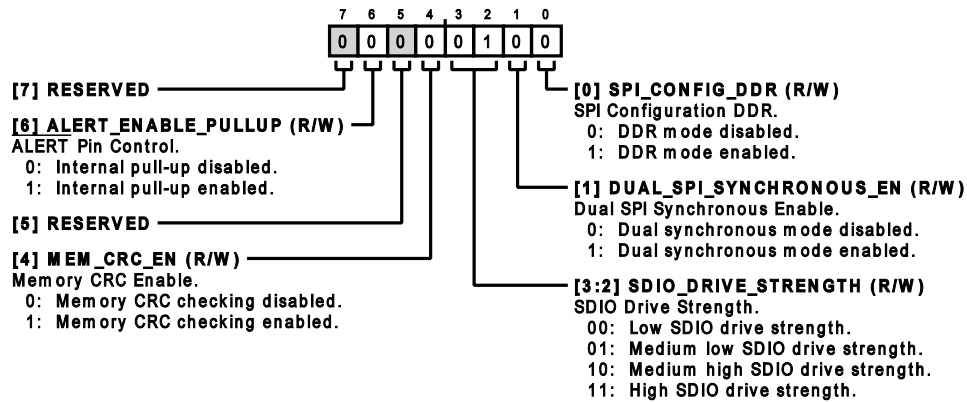

Table 33. Bit Descriptions for INTERFACE_CONFIG_D

Bits	Bit Name	Settings	Description	Reset	Access
7	RESERVED		Reserved.	0x0	R
6	ALERT_ENABLE_PULLUP		ALERT Pin Control. Enable internal 2.5 kΩ pull-up resistor. 0 Internal pull-up disabled. An external pull-up is required. 1 Internal pull-up enabled.	0x0	R/W
5	RESERVED		Reserved.	0x0	R
4	MEM_CRC_EN		Memory CRC Enable. This bit controls the continuous checking of the primary register set and the ROM memory. 0 Memory CRC checking disabled. 1 Memory CRC checking enabled.	0x0	R/W
[3:2]	SDIO_DRIVE_STRENGTH		SDIO Drive Strength. These two bits allow for the increase in SDIO drive strength. 00 Low SDIO drive strength. 01 Medium low SDIO drive strength. 10 Medium high SDIO drive strength. 11 High SDIO drive strength.	0x1	R/W
1	DUAL_SPI_SYNCHRONOUS_EN		Dual SPI Synchronous Enable. This bit controls the dual synchronous data transfer using one SDIO line for each DAC stream. 0 Dual synchronous mode disabled. 1 Dual synchronous mode enabled.	0x0	R/W
0	SPI_CONFIG_DDR		SPI Configuration DDR. This bit controls the use of DDR for data transfers. 0 DDR mode disabled. 1 DDR mode enabled.	0x0	R/W

REGISTERS

DAC REGISTER DETAILS

Reference Configuration Register

Address: 0x15, Reset: 0x00, Name: REFERENCE_CONFIG

This register controls the source and driving of the voltage reference.

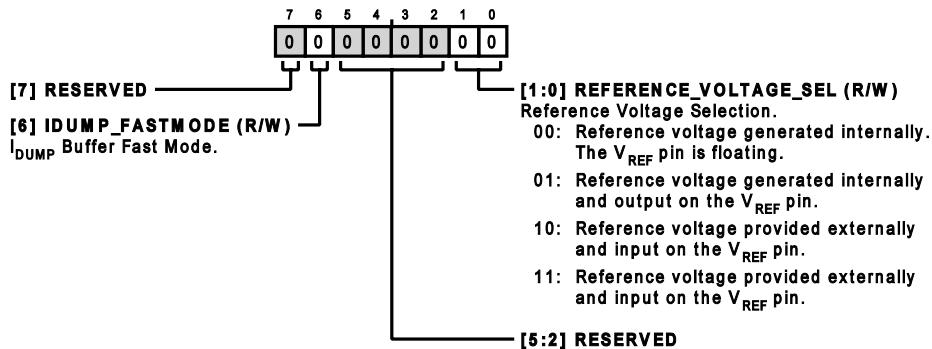

Table 34. Bit Descriptions for REFERENCE_CONFIG

Bits	Bit Name	Settings	Description	Reset	Access
7	RESERVED		Reserved.	0x0	R
6	IDUMP_FASTMODE		I _{DUMP} Buffer Fast Mode. Set this bit to increase the I _{DD} of the I _{DUMP} buffer of the amplifier to allow for a greater gain bandwidth.	0x0	R/W
[5:2]	RESERVED		Reserved.	0x0	R
[1:0]	REFERENCE_VOLTAGE_SEL		Reference Voltage Selection. These two bits are used to select the configuration of the reference voltage circuit. 00 Reference voltage generated internally. The V _{REF} pin is floating. 01 Reference voltage generated internally and output on the V _{REF} pin. 10 Reference voltage provided externally and input on the V _{REF} pin. 11 Reference voltage provided externally and input on the V _{REF} pin.	0x0	R/W

Error Alarm Mask Register

Address: 0x16, Reset: 0x00, Name: ERR_ALARM_MASK

This register selects which error conditions cause the assertion of the $\overline{\text{ALERT}}$ pin.

Table 35. Bit Descriptions for ERR_ALARM_MASK

Bits	Bit Name	Settings	Description	Reset	Access
7	RESERVED		Reserved.	0x0	R

REGISTERS

Table 35. Bit Descriptions for ERR_ALARM_MASK

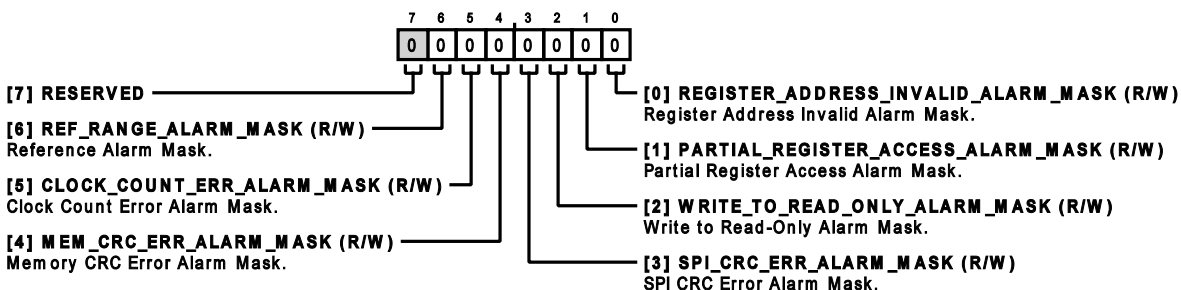
Bits	Bit Name	Settings	Description	Reset	Access
6	REF_RANGE_ALARM_MASK		Reference Alarm Mask. When set, the user can ignore alarms due to the reference dipping below 2 V.	0x0	R/W
5	CLOCK_COUNT_ERR_ALARM_MASK		Clock Count Error Alarm Mask. When set, the user can ignore alarms due to an insufficient number of clock periods for a user write.	0x0	R/W
4	MEM_CRC_ERR_ALARM_MASK		Memory CRC Error Alarm Mask. When set, the user can ignore alarms due to a memory CRC error.	0x0	R/W
3	SPI_CRC_ERR_ALARM_MASK		SPI CRC Error Alarm Mask. When set, the user can ignore alarms due to the SPI CRC checker.	0x0	R/W
2	WRITE_TO_READ_ONLY_ALARM_MASK		Write to Read-Only Alarm Mask. When set, the user can ignore alarms due to the user writing to a read-only register.	0x0	R/W
1	PARTIAL_REGISTER_ACCESS_ALARM_MASK		Partial Register Access Alarm Mask. When set, the user can ignore alarms due to the user not completing the write to a register.	0x0	R/W
0	REGISTER_ADDRESS_INVALID_ALARM_MASK		Register Address Invalid Alarm Mask. When set, the user can ignore alarms due to the user writing to an invalid register address.	0x0	R/W

Error Status Register

Address: 0x17, Reset: 0x01, Name: ERR_STATUS

This register signals a combination of errors in the analog and digital domains. All the bits are sticky and can be cleared by writing 1.

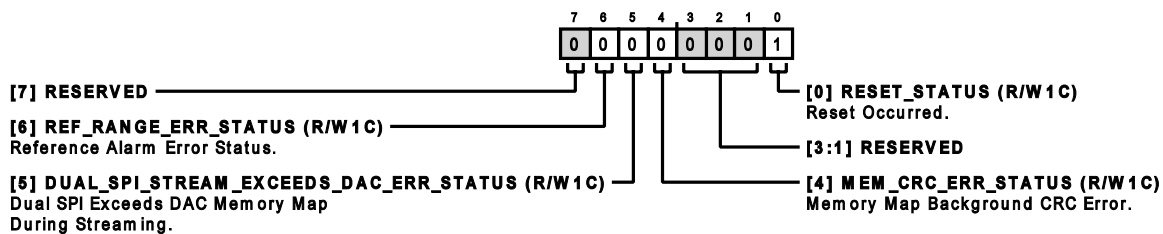

Table 36. Bit Descriptions for ERR_STATUS

Bits	Bit Name	Settings	Description	Reset	Access
7	RESERVED		Reserved.	0x0	R
6	REF_RANGE_ERR_STATUS		Reference Alarm Error Status. This bit indicates an alarm if the reference dips below 2 V.	0x0	R/W1C
5	DUAL_SPI_STREAM_EXCEEDS_DAC_ERR_STATUS		Dual SPI Exceeds DAC Memory Map During Streaming. This bit indicates an alarm when in dual SPI and streaming access goes beyond the DAC memory map.	0x0	R/W1C
4	MEM_CRC_ERR_STATUS		Memory Map Background CRC Error. This bit indicates an alarm when the background CRC detects	0x0	R/W1C

REGISTERS

Table 36. Bit Descriptions for ERR_STATUS

Bits	Bit Name	Settings	Description	Reset	Access
			bit corruption within the memory map.		
[3:1]	RESERVED		Reserved.	0x0	R
0	RESET_STATUS		Reset Occurred. This bit indicates that the device has just completed initialization following a reset. This bit asserts the $\overline{\text{ALERT}}$ pin and it is nonmaskable. Therefore, it must be cleared right after initialization.	0x1	R/W1C

Power-Down Configuration Register

Address: 0x18, Reset: 0x00, Name: POWERDOWN_CONFIG

This register controls the individual power-down of the DAC channels.

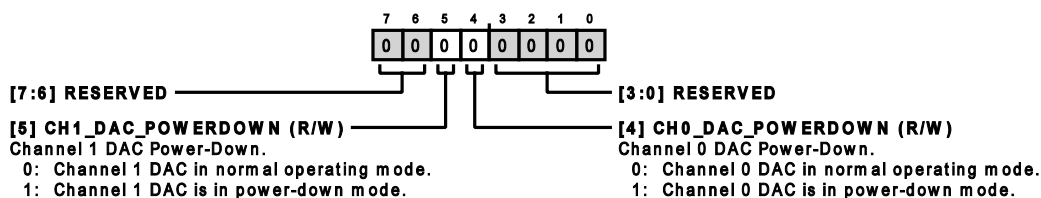

Table 37. Bit Descriptions for POWERDOWN_CONFIG

Bits	Bit Name	Settings	Description	Reset	Access
[7:6]	RESERVED		Reserved.	0x0	R
5	CH1_DAC_POWERDOWN		Channel 1 DAC Power-Down. 0 Channel 1 DAC in normal operating mode. 1 Channel 1 DAC is in power-down mode.	0x0	R/W
4	CH0_DAC_POWERDOWN		Channel 0 DAC Power-Down. 0 Channel 0 DAC in normal operating mode. 1 Channel 0 DAC is in power-down mode.	0x0	R/W
[3:0]	RESERVED		Reserved.	0x0	R

REGISTERS

Output Range Register

Address: 0x19, Reset: 0x00, Name: CH0_CH1_OUTPUT_RANGE

This register sets the output range of the DAC channels to one of the preconfigured ranges listed in Table 8. In addition to setting this register, the corresponding RFBx_y resistor must be connected to obtain the expected result.

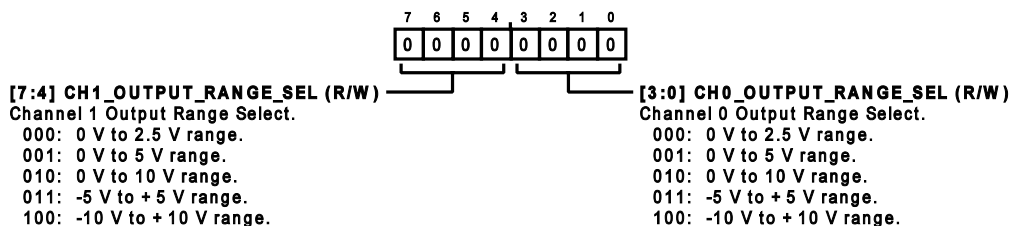

Table 38. Bit Descriptions for CH0_CH1_OUTPUT_RANGE

Bits	Bit Name	Settings	Description	Reset	Access
[7:4]	CH1_OUTPUT_RANGE_SEL		Channel 1 Output Range Select. The user can select which voltage output range is desired. 000 0 V to 2.5 V range. Requires RFB1_1 connection. 001 0 V to 5 V range. Requires RFB1_1 connection. 010 0 V to 10 V range. Requires RFB2_1 connection. 011 -5 V to +5 V range. Requires RFB2_1 connection. 100 -10 V to +10 V range. Requires RFB4_1 connection.	0x0	R/W
[3:0]	CH0_OUTPUT_RANGE_SEL		Channel 0 Output Range Select. The user can select which voltage output range is desired. 000 0 V to 2.5 V range. Requires RFB1_0 connection. 001 0 V to 5 V range. Requires RFB1_0 connection. 010 0 V to 10 V range. Requires RFB2_0 connection. 011 -5 V to +5 V range. Requires RFB2_0 connection. 100 -10 V to +10 V range. Requires RFB4_0 connection.	0x0	R/W

Channel 0 Offset Register

Address: 0x1B, Reset: 0x00, Name: CH0_OFFSET

This register configures the dc offset of the Channel 0 DAC. For this value to take effect, the CH0_RANGE_OVERRIDE bit must be set in the CH0_GAIN register.

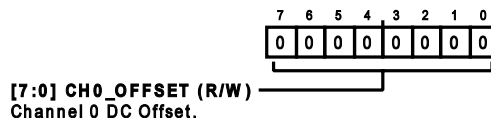

Table 39. Bit Descriptions for CH0_OFFSET

Bits	Bit Name	Settings	Description	Reset	Access
[7:0]	CH0_OFFSET		Channel 0 DC Offset.	0x0	R/W

REGISTERS

Channel 0 Gain Register

Address: 0x1C, Reset: 0x00, Name: CH0_GAIN

This register enables the configuration of custom span modes, configures the scaling of the PMOS DAC and NMOS DAC current sources, and controls the polarity of the offset value.

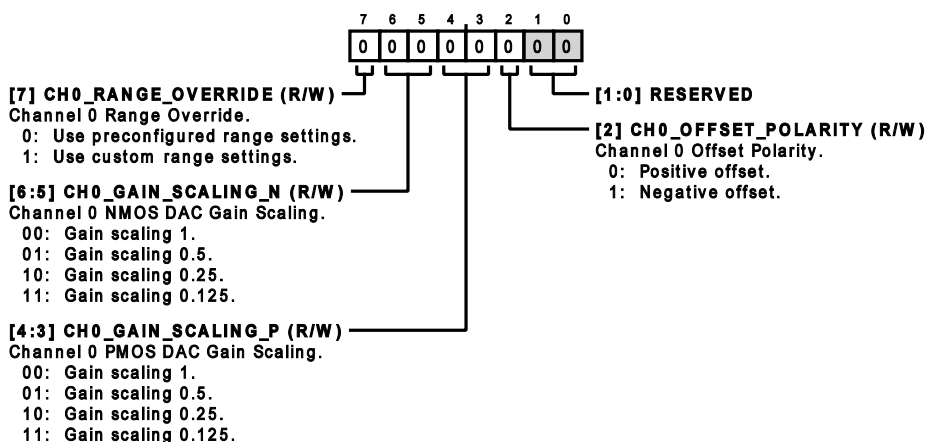

Table 40. Bit Descriptions for CH0_GAIN

Bits	Bit Name	Settings	Description	Reset	Access
7	CH0_RANGE_OVERRIDE		Channel 0 Range Override. This bit allows the user to override the preconfigured range settings and manually set offset and gain. 0 Use preconfigured range settings. 1 Use custom range settings.	0x0	R/W
[6:5]	CH0_GAIN_SCALING_N		Channel 0 NMOS DAC Gain Scaling. This field controls the multiplying factor for the codes applied to the NMOS DAC current sources. 00 Gain scaling 1. 01 Gain scaling 0.5. 10 Gain scaling 0.25. 11 Gain scaling 0.125.	0x0	R/W
[4:3]	CH0_GAIN_SCALING_P		Channel 0 PMOS DAC Gain Scaling. This field controls the multiplying factor for the codes applied to the PMOS DAC current sources. 00 Gain scaling 1. 01 Gain scaling 0.5. 10 Gain scaling 0.25. 11 Gain scaling 0.125.	0x0	R/W
2	CH0_OFFSET_POLARITY		Channel 0 Offset Polarity. This bit sets the polarity of the offset. 0 Positive offset. 1 Negative offset.	0x0	R/W
[1:0]	RESERVED		Reserved.	0x0	R

REGISTERS

Channel 1 Offset Register

Address: 0x1D, Reset: 0x00, Name: CH1_OFFSET

This register configures the dc offset of the Channel 0 DAC. For this value to take effect, the CH1_RANGE_OVERRIDE bit must be set in the CH1_GAIN register.

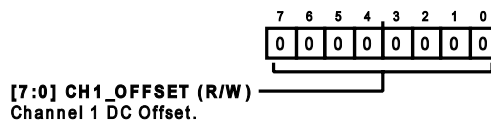

Table 41. Bit Descriptions for CH1_OFFSET

Bits	Bit Name	Settings	Description	Reset	Access
[7:0]	CH1_OFFSET		Channel 1 DC Offset.	0x0	R/W

Channel 1 Gain Register

Address: 0x1E, Reset: 0x00, Name: CH1_GAIN

This register enables the configuration of custom span modes, configures the scaling of the PMOS DAC and NMOS DAC current sources, and controls the polarity of the offset value.

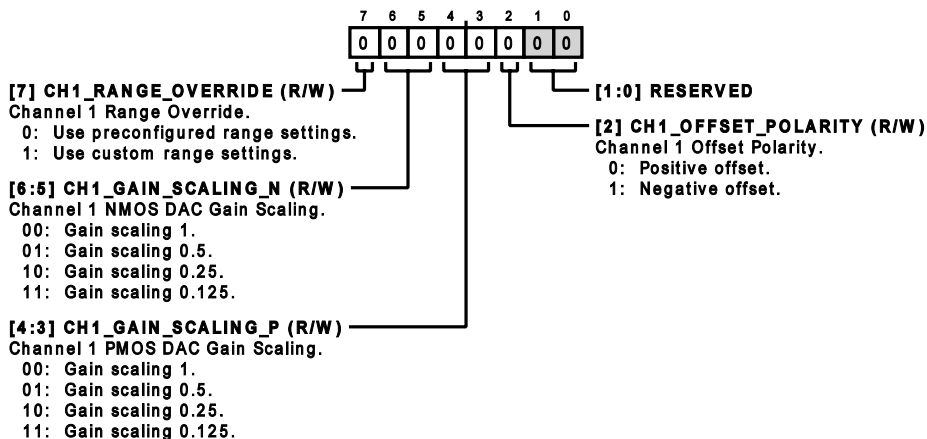

Table 42. Bit Descriptions for CH1_GAIN

Bits	Bit Name	Settings	Description	Reset	Access
7	CH1_RANGE_OVERRIDE		Channel 1 Range Override. This bit allows the user to override the preconfigured range settings and manually set offset and gain. 0 Use preconfigured range settings. 1 Use custom range settings.	0x0	R/W
[6:5]	CH1_GAIN_SCALING_N		Channel 1 NMOS DAC Gain Scaling. This field controls the multiplying factor for the codes applied to the NMOS DAC current sources. 00 Gain scaling 1. 01 Gain scaling 0.5. 10 Gain scaling 0.25. 11 Gain scaling 0.125.	0x0	R/W
[4:3]	CH1_GAIN_SCALING_P		Channel 1 PMOS DAC Gain Scaling. This field controls the multiplying factor for the codes applied to the PMOS DAC current sources. 00 Gain scaling 1. 01 Gain scaling 0.5.	0x0	R/W

REGISTERS

Table 42. Bit Descriptions for CH1_GAIN

Bits	Bit Name	Settings	Description	Reset	Access
			10 Gain scaling 0.25.		
			11 Gain scaling 0.125.		
2	CH1_OFFSET_POLARITY		Channel 1 Offset Polarity. This bit sets the polarity of the offset. 0 Positive offset. 1 Negative offset.	0x0	R/W
[1:0]	RESERVED		Reserved.	0x0	R

Hardware LDAC Mask Register, Fast Mode

Address: 0x28, Reset: 0x00, Name: HW_LDAC_16B

This register controls the masking of the external $\overline{\text{LDAC}}$ signal to latch data into each of the DAC channels.

Table 43. Bit Descriptions for HW_LDAC_16B

Bits	Bit Name	Settings	Description	Reset	Access
[7:2]	RESERVED		Reserved.	0x0	R
1	HW_LDAC_MASK_CH1		Hardware LDAC Mask for Channel 1. This bit controls the latching of data into the DAC register when the $\overline{\text{LDAC}}$ signal is asserted. 0 Data is latched in DAC Register 1 when the $\overline{\text{LDAC}}$ pin is asserted. 1 $\overline{\text{LDAC}}$ signal masked for Channel 1. DAC register is not updated when $\overline{\text{LDAC}}$ is asserted.	0x0	R/W
0	HW_LDAC_MASK_CH0		Hardware LDAC Mask for Channel 0. This bit controls the latching of data into the DAC register when the $\overline{\text{LDAC}}$ signal is asserted. 0 Data is latched in DAC Register 0 when the $\overline{\text{LDAC}}$ pin is asserted. 1 $\overline{\text{LDAC}}$ signal masked for Channel 0. DAC register is not updated when $\overline{\text{LDAC}}$ is asserted.	0x0	R/W

DAC Register for Channel 0, Fast Mode

Address: 0x29, Reset: 0x0000, Name: CH0_DAC_16B

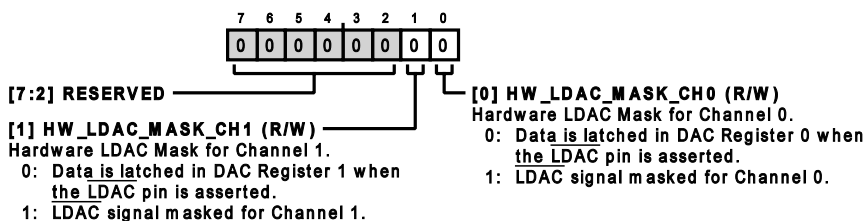
This register contains the data currently played on DAC Channel 0.

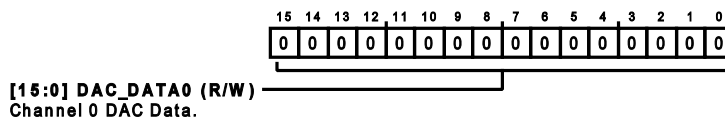

Table 44. Bit Descriptions for CH0_DAC_16B

Bits	Bit Name	Settings	Description	Reset	Access
[15:0]	DAC_DATA0		Channel 0 DAC Data.	0x0	R/W

REGISTERS

DAC Register for Channel 1, Fast Mode

Address: 0x2B, Reset: 0x0000, Name: CH1_DAC_16B

This register contains the data currently played on DAC Channel 1.

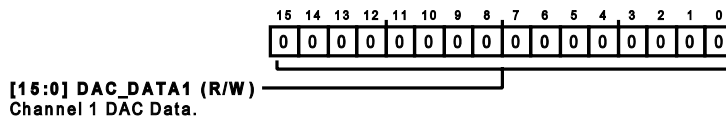

Table 45. Bit Descriptions for CH1_DAC_16B

Bits	Bit Name	Settings	Description	Reset	Access
[15:0]	DAC_DATA1		Channel 1 DAC Data.	0x0	R/W

DAC Page Register, Fast Mode

Address: 0x2D, Reset: 0x0000, Name: DAC_PAGE_16B

This register is used to write data to one or both channels according to the configuration of the SEL_CHx bits in the CH_SELECT_16B register. It can be used to write both channels simultaneously without using the LDAC signal.

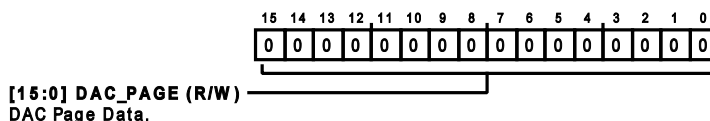

Table 46. Bit Descriptions for DAC_PAGE_16B

Bits	Bit Name	Settings	Description	Reset	Access
[15:0]	DAC_PAGE		DAC Page Data. Following a write to this register, the DAC code loaded into this register is copied into the DAC register of any channels selected in the CH_SELECT_16B register.	0x0	R/W

Channel Select for Page Registers, Fast Mode

Address: 0x2F, Reset: 0x00, Name: CH_SELECT_16B

This register selects which channel registers are updated following a write to the DAC_PAGE_16B or INPUT_PAGE_16B registers.

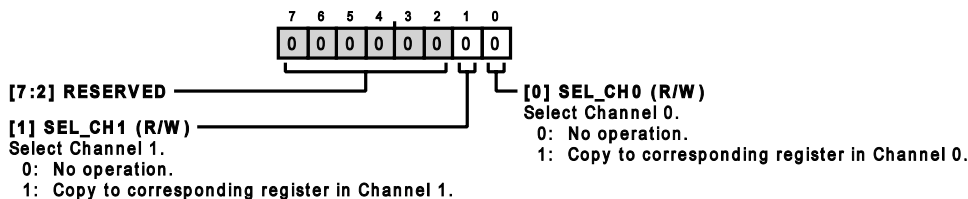

Table 47. Bit Descriptions for CH_SELECT_16B

Bits	Bit Name	Settings	Description	Reset	Access
[7:2]	RESERVED		Reserved.	0x0	R
1	SEL_CH1		Select Channel 1. When this bit is set, data written to the INPUT_PAGE_16B register is copied to the CH1_INPUT_16B register and data written to the DAC_PAGE_16B register is copied to the CH1_DAC_16B register. 0 No operation. 1 Copy to corresponding register in Channel 1.	0x0	R/W
0	SEL_CH0		Select Channel 0. When this bit is set, data written to the INPUT_PAGE_16B register is copied to the CH0_INPUT_16B register and data written to the DAC_PAGE_16B register is copied to the CH0_DAC_16B register.	0x0	R/W

REGISTERS

Table 47. Bit Descriptions for CH_SELECT_16B

Bits	Bit Name	Settings	Description	Reset	Access
		0	No operation.		
		1	Copy to corresponding register in Channel 0.		

Input Page Register, Fast Mode

Address: 0x30, Reset: 0x0000, Name: INPUT_PAGE_16B

This register is used to write data to one or both DAC input registers according to the configuration of the SEL_CHx bits in the CH_SELECT_16B register.

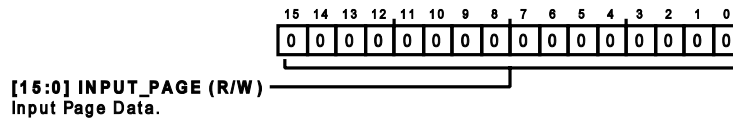

Table 48. Bit Descriptions for INPUT_PAGE_16B

Bits	Bit Name	Settings	Description	Reset	Access
[15:0]	INPUT_PAGE		Input Page Data. Following a write to this register, the DAC code loaded into this register is copied into the input register of any channels selected in the CH_SELECT_16B register.	0x0	R/W

Software LDAC Register, Fast Mode

Address: 0x32, Reset: 0x00, Name: SW_LDAC_16B

This register is used to trigger a data transfer between the input registers and the DAC registers. It is the software equivalent of pulsing the LDAC line low.

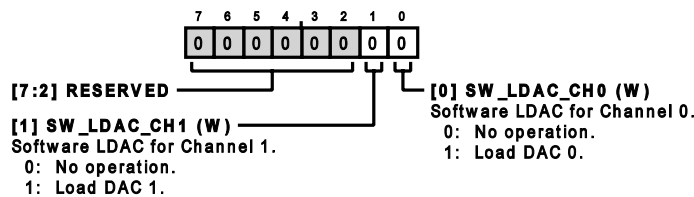

Table 49. Bit Descriptions for SW_LDAC_16B

Bits	Bit Name	Settings	Description	Reset	Access
[7:2]	RESERVED		Reserved.	0x0	R
1	SW_LDAC_CH1		Software LDAC for Channel 1. Setting this bit transfers contents from the CH1_INPUT_16B register to the CH1_DAC_16B register. This bit automatically resets after being written. 0 No operation. 1 Load DAC 1.	0x0	W
0	SW_LDAC_CH0		Software LDAC for Channel 0. Setting this bit transfers contents from the CH0_INPUT_16B register to the CH0_DAC_16B register. This bit automatically resets after being written. 0 No operation. 1 Load DAC 0.	0x0	W

REGISTERS

Input Register for Channel 0, Fast Mode

Address: 0x33, Reset: 0x0000, Name: CH0_INPUT_16B

This register contains the data to be transferred to the DAC register using one of the various trigger options, hardware LDAC, software LDAC, or automatic transfer.

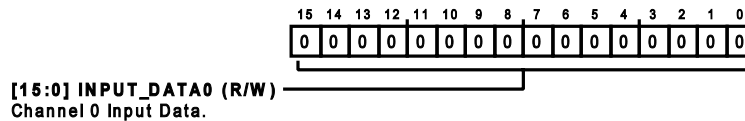

Table 50. Bit Descriptions for CH0_INPUT_16B

Bits	Bit Name	Settings	Description	Reset	Access
[15:0]	INPUT_DATA0		Channel 0 Input Data.	0x0	R/W

Input Register for Channel 1, Fast Mode

Address: 0x35, Reset: 0x0000, Name: CH1_INPUT_16B

This register contains the data to be transferred to the DAC register using one of the various trigger options, hardware LDAC, software LDAC, or automatic transfer.

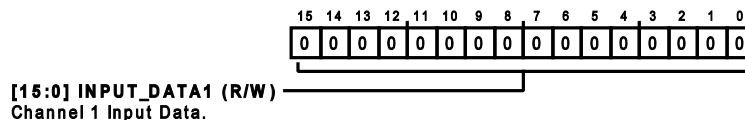

Table 51. Bit Descriptions for CH1_INPUT_16B

Bits	Bit Name	Settings	Description	Reset	Access
[15:0]	INPUT_DATA1		Channel 1 Input Data.	0x0	R/W

Hardware LDAC Mask Register, Precision Mode

Address: 0x37, Reset: 0x00, Name: HW_LDAC_24B

This register controls the masking of the external $\overline{\text{LDAC}}$ signal to latch data into each of the DAC channels.

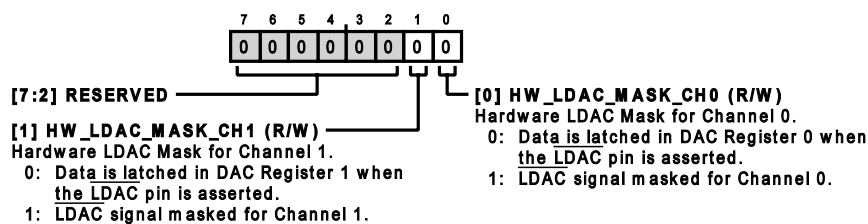

Table 52. Bit Descriptions for HW_LDAC_24B

Bits	Bit Name	Settings	Description	Reset	Access
[7:2]	RESERVED		Reserved.	0x0	R
1	HW_LDAC_MASK_CH1		Hardware LDAC Mask for Channel 1. This bit controls the latching of data into the DAC register when the $\overline{\text{LDAC}}$ signal is asserted. 0 Data is latched in DAC Register 1 when the $\overline{\text{LDAC}}$ pin is asserted. 1 $\overline{\text{LDAC}}$ signal masked for Channel 1. DAC register is not updated when $\overline{\text{LDAC}}$ is asserted.	0x0	R/W
0	HW_LDAC_MASK_CH0		Hardware LDAC Mask for Channel 0. This bit controls the latching of data into the DAC register when the $\overline{\text{LDAC}}$ signal is asserted.	0x0	R/W

REGISTERS

Table 52. Bit Descriptions for HW_LDAC_24B

Bits	Bit Name	Settings	Description	Reset	Access
		0	Data is latched in DAC Register 0 when the $\overline{\text{LDAC}}$ pin is asserted.		
		1	$\overline{\text{LDAC}}$ signal masked for Channel 0. DAC register is not updated when $\overline{\text{LDAC}}$ is asserted.		

DAC Register for Channel 0, Precision Mode

Address: 0x38, Reset: 0x000000, Name: CH0_DAC_24B

This register contains the data currently played on DAC Channel 0.

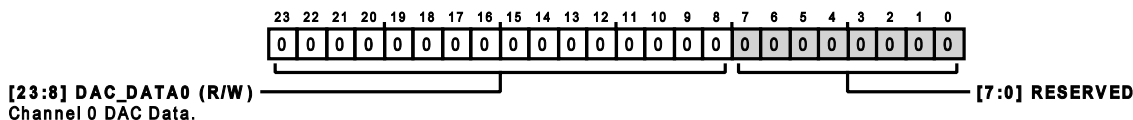

Table 53. Bit Descriptions for CH0_DAC_24B

Bits	Bit Name	Settings	Description	Reset	Access
[23:8]	DAC_DATA0		Channel 0 DAC Data.	0x0	R/W
[7:0]	RESERVED		Reserved.	0x0	R

DAC Register for Channel 1, Precision Mode

Address: 0x3B, Reset: 0x000000, Name: CH1_DAC_24B

This register contains the data currently played on DAC Channel 1.

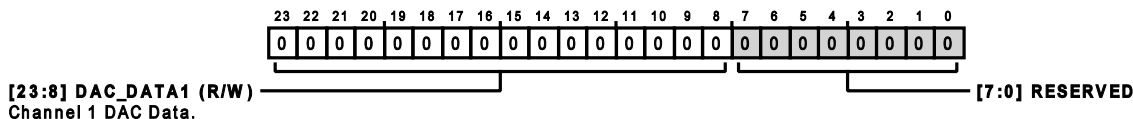

Table 54. Bit Descriptions for CH1_DAC_24B

Bits	Bit Name	Settings	Description	Reset	Access
[23:8]	DAC_DATA1		Channel 1 DAC Data.	0x0	R/W
[7:0]	RESERVED		Reserved.	0x0	R

DAC Page Register, Precision Mode

Address: 0x3E, Reset: 0x000000, Name: DAC_PAGE_24B

This register is used to write data to one or both channels according to the configuration of the SEL_CHx bits in the CH_SELECT_24B register. It can be used to write both channels simultaneously without using the $\overline{\text{LDAC}}$ signal.

Table 55. Bit Descriptions for DAC_PAGE_24B

Bits	Bit Name	Settings	Description	Reset	Access
[23:8]	DAC_PAGE		DAC Page Data. Following a write to this register, the DAC code loaded into this register is copied into the DAC register of any channels selected in the CH_SELECT_24B register.	0x0	R/W
[7:0]	RESERVED		Reserved.	0x0	R

REGISTERS

Channel Select for Page Registers, Precision Mode

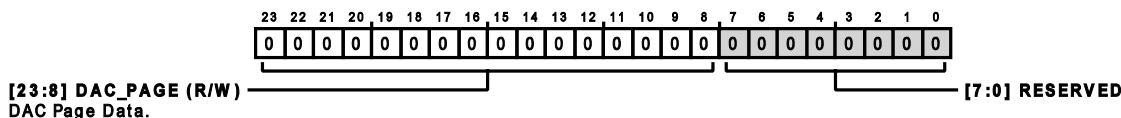
Address: 0x41, Reset: 0x00, Name: CH_SELECT_24B

This register selects which channel registers are updated following a write to the DAC_PAGE_24B or INPUT_PAGE_24B registers.

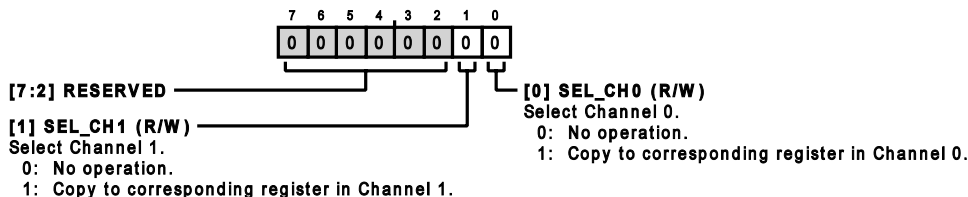

Table 56. Bit Descriptions for CH_SELECT_24B

Bits	Bit Name	Settings	Description	Reset	Access
[7:2]	RESERVED		Reserved.	0x0	R
1	SEL_CH1		Select Channel 1. When this bit is set, data written to the INPUT_PAGE_24B register is copied to the CH1_INPUT_24B register and data written to the DAC_PAGE_24B register is copied to the CH1_DAC_24B register. 0 No operation. 1 Copy to corresponding register in Channel 1.	0x0	R/W
0	SEL_CH0		Select Channel 0. When this bit is set, data written to the INPUT_PAGE_24B register is copied to the CH0_INPUT_24B register and data written to the DAC_PAGE_24B register is copied to the CH0_DAC_24B register. 0 No operation. 1 Copy to corresponding register in Channel 0.	0x0	R/W

Input Page Register, Precision Mode

Address: 0x42, Reset: 0x000000, Name: INPUT_PAGE_24B

This register is used to write data to one or both DAC input registers according to the configuration of the SEL_CHx bits in the CH_SELECT_24B register.

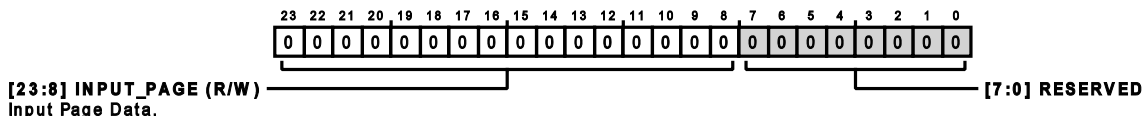

Table 57. Bit Descriptions for INPUT_PAGE_24B

Bits	Bit Name	Settings	Description	Reset	Access
[23:8]	INPUT_PAGE		Input Page Data. Following a write to this register, the DAC code loaded into this register is copied into the input register of any channels selected in the CH_SELECT_24B register.	0x0	R/W
[7:0]	RESERVED		Reserved.	0x0	R

REGISTERS

Software LDAC Register, Precision Mode

Address: 0x45, Reset: 0x00, Name: SW_LDAC_24B

This register is used to trigger a data transfer between the input registers and the DAC registers. It is the software equivalent of pulsing the LDAC line low.

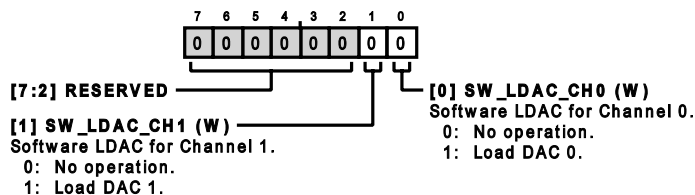

Table 58. Bit Descriptions for SW_LDAC_24B

Bits	Bit Name	Settings	Description	Reset	Access
[7:2]	RESERVED		Reserved.	0x0	R
1	SW_LDAC_CH1		Software LDAC for Channel 1. Setting this bit transfers contents from the CH1_INPUT_24B register to the CH1_DAC_24B register. This bit automatically resets after being written. 0 No operation. 1 Load DAC 1.	0x0	W
0	SW_LDAC_CH0		Software LDAC for Channel 0. Setting this bit transfers contents from the CH0_INPUT_24B register to the CH0_DAC_24B register. This bit automatically resets after being written. 0 No operation. 1 Load DAC 0.	0x0	W

Input Register for Channel 0, Precision Mode

Address: 0x46, Reset: 0x000000, Name: CH0_INPUT_24B

This register contains the data to be transferred to the DAC register using one of the various trigger options, hardware LDAC, software LDAC, or automatic transfer.

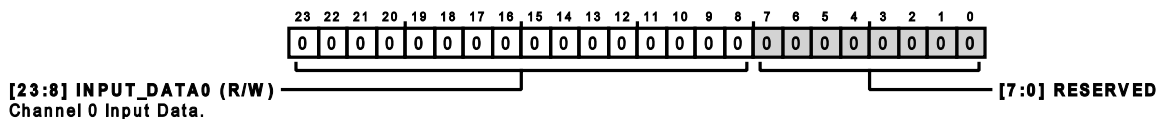

Table 59. Bit Descriptions for CH0_INPUT_24B

Bits	Bit Name	Settings	Description	Reset	Access
[23:8]	INPUT_DATA0		Channel 0 Input Data.	0x0	R/W
[7:0]	RESERVED		Reserved.	0x0	R

REGISTERS

Input Register for Channel 1, Precision Mode

Address: 0x49, Reset: 0x000000, Name: CH1_INPUT_24B

This register contains the data to be transferred to the DAC register using one of the various trigger options, hardware LDAC, software LDAC, or automatic transfer.

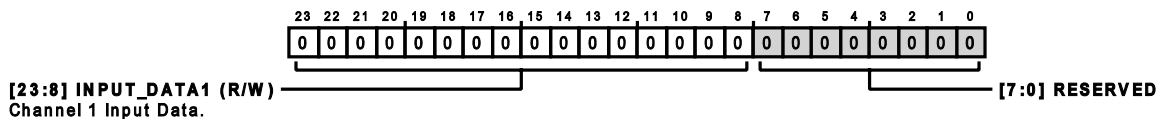

Table 60. Bit Descriptions for CH1_INPUT_24B

Bits	Bit Name	Settings	Description	Reset	Access
[23:8]	INPUT_DATA1		Channel 1 Input Data.	0x0	R/W
[7:0]	RESERVED		Reserved.	0x0	R

APPLICATIONS INFORMATION

POWER SUPPLY RECOMMENDATIONS

The AD3552R does not have any restriction for power supply sequencing. The chip incorporates a power monitor for AV_{DD} and DV_{DD} that releases the internal reset when both rails are within specification. Nevertheless, the recommended sequence to turn on the supply rails is GND, AV_{DD}, DV_{DD}, V_{LOGIC} because it minimizes the power-up glitch.

It is recommended to connect AGND and DGND together and have a single solid ground plane. The exposed pad under the chip must also be connected to the ground plane.

AV_{DD} has a constant power consumption that is independent of the update rate. The main caution for this rail is ensuring that noise level is low in the high frequencies, where AC PSRR is lower.

DV_{DD} has a variable power consumption that depends on the update rate and the SPI bus mode. Dynamic current has fast variations that cause the rail to be noisy. If DV_{DD} is derived from AV_{DD} a filter is recommended in addition to the LDO to completely remove the effect on the DAC output.

V_{LOGIC} has very low current demand that depends on the SPI bus mode and the type of access. Power consumption is maximum in readout operations in QSPI mode.

The recommended decoupling for the supply rails and the analog lines is shown in Figure 92.

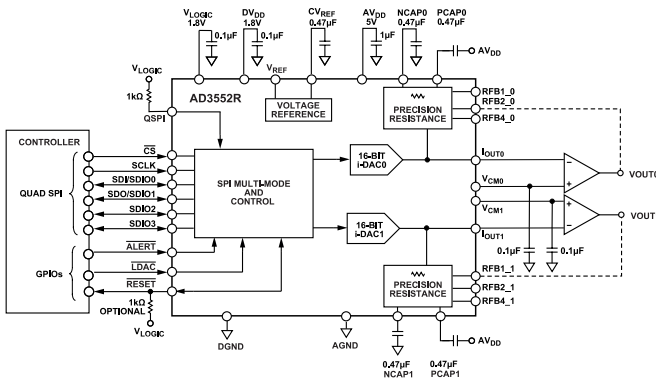

Figure 92. AD3552R Application Diagram with Quad SPI

The decoupling capacitors on PCAP_x, NCAP_x, V_{CMx}, and CV_{REF} can be adjusted to achieve the desired trade-off between noise floor, harmonic distortion, and power-up glitch amplitude.

Use capacitors with NP0 dielectric for NCAP_x, PCAP_x, feedback capacitors, and output filter capacitors to avoid the distortion caused by low frequency voltage variations. The decoupling capacitors for the supply rails, V_{CM} and CV_{REF}, can use materials with high dielectric constant because the voltage on these lines is constant.

COMBINING DAC CHANNELS

The AD3552R allows for combining of the two DAC channels to produce a single output. This results in lower noise density and faster settling time with higher power consumption.

To implement this configuration, both I_{OUTx} pins must be connected together and the same RFB_{x_y} pins from both DACS must be connected together. However, the feedback capacitor does not need to be duplicated if there is a single amplifier. An example for R_{FB2} is shown in Figure 93.

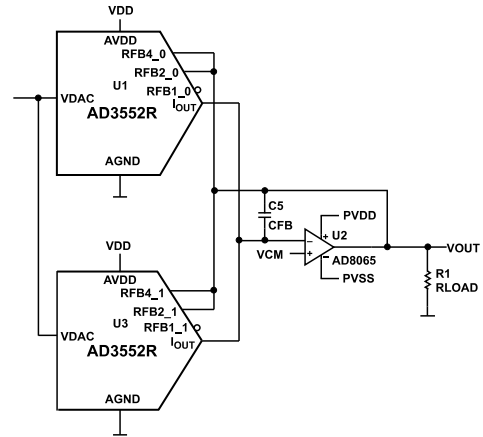

Figure 93. Dual DAC Configuration with RFB2_x

To obtain the same voltage output as when using a single DAC, both DACs must be updated simultaneously with the same code. The most efficient way to do this is using the DAC_PAGE register for a direct update or the INPUT_PAGE register for an update via the LDAC pin or a software LDAC command.

LAYOUT GUIDELINES

The pin configuration of the AD3552R, shown in Figure 13, is arranged in a way that facilitates the layout of the EVAL-AD3552R, which is shown in Figure 13. Most digital high speed lines are located on one side of the chip, with the analog functions of each DAC symmetrically distributed along the other three sides. This arrangement allows routing of the digital lines straight away from the analog functions, the placement of one amplifier on each side of the chip, and the external reference on the fourth side, as seen in Figure 94.

OUTLINE DIMENSIONS

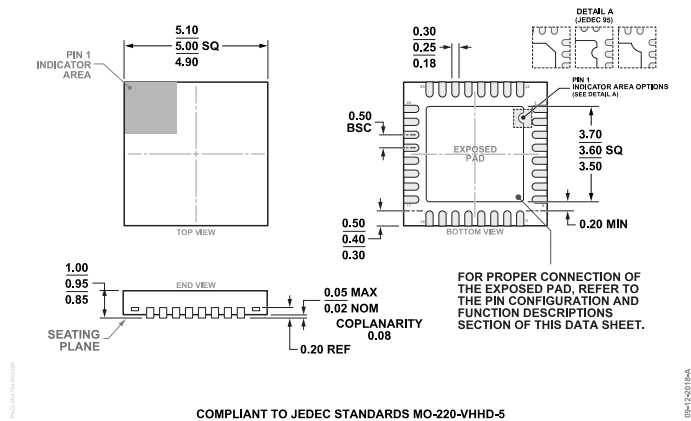

**Figure 95. 32-Lead Lead Frame Chip Package [LFCSP]
5 mm × 5 mm Body and 0.95 mm Package Height
(CP-32-30)**
Dimensions shown in millimeters

Updated: October 29, 2021

ORDERING GUIDE

Model ¹	Temperature Range	Package Description	Packing Quantity	Package Option
AD3552RBCPZ16	-40°C to +105°C	LFCSP:LEADFRM CHIP SCALE	Tray, 490	CP-32-30
AD3552RBCPZ16-RL7	-40°C to +105°C	LFCSP:LEADFRM CHIP SCALE	Reel, 1500	CP-32-30

¹ Z = RoHS Compliant Part.

EVALUATION BOARDS

Evaluation Board	Description
EVAL-AD3552RFMC1Z	AD3552R Evaluation Board optimized for Settling Time
EVAL-AD3552RFMC2Z	AD3552R Evaluation Board optimized for DC Accuracy
EVAL-SDP-CH1Z	SDP High Speed Controller Board