

Instrumentation Amplifier Common-Mode Range: The Diamond Plot

by Scott Hunt

INTRODUCTION

For operational amplifiers (op amps), determining the headroom limits is simple. The designer needs to consider only two limits: the input common-mode voltage range and the output voltage swing. However, determining the headroom limits for instrumentation amplifiers (in-amps) is more complex. The most common in-amp architectures combine two or three op amps, each with individual input and output ranges. Combined, these limits result in an operating range that depends on the common-mode voltage, the gain, and the voltage at the REF pin. In-amp data sheets feature headroom graphs to show the saturation boundaries, but these graphs represent data from the most common configurations only and still cause some confusion. This application note clarifies the major points of confusion associated with in-amp headroom graphs (also known as V_{CM} vs. V_{OUT} plots or diamond plots) and introduces an Analog Devices, Inc., web tool that dynamically calculates in-amp headroom limitations and greatly simplifies design with in-amps.

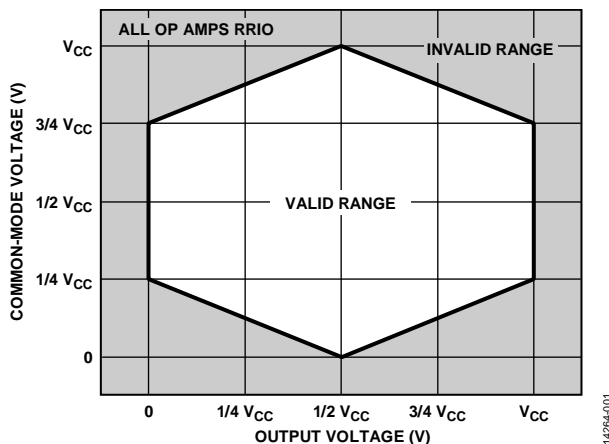

Figure 1. Diamond Plot of a Single-Supply 3-Op-Amp In-Amp Made from Rail-to-Rail Op Amps

IN-AMP BASICS

An in-amp is a closed-loop gain block. An op amp, on the other hand, is designed for a high open-loop gain. An op amp can be configured to perform many different functions when feedback is applied through various combinations of passive and active devices, whereas an in-amp simply multiplies the differential signal between its inputs by a fixed or programmed amount of gain and rejects any signals common to both inputs (the common-mode voltage). In-amps have two balanced, high impedance inputs to avoid loading the sensor or the signal source. In-amps are optimized

with low input-referred errors and a high common-mode rejection ratio to measure small signals in the presence of large common-mode voltages.

THE DIAMOND PLOT

Although in-amps appear agnostic to the input common-mode voltage, internally, they still must address this voltage. Common-mode voltages, especially as they approach the supplies, can cause the internal nodes to saturate when the external input and output voltages may otherwise be within range. The diamond plot represents this limitation by plotting the combination of every headroom limit, including the input range, the output range, and the internal nodes. The diamond plot is a boundary plot that shows the achievable output voltage (V_{OUT}) range for any given input common-mode voltage (V_{CM}), or equivalently, the input common-mode voltage range for which a given output voltage can be produced.

Although the diamond plots in the in-amp data sheets depict all of the input range, output swing, and internal headroom limits of the in-amp, circuit configuration parameters such as the supply voltages, the REF pin voltage (V_{REF}), and the gain also affect the diamond plot. For each op amp that makes up the in-amp, the input and output headroom limits scale relative to the supply voltage, meaning that changing the supply voltages expands or contracts the plot. In addition, the output voltage is related to the differential input voltage, gain, and V_{REF} according to the ideal in-amp transfer function:

$$V_{OUT} = Gain \times V_{IN_DIFF} + V_{REF}$$

where:

V_{IN_DIFF} is the differential input voltage, defined as $V_{+IN} - V_{-IN}$.
 V_{REF} is the voltage at the REF pin.

Because V_{REF} and gain both affect the output voltage and the output voltage is the x-axis variable, V_{REF} and gain can also affect the shape of the diamond plot. Traditionally, data sheets attempt to show these variations through a series of graphs that cover the most common configurations, and sometimes a set of published equations to describe the headroom limits.

To simplify the process of designing and debugging in-amp circuits, the [Instrumentation Amplifier Diamond Plot Tool](#) calculates the diamond plot limits of Analog Devices in-amps for any user configuration.

TABLE OF CONTENTS

Introduction	1	Combining the Signal Range with the Diamond Plot to Avoid Saturation	3
In-Amp Basics.....	1	Deconstructing the Diamond Plot.....	4
The Diamond Plot	1	The Analog Devices, Inc., Diamond Plot Tool.....	5
Revision History	2	Conclusion.....	7
How to Read a Diamond Plot	3		

REVISION HISTORY

10/2016—Revision 0: Initial Version

HOW TO READ A DIAMOND PLOT

Understanding how to use the diamond plot in a design is possible without going into detailed analysis. The aim is to ensure that the circuit operates within the valid range of the plot. When the circuit operates within the diamond plot, there is no saturation and the in-amp performs as intended. To ensure this, it is important to first understand the voltage range over which the circuit operates.

COMBINING THE SIGNAL RANGE WITH THE DIAMOND PLOT TO AVOID SATURATION

Every circuit has a signal operating voltage range, the range over which the common-mode and differential input voltages vary. This signal operating voltage range can be drawn directly on the diamond plot. If the operating range is entirely inside the diamond plot, the circuit does not have saturation issues. The operating range of a circuit can be as simple as a horizontal line of the desired output range at a given common-mode voltage. More likely, there is a range of common-mode voltages that must be accommodated, or rather, rejected, in the design. Graphically, this looks like a box from V_{CM_MIN} to V_{CM_MAX} and V_{OUT_MIN} to V_{OUT_MAX} . One final complication arises when the input voltage is single-ended (one input is at a fixed voltage,

DIFFERENTIAL

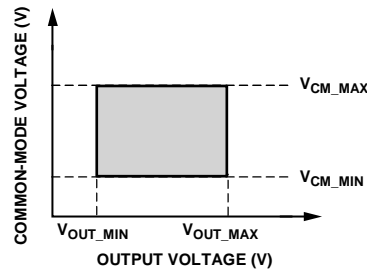
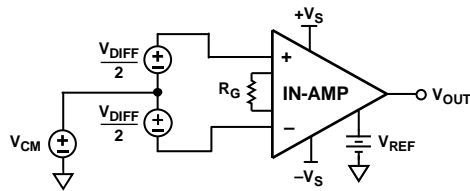

Figure 2. Differential Input Signal Condition and Its Graphical Representation

SINGLE-ENDED AT +IN

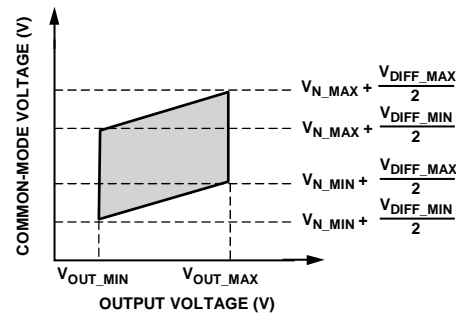
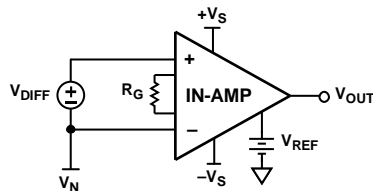

Figure 3. Single Ended at +IN Input Signal Condition and Its Graphical Representation

SINGLE-ENDED AT -IN

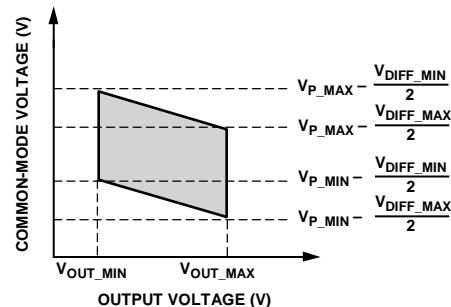
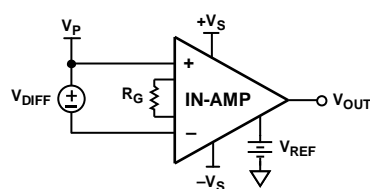

Figure 4. Single Ended at -IN Input Signal Condition and Its Graphical Representation

while the other input is varied), which causes the common-mode voltage to change with the input signal. The slope of this line in terms of V_{CM} vs. V_{OUT} is $\pm 1/(2G)$, and therefore, flattens out at high gains, but it can make a major difference at low gains. Figure 2 to Figure 4 show the three cases of the input signal conditions and their graphical representations.

Examples of when each of these conditions are applicable follow:

- A four-element varying bridge is a differential input example
- An isolated thermocouple measurement with the negative lead grounded is an input signal that is single-ended at +IN example
- A high-side current sensing on a positive rail is an input signal that is single-ended at -IN example

If it is not clear which method is right for a particular circuit, a differential input can be used universally as long as the maximum and minimum common-mode voltages are known. However, the resulting box may cover areas of the graph where the circuit never actually operates.

DECONSTRUCTING THE DIAMOND PLOT

The diamond plot represents a collection of individual headroom limits. Understanding where these limits come from and where they appear on the diamond plot yields insight into how to apply in-amps effectively.

First, consider the fundamental limits that all in-amps must observe: the input range and the output range. These limits are shown in Figure 5. When translated onto the V_{CM} vs. V_{OUT} axes used in the diamond plot, an output range limit appears as a vertical line at $V_{OUT} = V_{OUT,H}$ or $V_{OUT} = V_{OUT,L}$. In other words, V_{OUT} , which is the horizontal axis variable, must be greater than $V_{OUT,L}$ and less than $V_{OUT,H}$ in order to avoid saturation.

The input range is only slightly more difficult. If $V_{IN,DIFF}$ is set to 0 V, assuming that V_{REF} is within the output range, the output voltage becomes $V_{OUT} = V_{REF}$. Under these conditions, the maximum and minimum common-mode voltages that are still in range are at the specified input range limits, $V_{IN,H}$ and $V_{IN,L}$, respectively. To move the output voltage with the inputs sitting at one of those limits, one of the inputs must be moved away from the limit. When this move is done, the common-mode voltage (V_{CM}), which is defined as $(V_{+IN} + V_{-IN})/2$, changes by $\pm \Delta V_{OUT} \times 1/(2G)$, where G is the gain of the in-amp and the sign depends on which input was moved away from the limit. It is clear from the equation that the slope (m) is $\pm 1/2$ for a gain of 1. At higher gains, the slope decreases. Visually, the input range limit appears to be a horizontal line if the gain is higher than about 10.

The circuit designer generally takes the input range and the output range into account before referring to the diamond plot, so after recognizing these basic limits, the additional limits imposed by the in-amp architecture become apparent on the diamond plot. The ideal in-amp has only the limits shown in Figure 5 as well as a rail-to-rail input and a rail-to-rail output. Most in-amps have additional diamond plot limitations. In fact, the [AD8237](#), which uses a specialty indirect current feedback architecture, is one of the only in-amps in the industry that can match the ideal diamond plot in most configurations.

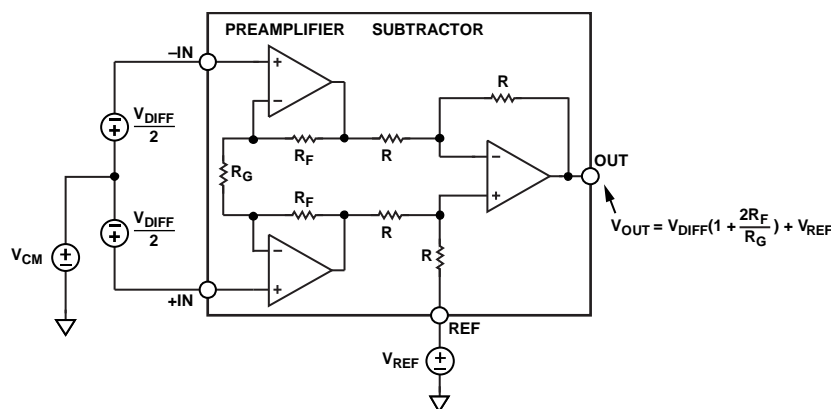

Figure 6. A Basic 3-Op-Amp In-Amp

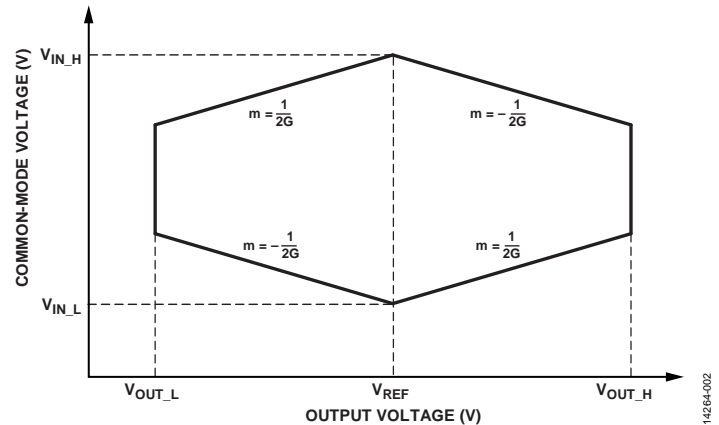

Figure 5. Diamond Plot Showing the Input Range and Output Range Limits Only

Most instrumentation amplifiers are based on the traditional 3-op-amp architecture shown in Figure 6, so it is worth looking at a 3-op-amp type in-amp to get an idea of an internal limitation. In the 3-op-amp in-amp, the gain is taken in the first stage, but the common-mode voltage is removed in the second stage. Because of this, the two outputs of the preamplifier stage are at $V_{CM} \pm G \times V_{IN,DIFF}/2$. Converting these limits back to the V_{CM} vs. V_{OUT} axes, the slope of the preamplifier output limitation is $\pm 1/(2 \times G_D)$, where G_D is the gain of the subtractor. G_D is typically 1, as in the circuit in Figure 6. This slope is independent of the preamp gain, so even though the input range flattens out at higher gains, this internal preamplifier output range limit does not.

The only other limit to consider is the input range of the subtractor op amp. The input of the subtractor op amp is at the center of a resistor divider between the positive preamplifier output and the REF pin. The REF pin is usually somewhere in the middle of the supply voltages; therefore, it tends to pull the input of the subtractor op amp toward the middle of the supplies as well. As a result, this limit typically does not affect the circuit at all unless V_{REF} and the positive preamplifier output are both very close to the same supply.

All of these limits can be taken together to explain the overall plot. Figure 7 shows the $G = 100$ plot from the AD8221 data sheet and labels which limit is shown by which line segment. The output range is the vertical line, the input range is nearly flat (a slope of $\pm 1/200$), and the preamp output range has a slope of $\pm 1/2$.

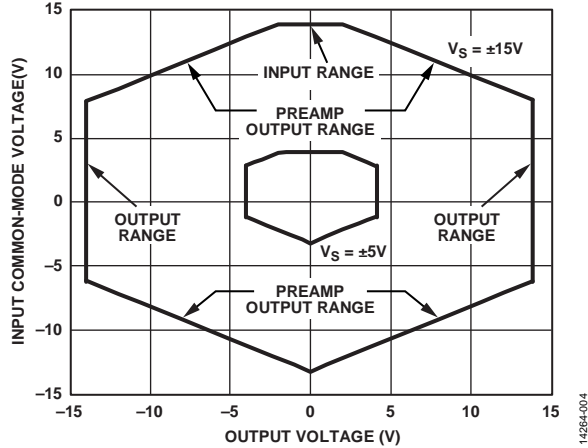

Figure 7. AD8221 Diamond Plot with Labels

THE ANALOG DEVICES, INC., DIAMOND PLOT TOOL

To simplify the process of generating and using diamond plots, Analog Devices developed an online Instrumentation Amplifier Diamond Plot tool (www.analog.com/designtools/en/diamond). This tool calculates diamond plots for Analog Devices instrumentation amplifiers based on the circuit conditions given by the user and detects whether the signal range is within the operating range of the in-amp (see Figure 8). The tool also checks for common errors such as gains or supply voltages that are out of range for the in-amp.

Figure 8. Screenshot of the Analog Devices Instrumentation Amplifier Diamond Plot Tool

To save time during the design process, the Instrumentation Amplifier Diamond Plot tool also generates a list of recommended in-amps that meet all of the circuit conditions and headroom requirements (see Figure 9). This list can be filtered parametrically in the tool itself by clicking **Filter this list by specifications** or the list can be viewed in the parametric search tables on

www.analog.com by clicking **View parametrics for recommended in-amps**. Filtering by specifications within the tool has the advantage of showing the specifications interpolated for the chosen gain, allowing a direct comparison that is more relevant to the design.

Recommended

Recommended in amps, based on settings specified in left panel

 [Filter this list by specifications](#)

Part	Description
AD8422	High Performance Low Power Rail-to-Rail output In-Amp
AD8421	High Performance Low Noise In-Amp
AD8420	Wide supply range, micropower, ICF In-Amp
AD8226	Wide Supply Rail-to-Rail output In-Amp
AD8227	Wide Supply Rail-to-Rail output In-Amp
AD8426	Dual Wide Supply Rail-to-Rail output In-Amp
AD8220	JFET input, Rail-to-Rail output In-Amp
AD8224	Dual JFET input, Rail-to-Rail output In-Amp
AD8253	Pin/Software Programmable Gain = 1, 10, 100, 1000 In-Amp
AD627	Wide supply range, micropower, 2 op amp In-Amp

View parametrics for [recommended in-amps](#) 

View parametrics for [all in-amps](#) 

Figure 9. Recommended In-Amps List Generated by the Diamond Plot Tool

CONCLUSION

A basic understanding of the diamond plot is essential to avoid unexpected saturation when designing with in-amps. Although the diamond plot can be very useful, it is dependent on the circuit configuration and therefore must be generated for the specific circuit conditions in the design. For new designs, it saves time to consider the diamond plot as the first criterion for in-amp

selection; however, it was difficult to narrow down the design choices this way in the past. With the Instrumentation Amplifier Diamond Plot tool, the headroom considerations can be evaluated quickly, and the designer can move on to performance considerations with confidence.