

Evaluating the AD8494 to AD8497 Series Thermocouple Amplifiers

FEATURES

J type or K type thermocouple (provided)

Low cost

Pretrimmed for J type or K type thermocouple

Internal cold junction compensation

Reference pin allows offset adjustment

EQUIPMENT NEEDED

±5 V dc power supply

GENERAL DESCRIPTION

This user guide is a description of functionality for the AD8494 series evaluation board. The evaluation board can be configured for the AD8494, AD8495, AD8496, and AD8497 to ensure that the metals and alloys are properly matched for the thermocouple type for which the device is trimmed. The 4-layer evaluation board (shown in Figure 1 and Figure 2 with different components) is designed to allow users to quickly prototype the precision thermocouple amplifiers for various user defined configurations for different applications. The evaluation board has three modes of operation: linear mode, setpoint controller mode, and hysteresis on setpoint controller mode.

The AD8494/AD8495/AD8496/AD8497 data sheet is available at www.analog.com. This data sheet provides additional information on the AD8494, AD8495, AD8496, and AD8497 and must be consulted in conjunction with this user guide when using the evaluation board.

EVALUATION BOARD PHOTOGRAPHS

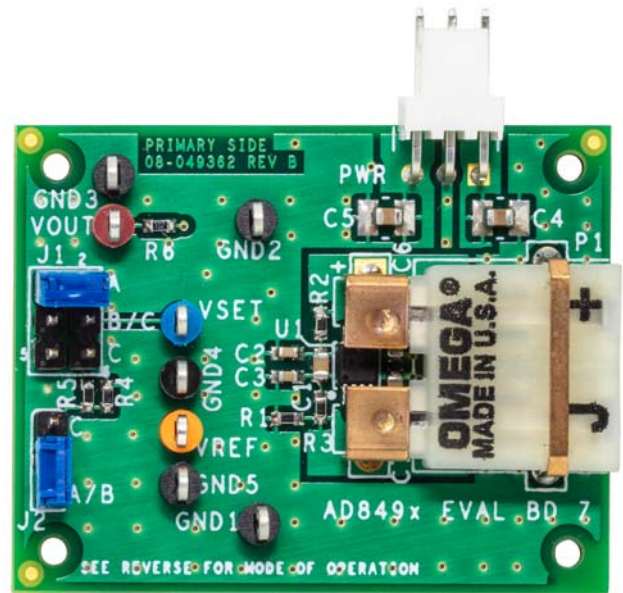

Figure 1. AD8494 Series Evaluation Board with J Type Female Thermocouple Connector for AD8494 and AD8496

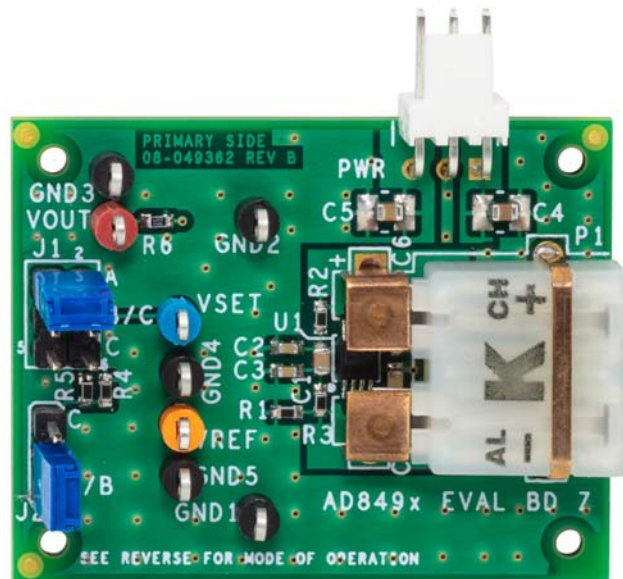

Figure 2. AD8494 Series Evaluation Board with K Type Female Thermocouple Connector for AD8495 and AD8497

TABLE OF CONTENTS

Features	1	Setup Procedure.....	3
Equipment Needed.....	1	Modes of Operation	3
General Description	1	Evaluation Board Schematic and Artwork.....	5
Evaluation Board Photographs	1	Ordering Information	8
Revision History	2	Bill of Materials.....	8
Quick Start.....	3		

REVISION HISTORY

11/2019—Revision 0: Initial Version

QUICK START

The AD8494 series evaluation board is shipped in linear mode by default, as shown in Figure 3. To configure the board in linear mode, ensure that the jumpers are set to the default values shown in Table 1.

Table 1. Linear Mode Settings (Default)

Label	Position	Setting
J1	A	Linear mode (SENSE shorted with V _{OUT} output voltage)
J2	A/B	Linear mode (V _{REF} is grounded)

SETUP PROCEDURE

Take the following steps to set up the AD8494 series evaluation board:

1. Plug the thermocouple into the thermocouple connector on the AD8494 series evaluation board.
2. Ensure that the jumper on J1 is set at Position A and that the jumper on J2 is set at Position A/B, as described in Table 1.
3. Connect the evaluation board PWR pins to ±5 V and ground.
4. The output signal with respect to the reference voltage (V_{REF}) is available at the V_{OUT} terminal on the evaluation board.

MODES OF OPERATION

Linear Mode

Linear mode is the default mode of operation set for the board. Figure 3 shows linear mode connections for the AD8494 series evaluation board using a J type or K type thermocouple input.

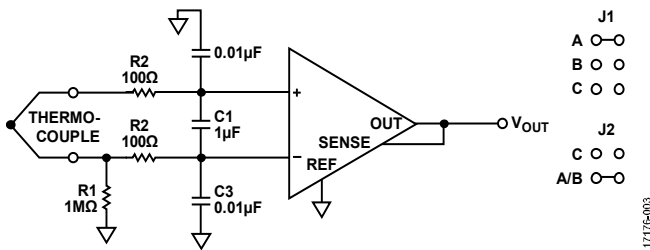

Figure 3. Linear Connection

The output voltage of the AD8494/AD8495/AD8496/AD8497 is calculated as follows:

$$V_{OUT} = (T_{MJ} \times 5 \text{ mV}/^{\circ}\text{C}) + V_{REF}$$

where T_{MJ} is the thermocouple measurement junction temperature.

If the linear connection is not working, disconnect the thermocouple and short both inputs to ground. If the system reads the ambient temperature correctly, the problem is related to the thermocouple. If the system does not read the ambient temperature correctly, the problem is either with the AD8494/AD8495/AD8496/AD8497 or with the downstream circuitry.

Setpoint Controller Mode

The AD8494 series evaluation board operates as a temperature setpoint controller when configured with either a thermocouple input from a remote location or with the AD8494/AD8495/AD8496/AD8497 being used as a temperature sensor (see Table 2 and Figure 4). When the measured temperature is below the setpoint temperature, the output voltage goes to $-V_s$. When the measured temperature is above the setpoint temperature, the output voltage goes to $+V_s$. For optimal accuracy and common-mode rejection ratio (CMRR) performance, the setpoint voltage must be created with a low impedance source. If the setpoint voltage is generated with a voltage divider, a buffer is recommended.

Table 2. Setpoint Controller Settings

Label	Position	Setting
J1	B	Setpoint control mode
J2	A/B	Setpoint control mode (V _{REF} is grounded)

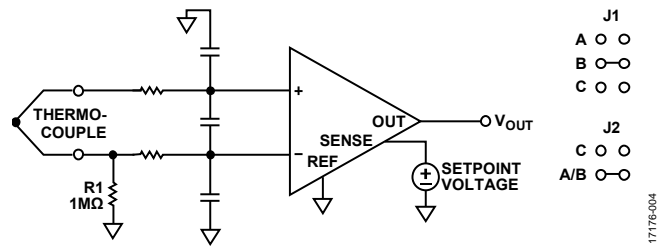

Figure 4. Setpoint Controller

Hysteresis on Setpoint Controller Mode

Hysteresis can be added to the setpoint controller by using a resistor divider from the output to the reference pin, as shown in Figure 5. The jumper positions must be updated to those in the Table 3. An additional jumper at J1 is required to make a total of three connections to maintain setpoint control and add hysteresis mode.

Table 3. Hysteresis on Setpoint Controller Settings

Label	Position	Setting
J1	B and C	Hysteresis on setpoint controller mode
J2	C	Hysteresis on setpoint controller mode

The hysteresis in $^{\circ}\text{C}$ is calculated as

$$T_{HYST} = \frac{V_s \times (R4 / (R4 + R5))}{5 \text{ mV}/^{\circ}\text{C}}$$

where:

T_{HYST} is the hysteresis temperature.

V_s is the supply voltage.

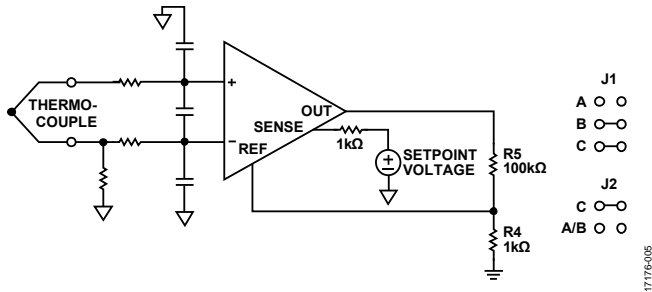

Figure 5. Adding 10°C of Hysteresis

The resistors installed on the evaluation board are 1 kΩ and 100 kΩ, which creates a window of approximately 10°C around the setpoint temperature for a +V_s of 5 V. A resistor equivalent to the output resistance of the divider must be connected to the SENSE pin to preserve the high performing CMRR.

Measuring Negative Temperatures

The AD8494 series evaluation board can measure negative temperatures using either single or dual supplies. When operating on dual supplies with the J2 jumper in A/B position

(reference pin grounded), a negative output voltage indicates a negative temperature at the thermocouple measurement junction.

When operating the AD8494 series evaluation board on a single supply level, apply a positive voltage (less than +V_s) on the reference pin to shift the output. The jumper from J2 must be removed so that the reference pin is not grounded. An output voltage less than V_{REF} indicates a negative temperature at the thermocouple measurement junction.

Reference Pin and Offset Adjustment

The VREF pin can be used to level shift the output voltage of the AD8494 series evaluation board. Level shifting the output voltage is useful when measuring negative temperatures on a single supply and when offsetting any initial calibration errors. Remove the jumper from J2 and apply a small reference voltage proportional to the error to nullify the effect of the calibration error on the output. The output voltage of the AD8494/AD8495/AD8496/AD8497 is calculated as follows:

$$V_{OUT} = (T_{MJ} \times 5 \text{ mV}/^\circ\text{C}) + V_{REF}$$

EVALUATION BOARD SCHEMATIC AND ARTWORK

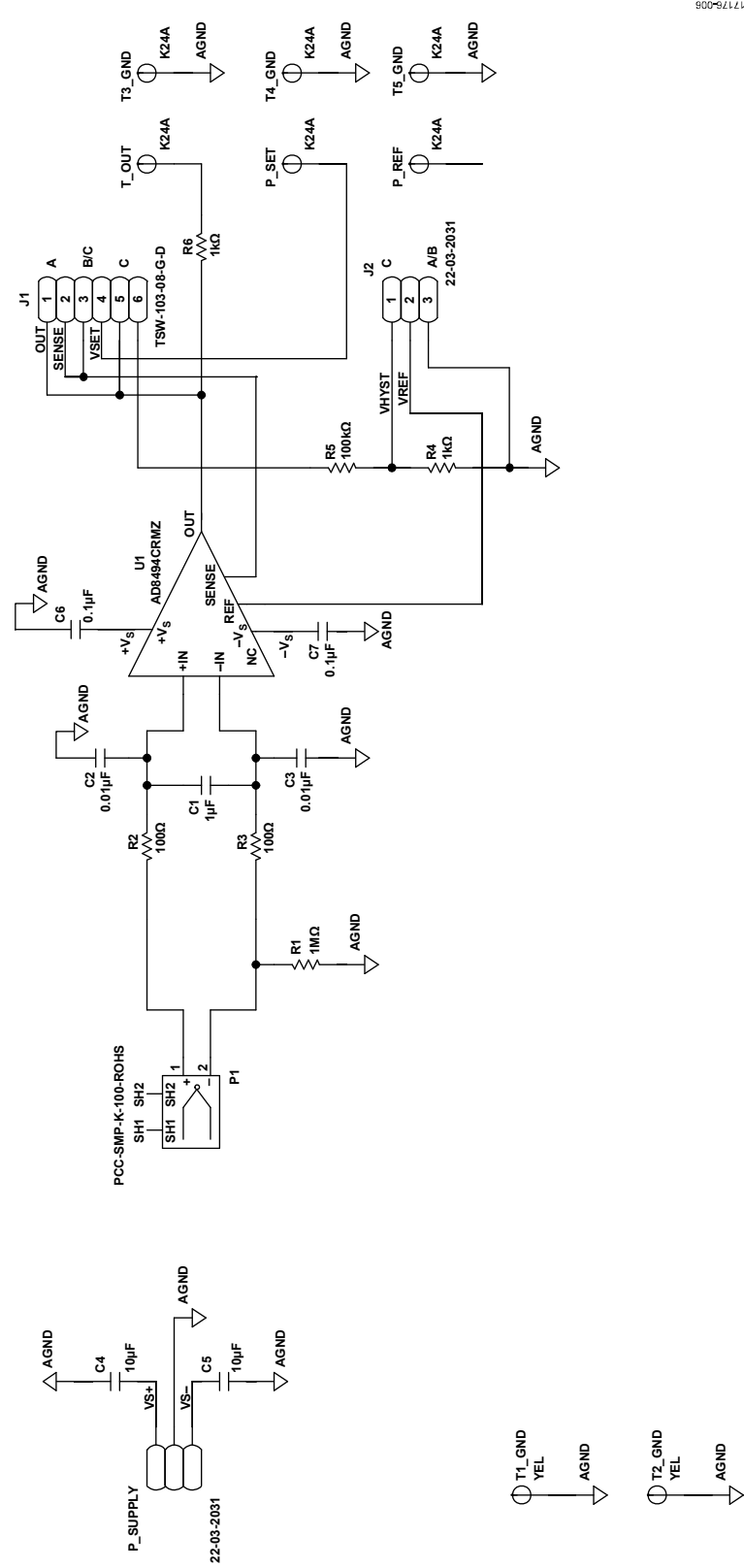

Figure 6. Evaluation Board Schematic, Device Under Test (DUT) Analog Input Circuits

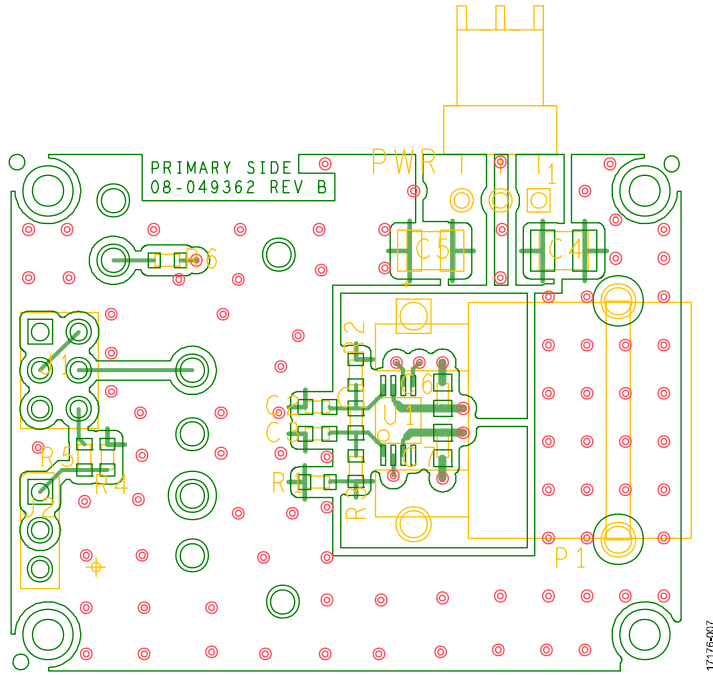

Figure 7. Evaluation Board Layout, Top Side

17715-007

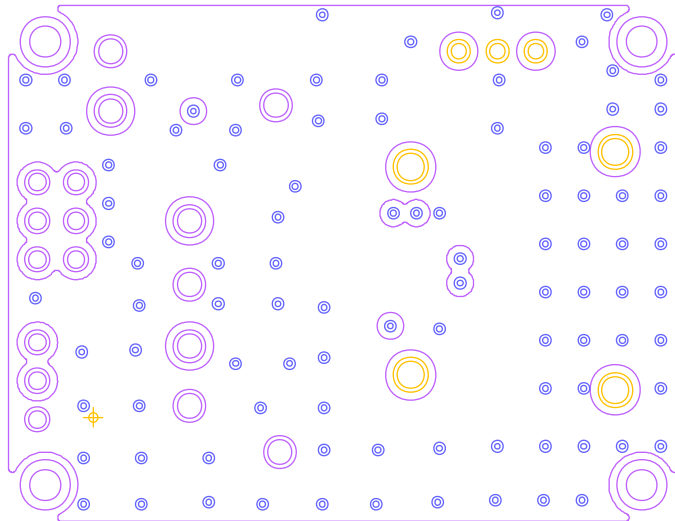

Figure 8. Evaluation Board Layout, Ground Plane (Layer 2)

17715-008

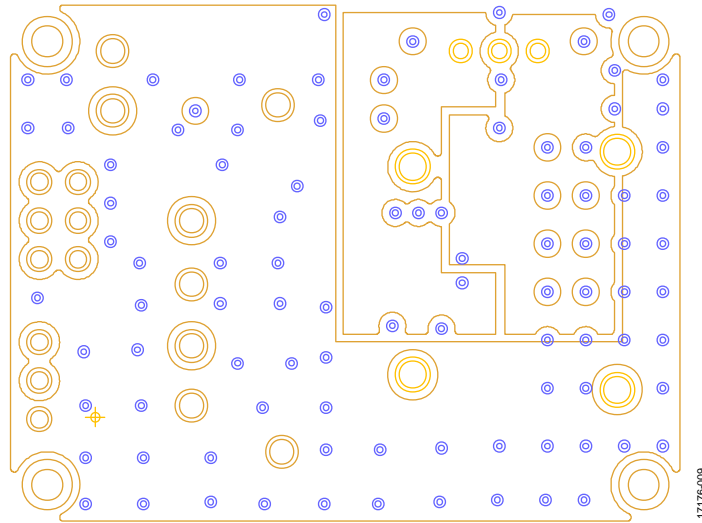

Figure 9. Evaluation Board Layout, Power Plane (Layer 3)

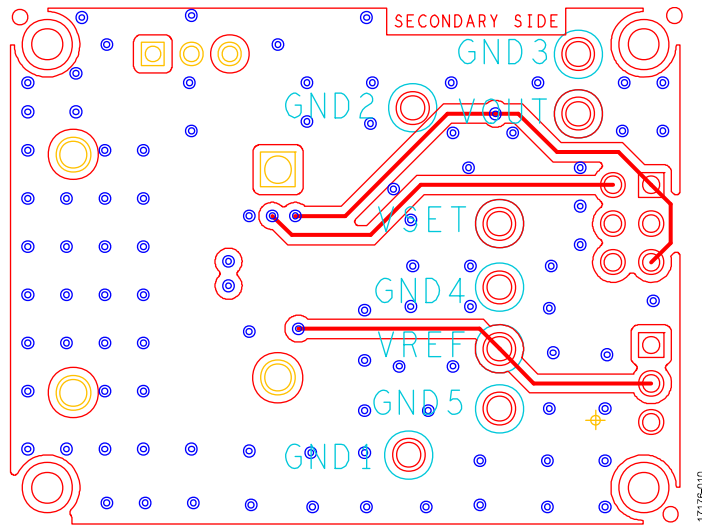

Figure 10. Evaluation Board Layout, Bottom Side

ORDERING INFORMATION

BILL OF MATERIALS

Table 4.

Reference Designator	Description	Value	Tolerance	Voltage	Manufacturer	Part Number
Not applicable	Printed circuit board (PCB)	Not applicable	Not applicable	Not applicable	Analog Devices, Inc. (supplied)	08_049362B
C1	Capacitor, ceramic X5R, general-purpose	1 μ F	10	16 V	Murata	GRM188R61C105KA93D
C2, C3	Capacitors, ceramic X7R, general-purpose	0.01 μ F	10	16 V	Murata	GRM188R71C103KA01D
C4, C5	Capacitors, ceramic X7R, for general use	10 μ F	10	63 V	Murata	GRM32ER71J106KA12L
C6, C7	Capacitors, ceramic broadband, X7R	0.1 μ F	20	25 V	Dielectric Labs	P62BN820MA2636
T1_GND, T2_GND, T3_GND, T4_GND, T5_GND	Connected PCB test point blocks	Block	Not applicable	Not applicable	Components Corporation	TP-104-01-00
J1	Connected PCB Berg header, double string male, 6-position	TSW-103-08-G-D	Not applicable	Not applicable	Samtec	TSW-103-08-G-D
J2	Connected PCB header, 2.54 mm, 3-position, vertical	22-03-2031	Not applicable	Not applicable	Molex	22-03-2031
P1	Connected PCB thermocouple, miniature size, calibration Type K and Type J, 1X M025043	PCC-SMP-K-100-RoHS, PCC-SMP-J-100-RoHS	Not applicable	Not applicable	Omega Engineering	PCC-SMP-K-100-RoHS, PCC-SMP-J-100-RoHS
PWR	Connected PCB header, right arm (RA) friction lock	22-12-2034	Not applicable	Not applicable	Molex	22-12-2034
R1	Resistor precision thick film chip, R0603	1 MB	1	Not applicable	Panasonic	ERJ-3EKF1004V
R2, R3	Resistor thin film chips, high reliability	100 Ω	0.1	Not applicable	Panasonic	ERA-3AEB101V
R4	Resistor chip, SMD, 0603	1 k Ω	0.05	Not applicable	Susumu Co., Ltd.	RG1608N-102-W-T1
R5	Resistor precision thick film chip	100 k Ω	1	50 V	Panasonic	ERJ-3EKF1003V
R6	Resistor metal film chip	1 k Ω	0.1	Not applicable	Panasonic	ERA-3AEB102V
U1	IC precision thermocouple amplifier with cold junction compensation	AD8494CRMZ , AD8495CRMZ , AD8496CRMZ , AD8497CRMZ	Not applicable	Not applicable	Analog Devices	AD8494CRMZ , AD8495CRMZ , AD8496CRMZ , AD8497CRMZ
VOUT	Connected PCB, test point red	Red	Not applicable	Not applicable	Components corporation	TP-104-01-02
VREF	Connected PCB, test point yellow	Yellow	Not applicable	Not applicable	Components corporation	TP-104-01-04
VSET	Connected PCB, test point blue	Blue	Not applicable	Not applicable	Components corporation	TP104-01-06
Not applicable	Mounting bracket for thermocouple connector, PCC-SMP	Not applicable	Not applicable	Not applicable	Omega Engineering	PCC-SMP-CLIP

NOTES

**ESD Caution**

ESD (electrostatic discharge) sensitive device. Charged devices and circuit boards can discharge without detection. Although this product features patented or proprietary protection circuitry, damage may occur on devices subjected to high energy ESD. Therefore, proper ESD precautions should be taken to avoid performance degradation or loss of functionality.

Legal Terms and Conditions

By using the evaluation board discussed herein (together with any tools, components documentation or support materials, the "Evaluation Board"), you are agreeing to be bound by the terms and conditions set forth below ("Agreement") unless you have purchased the Evaluation Board, in which case the Analog Devices Standard Terms and Conditions of Sale shall govern. Do not use the Evaluation Board until you have read and agreed to the Agreement. Your use of the Evaluation Board shall signify your acceptance of the Agreement. This Agreement is made by and between you ("Customer") and Analog Devices, Inc. ("ADI"), with its principal place of business at One Technology Way, Norwood, MA 02062, USA. Subject to the terms and conditions of the Agreement, ADI hereby grants to Customer a free, limited, personal, temporary, non-exclusive, non-sublicensable, non-transferable license to use the Evaluation Board FOR EVALUATION PURPOSES ONLY. Customer understands and agrees that the Evaluation Board is provided for the sole and exclusive purpose referenced above, and agrees not to use the Evaluation Board for any other purpose. Furthermore, the license granted is expressly made subject to the following additional limitations: Customer shall not (i) rent, lease, display, sell, transfer, assign, sublicense, or distribute the Evaluation Board; and (ii) permit any Third Party to access the Evaluation Board. As used herein, the term "Third Party" includes any entity other than ADI, Customer, their employees, affiliates and in-house consultants. The Evaluation Board is NOT sold to Customer; all rights not expressly granted herein, including ownership of the Evaluation Board, are reserved by ADI. CONFIDENTIALITY. This Agreement and the Evaluation Board shall all be considered the confidential and proprietary information of ADI. Customer may not disclose or transfer any portion of the Evaluation Board to any other party for any reason. Upon discontinuation of use of the Evaluation Board or termination of this Agreement, Customer agrees to promptly return the Evaluation Board to ADI. ADDITIONAL RESTRICTIONS. Customer may not disassemble, decompile or reverse engineer chips on the Evaluation Board. Customer shall inform ADI of any occurred damages or any modifications or alterations it makes to the Evaluation Board, including but not limited to soldering or any other activity that affects the material content of the Evaluation Board. Modifications to the Evaluation Board must comply with applicable law, including but not limited to the RoHS Directive. TERMINATION. ADI may terminate this Agreement at any time upon giving written notice to Customer. Customer agrees to return to ADI the Evaluation Board at that time. LIMITATION OF LIABILITY. THE EVALUATION BOARD PROVIDED HEREUNDER IS PROVIDED "AS IS" AND ADI MAKES NO WARRANTIES OR REPRESENTATIONS OF ANY KIND WITH RESPECT TO IT. ADI SPECIFICALLY DISCLAIMS ANY REPRESENTATIONS, ENDORSEMENTS, GUARANTEES, OR WARRANTIES, EXPRESS OR IMPLIED, RELATED TO THE EVALUATION BOARD INCLUDING, BUT NOT LIMITED TO, THE IMPLIED WARRANTY OF MERCHANTABILITY, TITLE, FITNESS FOR A PARTICULAR PURPOSE OR NON-INFRINGEMENT OF INTELLECTUAL PROPERTY RIGHTS. IN NO EVENT WILL ADI AND ITS LICENSORS BE LIABLE FOR ANY INCIDENTAL, SPECIAL, INDIRECT, OR CONSEQUENTIAL DAMAGES RESULTING FROM CUSTOMER'S POSSESSION OR USE OF THE EVALUATION BOARD, INCLUDING BUT NOT LIMITED TO LOST PROFITS, DELAY COSTS, LABOR COSTS OR LOSS OF GOODWILL. ADI'S TOTAL LIABILITY FROM ANY AND ALL CAUSES SHALL BE LIMITED TO THE AMOUNT OF ONE HUNDRED US DOLLARS (\$100.00). EXPORT. Customer agrees that it will not directly or indirectly export the Evaluation Board to another country, and that it will comply with all applicable United States federal laws and regulations relating to exports. GOVERNING LAW. This Agreement shall be governed by and construed in accordance with the substantive laws of the Commonwealth of Massachusetts (excluding conflict of law rules). Any legal action regarding this Agreement will be heard in the state or federal courts having jurisdiction in Suffolk County, Massachusetts, and Customer hereby submits to the personal jurisdiction and venue of such courts. The United Nations Convention on Contracts for the International Sale of Goods shall not apply to this Agreement and is expressly disclaimed.