

## 12-Bit, 10.25 GSPS, JESD204B, RF Analog-to-Digital Converter

### FEATURES

- ▶ Low power dissipation: <4.6 W typical at 10 GSPS
- ▶ Integrated input buffer (6.5 GHz input bandwidth)
  - ▶ 1.4 V p-p full-scale analog input with  $R_{IN} = 50 \Omega$
  - ▶ Overvoltage protection
- ▶ High instantaneous dynamic range
- ▶ NSD
  - ▶ -155.1 dBFS/Hz at 10 GSPS with -9 dBFS, 170 MHz input
  - ▶ -153 dBFS/Hz at 10 GSPS with -1 dBFS, 170 MHz input
- ▶ SFDR: 70 dBFS at 10 GSPS with -1 dBFS, 1000 MHz input
- ▶ SFDR excluding H2 and H3 (worst other spur): -89 dBFS at 10 GSPS with -1 dBFS, 1000 MHz input
- ▶ 16-lane JESD204B output (up to 16 Gbps line rate)
- ▶ Multichip synchronization capable with 1 sample accuracy
  - ▶ DDC NCO synchronization included
- ▶ Integrated DDC
  - ▶ Selectable decimation factors
  - ▶ 16 profile settings for fast frequency hopping
- ▶ Fast overrange detection for efficient AGC
- ▶ On-chip temperature sensor
- ▶ On-chip negative voltage generators
- ▶ Low CER:  $<1 \times 10^{-16}$
- ▶ 12 mm × 12 mm, 192-ball BGA-ED package

### COMMERCIAL SPACE FEATURES

- ▶ Supports aerospace applications
- ▶ Burn-in, life test, and deltas analysis
- ▶ Radiation lot acceptance test
  - ▶ Total ionizing dose
- ▶ Radiation benchmark
  - ▶ Single event latch-up
  - ▶ Single event transient
- ▶ Certificate of conformance

### APPLICATIONS

- ▶ Ultrawideband satellite receiver
- ▶ Low earth orbit (LEO) satellites
- ▶ Avionics

### GENERAL DESCRIPTION

The AD9213S-CSH is a single, 12-bit, 10.25 GSPS, RF analog-to-digital converter (ADC) with a 6.5 GHz input bandwidth. The AD9213S-CSH supports high dynamic range frequency and time domain applications requiring wide instantaneous bandwidth and low conversion error rates (CERs). The AD9213S-CSH features a 16-lane JESD204B interface to support maximum bandwidth capability.

The AD9213S-CSH achieves dynamic range and linearity performance while consuming <4.6 W typical. The device is based on an interleaved pipeline architecture and features a proprietary calibration and randomization technique that suppresses interleaving spurious artifacts into its noise floor. The linearity performance of the AD9213S-CSH is preserved by a combination of on-chip dithering and calibration, which results in excellent spurious-free performance over a wide range of input signal conditions.

Applications that require less instantaneous bandwidth can benefit from the on-chip, digital signal processing (DSP) capability of the AD9213S-CSH that reduces the output data rate along with the number of JESD204B lanes required to support the device. The DSP path includes a digital downconverter (DDC) with a 48-bit, numerically controlled oscillator (NCO), followed by an in-phase/quadrature (I/Q) digital decimator stage that allows selectable decimation rates that are factors of two or three. For fast frequency hopping applications, the AD9213S-CSH NCO supports up to 16 profile settings with a separate trigger input, allowing wide surveillance frequency coverage at a reduced JESD204B lane count.

The AD9213S-CSH supports sample accurate multichip synchronization that includes synchronization of the NCOs. The AD9213S-CSH is offered in a 12 mm × 12 mm, 192-ball ball grid array (BGA) package and is specified over a junction temperature range of -20°C to +115°C. Additional application and technical information can be found in the [Commercial Space Products Program](#) brochure and the [AD9213](#) data sheet.

**TABLE OF CONTENTS**

Features.....	1	Radiation Test and Limit Specifications.....	9
Commercial Space Features.....	1	Absolute Maximum Ratings.....	12
Applications.....	1	Thermal Characteristics.....	12
General Description.....	1	Explanation of Test Levels.....	12
Functional Block Diagram.....	3	Outgas Testing.....	12
Specifications.....	4	ESD Caution.....	12
AC Specifications.....	6	Pin Configuration and Function Descriptions.....	13
Digital Specifications.....	7	Typical Performance Characteristics.....	16
Switching Specifications.....	8	Outline Dimensions.....	23
Life Test and Burn-In Delta Specifications.....	9	Ordering Guide.....	23

**REVISION HISTORY****1/2022—Revision 0: Initial Version**

FUNCTIONAL BLOCK DIAGRAM

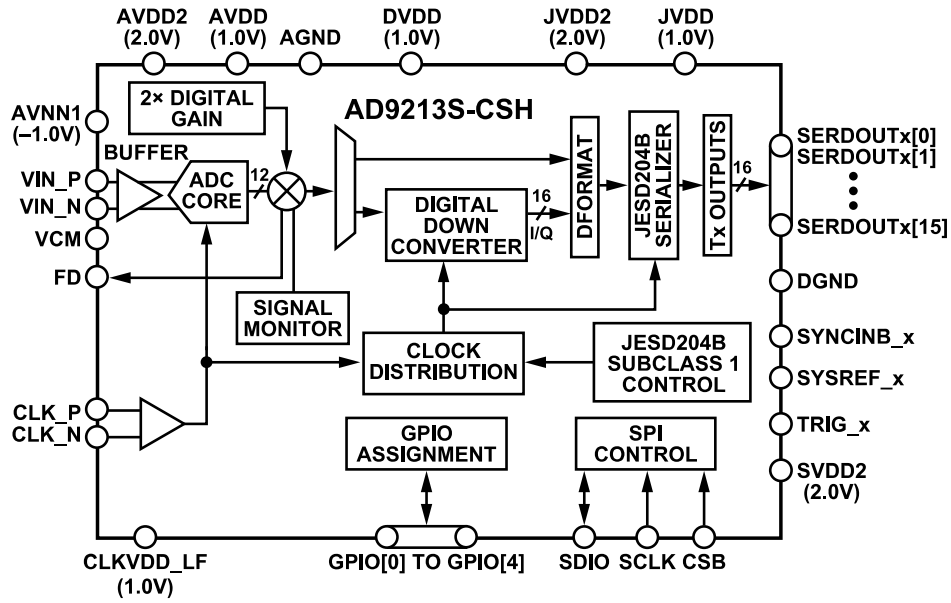

Figure 1.

001

## SPECIFICATIONS

Nominal supply voltages, specified maximum sampling rate, internal reference, and analog input ( $A_{IN}$ ) = -1.0 dBFS. Minimum and maximum specifications represent performance at  $-20^{\circ}\text{C} \leq T_J \leq +115^{\circ}\text{C}$ , unless otherwise noted. Typical specifications represent performance at  $T_J = 70^{\circ}\text{C}$ .

Table 1.

Parameter	Test Level	Temperature ( $T_J$ )	Min	Typ	Max	Unit
RESOLUTION	II	Full	12			Bits
ACCURACY						
No Missing Codes	II	Full	Guaranteed			
Offset Error	I	70°C	-2.0	0	+0.7	LSB
	I	Full	-11		+11	LSB
Gain Error	I	70°C	0.1	7.4	12.7	%FSR
	I	Full	-7.0		+17.0	%FSR
Differential Nonlinearity (DNL)	I	70°C	-0.4	±0.3	+0.5	LSB
	I	Full	-0.5		+0.6	LSB
Integral Nonlinearity (INL)	I	70°C	-4.2	±2.4	+2.3	LSB
	I	Full	-8.2		+6.2	LSB
ANALOG INPUTS						
Differential Input Voltage Range (Internal $V_{REF} = 0.5\text{ V}$ )	III	70°C		1.4		V p-p
Resistance ( $R_{IN}$ )	I	70°C	48.0	50.0	51.8	$\Omega$
	I	Full	47.8		52.2	$\Omega$
Capacitance	III	70°C		1		pF
Internal Common-Mode Voltage ( $V_{CM}$ )	I	Full	0.45	0.5	0.5	V
Analog Full Power Bandwidth (Internal Termination)	III	70°C		6.5		GHz
Input Referred Noise	III	70°C		1.72		LSB <sub>RMS</sub>
POWER SUPPLIES						
BVDD2	II	Full	1.95	2.0	2.05	V
BVNN1	II	Full	-1.025	-1.0	-0.975	V
AVNN1	II	Full	-1.025	-1.0	-0.975	V
BVNN2 (Internally Generated)	II	Full	-2.05	-2.0	-1.95	V
BVDD3 (Internally Generated)	II	Full	2.925	3.0	3.075	V
AVDD	II	Full	0.975	1.0	1.025	V
CLKVDD_LF	II	Full	0.975	1.0	1.025	V
PLLVDD2	II	Full	1.95	2.0	2.05	V
AVDDFS8	II	Full	0.975	1.0	1.025	V
FVDD	II	Full	0.975	1.0	1.025	V
VDD_NVG	II	Full	0.975	1.0	1.025	V
RVDD2	II	Full	1.95	2.0	2.05	V
SVDD2	II	Full	1.75	2.0	2.05	V
JVDD2	II	Full	1.95	2.0	2.05	V
DVDD	II	Full	0.975	1.0	1.025	V
JVTT	II	Full	0.975	1.0	1.025	V
JVDD	II	Full	0.975	1.0	1.025	V
TMU_AVDD2	II	Full	1.95	2.0	2.05	V
TMU_DVDD1	II	Full	0.975	1.0	1.025	V
Dynamic Supply Currents						
$I_{BVDD2}$	I	Full		112	147	mA
$I_{BVNN1}$	I	Full		-116	-151	mA
$I_{AVNN1}$	I	Full		-1.8	-2	mA
$I_{BVNN2}^1$		Full	N/A <sup>2</sup>	N/A <sup>2</sup>	N/A <sup>2</sup>	mA
$I_{BVDD3}^1$		Full	N/A <sup>2</sup>	N/A <sup>2</sup>	N/A <sup>2</sup>	mA

## SPECIFICATIONS

Table 1.

Parameter	Test Level	Temperature (T <sub>J</sub> )	Min	Typ	Max	Unit
I <sub>AVDD</sub>	I	Full		2180	2790	mA
I <sub>CLKVDD_LF</sub>	I	Full		31	37	mA
I <sub>PLLVDD2</sub>	I	Full		1	2	mA
I <sub>AVDDFS8</sub>	I	Full		38	56	mA
I <sub>FVDD</sub>	I	Full		31	35	mA
I <sub>VDD_NVG</sub> <sup>3</sup>	I	Full		159	195	mA
I <sub>VDD_NVG</sub> <sup>4</sup>	I	Full		387	478	mA
I <sub>RVDD2</sub>	I	Full		35	38	mA
I <sub>SVDD2</sub>	I	Full		0.3	1	mA
I <sub>JVDD2</sub>	I	Full		21	24	mA
I <sub>DVDD</sub> <sup>5</sup>	I	Full		643	1055	mA
I <sub>JVTT</sub>	I	Full		173	247	mA
I <sub>JVDD</sub>	I	Full		611	800	mA
I <sub>TMU_AVDD2</sub>	I	Full		1.7	2	mA
I <sub>TMU_DVDD1</sub>	I	Full		1	2	mA
Power-Down Supply Currents						
I <sub>BVDD2</sub>	I	Full		0.5	0.9	mA
I <sub>BVNN1</sub>	I	Full		-11	-9	mA
I <sub>AVNN1</sub>	I	Full		-0.15	-0.10	mA
I <sub>BVNN2</sub> <sup>1</sup>	I	Full	N/A <sup>2</sup>	N/A <sup>2</sup>	N/A <sup>2</sup>	mA
I <sub>BVDD3</sub> <sup>1</sup>	I	Full	N/A <sup>2</sup>	N/A <sup>2</sup>	N/A <sup>2</sup>	mA
I <sub>AVDD</sub>	I	Full		137	410	mA
I <sub>CLKVDD_LF</sub>	I	Full		1.1	3	mA
I <sub>PLLVDD2</sub>	I	Full		1	1.24	mA
I <sub>AVDDFS8</sub>	I	Full		3.5	14.5	mA
I <sub>FVDD</sub>	I	Full		1.5	5.3	mA
I <sub>VDD_NVG</sub> <sup>3</sup>	I	Full		0.8	2.8	mA
I <sub>RVDD2</sub>	I	Full		0.65	0.82	mA
I <sub>SVDD2</sub>	I	Full		0.23	0.4	mA
I <sub>JVDD2</sub>	I	Full		0.2	0.4	mA
I <sub>DVDD</sub> <sup>5</sup>	I	Full		60	240	mA
I <sub>JVTT</sub>	I	Full		20.8	85.7	mA
I <sub>JVDD</sub>	I	Full		60	180	mA
I <sub>TMU_AVDD2</sub>	I	Full		1.7	2	mA
I <sub>TMU_DVDD1</sub>	I	Full		0.25	0.7	mA
Power Consumption <sup>6</sup>						
Total Power Dissipation (Including Output Drivers) <sup>7</sup>	I	Full		4.44	5.93	W
Power-Down	I	Full		114	970	mW
Standby	I	Full		2.7	5	W

<sup>1</sup> Internally supplied.

<sup>2</sup> N/A means not applicable.

<sup>3</sup> Current when AVNN1 and BVNN1 are supplied by an external source.

<sup>4</sup> Current when AVNN1 and BVNN1 are supplied by VNEG\_OUT.

<sup>5</sup> DDC off.

<sup>6</sup> Power with optional DDC off. Power and supply currents are typical unless otherwise noted.

<sup>7</sup> Total power when AVNN1 and BVNN1 are supplied by VNEG\_OUT.

## SPECIFICATIONS

## AC SPECIFICATIONS

Nominal supply voltages, specified maximum sampling rate, internal reference, and  $A_{IN} = -1.0$  dBFS. Minimum and maximum specifications represent performance at  $-20^{\circ}\text{C} \leq T_J \leq +115^{\circ}\text{C}$ , unless otherwise noted. Typical specifications represent performance at  $T_J = 70^{\circ}\text{C}$ .

Table 2.

Parameter	Test Level	Temperature ( $T_J$ )	Min	Typ	Max	Unit
NOISE SPECTRAL DENSITY (NSD)						
At 170 MHz, -1 dBFS	III	70°C		-153		dBFS/Hz
At 170 MHz, -9 dBFS	III	70°C		-155.1		dBFS/Hz
At 170 MHz, -30 dBFS	III	70°C		-155.7		dBFS/Hz
SIGNAL-TO-NOISE RATIO (SNR)						
Input Frequency ( $f_{IN}$ ) = 170 MHz	I	70°C	50.2	55.9		dBFS
	I	Full	45.4			dBFS
$f_{IN} = 1000$ MHz	III	70°C		55.8		dBFS
$f_{IN} = 2600$ MHz	I	70°C	44.1	51.0		dBFS
	I	Full	43.8			dBFS
$f_{IN} = 4000$ MHz	III	70°C		49.9		dBFS
SIGNAL-TO-NOISE AND DISTORTION (SINAD)						
$f_{IN} = 170$ MHz	I	70°C	49.1	55.6		dBFS
	I	Full	46			dBFS
$f_{IN} = 1000$ MHz	III	70°C		55.6		dBFS
$f_{IN} = 2600$ MHz	I	70°C	43	50.8		dBFS
	I	Full	42.7			dBFS
$f_{IN} = 4000$ MHz	III	70°C		49.4		dBFS
EFFECTIVE NUMBER OF BITS (ENOB)						
$f_{IN} = 170$ MHz	I	70°C	7.86	8.9		Bits
	I	Full	7.35			Bits
$f_{IN} = 1000$ MHz	III	70°C		8.9		Bits
$f_{IN} = 2600$ MHz	I	70°C	6.85	8.1		Bits
	I	Full	6.8			Bits
$f_{IN} = 4000$ MHz	III	70°C		7.9		Bits
SPURIOUS-FREE DYNAMIC RANGE (SFDR), SECOND OR THIRD HARMONIC						
$f_{IN} = 170$ MHz	I	70°C	64.44	70		dBFS
	I	Full	57.3			dBFS
$f_{IN} = 1000$ MHz	III	70°C		70		dBFS
$f_{IN} = 2600$ MHz	I	70°C	61.9	65		dBFS
	I	Full	62			dBFS
$f_{IN} = 4000$ MHz	III	70°C		60		dBFS
SECOND HARMONIC (H2)						
$f_{IN} = 170$ MHz	I	70°C		-71	-68.4	dBFS
	I	Full			-63	dBFS
$f_{IN} = 1000$ MHz	III	70°C		-77		dBFS
$f_{IN} = 2600$ MHz	I	70°C		-65	-62	dBFS
	I	Full			-62	dBFS
$f_{IN} = 4000$ MHz	III	70°C		-60		dBFS

## SPECIFICATIONS

Table 2.

Parameter	Test Level	Temperature (T <sub>J</sub> )	Min	Typ	Max	Unit	
THIRD HARMONIC (H3) f <sub>IN</sub> = 170 MHz	I	70°C		-70	-64.4	dBFS	
	I	Full			-58	dBFS	
	f <sub>IN</sub> = 1000 MHz	III	70°C		-70		dBFS
		I	70°C		-72	-65	dBFS
	f <sub>IN</sub> = 2600 MHz	I	Full			-65	dBFS
		III	70°C		-74		dBFS
WORST OTHER (WO), EXCLUDING SECOND OR THIRD HARMONIC ( WO  = SFDR EXCLUDING H2 OR H3) f <sub>IN</sub> = 170 MHz	I	70°C		-88	-82	dBFS	
	I	Full			-68	dBFS	
	f <sub>IN</sub> = 1000 MHz	III	70°C		-89		dBFS
	f <sub>IN</sub> = 2600 MHz	I	70°C		-89	-76	dBFS
		I	Full			-72	dBFS
	f <sub>IN</sub> = 4000 MHz	III	70°C		-86		dBFS
TWO-TONE INTERMODULATION DISTORTION (IMD3, 2f <sub>IN1</sub> - f <sub>IN2</sub> ) f <sub>IN1</sub> AND f <sub>IN2</sub> = -7.0 dBFS f <sub>IN1</sub> = 1842 MHz, f <sub>IN2</sub> = 1847 MHz f <sub>IN1</sub> = 2138 MHz, f <sub>IN2</sub> = 2143 MHz	III	70°C		-77		dBFS	
	III	70°C		-76		dBFS	
TWO-TONE INTERMODULATION DISTORTION (IMD3, 2f <sub>IN1</sub> - f <sub>IN2</sub> ) f <sub>IN1</sub> AND f <sub>IN2</sub> = -15.0 dBFS f <sub>IN1</sub> = 1842 MHz, f <sub>IN2</sub> = 1847 MHz f <sub>IN1</sub> = 2138 MHz, f <sub>IN2</sub> = 2143 MHz	III	70°C		-99		dBFS	
	III	70°C		-101		dBFS	

## DIGITAL SPECIFICATIONS

Nominal supply voltages, specified maximum sampling rate, internal reference, and A<sub>IN</sub> = -1.0 dBFS. Minimum and maximum specifications represent performance at -20°C ≤ T<sub>J</sub> ≤ +115°C, unless otherwise noted. Typical specifications represent performance at T<sub>J</sub> = 70°C.

Table 3.

Parameter	Min	Typ	Max	Unit
CLOCK INPUTS (CLK_P, CLK_N)				
Logic Compliance		Low voltage positive emitter coupled logic (LVPECL)		
Differential Input Voltage	300	800	1800	mV p-p
Common-Mode Input Voltage		0.675		V
Input Resistance (Differential)		106		Ω
Input Capacitance		0.9		pF
SYSREF_x INPUTS				
Logic Compliance		Low voltage differential signaling (LVDS)		
Differential Input Voltage	500	700	800	mV p-p
Common-Mode Input Voltage		1.2		V
Input Resistance (Differential)		100		Ω
Input Capacitance		0.5		pF
LOGIC INPUTS (SDIO, SCLK, CSB, GPIO, PWDN)				
Logic Compliance		CMOS		
Voltage				
Logic 1	0.70 × SVDD2			V
Logic 0	0		0.30 × SVDD2	V
Input Resistance (Single-Ended)		44		kΩ

## SPECIFICATIONS

Table 3.

Parameter	Min	Typ	Max	Unit
<b>SYNCINB_x INPUT</b>				
Logic Compliance		LVDS		
Input Voltage				
Differential	400	800	1800	mV p-p
Common Mode		0.675	2.0	V
Input Resistance (Differential)		18		k $\Omega$
Input Capacitance		1		pF
<b>LOGIC OUTPUT (SDIO, GPIO, FD)</b>				
Logic Compliance		CMOS		
Voltage				
Logic 1, Output Logic Current High ( $I_{OH}$ ) = 4 mA	SVDD2 - 0.45			V
Logic 0, Output Logic Current Low ( $I_{OL}$ ) = 4 mA	0		0.45	V
<b>RESET (RSTB) INPUT</b>				
Logic Compliance		CMOS		
Voltage				
Logic 1	$0.70 \times SVDD2$			V
Logic 0	0		$0.30 \times SVDD2$	V
Input Resistance		77		k $\Omega$

## SWITCHING SPECIFICATIONS

Nominal supply voltages, specified maximum sampling rate, internal reference, and  $A_{IN} = -1.0$  dBFS. Minimum and maximum specifications represent performance at  $-20^{\circ}\text{C} \leq T_J \leq +115^{\circ}\text{C}$ , unless otherwise noted. Typical specifications represent performance at  $T_J = 70^{\circ}\text{C}$ .

Table 4.

Parameter	Test Level	Temperature ( $T_J$ )	Min	Typ	Max	Unit
<b>CLOCK (CLK)</b>						
Maximum Clock Rate	III	Full			10.25	GSPS
Minimum Clock Rate	III	Full	2.5			GSPS
Clock Duty Cycle	II	Full	45	50	55	% duty cycle
<b>LATENCY</b>						
Pipeline Latency	III	$70^{\circ}\text{C}$		367		Clock cycles
Fast Detect (FD) Latency	III	$70^{\circ}\text{C}$		170		Clock cycles
<b>OUTPUT PARAMETERS (SERDOUT_x[x], x = 0 to 15)</b>						
Logic Compliance	II	Full		JESD204B		
Differential Output Voltage	II	Full	560	770		mV p-p
Differential Termination Impedance	II	Full	100	120		$\Omega$
Unit Interval (UI) <sup>1</sup>	II	Full	62.5	80	588.2	ps
Rise Time ( $t_R$ ) (20% to 80% into 100 $\Omega$ Load)	III	$70^{\circ}\text{C}$		26		ps
Fall Time ( $t_F$ ) (20% to 80% into 100 $\Omega$ Load)	III	$70^{\circ}\text{C}$		26		ps
Phase-Locked Loop (PLL) Lock Time	III	$70^{\circ}\text{C}$		5		ms
Lane Rate (Nonreturn to Zero) <sup>2</sup>	II	Full	1.7	12.5	16	Gbps
<b>WAKE-UP TIME</b>						
Standby	III	$70^{\circ}\text{C}$		1		ms
Power-Down	III	$70^{\circ}\text{C}$		25		ms



## SPECIFICATIONS

Table 4.

Parameter	Test Level	Temperature (T <sub>J</sub> )	Min	Typ	Max	Unit
APERTURE						
Delay (t <sub>A</sub> )	III	70°C		120		ps
Uncertainty (Jitter, t <sub>j</sub> )	III	70°C		50		(f <sub>s</sub> ) rms

<sup>1</sup> Baud rate = 1/UI. A subset of this range can be supported.

<sup>2</sup> Default L = 16. This number can be changed based on the sample rate and decimation ratio.

## LIFE TEST AND BURN-IN DELTA SPECIFICATIONS

Nominal supply voltages, specified maximum sampling rate, internal reference, and A<sub>IN</sub> = -1.0 dBFS. Deltas are performed at room temperature (T<sub>A</sub> = 25°C) only, which represents performance at T<sub>J</sub> = 70°C.

Table 5.

Parameter <sup>1</sup>	Delta	Unit
ACCURACY		
Offset Error	±1.1	LSB
Gain Error	±3.4	%FSR
DYNAMIC SUPPLY CURRENT		
I <sub>BVDD2</sub>	±14.7	mA
I <sub>BVNN1</sub>	±15.1	mA
I <sub>AVNN1</sub>	±0.2	mA
I <sub>AVDD</sub>	±0.3	mA
I <sub>CLKVDD_LF</sub>	±3.7	mA
I <sub>PLLVD2</sub>	±0.2	mA
I <sub>AVDFS8</sub>	±5.6	mA
I <sub>FVDD</sub>	±3.5	mA
I <sub>VDD_NVG</sub> <sup>2</sup>	±19.5	mA
I <sub>RVDD2</sub>	±3.8	mA
I <sub>SVDD2</sub>	±0.3	mA
I <sub>JVDD2</sub>	±2.4	mA
I <sub>DVDD</sub> <sup>3</sup>	±105.5	mA
I <sub>JVTT</sub>	±24.7	mA
I <sub>JVDD</sub>	±80	mA
I <sub>TMU_AVDD2</sub>	±0.2	mA
I <sub>TMU_DVDD1</sub>	±0.2	mA

<sup>1</sup> 240 hour burn-in and 1000 hour life test end point electrical parameters.

<sup>2</sup> Current when AVNN1 and BVNN1 are supplied by an external source.

<sup>3</sup> DDC off.

## RADIATION TEST AND LIMIT SPECIFICATIONS

Nominal supply voltages, specified maximum sampling rate, internal reference, and A<sub>IN</sub> = -1.0 dBFS. Radiation testing is performed at room temperature (T<sub>A</sub> = 25°C) only, which represents performance at T<sub>J</sub> = 70°C. Total ionizing dose (TID) testing is characterized to 150 krad (100 krad + 50% overstress) with biased annealing at 100°C for 168 hours. Once characterized, TID testing is performed to 100 krad only.

Table 6.

Parameter	Test Conditions/Comments	Min	Max	Unit
ACCURACY				
Offset Error		-11	+11	LSB
Gain Error		-7.0	+17.0	%FSR

## SPECIFICATIONS

Table 6.

Parameter	Test Conditions/Comments	Min	Max	Unit
<b>DYNAMIC SUPPLY CURRENTS</b>				
I <sub>BVDD2</sub>			147	mA
I <sub>BVNN1</sub>			-151	mA
I <sub>AVNN1</sub>			-2	mA
I <sub>AVDD</sub>			2790	mA
I <sub>CLKVDD_LF</sub>			37	mA
I <sub>PLLVD2</sub>			2	mA
I <sub>AVDDFS8</sub>			56	mA
I <sub>FVDD</sub>			35	mA
I <sub>VDD_NVG</sub> <sup>1</sup>			195	mA
I <sub>RVDD2</sub>			38	mA
I <sub>SVDD2</sub>			1	mA
I <sub>JVDD2</sub>			24	mA
I <sub>DVDD</sub> <sup>2</sup>			1055	mA
I <sub>JVTT</sub>			247	mA
I <sub>JVDD</sub>			800	mA
I <sub>TMU_AVDD2</sub>			2	mA
I <sub>TMU_DVDD1</sub>			2	mA
<b>POWER-DOWN SUPPLY CURRENTS</b>				
	PDWN pin = 1			
I <sub>BVDD2</sub>			0.9	mA
I <sub>BVNN1</sub>			-9	mA
I <sub>AVNN1</sub>			-0.1	mA
I <sub>AVDD</sub>			410	mA
I <sub>CLKVDD_LF</sub>			3	mA
I <sub>PLLVD2</sub>			1.24	mA
I <sub>AVDDFS8</sub>			14.5	mA
I <sub>FVDD</sub>			5.3	mA
I <sub>VDD_NVG</sub> <sup>1</sup>			2.8	mA
I <sub>RVDD2</sub>			0.82	mA
I <sub>SVDD2</sub>			0.4	mA
I <sub>JVDD2</sub>			0.4	mA
I <sub>DVDD</sub> <sup>2</sup>			240	mA
I <sub>JVTT</sub>			85.7	mA
I <sub>JVDD</sub>			180	mA
I <sub>TMU_AVDD2</sub>			2	mA
I <sub>TMU_DVDD1</sub>			0.7	mA
Power Consumption <sup>3</sup>				
Total Power Dissipation (Including Output Drivers) <sup>4</sup>			5.93	W
Power-Down			970	mW
<b>SIGNAL-TO-NOISE RATIO (SNR)</b>				
f <sub>IN</sub> = 170 MHz			59.6	dBFS
f <sub>IN</sub> = 2600 MHz			53.9	dBFS
<b>SIGNAL-TO-NOISE AND DISTORTION (SINAD)</b>				
f <sub>IN</sub> = 170 MHz			58.3	dBFS
f <sub>IN</sub> = 2600 MHz			52.6	dBFS
<b>SPURIOUS-FREE DYNAMIC RANGE (SFDR), SECOND OR THIRD HARMONIC</b>				
f <sub>IN</sub> = 170 MHz			75	dBFS
f <sub>IN</sub> = 2600 MHz			70	dBFS

## SPECIFICATIONS

Table 6.

Parameter	Test Conditions/Comments	Min	Max	Unit
SECOND HARMONIC (H2)				
$f_{IN} = 170 \text{ MHz}$			-61.2	dBFS
$f_{IN} = 2600 \text{ MHz}$			-61.2	dBFS
THIRD HARMONIC (H3)				
$f_{IN} = 170 \text{ MHz}$			-64.4	dBFS
$f_{IN} = 2600 \text{ MHz}$			-67.3	dBFS

<sup>1</sup> Current when AVNN1 and BVNN1 are supplied by an external source.

<sup>2</sup> DDC off.

<sup>3</sup> Power with optional DDC off. Power and supply currents are typical unless otherwise noted.

<sup>4</sup> Total power when AVNN1 and BVNN1 are supplied by VNEG\_OUT.

## ABSOLUTE MAXIMUM RATINGS

Table 7.

Parameter	Rating
Supply Pins	
BVDD2 to AGND	2.2 V
BVNN1 to AGND	-1.1 V
AVNN1 to GND	-1.1 V
AVDD to AGND	1.1 V
CLKVDD_LF to AGND	1.1 V
PLLVDD2 to AGND	2.2 V
AVDDFS8 to AVSSFS8	1.1 V
FVDD to AGND	1.1 V
VDD_NVG to VSS_NVG	1.1 V
RVDD2 to AGND	2.2 V
SVDD2 to DGND	2.2 V
DVDD to DGND	1.1 V
JVTT to JGND	1.1 V
JVDD to JGND	1.1 V
JVDD2 to JGND	2.2 V
TMU_AVDD2 to AGND	2.2 V
TMU_DVDD1 to AGND	1.1 V
GND Pins	
AVSSFS8 to DGND	-0.3 V to +0.3 V
VSS_NVG to DGND	-0.3 V to +0.3 V
AGND to DGND	-0.3 V to +0.3 V
AGND to JGND	-0.3 V to +0.3 V
DGND to JGND	-0.3 V to +0.3 V
Input/Output Pins	
VIN_x to AGND	-0.125 V to AVDD + 0.150 V
CLK_x to AGND	AGND - 0.3 V to CLKVDD_LF + 0.3 V
CSB, RSTB, PDWN, SCLK, FD, GPIO[x], SDIO to DGND	DGND - 0.3 V to SVDD2 + 0.3 V
SYNCINB_x to DGND	DGND - 0.3 V to DVDD + 0.3 V
SYSREF_x, TRIG_x to AVSSFS8	1.8 V
TMU_REFx to TMU_AGND	AGND - 0.3 V to TMU_AVDD2 + 0.3 V
VCM to AGND	AGND - 0.3 V to RVDD2 + 0.3 V
VREF to AGND	AGND - 0.3 V to RVDD2 + 0.3 V
SERDOUT_x[x] to JGND	JGND - 0.3 V to JVTT + 0.3 V
Storage Temperature Range, T <sub>A</sub>	-40°C to +150°C
Operating Junction Temperature (T <sub>J</sub> )	125°C

Stresses at or above those listed under Absolute Maximum Ratings may cause permanent damage to the product. This is a stress rating only; functional operation of the product at these or any other conditions above those indicated in the operational section of this specification is not implied. Operation beyond the maximum operating conditions for extended periods may affect product reliability.

## THERMAL CHARACTERISTICS

Thermal performance is directly linked to printed circuit board (PCB) design and operating environment. Careful attention to PCB thermal design is required.

$\theta_{JA}$  is the natural convection junction to ambient thermal resistance measured in a one cubic foot sealed enclosure.

$\theta_{JC}$  is the junction to case thermal resistance.

$\theta_{JB}$  is the junction to board thermal resistance.

Table 8. Thermal Resistance

Package Type	$\theta_{JA}$	$\theta_{JC}$	$\theta_{JB}$	Unit
BP-192-1 <sup>1</sup>	20.5	1.6	9.2	°C/W

<sup>1</sup> Thermal resistance values specified are simulated based on JEDEC specs in compliance with JESD51-12.

## EXPLANATION OF TEST LEVELS

Table 9. Explanation of Test Levels

Test Level	Description
I	100% production tested at minimum, room, and maximum operating temperatures
II	Parameter is guaranteed by design and not production tested
III	Parameter is a typical value only

## OUTGAS TESTING

The criteria used for the acceptance and rejection of materials must be determined by the user and based upon specific component and system requirements. Historically, a total mass loss (TML) of 1.00% and collected volatile condensable material (CVCM) of 0.10% have been used as screening levels for rejection of spacecraft materials.

Table 10. Outgas Testing

Specification (Tested per ASTM E595 -15)	Value	Unit
TML	0.03	%
CVCM	<0.01	%
Water Vapor Recovered	0.02	%

## ESD CAUTION



**ESD (electrostatic discharge) sensitive device.** Charged devices and circuit boards can discharge without detection. Although this product features patented or proprietary protection circuitry, damage may occur on devices subjected to high energy ESD. Therefore, proper ESD precautions should be taken to avoid performance degradation or loss of functionality.

PIN CONFIGURATION AND FUNCTION DESCRIPTIONS

**AD9213S-CSH  
TOP VIEW  
(Not to Scale)**

	1	2	3	4	5	6	7	8	9	10	11	12	13	14
A	JGND	JGND	SERDOUT_N[1]	SERDOUT_N[0]	SERDOUT_N[2]	SERDOUT_N[4]	SERDOUT_N[6]	SERDOUT_N[8]	SERDOUT_N[10]	SERDOUT_N[12]	SERDOUT_N[14]	SERDOUT_N[15]	JGND	JGND
B	SERDOUT_N[3]	SERDOUT_P[3]	SERDOUT_P[1]	SERDOUT_P[0]	SERDOUT_P[2]	SERDOUT_P[4]	SERDOUT_P[6]	SERDOUT_P[8]	SERDOUT_P[10]	SERDOUT_P[12]	SERDOUT_P[14]	SERDOUT_P[15]	SERDOUT_P[13]	SERDOUT_N[13]
C	SERDOUT_N[5]	SERDOUT_P[5]	JGND	JGND	JGND	JGND	JGND	JGND	JGND	JGND	JGND	JGND	SERDOUT_P[11]	SERDOUT_N[11]
D	SERDOUT_N[7]	SERDOUT_P[7]	RES_DNC	JVTT	JVTT	JVDD	JVDD	JVDD	JVDD	JVTT	JVTT	JVDD2	SERDOUT_P[9]	SERDOUT_N[9]
E	JGND	JGND	RES_DNC	TIE_LOW	DGND	DGND	DGND	DGND	DGND	RES_DNC	RES_DNC	SVDD2	JGND	JGND
F	SYNCINB_P	SVDD2	RES_DNC	DGND	DGND	DGND	DVDD	DVDD	DGND	DGND	AVSSFS8	SCLK	CSB	SYSREF_N
G	SYNCINB_N	TMU_REFP	TDN	TMU_DVDD1	DVDD	DVDD	DVDD	DVDD	DVDD	DVDD	AVDDFS8	SDIO	AVSSFS8	SYSREF_P
H	FD	TMU_REFN	TDP	VSS_MOAT	AGND	AGND	AGND	AGND	AGND	AGND	VSS_MOAT	AVDD	TRIG_P	TRIG_N
J	VDD_NVG	VDD_NVG	AVDD	AVDD	AVDD	AVDD	AVDD	AVDD	AVDD	AVDD	AVDD	RES_DNC	AVDD	AGND
K	VNEG_OUT	AGND	AGND	AGND	AGND	AGND	AGND	AGND	AGND	AGND	AGND	RES_DNC	CLKVDD_LF	CLK_N
L	VSS_NVG	VSS_NVG	TMU_AVDD2	RVDD2	BVDD3	AGND	AGND	AGND	AGND	AGND	AGND	RES_DNC	CLKVDD_LF	CLK_P
M	GPIO[4]	GPIO[2]	GPIO[3]	BVNN2	BVNN1	AGND	VOID	VOID	AGND	BVDD2	FVDD	PLLVD2	AGND	AGND
N	RSTB	GPIO[1]	VREF	AGND	BVNN1	AGND	VOID	VOID	AGND	BVDD2	PDWN	AGND	AGND	RES_DNC
P	AGND	GPIO[0]	VCM	AVNN1	BVNN1	AGND	VIN_P	VIN_N	AGND	BVDD2	AGND	RES_DNC	RES_DNC	AGND

005

Figure 2. Pin Configuration (Top View, Not to Scale)

Table 11. Pin Function Descriptions

Pin No.	Ball Mnemonic	Ball Type	Signal Type	Description
A1, A2, A13, A14, C3 to C12, E1, E2, E13, E14	JGND	Ground	Not applicable	JESD Ground.
A3, B3	SERDOUT_N[1], SERDOUT_P[1]	Output	JESD204B	Lane 1 Differential Pair.
A4, B4	SERDOUT_N[0], SERDOUT_P[0]	Output	JESD204B	Lane 0 Differential Pair.
A5, B5	SERDOUT_N[2], SERDOUT_P[2]	Output	JESD204B	Lane 2 Differential Pair.
A6, B6	SERDOUT_N[4], SERDOUT_P[4]	Output	JESD204B	Lane 4 Differential Pair.
A7, B7	SERDOUT_N[6], SERDOUT_P[6]	Output	JESD204B	Lane 6 Differential Pair.
A8, B8	SERDOUT_N[8], SERDOUT_P[8]	Output	JESD204B	Lane 8 Differential Pair.
A9, B9	SERDOUT_N[10], SERDOUT_P[10]	Output	JESD204B	Lane 10 Differential Pair.
A10, B10	SERDOUT_N[12], SERDOUT_P[12]	Output	JESD204B	Lane 12 Differential Pair.
A11, B11	SERDOUT_N[14], SERDOUT_P[14]	Output	JESD204B	Lane 14 Differential Pair.
A12, B12	SERDOUT_N[15], SERDOUT_P[15]	Output	JESD204B	Lane 15 Differential Pair.
B1, B2	SERDOUT_N[3], SERDOUT_P[3]	Output	JESD204B	Lane 3 Differential Pair.
B13, B14	SERDOUT_P[13], SERDOUT_N[13]	Output	JESD204B	Lane 13 Differential Pair.
C1, C2	SERDOUT_N[5], SERDOUT_P[5]	Output	JESD204B	Lane 5 Differential Pair.
C13, C14	SERDOUT_P[11], SERDOUT_N[11]	Output	JESD204B	Lane 11 Differential Pair.
D1, D2	SERDOUT_N[7], SERDOUT_P[7]	Output	JESD204B	Lane 7 Differential Pair.

## PIN CONFIGURATION AND FUNCTION DESCRIPTIONS

Table 11. Pin Function Descriptions

Pin No.	Ball Mnemonic	Ball Type	Signal Type	Description
D3, E3, E10, E11, F3, J12, K12, L12, N14, P12, P13	RES_DNC	Not applicable	Not applicable	Reserved. Do not connect.
D4, D5, D10, D11	JVTT	Supply	Not applicable	JESD204B Output Driver Termination Voltage, 1 V Supply.
D6 to D9	JVDD	Supply	Not applicable	JESD204B Digital Circuitry Supply, 1 V Supply.
D12	JVDD2	Supply	Not applicable	2 V Supply for JESD204B.
D13, D14	SERDOUT_P[9], SERDOUT_N[9]	Output	JESD204B	Lane 9 Differential Pair.
E4	TIE_LOW	Input	CMOS	Internal Use Only. Connect to ground.
E5 to E9, F4 to F6, F9, F10	DGND	Ground	Not applicable	Digital Ground.
E12, F2	SVDD2	Supply	Not applicable	2 V Supply for Digital Input/Output and Serial Peripheral Interface (SPI).
F1, G1	SYNCINB_P, SYNCINB_N	Input	Not applicable	JESD204B Synchronization. When low, the JESD204B interface handshakes with the receiver. This pin goes high when handshake is complete.
F7, F8, G5 to G10	DVDD	Supply	Not applicable	1 V Supply for Digital Core.
F11, G13	AVSSFS8	Ground	Not applicable	Ground for AVSSFS8 Supply Domain. Connect to ground.
F12	SCLK	Input	Not applicable	Main SPI Clock Pin.
F13	CSB	Input	Not applicable	Chip Select Pin for SPI.
F14, G14	SYSREF_N, SYSREF_P	Input/output	LVDS/current mode logic (CML)	Differential Synchronization Signal. Critical timing relative to CLK_x. This pin is placed near CLK_x inputs and establishes deterministic latency. This pin is internally tied to ground through 50 $\Omega$ in default configuration and can be left floating if set to Subclass 0 mode via Register 0x525.
G2	TMU_REFP	Input	Static	Temperature Measurement Unit (TMU) Reference Supply. Connect this pin to a clean, 1.8 V reference supply on the board that is $\leq$ TMU_AVDD2.
G3, H3	TDN, TDP		Static	Temperature Diode Cathode/Anode. This pin can be left floating if unused.
G4	TMU_DVDD1	Supply	Not applicable	TMU Digital Domain Supply.
G11	AVDDFS8	Supply	Not applicable	1 V Supply for Clocks with $f_s/8$ Energy.
G12	SDIO	Input/output	Not applicable	Main SPI Input/Output Pin.
H1	FD	Output	CMOS	Fast Detect Pin.
H2	TMU_REFN	Input	Static	TMU Reference Supply. Connect to clean ground on board.
H4, H11	VSS_MOAT	Ground	Not applicable	Ground for Isolation Guard Ring. Connect to ground.
H5 to H10, J14, K2 to K11, L6 to L11, M6, M9, M13, M14, N4, N6, N9, N12, N13, P1, P6, P9, P11, P14	AGND	Ground	Not applicable	Ground for ADC.
H12, J3 to J11, J13	AVDD	Supply		Analog Core 1 V Supply for ADC.
H13, H14	TRIG_P, TRIG_N	Input	LVDS	Trigger Input for Frequency Hopping. This pin is internally tied to ground through 50 $\Omega$ in default configuration and can be left floating if disabled by default with Register 0x602.
J1, J2	VDD_NVG	Supply		1 V Supply for On-Board Negative Voltage Generator (NVG).
K1	VNEG_OUT	Output		Internally Generated -1 V Output.
K13, L13	CLKVDD_LF	Supply		1 V Supply for Clock Buffer.
K14, L14	CLK_N, CLK_P	Input	RF	Clock Inputs, High Frequency.
L1, L2	VSS_NVG	Ground		Supply Voltage (VSS) for NVG.
L3	TMU_AVDD2	Supply		TMU 2 V Analog Supply.
L4	RVDD2	Supply		TOP_REF 2 V Supply.

## PIN CONFIGURATION AND FUNCTION DESCRIPTIONS

Table 11. Pin Function Descriptions

Pin No.	Ball Mnemonic	Ball Type	Signal Type	Description
L5	BVDD3	Supply		Internally Generated 3 V Supply for Input Buffer. Bypass with 10 $\mu$ F and 0.1 $\mu$ F capacitors to GND.
M1, M2, M3, N2, P2	GPIO[4], GPIO[2], GPIO[3], GPIO[1], GPIO[0]	Input/output		General-Purpose Input/Output Pins. These pins can be left floating in default configuration.
M4	BVNN2	Supply	Not applicable	Internally Generated -2 V Supply for Input Buffer. Bypass with 10 $\mu$ F and 0.1 $\mu$ F capacitors to GND.
M5, N5, P5	BVNN1	Supply	Not applicable	-1 V Supply for Input Buffer.
M7, M8, N7, N8	VOID	Not applicable	Not applicable	No Balls at These Locations.
M10, N10, P10	BVDD2	Supply	Not applicable	2 V Supply for Input Buffer.
M11	FVDD	Supply	Not applicable	1 V Supply for Reference ADC (REF_ADC).
M12	PLLVDD2	Supply	Not applicable	2.0 V LDO Supply.
N1	RSTB	Input	Not applicable	Chip Reset, Active Low.
N3	VREF	Input	Static	Optional VREF Import.
N11	PDWN	Input	CMOS	Power-Down/Standby Mode Control.
P3	VCM	Output	Static	Export VCM.
P4	AVNN1	Supply	Not applicable	-1 V Supply for TOP_REF.
P7, P8	VIN_P, VIN_N	Input	RF	ADC Inputs, High Frequency.

TYPICAL PERFORMANCE CHARACTERISTICS

Nominal supply voltages, sampling rate = 10 GSPS, 1.4 V p-p full-scale differential input,  $A_{IN} = -1.0$  dBFS,  $T_J = 70^\circ\text{C}$ , and 128k fast Fourier transform (FFT), unless otherwise noted.

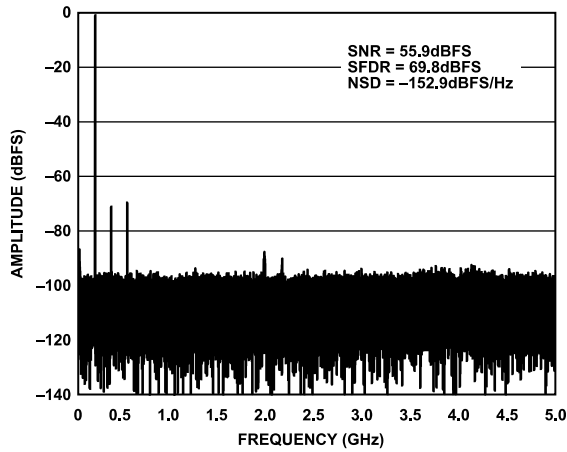

Figure 3. Single-Tone FFT with  $f_{IN} = 170$  MHz, 10 GSPS

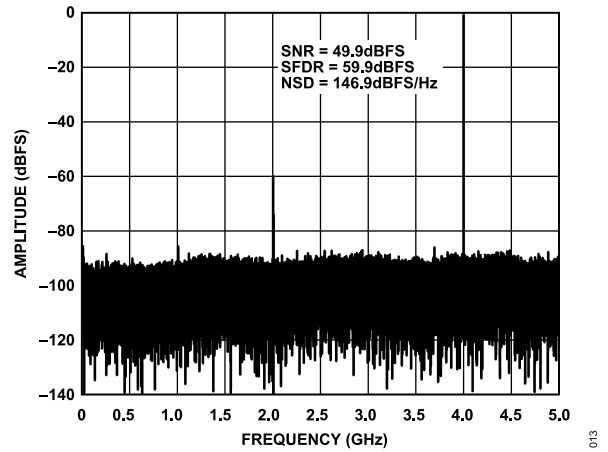

Figure 6. Single-Tone FFT with  $f_{IN} = 4$  GHz, 10 GSPS

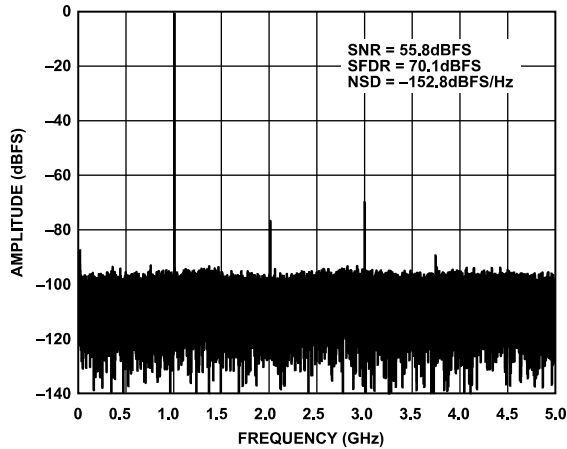

Figure 4. Single-Tone FFT with  $f_{IN} = 1$  GHz, 10 GSPS

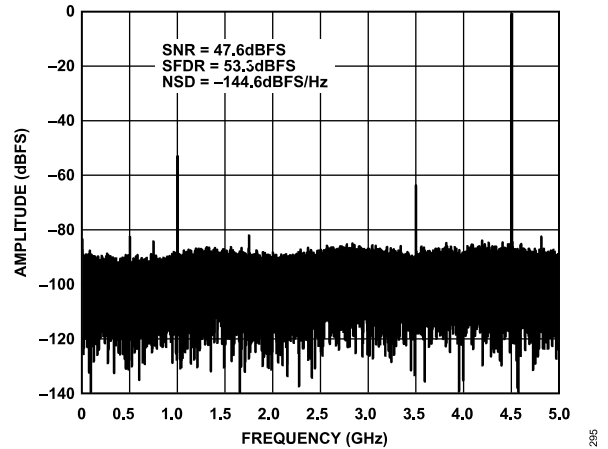

Figure 7. Single-Tone FFT with  $f_{IN} = 5.5$  GHz, 10 GSPS

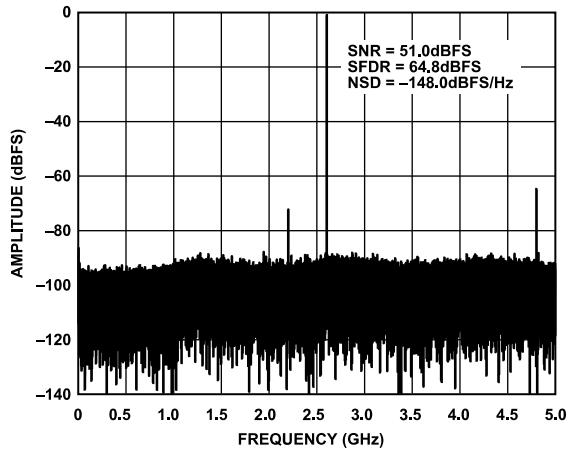

Figure 5. Single-Tone FFT with  $f_{IN} = 2.6$  GHz, 10 GSPS

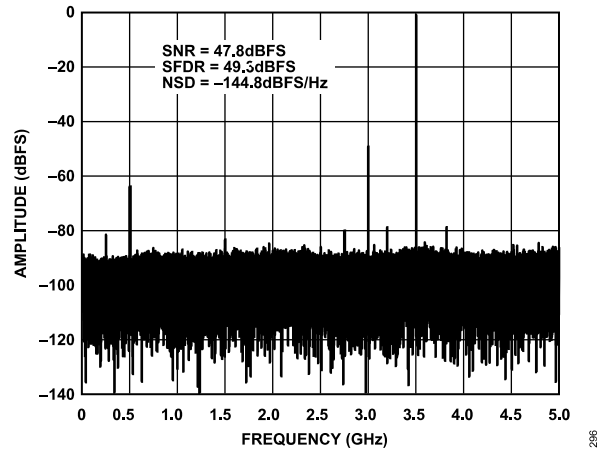

Figure 8. Single-Tone FFT with  $f_{IN} = 6.5$  GHz, 10 GSPS



TYPICAL PERFORMANCE CHARACTERISTICS

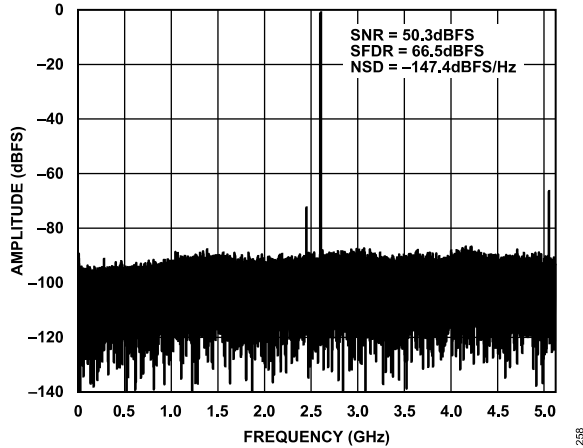

Figure 9. Single-Tone FFT with  $f_{IN} = 2.6$  GHz, 10.25 GSPS

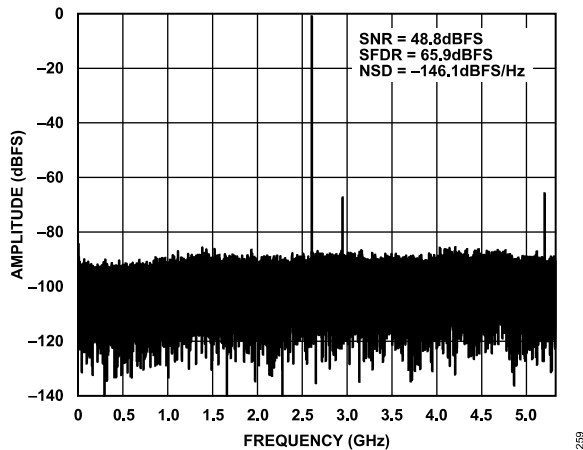

Figure 10. Single Tone FFT with  $f_{IN} = 2.6$  GHz, 10.75 GSPS

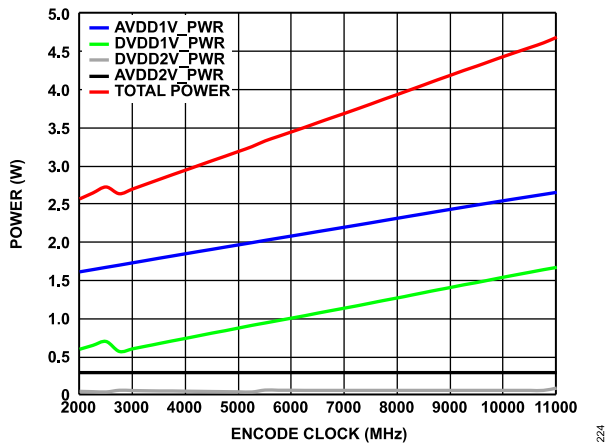

Figure 11. Power vs. Encode Clock ( $f_s$ ) for 16 JESD204B Lanes,  $f_{IN} = 170$  MHz, 10 GSPS

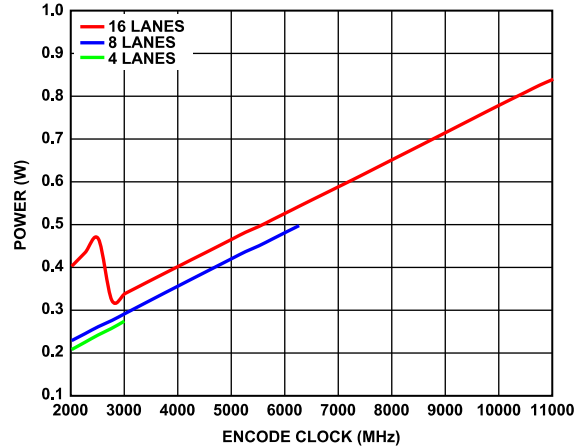

Figure 12. Power vs. Encode Clock ( $f_s$ ) for a Various Number of JESD204B Lanes,  $f_{IN} = 170$  MHz, 10 GSPS

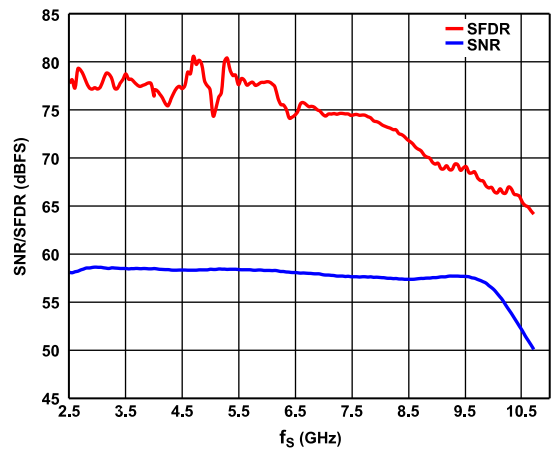

Figure 13. SNR/SFDR vs. Sampling Frequency,  $f_{IN} = 170$  MHz

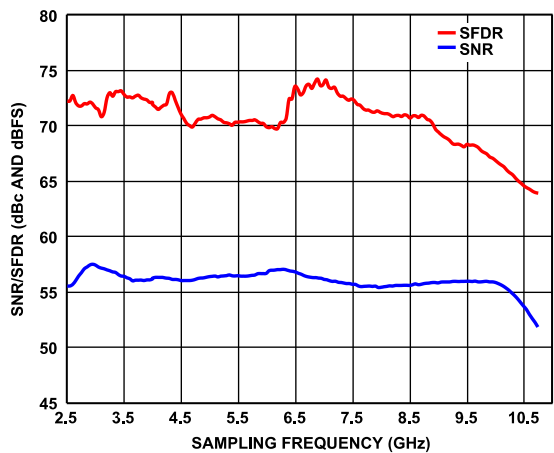

Figure 14. SNR/SFDR vs. Sampling Frequency ( $f_s$ ),  $f_{IN} = 1000$  MHz, 10 GSPS

TYPICAL PERFORMANCE CHARACTERISTICS

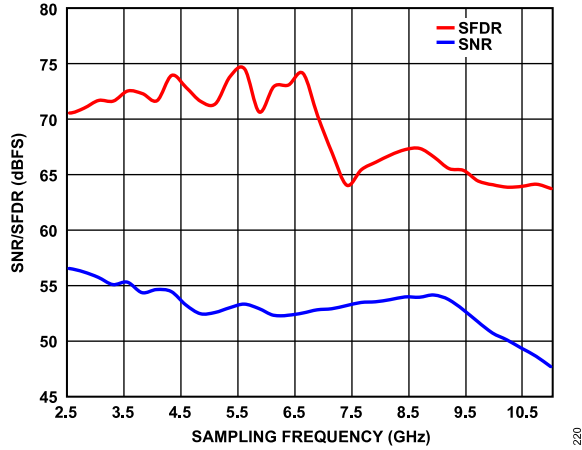

Figure 15. SNR/SFDR vs. Sampling Frequency,  $f_{IN} = 2600$  MHz, 10 GSPS

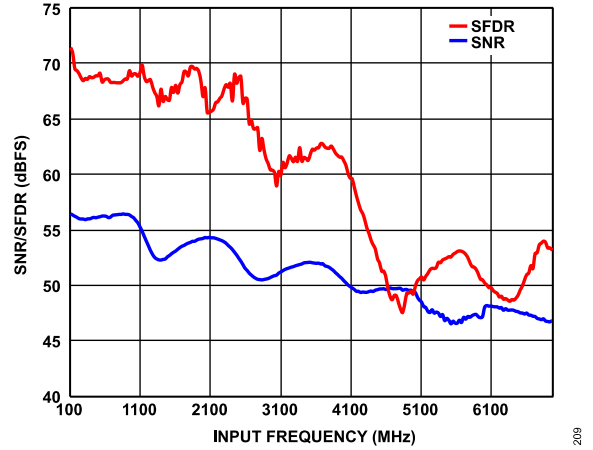

Figure 18. SNR/SFDR vs. Input Frequency ( $f_{IN}$ ), 10 GSPS,  $A_{IN} = -1$  dBFS

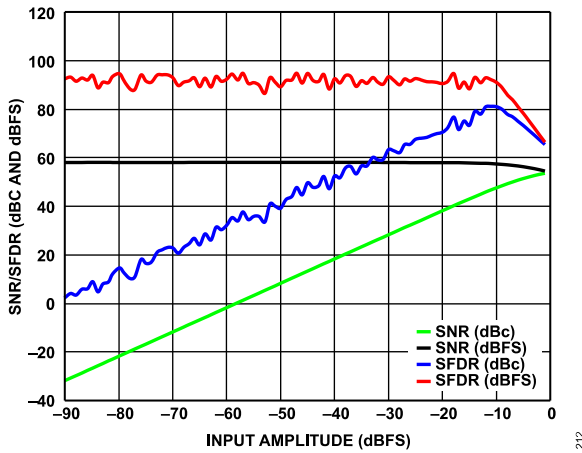

Figure 16. SNR/SFDR vs. Input Amplitude,  $f_{IN} = 1000$  MHz, 10 GSPS

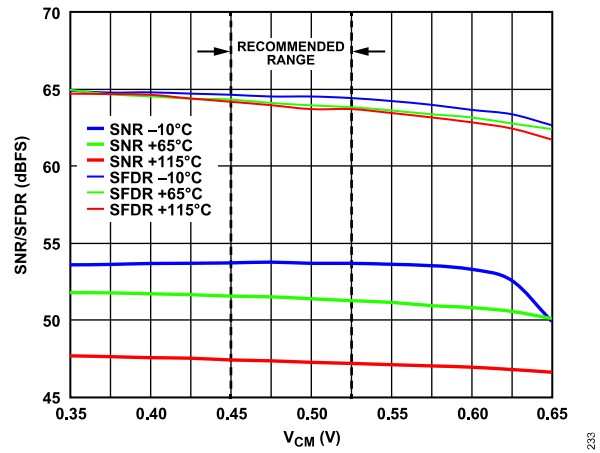

Figure 19. SNR/SFDR vs.  $V_{CM}$ , 10 GSPS, Temperatures

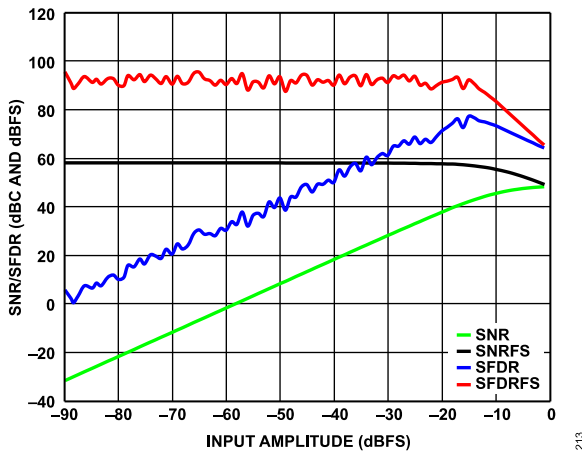

Figure 17. SNR/SFDR vs. Input Amplitude ( $A_{IN}$ ),  $f_{IN} = 2600$  MHz, 10 GSPS

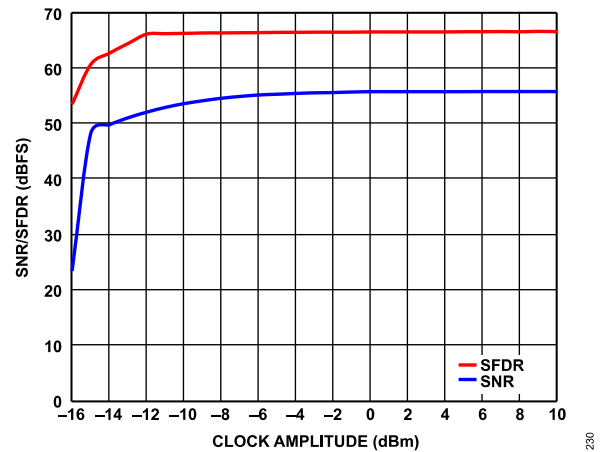

Figure 20. SNR/SFDR vs. Clock Amplitude,  $f_{IN} = 1000$  MHz, 10 GSPS

TYPICAL PERFORMANCE CHARACTERISTICS

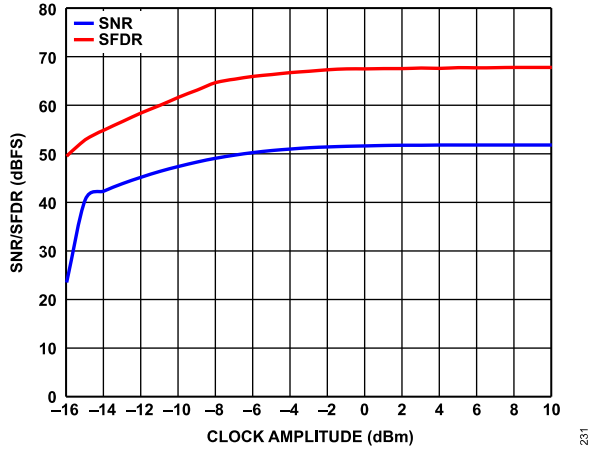

Figure 21. SNR/SFDR vs. Clock Amplitude,  $f_{IN} = 2600$  MHz, 10 GSPS

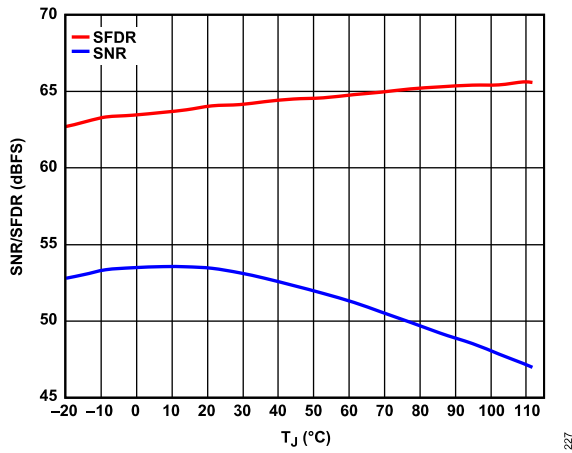

Figure 22. SNR/SFDR vs.  $T_J$ ,  $f_{IN} = 2600$  MHz, 10 GSPS

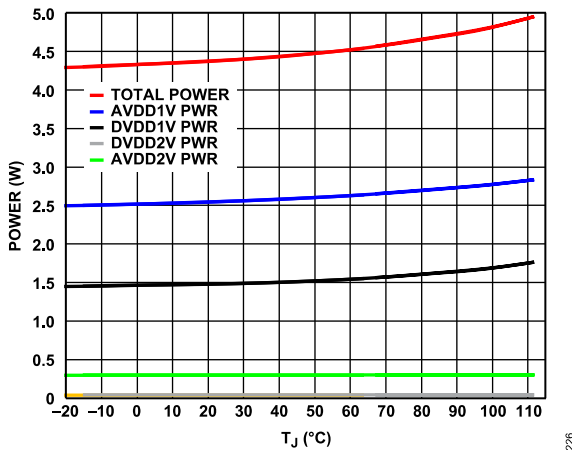

Figure 23. Power vs.  $T_J$ ,  $f_{IN} = 2600$  MHz, 10 GSPS

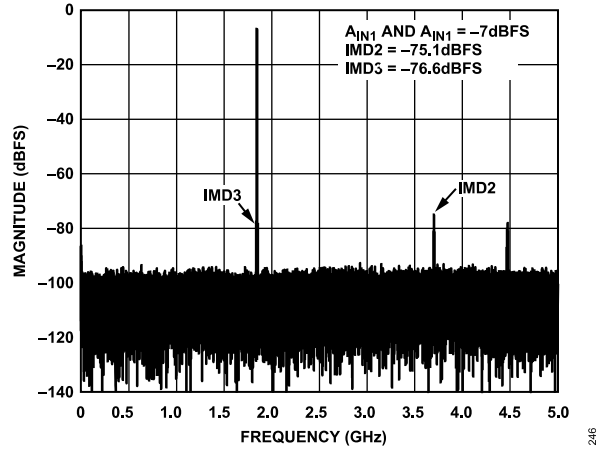

Figure 24. Two-Tone FFT,  $f_{IN1} = 1841.5$  MHz,  $f_{IN2} = 1846.5$  MHz,  $A_{IN1}$  and  $A_{IN2} = -7$  dBFS, 10 GSPS

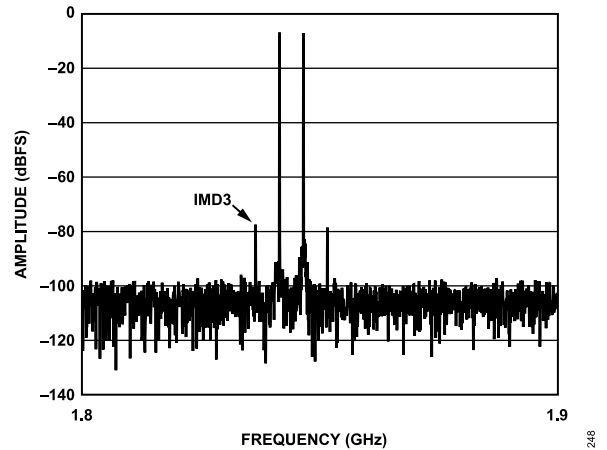

Figure 25. Two-Tone FFT, IMD3 Zoom In,  $f_{IN1} = 1841.5$  MHz,  $f_{IN2} = 1846.5$  MHz,  $A_{IN1}$  and  $A_{IN2} = -7$  dBFS (See Figure 24), 10 GSPS

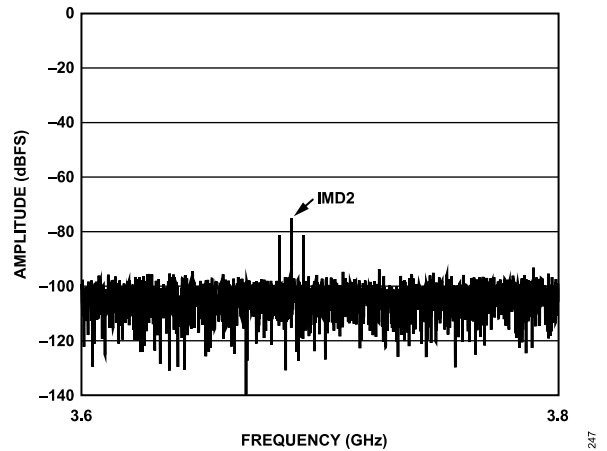

Figure 26. Two-Tone FFT, IMD2 Zoom In,  $f_{IN1} = 1841.5$  MHz,  $f_{IN2} = 1846.5$  MHz,  $A_{IN1}$  and  $A_{IN2} = -7$  dBFS (See Figure 24), 10 GSPS

TYPICAL PERFORMANCE CHARACTERISTICS

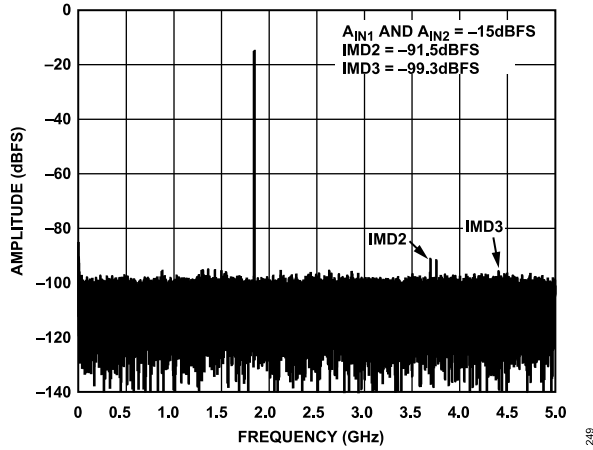

Figure 27. Two-Tone FFT,  $f_{IN1} = 1841.5$  MHz,  $f_{IN2} = 1846.5$  MHz,  $A_{IN1}$  and  $A_{IN2} = -15$  dBFS, 10 GSPS

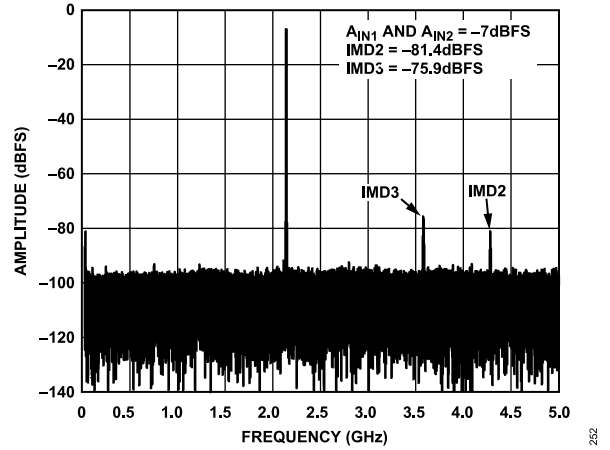

Figure 30. Two-Tone FFT,  $f_{IN1} = 2137.5$  MHz,  $f_{IN2} = 2142.5$  MHz,  $A_{IN1}$  and  $A_{IN2} = -7$  dBFS, 10 GSPS

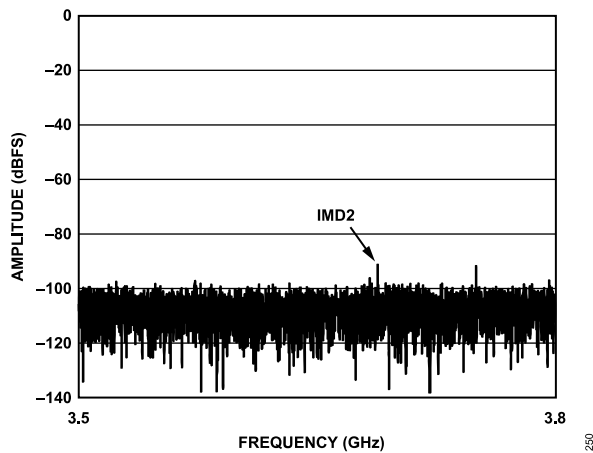

Figure 28. Two-Tone FFT, IMD2 Zoom In,  $f_{IN1} = 1841.5$  MHz,  $f_{IN2} = 1846.5$  MHz,  $A_{IN1}$  and  $A_{IN2} = -15$  dBFS (See Figure 27), 10 GSPS

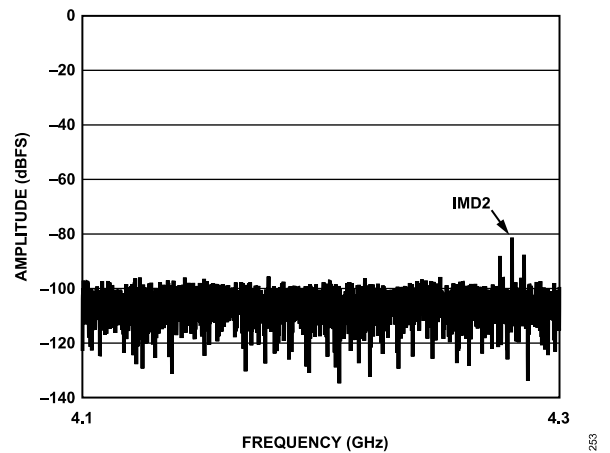

Figure 31. Two-Tone FFT, IMD2 Zoom In,  $f_{IN1} = 2137.5$  MHz,  $f_{IN2} = 2142.5$  MHz,  $A_{IN1}$  and  $A_{IN2} = -7$  dBFS (See Figure 30), 10 GSPS

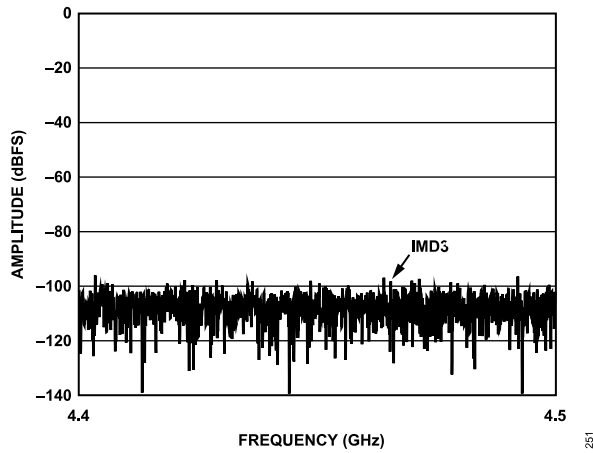

Figure 29. Two-Tone FFT, IMD3 Zoom In,  $f_{IN1} = 1841.5$  MHz,  $f_{IN2} = 1846.5$  MHz,  $A_{IN1}$  and  $A_{IN2} = -15$  dBFS (See Figure 27), 10 GSPS

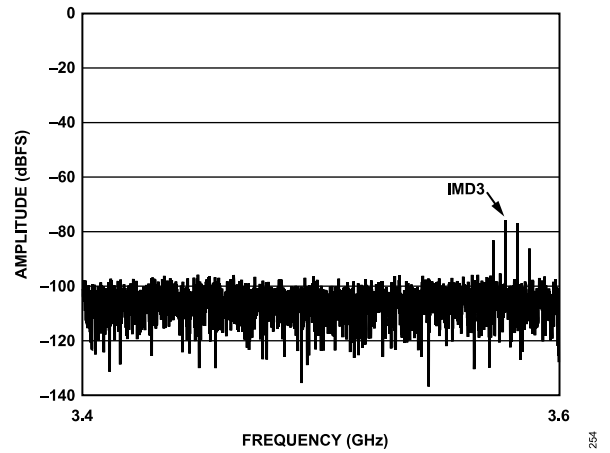

Figure 32. Two-Tone FFT, IMD3 Zoom In,  $f_{IN1} = 2137.5$  MHz,  $f_{IN2} = 2142.5$  MHz,  $A_{IN1}$  and  $A_{IN2} = -7$  dBFS (See Figure 30), 10 GSPS

TYPICAL PERFORMANCE CHARACTERISTICS

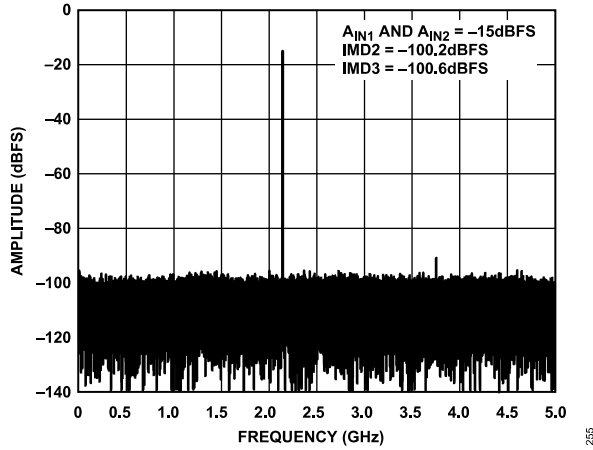

Figure 33. Two-Tone FFT,  $f_{IN1} = 2137.5$  MHz,  $f_{IN2} = 2142.5$  MHz,  $A_{IN1}$  and  $A_{IN2} = -15$  dBFS, 10 GSPS

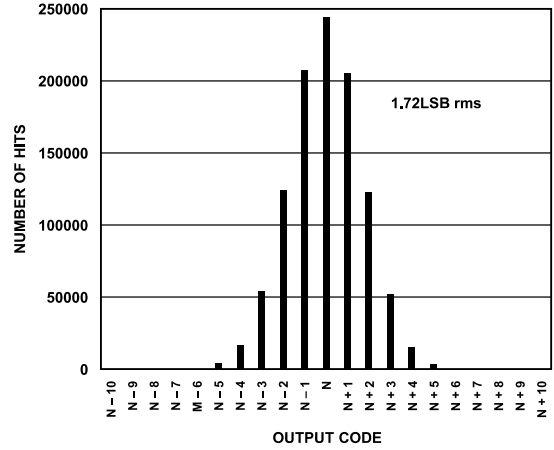

Figure 36. Input-Referred Noise Histogram, 10 GSPS

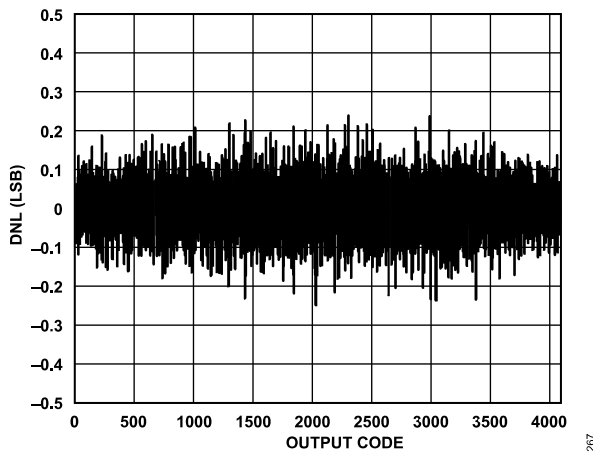

Figure 34. DNL at  $f_{IN} = 170$  MHz, 10 GSPS

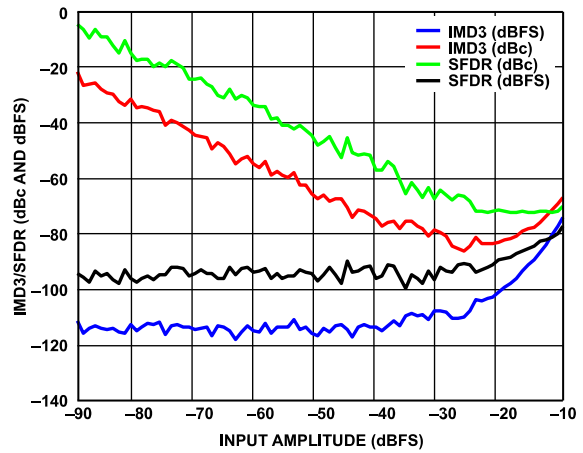

Figure 37. IMD3/SFDR vs. Input Amplitude,  $f_{IN1} = 2137.5$  MHz,  $f_{IN2} = 2142.5$  MHz, 10 GSPS

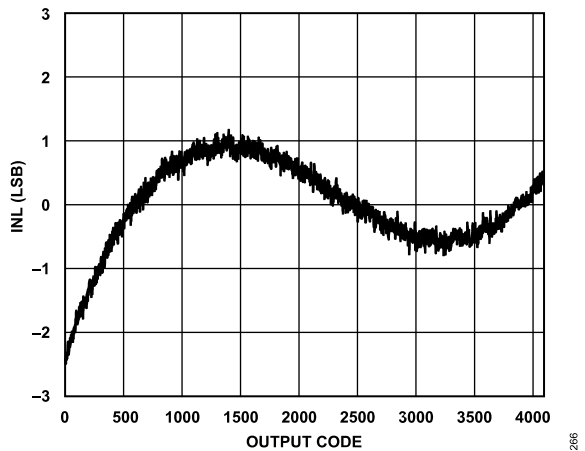

Figure 35. INL at  $f_{IN} = 170$  MHz, 10 GSPS

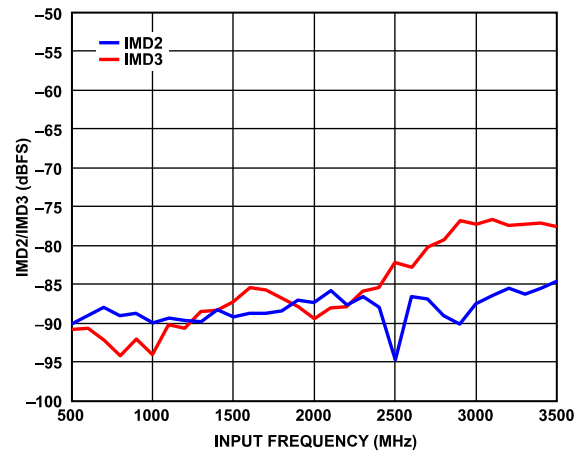

Figure 38. IMD2/IMD3 vs. Input Frequency, ( $A_{IN} = -7$  dBFS), 100 MHz Spacing, 10 GSPS

TYPICAL PERFORMANCE CHARACTERISTICS

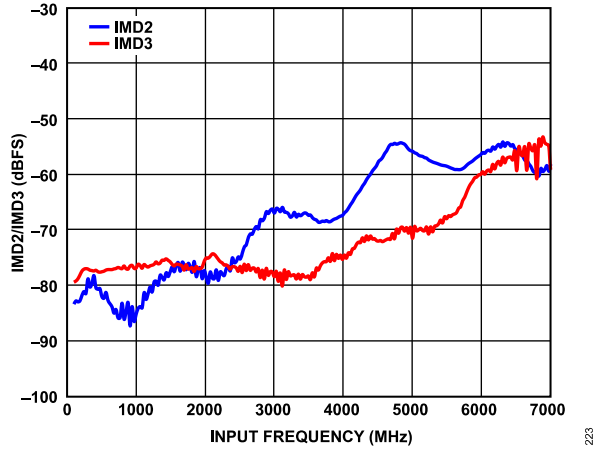

Figure 39. IMD2/IMD3 vs. Input Frequency ( $A_{IN} = -7$  dBFS), 10 MHz Spacing, 10 GSPS

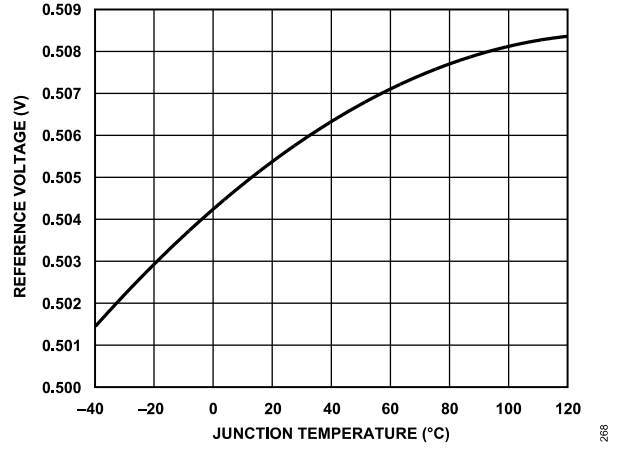
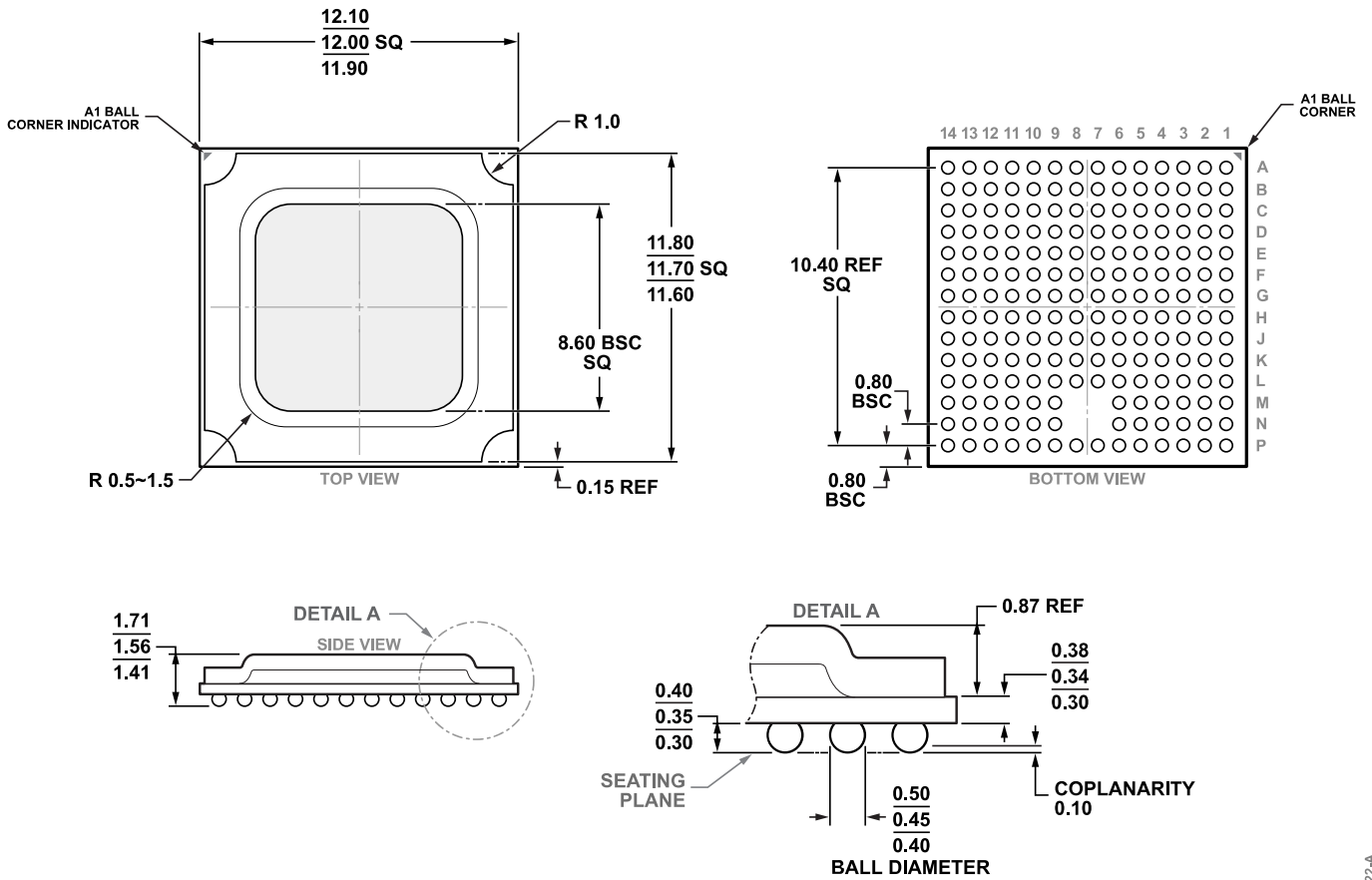

Figure 40. Reference Voltage vs. Junction Temperature, 10 GSPS

OUTLINE DIMENSIONS



COMPLIANT TO JEDEC STANDARDS MO-275-GGAB-1

Figure 41. 192-Ball Ball Grid Array, Thermally Enhanced [BGA\_ED] (BP-192-1)

Dimensions shown in millimeters

Updated: January 12, 2022

ORDERING GUIDE

Model	Temperature Range	Package Description	Packing Quantity	Package Option
AD9213BBP-10G-CSH	-40°C to +85°C	192-Ball BGA_ED (12mm x 12mm x 1.56mm w/ EP)	Tray, 189	BP-192-1