

FEATURES

- 600+ MSPS DAC update rate
- 16/14/12/10-bit resolution family
- LVDS interface with built-in 100-termination resistors
- Single data rate and double data rate capability
- Excellent dynamic performance
- SFDR = 63 dBc at 140 MHz
- IMD = 73 dBc at 140 MHz
- Differential current outputs: 2 mA to 20 mA
- 40°C to +85°C temperature range operation
- On-chip 1.20 V reference
- Package: 80-lead thermally-enhanced TQFP
- Versatile clock and data interface

APPLICATIONS

- Instrumentation and test
- Wideband communications systems
- Point-to-point wireless
- LMDS
- PA linearization
- High resolution displays

PRODUCT DESCRIPTION

The AD9725 is a 14-bit digital-to-analog converter (DAC) that utilizes an LVDS interface to achieve conversion rates in excess of 600 MSPS. It is in a family of pin compatible converters that offers selection of 10-bit, 12-bit, 14-bit, and 16-bit resolution grades. All of the devices share the same interface options, small outline package, and pinout, providing an upward or downward component selection path based on performance, resolution and cost.

Rev. PrA

Information furnished by Analog Devices is believed to be accurate and reliable. However, no responsibility is assumed by Analog Devices for its use, nor for any infringements of patents or other rights of third parties that may result from its use. Specifications subject to change without notice. No license is granted by implication or otherwise under any patent or patent rights of Analog Devices. Trademarks and registered trademarks are the property of their respective owners.

FUNCTIONAL BLOCK DIAGRAM

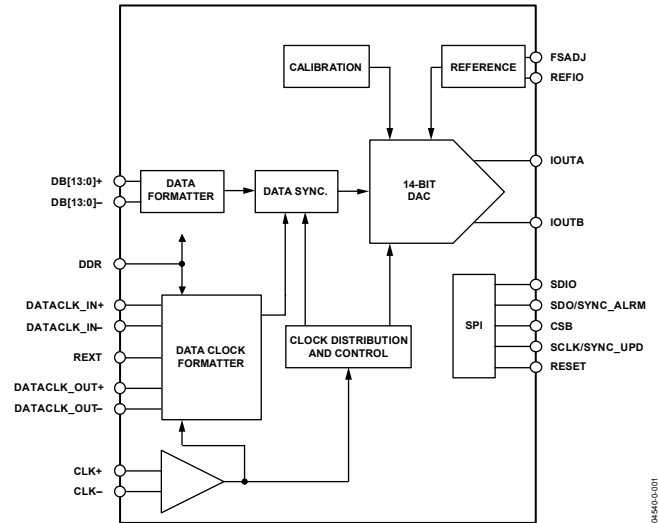

Figure 1

PRODUCT HIGHLIGHTS

Ultralow noise and intermodulation distortion (IMD) enable high quality waveform synthesis at intermediate frequencies up to 200 MHz.

LVDS receivers support SDR or DDR modes, with the maximum conversion rate exceeding 600 MSPS.

Manufactured on a CMOS process, the AD9725 uses a proprietary switching technique that enhances dynamic performance.

The current output of the AD9725 can be easily configured for various single-ended or differential circuit topologies.

TABLE OF CONTENTS

Specifications.....	3	Data Synchronization Circuitry	13
DC Specifications	3	Internal Reference and Full-Scale Output Current.....	13
AC Specifications.....	4	Analog Output	14
Digital Specifications	5	SPI Port Control	14
Digital Timing Information	5	General Operation of the Serial Port Interface	14
Absolute Maximum Ratings.....	6	Instruction Byte	14
Pin Configuration and Function Description	7	Serial Port Interface Pin Description.....	14
Serial Port Interface Register Maps	9	Notes on Serial Port Operation	15
Definitions	11	Outline Dimension.....	16
Typical Performance Curves	12	Ordering Guide	16
Theory of Operation	13		
LVDS Inputs	13		

SPECIFICATIONS

DC SPECIFICATIONS

Table 1. T_{MIN} to T_{MAX} , AVDD1, AVDD2, DBVDD = 3.3 V, ADVDD, ACVDD, CLKVDD, DVDD = 2.5 V, I_{OUTES} = 20 mA, unless otherwise noted. Specifications subject to change without notice

Parameter	Min	Typ	Max	Unit
Resolution	14			Bits
DC Accuracy				
Integral Nonlinearity		±1.5		LSB
Differential Nonlinearity		±0.75		LSB
Analog Output				
Offset Error	-1		1	%FSR
Gain Error				%FSR
Full Scale Output Current		20	1.26	mA
Output Compliance Range	1.14			V
Output Resistance		TBD	1.25	kW
Output Capacitance	0.1	TBD		pF
Reference Output				
Reference Voltage		1.2		V
Reference Output Current		100		nA
Reference Input				
Reference Input Compliance Range				V
Reference Input Resistance		5		kW
Small Signal Bandwidth		0.5		MHz
Temperature Coefficients				
Offset Drift		TBD		ppm of FSR/°C
Gain Drift (With Internal Reference)		TBD		ppm of FSR/°C
Reference Voltage Drift		TBD		ppm/°C
Power Supply ¹				
AVDD1, AVDD2				
Voltage Range		3.3		V
Analog Supply Current ($I_{AVDD1} + I_{AVDD2}$)		51		mA
ADVDD				
Voltage Range		2.5		V
ACVDD				
Voltage Range		2.5		V
Analog Supply Current ($I_{ADVDD} + I_{ACVDD}$)		9		mA
CLKVDD				
Voltage Range		2.5		V
Clock Supply Current (I_{CLKVDD})		20		mA
DVDD				
Voltage Range		2.5		V
Digital Supply Current (I_{DVDD})		69		mA
DBVDD				
Voltage Range		3.3		V
Digital Supply Current (I_{DBVDD})		20		mA
Nominal Power Dissipation (P_{DIS}) ²		479		mW
Nominal Power Dissipation (P_{DIS}) ³		1000		mW

¹Supply currents measured under the following conditions: $f_{DAC} = 200$ MSPS, $f_{OUT} = 11$ MHz, nominal power supply voltages

²Power dissipation measured under the following conditions: $f_{DAC} = 200$ MSPS, $f_{OUT} = 11$ MHz, nominal power supply voltages

³Power dissipation measured under the following conditions: $f_{DAC} = 600$ MSPS, $f_{OUT} = 111$ MHz, nominal power supply voltages

AC SPECIFICATIONS

Table 2. T_{MIN} to T_{MAZ} , AVDD1, AVDD2, DBVDD = 3.3 V, ADVDD, ACVDD, CLKVDD, DVDD = 2.5 V, I_{OUTES} = 20 mA, unless otherwise noted. Specifications subject to change without notice.

Parameter	Typ	Unit
Dynamic Performance		
Max DAC Output Update Rate (DDR)	600	MSPS
Max DAC Output Update Rate (SDR)	440	MSPS
AC Linearity		
Spurious Free Dynamic Range (SFDR) to Nyquist ($f_{OUT} = 0$ dBFS)		
$f_{DATA} = 260$ MSPS, $f_{OUT} = 20$ MHz	71	dBc
$f_{DATA} = 260$ MSPS, $f_{OUT} = 70$ MHz	68	dBc
$f_{DATA} = 260$ MSPS, $f_{OUT} = 120$ MHz	68	dBc
$f_{DATA} = 400$ MSPS, $f_{OUT} = 20$ MHz	72	dBc
$f_{DATA} = 400$ MSPS, $f_{OUT} = 70$ MHz	66	dBc
$f_{DATA} = 400$ MSPS, $f_{OUT} = 140$ MHz	60	dBc
$f_{DATA} = 600$ MSPS, $f_{OUT} = 20$ MHz	TBD	dBc
$f_{DATA} = 600$ MSPS, $f_{OUT} = 125$ MHz	TBD	dBc
$f_{DATA} = 600$ MSPS, $f_{OUT} = 250$ MHz	TBD	dBc
Two Tone IMD to Nyquist ($f_{OUT1} = f_{OUT2} = -6$ dBFS)		
$f_{DATA} = 300$ MSPS, $f_{OUT1} = 26$ MHz, $f_{OUT2} = 27$ MHz	89	dBc
$f_{DATA} = 300$ MSPS, $f_{OUT1} = 100$ MHz, $f_{OUT2} = 101$ MHz	80	dBc
$f_{DATA} = 300$ MSPS, $f_{OUT1} = 126$ MHz, $f_{OUT2} = 127$ MHz	80	dBc
$f_{DATA} = 500$ MSPS, $f_{OUT1} = 26$ MHz, $f_{OUT2} = 27$ MHz	90	dBc
$f_{DATA} = 500$ MSPS, $f_{OUT1} = 100$ MHz, $f_{OUT2} = 101$ MHz	78	dBc
$f_{DATA} = 500$ MSPS, $f_{OUT1} = 126$ MHz, $f_{OUT2} = 127$ MHz	76	dBc
$f_{DATA} = 600$ MSPS, $f_{OUT1} = 26$ MHz, $f_{OUT2} = 27$ MHz	TBD	dBc
$f_{DATA} = 600$ MSPS, $f_{OUT1} = 126$ MHz, $f_{OUT2} = 127$ MHz	TBD	dBc
$f_{DATA} = 600$ MSPS, $f_{OUT1} = 250$ MHz, $f_{OUT2} = 251$ MHz	TBD	dBc
Noise Spectral Density (NSD)		
$f_{DATA} = 500$ MSPS, $f_{OUT} = 20$ MHz, 0 dBFS	-162	dBm/Hz
$f_{DATA} = 500$ MSPS, $f_{OUT} = 20$ MHz, -12 dBFS	-165	dBm/Hz
$f_{DATA} = 500$ MSPS, $f_{OUT} = 120$ MHz, 0 dBFS	-151	dBm/Hz
$f_{DATA} = 500$ MSPS, $f_{OUT} = 120$ MHz, -12 dBFS	-161	dBm/Hz
CDMA2000 Adjacent Channel Leakage Ratio (ACLR)		
$f_{DATA} = 245.76$ MSPS, IF = 61.44 MHz	TBD	dBc
$f_{DATA} = 491.52$ MSPS, IF = 122.88 MHz	TBD	dBc
$f_{DATA} = 491.52$ MSPS, IF = 190 MHz	TBD	dBc
WCDMA Adjacent Channel Leakage Ratio (ACLR), Single Carrier		
$f_{DATA} = 184.32$ MSPS, IF = 61.44 MHz	79	dBc
$f_{DATA} = 245.76$ MSPS, IF = 61.44 MHz	79	dBc
$f_{DATA} = 491.52$ MSPS, IF = 122.88 MHz	76	dBc
$f_{DATA} = 491.52$ MSPS, IF = 190 MHz	74	dBc
WCDMA Adjacent Channel Leakage Ratio (ACLR), Four Carrier		
$f_{DATA} = 184.32$ MSPS, IF = 61.44 MHz,	69	dBc
$f_{DATA} = 368.64$ MSPS, IF = 92.16 MHz	67	dBc

DIGITAL SPECIFICATIONS

Table 3. T_{MIN} to T_{MAX}, AVDD1, AVDD2, DBVDD = 3.3 V, ADVDD, ACVDD, CLKVDD, DVDD = 2.5 V, I_{OUTFS} = 20 mA, unless otherwise noted. Specifications subject to change without notice.

Parameter	Conditions	Min	Typ	Max	Unit
Digital Inputs	VCM = 0.875 V to 1.575 V				
Differential Logic '1'	(put into footnote, and delete column?)	0.1		0.6	V
Differential Logic '0'		-0.6		-0.1	V
Logic '1' current			3.5		mA
Logic '0' current			3.5		mA
Differential Input Resistance			100		W
Differential Input Capacitance			3		pF
Data Setup Time (t _{DS})			0.9		ns
Data Hold Time (t _{DH})			-0.3		ns
Data Clock Output Delay (t _{DCO})			2.4		ns
Serial Control Bus					
Maximum SCLK Frequency (fSCLK)		15			MHz
Minimum Clock Pulse Width High (t _{PWH})		30			ns
Minimum Clock Pulse Width Low (t _{PWL})		30			ns
Maximum Clock Rise/Fall Time				1	ms
Minimum Data/Chip Select Set Up Time (t _{DS})		25			ns
Minimum Data Hold Time (t _{DH})		0			ns
Maximum Data Valid Time (t _{DV})				30	ns
RESET Pulse Width		1.5			ns
Inputs (SDI, SDIO, SCLK, CSB)					
Logic '1' Voltage		2.1	3		V
Logic '0' Voltage			0	0.9	V
Logic '1' Current		-10		+10	μA
Logic '0' Current		-10		+10	μA
Input Capacitance			5		pF
SDIO Output					
Logic '1' Voltage		DRVDD-0.6			V
Logic '0' Voltage				0.4	V
Logic '1' Current		30		50	mA
Logic '0' Current		30		50	mA

DIGITAL TIMING INFORMATION

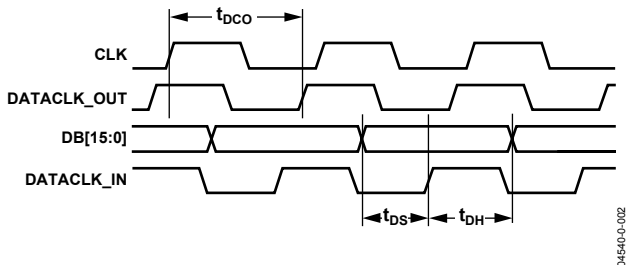

Figure 2. Single Datarate (SDR) Mode

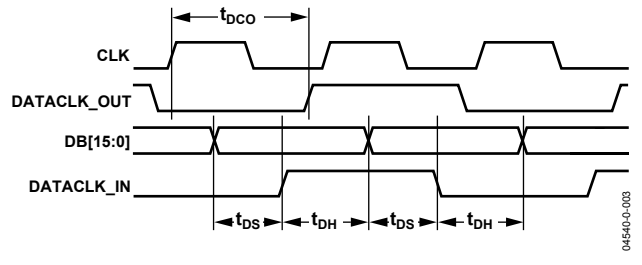

Figure 3. Double Datarate (DDR) Mode

ABSOLUTE MAXIMUM RATINGS

Parameter	With Respect to	Min	Max	Unit
AVDD1, AVDD2, DBVDD	ACOM1, ACOM2, DBCOM	-0.3	TBD	V
ADVDD, ACVDD, CLKVDD, DVDD	ADCOM, ACCOM, CLKCOM, DCOM	-0.3	TBD	V
ACOM1, ACOM2, DBCOM	ACOM1, ACOM2, DBCOM	-0.3	+0.3	V
ADCOM, ACCOM, CLKCOM, DCOM	ADCOM, ACCOM, CLKCOM, DCOM	-0.3	+0.3	V
REFIO, FSDAJ	ACOM1	-0.3	AVDD1 + 0.3	V
IOUTA, IOUTB	ACOM1	-1	AVDD1 + 0.3	V
DB0-DB15, DB0-DB15	DBCOM	-0.3	DBVDD + 0.3	V
DATACLKOUT, DATACLKOUT	DBCOM	-0.3	DBVDD + 0.3	V
REXT, CLK+, CLK-	CLKCOM	-0.3	CLKVDD + 0.3	V
SDO/SYNC_ALARM, SDIO, CSB	DBCOM	-0.3	DBVDD + 0.3	V
SCLK/SYNC, RESET	DBCOM	-0.3	DBVDD + 0.3	V
DDR, SPI_DIS	ADCOM	-0.3	ADVDD + 0.3	V

Stresses above those listed under Absolute Maximum Ratings may cause permanent damage to the device. This is a stress rating only; functional operation of the device at these or any other conditions above those listed in the operational sections of this specification is not implied. Exposure to absolute maximum rating conditions for extended periods may affect device reliability.

ESD (electrostatic discharge) sensitive device. Electrostatic charges as high as 4000 V readily accumulate on the human body and test equipment and can discharge without detection. Although this product features proprietary ESD protection circuitry, permanent damage may occur on devices subjected to high energy electrostatic discharges. Therefore, proper ESD precautions are recommended to avoid performance degradation or loss of functionality.



PIN CONFIGURATION AND FUNCTION DESCRIPTION

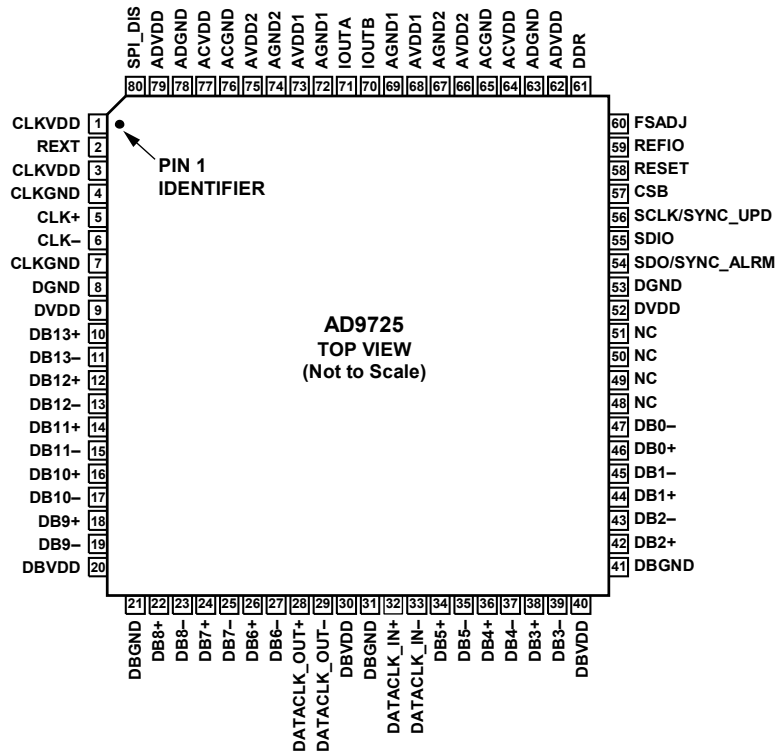

Figure 4. Pin Configuration

Table 4. Pin Function Description

Pin No.	Name	Description	Pin No.	Name	Description
1	CLKVDD	Clock Supply Voltage	41	DBGND	Digital Data Supply Common
2	REXT	Bias Resistor. Sets DATACLK_OUT drive strength. Nominally 1 kΩ to DBGND	42	DB2+	Digital Input Bit 2–True
3	CLKVDD	Clock Supply Voltage	43	DB2–	Digital Input Bit 2–Complement
4	CLKGND	Clock Supply Common	44	DB1+	Digital Input Bit 1–True
5	CLK+	Clock Input–True	45	DB1–	Digital Input Bit 1–Complement
6	CLK–	Clock Input–Complement	46	DB0+	Digital Input Bit 0–True
7	CLKGND	Clock Supply Common	47	DB0–	Digital Input Bit 0–Complement
8	DGND	Digital Common	48	NC	No Connect
9	DVDD	Digital Supply Voltage	49	NC	No Connect
10	DB13+	Digital Input Bit 13–True	50	NC	No Connect
11	DB13–	Digital Input Bit 13–Complement	51	NC	No Connect
12	DB12+	Digital Input Bit 12–True	52	DVDD	Digital Supply Voltage
13	DB12–	Digital Input Bit 12–Complement	53	DGND	Digital Common
14	DB11+	Digital Input Bit 11–True	54	SDO/SYNC_ALRM	SPI_DIS = 1: Data/Clock Synchronization Alarm
15	DB11–	Digital Input Bit 11–Complement	55	SDIO	SPI Serial Data Input/Output
16	DB10+	Digital Input Bit 10–True	56	SCLK/SYNC_UPD	SPI_DIS = 1: Data/Clock Synchronization Update Required
17	DB10–	Digital Input Bit 10–Complement	57	CSB	SPI Chip Select (Active Low)
18	DB9+	Digital Input Bit 9–True	58	RESET	Hardware Reset
19	DB9–	Digital Input Bit 9–Complement	59	REFIO	Reference Output, 1.2 V Nominal
20	DBVDD	Digital Data Supply Voltage	60	FSADJ	Full-Scale Current Adjust

Pin No.	Name	Description	Pin No.	Name	Description
21	DBGND	Digital Data Supply Common	61	DDR	SPI_DIS = 1: Double Data Rate Mode (Active High)
22	DB8+	Digital Input Bit 8–True	62	ADVDD	Analog Supply Voltage
23	DB8–	Digital Input Bit 8–Complement	63	ADGND	Analog Supply Common
24	DB7+	Digital Input Bit 7–True	64	ACVDD	Analog Supply Voltage
25	DB7–	Digital Input Bit 7–Complement	65	ACGND	Analog Supply Common
26	DB6+	Digital Input Bit 6–True	66	AVDD2	Analog Supply Voltage
27	DB6–	Digital Input Bit 6–Complement	67	AGND2	Analog Supply Common
28	DATACLK_OUT+	Data Clock Output–True	68	AVDD1	Analog Supply Voltage
29	DATACLK_OUT–	Data Clock Output–Complement	69	AGND1	Analog Supply Common
30	DBVDD	Digital Data Supply Voltage	70	IOUTB	DAC Current Output–Complement
31	DBGND	Digital Data Supply Common	71	IOUTA	DAC Current Output–True
32	DATACLK_IN+	Data Clock Input–True	72	AGND1	Analog Supply Common
33	DATACLK_IN–	Data Clock Input–Complement	73	AVDD1	Analog Supply Voltage
34	DB5+	Digital Input Bit 5–True	74	AGND2	Analog Supply Common
35	DB5–	Digital Input Bit 5–Complement	75	AVDD2	Analog Supply Voltage
36	DB4+	Digital Input Bit 4–True	76	ACGND	Analog Supply Common
37	DB4–	Digital Input Bit 4–Complement	77	ACVDD	Analog Supply Voltage
38	DB3+	Digital Input Bit 3–True	78	ADGND	Analog Supply Common
39	DB3–	Digital Input Bit 3–Complement	79	ADVDD	Analog Supply Voltage
40	DBVDD	Digital Data Supply Voltage	80	SPI_DIS	SPI Disable (Active High)

SERIAL PORT INTERFACE REGISTER MAPS

Table 5. Mode Control via SPI Port

Address	Bit 7	Bit 6	Bit 5	Bit 4	Bit 3	Bit 2	Bit 1	Bit 0	
COMMS	00	SDIODIR	DATADIR	SWRST	SLEEP	PDN	RESERVED ¹	RESERVED	EXREF
	01				RESERVED				
DATA	02	DATAFMT	DDR	DCLKPOLI	DCLKPOLO	DISDCLKO	SYNCMAN	SYNCUPD	SYNCALRM
	03				RESERVED				
	04				RESERVED				
	05				RESERVED				
	06				RESERVED				
	07				RESERVED				
	08				RESERVED				
	09				RESERVED				
	0A				RESERVED				
	0B				RESERVED				
	0C				RESERVED				
VERSION	0D	RESERVED	RESERVED	RESERVED	RESERVED	VERSION[3]	VERSION[2]	VERSION[1]	VERSION[0]
CALMEMCK	0E	RESERVED	RESERVED	CALMEM[1]	CALMEM[0]	RESERVED	CALCKDIV[2]	CALCKDIV[1]	CALCKDIV[0]
MEMRDWR	0F	CALSTAT	CALEN	XFERSTAT	XFEREN	SMEMWR	SMEMRD	FMEMRD	UNCAL
MEMADDR	10	MEMADDR[7]	MEMADDR[6]	MEMADDR[5]	MEMADDR[4]	MEMADDR[3]	MEMADDR[2]	MEMADDR[1]	MEMADDR[0]
MEMDATA	11	RESERVED	RESERVED	MEMDATA[5]	MEMDATA[4]	MEMDATA[3]	MEMDATA[2]	MEMDATA[1]	MEMDATA[0]

¹ Reserved registers should be set to Logic 0 (low state) during a write operation, and masked (ignored) during a read operation.

Table 6. SPI Register Definitions

Register	Bit	Direction	Default	Description
COMMCTRL(00)				
SDIODIR	7	1	0	0: SDIO pin configured for input only during data transfer 1: SDIO pin configured for input or output during data transfer
DATADIR	6	1	0	0: Serial data uses MSB first format 1: Serial data uses LSB first format
SWRST	5	1	0	1: Default all serial register bits, except address 00h
SLEEP	4	1	0	1: DAC output current off
PDN	3	1	0	1: All analog and digital circuitry, except serial interface, off
RESERVED	2	0	0	RESERVED
RESERVED	1	0	0	RESERVED
EXREF	0	1	0	0: Internal bandgap reference
DATACTRL(02)				
DATAFMT	7	1	0	0: Twos complement input data format 1: Unsigned binary input data format
DDR	6	1	0	0: Single Data Rate mode 1: Double Data Rate mode
DCLKPOLI	5	1	0	0: Data latched on DATACLKIN rising edge 1: Data latched on DATACLKIN falling edge
DCLKPOLO	4	1	0	0: Data latched on DATACLKOUT rising edge 1: Data latched on DATACLKOUT falling edge
DISDCLKO	3	1	0	0: DATACLKOUT enabled 1: DATACLKOUT disabled
SYNCMAN	2	1	0	0: Automatic synchronization initiated following a SYNCALRM 1: Manual synchronization needed following a SYNCALRM

SYNCUPD	1	1	0	0: Data synchronization complete 1: Initiate data synchronization
SYNCALRM	0	0	0	0: Data synchronizer does not require updating 1: Data synchronizer requires updating
VERSION(0D) VERSION[3:0]	[3:0]	0	–	Hardware version identifier
CALMEMCK(0E) CALMEM	[5:4]	0	00	Calibration memory 00: Uncalibrated 01: Self calibration 10: Factory calibration 11: User input
CALCKDIV	[2:0]	1	000	Calibration clock divide ratio from channel data rate 000:/32 001:/64 110:/2048 111:/4096
MEMRDWR(0F) CALSTAT	7	0	0	0: Self Calibration cycle not complete 1: Self Calibration cycle complete
CALEN	6	1	0	1: Self Calibration in progress
XFERSTAT	5	0	0	0: Factory memory transfer not complete 1: Factory memory transfer complete
XFEREN	4	1	0	1: Factory memory transfer in progress
SMEMWR	3	1	0	1: Write static memory data from external port
SMEMRD	2	1	0	1: Read static memory to external port
FMEMRD	1	1	0	1: Read factory memory data to external port
UNCAL	0	1	0	1: Use uncalibrated
MEMADDR(10) MEMADDR	[7:0]	I/O	00000000	Address of factory or static memory to be accessed
MEMDATA(11) MEMDATA	[5:0]	I/O	000000	Data for factory or static memory access

1: External reference

DEFINITIONS

Linearity Error (Also Called Integral Nonlinearity or INL)

Linearity error is defined as the maximum deviation of the actual analog output from the ideal output, determined by a straight line drawn from zero-scale to full-scale.

Differential Nonlinearity (DNL)

DNL is the measure of the variation in analog value, normalized to full-scale, and associated with a 1 LSB change in digital input code.

Monotonicity

A D/A converter is monotonic if the output either increases or remains constant as the digital input increases.

Offset Error

The deviation of the output current from the ideal of zero is called offset error. For I_{OUTA} , 0 mA output is expected when the inputs are all 0s. For I_{OUTB} , 0 mA output is expected when all inputs are set to 1s.

Gain Error

The difference between the actual and ideal output span. The actual span is determined by the output when all inputs are set to 1s, minus the output when all inputs are set to 0s.

Output Compliance Range

The range of allowable voltage at the output of a current-output DAC. Operation beyond the maximum compliance limits may cause either output stage saturation or breakdown, resulting in nonlinear performance.

Temperature Drift

Temperature drift is specified as the maximum change from the ambient (25°C) value to the value at either T_{MIN} or T_{MAX} . For offset and gain drift, the drift is reported in ppm of full-scale range (FSR) per degree celsius. For reference drift, the drift is reported in ppm per degree celsius.

Power Supply Rejection

The maximum change in the full-scale output as the supplies are varied from minimum to maximum specified voltages.

Settling Time

The time required for the output to reach and remain within a specified error band about its final value, measured from the start of the output transition.

Glitch Impulse

Asymmetrical switching times in a DAC give rise to undesired output transients that are quantified by a glitch impulse. It is specified as the net area of the glitch in pV-s.

Spurious-Free Dynamic Range

The difference, in decibels, between the rms amplitude of the output signal and the peak spurious signal over the specified bandwidth.

Total Harmonic Distortion

THD is the ratio of the rms sum of the first six harmonic components to the rms value of the measured fundamental. It is expressed as a percentage or in decibels (dB).

Signal-to-Noise Ratio (SNR)

S/N is the ratio of the rms value of the measured output signal to the rms sum of all other spectral components below the Nyquist frequency, excluding the first six harmonics and dc. The value for SNR is expressed in decibels.

Adjacent Channel Power Ratio (or ACPR)

A ratio in dBc between the measured power within a channel relative to its adjacent channel.

LVDS

Low voltage differential signaling. A differential logic specification that defines logic levels as approximately ± 350 mV (differential) over a common mode range of 0.875 V to 1.575 V. LVDS is designed to achieve clock rates of up to 840 MHz.

TYPICAL PERFORMANCE CURVES

Figure 5. SFDR vs. f_{OUT} at $f_{DAC} = 400$ MSPS

Figure 6. IMD vs. f_{OUT} at $f_{DAC} = 500$ MSPS

Figure 7. Noise Spectral Density vs. f_{OUT} at $f_{DAC} = 500$ MSPS

Figure 8. WCDMA ACLR at Select Intermediate Frequencies and Sample Rates

THEORY OF OPERATION

LVDS INPUTS

The AD9725 uses LVDS (Low Voltage Differential Signaling) digital inputs to enable high speed digital signaling. LVDS allows the use of a differential signal for optimum noise rejection, and has small signal amplitude for fast speed and lower power dissipation. Each differential digital input on the AD9725 has an internal 100 Ω resistor for proper load termination. The LVDS digital data inputs on the AD9725 meet the IEEE reduced range (RR) specs for common mode input range (875 mV to 1575 mV) with an input differential threshold of ± 350 mV.

DATA SYNCHRONIZATION CIRCUITRY

The high speeds at which the LVDS digital interface is designed to operate require maintaining synchronization of the data (DB[15:0]+, DB[15:0]-) and data clock (DATACLK_IN+, DATACLK_IN-) with the DAC clock (CLK+, CLK-). Since the DAC clock input is not LVDS, the phase relationship between that clock and the data can vary, and, unless precautions are taken, data can be corrupted.

The input data must be provided at the same frequency as the DAC clock from an LVDS source with an accompanying LVDS data clock. Since the DAC and data clocks are different types, their phase relationship is difficult to specify.

The AD9725 provides internal circuitry to keep the data from being corrupted over a wide variation in relative phase. Once the DAC and data clocks have been established and synchronization has been initiated, the phase between the two clocks can vary by at least one full clock cycle without loss of data. If the phase relationship between the clocks varies enough to cause a possible loss of data, the AD9725 can be resynchronized in several different ways.

The internal synchronization circuitry in the AD9725 eases this problem by allowing the phase to vary by at least one full clock cycle, once synchronization has been established. It does this by demultiplexing the incoming data stream into four channels, each containing every fourth data word. Each of these words is present for four DAC clock cycles. The data is then remultiplexed by sampling each channel with the appropriate DAC clock cycle.

Initial synchronization is established in one of the following ways:

1. When the RESET pin is asserted, the synchronization logic is initiated to provide optimal internal timing.
2. If SPI_DIS is not asserted, the synchronization is optimized by writing setting SYNC_UPD (02h[1]) high.
3. If SPI_DIS is asserted, the synchronization is optimized by asserting the SYNC_UPD pin.

Once synchronization is established, the AD9725 needs to be reoptimized only if operating conditions change enough to affect the relative phase of the DAC and data clocks by more than one clock cycle. The AD9725 detects when a synchronization update is necessary, and indicates this need by asserting SYNCALRM (02h[0]) or SYNC_ALARM high. If SYNCALRM (02h[0]) or SYNC_ALARM have been asserted, resynchronization can be accomplished as follows:

1. If the synchronization logic is in automatic mode (SYNCMAN (02h[2]) = 0), the synchronization logic will optimize the internal timing as necessary. Two data words will typically be lost or repeated when an optimization occurs. If that possibility could cause serious problems, manual operation may be required.
2. If the synchronization logic is in manual mode (SYNCMAN (02h[2]) = 1), the logic will indicate the need for an update by asserting SYNCALRM (02h[0]) high. In normal operation, a logic high on SYNCALRM (02h[0]) does not mean that data is being lost, but that conditions are close to the point where data may be lost. Optimization should be initiated by setting SYNCUPD (02h[1]) high at a convenient time.
3. Monitoring the synchronization logic state and initiating an update can be done via package pins by setting SPI_DIS high and using the SYNC_ALARM and SYNC_UPD pins in the same way the manual synchronization operation is described in step 2.

Note that SYNCUPD (02h[1]) or SYNC_UPD can be asserted at any time to optimize the synchronization, even if SYNCALRM (02h[0]) or SYNC_ALARM have not indicated that it is necessary.

If either the data clock or the DAC clock is interrupted for any reason, a SYNCUPD or SYNC_UPD should be executed to insure that no subsequent data is lost.

INTERNAL REFERENCE AND FULL-SCALE OUTPUT CURRENT

The AD9725 contains an internal band gap reference of 1.2 V. The reference voltage is applied to an external resistor at FSADJ, and the resultant current is amplified by the reference buffer to provide the full-scale current for the DAC output. The gain equation from the internal reference to the DAC output (assuming the digital inputs are at full scale) is as follows:

$$I_{OUTFS} = 1.2 \times 32/FSADJ$$

Taking into account the state of the digital inputs, the output current of I_{OUTA} and I_{OUTB} at any instant in time is:

$$I_{OUTA} = I_{OUTFS} \times (DB15:DB0)/65536$$

$$I_{OUTB} = I_{OUTFS} \times (1 - DB15:DB0)/65536$$

ANALOG OUTPUT

The analog output of the AD9725 is based around a high dynamic range CMOS DAC core. The output consists of a differential current source capable of up to 20 mA full-scale. The output devices are PMOS and are capable of sourcing current into an output termination within a compliance voltage range of ± 1 V. Excellent distortion, noise, and ACLR performance is achievable to Nyquist at sample rates of 600 MSPS+.

SPI PORT CONTROL

The AD9725 serial port is a flexible, synchronous serial communications port allowing easy interface to many industry standard microcontrollers and microprocessors. The serial I/O is compatible with most synchronous transfer formats, including both the Motorola SPI and Intel SSR protocols. The interface allows read/write access to all registers that configure the AD9725. Single or multiple byte transfers are supported as well as MSB first or LSB first transfer formats. The AD9725 serial interface port can be configured as a single pin I/O (SDIO) or two unidirectional pins for in/out (SDIO/SDO).

GENERAL OPERATION OF THE SERIAL PORT INTERFACE

There are two phases to a communication cycle with the AD9725. Phase 1 is the instruction cycle, which is the writing of an instruction byte into the AD9725, and coincident with the first eight SCLK rising edges. The instruction byte provides the AD9725 serial port controller with information regarding the data transfer cycle, which is Phase 2 of the communication cycle. The Phase 1 instruction byte defines the number of bytes in the data transfer, the starting register address for the first byte of the data transfer, and whether the upcoming data transfer is read or write. The first eight SCLK rising edges of each communication cycle are used to write the instruction byte into the AD9725.

A Logic 1 on the CS pin followed by a Logic 0 will reset the SPI port timing to the initial state of the instruction cycle. This is true regardless of the present state of the internal registers or the other signal levels present at the inputs to the SPI port. If the SPI port is in the midst of an instruction cycle or a data transfer cycle, none of the present data will be written.

The remaining SCLK edges are for Phase 2 of the communication cycle. Phase 2 is the actual data transfer between the AD9725 and the system controller. Phase 2 of the communication cycle is a transfer of 1, 2, 3, or 4 data bytes as determined by the instruction byte. Normally, using one multibyte transfer is the preferred method. However, single byte data transfers are useful to reduce CPU overhead when register access requires 1 byte only. Registers change immediately upon writing to the last bit of each transfer byte.

INSTRUCTION BYTE

The instruction byte contains the information shown in Table 7

Table 7

N1	N0	Description
0	0	Transfer 1 byte
0	1	Transfer 2 byte
1	0	Transfer 3 byte
1	1	Transfer 4 byte

R/W

Bit 7 of the instruction byte determines whether a read or a write data transfer will occur after the instruction byte write. Logic high indicates a read operation. Logic 0 indicates a write operation. N1, N0 -Bits 6 and 5 of the instruction byte determine the number of bytes to be transferred during the data transfer cycle. The bit decodes are shown in the following table:

Table 8

MSB							LSB
I7	I6	I5	I4	I3	I2	I1	I0
R/W	N1	N0	A4	A3	A2	A1	A0

A4, A3, A2, A1, A0

Bits 4, 3, 2, 1, 0 of the instruction byte determine which register is accessed during the data transfer portion of the communications cycle. For multibyte transfers, this address is the starting byte address. The remaining register addresses are generated by the AD9725.

SERIAL PORT INTERFACE PIN DESCRIPTION

SCLK (Serial Clock)

The serial clock pin is used to synchronize data to and from the AD9725, and to run the internal state machines. The SCLK maximum frequency is 15 MHz. All data input to the AD9725 is registered on the rising edge of SCLK. All data is driven out of the AD9725 on the falling edge of SCLK.

CSB (Chip Select)

Active low input starts and gates a communication cycle. It allows more than one device to be used on the same serial communications line. The SDO and SDIO pins will go to a high impedance state when this input is high. Chip select should stay low during the entire communication cycle.

SDIO

Serial data I/O. Data is always written into the AD9725 on this pin. This pin, however, can be used as a bidirectional data line. The configuration of this pin is controlled by Bit 7 of register address 00h. The default is Logic 0, which configures the SDIO pin as unidirectional.

SDO

Serial data out. Data is read from this pin for protocols that use separate lines for transmitting and receiving data. In the case where the AD9725 operates in a single bidirectional I/O mode, this pin does not output data and is set to a high impedance state.

MSB/LSB Transfers

The AD9725 serial port can support both MSB first and LSB first data formats. This functionality is controlled by register address 00h Bit 6. The default is MSB first. When this bit is set to active high, the AD9725 serial port is in LSB first format. That is, if the AD9725 is in LSB first mode, the instruction byte must be written from least significant bit to most significant bit. Multibyte data transfers in MSB format can be completed by writing an instruction byte that includes the register address of the most significant byte. In MSB first mode, the serial port internal byte address generator decrements for each byte required of the multibyte communication cycle. Multibyte data transfers in LSB first format can be completed by writing an instruction byte that includes the register address of the least significant byte. In LSB first mode, the serial port internal byte address generator increments for each byte required of the multibyte communication cycle.

The AD9725 serial port controller address will increment from 1Fh to 00h for multibyte I/O operations if the MSB first mode is active. The serial port controller address will decrement from 00h to 1Fh for multibyte I/O operations if the LSB first mode is active.

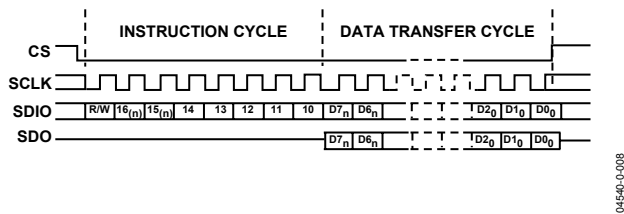

Figure 9. Serial Register Interface Timing MSB First

04540-0-008

NOTES ON SERIAL PORT OPERATION

The AD9725 serial port configuration bits reside in Bit 6 and Bit 7 of register address 00h. It is important to note that the configuration changes immediately upon writing to the last bit of the register. For multibyte transfers, writing to this register may occur during the middle of communication cycle. Care must be taken to compensate for this new configuration for the remaining bytes of the current communication cycle.

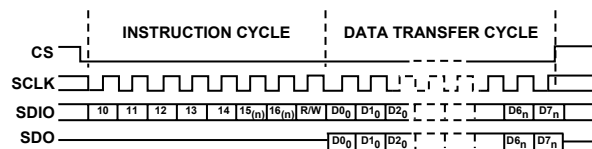

Figure 10. Serial Register Interface Timing LSB First

04540-0-009

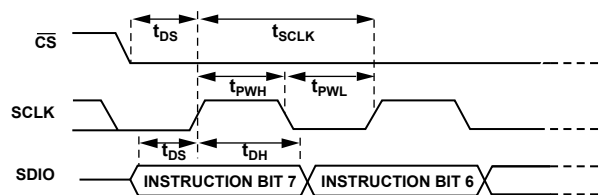

Figure 11. Timing Diagram for Register Write to AD9725

04540-0-010

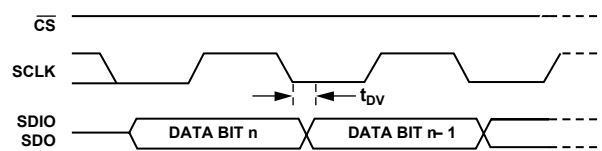

Figure 12. Timing Diagram for Register READ to AD9725

04540-0-011

The same considerations apply to setting the reset bit in register address 00h. All other registers are set to their default values, but the software reset doesn't affect the bits in register address 00h.

It is recommended to use only single byte transfers when changing serial port configurations or initiating a software reset.

OUTLINE DIMENSION

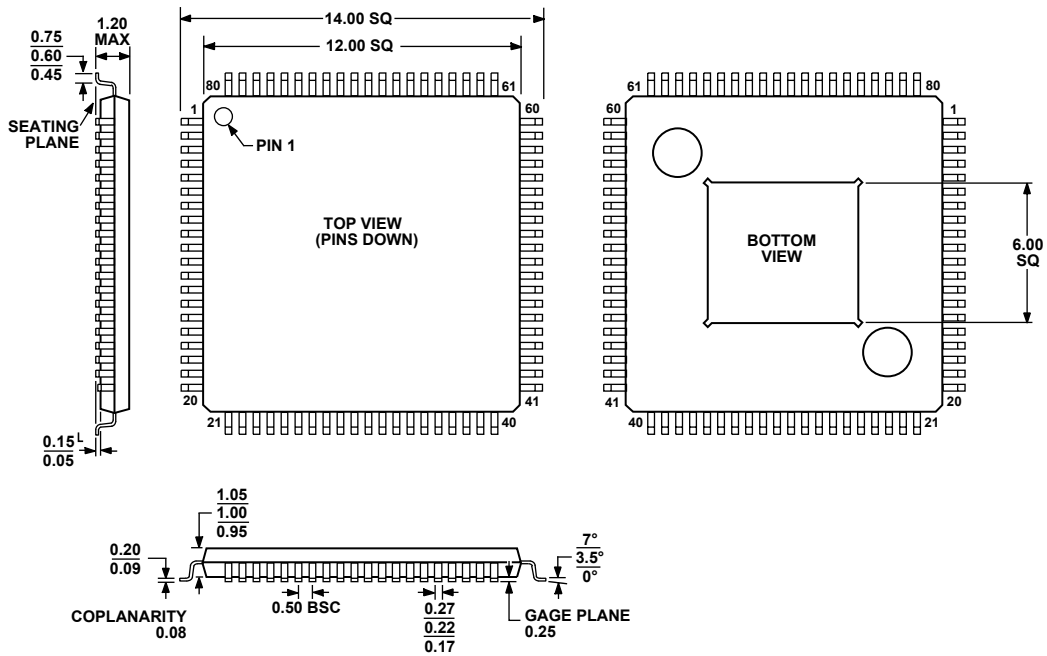

COMPLIANT TO JEDEC STANDARDS MS-026-ADD-HD

Figure 13. 80-Lead Thin Plastic Quad Flat Package, Exposed Pad [TQFP/ED] (SV-80)
Dimensions shown in millimeters

ORDERING GUIDE

Model	Temperature Range	Package Description	Package Option
AD9725BSV	-40°C to +85°C	80 Lead TQFP	SV-80

THERMAL CHARACTERISTICS

Thermal Resistance

80-Lead Thermally Enhanced
TQFP Package $\theta_{JA} = 23.5^\circ\text{C}/\text{W}^*$

*With thermal pad soldered to PCB.