

### Evaluating the **ADAU1962/ADAU1966** High Performance, Low Power, Multibit Sigma-Delta DACs

#### PACKAGE CONTENTS

- ADAU1962/ADAU1966** evaluation board
- USBi control interface board
- USB cable
- D-sub 25-pin to (8) XLR male
- 12 V desktop supply

#### OTHER SUPPORTING DOCUMENTATION

- ADAU1962** data sheet
- ADAU1966** data sheet

#### EVALUATION BOARD OVERVIEW

This user guide details the design and setup of the evaluation board for the **ADAU1962/ADAU1966**. Because the **ADAU1962** is a 12-channel device and the **ADAU1966** is a 16-channel device, the DAC 13 through DAC 16 outputs do not function on the **ADAU1962** evaluation board. The evaluation board must be connected to an external 12 V dc power supply and ground; the board draws approximately 150 mA.

On-board regulators derive 9 V, 5 V, and 3.3 V supplies for the **ADAU1962/ADAU1966** and peripherals. The **ADAU1962/ADAU1966** can be controlled through either an I<sup>2</sup>C or SPI interface. A small external interface board, **EVAL-ADUSB2EBZ**, also called an USBi, connects to a PC USB port and provides either I<sup>2</sup>C or SPI access to the evaluation board through a ribbon cable. A graphical user interface (GUI) program, the Automated Register Window Builder, is provided for easy programming of the chip in a Microsoft® Windows® PC environment. The evaluation board allows demonstration and performance testing of most **ADAU1962/ADAU1966** features, including high performance digital-to-analog converter (DAC) operation.

The board has an S/PDIF receiver with RCA and optical connectors, as well as a discrete serial audio interface that is available on the Analog Devices, Inc. system development platform (SDP) interface. Analog outputs are accessible with two D-sub, 25-pin connectors using the professional audio standard. A single D-sub, 25-pin to XLR male cable is included with the board for connecting individual DAC channels to an audio system.

#### EVALUATION BOARD DIAGRAM

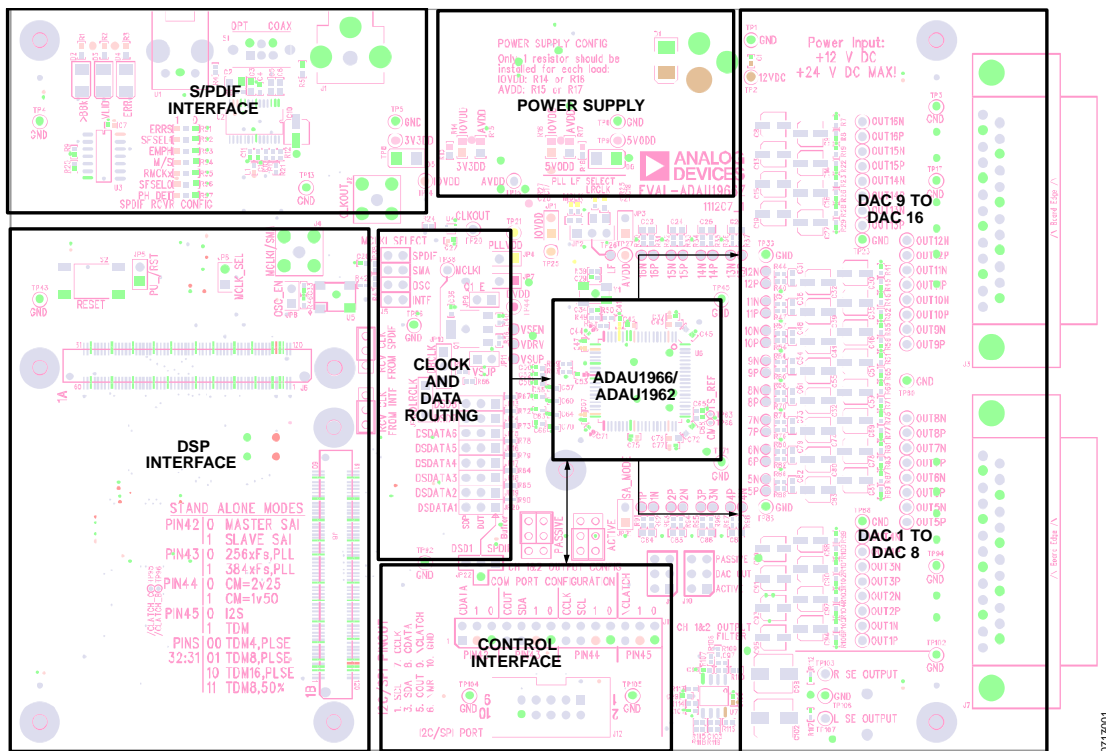

Figure 1.

**TABLE OF CONTENTS**

Package Contents.....	1	Powering the Board.....	5
Other Supporting Documentation.....	1	Reset for the Evaluation Board.....	5
Evaluation Board Overview.....	1	Setting Up the Master Clock (MCLK).....	6
Evaluation Board Diagram.....	1	Crystal Operation.....	6
Revision History.....	2	PLL Selection.....	7
Setting Up the Evaluation Board.....	3	Digital Audio Connections and Routing.....	7
Standalone Mode.....	3	Connecting Analog Audio Cables.....	8
I <sup>2</sup> C and SPI Control.....	4	Using the ADAU1962/ADAU1966.....	8
Automated Register Window Builder Software Installation ..	4	Schematics and Artwork.....	9
Hardware Setup—USBi.....	4		

**REVISION HISTORY**

**1/14—Rev. 0 to Rev. A**

Added ADAU1962..... Universal  
 Changes to Evaluation Board Overview Section and Figure 1 .. 1

**5/12—Revision 0: Initial Version**

# SETTING UP THE EVALUATION BOARD

## STANDALONE MODE

The ADAU1962/ADAU1966 have a standalone mode that allows the user to choose between a limited number of operation modes without the need for a control interface. Applying a jumper across JP21, as shown in Figure 2, pulls SA\_MODE (Pin 46) high, enabling the standalone mode in the ADAU1962/ADAU1966. The SA\_MODE selections are listed in Table 1.

**Table 1. Standalone Modes**

Pin(s)	Jumper Setting	Description
42	0	Serial audio interface, master mode
	1	Serial audio interface, slave mode
43	0	MCLK select: $256 \times f_s$ , PLL
	1	MCLK select: $384 \times f_s$ , PLL
44	0	CM = 2.25 V (for AVDD = 5 V)
	1	CM = 1.50 V (for AVDD = 3.3 V)
45	0	Serial audio interface, I <sup>2</sup> S mode
	1	Serial audio interface, TDM mode
32:31	00	TDM4, pulse
	01	TDM8, pulse
	10	TDM16, pulse
	11	TDM8, 50% duty

On the ADAU1962/ADAU1966 evaluation board, each of the four ADAU1962/ADAU1966 control port pins is brought to a block of jumpers, allowing each pin to be assigned to either the I<sup>2</sup>C port or the SPI port. In standalone mode, these jumpers can connect the individual pins to high or low to put the ADAU1962/ADAU1966 in the desired mode.

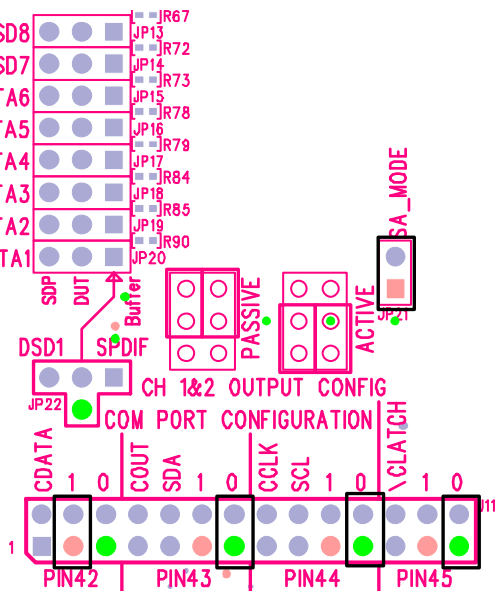

Figure 2. SA\_MODE—Slave,  $256 \times f_s$ , CM = 2.25 V, I<sup>2</sup>S

The ADAU1962/ADAU1966 evaluation board arrives configured for S/PDIF input. The S/PDIF receiver operates as a clock master, putting out an I<sup>2</sup>S stream at  $256 \times f_s$ . For a quick startup, the ADAU1962/ADAU1966 are in standalone mode with the settings shown in Figure 2. Pin 42 is pulled high (1) and Pin 43 to Pin 45 are pulled low (0). According to Table 1, this puts the ADAU1962/ADAU1966 in slave mode, running at  $256 \times f_s$ , while common mode (CM) is set to 2.25 V and the audio serial port is in I<sup>2</sup>S mode. Notice in Figure 2 that the jumper for Pin 42 is assigned to 1 and that the other pins are assigned to 0.

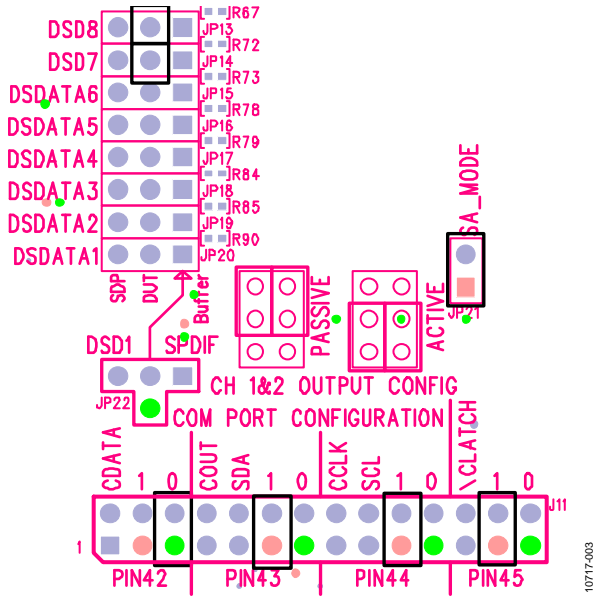

Figure 3. SA\_MODE—Master,  $384 \times f_s$ , CM = 1.50 V, TDM

Figure 3 shows the other options for each SA\_MODE configuration pin; master mode, running at  $384 \times f_s$ , CM set to 1.50 V, and the audio serial port in TDM mode. In the case where the ADAU1962/ADAU1966 are put in TDM mode, Pin 31 and Pin 32 can be pulled high or low to achieve the modes listed in Table 1. The correct pins are outlined in the top left corner of Figure 3, as DSD8 and DSD7.

I<sup>2</sup>C AND SPI CONTROL

The evaluation board can be configured for live control over the registers in the [ADAU1962/ADAU1966](#). When the **Automated Register Window Builder** software is installed and the USBi control interface is plugged into the board, the software can control the [ADAU1962/ADAU1966](#). For this configuration, the [ADAU1962/ADAU1966](#) must be assigned to I<sup>2</sup>C mode using Address 00. See Figure 4 for the correct jumper positions.

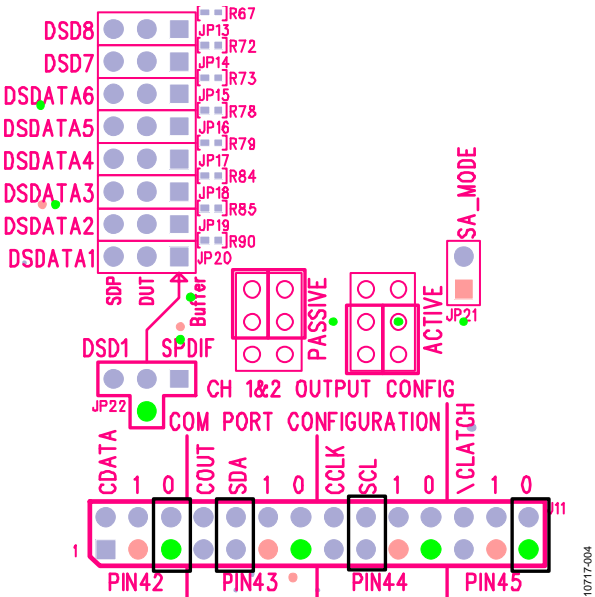

Figure 4. ADAU1962/ADAU1966 I<sup>2</sup>C Control, Address 00

The **Automated Register Window Builder** controls the [ADAU1962/ADAU1966](#) and is available for download under the **Tools, Software, & Simulation Models** section of the [ADAU1962](#) and [ADAU1966](#) product pages.

In addition, the [ADAU1962/ADAU1966](#) can be put into SPI mode for control by other means. See Figure 5 for the correct jumper positions.

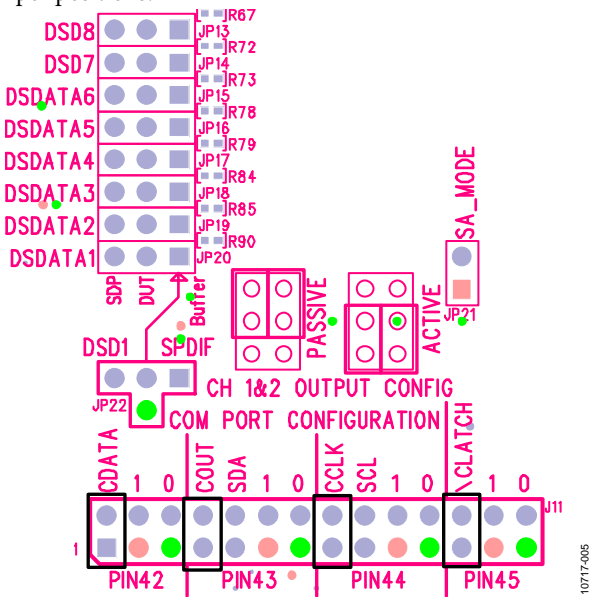

Figure 5. ADAU1962/ADAU1966 SPI Control

**AUTOMATED REGISTER WINDOW BUILDER SOFTWARE INSTALLATION**

The **Automated Register Window Builder** is a program that launches a graphical interface for direct, live control of the [ADAU1962/ADAU1966](#) registers. The GUI content for a specific part is defined in a part-specific .xml file; these files are included in the software installation. To install the **Automated Register Window Builder** software, follow these steps:

1. Go to the [ADAU1962](#) and [ADAU1966](#) product pages and download the 64-Bit OS (ARWB\_64BIT.zip) or 32-Bit OS (ARWB\_32Bit.zip) file, which can be found under the **Tools, Software, & Simulation Models** section of the [ADAU1962](#) and [ADAU1966](#) product pages.
2. Open the downloaded.zip file and extract the files to an empty folder on your PC.
3. Install the **Automated Register Window Builder** by double-clicking **setup.exe** and following the prompts. A computer restart is not required.
4. Copy the .xml file for the [ADAU1962/ADAU1966](#) from the extraction folder into the **C:\ProgramFiles\Analog Devices Inc\AutomatedRegWin** folder, if it is not already installed.

**HARDWARE SETUP—USBi**

To set up the USBi hardware, follow these steps:

1. Plug the USBi ribbon cable into J12, the I<sup>2</sup>C/SPI port.
2. Connect the USB cable to the PC and to the USBi.
3. When prompted for drivers, follow these steps:
  - a. Choose **Install from a list or a specific location**.
  - b. Choose **Search for the best driver in these locations**.
  - c. Check the box for **Include this location in the search**.
  - d. Find the USBi driver **C:\Program Files\Analog Devices Inc\AutomatedRegWin\USB drivers**.
  - e. Click **Next**.
  - f. If prompted to choose a driver, select **CyUSB.sys**.
  - g. If the PC is running Windows XP and a message appears saying that the software has not passed Windows logo testing, click **Continue Anyway**.
4. Open the **Automated Register Window Builder** application and load the .xml file for the part on the evaluation board. Plug the 10-way ribbon cable on the USBi into the I<sup>2</sup>C/SPI port (J12) on the evaluation board.

**POWERING THE BOARD**

The ADAU1962/ADAU1966 evaluation board requires a power supply input of 12 V dc and ground to the power jack; 12 V draws ~150 mA at higher sample rates with all channels running. The on-board regulators provide 9.0 V, 5.0 V, and 3.3 V rails. The 9.0 V rail is derived from 12 V by a linear regulator; it provides voltage to the audio op amp in the active output filter for Channel 1 and Channel 2. The 5.0 V rail is derived from 12 V by a switching regulator; it can supply AVDD as well as IOVDD for the ADAU1962/ADAU1966 and other peripherals. The 3.3 V rail is derived from the 5.0 V supply by an LDO linear regulator; it provides voltage to AVDD and IOVDD as well as other active peripherals.

AVDD and IOVDD are selected on the board using 0 Ω, 0805 package resistors. Install only one resistor for each load, AVDD and IOVDD, as described in Figure 6. Figure 6 shows AVDD fed from 5.0 V and IOVDD fed from 3.3 V.

**POWER SUPPLY CONFIG**

Only 1 resistor should be installed for each load:  
 IOVDD: R14 or R16  
 AVDD: R15 or R17

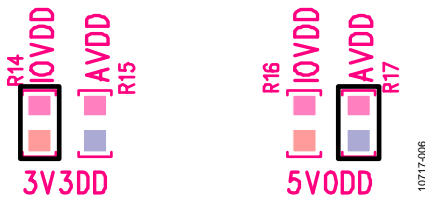

Figure 6. AVDD and IOVDD Selection Resistors

The ADAU1962/ADAU1966 have an internal voltage regulator that allows the user to derive DVDD and PLLVDD from the AVDD voltage source. The external PNP transistor, Q1, and passives, C36, C40 and R56, make the regulator circuit shown in Figure 7. Short both JP9 and JP11 to activate the circuit; JP9 supplies the emitter of the PNP, and JP11 powers the VSUPPLY pin (Pin 25) on the ADAU1962/ADAU1966.

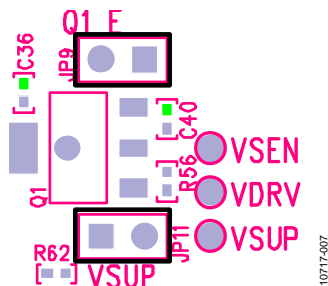

Figure 7. ADAU1962/ADAU1966 Internal Regulator Jumpers

Links are provided along each ADAU1962/ADAU1966 power rail to give access for current measurement (see Figure 8). These links also allow directly supplying voltage from an outside source.

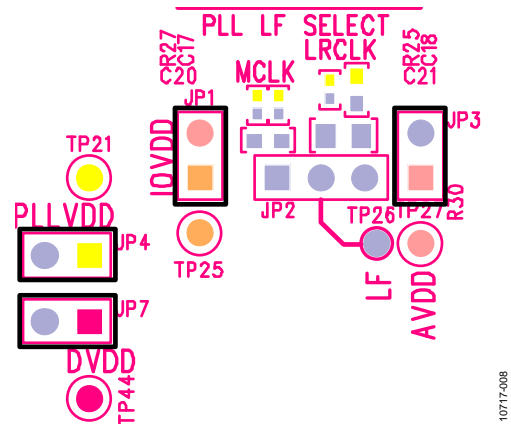

Figure 8. ADAU1962/ADAU1966 Power Links

**RESET FOR THE EVALUATION BOARD**

The ADAU1962/ADAU1966 evaluation board has provision for resetting and powering down the ADAU1962/ADAU1966. S2 on the evaluation board, shown in Figure 9, is a momentary reset switch that pulls the master reset (MR) line low; this line controls the reset generator U10. MR is also connected to the USBi and SDP INTF connectors through steering diodes and protection resistors so that outside devices can control the reset state of the evaluation board, as shown in Figure 26. The power down jumper, JP5, allows the MR line to be tied low. The output of the reset generator drives the PU\_/RST line.

The PU\_/RST line is directly connected to two devices: the S/PDIF receiver and the ADAU1962/ADAU1966. A pull-down resistor holds the line low until the reset generator, U10, asserts the line high, as shown in Figure 26. The PU\_/RST line is also connected to a pin on the SDP INTF through a steering diode and protection resistor, allowing external reset control.

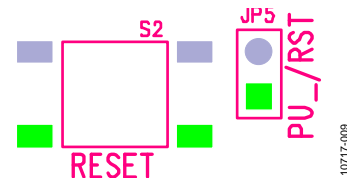

Figure 9. RESET Switch and Power-Down Jumper

### SETTING UP THE MASTER CLOCK (MCLK)

The MCLK routing on the evaluation board is handled by a block of jumpers, J5, allowing any one of four sources to be selected: SPDIF, SMA connector, active OSC, and INTF connector. The board comes with SPDIF selected, as shown in Figure 10.

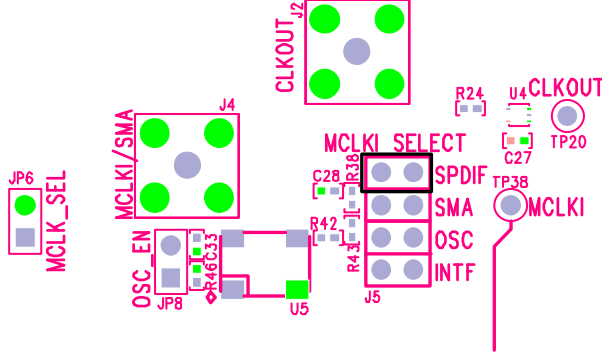

Figure 10. SPDIF Selected as MCLK Source

The evaluation board has a 12.288 MHz active oscillator that can be selected by shorting the OSC\_EN jumper, JP8, and selecting OSC on J5, as shown in Figure 11.

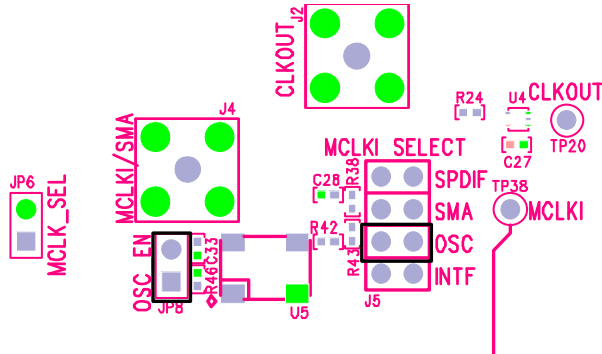

Figure 11. Active OSC-Enabled and Selected as MCLK

When using the SDP interface to add serial audio onto the evaluation board, MCLK can either be supplied by the SDP board, or it can be supplied by the MCLKO pin of the ADAU1962/ADAU1966.

To route MCLK from the SDP interface to the ADAU1962/ADAU1966, apply a shorting jumper across JP6 (MCLK\_SEL), as shown in Figure 12; this sets the direction of the level translators on the board to receive an MCLK signal from the SDP interface, EI3 1A, Pin 119 (EI3\_MCLK), as shown in Figure 28. Next, select INTF on JP5 to route the output of the MCLK level translator to the MCLKI pin of the ADAU1962/ADAU1966.

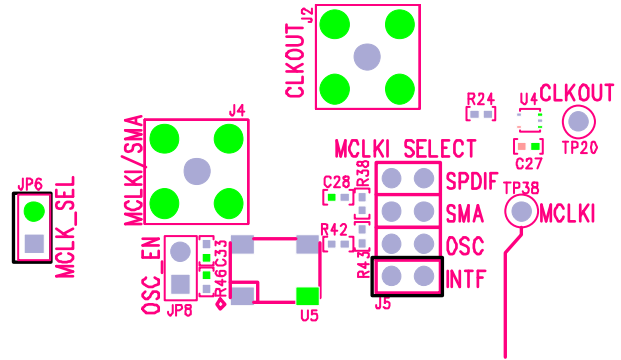

Figure 12. INTF Input Enabled and Selected

To route MCLK from the ADAU1962/ADAU1966 to the SDP interface, remove the shorting jumper from JP6 (MCLK\_SEL); this changes the direction of the level translators and feeds a buffered version of the MCLKO signal from the ADAU1962/ADAU1966 to the EI3\_MCLK pin on the SDP interface.

### CRYSTAL OPERATION

The ADAU1962/ADAU1966 evaluation board is shipped without R49 on the board, effectively disabling the crystal circuit. For operation with a crystal, install a 150 Ω, 0402 resistor and remove any jumpers from J5. For permanent use of the crystal, remove the 0 Ω resistor, R39.

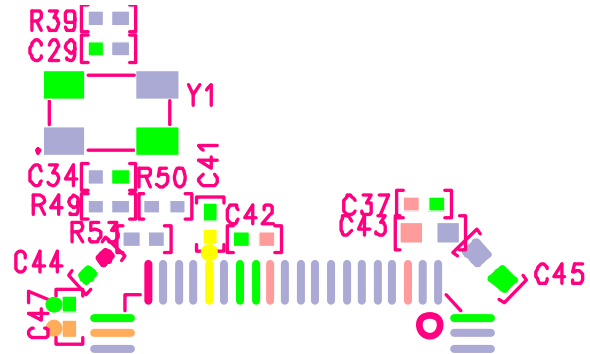

Figure 13. Crystal Circuit Near ADAU1962/ADAU1966

10717-010

10717-011

10717-012

10717-013

**PLL SELECTION**

The PLL in the ADAU1962/ADAU1966 is very flexible, allowing the part to run from a wide range of either MCLK or LRCLK frequencies. It is also possible to shut the PLL off altogether and use the part in direct MCLK mode; functionality with no PLL is limited to  $256 \times f_s$ .

By default, the ADAU1962/ADAU1966 run from the PLL using MCLK as the clock source. The MCLK loop filter must be selected using JP2, as shown in Figure 14.

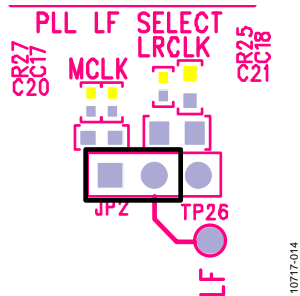

Figure 14. MCLK Selection for PLL Loop Filter

DLRCLK can be selected as the PLL clock source using the PLL and Clock Control Register 0, Register 0x00, Bits[7:6]. In this case, the LRCLK loop filter must be selected, as shown in Figure 15. If DLRCLK is selected as the PLL clock, there is no need for an MCLK signal.

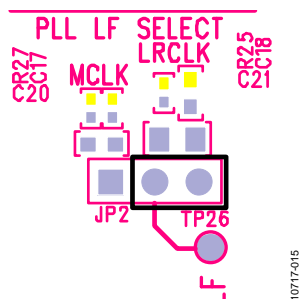

Figure 15. LRCLK Selection for PLL Loop Filter

**DIGITAL AUDIO CONNECTIONS AND ROUTING**

The ADAU1962/ADAU1966 evaluation board has two separate inputs for digital audio signals: S/PDIF and SDP interface.

The S/PDIF receiver can handle either of two options: COAX uses the RCA jack, J1, and OPT uses the Toslink jack, U1. The S/PDIF input is selected using S1, as shown in Figure 16.

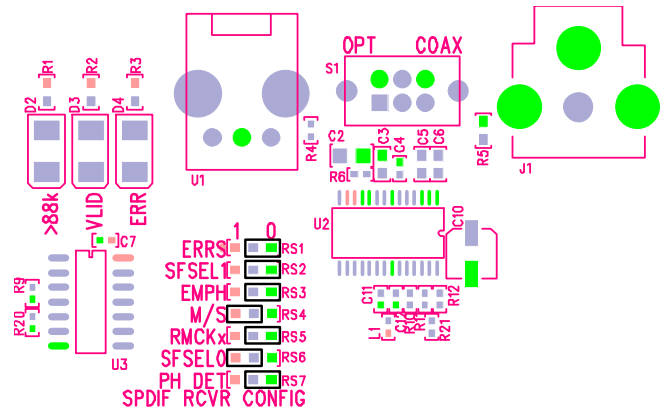

Figure 16. S/PDIF Input Selector Switch, SW1

A series of resistors is provided to set the functional mode of the S/PDIF receiver. By default, the S/PDIF receiver runs in master mode,  $256 \times f_s$ , I<sup>2</sup>S format; consult the data sheet for the S/PDIF receiver to make changes to the hardware mode.

The jumpers shown in Figure 17 are set for the S/PDIF receiver to drive the DBCLK and DLRCLK clock ports and the eight DSDATAx lines of the ADAU1962/ADAU1966. JP22 selects the input to the buffer; the output of this buffer shows up on the right-hand column of JP13 to JP20. The pins in the middle column of these jumpers are connected to the DSDATAx pins of the ADAU1962/ADAU1966 through the appropriate line termination. DBCLK and DLRCLK selections are made with JP10 and JP12, respectively, where the middle pins are connected to the DBCLK and DLRCLK pins of the ADAU1962/ADAU1966.

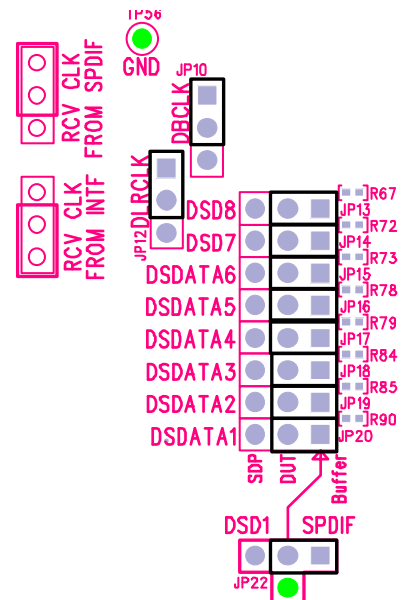

Figure 17. S/PDIF Data and Clock Routing

The SDP interface, J6 and J8, make up a standard interconnect within Analog Devices. They provide for transfer of digital audio, clocks, and control between boards. For additional information, see the pinout included in the schematic in Figure 28.

Figure 18 shows the jumpers configuration for using the SDP interface connector as the digital audio source. JP22 is set so that the DSDATA1 source from the SDP interface is driving the buffer, and this buffer is connected to all eight/six DSDATAx inputs of the ADAU1962/ADAU1966. JP10 and JP12 are set for the ADAU1962/ADAU1966 to run in slave mode from clocks supplied by the SDP interface.

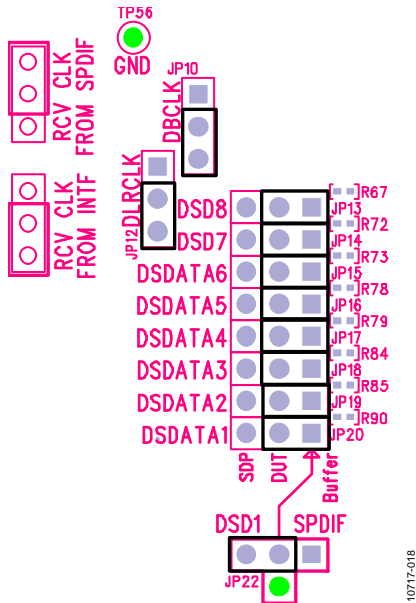

Figure 18. SDP Interface DSDATA1 Distribution

**CONNECTING ANALOG AUDIO CABLES**

There are two forms of the analog outputs of the ADAU1962/ADAU1966 evaluation board: differential outputs and single-ended outputs.

The differential outputs appear on through hole test points as well as on 25-way, female D-sub connectors. The pinout of these D-sub connectors follows the professional audio standard for eight differential signals on a single jack. A single 25-pin male D-sub to XLR male harness has been provided for testing and evaluation purposes. These cables are widely available on the open market.

The differential outputs of the ADAU1962/ADAU1966 drive the connectors directly through a simple 1-pole RC filter and appropriate ac coupling.

Channel 1 and Channel 2 are also available as single-ended outputs on a stereo, 3.5 mm stereo jack, J14. The J9 and J10 jumpers assign the differential outputs of the DAC to either the passive differential output or the active single-ended filter.

Figure 19 shows J9 and J10 set for the passive differential output available on the D-sub connector.

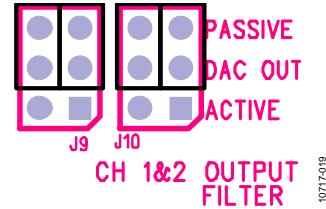

Figure 19. Channel 1 and Channel 2 in Passive Differential Output Mode

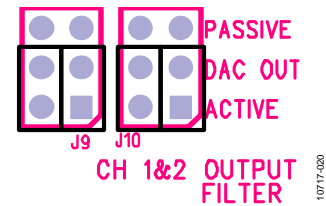

Figure 20. Channel 1 and Channel 2 in Active Single-Ended Output Mode

Figure 20 shows J9 and J10 set for the active single-ended output available on the 3.5 mm TRS connector, J14.

**USING THE ADAU1962/ADAU1966**

When the ADAU1962/ADAU1966 start in standalone mode, it is operational upon power up.

If the ADAU1962/ADAU1966 are not powered up in standalone mode, the USBi must be connected to set the appropriate registers to make the part operational. First, the ADAU1962/ADAU1966 must be activated using the PLL and Clock Control 0 register (Address 0x00) by setting the PUP bit (Bit 0) to 1 for master power-up. Next, using the DAC Control 0 register (Address 0x06) set the MMUTE bit (Bit 0) to 0 for normal operation. The ADAU1962/ADAU1966 now pass audio in its default mode: I<sup>2</sup>S, 256 × f<sub>s</sub>, slave mode, and CM = 2.25 V.

If different settings are desired, it is recommended to program the custom settings before unmuting the part.



**SCHEMATICS AND ARTWORK**

10717-021

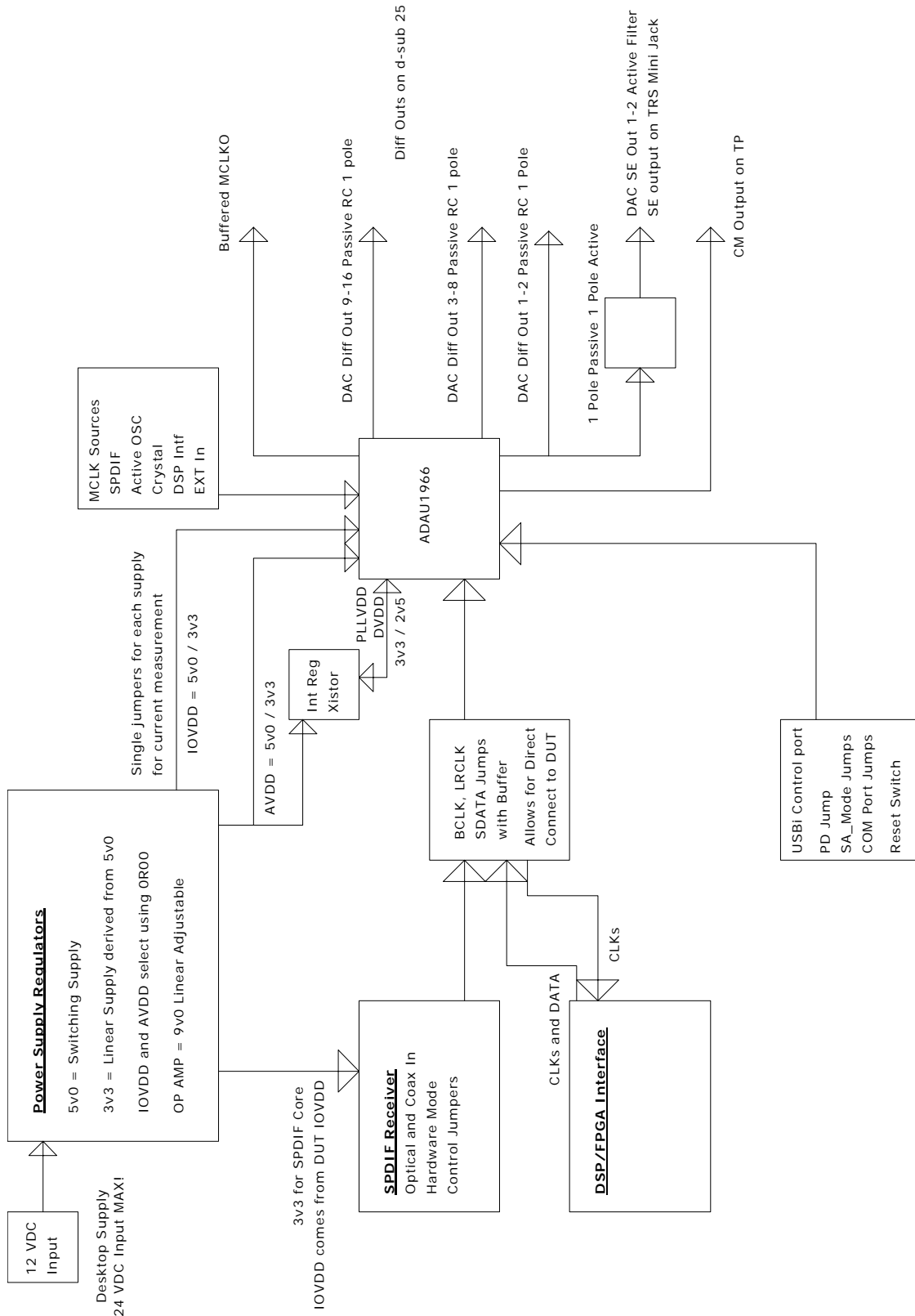

Figure 21. ADAU1962/ADAU1966 Evaluation Board Block Diagram Schematic, Page 1





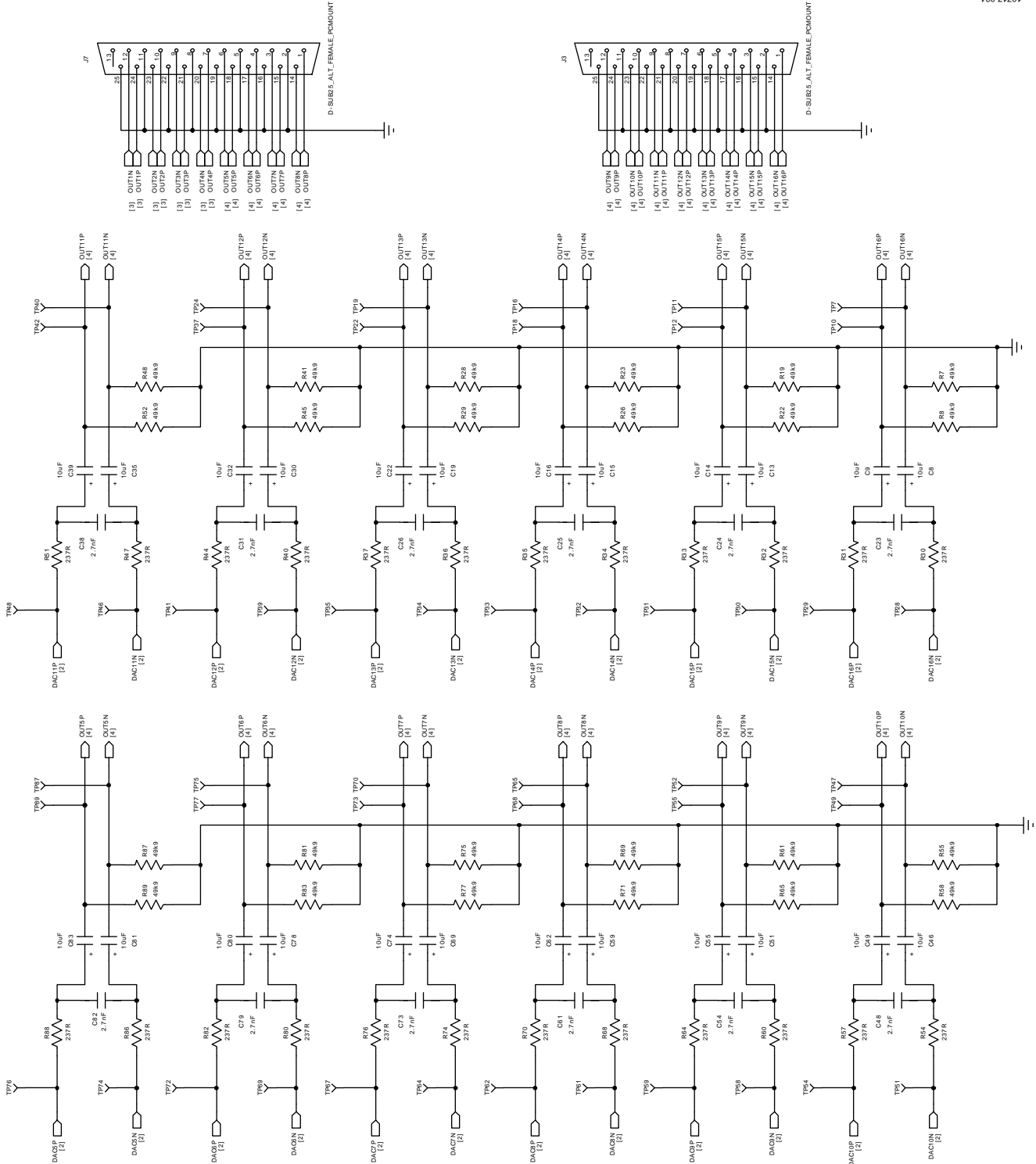

Figure 24. ADAU1962/ADAU1966 Evaluation Board, RC Output Filters and D-Sub 25-Pin Connectors Schematic, Page 4

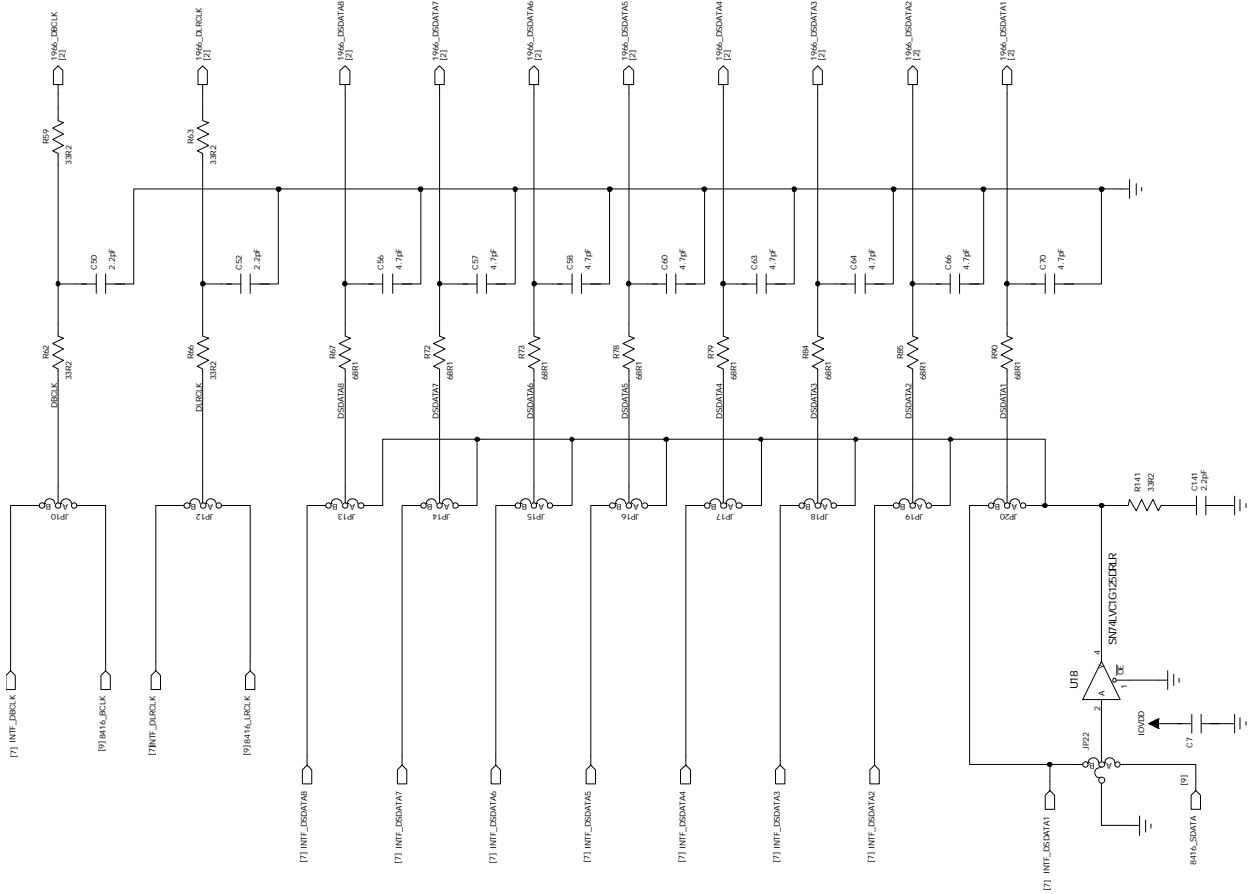

Figure 25. ADAU1962/ADAU1966 Evaluation Board, BCLK, LRLCK, and SDATA Jumpers and Routing Schematic, Page 5

10717-026

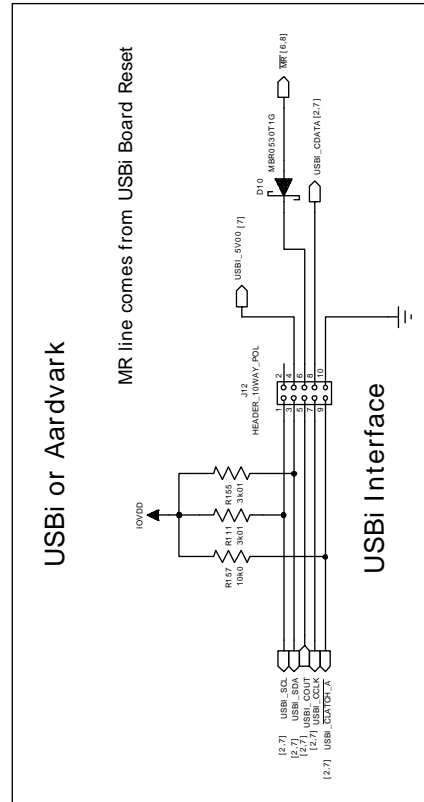
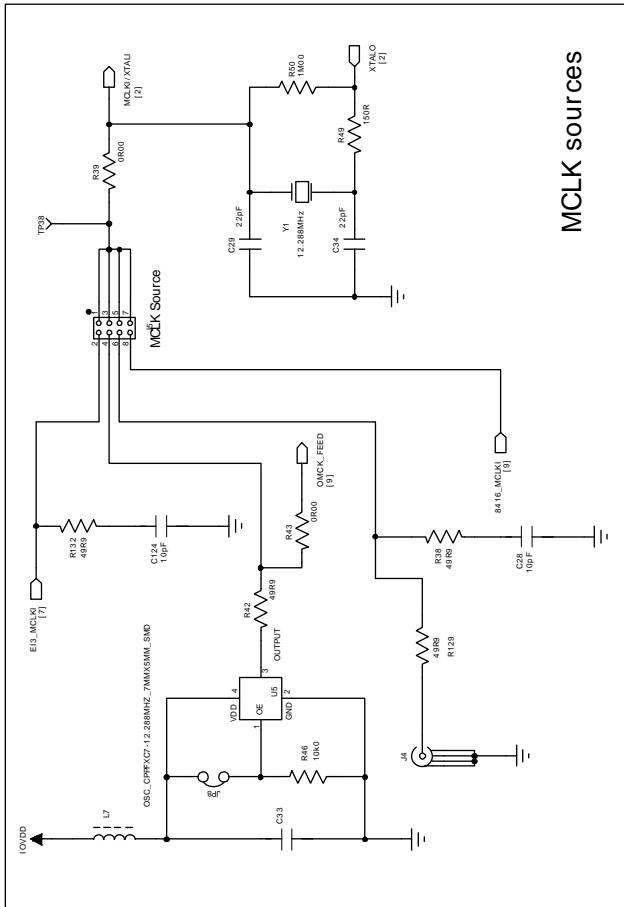
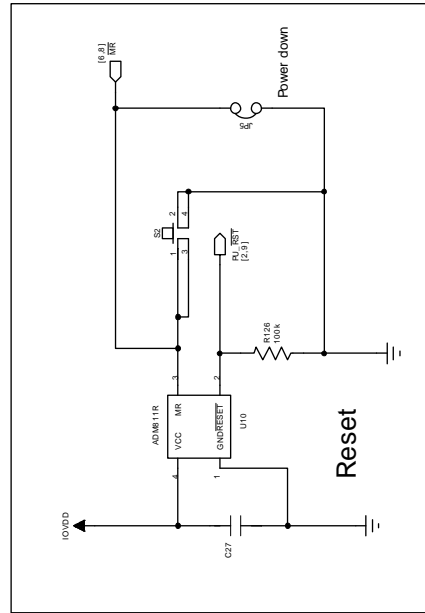
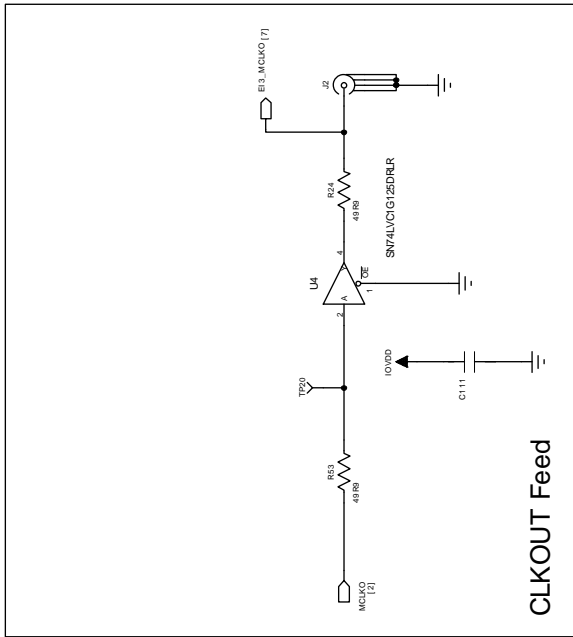

Figure 26. ADAU1962/ADAU1966 Evaluation Board, MCLK Source, USBi Interface, CLKOUT Feed, and Reset Generator Schematic, Page 6

10717-027

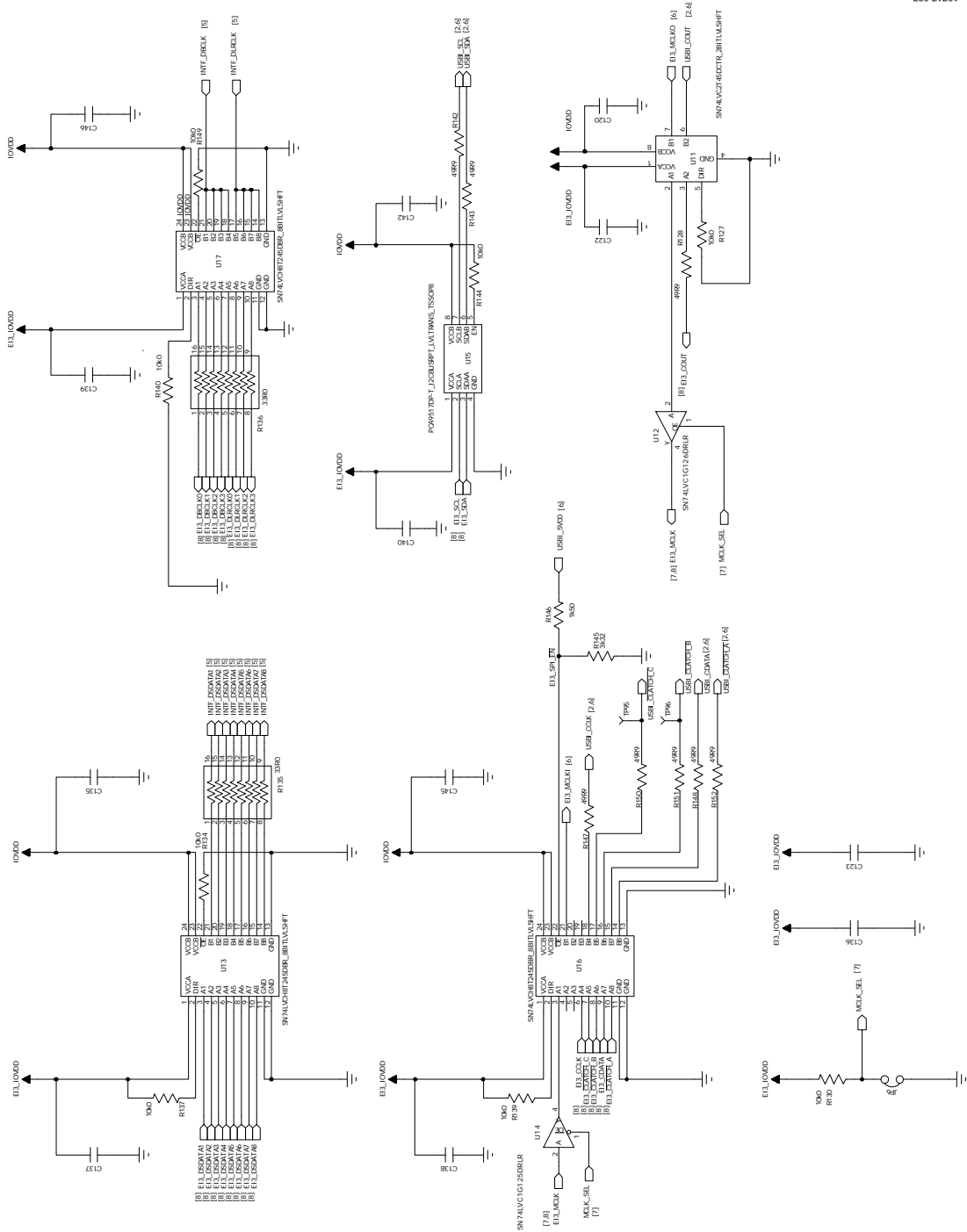

Figure 27. ADAU1962/ADAU166 Evaluation Board, Level Shift and Clock Direction Control Schematic, Page 7





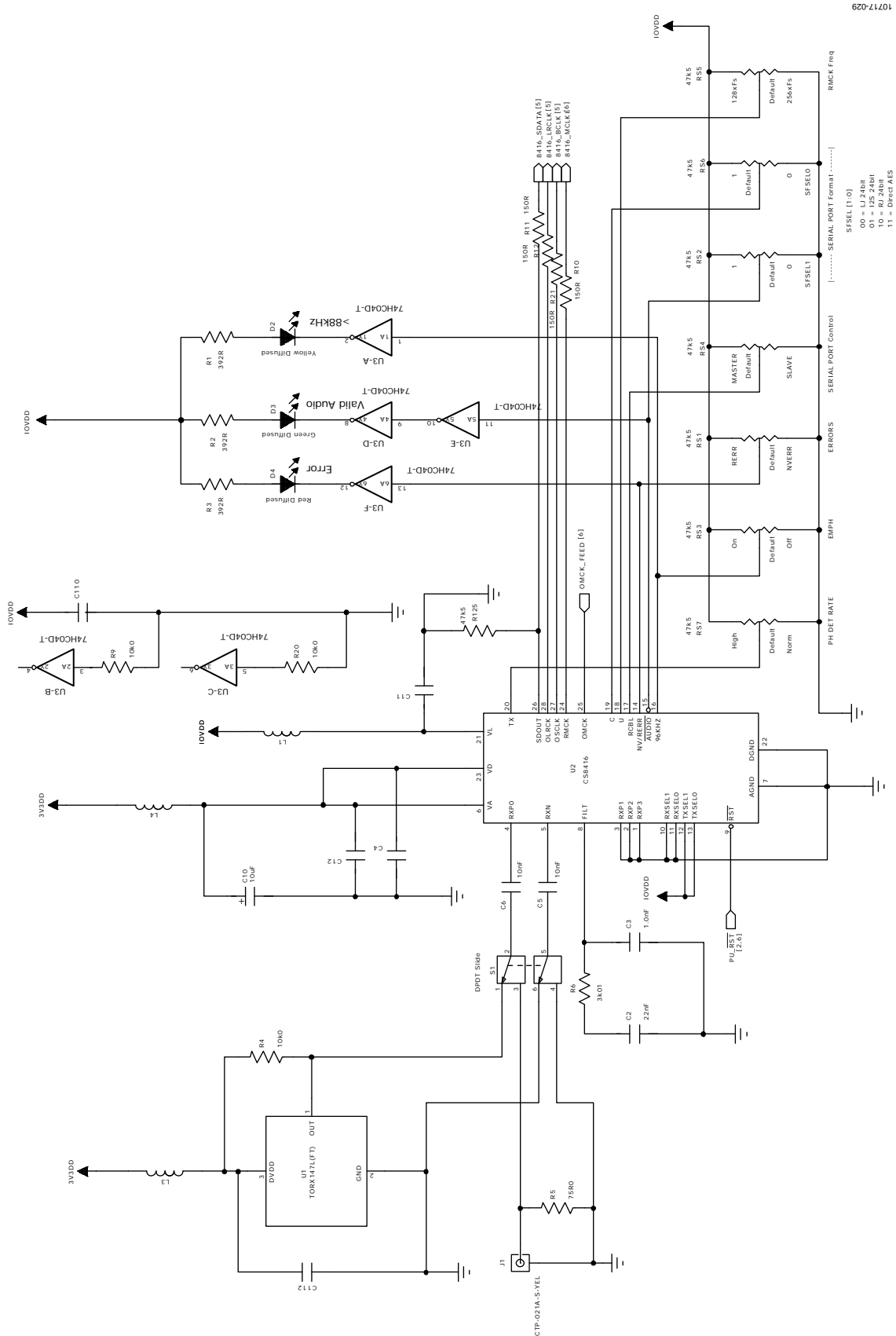

Figure 29. ADAU1962/ADAU1966 Evaluation Board, S/PDIF Receiver Schematic, Page 9

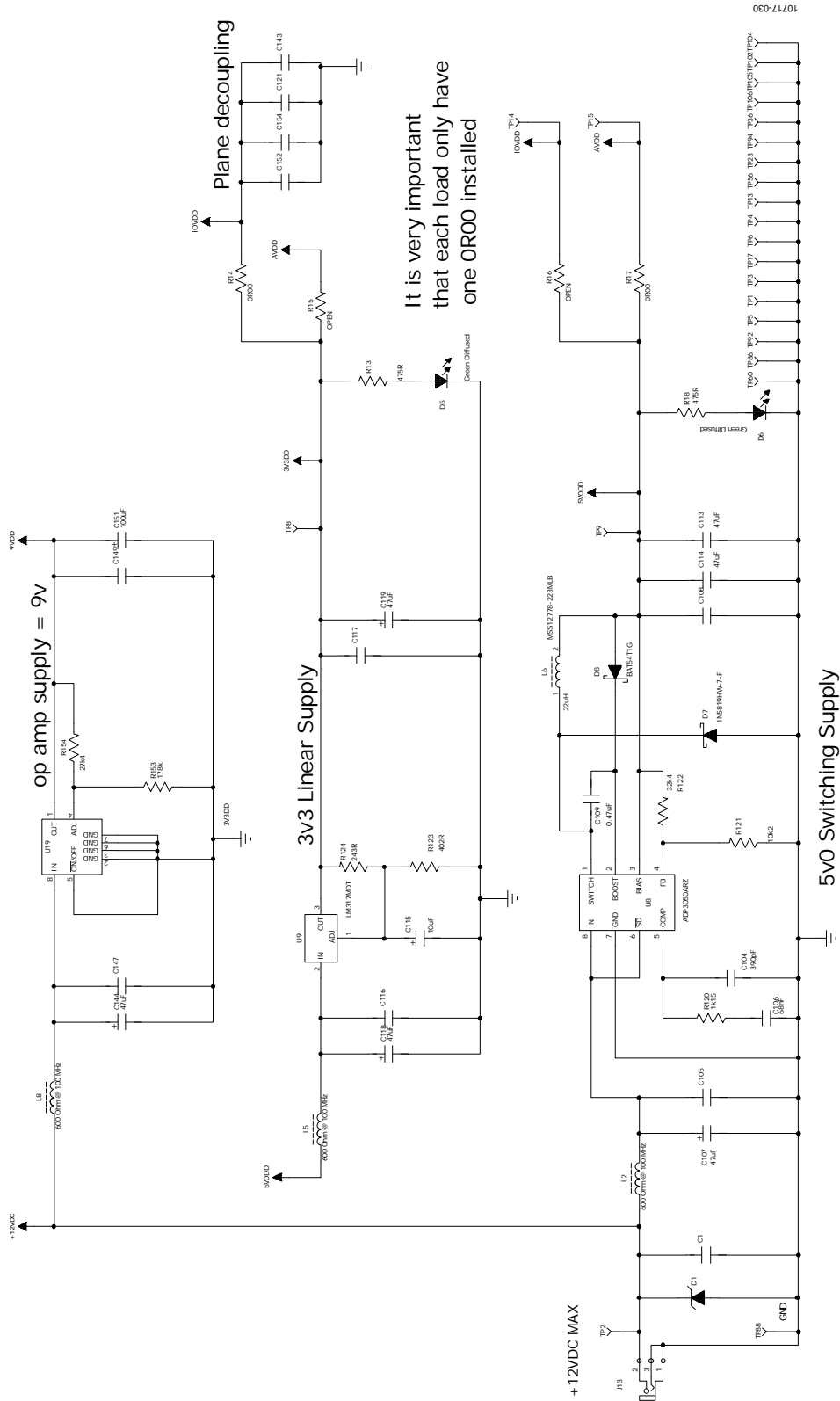
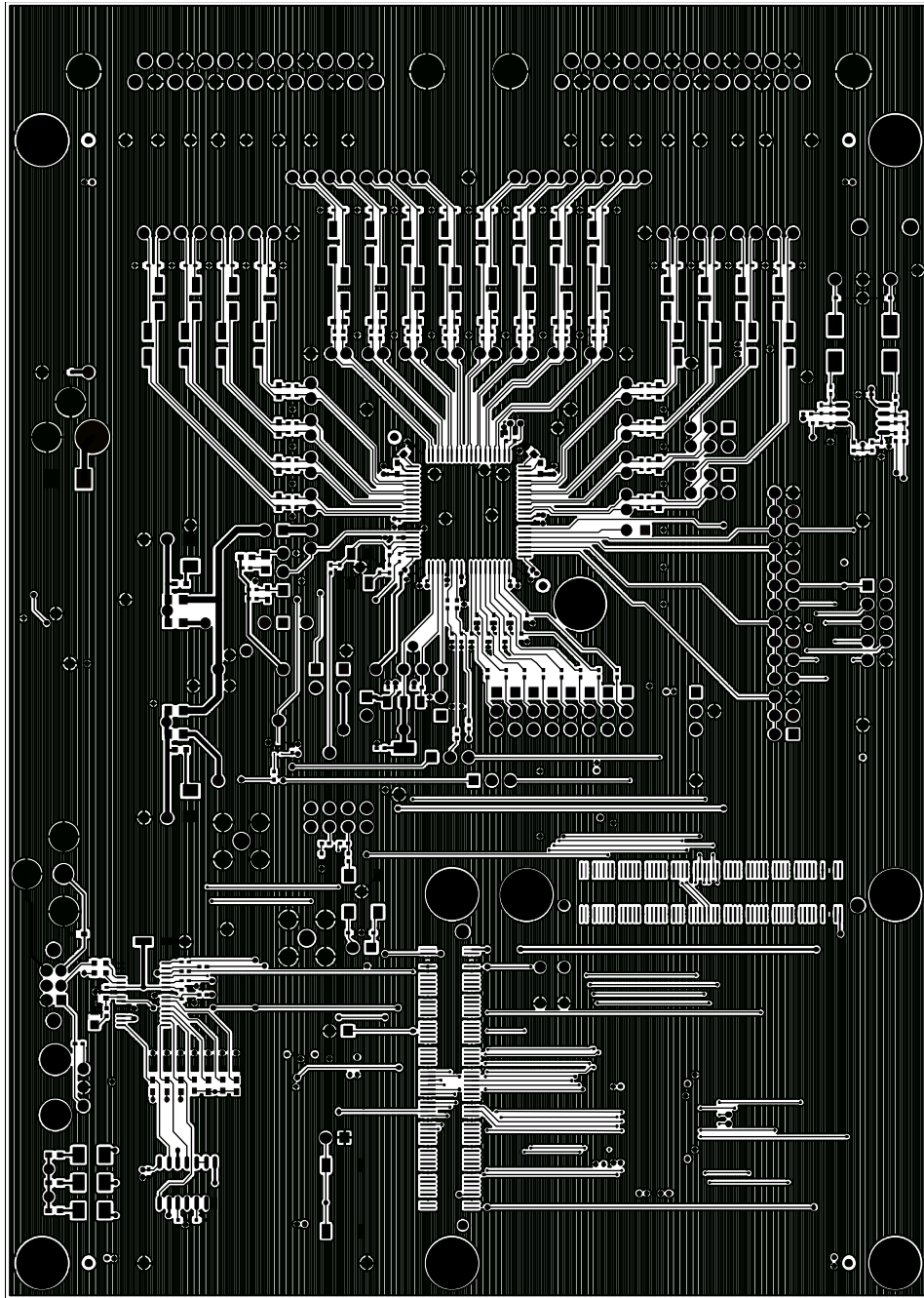

Figure 30. ADAU1962/ADAU1966 Evaluation Board, Power Supply Schematic, Page 10





10717-032

Figure 32. ADAU1962/ADAU1966 Evaluation Board, Top Layer Copper

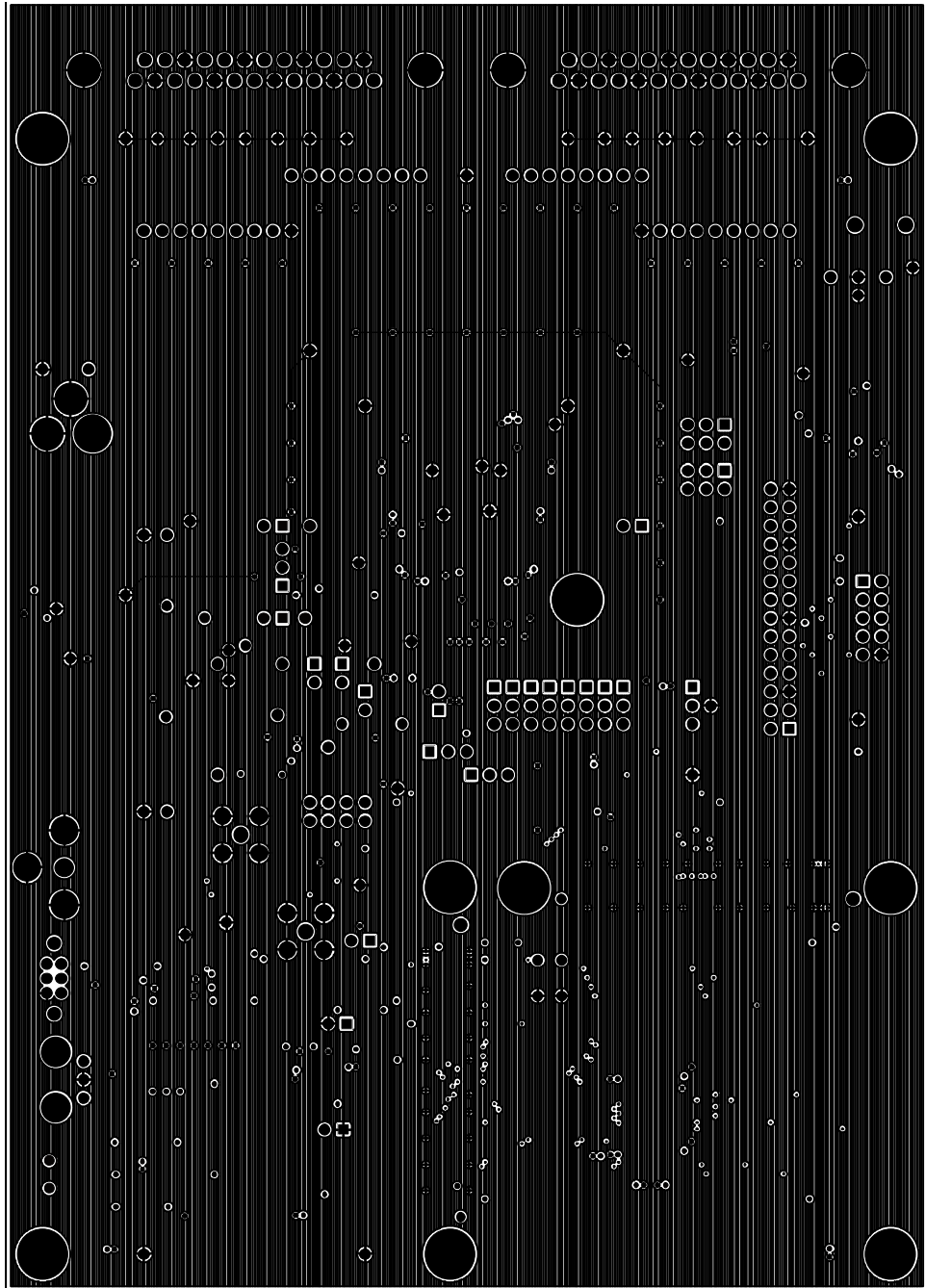
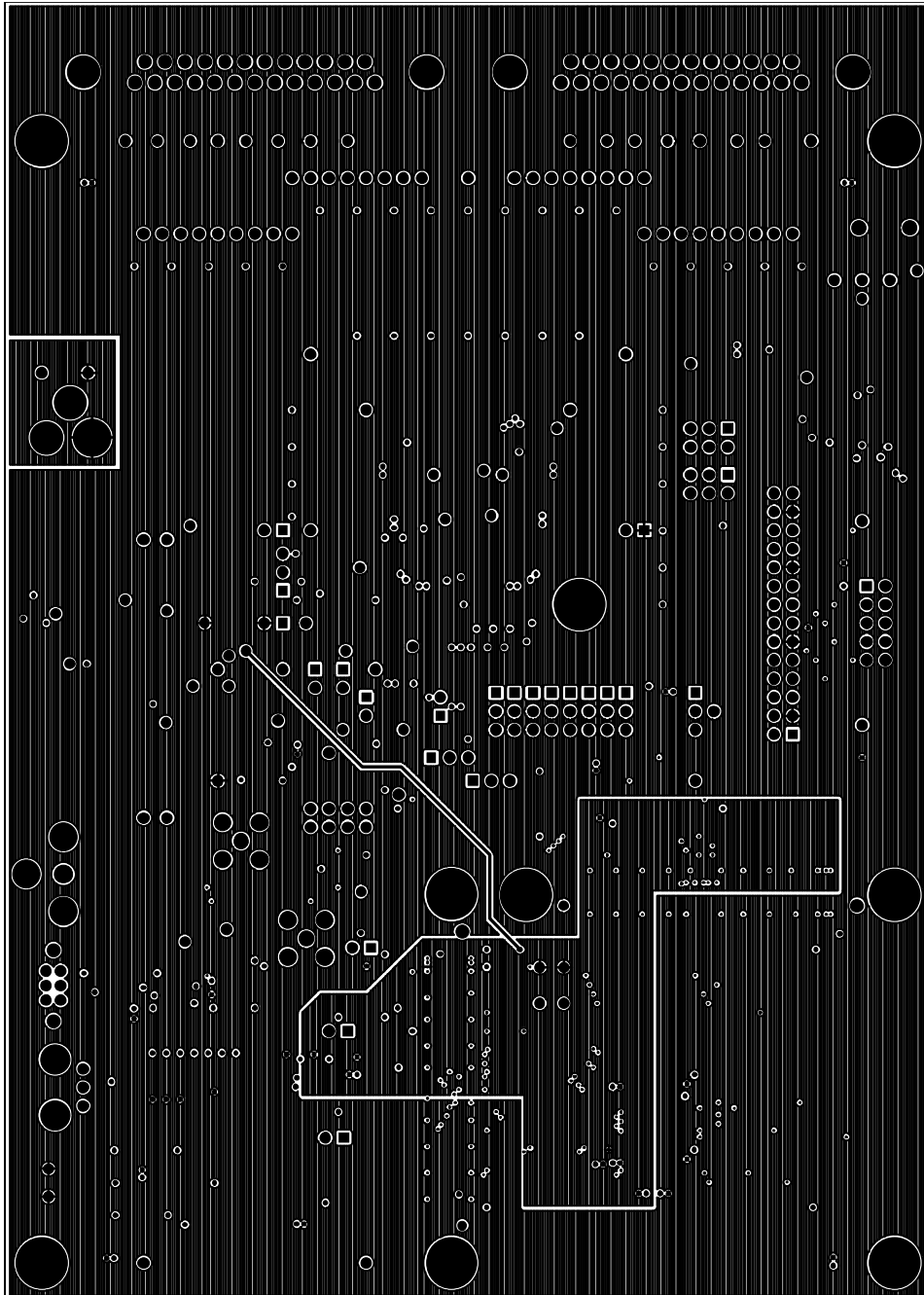

Figure 33. ADAU1962/ADAU1966 Evaluation Board, L2 Ground



10717-034

Figure 34. ADAU1962/ADAU1966 Evaluation Board, L3 Power

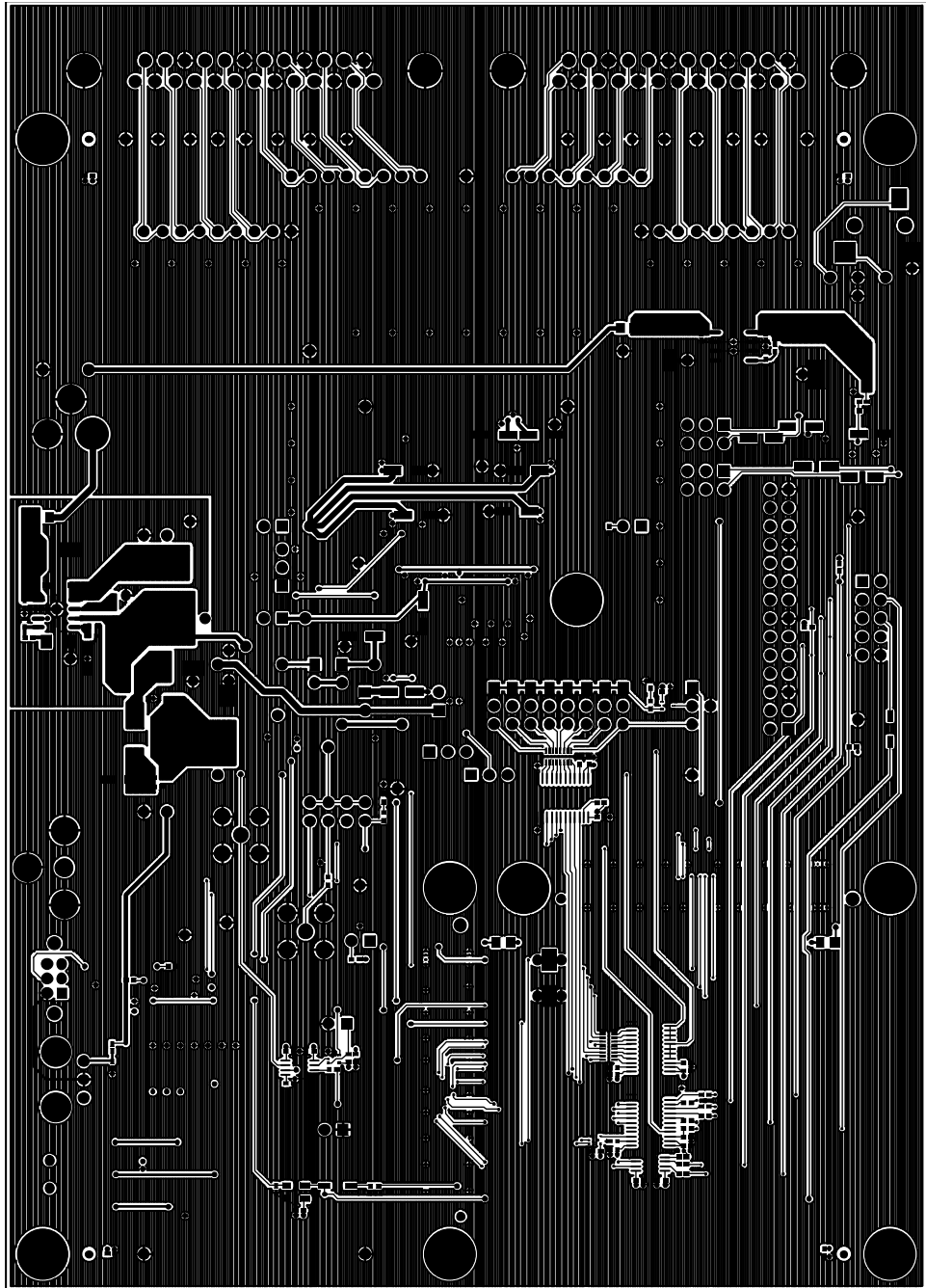
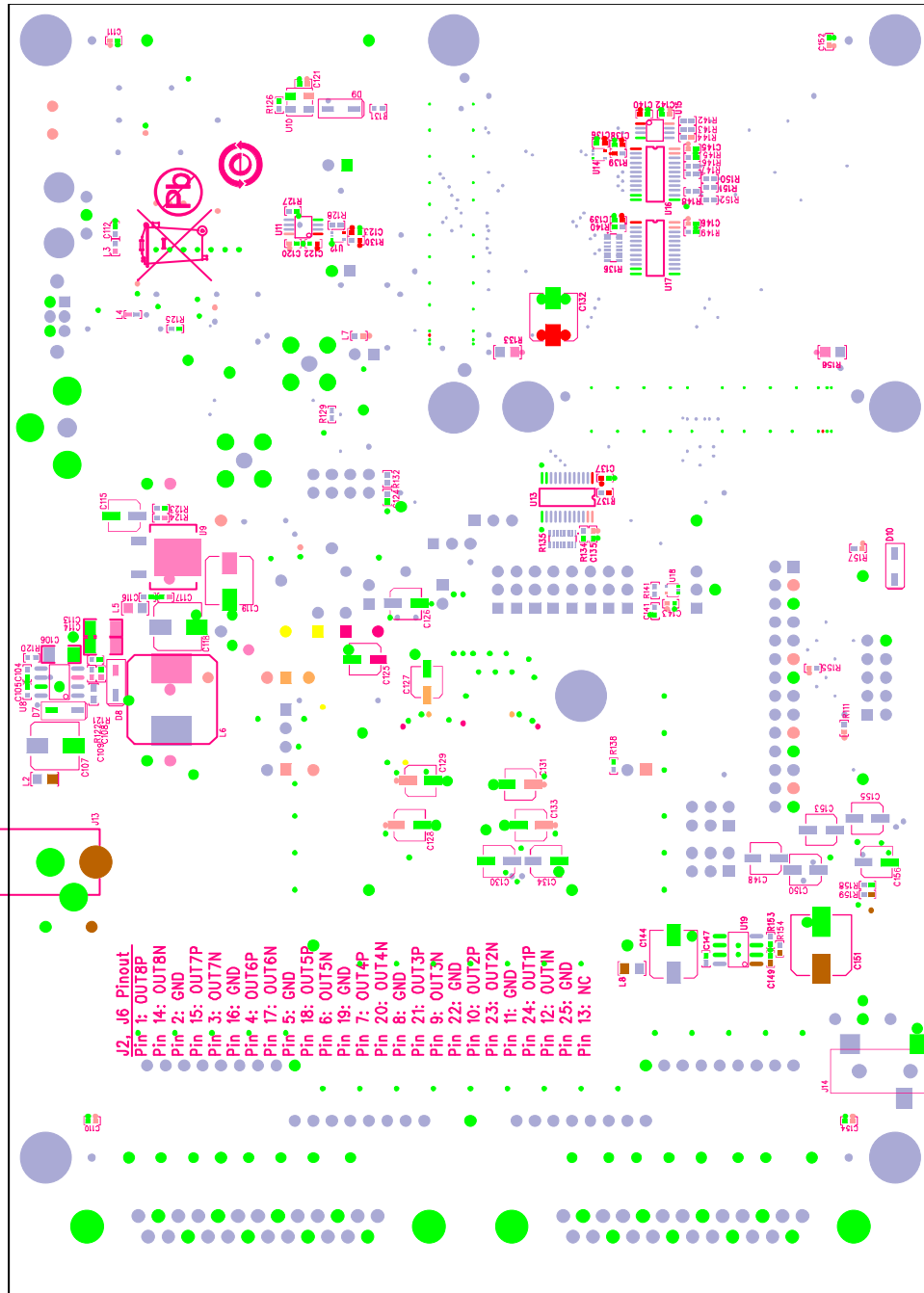

Figure 35. ADAU1962/ADAU1966 Evaluation Board, Bottom Copper

10717-035



10717-006

Figure 36. ADAU1962/ADAU1966 Evaluation Board, Bottom Assembly



**NOTES**

**NOTES**

**NOTES**

## NOTES

I<sup>2</sup>C refers to a communications protocol originally developed by Philips Semiconductors (now NXP Semiconductors).

**ESD Caution**

**ESD (electrostatic discharge) sensitive device.** Charged devices and circuit boards can discharge without detection. Although this product features patented or proprietary protection circuitry, damage may occur on devices subjected to high energy ESD. Therefore, proper ESD precautions should be taken to avoid performance degradation or loss of functionality.

**Legal Terms and Conditions**

By using the evaluation board discussed herein (together with any tools, components documentation or support materials, the "Evaluation Board"), you are agreeing to be bound by the terms and conditions set forth below ("Agreement") unless you have purchased the Evaluation Board, in which case the Analog Devices Standard Terms and Conditions of Sale shall govern. Do not use the Evaluation Board until you have read and agreed to the Agreement. Your use of the Evaluation Board shall signify your acceptance of the Agreement. This Agreement is made by and between you ("Customer") and Analog Devices, Inc. ("ADI"), with its principal place of business at One Technology Way, Norwood, MA 02062, USA. Subject to the terms and conditions of the Agreement, ADI hereby grants to Customer a free, limited, personal, temporary, non-exclusive, non-sublicensable, non-transferable license to use the Evaluation Board FOR EVALUATION PURPOSES ONLY. Customer understands and agrees that the Evaluation Board is provided for the sole and exclusive purpose referenced above, and agrees not to use the Evaluation Board for any other purpose. Furthermore, the license granted is expressly made subject to the following additional limitations: Customer shall not (i) rent, lease, display, sell, transfer, assign, sublicense, or distribute the Evaluation Board; and (ii) permit any Third Party to access the Evaluation Board. As used herein, the term "Third Party" includes any entity other than ADI, Customer, their employees, affiliates and in-house consultants. The Evaluation Board is NOT sold to Customer; all rights not expressly granted herein, including ownership of the Evaluation Board, are reserved by ADI. CONFIDENTIALITY. This Agreement and the Evaluation Board shall all be considered the confidential and proprietary information of ADI. Customer may not disclose or transfer any portion of the Evaluation Board to any other party for any reason. Upon discontinuation of use of the Evaluation Board or termination of this Agreement, Customer agrees to promptly return the Evaluation Board to ADI. ADDITIONAL RESTRICTIONS. Customer may not disassemble, decompile or reverse engineer chips on the Evaluation Board. Customer shall inform ADI of any occurred damages or any modifications or alterations it makes to the Evaluation Board, including but not limited to soldering or any other activity that affects the material content of the Evaluation Board. Modifications to the Evaluation Board must comply with applicable law, including but not limited to the RoHS Directive. TERMINATION. ADI may terminate this Agreement at any time upon giving written notice to Customer. Customer agrees to return to ADI the Evaluation Board at that time. LIMITATION OF LIABILITY. THE EVALUATION BOARD PROVIDED HEREUNDER IS PROVIDED "AS IS" AND ADI MAKES NO WARRANTIES OR REPRESENTATIONS OF ANY KIND WITH RESPECT TO IT. ADI SPECIFICALLY DISCLAIMS ANY REPRESENTATIONS, ENDORSEMENTS, GUARANTEES, OR WARRANTIES, EXPRESS OR IMPLIED, RELATED TO THE EVALUATION BOARD INCLUDING, BUT NOT LIMITED TO, THE IMPLIED WARRANTY OF MERCHANTABILITY, TITLE, FITNESS FOR A PARTICULAR PURPOSE OR NON-INFRINGEMENT OF INTELLECTUAL PROPERTY RIGHTS. IN NO EVENT WILL ADI AND ITS LICENSORS BE LIABLE FOR ANY INCIDENTAL, SPECIAL, INDIRECT, OR CONSEQUENTIAL DAMAGES RESULTING FROM CUSTOMER'S POSSESSION OR USE OF THE EVALUATION BOARD, INCLUDING BUT NOT LIMITED TO LOST PROFITS, DELAY COSTS, LABOR COSTS OR LOSS OF GOODWILL. ADI'S TOTAL LIABILITY FROM ANY AND ALL CAUSES SHALL BE LIMITED TO THE AMOUNT OF ONE HUNDRED US DOLLARS (\$100.00). EXPORT. Customer agrees that it will not directly or indirectly export the Evaluation Board to another country, and that it will comply with all applicable United States federal laws and regulations relating to exports. GOVERNING LAW. This Agreement shall be governed by and construed in accordance with the substantive laws of the Commonwealth of Massachusetts (excluding conflict of law rules). Any legal action regarding this Agreement will be heard in the state or federal courts having jurisdiction in Suffolk County, Massachusetts, and Customer hereby submits to the personal jurisdiction and venue of such courts. The United Nations Convention on Contracts for the International Sale of Goods shall not apply to this Agreement and is expressly disclaimed.