

### FCC Part 90 Reference Design Using the **ADF7030-1**, **ADuCM3029**, **ADP5310**, and **SKY65377-21**

#### INTRODUCTION

In this user guide, a reference design that has the capability to transmit at a power of 30 dBm in the 450 MHz to 470 MHz frequency band is presented. The reference design is mainly based on the Analog Devices, Inc., **ADF7030-1** radio transceiver. The improvement in the link budget is almost 17 dB, which translates to a range increase of approximately five to six times in a line of sight scenario with no significant interferer. This design is intended to satisfy the Federal Communications Commission (FCC) Part 90 requirements for operation in the

450 MHz to 470 MHz frequency band.<sup>1</sup> The power strategy used in this design optimizes power for long battery life, but can supply the necessary high current during high power transmission.

Besides the **ADF7030-1**, the reference design uses two other Analog Devices products. These products are the **ADuCM3029** Arm® Cortex®-M3 microcontroller unit (MCU) and the **ADP5310** power management unit (PMU). The design also uses the Skyworks Solutions, Inc., **SKY65377-21** transceiver front-end module (FEM).

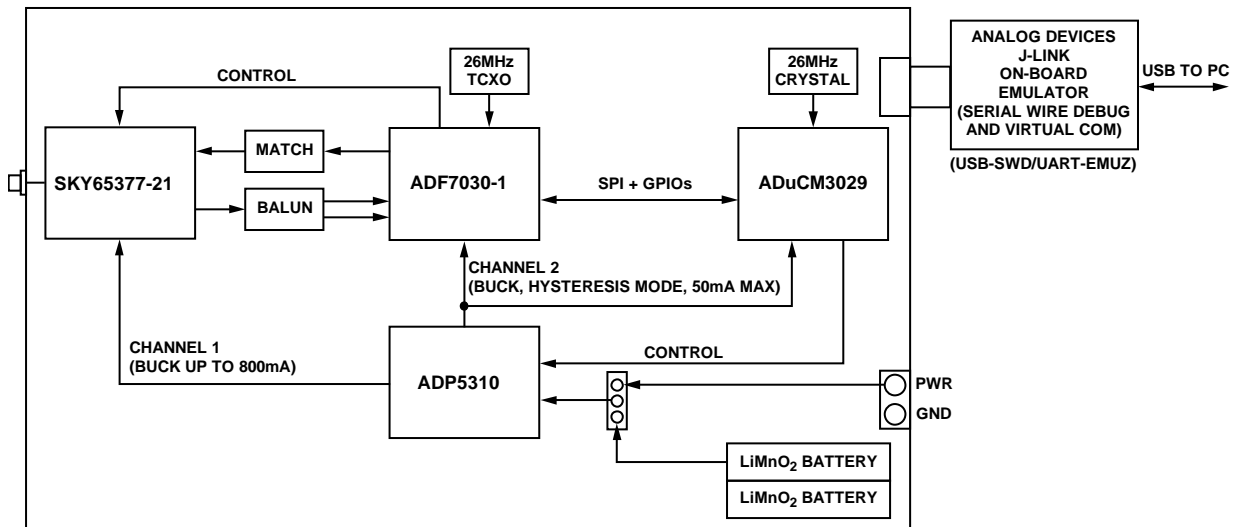

Figure 1. Functional Block Diagram

16720-001

<sup>1</sup> Analog Devices, Inc., does not make and specifically disclaims any representation or warranty that a transceiver built using this reference design will necessarily meet the requirements of FCC Part 90. A designer using this reference design should consult the applicable laws and regulations and use his or her own independent analysis, evaluation, and judgement to ensure compliance.

**TABLE OF CONTENTS**

Introduction .....	1	Typical FCC Part 90 Reference Design Performance	
Revision History .....	2	Characteristics .....	7
Overview .....	3	Receive .....	7
About the FCC Part 90 Standard.....	3	Transmit.....	8
About the ADF7030-1 .....	3	FCC Compliance, Transmit .....	9
About the ADuCM3029 .....	3	Reference Evaluation Board.....	10
About the ADP5310 .....	3	Using the Reference Evaluation Board.....	10
About the SKY65377-21 .....	3	Schematics .....	11
Design Overview .....	3	PCB Layout .....	13
General Operation and Performance Data .....	4	Ordering Information.....	16
General Operation.....	4	Bill of Materials.....	16
Design Specific Receive and Transmit.....	4		

**REVISION HISTORY**

**3/2019—Revision 0: Initial Version**

## OVERVIEW

A brief overview of the reference design and the four main devices used are discussed in this section. Figure 1 shows the functional block diagram of this reference design.

### ABOUT THE FCC PART 90 STANDARD

FCC Part 90 contains the standards or regulations under which radio communication systems can be licensed and used in public safety, industrial or business radio pool, and radiolocation services. General technical requirements include standards for acceptability of equipment, frequency tolerance, modulation, emission, power, and bandwidth.

### ABOUT THE ADF7030-1

The [ADF7030-1](#) is a fully integrated, sub GHz radio transceiver achieving high performance at very low power. This transceiver is designed to operate in the 169.4 MHz to 169.6 MHz, 426 MHz to 470 MHz, and 863 MHz to 960 MHz frequency bands. This transceiver is suitable for applications that require long range transmission, network robustness, and long battery life. This transceiver supports the IEEE 802.15.4g MR-FSK PHY requirements as well as the proprietary 2FSK/2GFSK and 4FSK/4GFSK (transmitter only) modulation schemes in both packet and data streaming modes. This highly configurable low intermediate frequency (IF) receiver supports a large range of receiver channel bandwidths from 2.6 kHz to 738 kHz, which allows the [ADF7030-1](#) to support ultranarrow-band, narrow-band, and wideband channel spacing. This transceiver is suitable for circuit applications under the European ETSI 300-220, the North American FCC (Part 15 and Part 90), the Japanese ARIB (T108), the Chinese short range wireless regulatory standards, or other similar regional standards.

### ABOUT THE ADUCM3029

The [ADuCM3029](#) processor is an ultra low power integrated mixed-signal microcontroller system for processing, control, and connectivity. This MCU system is based on the Arm Cortex-M3 processor, a collection of digital peripherals, embedded static random access memory (SRAM) and flash memory, and an analog subsystem that provides clocking, reset, and power management capability, in addition to an analog-to-digital converter (ADC) subsystem. This MCU offers several power modes, as well as features such as dynamic and software controlled clock gating and power gating, which enables extremely low dynamic and hibernate power management.

### ABOUT THE ADP5310

The [ADP5310](#) PMU is composed of dual buck regulators and a load switch. This device enables direct connection to a wide input voltage range of 2.7 V to 15.0 V, allowing the use of multiple alkaline, nickel metal hydride (NiMH), or lithium cells and

other power sources. For excellent stability and transient performance, the buck regulator in Channel 1 uses a constant frequency pulse-width modulation (PWM) control scheme, which can provide up to 800 mA of output current. An ultra low power buck regulator is integrated in Channel 2 with two modes of operation. Hysteresis mode draws 700 nA of quiescent current to regulate the output under zero load and provides up to 50 mA of output current. Constant frequency PWM mode provides low output ripple for noise sensitive applications and an output current of up to 300 mA.

### ABOUT THE SKY65377-21

The SKY65377-21 is a high performance transmit/receive FEM that integrates a power amplifier and an antenna switch. The device transmit chain features 30 dBm output power with a 40% power added efficiency (PAE). The typical operating current in transmit mode with an output power of 30 dBm and a supply voltage of 3.6 V is 675 mA. In receive mode, the typical insertion loss is 0.5 dB and up to a maximum of 1 dB. This FEM also has a shutdown mode to minimize power consumption.

## DESIGN OVERVIEW

To meet the required power strategy, the [ADP5310](#) PMU is employed to provide power to most of the devices in the system. The [ADP5310](#) in this design has an adjustable output in Channel 1 and fixed 3.3 V in Channel 2. Channel 1, which is configured to output 3.6 V, solely powers the SKY65377-21 FEM. The maximum current of Channel 1 is 800 mA, which is suitable for the demanding high burst current of the FEM when transmitting at 30 dBm. Channel 2 is used to provide power to the [ADuCM3029](#) host MCU and the [ADF7030-1](#) radio transceiver. To improve power efficiency and extend battery life, Channel 2 is operated in hysteresis mode. Either the host MCU or the radio transceiver can turn Channel 1 on or off, which contributes to higher power efficiency.

Between the radio transceiver and the FEM, a matching network and a balun are necessary on the transmit and receive chains, respectively. The antenna or output port of FEM is matched internally to 50  $\Omega$ , which eliminates the need to add a matching network to the antenna. The radio transceiver handles switching between transmit and receive modes of the FEM.

The communication between the MCU and the radio transmitter is carried out using the serial peripheral interface (SPI) protocol. All radio state transition and memory access are performed through the SPI. An interface to the Analog Devices J-Link on-board emulator is also included. This additional interface allows the user to program the host MCU and perform a debug.

## GENERAL OPERATION AND PERFORMANCE DATA

The general operating conditions and typical performance data of the FCC Part 90 reference design are presented in this section. Further details regarding the performance of each device are available in the product data sheets.

Typical performance data is obtained as the average of four different FCC Part 90 reference evaluation boards tested at room temperature and using a supply voltage of 5 V.

### GENERAL OPERATION

**Table 1. General Operating Conditions**

Parameter	Min	Typ	Max	Unit
Supply Voltage Range	4.8 <sup>1</sup>	5	15 <sup>2</sup>	V
Frequency Range	450		470	MHz
Temperature Range <sup>3</sup>	-40		+85	°C

<sup>1</sup> 30 dBm transmit output power at 460 MHz.

<sup>2</sup> It is recommended not to exceed the 15 V supply limit of the [ADP5310](#).

<sup>3</sup> For more detailed performance data on the [ADF7030-1](#) in the 450 MHz to 470 MHz band (for example, vs. temperature) refer to the [ADF7030-1](#) data sheet.

**Table 2. Current Consumption**

Parameter	Min	Typ	Max	Unit
Transmit at 460 MHz Carrier Test Signal with Output Power of 30 dBm		636		mA
Receive at 460 MHz Serial Port (SPORT) or Bit Error Rate (BER) Mode		25		mA

**Table 3. Configurations for the Reference Design in the 450 MHz to 470 MHz Frequency Range**

Configuration Name	Radio Frequency (RF) Frequency (MHz)	Data Rate (kbps)	Modulation	Frequency Deviation (kHz)	Channel Spacing (kHz)	IF Frequency (kHz)	Receiver Bandwidth (kHz)	Packet Setup for Packet Based Testing
460 MHz/ 7.2 kbps	460	7.2	2GFSK	2.0	12.5	81.25	11.1	Preamble = 0xAAAAAAAA, sync word = 0xF672, payload length = 23 bytes, CRC = 2 bytes
460 MHz/ 4.8 kbps	460	4.8	2GFSK	2.0	12.5	81.25	9.7	Preamble = 0x55555555, sync word = 0xF672, payload length = 23 bytes, CRC = 2 bytes

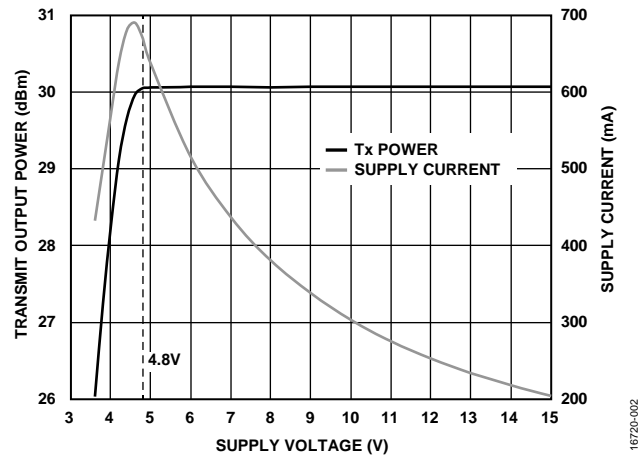

Figure 2. Transmit Output Power and Supply Current vs. Supply Voltage

### DESIGN SPECIFIC RECEIVE AND TRANSMIT

The configurations detailed in Table 3 are used to specify the performance of the FCC Part 90 reference design in Table 4. The two configurations are chosen to satisfy the requirements of the FCC Part 90 standard.

Table 4. Specifications for the Reference Design in the 450 MHz to 470 MHz Frequency Band

Parameter	Min	Typ	Max	Unit	Test Conditions/Comments
SENSITIVITY, PACKET ERROR RATE (PER) Configuration 460 MHz/7.2 kbps		-115.0		dBm	At PER = 5%, automatic frequency control (AFC) enabled, RF frequency error range = $\pm 3.9$ ppm
Configuration 460 MHz/4.8 kbps		-120.0		dBm	
CHANNEL SELECTIVITY AND BLOCKING, BER — BASED TEST METHOD Configuration 460 MHz/7.2 kbps					Desired signal 3 dB above the input sensitivity level (BER = 0.1%), by unmodulated carrier interferer power level increased until BER = 0.1%, image calibrated, AFC disabled
Adjacent Channel ( $\pm 12.5$ kHz)		59.9		dB	
Alternate Channel ( $\pm 25$ kHz)		59.0		dB	
$\pm 2$ MHz		82.4		dB	
$\pm 10$ MHz		90.4		dB	
$\pm 20$ MHz		96.2		dB	
Configuration 460 MHz/4.8 kbps					
Adjacent Channel ( $\pm 12.5$ kHz)		66.9		dB	
Alternate Channel ( $\pm 25$ kHz)		65.6		dB	
$\pm 2$ MHz		89.7		dB	
$\pm 10$ MHz		94.4		dB	
$\pm 20$ MHz		96.5		dB	
CHANNEL SELECTIVITY AND BLOCKING, PER — BASED TEST METHOD Configuration 460 MHz/7.2 kbps					Desired signal 3 dB above the input sensitivity level (PER = 5%), by unmodulated carrier interferer power level increased until PER = 5%, image calibrated, AFC enabled
Adjacent Channel ( $\pm 12.5$ kHz)		52.3		dB	
Alternate Channel ( $\pm 25$ kHz)		58.4		dB	
$\pm 2$ MHz		84.2		dB	
$\pm 10$ MHz		91.9		dB	
$\pm 20$ MHz		97.6		dB	
Configuration 460 MHz/4.8 kbps					
Adjacent Channel ( $\pm 12.5$ kHz)		65.9		dB	
Alternate Channel ( $\pm 25$ kHz)		64.2		dB	
$\pm 2$ MHz		89.3		dB	
$\pm 10$ MHz		96.9		dB	
$\pm 20$ MHz		102.5		dB	
COCHANNEL REJECTION Configuration 460 MHz/7.2 kbps		-4.2		dB	Desired signal 3 dB above the input sensitivity level (PER = 5%), by unmodulated carrier interferer power level increased until PER = 5%, AFC enabled
Configuration 460 MHz/4.8 kbps		-5.1		dB	
CALIBRATED IMAGE REJECTION Configuration 460 MHz/7.2 kbps		49.3		dB	Desired signal 3 dB above the input sensitivity level (PER = 5%), by unmodulated carrier interferer power level increased until PER = 5%, AFC enabled, image calibrated
Configuration 460 MHz/4.8 kbps		47.8		dB	
ADJACENT CHANNEL POWER (ACP) Configuration 460 MHz/7.2 kbps					Spectrum analyzer settings: resolution bandwidth = 100 Hz, video bandwidth = 300 Hz
Adjacent Channel ( $\pm 12.5$ kHz)		-47.3		dBc	
Alternate Channel ( $\pm 25$ kHz)		-72.0		dBc	
Configuration 460 MHz/4.8 kbps					
Adjacent Channel ( $\pm 12.5$ kHz)		-61.7		dBc	
Alternate Channel ( $\pm 25$ kHz)		-72.4		dBc	

Parameter	Min	Typ	Max	Unit	Test Conditions/Comments
OCCUPIED BANDWIDTH					Occupied bandwidth is the bandwidth containing 99% of the total integrated power; spectrum analyzer settings: resolution bandwidth = 100 Hz, video bandwidth = 300 Hz
Configuration 460 MHz/7.2 kbps		7.6		kHz	
Configuration 460 MHz/4.8 kbps		6.8		kHz	
RF SPURS DUE TO REGULATOR RIPPLE					Spectrum analyzer settings: resolution bandwidth = 100 Hz, video bandwidth = 300 Hz; RF spurs typically occurs at $\pm 60$ kHz and $\pm 120$ kHz
Configuration of Pseudorandom Number (9-Bit Generator) (PN9) Signal					
First RF Spur		-62.3		dBc	
Second RF Spur		-75.1		dBc	

# TYPICAL FCC PART 90 REFERENCE DESIGN PERFORMANCE CHARACTERISTICS

## RECEIVE

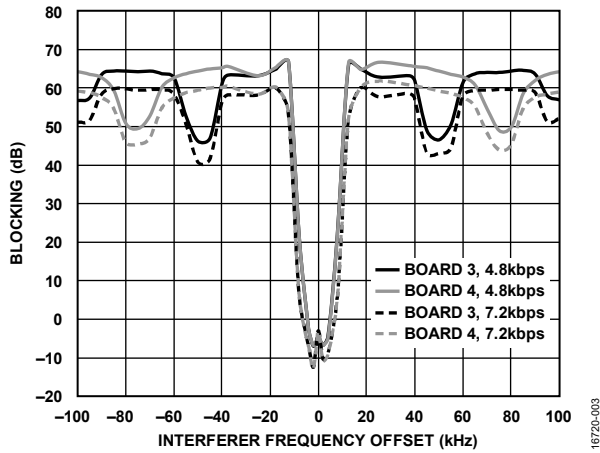

Figure 3. Receiver Close In Blocking vs. Interferer Frequency Offset, Configuration 460 MHz/4.8 kbps, and 7.2 kbps, Unmodulated Interferer, Desired Signal 3 dB Above the Sensitivity Level of PER = 5%, PER-Based Test

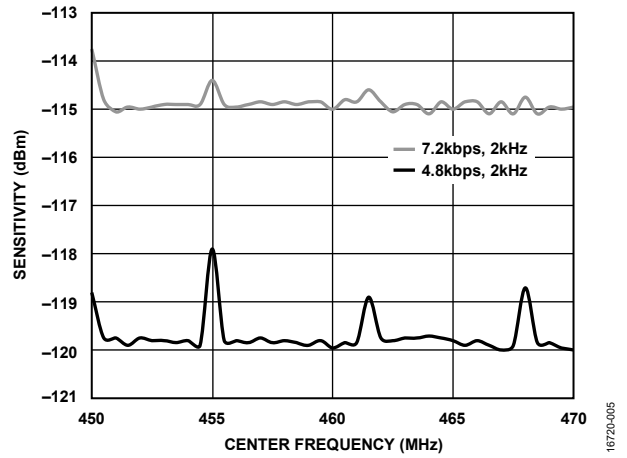

Figure 5. Receiver Sensitivity vs. Center Frequency, Configuration 4.8 kbps and 7.2 kbps, PER = 5%, AFC Enabled

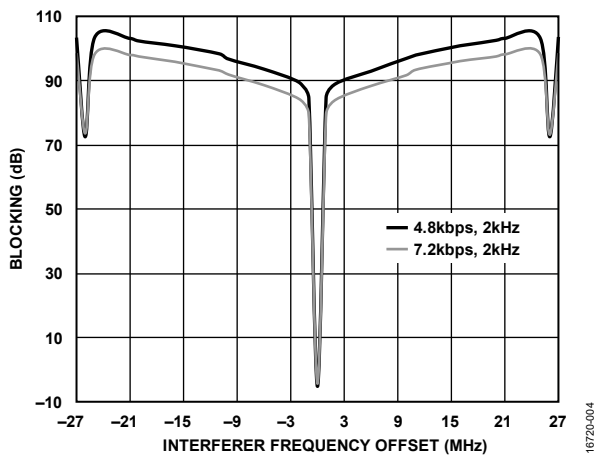

Figure 4. Receiver Wideband Blocking vs. Interferer Frequency Offset, Configuration 460 MHz/4.8 kbps, and 7.2 kbps, Unmodulated Interferer, Desired Signal 3 dB Above the Sensitivity Level of PER = 5%, PER-Based Test

TRANSMIT

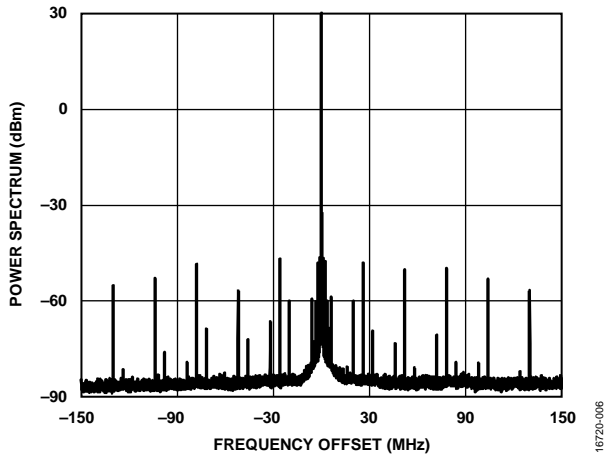

Figure 6. Power Spectrum of Carrier Test Signal vs. Frequency Offset, Configuration 460 MHz, Resolution Bandwidth = 100 Hz, Video Bandwidth = 300 Hz, Frequency Span = 300 MHz

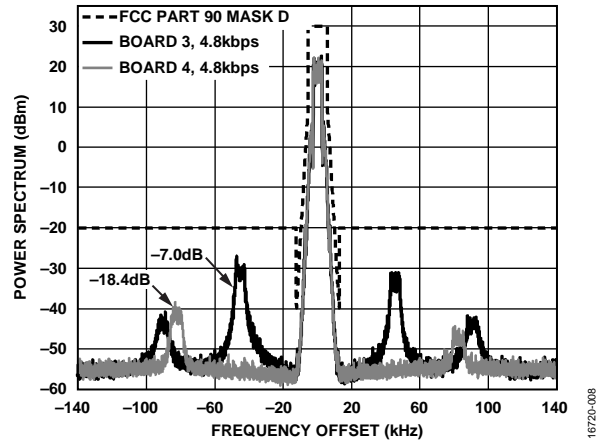

Figure 8. Power Spectrum of PN9 Test Signal vs. Frequency Offset, Configuration 460 MHz/4.8 kbps, Frequency Deviation of 2 kHz, Resolution Bandwidth = 100 Hz, Video Bandwidth = 300 Hz

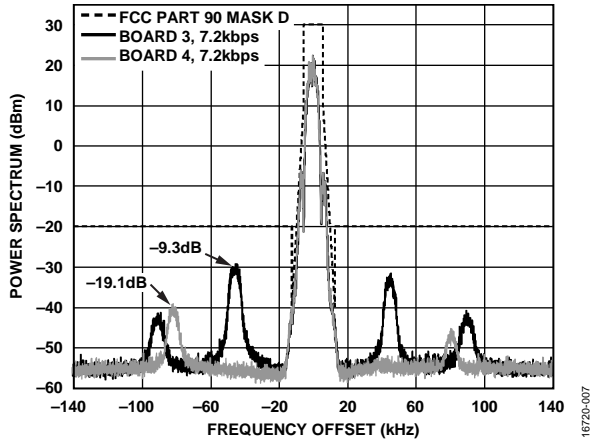

Figure 7. Power Spectrum of PN9 Test Signal vs. Frequency Offset, Configuration 460 MHz/7.2 kbps, Frequency Deviation of 2 kHz, Resolution Bandwidth = 100 Hz, Video Bandwidth = 300 Hz



## FCC COMPLIANCE, TRANSMIT

Because this reference design is intended to be operated in the 450 MHz to 470 MHz frequency band in North America, relevant regulations under the FCC Part 90 standard must be satisfied for compliance. A summary of the compliance to FCC Part 90 provisions is provided in Table 5. The selected operational channel bandwidth is 12.5 kHz, which meets the

data rate need of smart meters. Note that the certification requirement on spectrum efficiency, Part 90.203 (j) (5), is not part of the technical requirement and is not included in this reference design. Refer to the Electronic Code of Federal Regulations for the complete FCC Part 90 standard.

**Table 5. Summary of FCC Part 90 Requirement Tests**

<b>Part 90 Subpart</b>	<b>Description</b>	<b>Regulation</b>	<b>Results and Measurement</b>
90.205 (h)	Power	33 dBm	Pass with 30 dBm
90.207 (e)	Types of emissions	F1D (frequency modulation, digital modulation with no subcarrier, data)	Pass using 2FSK, 2GFSK, 4FSK, 4GFSK modulations
90.209 (b) (5)	Bandwidth limitations	<11.25 kHz	4.8 kbps use case: pass, 6.8 kHz with 4.45 kHz margin; 7.2 kbps use case: pass, 7.6 kHz with 3.65 kHz margin
90.210 (c)	Emission masks	Emission Mask D	Pass for all use cases
90.213	Frequency stability	2.5 ppm or 1.125 kHz at 450 MHz	Pass with 120 Hz frequency error due to temperature compensated crystal oscillator (TCXO) accuracy
90.214	Transient frequency behavior	12.5 kHz within 10 ms, 6.25 kHz within 25 ms	Pass with frequency error less than 5 kHz after turning on and off, pass with negligible frequency error

## REFERENCE EVALUATION BOARD

This section provides the schematic, the printed circuit board (PCB) layout, and the bill of materials (BOM) used to test the reference design described in this user guide. Analog Devices does not provide this evaluation board. The FCC Part 90 reference evaluation board was developed to demonstrate capability, performance, and compliance. However, a full reference design package is available from the Analog Devices website that consists of Gerber files, circuit schematics, fabrication notes, and the BOM. See to the [ADF7030-1](#) product page for the full reference design package.

### USING THE REFERENCE EVALUATION BOARD

The two power supply connections in this reference design are the wall wart and the 5 V line of the Analog Devices J-Link on-board emulator, which can be connected to a dc power supply or batteries. A switch is provided for these two supply

connections. Care is necessary when powering through the emulator to avoid sinking current to the USB connector.

The design can deliver an output power of 30 dBm. Because the FEM has a saturated signal gain of 29.5 dB on its transmit chain, it is recommended that the [ADuCM3029](#) configures the output power of Power Amplifier 1 (PA1) of the [ADF7030-1](#) to approximately 0.5 dBm. Avoid exceeding the maximum input power of the SKY65377-21 of 5 dBm. Due to the high power operation of the design, it is recommended to limit transmission at full power of 30 dBm to 20 sec.

The design also provides additional options for controlling the FEM mode, the Channel 1 output of the PMU, and the source for the TCXO. Control is handled either by the MCU or the radio transceiver. Mixed control is also possible. With these options, there are ways to improve efficiency.

SCHEMATICS

9102-00291

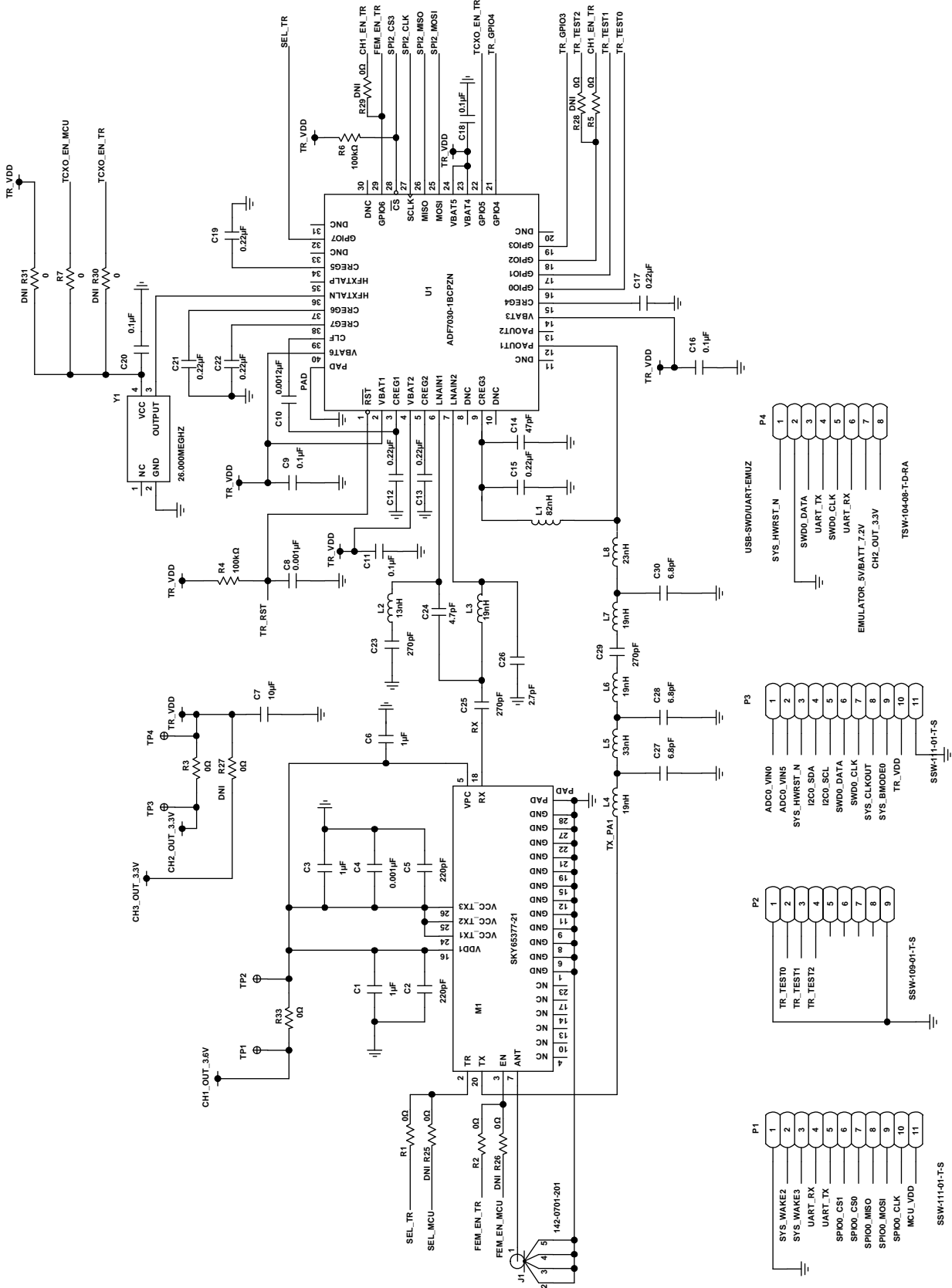

Figure 9. Schematic for the ADF7030-1, SKY65377-21, Header, and J-Link Connectors

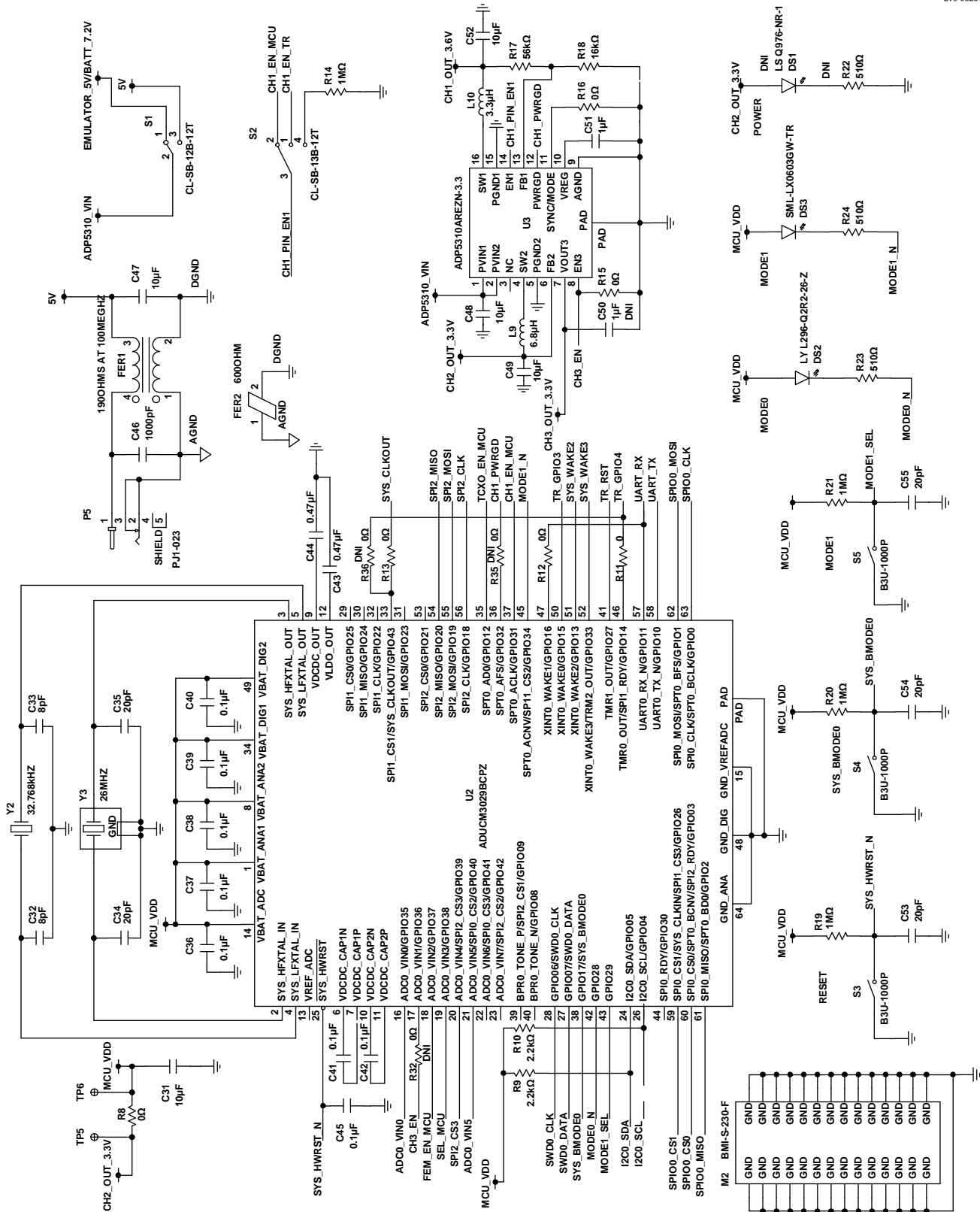

Figure 10. Schematic for the ADuCM3029, ADP5310, and Power Supply

PCB LAYOUT

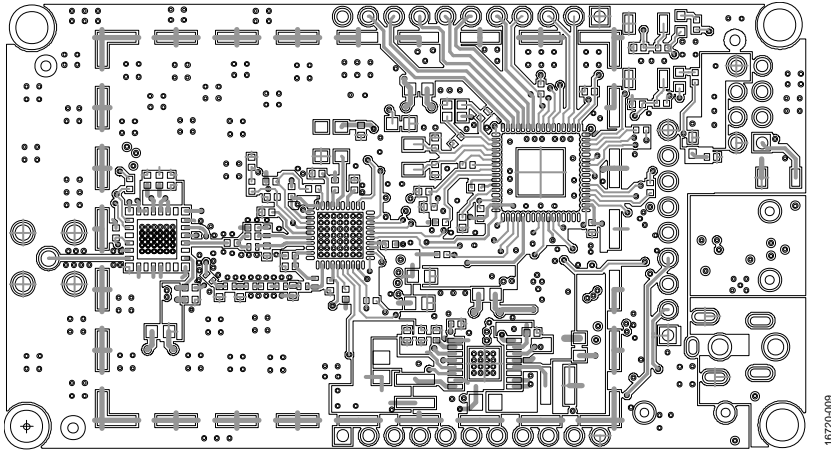

Figure 11. Top Layer, Signal and RF

16720-009

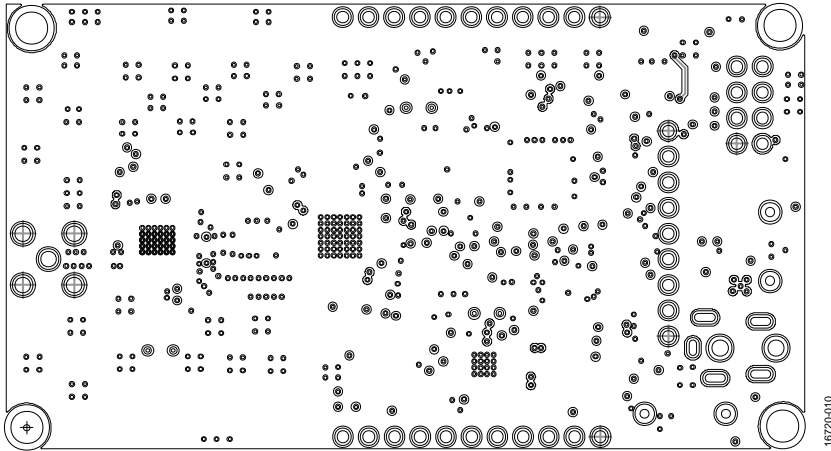

Figure 12. Layer 2, Ground

16720-010

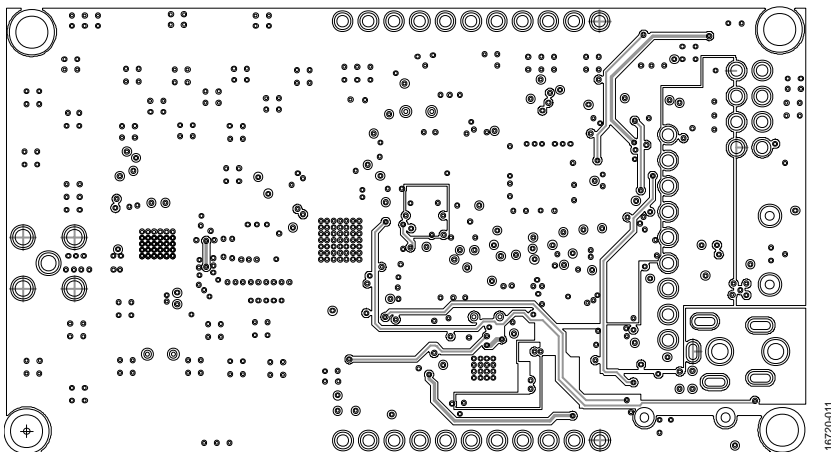
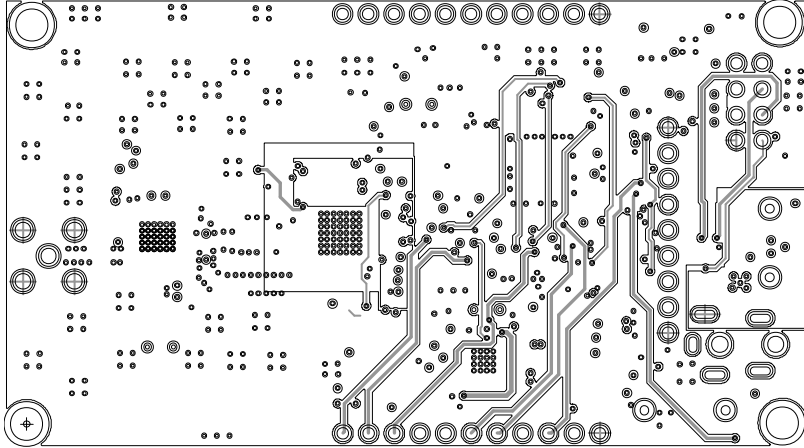

Figure 13. Layer 3, Signal and RF

16720-011



16720-012

Figure 14. Layer 4, Ground

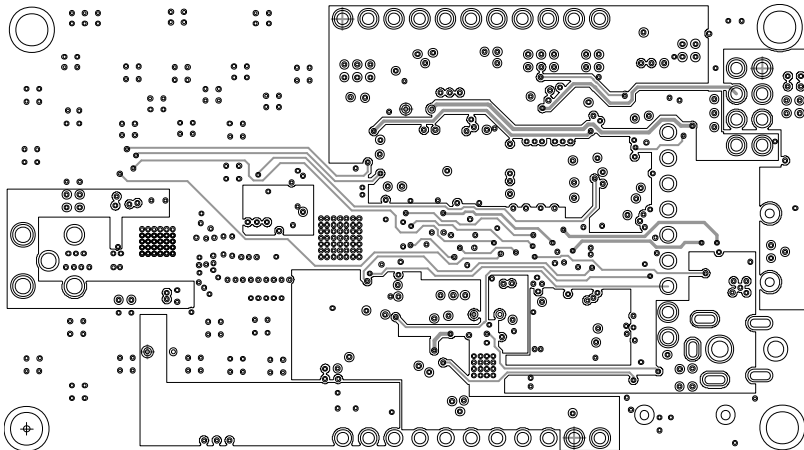

16720-013

Figure 15. Layer 5, Supply Plane

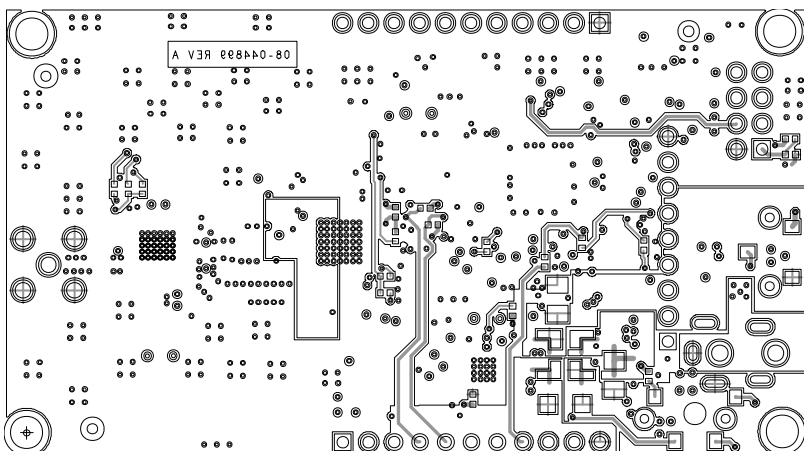

16720-014

Figure 16. Bottom Layer, Ground

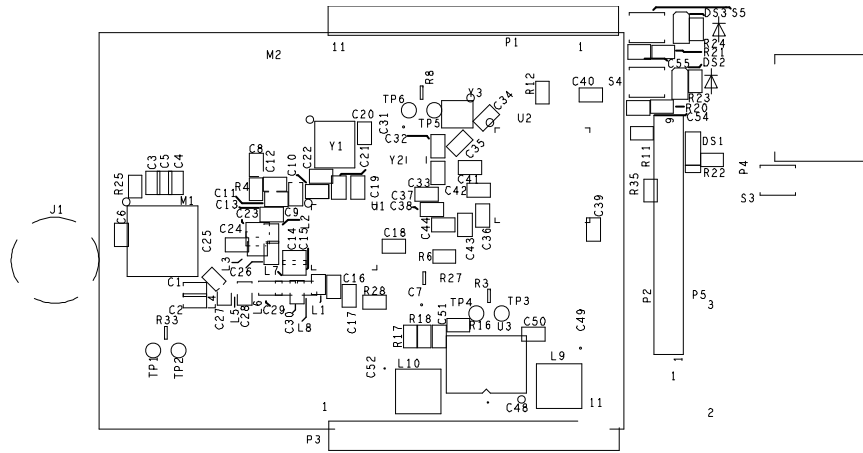

Figure 17. Top Layer Silkscreen

16720-015

## ORDERING INFORMATION

## BILL OF MATERIALS

Table 6. FCC Part 90 Reference Evaluation Board Bill of Materials

Qty	Reference Designator	Value	Tolerance	PCB Decal	Manufacturing Part No.
4	C1, C3, C6, C50	1 $\mu$ F	$\pm$ 10%	C0402	100R07X105KV4T
2	C2, C5	220 pF	$\pm$ 5%	C0402	GRM155R71H221JA01D
2	C4, C8	1 nF	$\pm$ 5%	C0402	GRM155R71H102JA01D
3	C7, C31, C49	10 $\mu$ F	$\pm$ 20%	C0603	6R3R14X106MV4T
13	C9, C11, C16, C18, C20, C36, C37, C38, C39, C40, C41, C42, C45	0.1 $\mu$ F	$\pm$ 5%	C0402	GRM155R71C104JA88D
1	C10	1.2 nF	$\pm$ 5%	C0402	GRM1557U1A122JA01D
7	C12, C13, C15, C17, C19, C21, C22	0.22 $\mu$ F	$\pm$ 10%	C0402	GRM155R71C224KA12D
1	C14	47 pF	$\pm$ 2%	C0402	GRM1555C1H470GA01D
3	C23, C25, C29	270 pF	$\pm$ 1%	C0402	GRM1555C1H271FA01D
1	C24	4.7 pF	$\pm$ 0.05 pF	C0402	GRM1555C1H4R7WA01D
1	C26	2.7 pF	$\pm$ 0.05 pF	C0402	GRM1555C1H2R7WA01D
3	C27, C28, C30	6.8 pF	$\pm$ 0.1 pF	C0402	GRM1555C1H6R8BA01D
2	C32, C33	8 pF	$\pm$ 0.25 pF	C0402	GRM1555C1E8R0CA01D
5	C34, C35, C53, C54, C55	20 pF	$\pm$ 5%	C0402	GRM1555C1E200JA01D
2	C43, C44	0.47 $\mu$ F	$\pm$ 10%	C0402	C1005JB1C474K050BC
1	C46	1 nF	$\pm$ 5%	C1206	GRM3195C1H102JA01D
1	C47	10 $\mu$ F	$\pm$ 10%	C1206	100R18X106KV4E
2	C48, C52	10 $\mu$ F	$\pm$ 10%	C0805	100R15X106KV4E
1	C51	1 $\mu$ F	$\pm$ 10%	C0402	GRM155R60J105KE19D
1	DS1	DNI	Not applicable	LED0603	Do not insert
1	DS2	Not applicable	Not applicable	LED0603	LY L296-Q2R2-26-Z
1	DS3	Not applicable	Not applicable	LED0603	SML-LX0603GW-TR
1	FER1	190 $\Omega$	Not applicable	5 mm $\times$ 5 mm	DLW5B5M191SQ2
1	FER2	600 $\Omega$	$\pm$ 25%	L1206	HZ1206E601R-10
1	J1	Not applicable	Not applicable	CNJOHNSON142-0701-201	142-0701-201
1	L1	82 nH	$\pm$ 5%	L0402-2	Coilcraft 0402CS-82NXJL
1	L2	13 nH	$\pm$ 5%	L0402-2	Coilcraft 0402CS-13NXJL
4	L3, L4, L6, L7	19 nH	$\pm$ 5%	L0402-2	Coilcraft 0402CS-19NXJLW
1	L5	33 nH	$\pm$ 5%	L0402-2	Coilcraft 0402CS-33NXJL
1	L8	23 nH	$\pm$ 5%	L0402-2	Coilcraft 0402CS-23NXJL
1	L9	6.8 $\mu$ H	$\pm$ 20%	LSMSQ157H122	Coilcraft XEL4030-682MEC
1	L10	3.3 $\mu$ H	$\pm$ 20%	LSMSQ157H122	Coilcraft XEL4030-332MEC
1	M1	Not applicable	Not applicable	MSKY65377-21	SKY65377-21
1	M2	Not applicable	Not applicable	MBMI-S-230-F	BMI-S-230-F
1	Not applicable	Not applicable	Not applicable	Not applicable	BMI-S-230-C
2	P1, P3	Not applicable	Not applicable	CNTHFHDR1X11L1120W95H340	SSW-111-01-T-S
1	P2	Not applicable	Not applicable	CNSAMTECSSW-109-01-T-S	SSW-109-01-T-S



Qty	Reference Designator	Value	Tolerance	PCB Decal	Manufacturing Part No.
1	P4	Not applicable	Not applicable	CNHDRRA2X4H240	TSW-104-08-T-D-RA
1	P5	Not applicable	Not applicable	CNCUIPJ1-023	PJ1-023
9	R1, R2, R5, R7, R11, R12, R13, R15, R16	0 $\Omega$	Not applicable	R0402	ERJ-2GE0R00X
3	R3, R8, R33	0 $\Omega$	Not applicable	R0603	CRCW06030000Z0EAHP
2	R4, R6	100 k $\Omega$	$\pm 5\%$	R0402	ERJ-2GEJ104X
2	R9, R10	2.2 k $\Omega$	$\pm 5\%$	R0402	ERJ-2GEJ222X
1	R14	1 M $\Omega$	$\pm 1\%$	R0402	ERJ-2RKF1004X
1	R17	56 k $\Omega$	$\pm 1\%$	R0402	ERJ-2RKF5602X
1	R18	16 k $\Omega$	$\pm 1\%$	R0402	ERJ-2RKF1602X
3	R19, R20, R21	10 k $\Omega$	$\pm 1\%$	R0402	ERJ-2RKF1002X
1	R22	DNI	Not applicable	Not applicable	Do not insert
2	R23, R24	499 $\Omega$	$\pm 1\%$	R0402	ERJ-2RKF4990X
9	R25, R26, R28, R29, R30, R31, R32, R35, R36	DNI	Not applicable	Not applicable	Do not insert
1	R27	DNI	Not applicable	Not applicable	Do not insert
1	S1	Not applicable	Not applicable	SWSML335W138H150	CL-SB-12B-12T
1	S2	Not applicable	Not applicable	SWSML472W138H150	CL-SB-13B-12T
3	S3, S4, S5	Not applicable	Not applicable	SWSML118W98H69	B3U-1000P
1	U1	Not applicable	Not applicable	QFN40_6X6_PAD4_5X4_5	<a href="#">ADF7030-1BCPZN</a>
1	U2	Not applicable	Not applicable	QFN64_9X9_PAD4_5X4_5	<a href="#">ADuCM3029BCPZ</a>
1	U3	Not applicable	Not applicable	TSSOP16_PAD3X3	<a href="#">ADP5310AREZN-3.3</a>
1	Y1	26 MHz	$\pm 2$ ppm	YSML126W98H39_A	TG- 5035CE-26N: X1G003831002500
1	Y2	32.768 kHz	$\pm 20$ ppm	YSML126W59H35	ABS07-120-32.768KHZ-T
1	Y3	26 MHz	$\pm 10$ ppm	YSML79W63H20	FA-128 26.0000MF10Z-W3

## NOTES

**ESD Caution**

**ESD (electrostatic discharge) sensitive device.** Charged devices and circuit boards can discharge without detection. Although this product features patented or proprietary protection circuitry, damage may occur on devices subjected to high energy ESD. Therefore, proper ESD precautions should be taken to avoid performance degradation or loss of functionality.

**IMPORTANT NOTICE**

Information in this User Guide (the "User Guide") is intended to assist designers who are developing applications that incorporate Analog Devices, Inc. ("ADI") products. By downloading, accessing or using this User Guide in any way, you (individually or, if you are acting on behalf of a company, your company) agree to use it solely for this purpose and subject to the terms of this Notice. ADI's provision of this User Guide does not expand or otherwise alter ADI's applicable published warranties or warranty disclaimers for ADI products, and no additional obligations or liabilities arise from ADI providing the User Guide. ADI reserves the right to make corrections, enhancements, improvements and other changes to its documentation, products, services, specifications or product descriptions at any time, without notice. ADI makes no commitment to update any materials or information and shall have not responsibility whatsoever for conflicts, incompatibilities, or other difficulties arising from any future changes.

You understand and agree that you remain responsible for using your independent analysis, evaluation and judgment in designing your applications and that you have full and exclusive responsibility to assure the safety of your applications and compliance of your applications (and of all ADI products used in or for your applications) with all applicable regulations, laws and other applicable requirements. You are responsible for your products and applications using ADI products, which may deviate from published specifications as a result of design defects, errors, or operation of products outside of published parameters or design specifications. You should include design and operating safeguards to minimize these and other risks.

You are authorized to use and copy this User Guide only in connection with creating the reference design described therein using ADI products. NO OTHER LICENSE, EXPRESS OR IMPLIED, BY ESTOPPEL OR OTHERWISE TO ANY OTHER ADI INTELLECTUAL PROPERTY RIGHT, AND NO LICENSE TO ANY TECHNOLOGY OR INTELLECTUAL PROPERTY RIGHT OF ADI OR ANY THIRD PARTY IS GRANTED HEREIN, including but not limited to any patent right, copyright, mask work right, or other intellectual property right relating to any combination, machine, or process in which ADI products or services are used. Information regarding or referencing third-party products or services does not constitute a license to use such products or services, or a warranty or endorsement thereof. Use of the information in this User Guide may require a license from a third party under the patents or other intellectual property of the third party, or a license from ADI under the patents or other intellectual property of ADI.

THE USER GUIDE IS PROVIDED "AS IS" AND WITH ALL FAULTS. ADI DISCLAIMS ALL OTHER WARRANTIES OR REPRESENTATIONS, EXPRESS OR IMPLIED, REGARDING THE INFORMATION THEREIN OR USE THEREOF, INCLUDING BUT NOT LIMITED TO ACCURACY OR COMPLETENESS, TITLE, ANY EPIDEMIC FAILURE WARRANTY AND ANY IMPLIED WARRANTIES OF MERCHANTABILITY, FITNESS FOR A PARTICULAR PURPOSE, AND NON-INFRINGEMENT OF ANY THIRD PARTY INTELLECTUAL PROPERTY RIGHTS. ADI SHALL NOT BE LIABLE FOR AND SHALL NOT DEFEND OR INDEMNIFY YOU AGAINST ANY CLAIM, INCLUDING BUT NOT LIMITED TO ANY INFRINGEMENT CLAIM THAT RELATES TO OR IS BASED ON ANY COMBINATION OF PRODUCTS EVEN IF DESCRIBED IN THE USER GUIDE OR OTHERWISE. IN NO EVENT SHALL ADI BE LIABLE FOR ANY ACTUAL, DIRECT, SPECIAL, COLLATERAL, INDIRECT, PUNITIVE, INCIDENTAL, CONSEQUENTIAL OR EXEMPLARY DAMAGES IN CONNECTION WITH OR ARISING OUT OF ADI RESOURCES OR USE THEREOF, AND REGARDLESS OF WHETHER ADI HAS BEEN ADVISED OF THE POSSIBILITY OF SUCH DAMAGES.

Products sold by ADI are not designed, intended or approved for use in life support, implantable medical devices, transportation, nuclear, safety or other equipment where malfunction of the product can reasonably be expected to result in personal injury, death, severe property damage or severe environmental harm. You represent and warrant that you will use appropriate safeguards to minimize potentially dangerous consequences associated with product failure. Notwithstanding the foregoing, if you use or sell products for in such critical applications, you do so at your own risk.

You agree to fully indemnify ADI and its representatives against any damages, costs, losses, and/or liabilities arising out of your noncompliance with the terms and provisions of this Notice. Additional terms apply to the use and purchase of certain types of materials, ADI products and services. These include, without limitation, ADI's Standard Terms and Conditions of Sale. Copyright © 2019, Analog Devices, Inc.