

## Correcting Imperfections in IQ Modulators to Improve RF Signal Fidelity

by Eamon Nash

### INTRODUCTION

The in-phase and quadrature modulator (IQ modulator) is a key component in modern wireless transmitters. It provides a convenient method for modulating data bits or symbols onto an RF carrier. IQ upconversion has become the architecture of choice for implementing transmitter signal chains for end applications such as cellular, WiMAX, and wireless point-to-point. IQ modulators, however, can degrade signal fidelity in ways that are somewhat unique. These effects can degrade the quality of the transmitted signal during the modulation process, resulting in degraded error vector magnitude (EVM) at the receiver, which in turn degrades bit error rate (BER). Fortunately, algorithms exist that can correct these imperfections.

This application note describes a typical zero-IF or direct-conversion transmitter and provides a brief introduction to digital modulation. Other items discussed are: the imperfections introduced by the modulator are examined with particular focus on the effect of temperature and frequency

changes, in-factory and in-field algorithms that can reduce the effect of these modulator imperfections is also discussed, and particular focus is placed on the efficacy of in-factory set-and-forget algorithms.

### A TYPICAL WIRELESS TRANSMITTER

Figure 1 shows a block diagram of a direct-conversion wireless transmitter that uses an IQ modulator to modulate a bit stream onto a carrier. A single bit stream is split into two parallel bit streams at half the original data rate. To limit the spectral bandwidth of the final carrier, the two bit streams are low-pass filtered in the digital domain. To do this, the original bit-streams must be digitally oversampled by the digital signal processor or field programmable gate array (FPGA). So, instead of two bit streams, there are now two streams of digital words. The chosen resolution of these words depends upon multiple factors such as the required signal-to-noise ratio of the link and the chosen modulation scheme (QPSK in this case). Word widths between 12 and 16 bits are commonly chosen.

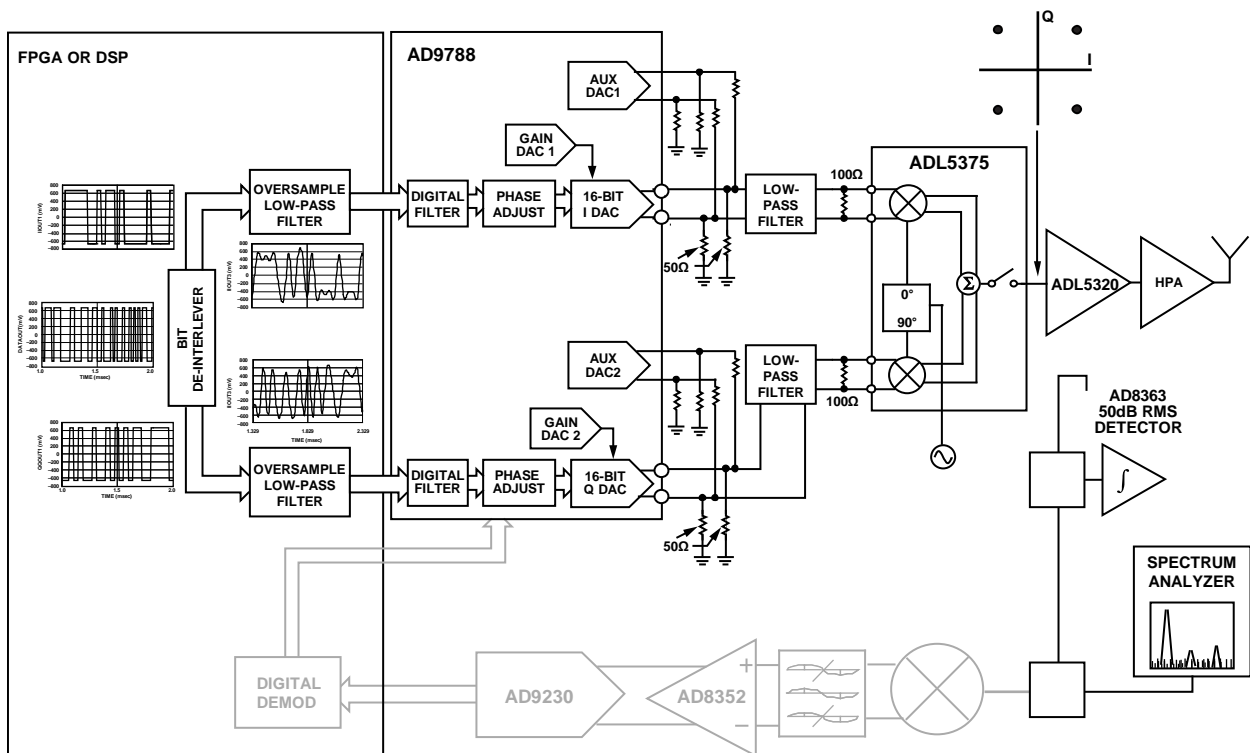

Figure 1. A Zero IF Direct-Conversion Transmitter with Optional Loop-Back Receiver

**TABLE OF CONTENTS**

Introduction .....	1	Correcting for Quadrature and I/Q Gain Errors .....	6
A Typical Wireless Transmitter .....	1	Frequency Variations .....	7
Modulator Imperfections .....	3	Post Calibration Temperature Drift.....	7
Correcting Modulator Imperfections .....	4	Calibration vs. Time.....	7
Factory Calibration .....	4	Complex Modulation.....	8
Calibration Procedure.....	6	Conclusions.....	8

After low-pass filtering, the two word streams are applied to a pair of digital-to-analog converters (DAC). The DAC outputs drive two low-pass filters whose primary role is to remove Nyquist images. The outputs of these filters then drive the baseband inputs of the IQ modulator. The local oscillator (LO) input of the modulator is driven by a relatively pure CW signal generated by a phase-locked loop (PLL) such as the [ADF4106](#) from Analog Devices, Inc. Now, take a closer look at the operation of the IQ modulator.

The LO signal is split into two signals, equal in amplitude but with a phase difference of exactly  $90^\circ$ . These two quadrature signals drive the inputs of the two mixers that, for the purposes of this application note, are viewed as analog multipliers. The outputs of these two multipliers are added together (in the  $\Sigma$  block of the IQ modulator) to provide the IQ modulator's output.

While it is apparent that the baseband data streams have been filtered, instead briefly consider them as the original bit streams. Instead of a stream of 1s and 0s, think of them as two streams switching between a value of +1 and -1. So, the output of the I multiplier consists of a vector which is flipping in-phase between  $0^\circ$  and  $180^\circ$  as the bit stream alternates. Likewise, the output of the Q multiplier is a vector that flips between  $+90^\circ$  and  $-90^\circ$  as the bit stream modulates the original  $90^\circ$  vector. Thus, if at a particular instant, both the I and Q bit streams are equal to +1, the result at the output of the IQ modulator is the sum of the  $90^\circ$  and  $0^\circ$  vectors, that is, a  $+45^\circ$  vector. Likewise, I and Q bit combinations of  $-1/+1$ ,  $-1/-1$ , and  $+1/-1$  produce vectors (commonly called symbols) all of equal amplitude at  $+135^\circ$ ,  $-135^\circ$ , and  $-45^\circ$ , respectively. If these vectors were plotted, observe the constellation of the modulated carrier (see Figure 2A).

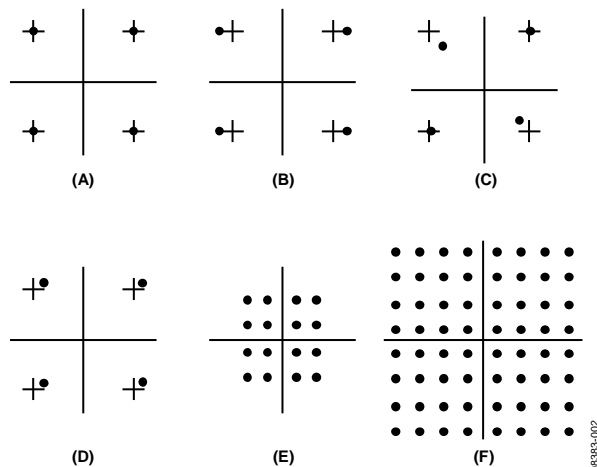

Figure 2. Error Vector Magnitude Constellations that Result from Various Modulator Imperfections

### MODULATOR IMPERFECTIONS

Contrary to the previous hypothetical situation, in a real IQ modulator, things do not look so perfect. A series of effects in the IQ modulator conspire to create QPSK (or QAM) vectors that are neither equal in amplitude nor separated by exactly  $45^\circ$ . Consider first what happens if for some reason the gain of the I path is greater than that of the Q channel; this could be caused by a DAC gain mismatch, low-pass filter insertion loss, mismatch, or gain imbalance inside the IQ modulator. Regardless of where this gain imbalance comes from, its effect is the same. Because the  $0^\circ/180^\circ$  vectors at the output of the I multiplier are larger than the  $+90^\circ/-90^\circ$  vectors from the Q multiplier, the shape of the constellation becomes rectangular (see Figure 2B). This degrades signal integrity at the receiver because the receiver is expecting a perfectly square constellation. In the QPSK example shown in Figure 2B, a slight gain imbalance is unlikely to result in an incorrect bit decision in the receiver unless the received signal is very small. However, in higher order modulation schemes such as 16 QAM or 64 QAM (see Figure 2E and Figure 2F), the increased density of the constellation points could easily combine with an IQ gain imbalance to produce an incorrect symbol decision in the receiver.

In most IQ modulators, the  $90^\circ$  phase split of the LO is achieved using either a polyphase filter or a divide-by-two flip-flop circuit (which requires an external LO that is twice the desired output frequency). In either circuit, the  $90^\circ$  phase split or quadrature is never perfect. For example, if there is a  $1^\circ$  quadrature error, the shape of the resulting constellation is slightly trapezoidal (see Figure 2C). Just like IQ gain imbalance, this can result in incorrect bit decisions in the receiver.

Now consider what happens if either the I or Q paths have unwanted dc offset errors. This results in the  $+1/-1$  multiplication being skewed. For example, an offset that is equal to 1% of the baseband signal amplitude causes the  $+1/-1$  multipliers to be modified to  $+1.01/-0.99$ . This has the effect of shifting the center of the constellation off the origin, on either the I or Q axis, most likely in both (see Figure 2D). In the frequency domain, this manifests itself as a small portion of the unmodulated carrier appearing at the output of the modulator. In the frequency domain, this LO leakage (also referred to as LO feedthrough) appears at the center of the modulated spectrum.

Because of parasitic capacitances within the silicon die and bond-wire to bond-wire coupling, the signal that is applied to the LO port of the IQ modulator may also couple directly to the RF output. This leakage is independent of the offset multiplication effect that was described previously. However, its manifestation, that is, the presence of the unmodulated carrier in the output spectrum, is exactly the same. Thus, the net LO leakage seen at the output of the IQ modulator is the vector sum of these two components. Fortunately, as discussed in the Correcting Modulator Imperfections section, the composite LO leakage at the output can be mitigated by a single compensation technique.

Table 1. IQ Modulator Selection Table Showing Uncompensated Gain and Phase Imbalance

PART NUMBER	FREQUENCY (MHz)	IQ 3dB BANDWIDTH (MHz)	CARRIER SUPPRESS (dBm)	SIDEBAND SUPPRESSION (dBc)	GAIN IMBALANCE (dB)	PHASE IMBALANCE (°)	NOISE FLOOR (dBm/Hz)	P1dB (dBm)	OUTPUT IP3 (dBm)	SUPPLY VOLTAGE (V)	SUPPLY CURRENT (mA)	SPECS @ (MHz)
AD8345	140 TO 1000	80	-42	-42	0.200	0.50	-155.0	2.5	N/A	2.70 TO 5.50	65	800
AD8346	800 TO 2500	70	-42	-36	0.200	1.00	-147.0	-3.0	N/A	2.70 TO 5.50	45	1900
AD8349	700 TO 2700	160	-45	-35	0.100	1.90	-155.0	7.6	21.0	4.75 TO 5.50	135	900
ADL5370	300 TO 1000	500	-50	-41	0.030	0.76	-160.0	11.0	24.0	4.75 TO 5.25	205	450
ADL5371	500 TO 1500	500	-50	-55	0.100	-0.03	-158.6	14.4	27.0	4.75 TO 5.25	175	900
ADL5372	1500 TO 2500	500	-45	-45	0.090	0.21	-158.0	14.2	27.0	4.75 TO 5.25	165	1900
ADL5373	2300 TO 3000	500	-32	-57	0.010	0.10	-157.0	13.8	26.0	4.75 TO 5.25	174	2500
ADL5374	3000 TO 4000	500	-33	-50	0.015	0.25	-160.0	12.0	22.8	4.75 TO 5.25	173	3500
ADL5375	400 TO 6000	750	-46	-52	-0.050	-0.29	-160.0	9.4	27.0	4.75 TO 5.25	200	900
ADL5385	50 TO 2200	700	-46	-50	-0.030	-0.39	-159.0	11.0	26.0	4.75 TO 5.50	215	350
ADL5386	50 TO 2200	700	-38	-46	0.050	-0.50	-160.0	11.1	25.0	4.75 TO 5.50	230	350
ADL5590	869 TO 960	250	-44	-50	0.050	0.20	-157.0	16.0	29.0	4.75 TO 5.50	170	940
ADL5591	1805 TO 1990	250	-39	-48	0.050	0.30	-157.0	16.0	30.0	4.75 TO 5.50	170	1960

08385-009

## CORRECTING MODULATOR IMPERFECTIONS

Note that in Figure 1, in addition to the direct conversion signal chain, an optional loop-back or transmit observation receiver has also been incorporated into the radio. The primary function of this receiver is to analyze the adjacent channel power ratio (ACPR) of the transmitter that is primarily caused by distortion in the high power amplifier (HPA). By continually observing the ACPR of the transmitter, digital predistortion of the baseband signal can be employed to partially correct HPA nonlinearities while allowing the HPA to operate closer to its compression point.

The presence of a loop-back receiver can be opportunistically used to also correct for modulator imperfections.

A detailed discussion of the IQ modulator correction techniques used when a loop-back receiver is present is beyond the scope of this application note. However, the general procedure involves using the loop-back receiver to demodulate the I and Q bit streams. The demodulated constellation is then examined for evidence of IQ gain imbalance, imperfect quadrature, and/or LO leakage. Once these imperfections have been identified, the I and Q data streams can be preprocessed so that the IQ modulator imperfections cancel out. For example, if the demodulated constellation from the loop-back receiver shows a rectangular constellation with the width of I being larger than the height of Q (see Figure 2B), gain adjust registers in the DAC can be used to either decrease the size of the I data stream or increase the size of the Q data stream. Likewise, the phase adjustment registers of the DAC can be used to slightly skew the I and Q channels so that the imperfect quadrature of the IQ modulator's phase splitter is compensated.

## FACTORY CALIBRATION

If a wireless transmitter does not use digital predistortion, it would be difficult to justify the cost of a loop-back receiver purely for the sake of the IQ modulator. In such situations, the two options that remain are:

- Do not perform any correction of the IQ modulator's imperfections.
- Complete a one-time factory calibration and store the correction coefficients in nonvolatile memory.

In recent years, the performance of IQ modulators has improved to such a degree that it is now feasible (depending on the modulation scheme) to design a transmitter without any need to provide correction for imperfections. For example, the [ADL5375](#) from Analog Devices has gain and quadrature imbalances of 0.05 dB and 0.29°, respectively, at 900 MHz, with little or no degradation over temperature. As a result, in many applications, it may be adequate to dispense with any correction algorithms. Table 1 shows the performance of this and other members of the Analog Devices IQ modulator family.

The second alternative presented previously is to perform factory calibration. To do this, the popular single sideband spectrum can be used as a simple but valuable diagnosis tool during factory calibration. To create a single sideband spectrum, the I and Q inputs are driven by low frequency (typically 1 MHz) sine and cosine signals, that is, the base-band signals are in quadrature. Figure 3 shows the spectrum that results when these baseband signals are mixed with the LO. The primary components of the single sideband spectrum are:

- Lower sideband: If the IQ modulator has no imperfections, this is the only spectral component observed, the result of multiplication and summing of the baseband sine and cosine signals with the two in-quadrature LO signals.
- Undesired upper sideband: This undesired component results from gain and phase imbalances between the I and Q signal paths along with LO quadrature imbalance.
- Undesired LO leakage: As discussed earlier, the LO leakage results from I and Q offsets and/or parasitic leakage of the LO directly to the IQ modulator's output.

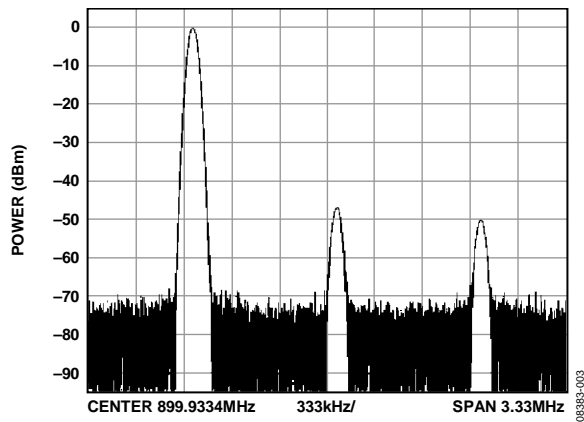

Figure 3. Single Sideband Spectrum

Figure 4 shows a plot that can be used to relate sideband suppression to I/Q gain mismatch and quadrature mismatch. From the plot, it can be noted that a quadrature phase error of 1°, coupled with an I/Q gain mismatch of 0.5 dB, results in -30 dB of sideband suppression. It is notable in this example that improving the quadrature phase mismatch has no effect on the sideband suppression unless the gain mismatch is also improved.

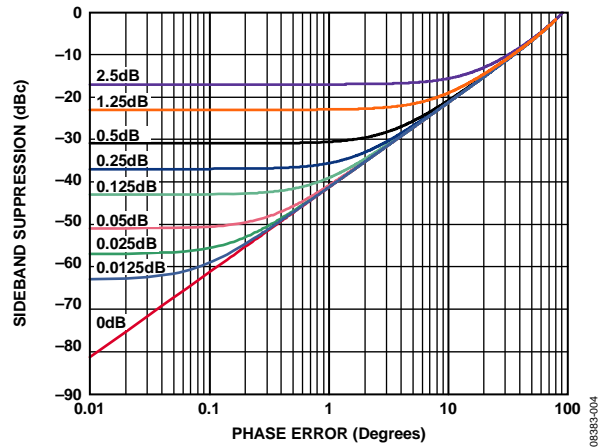

Figure 4. Plot Showing the Relationship Between Modulator Errors and Sideband Suppression

By using a directional coupler and a power splitter (as shown in Figure 1), it is quite simple to add an auxiliary output to the transmitter that can be used during factory calibration. A spectrum analyzer is connected to this port. Another alternative would be to connect the spectrum analyzer at the antenna connector (after the signal has been adequately attenuated).

## CALIBRATION PROCEDURE

Correcting all of the modulator's imperfections is a multistep process. Start by looking at the procedure for LO leakage correction which results in a constellation that is offset from the origin. A single sideband spectrum is applied to the transmitter and is monitored on the spectrum analyzer. Next, small differential offset voltages are applied to the I and Q inputs. Applying differential offset voltages to the I and Q inputs should not be confused with changing the dc bias levels (also referred to as the common-mode level) on these pins, which has no effect. This is done as an I offset sweep followed by a Q offset sweep (or vice versa). Returning briefly to Figure 1, note that the AD9788 (a 16-bit, 800 MSPS dual DAC) conveniently includes two auxiliary DACs that can be used to couple differential dc offset voltages on I and Q lines. This coupling is performed externally using resistor dividers.

Figure 5 shows how sweeping the I and Q offset voltages alters the LO leakage. Start by sweeping the I offset voltage around 0 V while holding the Q offset voltage at 0 V. With modern IQ modulators exhibiting unadjusted LO leakage in the  $-40$  dBm range and having voltage gains in the  $-5$  dB to  $+5$  dB range, an offset voltage sweep range of  $\pm 5$  mV is more than adequate to identify the location of the null (in this example,  $\pm 2$  mV is adequate to identify a nulling voltage somewhere between  $100 \mu\text{V}$  and  $200 \mu\text{V}$ ). Note, however, that the first pass (black trace) only manages to reduce the LO leakage to just under  $-40$  dBm. This clearly indicates that the Q offset needs correction. The second pass (blue trace) involves sweeping the Q offset around 0 V with the I offset held at the value that yielded the first I null. Note that a Q offset of  $400 \mu\text{V}$  reduces the LO leakage a further 10 dB to around  $-50$  dBm. However, a third pass is required. The trough from the first pass is quite shallow because the Q channel had not yet been adjusted. This makes it difficult to identify the ideal I nulling voltage. A third pass (red trace) that involves again sweeping the I offset while holding the Q offset at  $400 \mu\text{V}$ , identifies the optimum I nulling voltage to be  $150 \mu\text{V}$ .

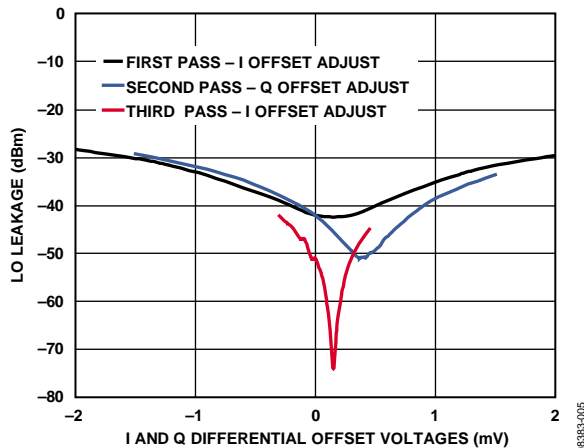

Figure 5. Multipass LO Leakage Compensation Sweeps

## CORRECTING FOR QUADRATURE AND I/Q GAIN ERRORS

A similar procedure can be used to correct quadrature and I/Q gain mismatch. IQ modulator family data sheets typically specify the quadrature phase mismatch and I/Q gain imbalance in degrees and decibels, respectively, along with the sideband suppression (also in decibels). Using this information, it is advisable to perform the first optimization pass on the weaker of the two specifications, that is, the specification which most contributes to the sideband suppression. For example, assume that the device data sheet specifies a sideband suppression of  $-40$  dBc, comprising of 1 degree of phase imbalance and 0.1 dB of gain imbalance amplitude. In this case, it is advisable to first try to adjust phase because making a gain adjustment has almost no effect as long as the 1 degree of phase error is present (see Figure 4).

Figure 6 shows the results of a gain sweep followed by a phase sweep. In the first pass, the gain delta between I and Q is adjusted over a range of approximately  $\pm 2$  dB. The TxDAC<sup>®</sup> in Figure 1 facilitates this adjustment by providing internal gain adjust auxiliary DACs. The sweep yields a null of around  $-57$  dBc for a gain difference of approximately  $-0.1$  dB (gain is scaled on the top axis). Next, adjust the skew between I and Q. This drives the null down further to  $-60$  dBc for a phase adjust of  $-0.05^\circ$ .

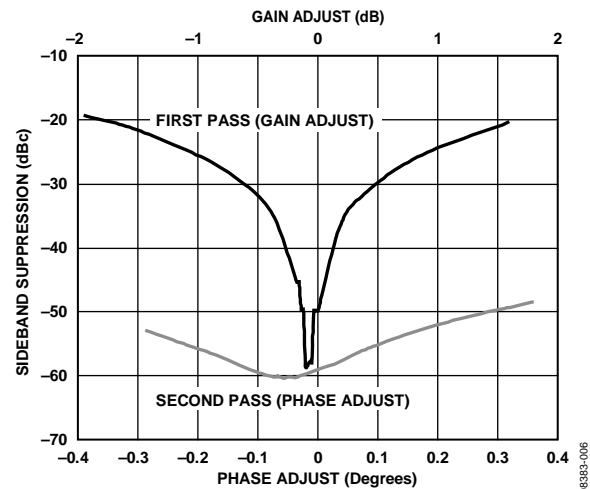

Figure 6. Multipass Sideband Suppression Compensation Sweeps

In this case, a third pass is not necessary and does not yield further improvement. This stems from the fact that the unadjusted phase error is very close to the optimized value ( $\sim 0.05^\circ$ ). Thus, the first-pass gain adjust yields a deep trough that is only slightly improved during the phase sweep. This contrasts to the LO leakage nulling where a third pass yielded further improvement.

Once the LO leakage and quadrature error have been calibrated, all that remains is for the calibration coefficients to be stored in nonvolatile RAM so that they are available when the equipment is turned on in the field. To recap, the four calibration coefficients are

- I channel offset voltage
- Q channel offset voltage
- I channel vs. Q channel gain imbalance
- Quadrature phase imbalance

### FREQUENCY VARIATIONS

Calibrating at multiple frequencies within a band adds time to the factory calibration, requires more nonvolatile memory for the larger look up table, and is more cumbersome during field operation as calibration coefficients have to be swapped out as the frequency changes.

Now, consider what happens to the quality of calibration as the frequency changes. In Figure 7, sideband suppression and LO leakage have been nulled to -60 dBc and -74 dBm, respectively, at 1900 MHz. Figure 7 also shows how the uncompensated sideband suppression and LO leakage vary with frequency (the flatter green and red traces at the top of the plot). Next, adjust the frequency over a range of ±30 MHz (the typical width of a cellular telephony band) without recalibration. The LO leakage quickly loses its null and at some frequencies is only around 8 dB better than the uncompensated value. In the case of the sideband suppression, the difference between the compensated and uncompensated values becomes as low as around 1 dB. Figure 7 suggests that factory calibration be performed at multiple frequencies within a band to maintain nulled performance across the band.

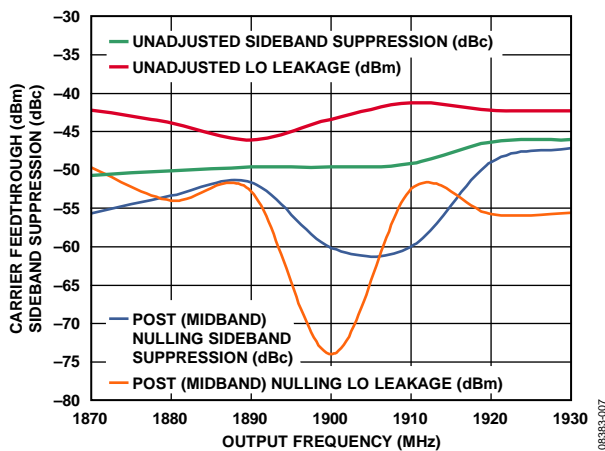

Figure 7. Variation of LO Leakage and Sideband Suppression vs. Frequency after Nulling Midband

### POST CALIBRATION TEMPERATURE DRIFT

Factory calibration at multiple temperatures is even more difficult and expensive than calibration at multiple frequencies. As a result, it is generally only practical to perform factory adjustment of LO leakage and sideband suppression at an ambient temperature. Thus, what happens to post-calibration performance as temperature varies?

In Figure 8, the LO leakage and sideband suppression have again been nulled midband. After nulling, the device is cycled over temperature. This again has the effect of moving sideband suppression and LO leakage off their nulled levels. However, notice that the performance at temperature is quite flat across frequency and it is no longer clear at which frequency the nulling was performed. The net improvement over temperature is approximately 15 dB compared to the unadjusted LO leakage.

### CALIBRATION VS. TIME

In the set-and-forget factory calibration scheme that has just been described, the question of long-term drift arises because the equipment may never be recalibrated in the field. Experiments have shown that it is very difficult, if not impossible, to measure the degradation of nulled sideband suppression and LO leakage over time. Very mild changes in environmental conditions tend to quickly move the device off its null. This makes it impossible to determine whether the environment and the test equipment are altering the experiment or if genuine device drift over time is taking place.

However, Figure 8 shows that the question of drift over time is less important. This is because the effect of temperature drift is much more significant. Thus, in a system that experiences reasonable temperature fluctuations, whatever drift over time takes place is completely masked by the temperature drift.

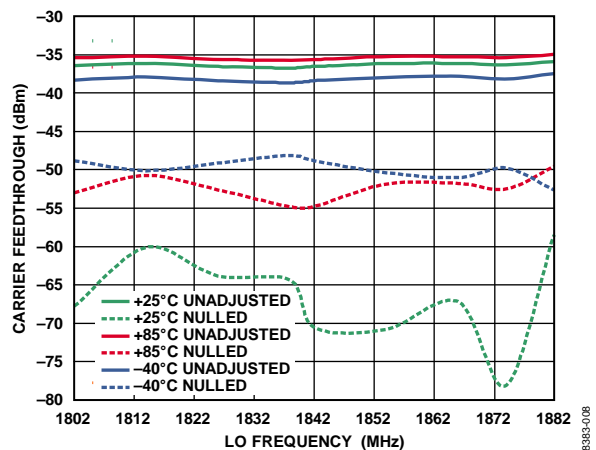

Figure 8. Variation of LO Leakage vs. Frequency and Temperature After Nulling Midband



## COMPLEX MODULATION

While a detailed discussion is beyond the scope of this article, it is worth mentioning that all of the issues associated with modulator imperfections can be avoided with a slightly different transmit architecture. Many modern DACs incorporate complex modulators, that is, digital engines that convert baseband I and Q data up to a low intermediate frequency (IF). These signals, which are still in Cartesian I and Q format, drive the IQ modulator. Because modern IQ modulators, such as the [ADL5375](#), have baseband input bandwidths of as high as 750 MHz, low IFs in the 100 MHz to 250 MHz range can be easily accommodated. When an IQ modulator is driven by such a signal, the output spectrum is essentially a single sideband spectrum similar to what is shown in Figure 3.

The lower sideband becomes the modulated carrier and is displaced from the LO by a frequency offset equal to the intermediate frequency. The imperfections of the IQ modulator now manifest themselves as out-of-band effects, which can be filtered away, resulting in in-band EVM, which is not affected by the IQ modulator's imperfections.

However, this approach comes at some cost. Care must be taken to filter out the LO leakage along with the undesired upper sideband. In contrast, a Nyquist filtered zero IF spectrum is completely free of spurious components apart from harmonics of the LO. In addition, as the frequency of the low IF increases, the distortion of the DAC and IQ modulator increases slightly.

## CONCLUSIONS

While modern IQ modulators offer excellent out-of-the-box quadrature accuracy, IQ gain imbalance, and LO leakage, their performance can be improved further using calibration. If the transmitter incorporates a loop-back receiver as part of a digital predistortion scheme, the receiver can also be used to continuously monitor and correct the imperfections of the IQ modulator. The post-calibration performance is only limited by the available compensation step sizes and the ability of the receiver to precisely measure the constellation degradation.

In transmitters that do not contain a loop-back receiver, factory calibration is a reasonable alternative. A single calibration in the middle of a operating band most likely causes degradation at the band edges. As a result, calibration at multiple frequencies within a band is more effective. When temperature drift is factored in, factory calibration at the ambient temperature typically improves LO leakage and sideband suppression by around 10 dB to 15 dB.