

FEATURES**Two Output Voltages: 5.0 V, 3.3 V****Output Current: 3 A****Input voltage: 8.0-16.0 V****Ripple 2% ppk of Output Voltage****Transient step $\pm 5\%$, 50% max load****ADP1829 DESCRIPTION**

This ADP1829 reference design uses 8.0 V to 16.0 V for the input voltage. The output voltages and currents are as follows:

- $V_{OUT1} = 5.0$ V with a maximum output current of 3.0 A,
- $V_{OUT2} = 3.3$ V with a maximum output current of 3.0 A.

Design criteria require no tracking or sequencing. The ripple and transient assumptions are 2% peak to peak voltage ripple (for the switchers) and 5% deviation due to 50% instantaneous load step respectively. The nominal switching frequency is fixed at 300 kHz.

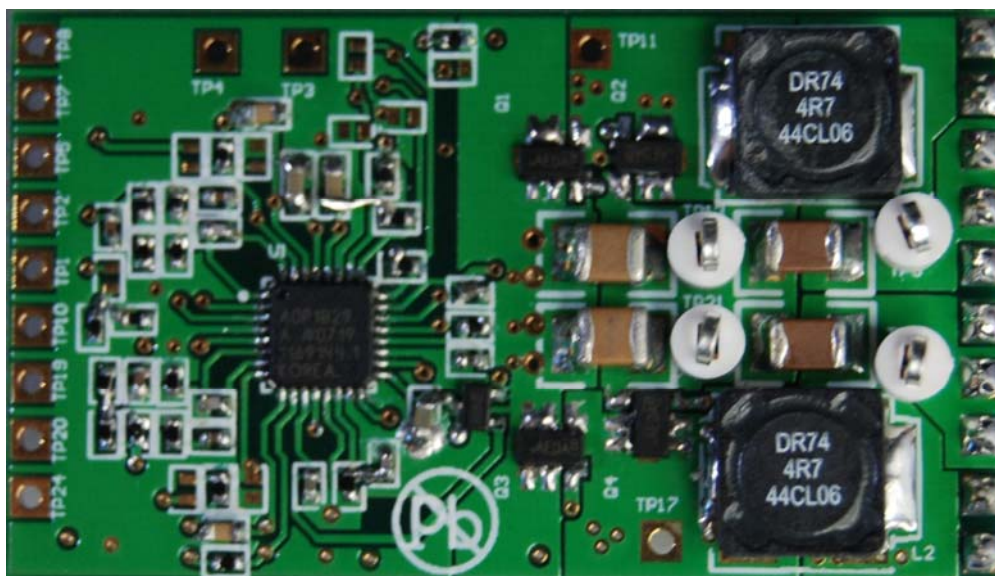

Figure 1. ADP1829 Evaluation Board

Rev. 0

Reference designs are as supplied "as is" and without warranties of any kind, express, implied, or statutory including, but not limited to, any implied warranty of merchantability or fitness for a particular purpose. No license is granted by implication or otherwise under any patents or other intellectual property by application or use of reference designs. Information furnished by Analog Devices is believed to be accurate and reliable. However, no responsibility is assumed by Analog Devices for its use, nor for any infringements of patents or other rights of third parties that may result from its use. Analog Devices reserves the right to change devices or specifications at any time without notice. Trademarks and registered trademarks are the property of their respective owners. Reference designs are not authorized to be used in life support devices or systems.

TABLE OF CONTENTS

Features.....	1
ADP1829 Description	1
Revision History.....	3
General Description	4
ADP1829.....	4
Schematic	5
Bill of Materials	6
Assembly Drawing.....	7
Powering the ADP1829.....	8
Input Power Source	8
Output Load	8
Input and Output Voltmeters.....	8
Turning On the Evaluation Board.....	9
Typical Performance Characteristics.....	10

TABLE OF FIGURES

Figure 1. ADP1829 Evaluation Board.....	1
Figure 2. Schematic: V_{OUT1} and V_{OUT2}	5
Figure 3. Top Assembly Drawing for 1829 Evaluation Board.....	7
Figure 4. Bottom Assembly Drawing for 1829 Evaluation Board (looking through from top)	7
Figure 5. Efficiency.....	10
Figure 6. Normalized Load Regulation	10
Figure 7. Switching regulator turn on at no load: Ch1 = 3.3 V, Ch2 = 5.0 V, Ch4 = V_{in}	11
Figure 8. Switching regulator turn on at full load: Ch1 = 3.3 V, Ch2 = 5.0 V, Ch4 = V_{in}	11
Figure 9. Switching regulator turn off at no load: Ch1 = 3.3 V, Ch2 = 5.0 V, Ch4 = V_{in}	12
Figure 10. Switching regulator turn off at full load: Ch1 = 3.3 V, Ch2 = 5.0 V, Ch4 = V_{in}	12
Figure 11. Switching regulator ripple and noise at no load: Ch1 = 3.3 V, Ch2 = 5.0 V, Ch4 = V_{in} @ 8.0 V.....	13
Figure 12. Switching regulator ripple and noise at full load: Ch1 = 3.3 V, Ch2 = 5.0 V, Ch4 = V_{in} @ 8.0 V	13
Figure 13. Switching regulator ripple and noise at no load: Ch1 = 3.3 V, Ch2 = 5.0 V, Ch4 = V_{in} @ 16.0 V	14
Figure 14. Switching regulator ripple and noise at full load: Ch1 = 3.3 V, Ch2 = 5.0 V, Ch4 = V_{in} @ 16.0 V	14
Figure 15. Transient 50% to 100% load: Ch1 = 3.3 V, Ch2 = 5.0 V, Ch4 = V_{in} @ 8.0 V.....	15
Figure 16. Transient 50% to 100% load: Ch1 = 3.3 V, Ch2 = 5.0 V, Ch4 = V_{in} @ 16.0 V	15
Figure 17. Transient 100% to 50% load: Ch1 = 3.3 V, Ch2 = 5.0 V, Ch4 = V_{in} @ 8.0 V	16
Figure 18. Transient 100% to 50% load: Ch1 = 3.3 V, Ch2 = 5.0 V, Ch4 = V_{in} @ 16.0 V	16

REVISION HISTORY

11/19/2007—Revision 0: Initial Version

GENERAL DESCRIPTION

ADP1829

The ADP1829 is a versatile, dual output, interleaved, synchronous PWM buck controller that generates two independent outputs from an input voltage of 2.9 V to 18 V. Each channel can be configured to provide output voltage from 0.6V to 85% of the input voltage. The two channels operate 180° out of phase, which reduces the current stress on the input capacitor and allows the use of a smaller and lower cost input capacitor.

The ADP1829 operates at a pin-selectable fixed switching frequency of either 300 kHz or 600 kHz. For some noise sensitive applications, it can also be synchronized to an external clock to achieve switching frequency between 300 kHz and 1 MHz. The switching frequency chosen is 300 kHz to get good efficiency over a wide range of input and output conditions.

The ADP1829 includes an adjustable soft start to limit input inrush current, voltage tracking for sequencing or DDR termination, independent power-good output, and a power enable pin. It also provides current-limit and short-circuit protection by sensing the voltage on the synchronous MOSFET.

SCHEMATIC

5.0V at 2.0A and 3.3V at 2.0A

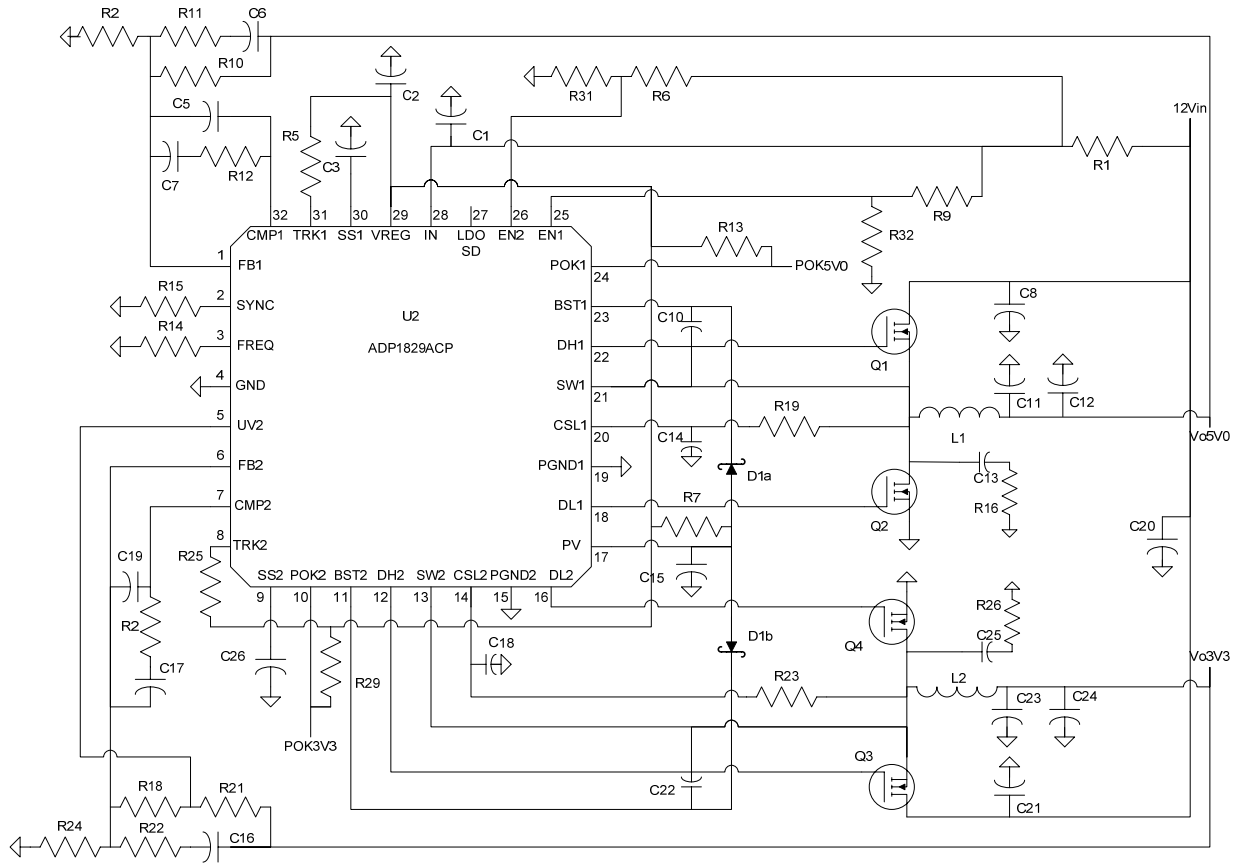

Figure 2. Schematic: V_{OUT1} and V_{OUT2}

BILL OF MATERIALS**Table 1. Vout1, and Vout2 Bill of Materials (Vo5V0 and Vo3V3)**

Description	Designator	Qty	Manufacturer	MFR#
Cap Ceramic C0G 100p 0402 50V	C5, C19	2	Vishay	Generic
Cap Ceramic X5R 1u 0603 16V	C2, C15	2	Murata	GRM188R61C105K
Cap Ceramic X5R 1u 0603 25V	C1	1	Murata	GRM188R61E105K
Cap Ceramic X7R 47n 0402 10V	C3, C26	2	Vishay	Generic
Cap Ceramic X7R 22u 1210 25V	C8, C21	2	Murata	CGRM32ER61E226K
Cap Polymer 22u 7343 20V	C20	1	Kemet	T520V226M020ATE090
Cap Ceramic X5R 22u 1210 10V	C12, C24	2	TDK	C3225X5R1A226M
Cap Ceramic X7R 100n 0402 16V	C10, C22	2	Murata	GRM155R71C104KA88D
Cap Ceramic C0G 33p 0402 50V	C14, C18	2	Vishay	Generic
Cap Ceramic COG 470p 0402 50V	C6, C16	2	Vishay	Generic
Cap Ceramic X7R 3.3n 0402 50V	C7, C17	2	Vishay	Generic
Diode Dual Schottky 200mA SOT-323 30V	D1	1	Diodes inc	BAT54AW
Inductor Ferrite 4.7uH 7.6mm x 7.6mm	L1, L2	2	Coiltronics	DR74-4R7-R
Single N-Channel MOSFET 1206-8 30V	Q1, Q2, Q3, Q4	4	Vishay	Si5404bdc
Res 5% Thick Film 10 Ohms 0402	R1, R7	2	Vishay	Generic
Res 1% Thick Film 10.0k 0402	R6, R9, R13, R29	4	Vishay	Generic
Res 1% Thick Film 5.11k 0402	R12, R20	2	Vishay	Generic
Res 1% Thick Film 20.0k 0402	R10, R21	2	Vishay	Generic
Res 1% Thick Film 2.74k 0402	R2	1	Vishay	Generic
Res 1% Thick Film 100 Ohms 0402	R11, R22	2	Vishay	Generic
Res 1% Thick Film 4.42k 0402	R24	1	Vishay	Generic
Res 1% Thick Film 4.53k 0402	R19, R23	2	Vishay	Generic
2 chan 300k to 600k PWM LFCSP-32	U1	1	Analog	ADP1829ACPZ

ASSEMBLY DRAWING

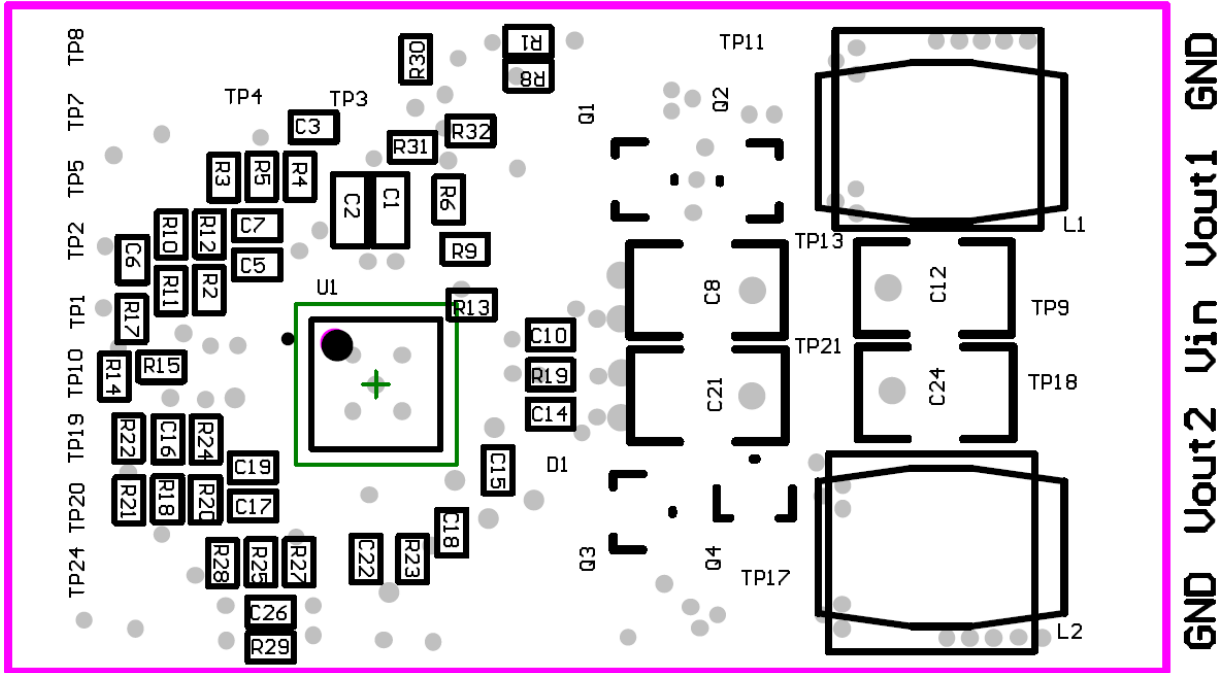

Figure 3. Top Assembly Drawing for 1829 Evaluation Board

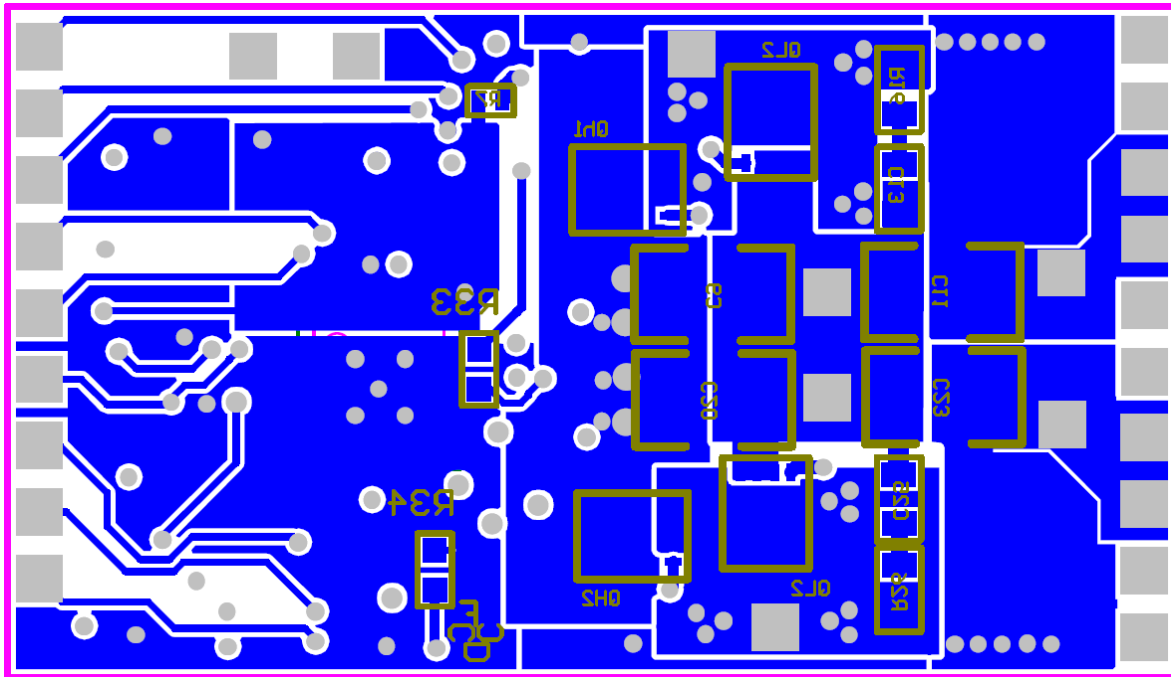

Figure 4. Bottom Assembly Drawing for 1829 Evaluation Board (looking through from top)

POWERING THE ADP1829

The ADP1829 is supplied fully assembled.

INPUT POWER SOURCE

1. Before connecting the power source to the ADP1829, make sure that it is turned off. If the input power source includes a current meter, use that meter to monitor the input current.
2. Connect the positive terminal of the power source to the VIN terminal on the evaluation board, and the negative terminal of the power source to the GND terminal just below the VIN terminal.
3. If the power source does not include a current meter, connect a current meter in series with the input source voltage.
4. Connect the positive lead (+) of the power source to the ammeter positive (+) connection, the negative lead (–) of the power source to the GND pins on the board, and the negative lead (–) of the ammeter to the VIN pins on the board.

OUTPUT LOAD

1. Although the ADP1829 can sustain the sudden connection of the load, it is possible to damage the load if it is not properly connected.
2. Make sure that the board is turned off before connecting the load.
 - a) If the load includes an ammeter, or if the current is not measured, connect the load directly to the evaluation board with the positive (+) load connection to the V_{OUT} pins and negative (–) load connection to the GND pins next to the V_{OUT} pins.
 - b) If an ammeter is used, connect it in series with the load; connect the positive (+) ammeter terminal to the evaluation board V_{OUT} pins, the negative (–) ammeter terminal to the positive (+) load terminal, and the negative (–) load terminal to the evaluation board GND pins next to the V_{OUT} pins.
 - c) Repeat for the other V_{OUT} channel.

Once the loads are connected, make sure that they are set to the proper current before powering the ADP1829.

INPUT AND OUTPUT VOLTMETERS

Measure the input and output voltages with voltmeters.

1. Connect the voltmeter measuring the input voltage with the positive (+) lead connected to the VIN pins on the test board and the negative lead (–) connected to the GND test point between the inductors (TP13 or TP21).
2. Connect the voltmeter measuring V_{OUT1} with the positive lead (+) connected to the test point near the V_{OUT1} pins (TP9) and the negative lead (–) connected to the adjacent GND test point (TP13).
3. Connect the voltmeter measuring V_{OUT2} in the same manner (between TP8 and TP21).
4. Make sure to connect the voltmeters to the appropriate evaluation board test points and not to the load or power source themselves.
5. If the voltmeters are not connected directly to the evaluation board at these connection points, the measured voltages will be incorrect due to the voltage drop across the leads connecting the evaluation board to both the source and load.

TURNING ON THE EVALUATION BOARD

Once the power source and loads are connected to the ADP1829, the board can be powered for operation. Slowly increase the input power source voltage until the input voltage exceeds the minimum input operating voltage of 8.0 V. If the load is not already enabled, enable the load and check that it is drawing the proper current and that the output voltage maintains voltage regulation.

TYPICAL PERFORMANCE CHARACTERISTICS

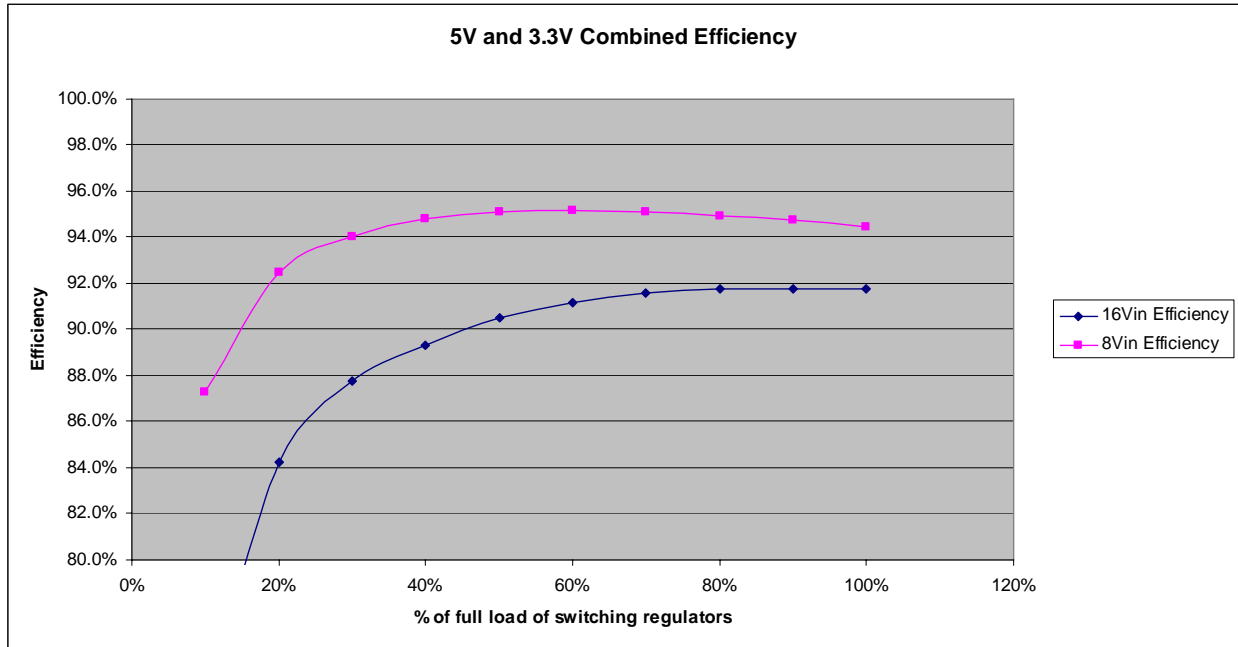

Figure 5. Efficiency

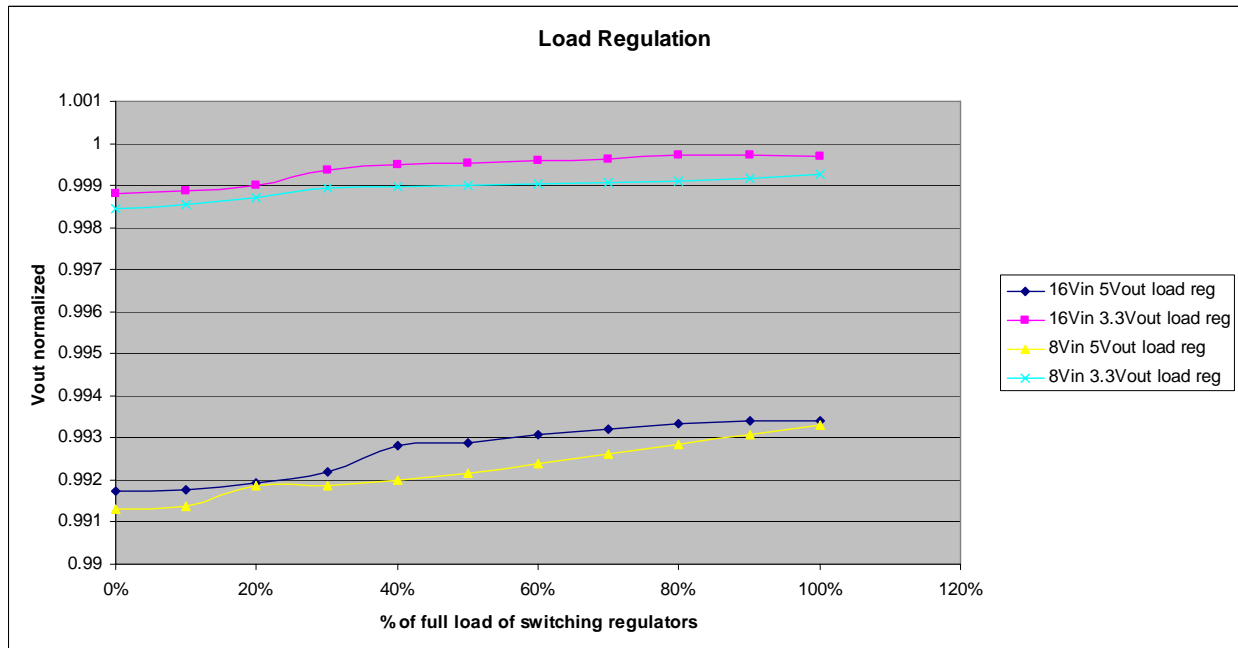

Figure 6. Normalized Load Regulation

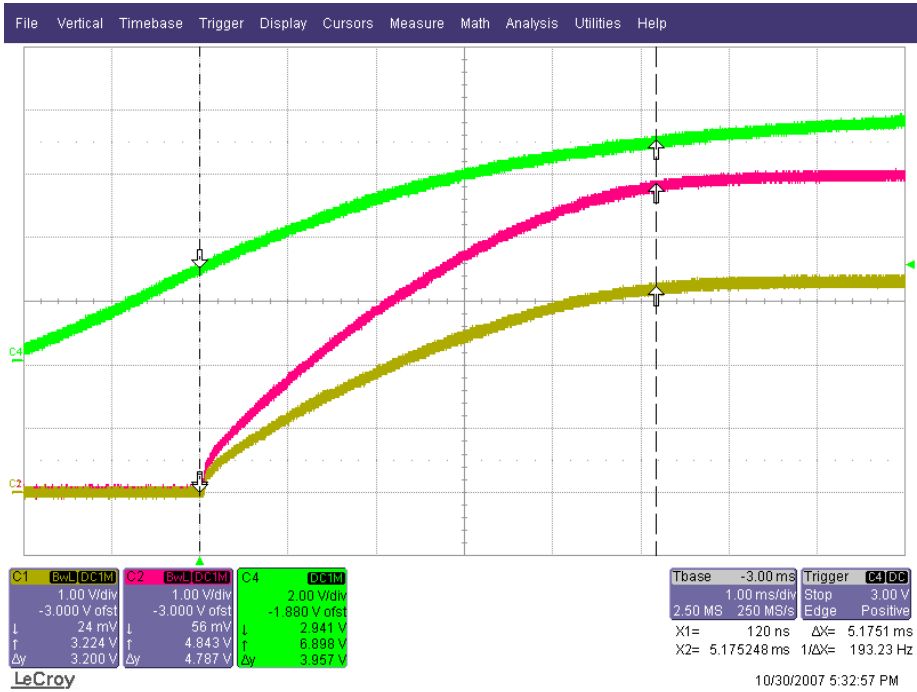

Figure 7. Switching regulator turn on at no load: Ch1 = 3.3 V, Ch2 = 5.0 V, Ch4 = Vin

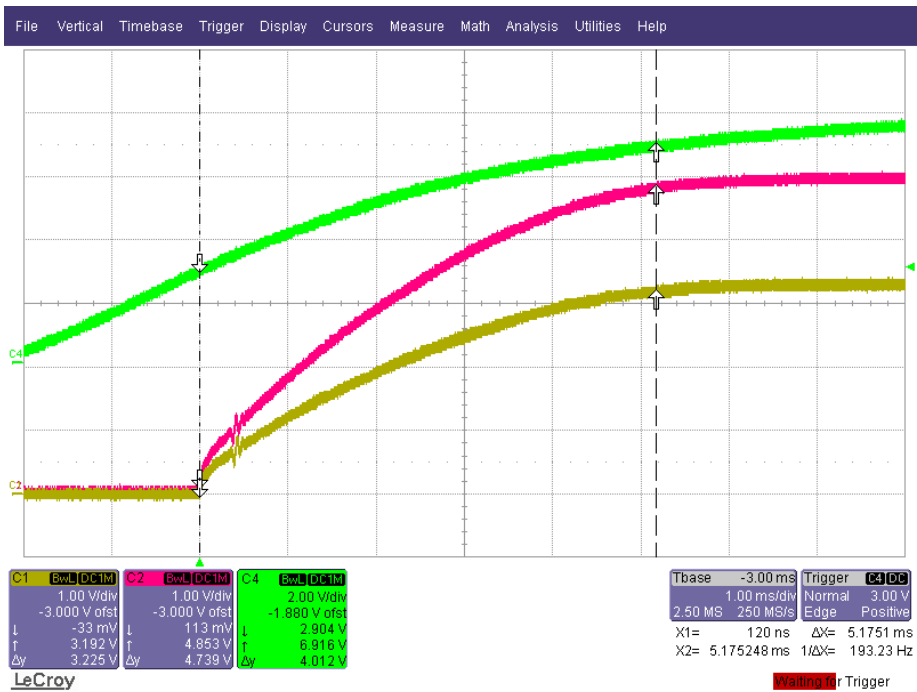

Figure 8. Switching regulator turn on at full load: Ch1 = 3.3 V, Ch2 = 5.0 V, Ch4 = Vin

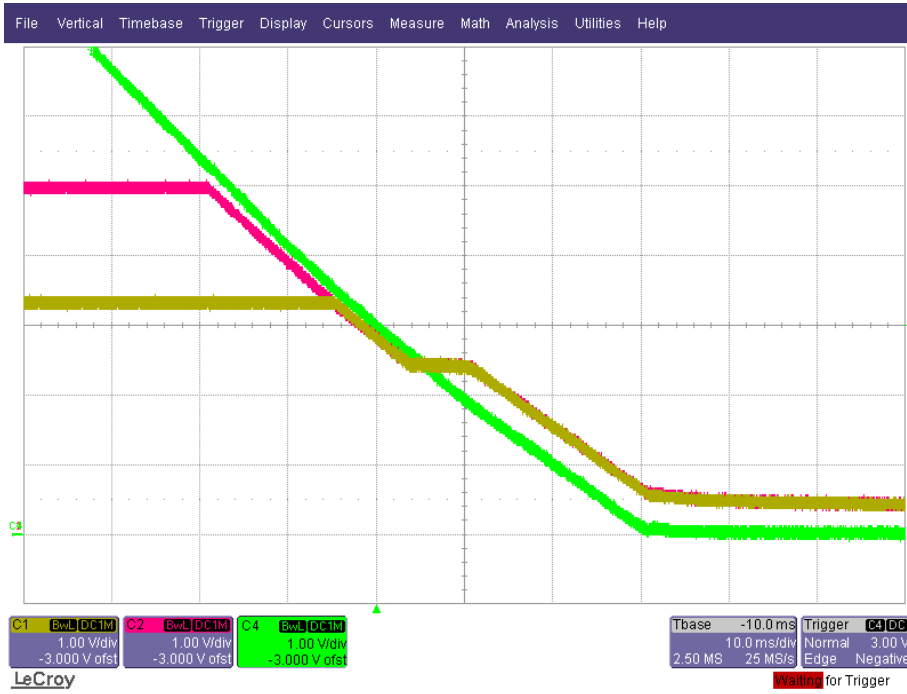

Figure 9. Switching regulator turn off at no load: Ch1 = 3.3 V, Ch2 = 5.0 V, Ch4 = Vin



Figure 10. Switching regulator turn off at full load: Ch1 = 3.3 V, Ch2 = 5.0 V, Ch4 = Vin

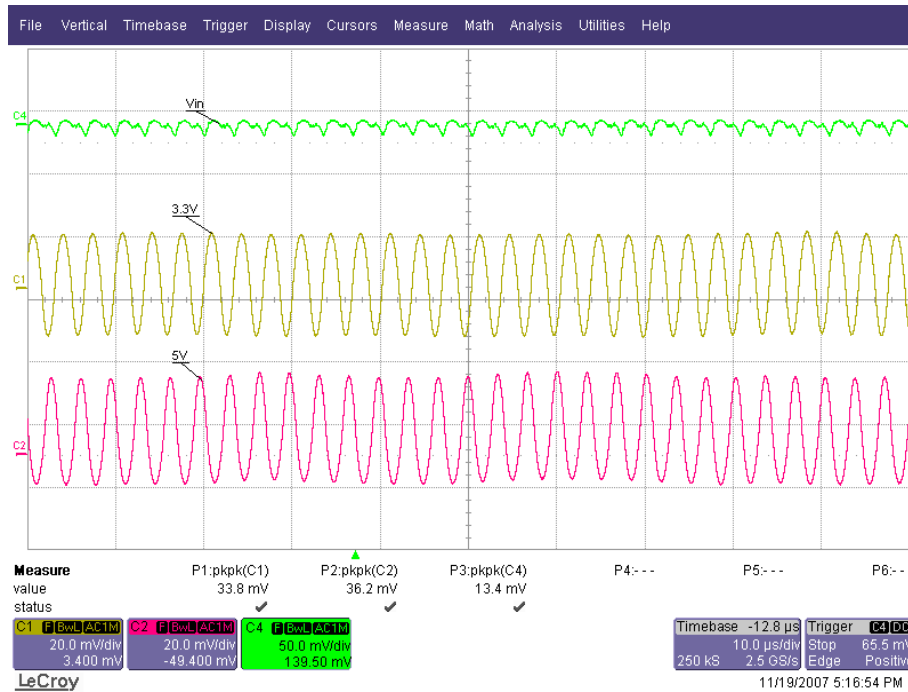

Figure 11. Switching regulator ripple and noise at no load: Ch1 = 3.3 V, Ch2 = 5.0 V, Ch4 = Vin @ 8.0 V

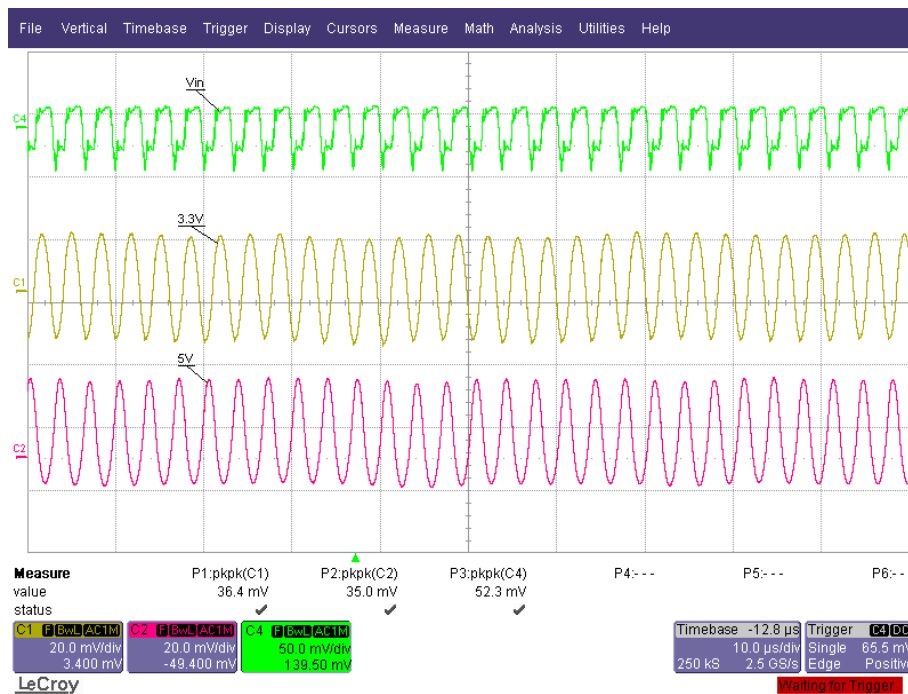

Figure 12. Switching regulator ripple and noise at full load: Ch1 = 3.3 V, Ch2 = 5.0 V, Ch4 = Vin @ 8.0 V



Figure 13. Switching regulator ripple and noise at no load: Ch1 = 3.3 V, Ch2 = 5.0 V, Ch4 = Vin @ 16.0 V



Figure 14. Switching regulator ripple and noise at full load: Ch1 = 3.3 V, Ch2 = 5.0 V, Ch4 = Vin @ 16.0 V

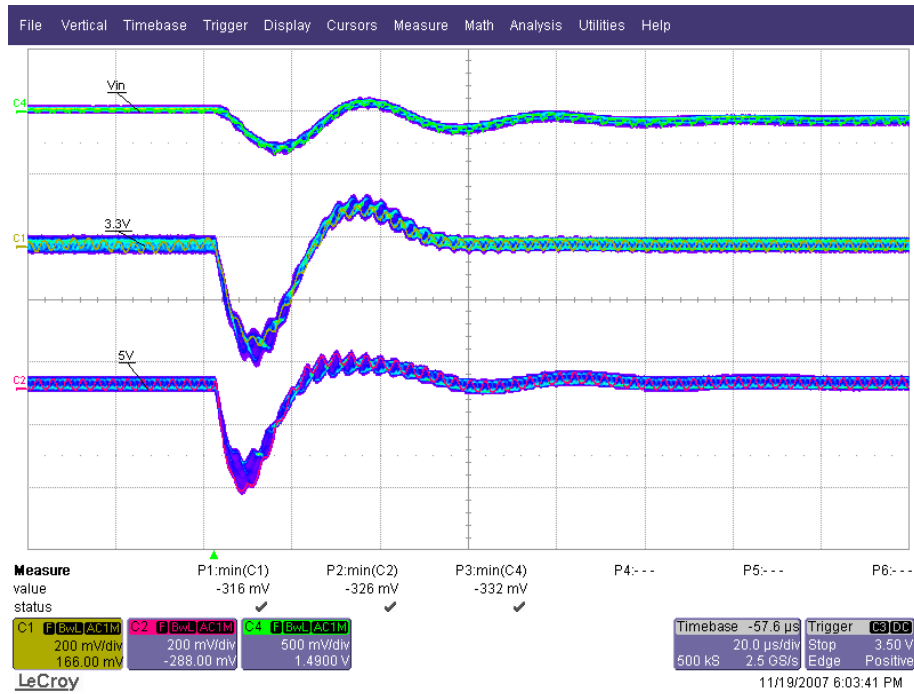

Figure 15. Transient 50% to 100% load: Ch1 = 3.3 V, Ch2 = 5.0 V, Ch4 = Vin @ 8.0 V

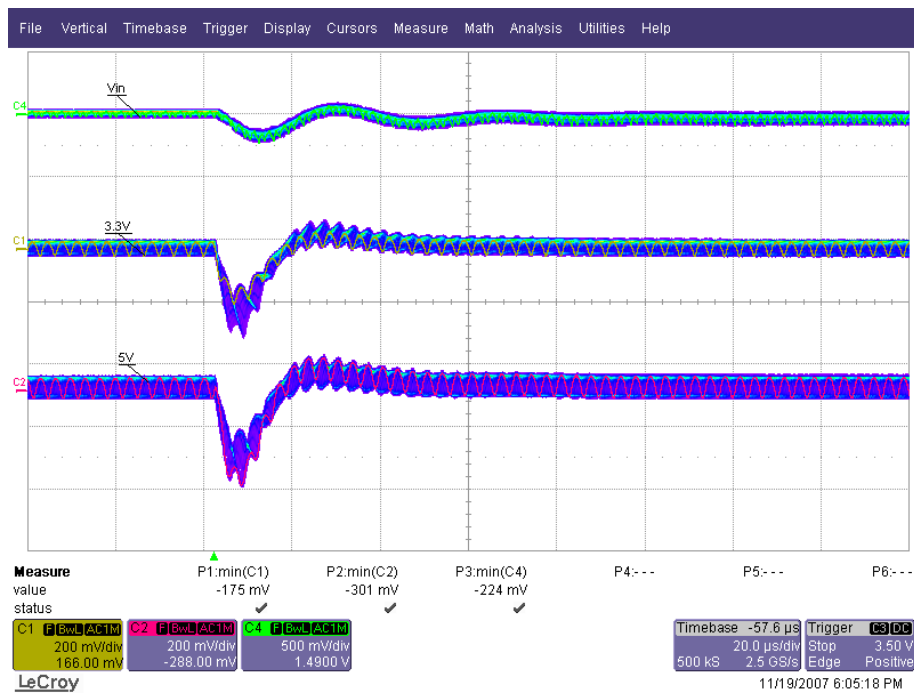

Figure 16. Transient 50% to 100% load: Ch1 = 3.3 V, Ch2 = 5.0 V, Ch4 = Vin @ 16.0 V

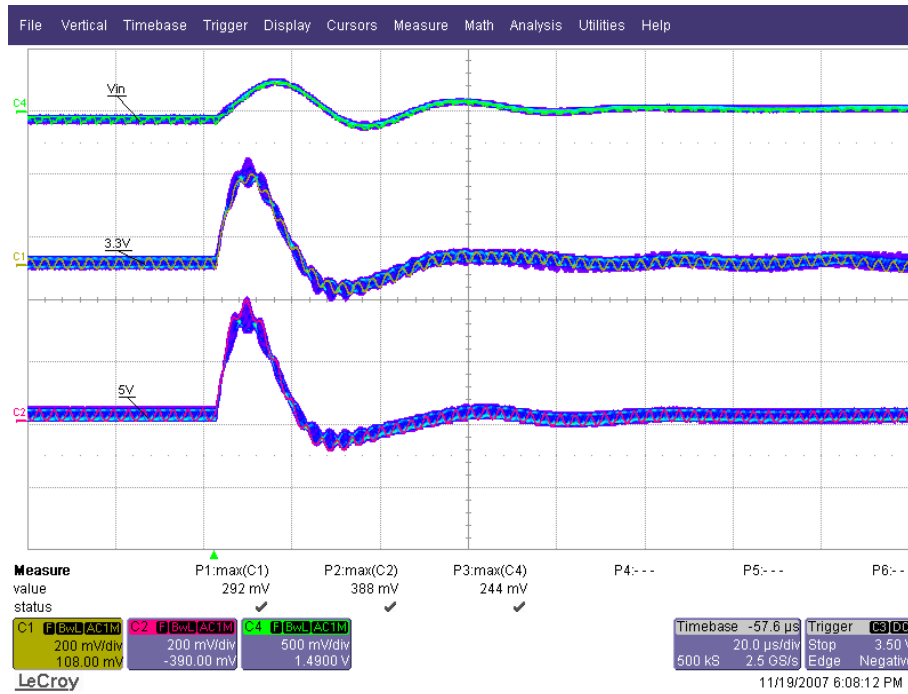

Figure 17. Transient 100% to 50% load: Ch1 = 3.3 V, Ch2 = 5.0 V, Ch4 = Vin @ 8.0 V

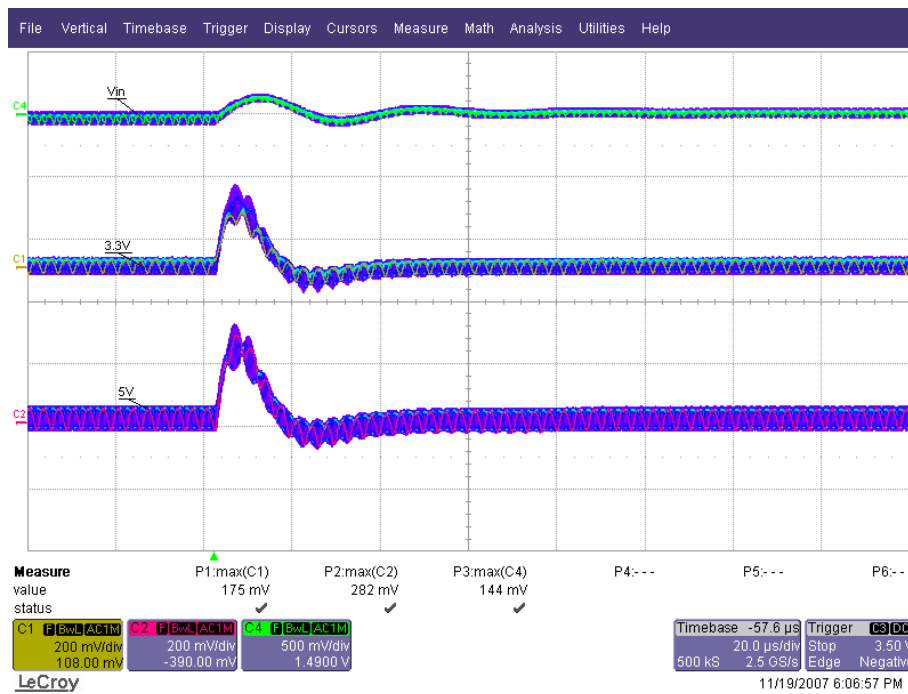

Figure 18. Transient 100% to 50% load: Ch1 = 3.3 V, Ch2 = 5.0 V, Ch4 = Vin @ 16.0 V

NOTES

©2007 Analog Devices, Inc. All rights reserved.
Trademarks and registered trademarks are the
property of their respective owners.

EB



**ANALOG
DEVICES**

www.analog.com