

**FEATURES****Four Output Voltages: 1.2 V, 1.8 V, 3.3 V, 5 V****Output Current: 1 A to 3.5 A****Input voltage: 10.8-13.2 V****Ripple 50 mV ppk****Transient step  $\pm 5\%$ , 50% max load****ADP1877 REFERENCE DESIGN DESCRIPTION**

This ADP1877 Reference Design uses 10.8 V to 13.2 V for the input voltage. The output voltages and currents are as follows:

- $V_{OUT1} = 1.2$  V with a maximum output current of 3.5 A,
- $V_{OUT2} = 1.8$  V with a maximum output current of 1.4 A,
- $V_{OUT3} = 3.3$  V with a maximum output current of 2.1 A,
- $V_{OUT4} = 5.0$  V with a maximum output current of 2.2 A,

Design criteria are for coincidental tracking of  $V_{OUT1}$ ,  $V_{OUT2}$  and  $V_{OUT3}$  with  $V_{OUT4}$  for both turn on and turn off. The ripple and transient assumptions are 50 mV peak to peak voltage ripple and 5% deviation due to 50% instantaneous load step. The switching frequency is fixed at 700 kHz for  $V_{OUT1}$  and  $V_{OUT2}$ , 1000kHz for  $V_{OUT3}$  and  $V_{OUT4}$ .

**Rev. 0**

Reference designs are as supplied "as is" and without warranties of any kind, express, implied, or statutory including, but not limited to, any implied warranty of merchantability or fitness for a particular purpose. No license is granted by implication or otherwise under any patents or other intellectual property by application or use of reference designs. Information furnished by Analog Devices is believed to be accurate and reliable. However, no responsibility is assumed by Analog Devices for its use, nor for any infringements of patents or other rights of third parties that may result from its use. Analog Devices reserves the right to change devices or specifications at any time without notice. Trademarks and registered trademarks are the property of their respective owners. Reference designs are not authorized to be used in life support devices or systems.

## TABLE OF CONTENTS

Features.....	1
ADP1877 Reference Design Description .....	1
Revision History.....	2
General Description .....	3
ADP1877.....	3
Typical Performance Characteristics.....	4
Schematic.....	10

## TABLE OF FIGURES

Figure 1. Calculated efficiency of 1.2V output.....	4
Figure 2. Calculated efficiency of 1.8V output.....	4
Figure 3. Calculated efficiency of 3.3V output.....	5
Figure 4. Calculated efficiency of 5.0V output.....	5
Figure 5. Calculated efficiency of 3.3V output with 2xSi2304BDS high and 2xSi2304BDS low.....	6
Figure 6. Calculated gain and phase of 1.8V output with additional 15x10uF ceramic.....	6
Figure 7. Calculated gain and phase of 3.3V output with additional 40uF of aluminum electrolytic and 225uF of ceramic	7
Figure 8. Calculated gain and phase of 5.0V output with additional 300uF of aluminum electrolytic and 2x10uF ceramic	7
Figure 9. Calculated ripple and transient of 1.2V output with additional 10uF ceramic.....	8
Figure 10. Calculated ripple and transient of 1.8V output with additional 15x10uF ceramic .....	8
Figure 11. Calculated ripple and transient of 3.3V output with additional 40uF of aluminum electrolytic and 225uF of ceramic	9
Figure 12. Calculated ripple and transient of 5.0V output with additional 300uF of aluminum electrolytic and 2x10uF ceramic	9
Figure 13. Schematic: $V_{OUT1}$ and $V_{OUT2}$ .....	10
Figure 14. Schematic: $V_{OUT3}$ , $V_{OUT4}$ .....	11

## REVISION HISTORY

2/12/2009—Revision 0: Initial Version

## GENERAL DESCRIPTION

### **ADP1877**

The ADP1877 is a current mode dual-phase step-down switching controller with integrated drivers that drive Nchannel synchronous power MOSFETs. The two PWM outputs are phase shifted 180°, which reduces the input RMS current thus minimizing required input capacitance.

The boost diodes are built into the ADP1877, thus lowering the overall system cost and component count. The ADP1877 can be set to operate in pulse skip high efficiency mode under light load or in forced PWM (continuous conduction mode).

The ADP1877 includes programmable soft start, output overvoltage protection, programmable current limit, power good, tracking function, and programmable oscillator frequency that ranges from 200 kHz to 1.5 MHz. The ADP1877 provides an output voltage accuracy of  $\pm 1\%$  over temperature, superior transient response and reduced output capacitance. This part can be powered from a 2.75V to 15V supply and is available in 32 pin LFCSP package.

## TYPICAL PERFORMANCE CHARACTERISTICS

Figure 1. Calculated efficiency of 1.2V output

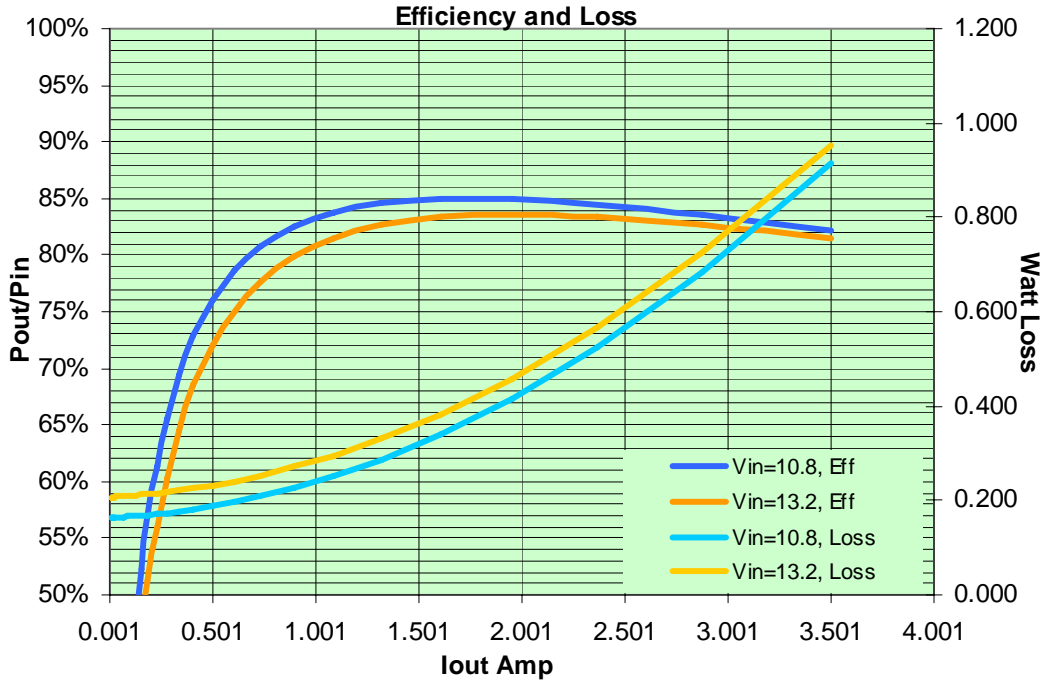

Figure 2. Calculated efficiency of 1.8V output

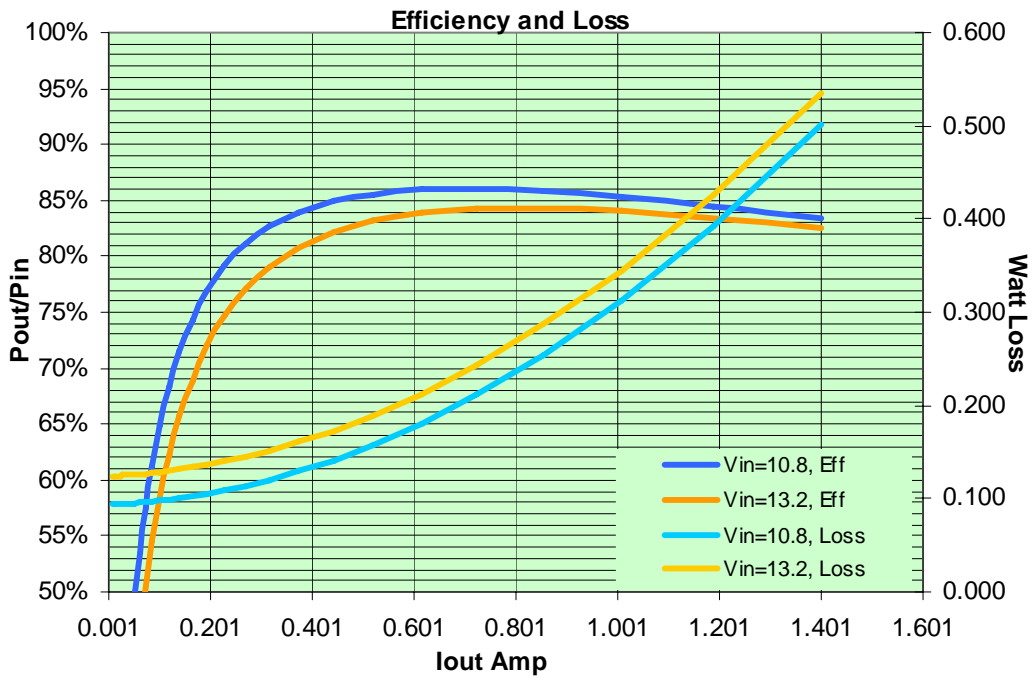

Figure 3. Calculated efficiency of 3.3V output

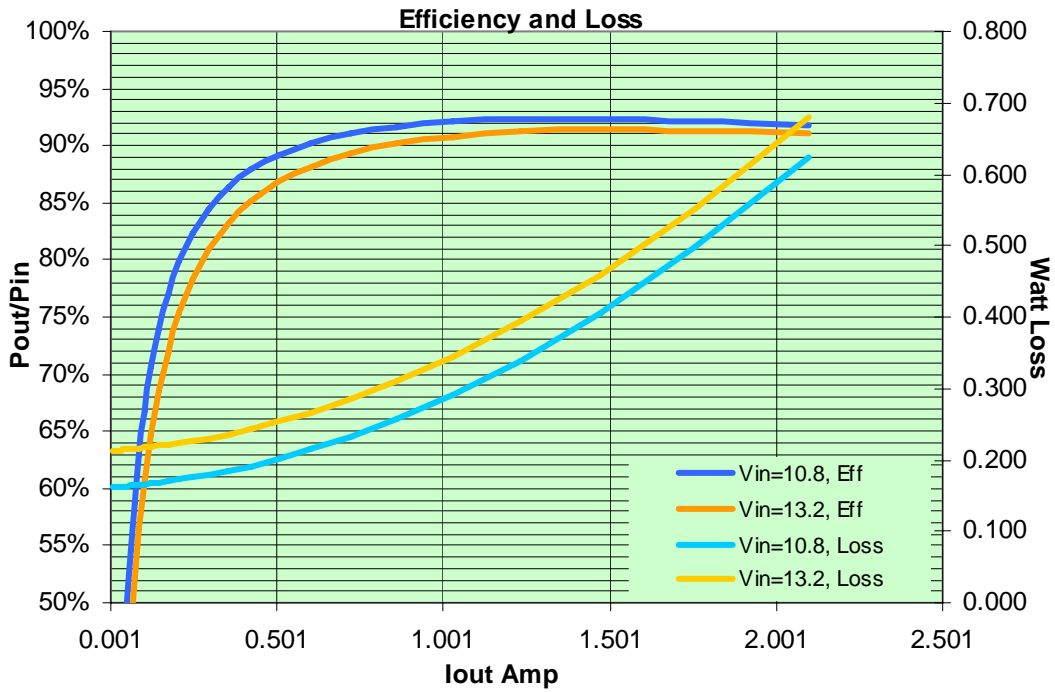

Figure 4. Calculated efficiency of 5.0V output

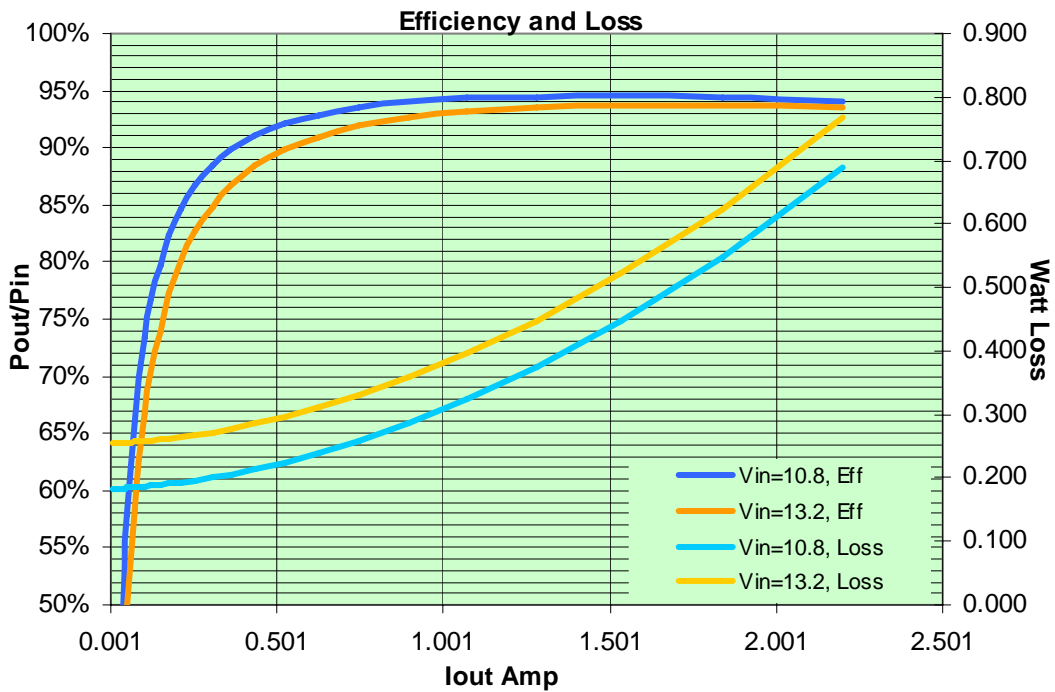

Figure 5. Calculated efficiency of 3.3V output with 2xSi2304BDS high and 2xSi2304BDS low

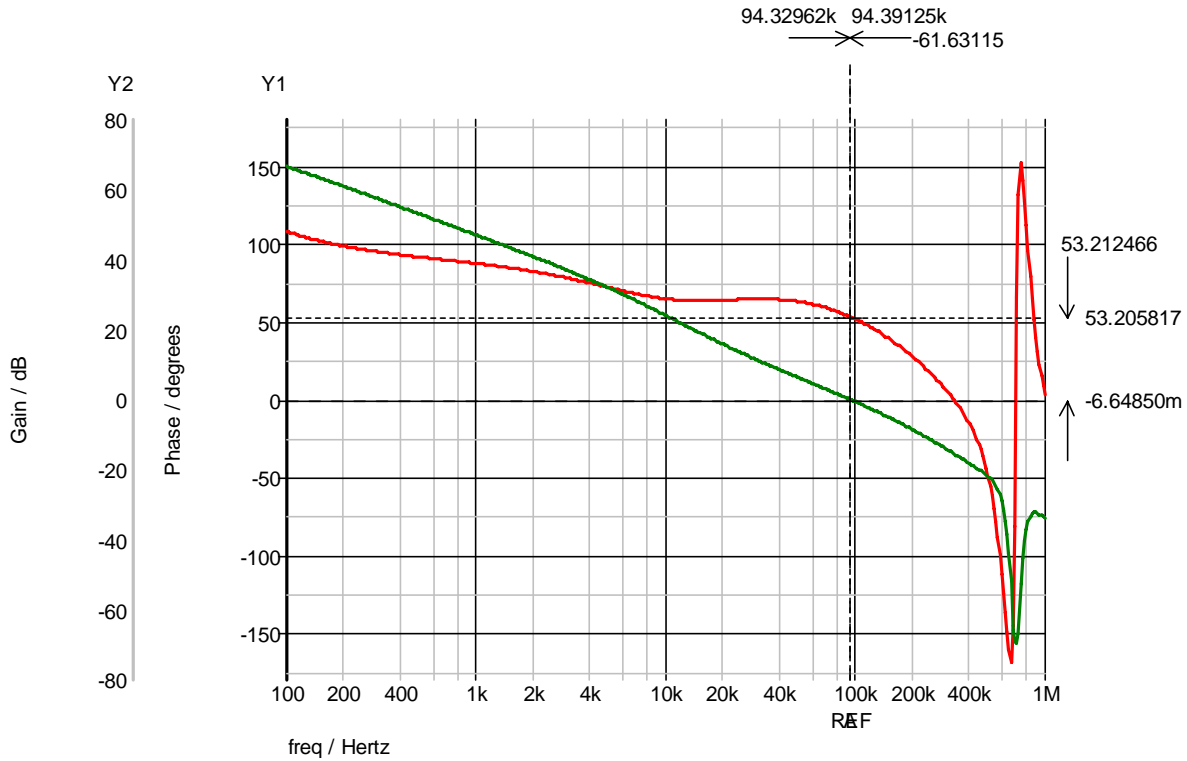

Figure 6. Calculated gain and phase of 1.8V output with additional 15x10uF ceramic

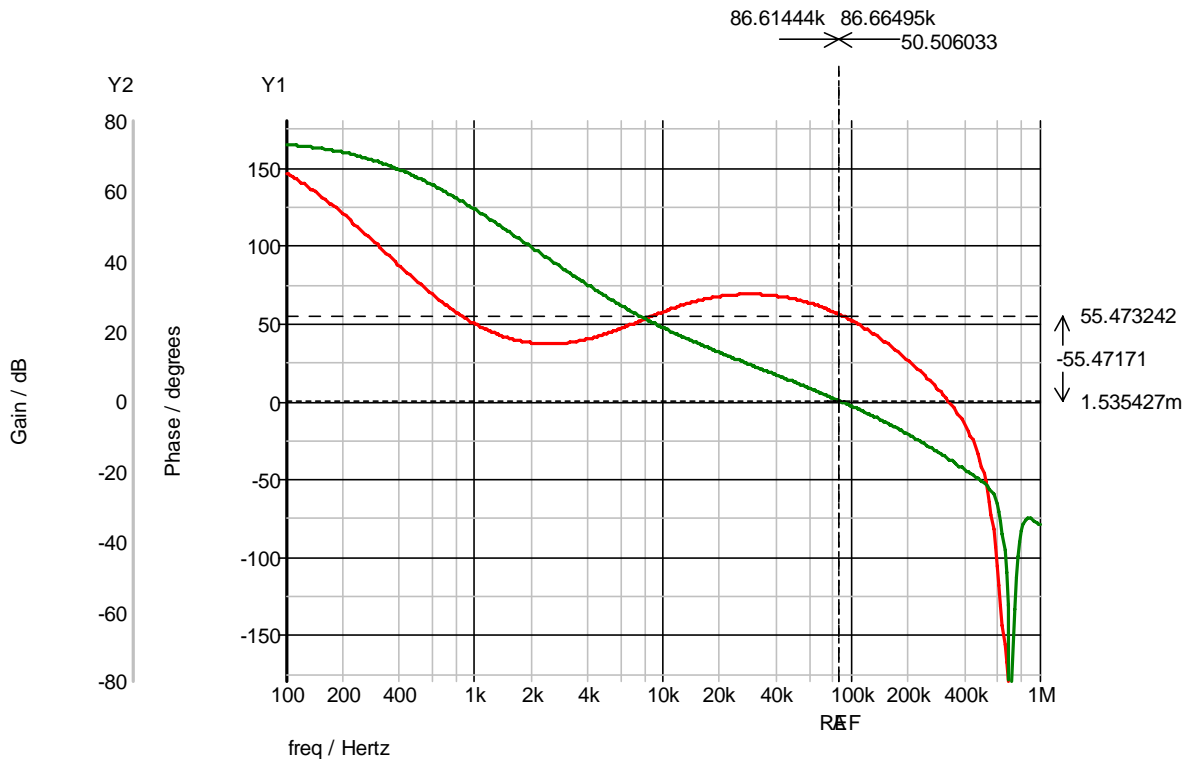

Figure 7. Calculated gain and phase of 3.3V output with additional 40uF of aluminum electrolytic and 225uF of ceramic

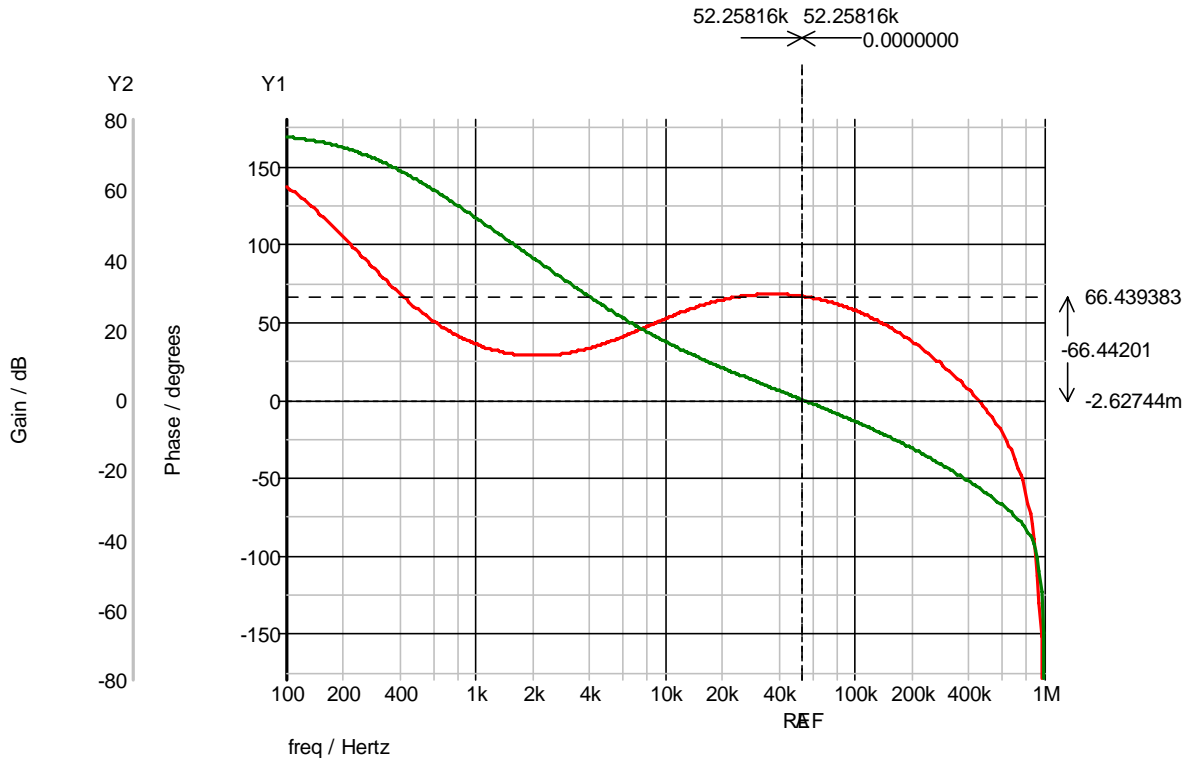

Figure 8. Calculated gain and phase of 5.0V output with additional 300uF of aluminum electrolytic and 2x10uF ceramic

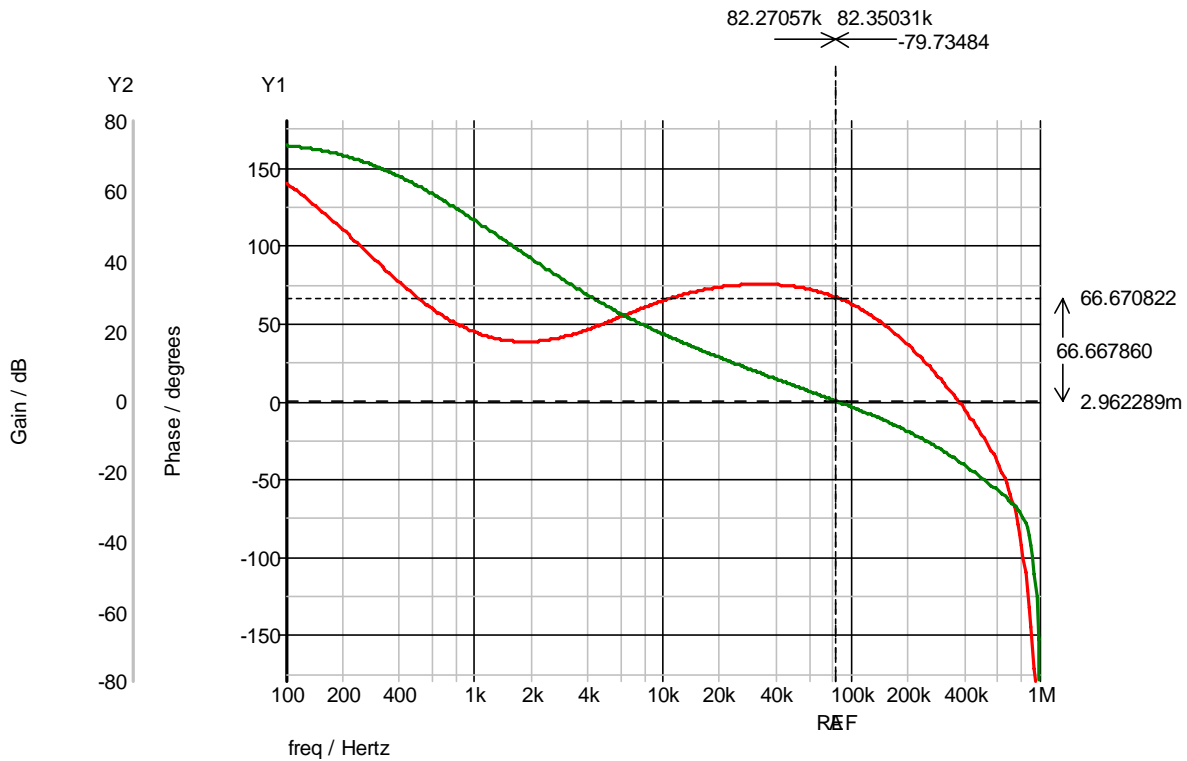

Figure 9. Calculated ripple and transient of 1.2V output with additional 10uF ceramic

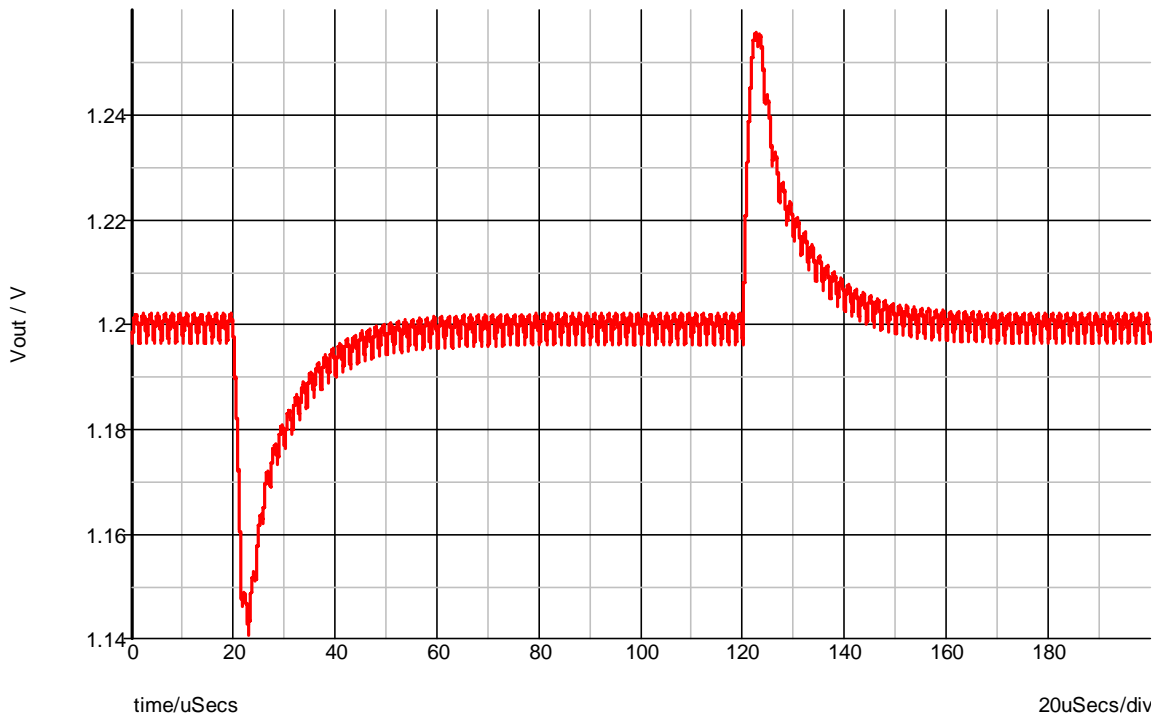

Figure 10. Calculated ripple and transient of 1.8V output with additional 15x10uF ceramic

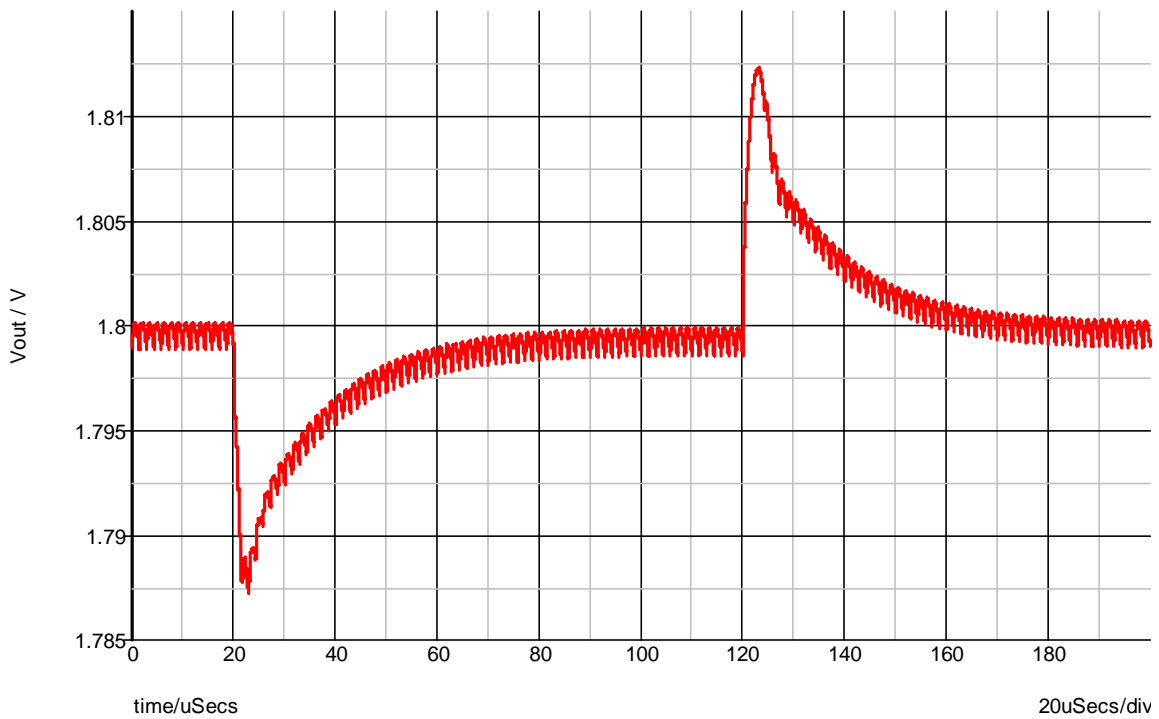



Figure 11. Calculated ripple and transient of 3.3V output with additional 40uF of aluminum electrolytic and 225uF of ceramic

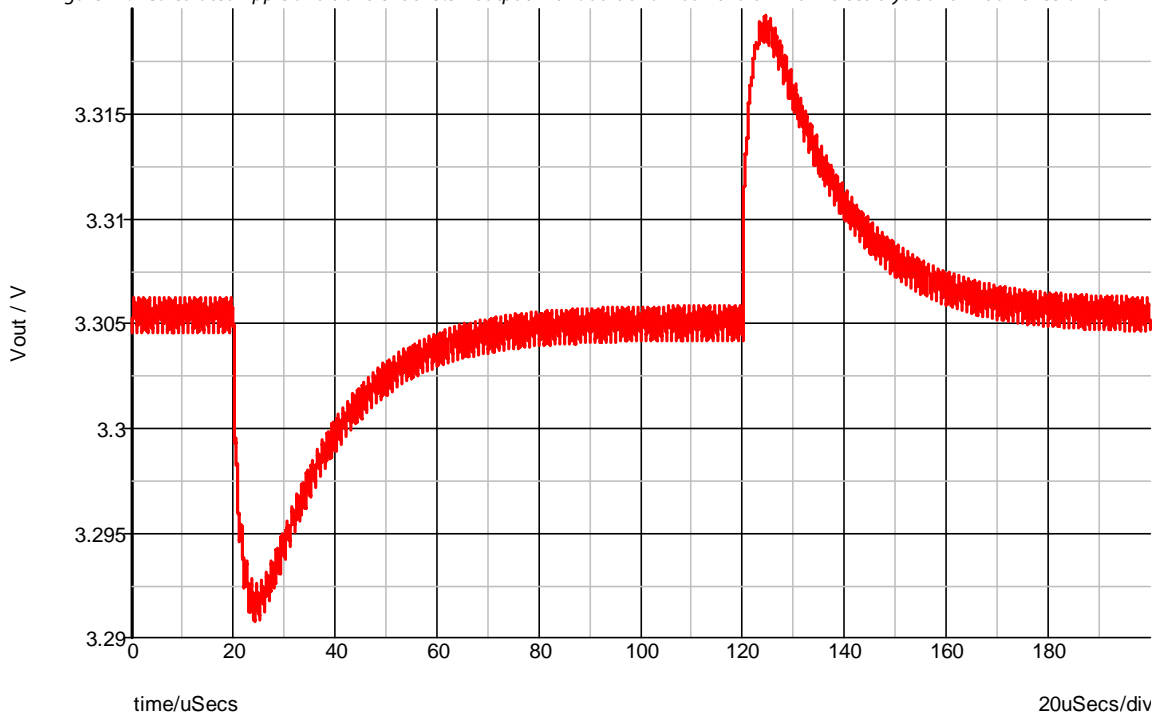
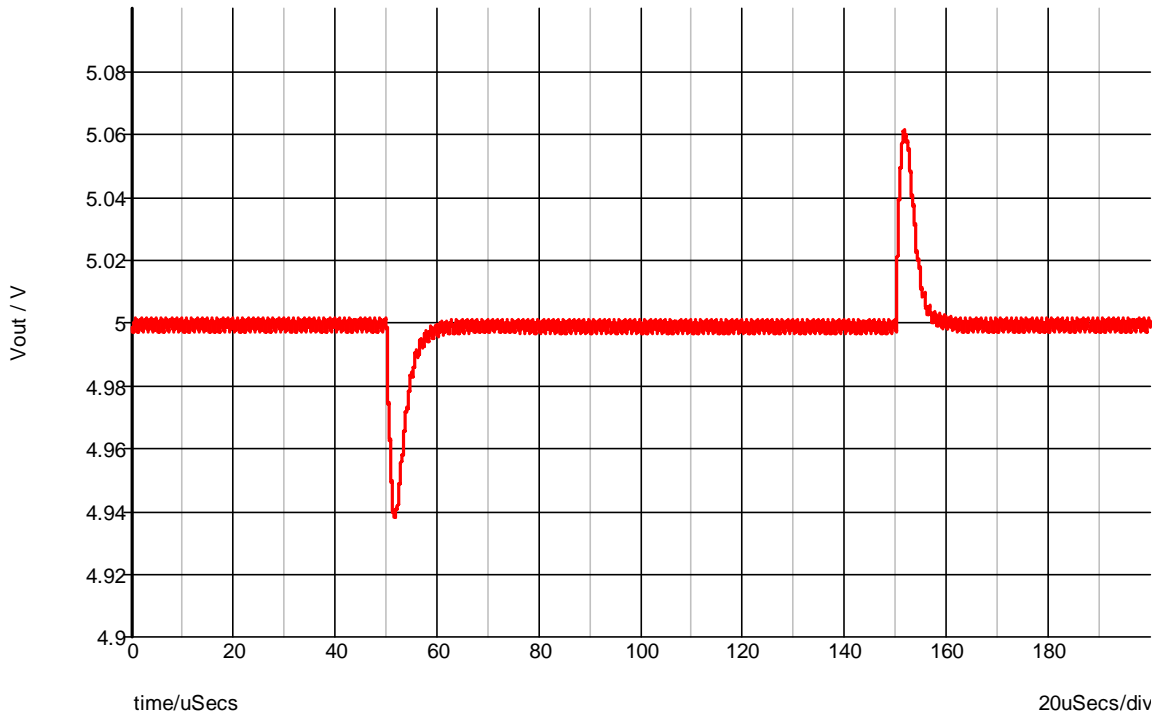

Figure 12. Calculated ripple and transient of 5.0V output with additional 300uF of aluminum electrolytic and 2x10uF ceramic



SCHEMATIC

Figure 13. Schematic:  $V_{OUT1}$  and  $V_{OUT2}$

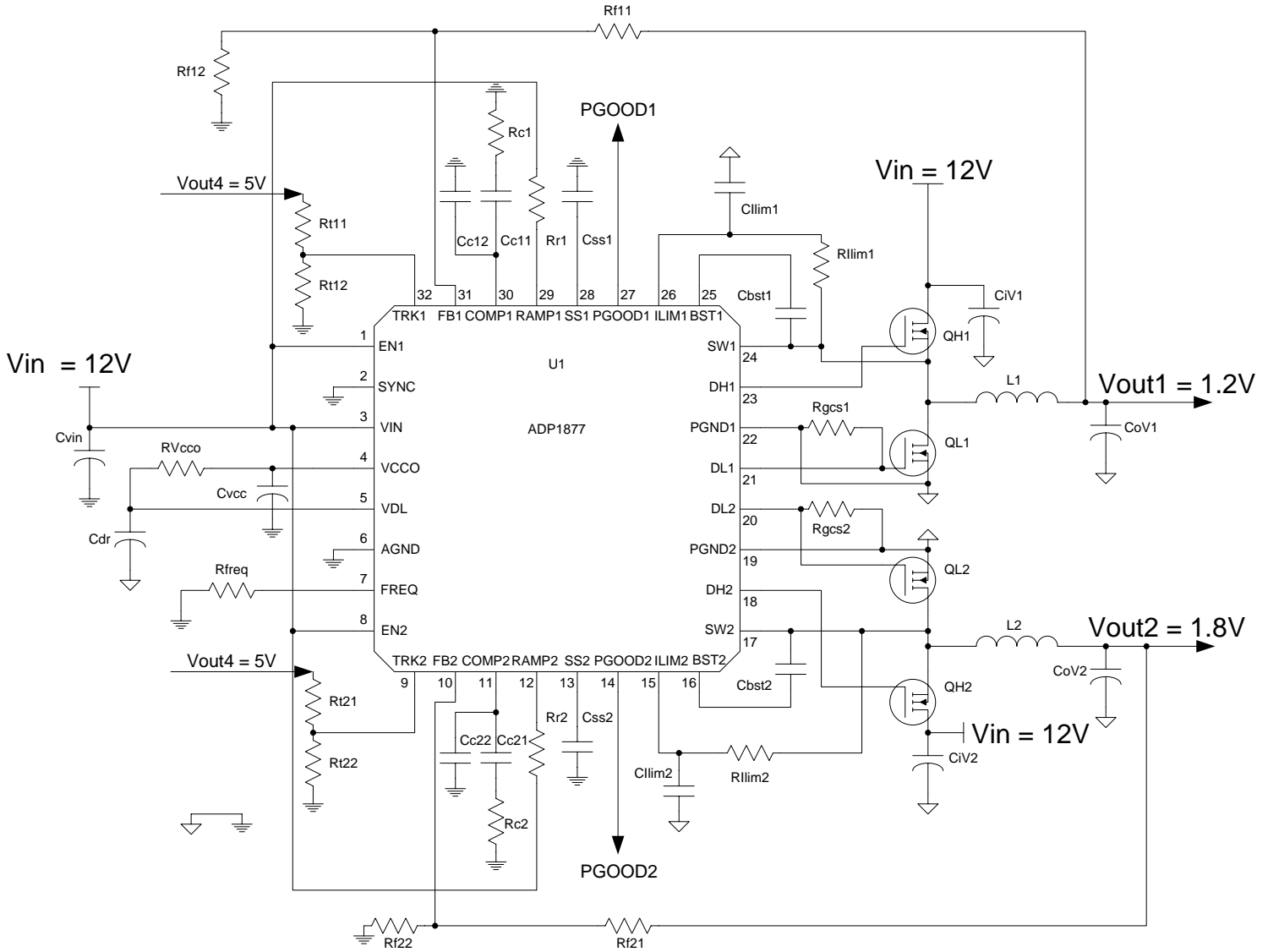
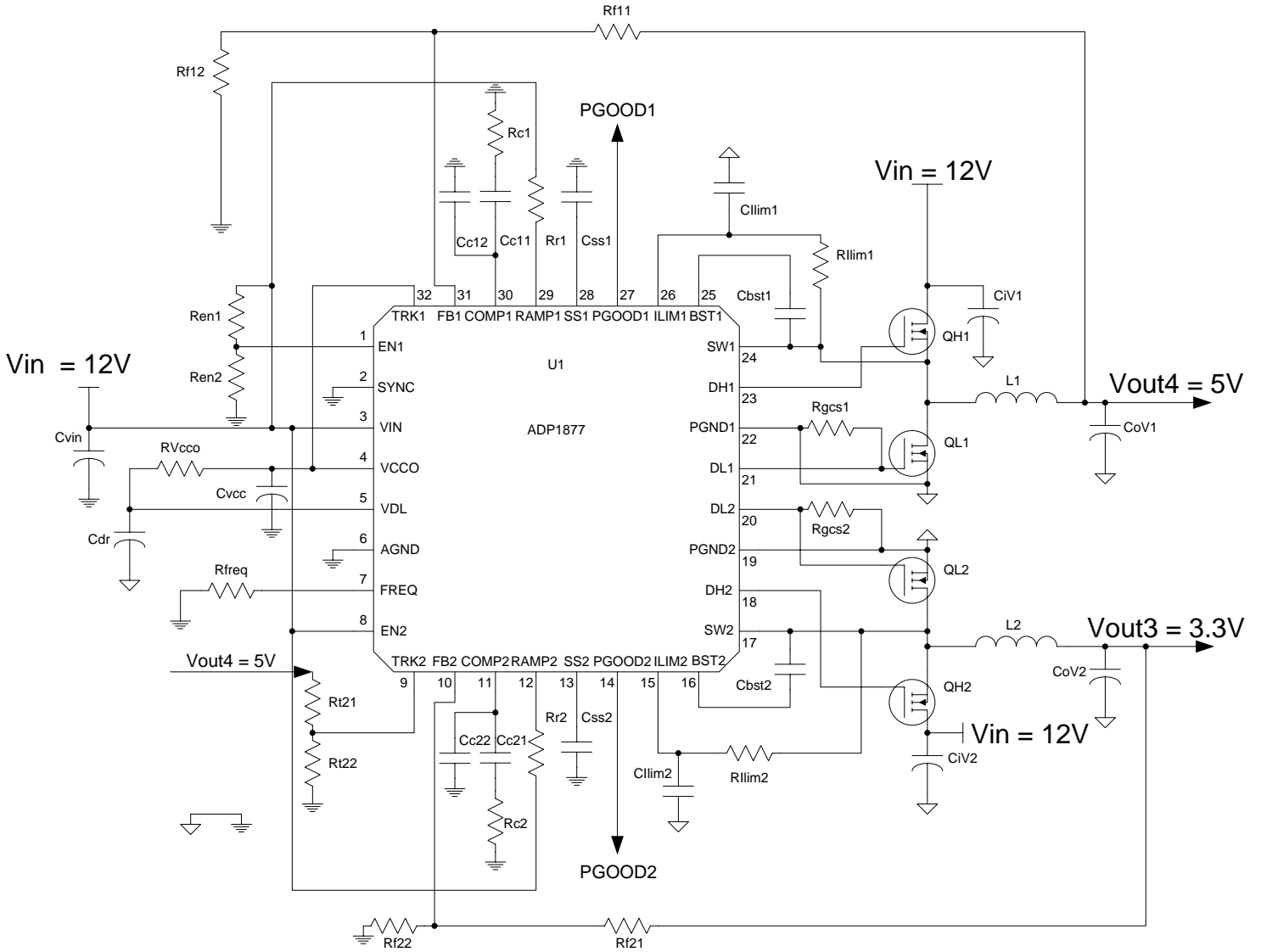

Figure 14. Schematic:  $V_{OUT3}$ ,  $V_{OUT4}$



Bill of Materials

Table 1. Vout1, and Vout2 Bill of Materials (1.2 V and 1.8 V)

Designator	Part Number	Manufacturer	Value	Package	Comment	Quantity
U1	ADP1877	Analog Devices		40pin LFCSP	Dual Current Mode Controller	1
QH1	NTGS3446G	ON-Semi		SOT23-6	Single 60mOhm 20V N-FET	1
QH2	NTGS3446G	ON-Semi		SOT23-6	Single 60mOhm 20V N-FET	1
QL1	NTGS3446G	ON-Semi		SOT23-6	Single 60mOhm 20V N-FET	2
QL2	NTGS3446G	ON-Semi		SOT23-6	Single 60mOhm 20V N-FET	1
L1	DO1813H-122	Coilcraft	1.15uH	Unshielded Drum Core	Ferrite	1
L2	LPS5030-822	Coilcraft	8.2uH	Shielded Drum Core	Ferrite	1
CoV1	JMK212BJ226MG-T	Taiyo Yuden	22uF	0805	MLCC / X5R / 6.3V	2
CoV2	JMK212BJ106MG-T	Taiyo Yuden	10uF	0805	MLCC / X5R / 6.3V	1
CiV1	EMK212BJ106KG-T	Taiyo Yuden	10uF	0805	MLCC / X5R / 16V	1
CiV2	EMK212BJ106KG-T	Taiyo Yuden	10uF	0805	MLCC / X5R / 16V	1
Cvin	GRM21BR71C105K	Murata	1uF	0805	MLCC / X7R / 16V	1
Cbst1, Cbst2	Generic 10%	Vishay	100nF	0805	Boost Capacitor / COG or X7R	2
Css1	Generic 10%	Vishay	10nF	0805	Soft Start Capacitor / COG or X7R	1
Css2	Generic 10%	Vishay	10nF	0805	Soft Start Capacitor / COG or X7R	1
Clim1	Generic 10%	Vishay	33pF	0805	Current Limit Capacitor	1
Clim2	Generic 10%	Vishay	33pF	0805	Current Limit Capacitor	1
Cdr	GRM185R60J105KE21	Murata	1uF	0603	MLCC / X5R / 6.3V	1
Cvcc	GRM185R60J105KE21	Murata	1uF	0603	MLCC / X5R / 6.3V	1
Cc11	Generic 10%	Vishay	470pF	0603	Compensation Capacitor - CH1	1
Cc12	Generic 10%	Vishay	5pF	0603	Compensation Capacitor - CH1	1
Cc21	Generic 10%	Vishay	68pF	0603	Compensation Capacitor - CH2	1
Cc22	Generic 10%	Vishay	5pF	0603	Compensation Capacitor - CH2	1
Rlim1	Generic 1%	Vishay	2.4k	0603	Current Limit Resistor	1
Rlim2	Generic 1%	Vishay	2.2k	0603	Current Limit Resistor	1
Rgcs1	Generic 1%	Vishay	22k	0603	Current Sense Gain Set - 6V/V	1
Rgcs2	No Pop	Vishay		0603	Current Sense Gain Set - 12V/V	1
Rfreq	Generic 5%	Vishay	82k	0603	Frequency Set Resistor - 700kHz	1
Rvcco	Generic 10%	Vishay	1 Ohms	0603	Decoupling Resistor	1
Rr1	Generic 10%	Vishay	240k	0603	Vout 1 Ramp Resistor	1
Rr2	Generic 10%	Vishay	430k	0603	Vout 2 Ramp Resistor	1
Rc1	Generic 10%	Vishay	20k	0603	Compensation Resistor	1
Rc2	Generic 10%	Vishay	240k	0603	Compensation Resistor	1
Rf11	Generic 1%	Vishay	10k	0603	Feedback Resistor - CH1	1
Rf12	Generic 1%	Vishay	10k	0603	Feedback Resistor - CH1	1
Rf21	Generic 1%	Vishay	20k	0603	Feedback Resistor - CH2	1
Rf22	Generic 1%	Vishay	10k	0603	Feedback Resistor - CH2	1
Rt11	Generic 1%	Vishay	10k	0603	Voltage track Resistor - CH1	1
Rt12	Generic 1%	Vishay	10k	0603	Voltage track Resistor - CH1	1
Rt21	Generic 1%	Vishay	20k	0603	Voltage track Resistor - CH2	1
Rt22	Generic 1%	Vishay	10k	0603	Voltage track Resistor - CH2	1

Vout3 and Vout4 Bill of Materials (3.3 V and 5.0 V)

Designator	Part Number	Manufacturer	Value	Package	Comment	Quantity
U1	ADP1877	Analog Devices		40pin LFCSP	Dual Current Mode Controller	1
QH1	NTGS3446G	ON-Semi		SOT23-6	Single 60mOhm 20V N-FET	1
QH2	NTGS3446G	ON-Semi		SOT23-6	Single 60mOhm 20V N-FET	1
QL1	NTGS3446G	ON-Semi		SOT23-6	Single 60mOhm 20V N-FET	1
QL2	NTGS3446G	ON-Semi		SOT23-6	Single 60mOhm 20V N-FET	1
L1	MSS1048-682	Coilcraft	6.8uH	Shielded Drum Core	Ferrite	1
L2	MSS1048-682	Coilcraft	6.8uH	Shielded Drum Core	Ferrite	1
CoV1	JMK212BJ106MG-T	Taiyo Yuden	10uF	0805	MLCC / X5R / 6.3V	1
CoV2	JMK212BJ106MG-T	Taiyo Yuden	10uF	0805	MLCC / X5R / 6.3V	1
CiV1	EMK212BJ106KG-T	Taiyo Yuden	10uF	0805	MLCC / X5R / 16V	1
CiV2	EMK212BJ106KG-T	Taiyo Yuden	10uF	0805	MLCC / X5R / 16V	1
Cvin	GRM21BR71C105K	Murata	1uF	0805	MLCC / X7R / 16V	1
Cbst1, Cbst2	Generic 10%	Vishay	100nF	0805	Boost Capacitor / COG or X7R	2
Css1	Generic 10%	Vishay	100nF	0805	Soft Start Capacitor / COG or X7R	1
Css2	Generic 10%	Vishay	10nF	0805	Soft Start Capacitor / COG or X7R	1
Clim1	Generic 10%	Vishay	33pF	0805	Current Limit Capacitor	1
Clim2	Generic 10%	Vishay	33pF	0805	Current Limit Capacitor	1
Cdr	GRM185R60J105KE21	Murata	1uF	0603	MLCC / X5R / 6.3V	1
Cvcc	GRM185R60J105KE21	Murata	1uF	0603	MLCC / X5R / 6.3V	1
Cc11	Generic 10%	Vishay	33pF	0603	Compensation Capacitor - CH1	1
Cc12	Generic 10%	Vishay	5pF	0603	Compensation Capacitor - CH1	1
Cc21	Generic 10%	Vishay	68pF	0603	Compensation Capacitor - CH2	1
Cc22	Generic 10%	Vishay	5pF	0603	Compensation Capacitor - CH2	1
Rlim1	Generic 1%	Vishay	3.3k	0603	Current Limit Resistor	1
Rlim2	Generic 1%	Vishay	3.0k	0603	Current Limit Resistor	1
Rgcs1	Generic 1%	Vishay	22k	0603	Current Sense Gain Set - 6V/V	1
Rgcs2	Generic 1%	Vishay	22k	0603	Current Sense Gain Set - 6V/V	1
Rfreq	Generic 5%	Vishay	51k	0603	Frequency Set Resistor - 700kHz	1
Rvcco	Generic 10%	Vishay	1 Ohms	0603	Decoupling Resistor	1
Rr1	Generic 10%	Vishay	750k	0603	Vout 1 Ramp Resistor	1
Rr2	Generic 10%	Vishay	750k	0603	Vout 2 Ramp Resistor	1
Rc1	Generic 10%	Vishay	51k	0603	Compensation Resistor	1
Rc2	Generic 10%	Vishay	240k	0603	Compensation Resistor	1
Rf11	Generic 1%	Vishay	11k	0603	Feedback Resistor - CH1	1
Rf12	Generic 1%	Vishay	1.5k	0603	Feedback Resistor - CH1	1
Rf21	Generic 1%	Vishay	10k	0603	Feedback Resistor - CH2	1
Rf22	Generic 1%	Vishay	2.2k	0603	Feedback Resistor - CH2	1
Rt11	Generic 1%	Vishay	10k	0603	Voltage track Resistor - CH1	1
Rt12	Generic 1%	Vishay	10k	0603	Voltage track Resistor - CH1	1
Ren1	Generic 1%	Vishay	150k	0603	Voltage track Resistor - CH2	1
Ren2	Generic 1%	Vishay	10k	0603	Voltage track Resistor - CH2	1

## NOTES

Reference designators shown on the schematic but not listed on the Bill of Materials are place holders for possible design adjustments (snubbers, additional decoupling capacitors and clamp diodes). These components should be put in the layout, but not populated unless after testing it is deemed necessary.

If a different number, or different type of output capacitors are used on the switching outputs the loop compensation components may need adjustment. The assumed additional output caps are listed on the transient and bode plot figures.

Efficiency calculations are estimates and are not verified in actual hardware.

FETs and other components with quantities greater than 1 are connected in parallel with the other FETs / components of the same reference designator. Paralleled FETs should be placed physically close together and have large power planes connecting all the drains together and large power planes connecting all the sources together. Gate drive resistors may be used if there is concern about possible paralleling issues.

Ground symbols with multiple parallel lines (not the triangle symbol) designator should be connected together with one small plane and tied to the power ground plane (triangle symbol) at one point near the IC. Each IC should have its own signal ground pour. The PGND1 and PGND2 pins should be connected directly to the source of the lowside MOSFET for that channel with short wide traces. They should not connect into the main ground plane except at the MOSFET sources.