

Evaluating the ADP1877 Step-Down DC-to-DC Controller

FEATURES

- Input range: 6 V to 14 V**
- Two output voltages: 1.8 V and 1.05 V**
- Output current: 13 A per channel**
- Switching frequency: 600 kHz**
- Operate in PWM or PSM**
- Compact, low cost, and efficient design**

EVALUATION BOARD DESCRIPTION

This user guide describes the design, operation, and test results of the [ADP1877](#) 13 A evaluation board. The input range for this evaluation board is 6 V to 14 V, and the two regulated output voltages are set to 1.8 V and 1.05V, each with a maximum load current of 13 A. A switching frequency (f_{sw}) of 600 kHz achieves a good balance between efficiency and the sizes of the power components.

ADP1877 DEVICE DESCRIPTION

The ADP1877 is a dual-channel, step-down switching controller with integrated drivers that drive N-channel synchronous power MOSFETs. The two PWM outputs are phase shifted 180°, which reduces the input rms current, thus minimizing required input capacitance.

The boost diodes are built into the ADP1877, thus lowering the overall system cost and component count. The ADP1877 can be set to operate in pulse skip, high efficiency mode under light loads or in PWM continuous conduction mode.

The ADP1877 includes externally adjustable soft start, output overvoltage protection, externally adjustable current limit, power good, a tracking function, and a programmable oscillator frequency that ranges from 200 kHz to 1.5 MHz. The ADP1877 provides an output voltage accuracy of $\pm 1\%$ over temperature. This part can be powered from a 2.75 V to 14.5 V supply, operates over the -40°C to $+125^{\circ}\text{C}$ junction temperature range, and is available in a 32-lead 5 mm \times 5 mm LFCSP package.

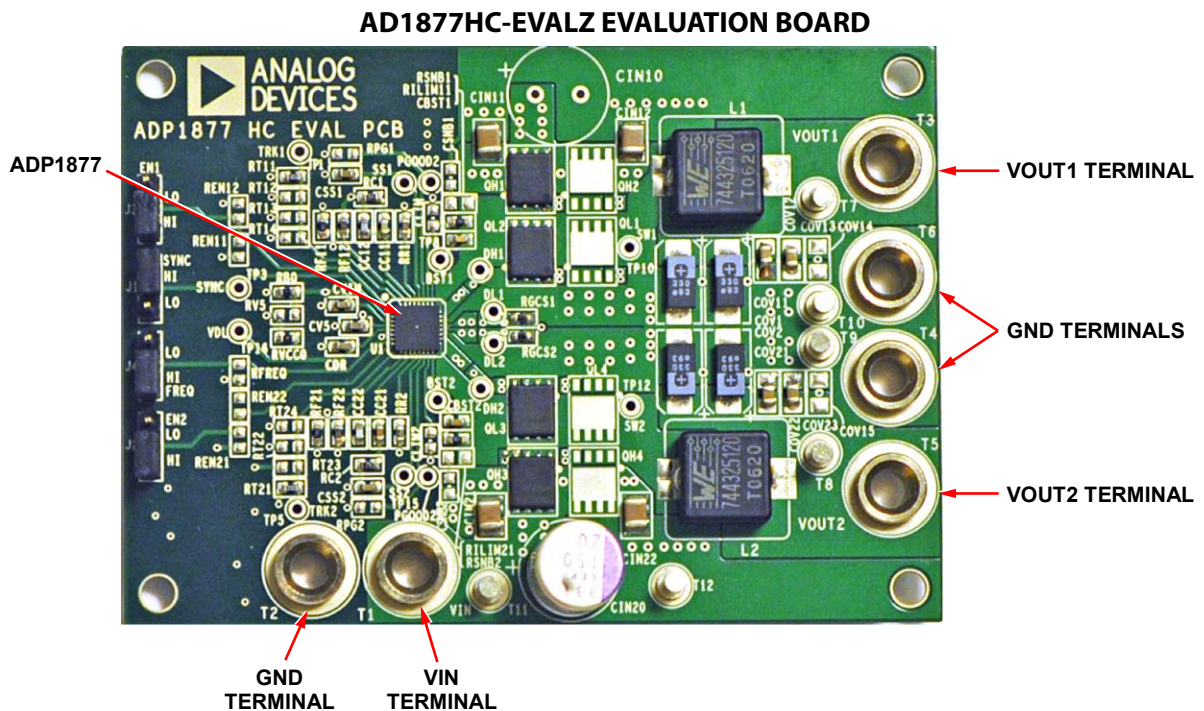

Figure 1.

TABLE OF CONTENTS

Features 1
 Evaluation Board Description..... 1
 ADP1877 Device Description..... 1
 Evaluation Board Digital Picture..... 1
 Revision History 2
 Component Design 3
 Inductor Selection 3
 Input Capacitors 3
 Output Capacitors 3

MOSFET Selection.....3
 Test Results4
 Evaluation Board Operating Instructions.....5
 Printed Circuit Board (PCB) Layout of the
 Evaluation Board6
 Evaluation Board Schematic and Artwork.....7
 Ordering Information 11
 Bill of Materials..... 11

REVISION HISTORY

2/11—Rev. A to Rev. B
 Document Title Changed from ADP1877HC-EVALZ to
 UG-247..... Universal
 Changes to Figure 1 1
 Changes to Input Capacitors Section 3
 Deleted Switching Noise and Overshoot Reduction Section 3
 Added Default Factory Setting Column, Table 1 5
 Added Printed Circuit Board (PCB) Layout of the Evaluation
 Board Section 6

Changes to Figure 8.....7
 Changes to Figure 10.....8
 Changes to Figure 13..... 10
 Changes to Table 3..... 11

8/10—Rev. 0 to Rev. A
 Change to Figure 11

8/09—Revision 0: Initial Version

COMPONENT DESIGN

For information in selecting power components and calculating component values, see the [ADP1877](#) data sheet.

INDUCTOR SELECTION

A 1.2 μH inductor with a 20 A average current rating (744325120 from Würth Elektronik) is selected. This is a compact inductor with a ferrite core, which offers high performance in terms of low R_{DC} and low core loss.

INPUT CAPACITORS

Because of the very low ESR and high input current rating of multilayer ceramic capacitors (MLCCs), two 10 μF MLCCs in Size 1210 are selected as the input capacitors for each input. A bulk input capacitor of 150 μF (OS-CON) is selected to filter out large current ripple and noise from the power supply line.

OUTPUT CAPACITORS

A combination of POSCAP™ polymer capacitors and MLCCs are selected for the output rails. Polymer capacitors have low ESR and high current ripple rating. Connecting polymer capacitors and MLCCs in parallel is very effective in reducing voltage ripple. Two 330 μF POSCAP capacitors and two 22 μF MLCCs in Size 0805 are selected.

MOSFET SELECTION

For low output or low duty cycle, select a high-side MOSFET with fast rise and fall times and with low input capacitance to significantly reduce the switching power loss. As for the synchronous rectifier (low-side MOSFET), select a MOSFET with low $R_{\text{DS(on)}}$ because switching speed is not critical, and there is no switching loss in the low-side MOSFET.

For the high-side MOSFET, the BSC080N03LS from Infineon Technologies in the PG-TDSON-8 or Super-SO8 package is selected. This part has low input capacitance (1.2 nF) and fast transition times (3 ns). As for the low-side MOSFET, the BSC030N03LS, with $R_{\text{DS(on)}}$ of 4.7 m Ω at a V_{GS} of 4.5 V, is selected.

TEST RESULTS

T_A = 25°C.

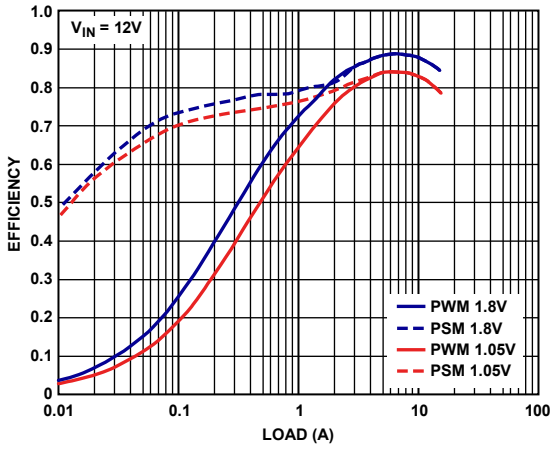

Figure 2. Efficiency

09685-002

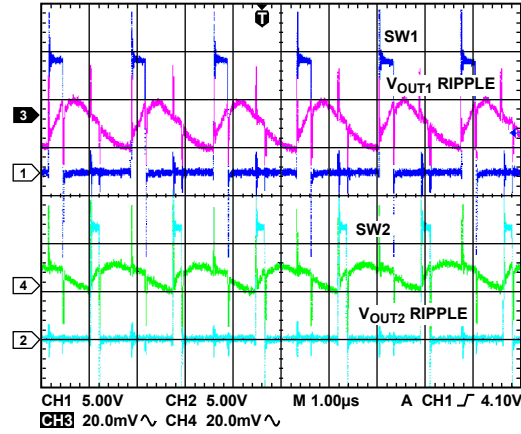

Figure 5. Output Ripple, 13 A Load

09685-005

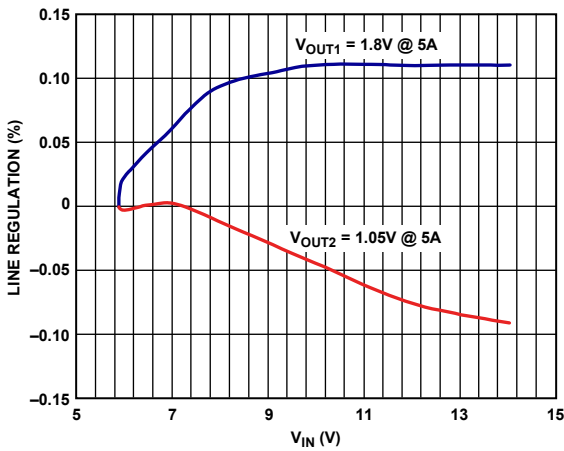

Figure 3. Line Regulation

09685-003

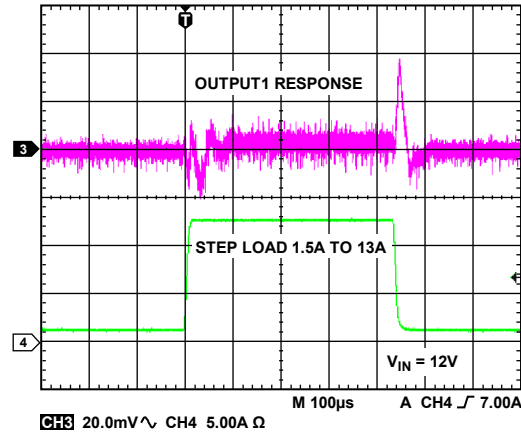

Figure 6. Step Load Transient, V_{OUT1}

09685-006

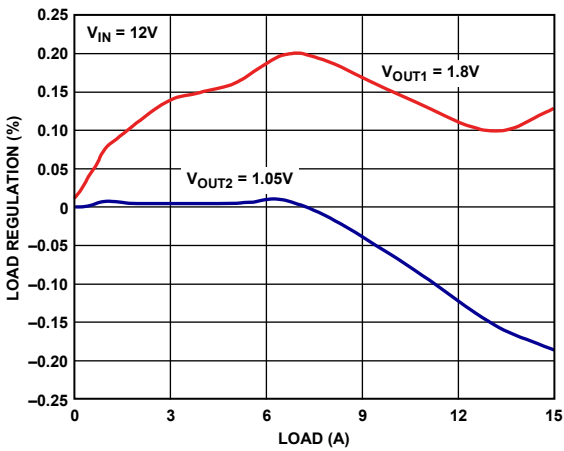

Figure 4. Load Regulation

09685-004

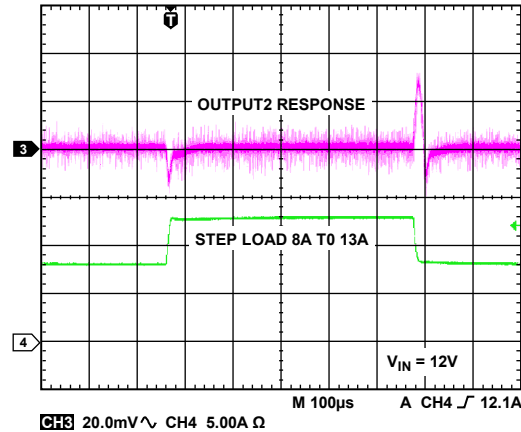

Figure 7. Step Load Transient, V_{OUT2}

09685-007

EVALUATION BOARD OPERATING INSTRUCTIONS

1. Connect Jumper J3 (EN1) to the high position to enable Channel 1 of the ADP1877.
2. Connect Jumper J2 (EN2) to the high position to enable Channel 2 of the ADP1877.
3. Connect Jumper J4 (FREQ) to the high position for 600 kHz operation.
4. Connect Jumper J1 (SYNC) to the high position for PWM operation or to low position for PSM operation.
5. Connect the positive terminal of the input power supply to the input terminal, T1. The input range is 6 V to 14 V.

Table 1. Jumper Description

Jumper	Description	Default Factory Setting	Function
J1	SYNC	High	Connect to the high position for PWM operation or the low position for PSM operation. For synchronization, run an external clock source to this pin.
J2	EN2	High	Connect to the high position to enable Channel 2 of the ADP1877 or to the low position to disable the Channel 2.
J3	EN1	High	Connect to high position to enable Channel 1 of the ADP1877 or to the low position to disable the Channel 1.
J4	FREQ	High	Connect to the low position for 300 kHz operation or to the high position for 600 kHz operation. For this 13 A evaluation board, connect J4 to the high position.

Table 2. Performance Summary (T_A = 25°C)

Parameter	Condition
V _{IN}	6 V to 14 V
f _{SW}	Switching frequency, 600 kHz
V _{OUT1}	1.8 V
I _{OUT1}	0 A to 13 A
V _{OUT1} Ripple, DC Load	20 mV at 13 A load
V _{OUT1} Deviation upon Step Load Release	2% with a 11 A step load; 3% with a 13 A step load
V _{OUT2}	1.05 V
I _{OUT2}	0 A to 13 A
V _{OUT2} Ripple, DC Load	13 mV at 13 A load
V _{OUT2} Deviation upon Step Load Release	3% with a 5 A step load

PRINTED CIRCUIT BOARD (PCB) LAYOUT OF THE EVALUATION BOARD

As shown in Figure 1, the layout of this evaluation board is not optimized for the smallest PCB area. The layout is such that any of the components can be desoldered and replaced easily with different components. When replacing components, use a hand soldering iron so that the user can modify the existing design without needing to acquire a new PCB layout. The physical size of the compensation components is 0603, which is for its ease of hand soldering when reworking of the board is needed. The size of these components can be 0402 or even smaller in the final design. Note that there are extra placeholders for input bulk capacitors

and MOSFETs. The user can remove, add, or change any of these power components to achieve a particular design objective. The dummy 0 Ω resistors are placed at the driver gates, DHx and DLx, for evaluation purposes only and can be removed in the final design. Furthermore, many test points are placed on the evaluation board so that the user can easily evaluate the performances of the [ADP1877](#) with an oscilloscope. See the evaluation board schematic shown in Figure 8 for additional information.

EVALUATION BOARD SCHEMATIC AND ARTWORK

800-58960

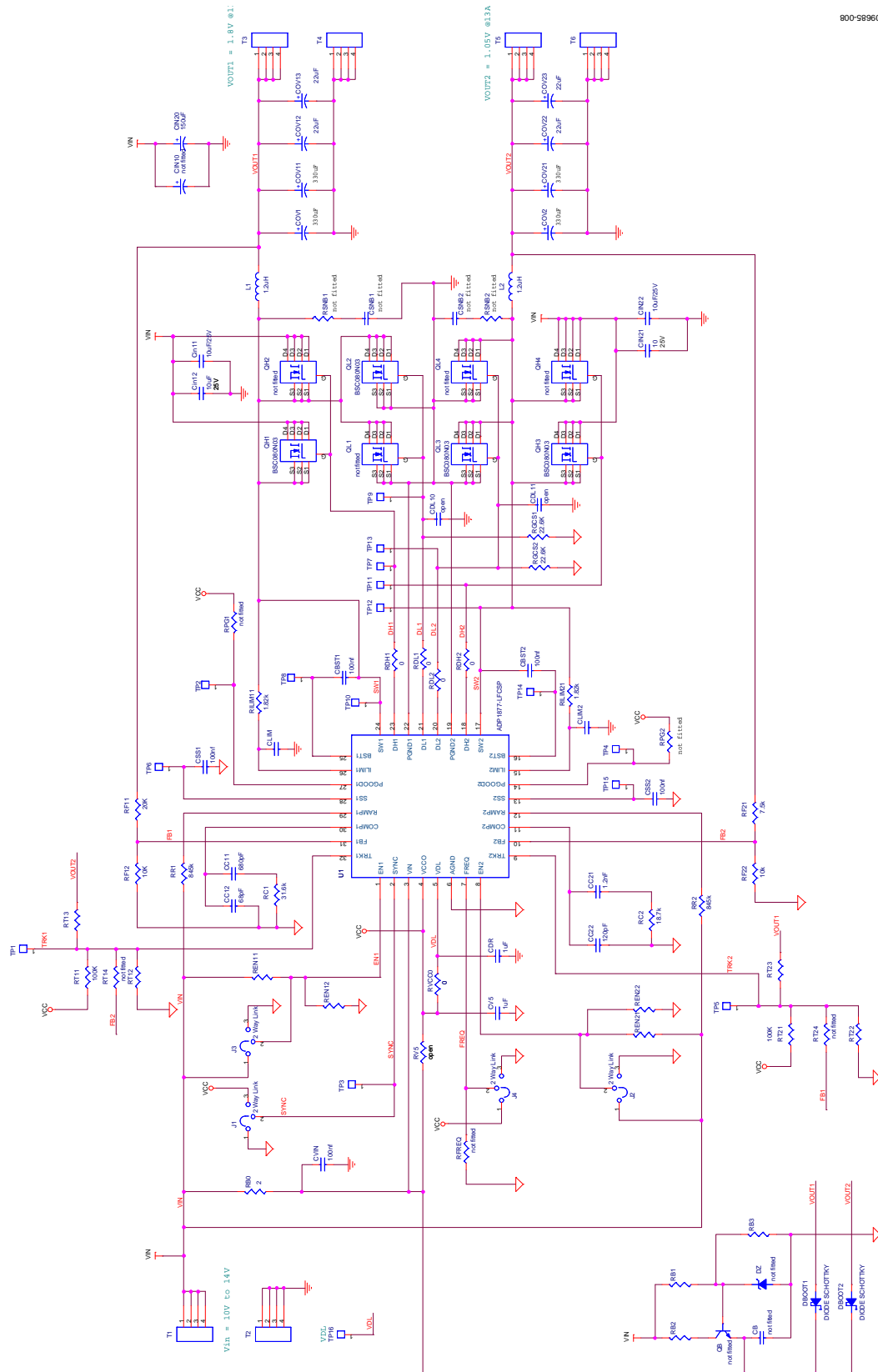

Figure 8. Evaluation Board Schematic

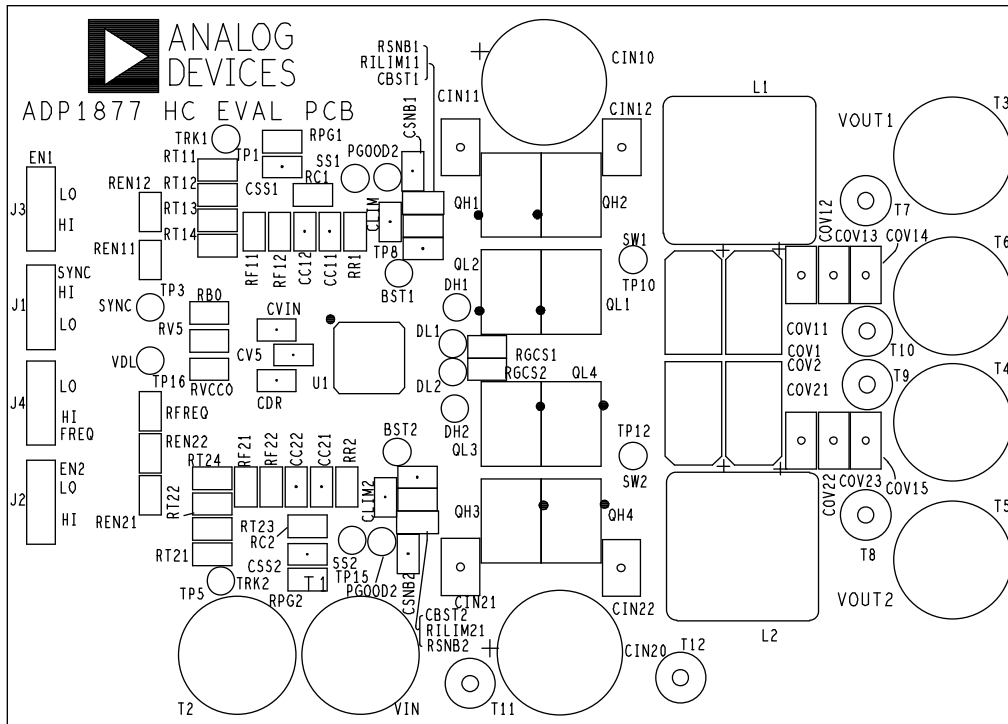

Figure 9. Top Silkscreen

09885-009

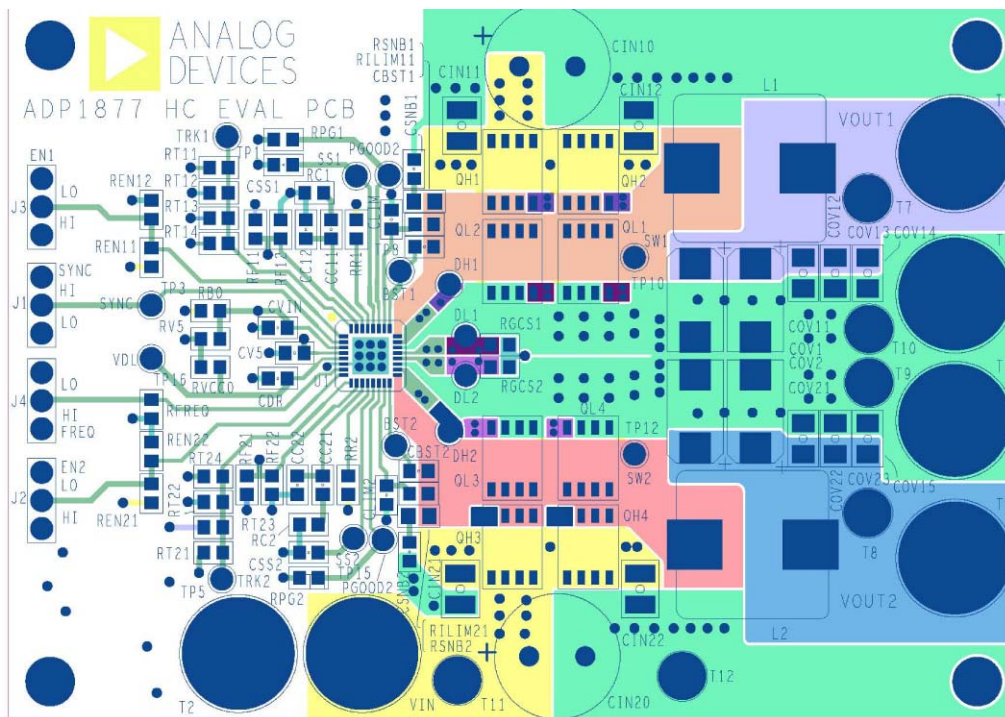

Figure 10. Top Layer

09885-010

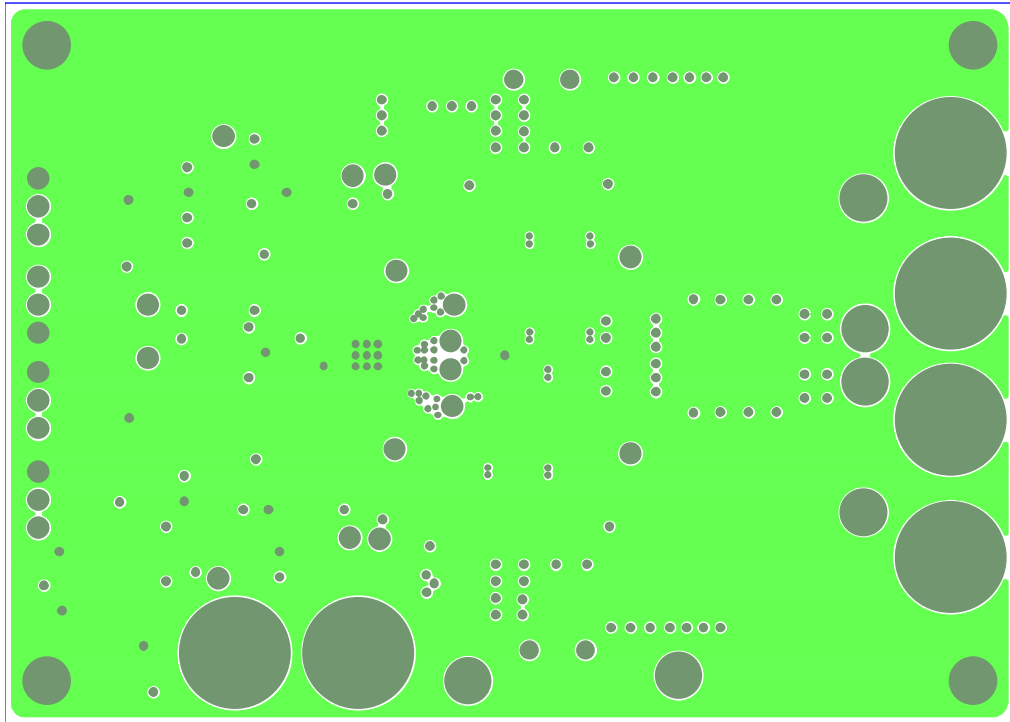

Figure 11. Second Layer (AGND plane)

09885-011

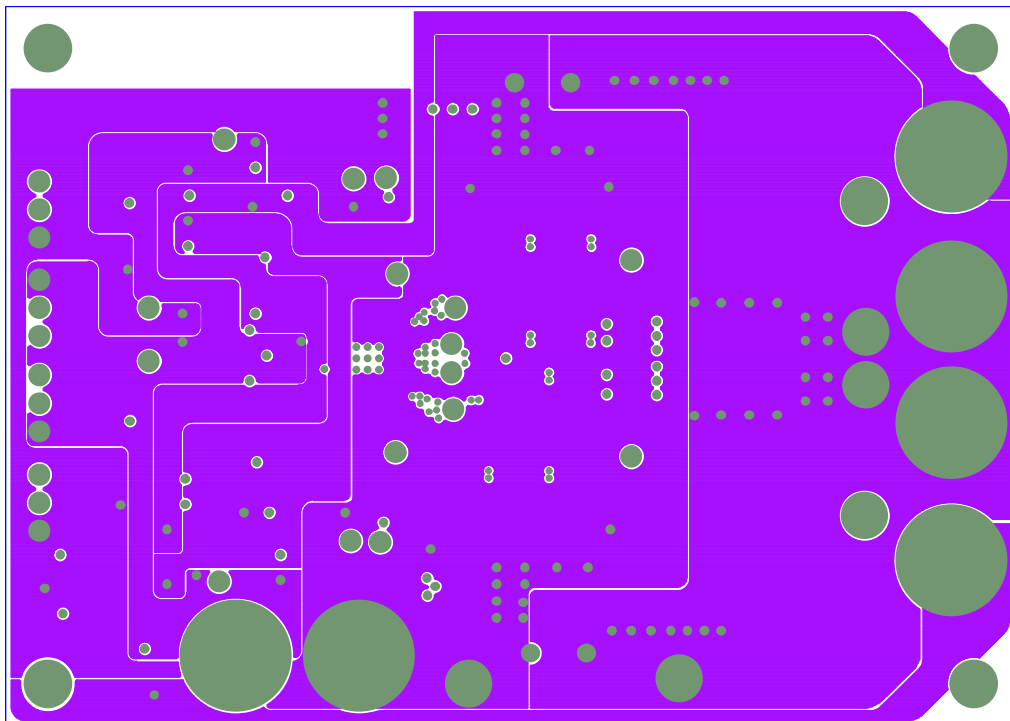

Figure 12. Third Layer (PGND Layer)

09885-012

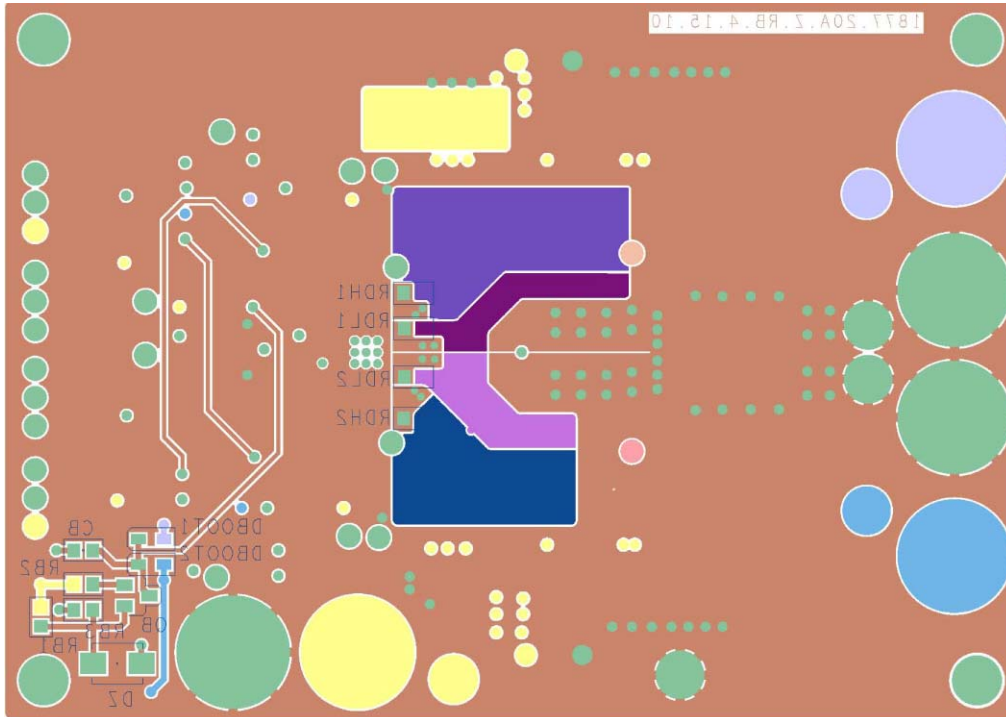

Figure 13. Bottom Layer (PGND Layer)

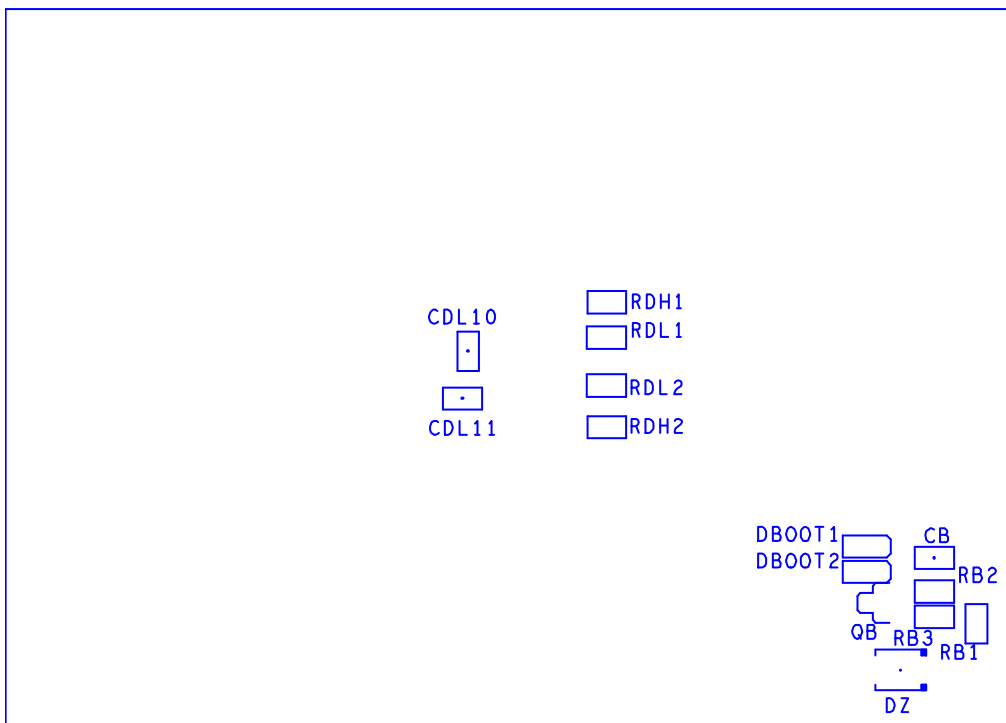

Figure 14. Bottom Silk Screen

ORDERING INFORMATION

BILL OF MATERIALS

Table 3. Component Listing

Description	Qty	Reference Designator	Manufacturer	Part No
Device Under Test, LFCSP	1	U1	Analog Devices	ADP1877
Input Capacitors				
MLCC, 10 μ F, X7R, 25 V, 1210	4	CIN11, CIN12, CIN21, CIN22	Murata	GRM32DR71E106KA12
OS-CON, 150 μ F, 20 V	1	CIN22	Sanyo	20SEP150M
Miscellaneous Parts				
MLCC, 100 nF, X7R, 16 V, 0603	5	CSS1, CSS2, CBST1, CBST2, CVIN	Murata	GRM188R71E104KA01
MLCC, 1.0 μ F, X5R, 6.3 V, 0603	2	CV5, CDR	Murata	GRM185R60J105KE21
Resistor, 2 Ω , 0603	1	RB0	Vishay	CRCW06032R00F
Resistor, 0 Ω , 0603	1	RVCCO	Vishay	CRCW06030R00F
Resistor, Not Fitted, 0603	1	RV5	Vishay	
Resistor, Not Fitted, 0603	1	RFREQ	Vishay	
Resistor, 22.6 k Ω , 0603	2	RGCS1, RGCS2	Vishay	CRCW06032262F
Resistor, 845 k Ω , 0603	2	RR1, RR2	Vishay	CRCW06038453F
Output Capacitors				
POSCAP, 330 μ F, 2.5 V, 9 m Ω	4	COV1, COV2, COV11, COV21	Sanyo	2R5TPE330M9C2
MLCC, 22 μ F, X5R, 0805	4	COV12, COV13, COV22, COV23	Murata	GRM21BR60J226ME39
Inductors				
Inductor, 1.2 μ H, 1.8 m Ω , $I_N = 20$ A, $I_{SAT} = 25$ A	2	L1, L2	Würth Elektronik	744325120
Feedback Resistors				
Resistor, 10 k Ω , 0603	2	RF22, RF12	Vishay	CRCW06031002F
Resistor, 7.5 k Ω , 0603	1	RF21	Vishay	CRCW06037501F
Resistor, 20 k Ω , 0603	1	RF11	Vishay	CRCW06032002F
Resistor, 0 Ω , 0603	4	RDH1, RDH2, RDL1, RDL2	Vishay	CRCW06033R01F
Power MOSFETs				
N MOSFET, 30 V, 9 m Ω , Super-SO8	2	QH1, QH3	Infineon	BSC080N03LS
N MOSFET, 30 V, 4.5 m Ω , Super-SO8	2	QL2, QL3	Infineon	BSC030N03LS
Compensation				
MLCC, 680 pF, 0603	1	CC11	Vishay	VJ0603Y681KXAA
MLCC, 1.2 nF, 0603	1	CC21	Vishay	VJ0603Y122KXAA
MLCC, 68 pF, 0603	1	CC12	Vishay	VJ0603A121KXAA
MLCC, 120 pF, 0603	1	CC22	Vishay	VJ0603A680KXAA
Resistor, 31.6 k Ω , 0603	1	RC1	Vishay	CRCW06033162F
Resistor, 18.7 k Ω , 0603	1	RC2	Vishay	CRCW06031872F
Resistor, 1.82 k Ω , 0603	2	RLIM11, RLIM21	Vishay	CRCW06031821F
Tracking				
Resistor, 100 k Ω , 0603	2	RT11, RT21	Vishay	CRCW06031003F
Resistor, 0603, Not Fitted	4	RT12, RT13, RT22, RT23	Vishay	
Resistor, 0603, Not Fitted	2	RT14, RT24	Vishay	
External LDO on Back Side (For High Input Voltage)				
Resistor, 0603, Not Fitted	1	RB2	Vishay	
Resistor, 0603, Not Fitted	2	RB1, RB3	Vishay	
MLCC, 0603, Not Fitted	1	CB	Vishay	
Bipolar Signal NPN, Not Fitted	1	QB		
Zener Diode, 5.5 V, Not Fitted	1	DZ		
Schottky Diode, Not Fitted	2	DBOOT1, DBOOT2		

Description	Qty	Reference Designator	Manufacturer	Part No
Resistor (PGOOD Pull-Up, Optional), 0603, Not Fitted	2	RPG1, RPG2	Vishay	
MLCC (Optional), 0603, Not Fitted	2	CLIM, CLIM2		
3-Terminal Jumpers, 0.1 Inch Spacing	4	J1, J2, J3, J4	Any	
Test Points, 40 mil (1 mm) Through Hole , Not Fitted	15	PGOOD1, PGOOD2, SS1, SS2, TRK1, TRK2, SW1, SW2, DH1, DH2, DL1, DL2, BST1, BST2, VDL	Any	
Test Points, 110 mil Through Hole	6	T7, T8, T9, T10, T11, T12	Keystone Electronics Corp.	1502-1
Terminals, Banana Jack	6	VIN, GND, VOUT1, VOUT2, GND, GND	Keystone Electronics Corp.	575-4

**ESD Caution**

ESD (electrostatic discharge) sensitive device. Charged devices and circuit boards can discharge without detection. Although this product features patented or proprietary protection circuitry, damage may occur on devices subjected to high energy ESD. Therefore, proper ESD precautions should be taken to avoid performance degradation or loss of functionality.

Legal Terms and Conditions

By using the evaluation board discussed herein (together with any tools, components documentation or support materials, the "Evaluation Board"), you are agreeing to be bound by the terms and conditions set forth below ("Agreement") unless you have purchased the Evaluation Board, in which case the Analog Devices Standard Terms and Conditions of Sale shall govern. Do not use the Evaluation Board until you have read and agreed to the Agreement. Your use of the Evaluation Board shall signify your acceptance of the Agreement. This Agreement is made by and between you ("Customer") and Analog Devices, Inc. ("ADI"), with its principal place of business at One Technology Way, Norwood, MA 02062, USA. Subject to the terms and conditions of the Agreement, ADI hereby grants to Customer a free, limited, personal, temporary, non-exclusive, non-sublicensable, non-transferable license to use the Evaluation Board FOR EVALUATION PURPOSES ONLY. Customer understands and agrees that the Evaluation Board is provided for the sole and exclusive purpose referenced above, and agrees not to use the Evaluation Board for any other purpose. Furthermore, the license granted is expressly made subject to the following additional limitations: Customer shall not (i) rent, lease, display, sell, transfer, assign, sublicense, or distribute the Evaluation Board; and (ii) permit any Third Party to access the Evaluation Board. As used herein, the term "Third Party" includes any entity other than ADI, Customer, their employees, affiliates and in-house consultants. The Evaluation Board is NOT sold to Customer; all rights not expressly granted herein, including ownership of the Evaluation Board, are reserved by ADI. CONFIDENTIALITY. This Agreement and the Evaluation Board shall all be considered the confidential and proprietary information of ADI. Customer may not disclose or transfer any portion of the Evaluation Board to any other party for any reason. Upon discontinuation of use of the Evaluation Board or termination of this Agreement, Customer agrees to promptly return the Evaluation Board to ADI. ADDITIONAL RESTRICTIONS. Customer may not disassemble, decompile or reverse engineer chips on the Evaluation Board. Customer shall inform ADI of any occurred damages or any modifications or alterations it makes to the Evaluation Board, including but not limited to soldering or any other activity that affects the material content of the Evaluation Board. Modifications to the Evaluation Board must comply with applicable law, including but not limited to the RoHS Directive. TERMINATION. ADI may terminate this Agreement at any time upon giving written notice to Customer. Customer agrees to return to ADI the Evaluation Board at that time. LIMITATION OF LIABILITY. THE EVALUATION BOARD PROVIDED HEREUNDER IS PROVIDED "AS IS" AND ADI MAKES NO WARRANTIES OR REPRESENTATIONS OF ANY KIND WITH RESPECT TO IT. ADI SPECIFICALLY DISCLAIMS ANY REPRESENTATIONS, ENDORSEMENTS, GUARANTEES, OR WARRANTIES, EXPRESS OR IMPLIED, RELATED TO THE EVALUATION BOARD INCLUDING, BUT NOT LIMITED TO, THE IMPLIED WARRANTY OF MERCHANTABILITY, TITLE, FITNESS FOR A PARTICULAR PURPOSE OR NON-INFRINGEMENT OF INTELLECTUAL PROPERTY RIGHTS. IN NO EVENT WILL ADI AND ITS LICENSORS BE LIABLE FOR ANY INCIDENTAL, SPECIAL, INDIRECT, OR CONSEQUENTIAL DAMAGES RESULTING FROM CUSTOMER'S POSSESSION OR USE OF THE EVALUATION BOARD, INCLUDING BUT NOT LIMITED TO LOST PROFITS, DELAY COSTS, LABOR COSTS OR LOSS OF GOODWILL. ADI'S TOTAL LIABILITY FROM ANY AND ALL CAUSES SHALL BE LIMITED TO THE AMOUNT OF ONE HUNDRED US DOLLARS (\$100.00). EXPORT. Customer agrees that it will not directly or indirectly export the Evaluation Board to another country, and that it will comply with all applicable United States federal laws and regulations relating to exports. GOVERNING LAW. This Agreement shall be governed by and construed in accordance with the substantive laws of the Commonwealth of Massachusetts (excluding conflict of law rules). Any legal action regarding this Agreement will be heard in the state or federal courts having jurisdiction in Suffolk County, Massachusetts, and Customer hereby submits to the personal jurisdiction and venue of such courts. The United Nations Convention on Contracts for the International Sale of Goods shall not apply to this Agreement and is expressly disclaimed.