

Measuring Output Ripple and Switching Transients in Switching Regulators

by Aldrick S. Limjoco

INTRODUCTION

Minimizing output ripple and switching transients is very important for some applications, especially noise sensitive devices such as high resolution ADCs. When using a switching regulator as a power supply, the output ripple can appear as a distinct spur on the ADC's output spectrum, affecting its dynamic performance, or signal-to-noise ratio and spurious-free dynamic range (SFDR). Due to these undesirable output signals, a switching regulator is sometimes replaced with a low dropout (LDO) regulator. Thus, the high efficiency advantage of the switching regulator is traded for the cleaner output of the LDO regulator. Quantifying these artifacts correctly provides a better perspective when applying, designing, and integrating switching regulators in a wider range of high performance applications and noise sensitive systems.

This application note describes effective techniques for measuring output ripple and switching transients in switching regulators. Measuring these artifacts requires great care because poor measurement setup can lead to incorrect readings. Loops formed by the oscilloscope probe signal and ground leads introduce parasitic inductance. This inaccurately increases the amplitude of switching transients that are associated with the fast switching transitions. Therefore, proper connections and good measurement techniques in a wide bandwidth measurement are observed.

The Analog Devices, Inc., part used to demonstrate the techniques for measuring output ripple and switching noise is the [ADP2114](#) dual 2 A/single 4 A synchronous step down dc-to-dc converter. This buck regulator provides high efficiency and operates at a switching frequency of up to 2 MHz.

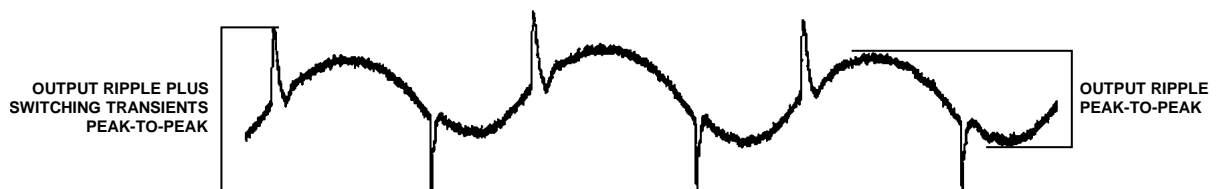

Figure 1. Output Ripple and Switching Transients

19603-201

TABLE OF CONTENTS

Introduction	1	Frequency Domain Measurement	4
Revision History	2	Time Domain Measurement.....	5
Output Ripple and Switching Transients.....	3	Best Method	6
Estimating Output Ripple in a Buck Regulator	3	Measuring Switching Transients	8
Output Ripple Considerations	4	Conclusion	8
Measuring Output Ripple.....	4	References.....	8

REVISION HISTORY

1/13—Revision 0: Initial Version

OUTPUT RIPPLE AND SWITCHING TRANSIENTS

Output ripple and switching transients are two undesirable signals on a switching regulator’s output. These depend on the regulator’s topology and the values and the characteristics of external components used.

Output ripple is the ac output voltage residue and is coherently related to the switching operation of a switching regulator. Its fundamental frequency is the same as the regulator switching frequency.

Switching transients are high frequency oscillations that occur during switching transitions. Its amplitude is express as a maximum peak-to-peak value. Often, this is difficult to measure accurately since it is highly dependent on the test setup.

An example of output ripple and switching transients is shown in Figure 1.

ESTIMATING OUTPUT RIPPLE IN A BUCK REGULATOR

Figure 2 shows a typical simplified buck regulator circuit.

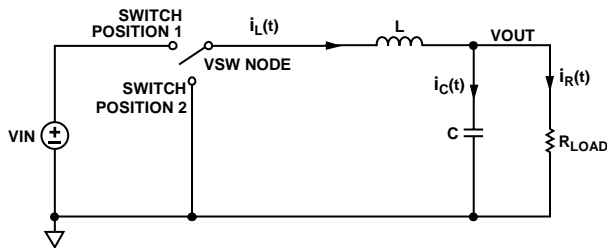

Figure 2. Simplified Buck Regulator Circuit

For the output ripple calculation in a steady state condition, the inductor current ripple, which mainly flows through Capacitor C, must not be neglected. Figure 3 shows the switch node voltage and inductor current waveform for Switch Position 1 and Switch Position 2 from Figure 2.

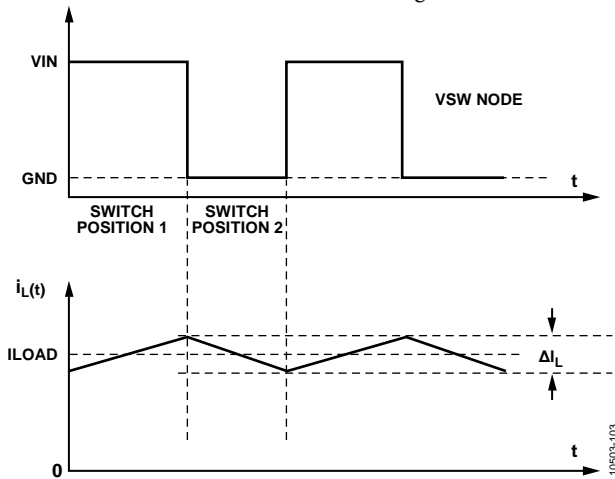

Figure 3. Switch Node Voltage and Inductor Current Waveform

The inductor current waveform $i_L(t)$ contains a dc current (I_LOAD) and current ripple of peak to peak magnitude, ΔI_L .

The dc current only flows into the load resistance R_{LOAD} as the capacitor blocks all dc current from flowing through it. The inductor current ripple divides between Capacitor C and the load resistance R_{LOAD} . However, the capacitance must be big enough that its impedance at the switching frequency is significantly lower than the impedance of the load. The capacitor then provides the adequate filtering of the switching ripple as most of the inductor current ripple flows through Capacitor C.

Figure 4 illustrates the capacitor output ripple from a buck converter. The capacitor output ripple can be associated with the charge contained in the positive portion of the capacitor current waveform $i_C(t)$ above zero reference level. The capacitor current waveform is the same as the inductor current waveform, but without the I_LOAD component. The capacitor current waveform above the zero reference level for half the switching period, makes the capacitor voltage $V_C(t)$ increase since charge is being stored on the capacitor plates. When the capacitor current waveform is below the zero reference level, $V_C(t)$ decreases. Thus, between the two zero crossings of the capacitor current is half of Switch Position 1 and Switch Position 2 which causes the capacitor voltage to change between its minimum and maximum values.

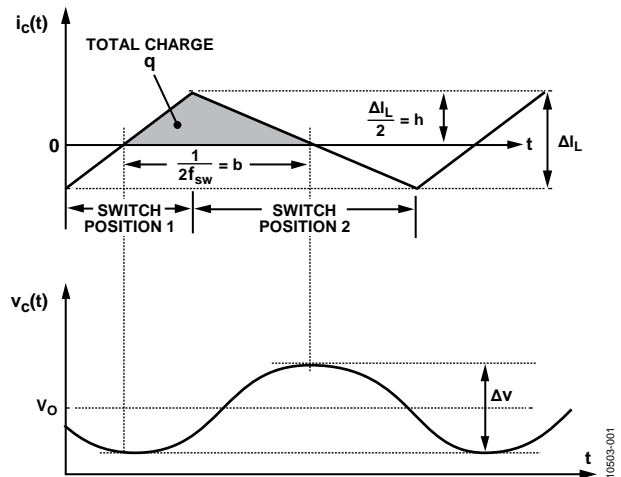

Figure 4. Capacitor Current and Capacitor Voltage Waveform

The total change in $v_C(t)$ is the peak-to-peak output ripple, or Δv . During the time when the capacitor voltage changes between its minimum and maximum values, the change in charge on the capacitor is defined by

$$q = C(\Delta v)$$

where the charge, q , is the integral of the current waveform between its zero crossings.

The integral can be expressed as the area of the shaded triangle.

Using the base as $\frac{1}{2f_{sw}}$ and the height as $\Delta I_L/2$, the total

charge, q , from Figure 4, is expressed in the following equation:

$$q = \frac{b \times h}{2} = \frac{\Delta I_L}{8 \times f_{sw}}$$

Solving for Δv yields the following equation:

$$\Delta v = \frac{\Delta I_L}{8 \times f_{sw} \times C} \quad (1)$$

where:

Δv is the capacitor voltage ripple.

ΔI_L is the inductor current ripple.

f_{sw} is the switching frequency.

C is the capacitance.

The ESR can be modeled as a resistor in series with the capacitor. The equation of output ripple including ESR yields the following equation:

$$\Delta v = \Delta I_L \times \left(ESR + \frac{1}{8 \times f_{sw} \times C} \right) \quad (2)$$

OUTPUT RIPPLE CONSIDERATIONS

The inductor and the output capacitor are the main components that directly affect the output ripple.

Output ripple is associated with inductor current ripple. Thus, they are directly related. However, there are some trade-offs and advantages for inductor selection. For example, a small inductor gives better transient response at the expense of larger inductor current ripple while a large inductor leads to a smaller inductor current ripple at the expense of slower transient response ability.

Using a low ESR capacitor minimizes the output ripple of the switching regulator. Ceramic capacitor with dielectric X5R or X7R is a good choice. On the other hand, large capacitance is often used to lower the output ripple. However, size and number of output capacitors can come at the expense of cost and board space.

MEASURING OUTPUT RIPPLE

When measuring output ripple, it is important to consider the theoretical calculation to be used as a reference. The calculation depends on the switching regulator's topology and the choice of values and materials used as external components.

The following formula for calculating the output ripple of the ADP2114 is expressed from Equation 2.

In this example, the ADP2114 operates at 620 kHz switching frequency in forced PWM mode. The total output capacitance is chosen to be 69 μ F and total capacitor ESR is 1.5 m Ω . The inductor current ripple is calculated based on Equation 3.

$$\Delta I_L = \frac{VIN - VOUT}{L \times Fsw} \times \frac{VOUT}{VIN} \quad (3)$$

where:

VIN is the input voltage in volts, which is 5 V.

$VOUT$ is the output voltage in volts, which is 1.8 V.

L is the storage inductance in henry, which is 2.2 μ H.

Equation 3 yields a theoretical inductor current ripple of 0.85 A. Substituting all values into Equation 2 yields a theoretical output ripple of 3.76 mV p-p. These conditions and component values are used throughout the application note for frequency and time domain measurements.

FREQUENCY DOMAIN MEASUREMENT

It is useful for power engineers to think of the frequency domain when measuring unwanted output signal artifacts in a switching regulator. This provides a better perspective where the output ripple and its harmonics are placed at discrete frequencies with each corresponding power level. Figure 5 provides information for engineers who want to use a switching regulator on RF and high speed converter applications since they can see if the switching regulator they chose is appropriate for their wide bandwidth application.

The measurement scheme for frequency domain uses a 50 Ω coaxial cable probe across the ADP2114 output capacitor, which goes through a dc blocking capacitor and ends with a 50 Ω termination at the input of the spectrum analyzer. The dc blocking capacitor prevents any dc current from passing through to the spectrum analyzer. It also avoids dc loading effects. The 50 Ω transmission environment minimizes reflections and standing waves specifically at high frequencies.

The measurement point should be across the output capacitor since it is the main source of output ripple. The loop from signal tip to ground should be kept as small as possible. This avoids additional inductance that may affect the measurement. The frequency domain plot of output ripple and harmonics of the ADP2114 are shown in Figure 5.

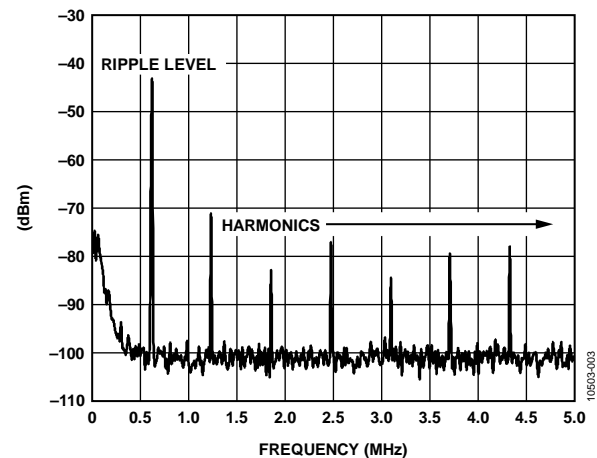

Figure 5. Frequency Domain Plot using Spectrum Analyzer

The ADP2114 generates a low output ripple voltage at the fundamental frequency of 4 mV p-p with the specified operating conditions.

TIME DOMAIN MEASUREMENT

Avoid ground loops when using an oscilloscope probe by eliminating long ground leads, as loops formed by the signal tip and long ground leads create additional inductance, in effect inducing higher switching transients during the switching transition.

When measuring low level output ripple, a common 10× oscilloscope probe is not recommended. The signal may be lower than the maximum sensitivity of the oscilloscope probe. It may be the same level as the channel noise floor. Thus, the 10× probe attenuates the signal by a factor of 10, pushing the low level signal down towards the oscilloscope noise floor. If you need to perform low level ripple measurements, consider a 1× passive probe or a 50 Ω coaxial cable.

Figure 6 shows the incorrect probing method, and Figure 7 shows its measurement waveform.

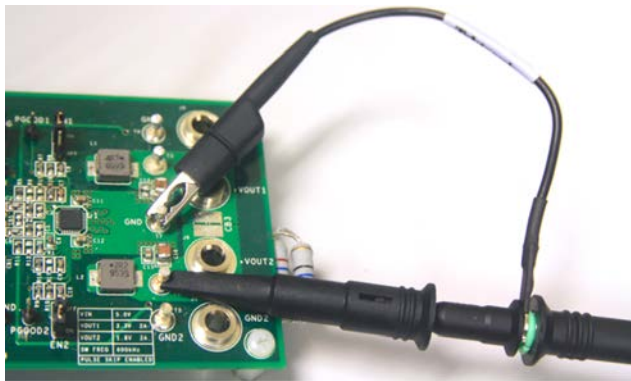

Figure 6. Incorrect Ground Loop Method

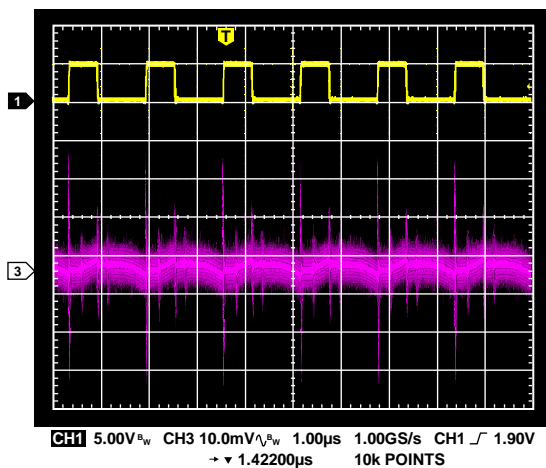

Figure 7. Switch Node and AC-Coupled Output Waveform from Figure 6

High frequency transients are evident in Figure 7 due to the loop formed by the long ground leads of the oscilloscope probe. This was measured using a 500 MHz bandwidth setting in the oscilloscope. The large amplitude of the transients in Figure 7 is not inherent in the part, but is a measurement artifact.

There are a few ways to reduce the stray inductance. One method is to remove the long ground leads of the standard oscilloscope probe and connect its barrel body to the ground reference.

The tip and barrel method is shown in Figure 8.

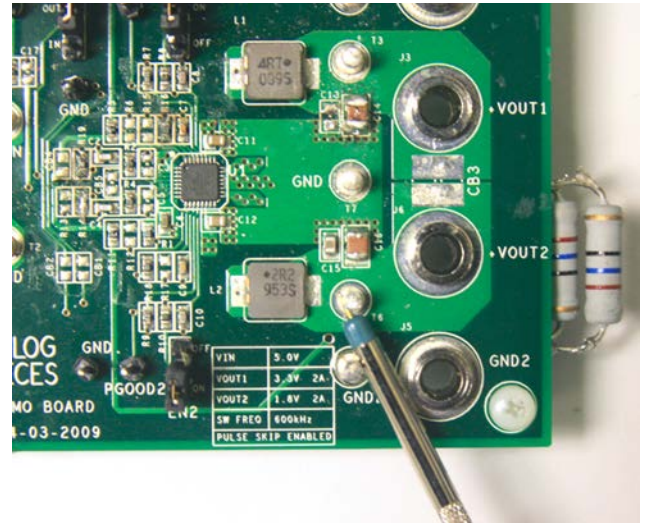

Figure 8. Tip and Barrel Method Probed on Any Point of Switcher's Output

The tip is connected at the incorrect point of the switching regulator output. The ground leads are removed, but the inductance caused by the trace path on the board remains. Probing directly on the output capacitor is recommended instead.

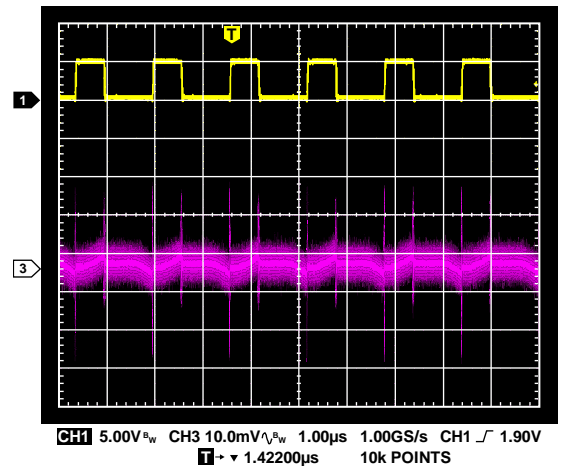

Figure 9. Switch Node and AC-Coupled Output Waveform from Figure 8

Figure 9 shows the results from the method shown in Figure 8 at a 500 MHz bandwidth setting. High frequency transients are minimized because the long ground leads were removed.

Probing on the output capacitor using a grounded coil wire (see Figure 10) produces nearly optimal ripple detail. Trace inductance on the board is significantly reduced and switching transient amplitude is decreased. However, a low signal silhouette is still evidently superimposed on the ripple as shown in Figure 11.

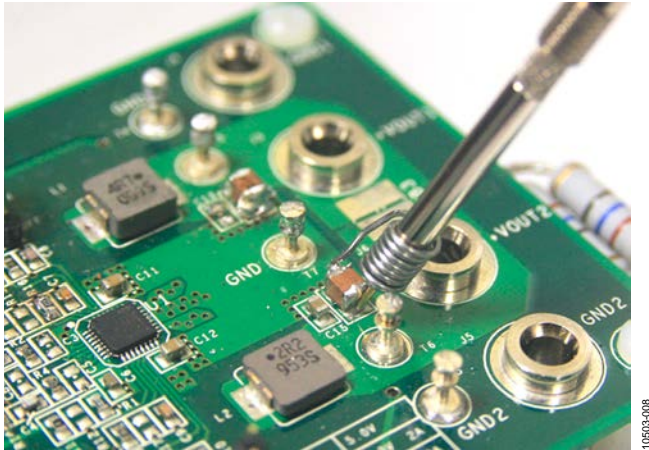

Figure 10. Tip and Barrel Method Probed on Output Capacitor Using Coil Wire

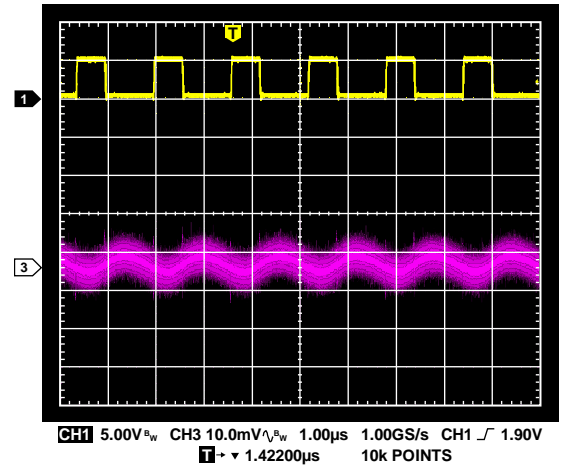
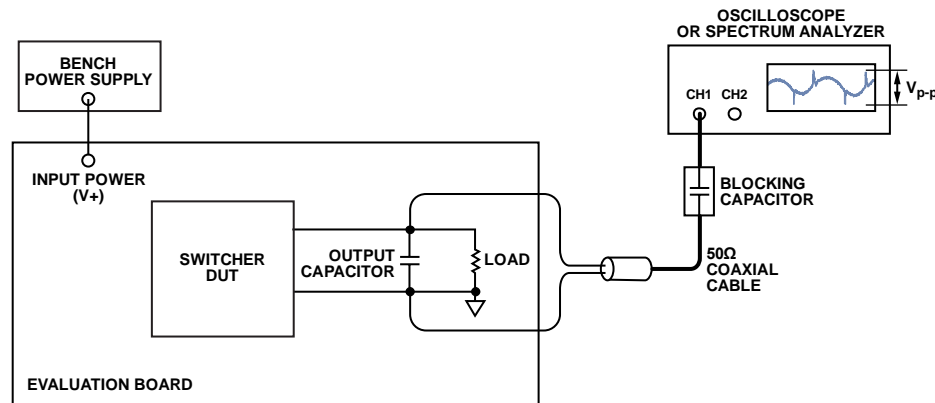

Figure 11. Switch Node and AC-Coupled Output Waveform from Figure 10

BEST METHOD

The best method uses a 50 Ω coaxial cable maintained in a 50 Ω environment and terminated by the selectable 50 Ω input impedance of the oscilloscope. Place a dc blocking capacitor between the output capacitor of the switching regulator and the oscilloscope input. The other end of the cable can be soldered directly to the output capacitor using very short flying leads (see Figure 12 and Figure 13). This preserves signal integrity, specifically when measuring very low level signals over a wide bandwidth.



- NOTES
 1. OSCILLOSCOPE OR SPECTRUM ANALYZER SHOULD BE SET FOR A 50Ω TERMINATION.
 2. USE AN OSCILLOSCOPE WITH 500MHz BANDWIDTH.

Figure 12. Best Method Using an End-Terminated 50 Ω Coaxial Cable



Figure 13. Best Method Example

At 500 MHz bandwidth, each of the previous measurement methods was compared with the 50 Ω coaxial method. Figure 14 to Figure 17 show the results.

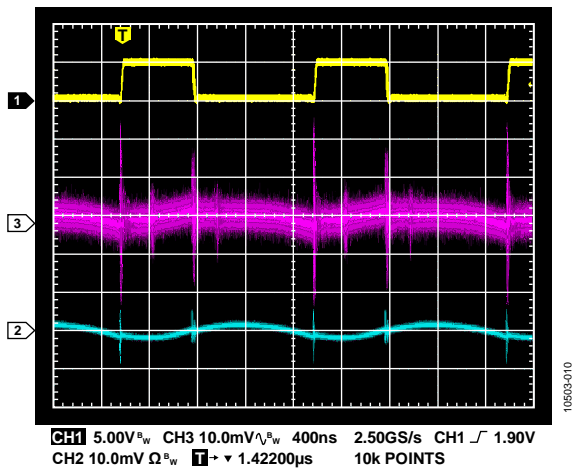

Figure 14. Switch Node (1), Standard Oscilloscope Probe with Long Ground Lead (3), and 50 Ω Coaxial Method (2) Waveform

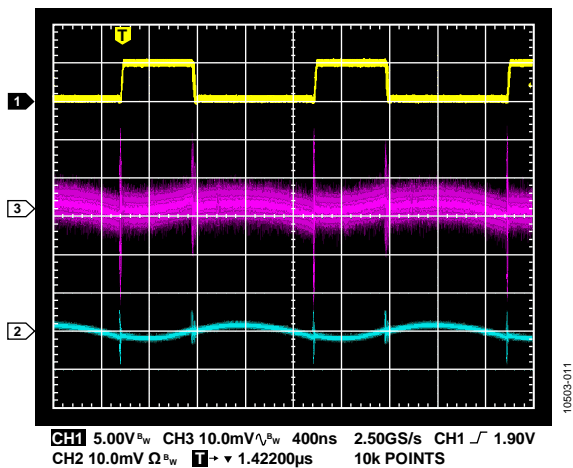

Figure 15. Switch Node (1), Tip and Barrel Method on Any Point of Switcher Output (3), and 50 Ω Coaxial Method (2) Waveform

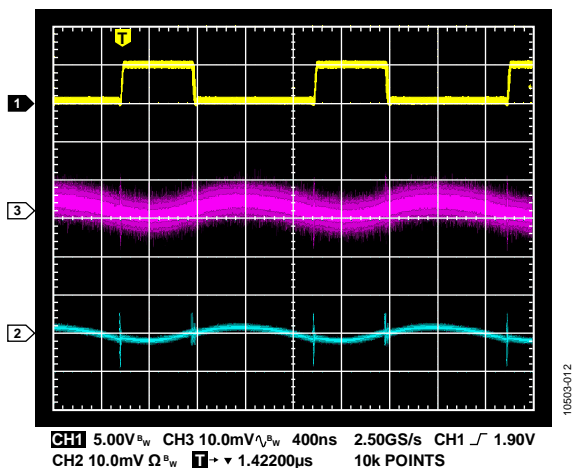

Figure 16. Switch Node (1), Tip and Barrel Method Probed on Output Capacitor (3), and 50 Ω Coaxial Method (2) Waveform

Comparison of the different techniques shows that using the coaxial cable in a 50 Ω environment generates more accurate results with less noise on the ripple itself, even at 500 MHz bandwidth setting. Changing the oscilloscope bandwidth setting to 20 MHz removes the high frequency component of the signal leaving the output ripple itself (see Figure 17).

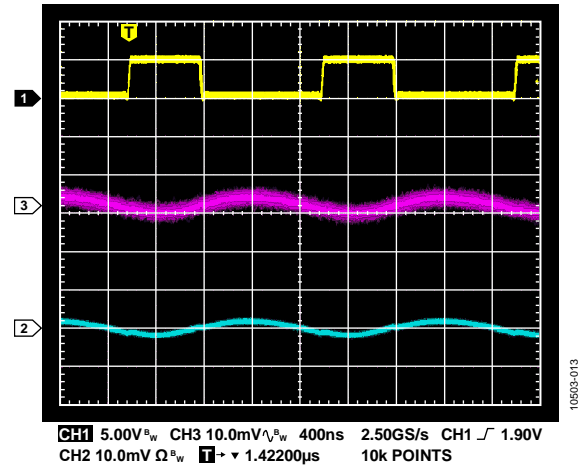

Figure 17. Switch Node (1), Tip and Barrel Method Probed on Output Capacitor (3), and 50 Ω Coaxial Method (2) Waveform Using 20 MHz Oscilloscope Bandwidth Setting

Minimal signal or noise silhouette variations on the ripple were observed and no other unwanted signal artifacts besides the switching transients were removed after the bandwidth reduction. This proves that using a coaxial cable in a 50 Ω environment is the best solution when measuring low output ripple and switching transients signals across a wide bandwidth.

In Figure 18, the ADP2114 generates an output ripple of 3.9 mV p-p in the time domain, which is near the frequency domain measured value of 4 mV p-p using the 20 MHz bandwidth setting. The measured results also correlate closely with the theoretical results of 3.76 mV p-p.

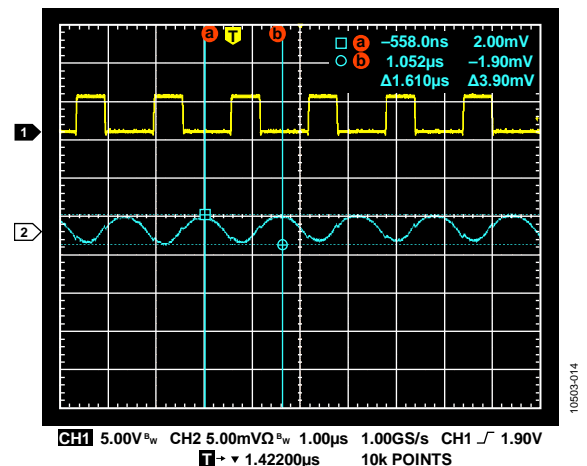

Figure 18. Switch Node (1) and Output Ripple (2) Waveform

MEASURING SWITCHING TRANSIENTS

Switching transients have low energy but higher frequency content than the output ripple. This occurs during switching transition and is often standardized as a peak-to-peak value including the ripple content.

Figure 19 shows a switching transients waveform using a standard oscilloscope probe with long ground leads vs. a 50 Ω coaxial termination. Typically, the ground loop due to the long ground leads generates larger switching transients measurements than expected.

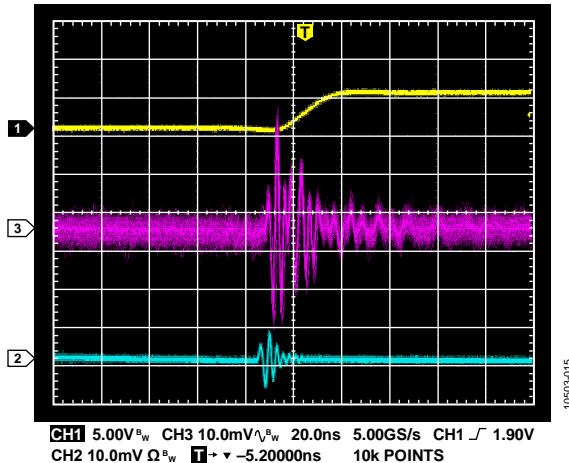

Figure 19. Switch Node Transition (1), Waveform Using Standard Oscilloscope Probe (3), and 50 Ω Coaxial Termination (2)

CONCLUSION

These measurement techniques and methods were studied and conducted to produce an accurate and reproducible result in the time and frequency domains.

It is very important to maintain a 50 Ω environment when measuring low level signals in a wide range of frequencies. A simple and low cost way to do this measurement is to use a 50 Ω coaxial cable that is properly end terminated. This method can be used and applied to a wide range of switching regulator topologies.

Output ripple and switching transient measurement techniques are important elements to consider when designing and optimizing the system power supply for low noise, sensitive, and high performance applications.

REFERENCES

ADP2114 Data Sheet. Analog Devices, Inc.

Erickson, R. W. *Fundamental of Power Electronics*. New York: Springer Science & Business Media, Inc., 2001.

SynQor. Application Note 01-08-01, Rev. 01., *Output Ripple Voltage Measurements*. (Available on the SynQors website).

Williams, Jim. Application Note 70, *A Monolithic Switching Regulator with 100 μ V Output Noise*. Linear Technology, 1997.