

Inverting Buck-Boost Evaluation Board for the **ADP2386**, 20 V, 6 A Synchronous Step-Down DC-to-DC Regulator

FEATURES

Input voltage: 4.5 V to 15 V
Output voltage: -0.6 V to -15 V
±1% output voltage accuracy
Output current up to 4 A
Integrated MOSFET
 44 mΩ/11 mΩ
Programmable switching frequency: 200 kHz to 1.4 MHz
Level-shifting circuit for EN signal
External compensation
Internal soft start with external adjustable option
Startup into precharged output
Compact solution size

ONLINE RESOURCES

Evaluation Kit Contents
[ADP2386BB-EVALZ](#)
Documents Needed
[ADP2386 data sheet](#)
[AN-1168 Application Note](#)

EQUIPMENT NEEDED

DC power supply
DC electronic load
Oscilloscope
Digital multimeter

GENERAL DESCRIPTION

The **ADP2386** inverting buck-boost evaluation board is a complete, high current inverting buck-boost solution, realized by using a typical step-down regulator, which allows users to evaluate the performance of the **ADP2386** with a near ideal printed circuit board (PCB) layout.

The switching frequency can be programmed between 200 kHz and 1.4 MHz. External compensation with adjustable soft start time provides design flexibility and system stability.

The extra level-shifting circuit for the enable signal ensures the reliability of turning on/off the regulator while providing easy sequence control at the same time.

The output of the **ADP2386** inverting buck-boost evaluation board is preset to -5 V/4 A, and the switching frequency is set to 600 kHz. Different output voltage settings can be achieved by changing appropriate passive components. The ambient temperature operating range is -40°C to +85°C.

The optimized compact solution size provides an excellent design reference for users.

Full details on the **ADP2386** regulator are provided in the **ADP2386** data sheet, available from Analog Devices, Inc., which should be consulted in conjunction with this user guide.

ADP2386 INVERTING BUCK-BOOST EVALUATION BOARD

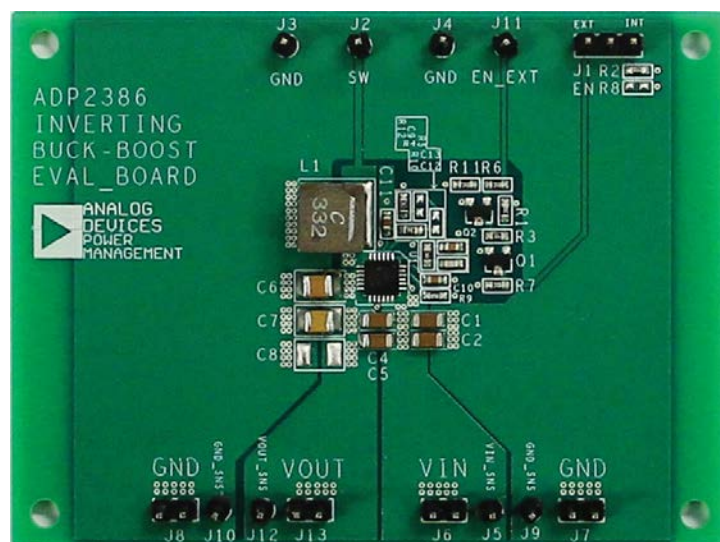

Figure 1.

TABLE OF CONTENTS

Features	1	Modifying the Board.....	4
General Description	1	Typical Performance Characteristics	6
ADP2386 Inverting Buck-Boost Evaluation Board	1	Evaluation Board Schematic and Artwork.....	8
Revision History	2	Schematic.....	8
Using the Evaluation Board.....	3	PCB Layout	9
Powering Up.....	3	Ordering Information.....	10
Measuring Evaluation Board Performance	3	Bill of Materials.....	10
Application Limitations	4		

REVISION HISTORY

4/13—Revision 0: Initial Version

USING THE EVALUATION BOARD

POWERING UP

The [ADP2386](#) inverting buck-boost evaluation board is supplied fully assembled and tested. Before applying power to the evaluation board, follow the procedures in this section.

Jumper J1 (EN)

Use one of the following methods to enable or to disable the regulator:

- To enable the regulator, short the middle pin of J1 to INT.
- To disable the regulator, leave all the pins of J1 unconnected.

Input Power Source

If the input power source includes a current meter, use that meter to monitor the input current. Connect the positive terminal of the power source to J6 (VIN) of the evaluation board, and the negative terminal of the power source to J7 (GND) of the evaluation board.

If the power source does not include a current meter, connect a current meter in series with the input source voltage. Connect the positive lead (+) of the power source to the positive (+) ammeter terminal, the negative lead (–) of the power source to J7 (GND), and the negative lead (–) of the ammeter to J6 (VIN).

Output Load

Before connecting the load, ensure that the board is turned off. Connect an electronic load or resistor to set the load current.

Because the output voltage is negative, if using an electronic load to perform the output load, connect the positive terminal of the electronic load to J8 (GND) of the evaluation board and connect the negative terminal of the electronic load to J13 (VOUT).

The maximum output current capability may vary with the change of input voltage, output voltage, switching frequency, and the inductor, and may not always remain at 4 A. For detailed information, refer to the Application Limitations section.

Input and Output Voltmeter

Measure the input and output voltages using voltmeters. Make sure that the voltmeters are connected to the appropriate terminals of the evaluation board and not to the load or power source. If the voltmeters are not connected directly to the evaluation board, the measured voltages are incorrect due to the voltage drop across the leads and/or connections between the evaluation board, the power source, and/or the load.

To measure the input voltage, connect the positive terminal of the voltmeter to J5 (VIN_SNS) and the negative terminal to J9 (GND_SNS). Likewise, to measure the output voltage, connect the positive terminal of the voltmeter to J12 (VOUT_SNS) and the negative terminal to J10 (GND_SNS).

Turning On the Evaluation Board

When the power source and load are connected to the evaluation board, it can be powered for operation.

Perform the following steps to turn on the board:

1. Ensure that the power source voltage is $>4.5\text{ V}$ and $<20\text{ V} - |-5\text{ V}| = 15\text{ V}$.
2. Ensure that EN is connected to INT, and monitor the output voltage.
3. Turn on the load, check that it is drawing the proper load current, and verify that the output voltage maintains its regulation.

MEASURING EVALUATION BOARD PERFORMANCE

Measuring the Switching Waveform

To observe the switching waveform with an oscilloscope, place the oscilloscope probe tip at Test Point J2 (SW) with the probe ground at J3 (GND). Set the scope to dc with the appropriate voltage and time divisions. The switching waveform limits should alternate approximately between output voltage and the input voltage.

Measuring Load Regulation

Load regulation can be tested by observing the change in the output voltage with increasing output load current. To minimize the voltage drop, use short, low resistance wires.

Measuring Line Regulation

Vary the input voltage and examine the change in the output voltage with a fixed output current.

Line Transient Response

Generate a step input voltage change, and observe the behavior of the output voltage using an oscilloscope.

Load Transient Response

Generate a load current transient at the output, and observe the output voltage response using an oscilloscope. Attach the current probe to the wire between the output and the load to capture the current transient waveform.

Measuring Efficiency

The efficiency, η , is measured by comparing the input power with the output power.

$$\eta = \frac{-V_{OUT} \times I_{OUT}}{V_{IN} \times I_{IN}}$$

Measure the input and output voltages as close as possible to the input and output capacitors to reduce the effect of voltage drop.

Measuring Inductor Current

The inductor current can be measured by removing one end of the inductor from its pad and connecting a current loop in series. A current probe can be connected onto this wire.

Measuring Output Voltage Ripple

To observe the output voltage ripple, place the oscilloscope probe across the output capacitor with the probe ground lead connected to the GND terminal of the capacitor and the probe tip placed at the VOUT terminal of the capacitor terminal. Set the oscilloscope to ac, 10 mV/division, 2 μs/division time base, and 20 MHz bandwidth.

A standard oscilloscope probe has a long wire ground clip. For high frequency measurements, this ground clip picks up high frequency noise and injects it into the measured output ripple. Figure 2 shows an easy way to measure the output ripple properly. It requires removing the oscilloscope probe sheath and wrapping an unshielded wire around the oscilloscope probe. By keeping the ground length of the oscilloscope probe as short as possible, the true ripple can be measured.

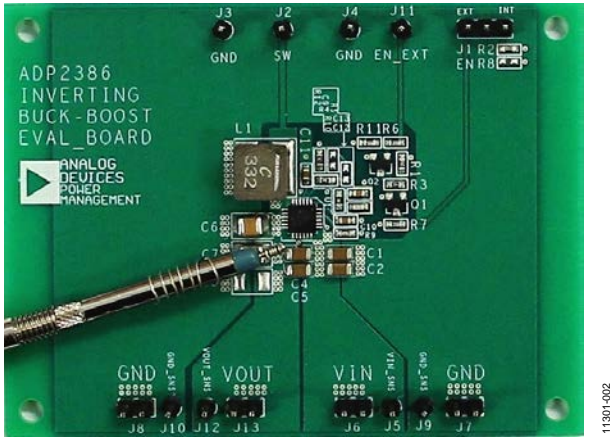

Figure 2. Measuring Output Voltage Ripple

APPLICATION LIMITATIONS

To implement the inverting buck-boost topology power supply application by using the ADP2386 synchronous buck regulator, some basic design restrictions must be taken into consideration as follows:

- The minimum input voltage, V_{IN_MIN} , should be greater than the UVLO threshold of the device, which has the typical value of 4.5 V.
- The maximum input voltage, V_{IN_MAX} , plus the absolute value of the output voltage $|V_{OUT}|$ should be less than the maximum operation input voltage of the device, which has the typical value of 20 V.
- The inductor peak current should be smaller than the overcurrent protection (OCP) trigger point of the device.

Similar to most peak current mode buck regulators, the ADP2386 senses the peak inductor current to determine whether to induce current limit. To avoid premature current limit, the peak inductor current must not exceed the OCP threshold of the device. Taking into account this peak inductor current, the application space of this inverting buck-boost evaluation board for some common input voltages at 600 kHz switching frequency is shown in Figure 3, with the assumption

that the peak-to-peak inductor ripple current is 40% of the inductor average current.

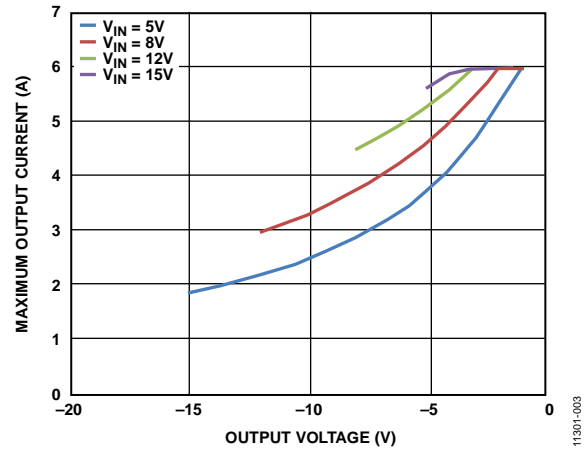

Figure 3. Application Space for Common Input Voltages at $f_{sw} = 600$ kHz

MODIFYING THE BOARD

To modify the ADP2386 inverting buck-boost evaluation board configuration, unsolder and/or replace/remove the appropriate passive components or jumpers on the board.

Changing the Output Voltages

The output voltage set points of the ADP2386 can be changed by replacing the R4 and R12 resistors with the resistor values shown in Table 1.

Table 1. Resistive Divider for Various Output Voltages

V_{OUT} (V)	R4, ±1% (kΩ)	R12, ±1% (kΩ)
-1.2	10	10
-1.8	20	10
-2.5	47.5	15
-3.3	10	2.21
-5	22	3
-12	28	1.47
-15	35.7	1.5

To limit output voltage accuracy degradation due to the FB pin bias current (0.1 μA maximum) to less than 0.5% (maximum), ensure that the bottom divider string resistor, R12, is less than 30 kΩ.

The top resistor, R4, value is calculated using the following equation:

$$R4 = R12 \times \left(\frac{|V_{OUT}| - 0.6 \text{ V}}{0.6 \text{ V}} \right)$$

When the output voltage is changed, the values of the inductor (L1), the output capacitors (C6, C7, and C8), and the compensation components (R10, C12, and C13) must be recalculated and changed to ensure stable operation (see the AN-1168 Application Note, *Designing an Inverting Power Supply Using the ADP2384/ADP2386 Synchronous Step-Down DC-to-DC Regulators*, for details on external component selection).

Changing the Switching Frequency

The switching frequency (f_{sw}) setpoint can be changed by replacing the R9 resistor with a different value, as shown in the following equation:

$$f_{sw} [\text{kHz}] = 69,120 / (R9 [\text{k}\Omega] + 15)$$

A 215 k Ω resistor sets the frequency to 300 kHz, and a 100 k Ω resistor sets the frequency to 600 kHz.

When the switching frequency is changed, the values of the inductor (L1), the output capacitors (C6, C7, C8), and the compensation components (R10, C13, C12) must be recalculated and changed for stable operation (see the [AN-1168 Application Note](#) for details on external component selection).

Changing the Soft Start Time

The soft start time of the [ADP2386](#) on the evaluation board is programmed to 4 ms.

To change the soft start time, t_{ss} , replace the C10 capacitor value using the following equation:

$$C10 [\text{nF}] = 5.33 \times t_{ss} [\text{ms}]$$

Using an External Enable Level-shifting Circuit

In the application of using a buck regulator such as the [ADP2386](#) to perform an inverting buck-boost topology, the IC is referenced to the negative output voltage instead of the system ground. It is possible that if the EN pin is connected to system ground with the intention of disabling the regulator, the [ADP2386](#) may still be switching. One of the possible solutions for this is to use an external enable level-shifting circuit.

To use the enable level-shifting circuit, short the middle pin of J1 (EN) to EXT. Add a logic high voltage, such as 5 V, between J11 (EN_EXT) and J4 (GND) to enable the regulator. Alternatively, a logic low voltage, such as 0 V, between J11 (EN_EXT) and J4 (GND) disables the regulator.

TYPICAL PERFORMANCE CHARACTERISTICS

$T_A = 25^\circ\text{C}$, $V_{IN} = 12\text{ V}$, $V_{OUT} = -5\text{ V}$, $L = 3.3\ \mu\text{H}$, $C_{OUT} = 2 \times 100\ \mu\text{F}$, $f_{SW} = 600\ \text{kHz}$, unless otherwise noted.

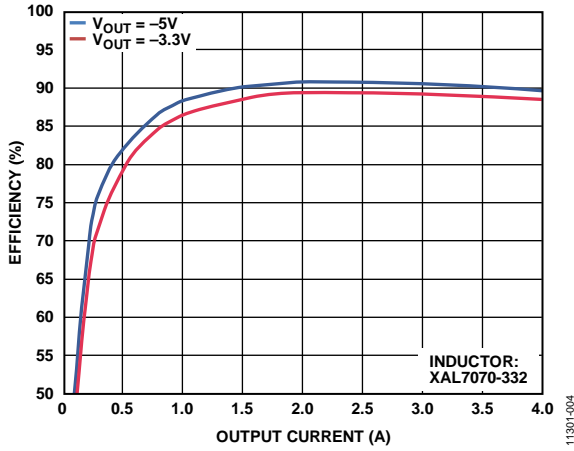

Figure 4. Efficiency at $V_{IN} = 12\text{ V}$, $f_{SW} = 600\ \text{kHz}$

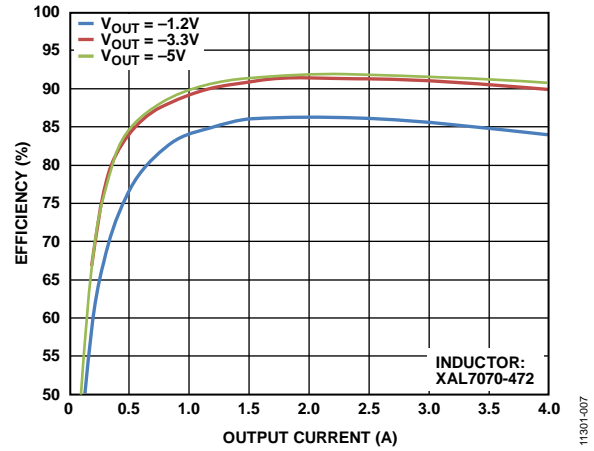

Figure 7. Efficiency at $V_{IN} = 12\text{ V}$, $f_{SW} = 300\ \text{kHz}$

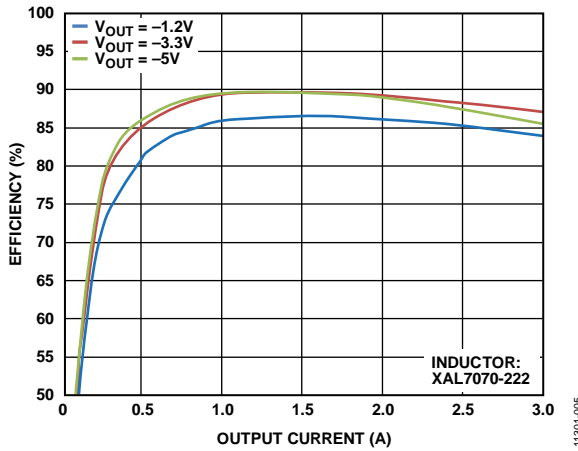

Figure 5. Efficiency at $V_{IN} = 5\text{ V}$, $f_{SW} = 600\ \text{kHz}$

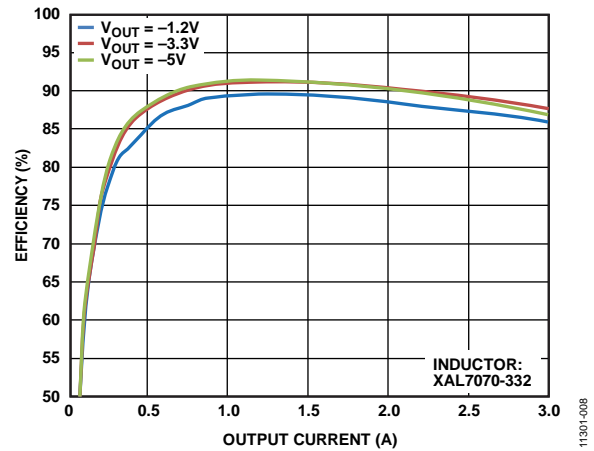

Figure 8. Efficiency at $V_{IN} = 5\text{ V}$, $f_{SW} = 300\ \text{kHz}$

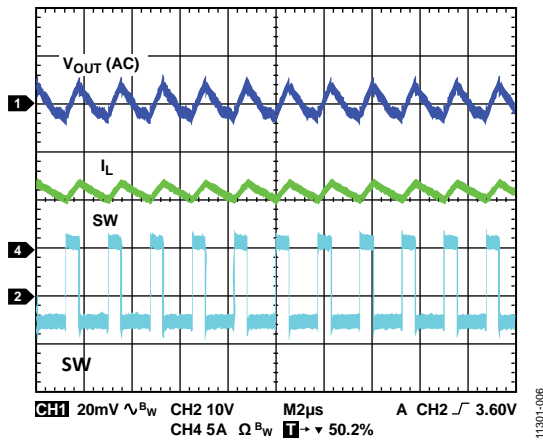

Figure 6. Working Mode Waveform

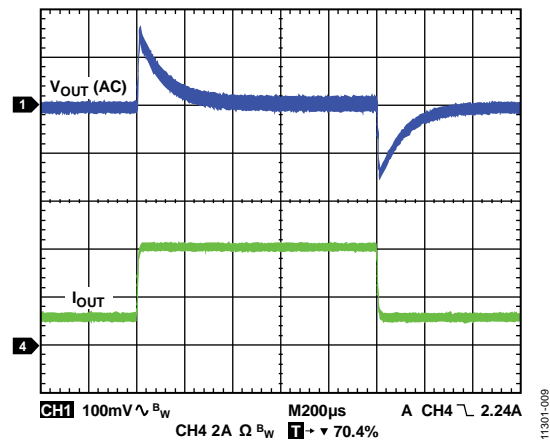

Figure 9. Load Transient Response, 1 A to 4 A

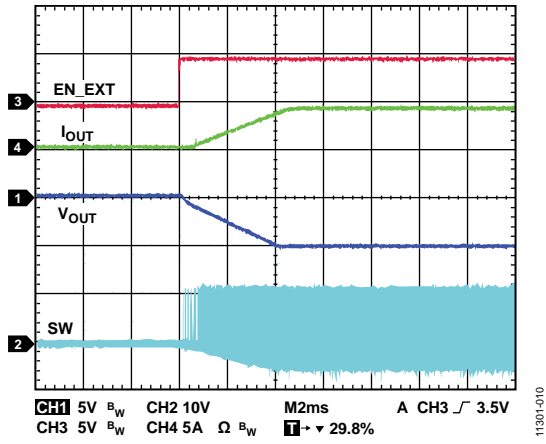

Figure 10. Startup with 4 A Load

11301-010

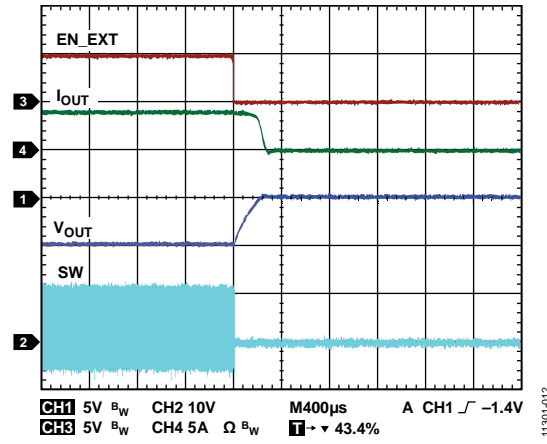

Figure 12. Shutdown with 4 A Load

11301-012

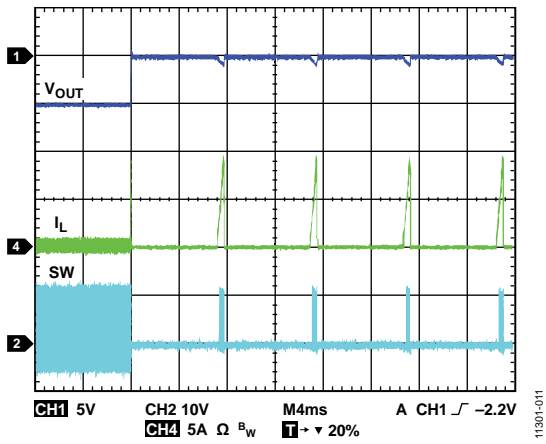

Figure 11. Output Short Entry

11301-011

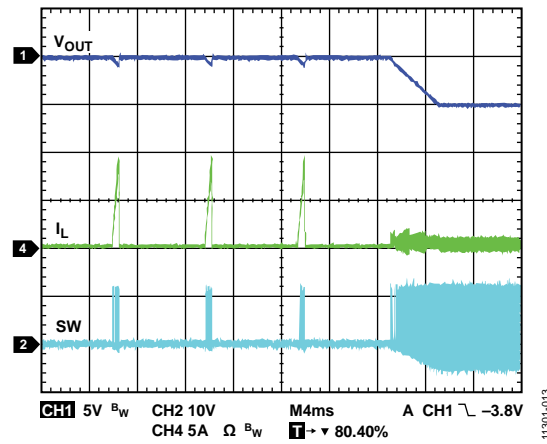
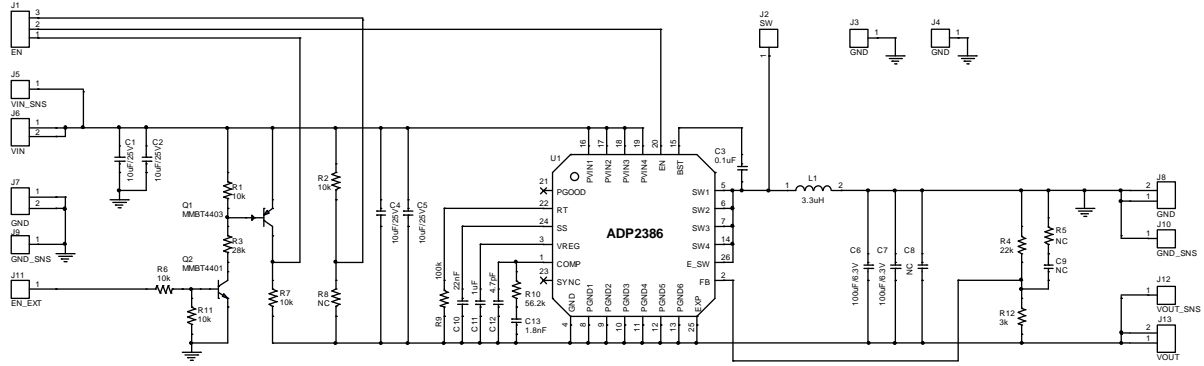

Figure 13. Output Short Recovery

11301-013

EVALUATION BOARD SCHEMATIC AND ARTWORK
SCHEMATIC



Vin = 12V, Vout = -5V, Iout = 4A, Fsw = 600kHz

Figure 14. Evaluation Board Schematic for ADP2386

11381-014

PCB LAYOUT

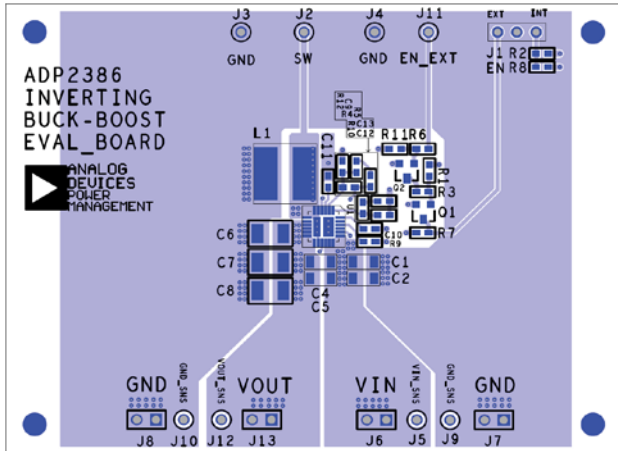

Figure 15. Layer 1, Component Side

11301-015

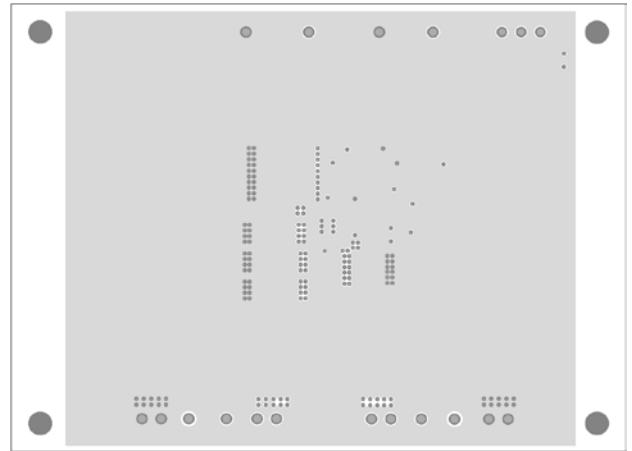

Figure 17. Layer 2, Ground Plane

11301-017

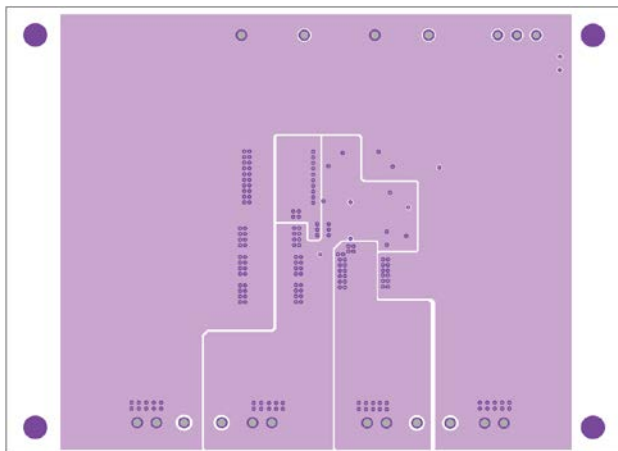

Figure 16. Layer 3, Power Plane

11301-016

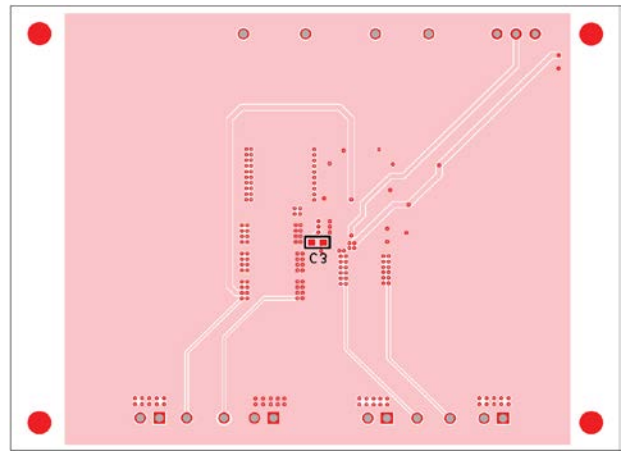

Figure 18. Layer 4, Bottom Side

11301-018

ORDERING INFORMATION**BILL OF MATERIALS**

Table 2.

Qty	Reference Designator	Description	Part Number/Vendor
4	C1, C2, C4, C5	10 μ F, 25 V, capacitor, 1206	GRM31CR61E106MA12L/Murata
1	C3	0.1 μ F, 16 V, capacitor, 0603	GRM188R71C104KA01D/Murata
2	C6, C7	100 μ F, 6.3 V, capacitor, 1210	GRM32ER60J107ME20L/Murata
1	C8	Optional, capacitor, 1210	Optional/Murata
1	C9	Optional, capacitor, 0603	Optional/Murata
1	C10	22 nF, 16 V, capacitor, 0603	GRM188R71C223KA01D/Murata
1	C11	1 μ F, 16 V, capacitor, 0603	GRM188R61C105KA93D/Murata
1	C12	4.7 pF, 50 V, capacitor, 0603	GRM1885C1H4R7CZ01D/Murata
1	C13	1.8 nF, 50 V, capacitor, 0603	GRM188R71H182KA01D/Murata
1	L1	Inductor, XAL7070, L = 3.3 μ H, I _{RAT} = 19.4 A, DCR = 8.56 m Ω	XAL7070-332ME/Coilcraft
1	Q1	PNP switching transistor, SOT-23	MMBT4403L/ON Semiconductor
1	Q2	NPN switching transistor, SOT-23	MMBT4401L/ON Semiconductor
5	R1, R2, R6, R7, R11	10 k Ω , 1%, resistor, 0603	CRCW060310K0FKEA/Vishay Dale
1	R3	28 k Ω , 1%, resistor, 0603	CRCW060328K0FKEA/Vishay Dale
1	R4	22 k Ω , 1%, resistor, 0603	CRCW060322K0FKEA/Vishay Dale
2	R5, R8	Optional, resistor, 0603	Optional/Vishay Dale
1	R9	100 k Ω , 1%, resistor, 0603	CRCW0603100KFKEA/Vishay Dale
1	R10	56.2 k Ω , 1%, resistor, 0603	CRCW060356K2FKEA/Vishay Dale
1	R12	3 k Ω , 1%, resistor, 0603	CRCW06033K00FKEA/Vishay Dale
1	U1	20 V, 6 A, synchronous, step-down regulator, 24-lead LFCSP_WQ, with exposed pad	ADP2386/Analog Devices, Inc.
1	J1	Jumper, 0.1-inch header, 3-way, SIP3	M20-9990346/Harwin
8	J2, J3, J4, J5, J9, J10, J11, J12	Test point, 2.54 mm pitch SIL vertical PC tail pin header, 6.1 mm mating pin height, tin, SIP1	M20-9990245/Harwin
4	J6, J7, J8, J13	Connector, 2.54 mm pitch SIL vertical PC tail pin header, 6.1 mm mating pin height, tin, 2-way, SIP2	M20-9990245/Harwin

NOTES

NOTES

**ESD Caution**

ESD (electrostatic discharge) sensitive device. Charged devices and circuit boards can discharge without detection. Although this product features patented or proprietary protection circuitry, damage may occur on devices subjected to high energy ESD. Therefore, proper ESD precautions should be taken to avoid performance degradation or loss of functionality.

Legal Terms and Conditions

By using the evaluation board discussed herein (together with any tools, components documentation or support materials, the "Evaluation Board"), you are agreeing to be bound by the terms and conditions set forth below ("Agreement") unless you have purchased the Evaluation Board, in which case the Analog Devices Standard Terms and Conditions of Sale shall govern. Do not use the Evaluation Board until you have read and agreed to the Agreement. Your use of the Evaluation Board shall signify your acceptance of the Agreement. This Agreement is made by and between you ("Customer") and Analog Devices, Inc. ("ADI"), with its principal place of business at One Technology Way, Norwood, MA 02062, USA. Subject to the terms and conditions of the Agreement, ADI hereby grants to Customer a free, limited, personal, temporary, non-exclusive, non-sublicensable, non-transferable license to use the Evaluation Board FOR EVALUATION PURPOSES ONLY. Customer understands and agrees that the Evaluation Board is provided for the sole and exclusive purpose referenced above, and agrees not to use the Evaluation Board for any other purpose. Furthermore, the license granted is expressly made subject to the following additional limitations: Customer shall not (i) rent, lease, display, sell, transfer, assign, sublicense, or distribute the Evaluation Board; and (ii) permit any Third Party to access the Evaluation Board. As used herein, the term "Third Party" includes any entity other than ADI, Customer, their employees, affiliates and in-house consultants. The Evaluation Board is NOT sold to Customer; all rights not expressly granted herein, including ownership of the Evaluation Board, are reserved by ADI. CONFIDENTIALITY. This Agreement and the Evaluation Board shall all be considered the confidential and proprietary information of ADI. Customer may not disclose or transfer any portion of the Evaluation Board to any other party for any reason. Upon discontinuation of use of the Evaluation Board or termination of this Agreement, Customer agrees to promptly return the Evaluation Board to ADI. ADDITIONAL RESTRICTIONS. Customer may not disassemble, decompile or reverse engineer chips on the Evaluation Board. Customer shall inform ADI of any occurred damages or any modifications or alterations it makes to the Evaluation Board, including but not limited to soldering or any other activity that affects the material content of the Evaluation Board. Modifications to the Evaluation Board must comply with applicable law, including but not limited to the RoHS Directive. TERMINATION. ADI may terminate this Agreement at any time upon giving written notice to Customer. Customer agrees to return to ADI the Evaluation Board at that time. LIMITATION OF LIABILITY. THE EVALUATION BOARD PROVIDED HEREUNDER IS PROVIDED "AS IS" AND ADI MAKES NO WARRANTIES OR REPRESENTATIONS OF ANY KIND WITH RESPECT TO IT. ADI SPECIFICALLY DISCLAIMS ANY REPRESENTATIONS, ENDORSEMENTS, GUARANTEES, OR WARRANTIES, EXPRESS OR IMPLIED, RELATED TO THE EVALUATION BOARD INCLUDING, BUT NOT LIMITED TO, THE IMPLIED WARRANTY OF MERCHANTABILITY, TITLE, FITNESS FOR A PARTICULAR PURPOSE OR NON-INFRINGEMENT OF INTELLECTUAL PROPERTY RIGHTS. IN NO EVENT WILL ADI AND ITS LICENSORS BE LIABLE FOR ANY INCIDENTAL, SPECIAL, INDIRECT, OR CONSEQUENTIAL DAMAGES RESULTING FROM CUSTOMER'S POSSESSION OR USE OF THE EVALUATION BOARD, INCLUDING BUT NOT LIMITED TO LOST PROFITS, DELAY COSTS, LABOR COSTS OR LOSS OF GOODWILL. ADI'S TOTAL LIABILITY FROM ANY AND ALL CAUSES SHALL BE LIMITED TO THE AMOUNT OF ONE HUNDRED US DOLLARS (\$100.00). EXPORT. Customer agrees that it will not directly or indirectly export the Evaluation Board to another country, and that it will comply with all applicable United States federal laws and regulations relating to exports. GOVERNING LAW. This Agreement shall be governed by and construed in accordance with the substantive laws of the Commonwealth of Massachusetts (excluding conflict of law rules). Any legal action regarding this Agreement will be heard in the state or federal courts having jurisdiction in Suffolk County, Massachusetts, and Customer hereby submits to the personal jurisdiction and venue of such courts. The United Nations Convention on Contracts for the International Sale of Goods shall not apply to this Agreement and is expressly disclaimed.