

Getting Started With Blackfin® Processors

Revision 6.0, September 2010

Part Number
82-000850-01

Analog Devices, Inc.
One Technology Way
Norwood, Mass. 02062-9106



Copyright Information

©2010 Analog Devices, Inc., ALL RIGHTS RESERVED. This document may not be reproduced in any form without prior, express written consent from Analog Devices.

Printed in the USA.

Disclaimer

Analog Devices reserves the right to change this product without prior notice. Information furnished by Analog Devices is believed to be accurate and reliable. However, no responsibility is assumed by Analog Devices for its use; nor for any infringement of patents or other rights of third parties which may result from its use. No license is granted by implication or otherwise under the patent rights of Analog Devices.

Trademark and Service Mark Notice

The Analog Devices logo, Blackfin, the Blackfin logo, CROSSCORE, EZ-Extender, EZ-KIT Lite, and VisualDSP++ are registered trademarks of Analog Devices.

EZ-Board is a trademark of Analog Devices.

All other brand and product names are trademarks or service marks of their respective owners.

CONTENTS

PREFACE

Purpose of This Manual	xi
Intended Audience	xii
Manual Contents	xii
What's New in This Manual	xii
Technical or Customer Support	xiii
Product Information	xiii
Analog Devices Web Site	xiii
VisualDSP++ Online Documentation	xiv
EngineerZone	xv
Social Networking Web Sites	xv

INTRODUCTION

What are Blackfin Processors?	1-1
Combining RISC MCU and Signal Processor Functionality	1-2
Approaches to Application Development	1-4
Dual-Core Processors Add Flexibility	1-6

Contents

The Blackfin Family of Processors	1-7
Blackfin Processors (Currently Available)	1-7
Future Blackfin Processor Releases	1-27
Blackfin Processor Features	1-27
Performance	1-28
Benchmarks Against Other Processors	1-30
Dhrystone	1-30
Whetstone	1-31
nbench	1-32
EEMBC	1-33
Analog Devices Benchmarks	1-35
Links to Comparative Benchmarks	1-36
Blackfin Processor Compiler and Code Density	1-36

THE EVALUATION PROCESS

Selecting Software Development Tools	2-1
VisualDSP++ From Analog Devices	2-3
Platform and Processor Support	2-3
Develop High-Performance Applications Quickly	2-3
Leverage-Proven Application Infrastructure	2-5
Debug and Tune Your Application With Ease	2-6
Integrate Into Your Existing Environment	2-8
Get Help and Stay Up to Date	2-9
Use Third Parties	2-10
Install VisualDSP++	2-10

Analog Devices Tools	2-10
Embedded Processors and DSPs	2-10
Code Examples	2-11
Device Drivers and System Services	2-11
Open Source Software for Blackfin Processor	2-12
GNU Toolchain	2-12
Linux and μ Clinux	2-13
Linux and GNU Toolchain Help: The Blackfin Koop	2-14
Eclipse IDE	2-14
μ Clinux Distribution	2-15
Blackfin μ Clinux	2-15
Analog Devices Processors Supported for μ Clinux	2-16
Latest Versions of Linux and Corresponding URLs	2-16
μ Clinux Footprint	2-16
Recommended Flash Size	2-16
Supported Debugging Tools	2-17
Real-Time and General-Purpose Kernels	2-17
Linux Software Projects	2-17
Board Support Packages	2-19
Daughter Cards	2-20
Linux Hardware Projects	2-20
Summary: Software Development Tools	2-22
Examples Included With VisualDSP++	2-22
Software Modules	2-23

Contents

Selecting Hardware Development Tools	2-23
EZ-KIT Lite and EZ-Board Evaluation Systems	2-23
ADSP-BF592 EZ-KIT Lite From Analog Devices	2-26
ADSP-BF506F EZ-KIT Lite From Analog Devices	2-28
ADSP-BF518F EZ-KIT Lite From Analog Devices	2-30
ADSP-BF526 EZ-Board From Analog Devices	2-33
ADSP-BF527 EZ-KIT Lite From Analog Devices	2-36
ADSP-BF548 EZ-KIT Lite From Analog Devices	2-38
ADSP-BF538F EZ-KIT Lite From Analog Devices	2-40
ADSP-BF537 EZ-KIT Lite From Analog Devices	2-43
ADSP-BF561 EZ-KIT Lite From Analog Devices	2-45
ADSP-BF533 EZ-KIT Lite From Analog Devices	2-47
EZ-KIT Lite Expansion Boards	2-50
Blackfin EZ-Extender	2-50
Blackfin USB-LAN EZ-Extender Board	2-52
Blackfin FPGA EZ-Extender Daughter Board	2-54
Blackfin Landscape LCD EZ-Extender Daughter Board	2-57
Blackfin Audio EZ-Extender Daughter Board	2-60
Blackfin A-V EZ-Extender Board	2-62
Blackfin Bluetooth EZ-Extender Daughter Board	2-64
ADSP-BF537 STAMP Board Support Package (BSP)	2-66
Blackfin/SHARC USB EZ-Extender	2-68
Standalone Debug Agent Board	2-70

JTAG Emulators	2-71
High-Performance USB 2.0 JTAG Emulator	2-72
USB-Based JTAG Emulator	2-75
Analog Devices Blackfin Emulator	2-77
Third-Party Boards	2-80
PHYTEC phyCORE-BF537 SBC	2-80
Selecting the Right Combination of Tools	2-84
Scenario 1	2-84
Scenario 2	2-85

SUPPORT OPTIONS

Available Support	3-1
Analog Devices Web Site	3-2
Processor and Tools Selection Information	3-3
Getting Started Information	3-3
Applications Notes, EE-Notes, and Other Articles	3-3
Communities-Related Information	3-4
Visual Learning and Development (VLD) - On-Demand Video Tutorials	3-4
Platform-Related Information	3-5
Workshops and Seminars	3-5
Blackfin Processor Workshops	3-6
Blackfin Processor Seminars	3-6
TechOnLine Seminars	3-7
µClinux on the Blackfin Processor 3-Day Workshop	3-7

Contents

Processor Documentation	3-7
Blackfin Processor Manuals	3-7
Hardware Reference Manuals	3-8
Blackfin Processor Programming Reference	3-8
Open Source Software on the Blackfin Processor Manual	3-9
Data Sheets	3-9
Anomalies Lists for Processors and Tools	3-10
BSDL Files	3-10
IBIS Models	3-10
CROSSCORE Tools Documentation	3-11
VisualDSP++ Documentation	3-11
VisualDSP++ Installation Quick Reference Card	3-11
VisualDSP++ Product Release Bulletin	3-12
VisualDSP++ User's Guide	3-12
VisualDSP++ Licensing Guide	3-12
VisualDSP++ Getting Started Guide	3-13
VisualDSP++ Assembler and Preprocessor Manual	3-13
VisualDSP++ C/C++ Compiler and Library Manual for Blackfin Processors	3-13
VisualDSP++ Linker and Utilities Manual	3-14
VisualDSP++ Loader and Utilities Manual	3-14
VisualDSP++ Device Driver and System Services Libraries Manual for Blackfin Processors	3-15
VisualDSP++ Kernel (VDK) User's Guide	3-15

Hardware Tools Documentation	3-16
Getting Started With the ADSP-BF537 EZ-KIT Lite Manual	3-16
Getting Started With the ADSP-BF548 EZ-KIT Lite Manual	3-17
ADSP-BF506F EZ-Board Evaluation System Manual	3-17
ADSP-BF518F EZ-Board Evaluation System Manual	3-17
ADSP-BF526 EZ-Board Evaluation System Manual	3-18
ADSP-BF527 EZ-KIT Lite Evaluation System Manual	3-18
ADSP-BF533 EZ-KIT Lite Evaluation System Manual	3-18
ADSP-BF537 EZ-KIT Lite Evaluation System Manual	3-19
ADSP-BF538F EZ-KIT Lite Evaluation System Manual	3-19
ADSP-BF548 EZ-KIT Lite Evaluation System Manual	3-19
ADSP-BF561 EZ-KIT Lite Evaluation System Manual	3-20
ADSP-BF592 EZ-KIT Lite Evaluation System Manual	3-20
EZ-Extender Manuals	3-20
VisualDSP++ Help	3-22
Find a Third Party—Faster Time To Market	3-23
MyAnalog.com	3-23

INDEX

Contents

PREFACE

Thank you for your interest in the Blackfin® family of processors by Analog Devices, Inc.

Purpose of This Manual

Getting Started With Blackfin Processors provides you with information about the design and evaluation process, Analog Devices tools, training, documentation, and other informational resources.

This manual provides an overview of a variety of documentation available in online form as well as a guide for evaluating Blackfin processors. This manual also describes the resources available to help you move your evaluation/design along quickly.

For engineers already using Blackfin processors in their designs, this guide provides resources and pointers to help transition your system to take advantage of the newest series of processors. For detailed descriptions of a processor's internal architectures, refer to the applicable processor's hardware reference manual. For detailed descriptions of processor software, refer to the *Blackfin Processor Programming Reference*. For a complete list of documents that support Blackfin processors, refer to [“Support Options” on page 3-1](#).

Intended Audience

The primary audience for this guide is comprised of system designers, programmers, and hardware engineers who want to learn whether a specific Blackfin processor matches their design requirements for new applications.

Manual Contents

This manual consists of:

- Chapter 1, “[Introduction](#)”
This chapter briefly describes the processor architecture, available models, and processor features.
- Chapter 2, “[The Evaluation Process](#)”
This chapter focuses on available software and hardware tools.
- Chapter 3, “[Support Options](#)”
This chapter describes support (documentation, training, and more) available during the evaluation and development processes.

What’s New in This Manual

Revision 6.0 of *Getting Started With Blackfin Processors* provides information about a new Blackfin processor and EZ-KIT Lite® package.

Technical or Customer Support

You can reach Analog Devices, Inc. Customer Support in the following ways:

- Visit the Embedded Processing and DSP products Web site at:
http://www.analog.com/processors/technical_support
- E-mail tools questions to:
processor.tools.support@analog.com
- E-mail processor questions to:
processor.support@analog.com (World wide support)
processor.europe@analog.com (Europe support)
processor.china@analog.com (China support)
- Phone questions to 1-800-ANALOGD
- Contact your Analog Devices, Inc. local sales office or authorized distributor

Product Information

Product information can be obtained from the Analog Devices Web site and the VisualDSP++® online Help system.

Analog Devices Web Site

The Analog Devices Web site, www.analog.com, provides information about a broad range of products—analog integrated circuits, amplifiers, converters, and digital signal processors.

To access a complete technical library for each processor series, go to http://www.analog.com/processors/technical_library. The manuals selection opens a list of current manuals related to the product as well as a

Product Information

link to the previous revisions of the manuals. When locating your manual title, note a possible errata check mark next to the title that leads to the current correction report against the manual.

Also note, MyAnalog.com is a free feature of the Analog Devices Web site that allows customization of a Web page to display only the latest information about products you are interested in. You can choose to receive weekly e-mail notifications containing updates to the Web pages that meet your interests, including documentation errata against all manuals. MyAnalog.com provides access to books, application notes, data sheets, code examples, and more.

Visit MyAnalog.com to sign up. If you are a registered user, just log on. Your user name is your e-mail address.

VisualDSP++ Online Documentation

Online documentation comprises the VisualDSP++ Help system, software tools manuals, hardware tools manuals, processor manuals, Dinkum Abridged C++ library, and FLEXnet License Tools software documentation. You can search easily across the entire VisualDSP++ documentation set for any topic of interest.

For easy printing, supplementary Portable Documentation Format (.pdf) files for all manuals are provided on the VisualDSP++ installation CD.

Each documentation file type is described as follows.

File	Description
.chm	Help system files and manuals in Microsoft help format
.htm or .html	Dinkum Abridged C++ library and FLEXnet License Tools software documentation. Viewing and printing the .html files requires a browser, such as Internet Explorer 6.0 (or higher).
.pdf	VisualDSP++ and processor manuals in PDF format. Viewing and printing the .pdf files requires a PDF reader, such as Adobe Acrobat Reader (4.0 or higher).

EngineerZone

EngineerZone is a technical support forum from Analog Devices. It allows you direct access to ADI technical support engineers. You can search FAQs and technical information to get quick answers to your embedded processing and DSP design questions.

Use EngineerZone to connect with other DSP developers who face similar design challenges. You can also use this open forum to share knowledge and collaborate with the ADI support team and your peers. Visit <http://ez.analog.com> to sign up.

Social Networking Web Sites

You can now follow Analog Devices processor development on Twitter and LinkedIn. To access:

- Twitter: <http://twitter.com/blackfin>
- LinkedIn: Network with the LinkedIn group Analog Devices Blackfin: <http://www.linkedin.com>

1 INTRODUCTION

This chapter briefly describes the Blackfin processor’s architecture and key features and compares available models.

Topics include:

- [“What are Blackfin Processors?”](#) on page 1-1
- [“Blackfin Processor Features”](#) on page 1-27
- [“Benchmarks Against Other Processors”](#) on page 1-30

What are Blackfin Processors?

Blackfin processors from Analog Devices embody a new breed of 16/32-bit embedded processor. They have the industry’s highest performance and power efficiency for applications where a convergence of capabilities—multi-format audio, video, voice and image processing; multi-mode baseband and packet processing; and real-time security and control processing—are critical.

Blackfin processors deliver breakthrough signal processing performance and power efficiency with a RISC programming model. Blackfin processors present high-performance, homogeneous software targets, which allow flexible resource allocation between hard real-time processor tasks and non real-time control tasks. System control tasks can often run in the shadow of processor and video tasks.

What are Blackfin Processors?

Blackfin processors combine a 32-bit RISC instruction set, dual 16-bit multiply/accumulate (MAC) digital signal processing functionality, and 8-bit video processing performance that had previously been the exclusive domain of very long instruction word (VLIW) media processors.

Blackfin processors include advanced memory management that supports memory-protected and non memory-protected embedded operating systems such as μ Clinux™, ThreadX® (Express Logic), INTEGRITY®, velOSity™, Nucleus® (Mentor Graphics), Fusion™ (Unicoi Systems), and RTX C Quadros™ (Quadros Systems).

Combining RISC MCU and Signal Processor Functionality

Blackfin processors provide microcontroller (MCU) and signal processing functionality in a unified architecture, allowing flexible partitioning between the needs of control and signal processing. If the application demands, the Blackfin processor can act as 100% MCU (with code density on par with industry standards), 100% signal processor (with clock rates at the leading edge of signal processor technology), or a combination of the two.

The Blackfin family of processors from Analog Devices integrates a 32-bit RISC instruction set with an 8-bit video instruction set with dual 16-bit MAC units. The processor's variable-length instruction set extends up to 64-bit opcodes used in processor inner loops (one single instruction, multiple data [SIMD] and two load/store/cycle), but is optimized so that 16-bit opcodes represent the most frequently used instructions. As a result, compiled code density figures are competitive with industry-leading MCUs, yet its interlocked pipeline and algebraic instruction syntax facilitate development in both C/C++ and assembly.

[Figure 1-1](#) shows a block diagram of a single-core ADSP-BF549 Blackfin 16/32-bit processor.

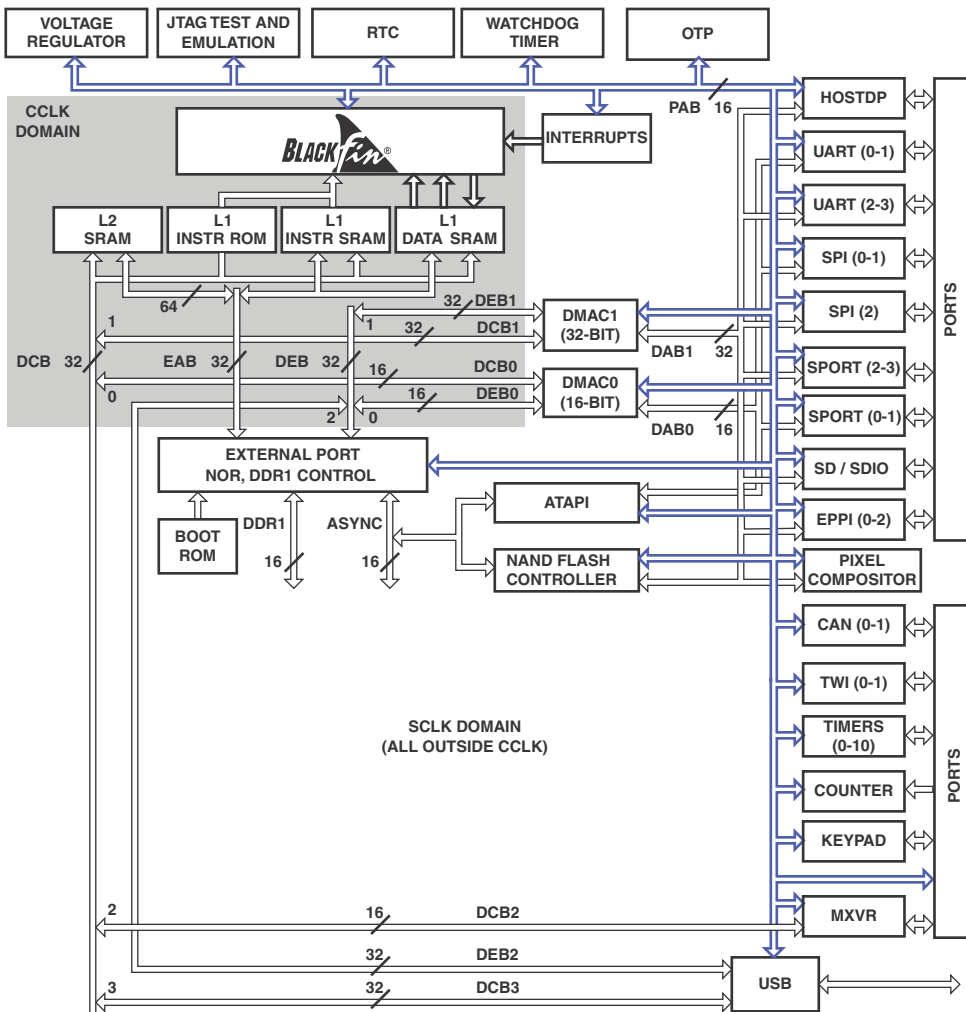

Figure 1-1. Single-Core ADSP-BF549 Blackfin 16/32-Bit Processor

Blackfin processors support both protected and unprotected operating modes that prevent users from accessing or affecting shared parts of the system. In addition, the processors provide memory management

What are Blackfin Processors?

capabilities that enable users to define separate application development spaces. This design feature prevents distinct code sections from being overwritten. At the same time, the Blackfin processor's architecture allows asynchronous interrupts and synchronous exceptions, as well as programmable interrupt priorities. Thus, Blackfin processors are well suited as targets for embedded operating systems.

Approaches to Application Development

Blackfin processors have a peripheral set that supports high-speed serial and parallel data movement. In addition, Blackfin processors include an advanced power management feature set that allows system architects to craft designs with low dynamic power profiles.

In today's design model, MCU (microcomputer unit) and traditional processor programmers often partition their code development into two separate groups, interacting only at the system boundary level where their two functional worlds meet. This makes some sense, as two separate groups of designers can develop their own sets of design practices based on application requirements. For instance, signal processing developers may want to implement techniques to improve performance. Another group may have opposing design goals; MCU programmers, for example, may prefer implementing a turnkey system and letting it perform all tasks without user intervention.

With this in mind, Blackfin processors were designed to support both DMA and cache memory controllers to move data through a system. Multiple high-speed DMA channels shuttle data between peripherals and memory systems, allowing the fine-tuning controls sought by processor programmers without using up valuable core processor cycles. Conversely, on-chip configurable instruction and data caches allow a hands-off approach to managing code and data in a manner very familiar to MCU programmers. Often, at the system integration level, a combination of both approaches is ideal.

Another reason for the historical separation of MCU and processor development groups is that the two processors have two separate sets of design imperatives. From a technical standpoint, engineers responsible for architecting a system often hesitate to mix a “control” application with a “signal processing” application on the same processor. Their most common fear is that non real-time tasks interfere with real-time tasks. For instance, programmers who handle tasks such as the graphical user interface (GUI) or the networking stack should not have to worry about hampering the system’s “real-time” signal processing activities. Of course, the definition of real time varies based on the specific application. In an embedded application, the focus is on the time required to service an interrupt. For this purpose, assume there is a time frame of less than 1 microsecond between an interrupt and the time that the system context is saved at the start of the service routine.

With the introduction of the Blackfin processors, a C/C++-centric unified code base can be realized. This enables developers to leverage enormous amounts of existing application code developed from previous efforts. Because Blackfin processors are optimized for both control and signal processing operations, compilers can generate code that is both tight (from a code density standpoint) and efficient (for computationally-intensive signal processing applications). Of course for veteran programmers, targeted assembly coding is still an option for optimizing critical processing loops.

Operating system (OS) support is also key. Several layers of tasking can be realized by supporting an operating system or real-time kernel. An interrupt controller that supports multiple priority levels is needed to ensure that targeted performance is still achievable. Context switching must be attainable through hardware-based stack and frame pointer support. This enables developers to create systems that include both worlds—control and real-time signal processing—on the same device.

In addition, the Blackfin processor’s memory protection facility permits OS support for memory protection. This allows one task, via a paging mechanism, to block memory or instruction accesses by another task.

What are Blackfin Processors?

An exception is generated whenever unauthorized access is made to a protected area of memory. The kernel services this exception and takes appropriate action.

The high processing speeds achieved by Blackfin processors translate into several tangible benefits. The first is time to market. There can be considerable savings in reducing or bypassing the code optimization effort when there is plenty of processing capacity to spare. A second benefit is reduced software maintenance, which can otherwise dominate a product's life cycle cost. Finally, for scalable Blackfin architectures, designers can base their work around the most capable member of the Blackfin processor family, and can use a cost-optimized processor.

Dual-Core Processors Add Flexibility

Blackfin processors are also available as dual-core devices. The traditional use of a dual-core processor employs discrete and often different tasks that run on each of the cores. For example, one core might perform all of the control-related tasks, such as graphics and overlay functionality, networking, interfacing to bulk storage, and overall flow control. This core is also where the operating system or kernel most likely resides. Meanwhile, the second core is dedicated to the application's high intensity processing functions. For example, compressed data packets might be transferred over a network interface to the first core for preprocessing, and then passed to the second core for audio and video decoding. [Figure 1-2](#) shows a block diagram of a typical dual-core processor.

The use of a dual-core processor is preferred for designs built by separate software development teams. The ability to segment these types of functions allows a parallel design process, eliminating critical path dependencies in the project. This programming model also aids the testing and validation phases of the project. For example, a code change on one core does not necessarily invalidate the testing efforts already completed on the other core.

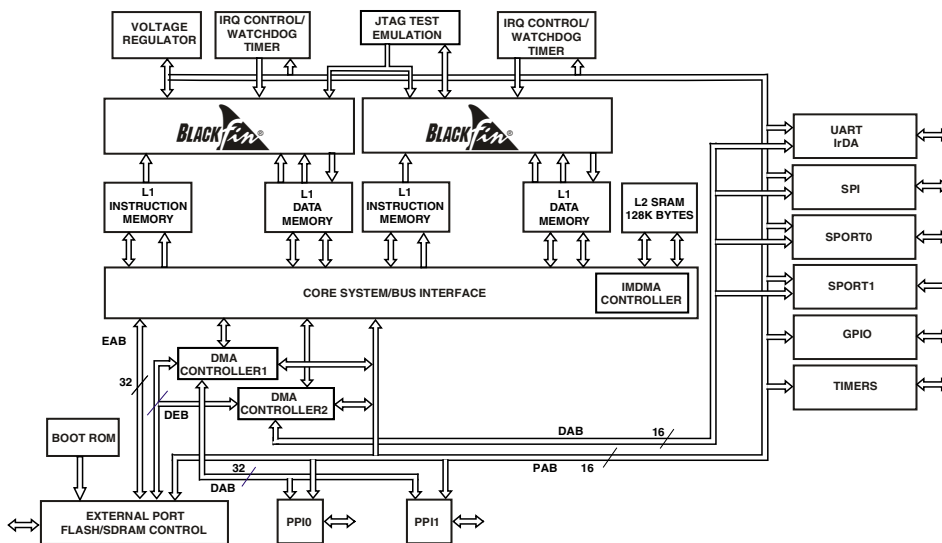

Figure 1-2. Functional Block Diagram

The Blackfin Family of Processors

New high-performance Blackfin processors are available now, while plans for additional Blackfin processors are designed to offer feature-packed, future-ready architectures for media-rich applications.

Blackfin Processors (Currently Available)

The ADSP-BF535 was the first released Blackfin processor, followed in March 2003 by three pin-compatible devices, the ADSP-BF531, ADSP-BF532, and ADSP-BF533 Blackfin processors. These three devices offer a range of memory and speed options, providing maximum scalability and design flexibility with standard serial interfaces such as SPI, UART, and a flexible programmable serial ports (SPORTs). The devices also offer 16-bit parallel peripheral interfaces (PPI) to connect gluelessly to high-speed converters and imaging components.

What are Blackfin Processors?

In January of 2005, Analog Devices introduced three Blackfin processors with embedded connectivity: the ADSP-BF536, ADSP-BF537, and ADSP-BF534. These three devices are also pin-compatible with each other and include a controller area network (CAN) and a two-wire interface (TWI), and on some models, a 10/100 ethernet MAC.

In May of 2006, Analog Devices introduced the ADSP-BF538 Blackfin processors, which added the complement of on-board flash memory and also more instances of the communications peripherals for enhanced connectivity.

In November of 2006, Analog Devices introduced five new Blackfin processors: ADSP-BF542, ADSP-BF544, ADSP-BF547, ADSP-BF548, and ADSP-BF549. These ADSP-BF54x processors focus on higher system performance for convergent applications through increased (2x) I/O bandwidth, increased on-chip memory, and a rich peripherals set including high-speed USB, ATAPI, NAND flash, DDR1, and LockBox™ secure technology. The PPI was also enhanced to support more high-speed parallel devices; up to three PPIs are available on some models.

In March of 2007, Analog Devices introduced ADSP-BF52x Blackfin processors, which focus on the next generation of mobile devices. The ADSP-BF52x series is pin-compatible and is comprised of the ADSP-BF522, ADSP-BF523, ADSP-BF524, ADSP-BF525, ADSP-BF526, and ADSP-BF527 processors. This series concentrates on connectivity, including combinations of high-speed USB, 10/100 ethernet, NAND flash controller, an audio codec, and so on. The ADSP-BF52x processors offer lower dynamic and static power consumption over previous Blackfin processors.

In November of 2008, Analog Devices introduced the ADSP-BF51x processors. The ADSP-BF512, ADSP-BF514, ADSP-BF516, and ADSP-BF518 processors extend the Blackfin family further into the industrial and instrumentation market with the availability of an on-chip eMAC which supports 1588 version 2, a 3-phase PWM generation unit, and a quadrature encoder.

In January of 2010, Analog Devices unveiled the latest entries in its Blackfin family of processors: the Blackfin ADSP-BF50x Blackfin series.

Delivering up to 100% greater performance than competing processors in its price class, single-core ADSP-BF50x series processors enable designers to achieve significant gains in signal conversion and computational precision, and apply advanced power control techniques to yield greater energy efficiency for industrial applications.

In September of 2010, Analog Devices introduced the ADSP-BF592 processor, the lowest priced member of its successful portfolio of Blackfin processors. With 800 MMACs/400 MHz of performance for just \$3 (in 10K quantities), the ADSP-BF592 makes high performance DSP now practical for many more applications in the industrial, medical, video, audio, and general-purpose markets. In addition, the ADSP-BF592 low power requirements and the small size (9 mm x 9 mm) enable designers to include high-performance signal processing in power-constrained and small form-factor applications.

All Blackfin processors mentioned above are single-core processors.

Analog Devices also developed a dual-core symmetric multiprocessor, the ADSP-BF561 Blackfin processor. This processor uses a dual-core processor and increases performance without switching processor architectures. In fact, by running both processor cores at lower frequencies and lower voltages, power consumption is lowered. The advantages of this technique are described in [“Dual-Core Processors Add Flexibility” on page 1-6](#). In addition, the ADSP-BF561 processor offers a second PPI, making video in/out possible simultaneously.

What are Blackfin Processors?

Each Blackfin processor provides unique capabilities, while being pin-compatible with other Blackfin devices. [Table 1-1](#) lists key Blackfin processor specifications.



All processors noted as “RoHS Compliant” are also lead free.

Also, unless they differ from processor to processor, the key peripherals are listed in the row designating the Blackfin series in bold typeface (such as **ADSP-BF522**).

The list of supported Blackfin processors is subject to change. For a complete and up-to-date listing of Blackfin processors, refer to:

<http://www.analog.com/blackfin>

Table 1-1. Summary of Blackfin Processor Specifications

Blackfin Family Matrix	Package	Clock Speed MHZ Max	Temp Range Ambient	RoHS Compliant	Key Peripherals ¹
ADSP-BF592 Peripherals: 1 UART, 2 SPORT, 2SPI, TWI PPI/LCD, ROM Libraries					
ADSP-BF592KCPZ	64-Lead LFCSP	400	0°C to +70°C	x	
ADSP-BF592BCPZ	64-Lead LFCSP	400	-40°C to +85°C	x	
ADSP-BF50x Peripherals: SPI, PPI, SPORT, UART, PWM, ADC Control Module					
ADSP-BF504BCPZ-3F	88-Lead LFCSP	300	-40°C to +85°C	x	4MB parallel flash
ADSP-BF504BCPZ-4	88-Lead LFCSP	400	-40°C to +85°C	x	

Table 1-1. Summary of Blackfin Processor Specifications (Cont'd)

Blackfin Family Matrix	Package	Clock Speed MHZ Max	Temp Range Ambient	RoHS Comp- liant	Key Peripherals ¹
ADSP-BF504BCPZ-4F	88-Lead LFCSP	400	-40°C to +85°C	x	4MB parallel flash
ADSP-BF504KCPZ-3F	88-Lead LFCSP	300	0°C to +70°C	x	4MB parallel flash
ADSP-BF504KCPZ-4	88-Lead LFCSP	400	0°C to +70°C	x	
ADSP-BF504KCPZ-4F	88-Lead LFCSP	400	0°C to +70°C	x	4MB parallel flash
ADSP-BF506BSWZ-3F	88-Lead LFCSP	300	-40°C to +85°C	x	4MB parallel flash, 12 bit ADC
ADSP-BF506BSWZ-4F	88-Lead LFCSP	400	-40°C to +85°C	x	4MB parallel flash, 12 bit ADC
ADSP-BF506KSWZ-3F	88-Lead LFCSP	300	0°C to +70°C	x	4MB parallel flash, 12 bit ADC
ADSP-BF506KSWZ-4F	88-Lead LFCSP	400	0°C to +70°C	x	4MB parallel flash, 12 bit ADC
ADSP-BF51x Peripherals: SPORT, SPI, PPI, TWI UART					
ADSP-BF512BSWZ-3	176-Lead LQFP_EP	300	-40°C to +85°	x	
ADSP-BF512BSWZ-4	176-Lead LQFP_P	400	-40°C to +85°	x	
ADSP-BF512BSWZ-4F4	176-Lead LQFP_EP	400	-40°C to +8°C	x	SPI Flash

What are Blackfin Processors?

Table 1-1. Summary of Blackfin Processor Specifications (Cont'd)

Blackfin Family Matrix	Package	Clock Speed MHZ Max	Temp Range Ambient	RoHS Comp- liant	Key Peripherals ¹
ADSP-BF512KBCZ-3	168-Ball CSP_BGA	300	0°C to +70°C	x	
ADSP-BF512KBCZ-4	168-Ball CSP_BGA	400	0°C to +70°C	x	
ADSP-BF512KBCZ-4F	168-Ball CSP_BGA	400	0°C to +70°C	x	SPI Flash
ADSP-BF512KSWZ-3	176-Lead LQFP_EP	300	0°C to +70°C	x	
ADSP-BF512KSWZ-4	176-Lead LQFP_P	400	0°C to +70°C	x	
ADSP-BF512KSWZ-4F4	176-Lead LQFP_EP	400	0°C to +70°C	x	SPI Flash
ADSP-BF514BSWZ-3	176-Lead LQFP_EP	300	-40°C to +85°	x	SDIO, CE-ATA, eMMC
ADSP-BF514BSWZ-4	176-Lead LQFP_EP	400	-40°C to +8°C	x	SDIO, CE-ATA, eMMC
ADSP-BF514BSWZ-4F4	176-Lead LQFP_EP	400	-40°C to +85°C	x	SDIO, CE-ATA, eMMC SPI Flash
ADSP-BF514KBCZ-3	168-Ball CSP_BGA	300	0°C to +70°C	x	SDIO, CE-ATA, eMMC
ADSP-BF514KBCZ-4	168-Ball CSP_BGA	400	0°C to +70°C	x	SDIO, CE-ATA, eMMC
ADSP-BF514KBCZ-4F4	168-Ball CSP_BGA	400	0°C to +70°C	x	SDIO, CE-ATA, eMMC, SPI Flash

Table 1-1. Summary of Blackfin Processor Specifications (Cont'd)

Blackfin Family Matrix	Package	Clock Speed MHZ Max	Temp Range Ambient	RoHS Compliant	Key Peripherals ¹
ADSP-BF514KSWZ-3	176-Lead LQFP_EP	300	0°C to +70°C	x	SDIO, CE-ATA, eMMC
ADSP-BF514KSWZ-4	176-Lead LQFP_EP	400	0°C to +70°C	x	SDIO, CE-ATA, eMMC
ADSP-BF514KSWZ-4F4	176-Lead LQFP_EP	400	0°C to +70°C	x	SDIO, CE-ATA, eMMC SPI Flash
ADSP-BF516BSWZ-3	176-Lead LQFP_EP	300	-40°C to +8°C	x	10/100 Ethernet, SDIO, CE-ATA, eMMC
ADSP-BF516BSWZ-4	176-Lead LQFP_EP	400	-40°C to +85°	x	10/100 Ethernet, SDIO, CE-ATA, eMMC
ADSP-BF516BSWZ-4F4	176-Lead LQFP_EP	400	-40°C to +85°C	x	10/100 Ethernet, SDIO, CE-ATA, eMMC, SPI Flash
ADSP-BF516KBCZ-3	168-Ball CSP_BGA	300	0°C to +70°C	x	10/100 Ethernet, SDIO, CE-ATA, eMMC
ADSP-BF516KBCZ-4	168-Ball CSP_BGA	400	0°C to +70°C	x	10/100 Ethernet, SDIO, CE-ATA, eMMC
ADSP-BF516KBCZ-4F4	168-Ball CSP_BGA	400	0°C to +70°C	x	10/100 Ethernet, SDIO, CE-ATA, eMMC, SPI Flash

What are Blackfin Processors?

Table 1-1. Summary of Blackfin Processor Specifications (Cont'd)

Blackfin Family Matrix	Package	Clock Speed MHZ Max	Temp Range Ambient	RoHS Comp- liant	Key Peripherals ¹
ADSP-BF516KSWZ-3	176-Lead LQFP_EP	300	0°C to +70°C	x	10/100 Ethernet, SDIO, CE-ATA, eMMC
ADSP-BF516KSWZ-4	176-Lead LQFP_EP	400	0°C to +70°C	x	10/100 Ethernet, SDIO, CE-ATA, eMMC
ADSP-BF516KSWZ-4F4	176-Lead LQFP_EP	400	0°C to +70°C	x	10/100 Ethernet, SDIO, CE-ATA, eMMC, SPI Flash
ADSP-BF518BSWZ-3	176-Lead LQFP_EP	300	-40°C to +85°	x	10/100 Ethernet with 1588, SDIO, CE-ATA, eMMC
ADSP-BF518BSWZ-4	176-Lead LQFP_EP	400	-40°C to +85°	x	10/100 Ethernet with 1588, SDIO, CE-ATA, eMMC
ADSP-BF518BSWZ-4F4	176-Lead LQFP_EP	400	-40°C to +8°C	x	10/100 Ethernet with 1588, SDIO, CE-ATA, eMMC, SPI flash
ADSP-BF518KBCZ-3	168-Ball CSP_BGA	300	0°C to +70°C	x	10/100 Ethernet with 1588, SDIO, CE-ATA, eMMC
ADSP-BF518KBCZ-4	168-Ball CSP_BGA	400	0°C to +70°C	x	10/100 Ethernet with 1588, SDIO, CE-ATA, eMMC

Table 1-1. Summary of Blackfin Processor Specifications (Cont'd)

Blackfin Family Matrix	Package	Clock Speed MHZ Max	Temp Range Ambient	RoHS Comp- liant	Key Peripherals ¹
ADSP-BF518KBCZ-4F4	168-Ball CSP_BGA	400	0°C to +70°C	x	10/100 Ethernet with 1588, SDIO, CE-ATA, eMMC, SPI flash
ADSP-BF518KSWZ-3	176-Lead LQFP_EP	300	-40°C to +85°	x	10/100 Ethernet with 1588, SDIO, CE-ATA, eMMC
ADSP-BF518KSWZ-4	176-Lead LQFP_EP	400	-40°C to +85°	x	10/100 Ethernet with 1588, SDIO, CE-ATA, eMMC
ADSP-BF518KSWZ-4F4	176-Lead LQFP_ED	400	0°C to +70°C	x	10/100 Ethernet with 1588, SDIO, CE-ATA, eMMC, SPI flash
ADSP-BF522 Peripherals: PPI, SPI, SPORTs, NAND Interface, TWI, Host DMA, UART, Lockbox					
ADSP-BF522BBCZ-3A	208-CSP_BGA	300	-40°C to +85°C	x	
ADSP-BF522BBCZ-4A	208-CSP_BGA	400	-40°C to +85°C	x	
ADSP-BF522KBCZ-3	289-CSP_BGA	300	0°C to +70°C	x	
ADSP-BF522KBCZ-3C2	289-CSP_BGA	300	0°C to +70°C	x	

What are Blackfin Processors?

Table 1-1. Summary of Blackfin Processor Specifications (Cont'd)

Blackfin Family Matrix	Package	Clock Speed MHZ Max	Temp Range Ambient	RoHS Compliant	Key Peripherals ¹
ADSP-BF522KBCZ-4	289-CSP_BGA	400	0°C to +70°C	x	
ADSP-BF522KBCZ-4C2	289-CSP_BGA	400	0°C to +70°C	x	
ADSP-BF523 Peripherals: PPI, SPI, SPORTs, NAND Interface, TWI, Host DMA, UART, Lockbox					
ADSP-BF523BBCZ-5A	208-CSP_BGA	533	-40°C to +85°C	x	
ADSP-BF523KBCZ-5	289-CSP_BGA	533	0°C to +70°C	x	
ADSP-BF523KBCZ-5C2	289-CSP_BGA	533	0°C to +70°C	x	
ADSP-BF523KBCZ-6	289-CSP_BGA	600	0°C to +70°C	x	
ADSP-BF523KBCZ-6A	208-CSP_BGA	600	0°C to +70°C	x	
ADSP-BF523KBCZ-6C2	289-CSP_BGA	600	0°C to +70°C	x	
ADSP-BF524 Peripherals: PPI, SPI, SPORTs, NAND Interface, TWI, Host DMA, UART, Lockbox, HS USB OTG					
ADSP-BF524BBCZ-3A	208-CSP_BGA	300	-40°C to +85°C	x	
ADSP-BF524BBCZ-4A	208-CSP_BGA	400	-40°C to +85°C	x	

Table 1-1. Summary of Blackfin Processor Specifications (Cont'd)

Blackfin Family Matrix	Package	Clock Speed MHZ Max	Temp Range Ambient	RoHS Comp- liant	Key Peripherals ¹
ADSP-BF524KBCZ-3	289-CSP_BGA	300	0°C to +70°C	x	
ADSP-BF524KBCZ-3C2	289-CSP_BGA	300	0°C to +70°C	x	
ADSP-BF524KBCZ-4	289-CSP_BGA	400	0°C to +70°C	x	
ADSP-BF524KBCZ-4C2	289-CSP_BGA	400	0°C to +70°C	x	
ADSP-BF525 Peripherals: PPI, SPI, SPORTs, NAND Interface, TWI, Host DMA, UART, Lockbox, HS USB OTG					
ADSP-BF525BBCZ-5A	208-CSP_BGA	533	-40°C to +85°C	x	
ADSP-BF525KBCZ-5	289-CSP_BGA	533	0°C to +70°C	x	
ADSP-BF525KBCZ-5C2	289-CSP_BGA	533	0°C to +70°C	x	
ADSP-BF525KBCZ-6	289-CSP_BGA	600	0°C to +70°C	x	
ADSP-BF525KBCZ-6A	208-CSP_BGA	600	0°C to +70°C	x	
ADSP-BF525KBCZ-6C2	289-CSP_BGA	600	0°C to +70°C	x	

What are Blackfin Processors?

Table 1-1. Summary of Blackfin Processor Specifications (Cont'd)

Blackfin Family Matrix	Package	Clock Speed MHZ Max	Temp Range Ambient	RoHS Compliant	Key Peripherals ¹
ADSP-BF526 Peripherals: PPI, SPI, SPORTs, 10/100 Ethernet, TWI, Host DMA, NAND Interface, UART, Lock-box, HS USB OTG					
ADSP-BF526BBCZ-3A	208-CSP_BGA	300	-40°C to +85°C	x	
ADSP-BF526BBCZ-4A	208-CSP_BGA	400	-40°C to +85°C	x	
ADSP-BF526KBCZ-3	289-CSP_BGA	300	0°C to +70°C	x	
ADSP-BF526KBCZ-3C2	289-CSP_BGA	300	0°C to +70°C	x	
ADSP-BF526KBCZ-4	289-CSP_BGA	300	0°C to +70°C	x	
ADSP-BF526KBCZ-4C2	289-CSP_BGA	400	0°C to +70°C	x	
ADSP-BF527 Peripherals: PPI, SPI, SPORTs, 10/100 Ethernet, TWI, Host DMA, NAND Interface, UART, Lock-box, HS USB OTG					
ADSP-BF527BBCZ-5A	208-CSP_BGA	533	-40°C to +85°C	x	
ADSP-BF527KBCZ-5	289-CSP_BGA	533	0°C to +70°C	x	
ADSP-BF527KBCZ-5C2	289-CSP_BGA	533	0°C to +70°C	x	

Table 1-1. Summary of Blackfin Processor Specifications (Cont'd)

Blackfin Family Matrix	Package	Clock Speed MHZ Max	Temp Range Ambient	RoHS Comp- liant	Key Peripherals ¹
ADSP-BF527KBCZ-6	289-CSP_BGA	600	0°C to +70°C	x	
ADSP-BF527KBCZ-6A	208-CSP_BGA	600	0°C to +70°C	x	
ADSP-BF527KBCZ-6C2	289-CSP_BGA	600	0°C to +70°C	x	
ADSP-BF531 Peripherals: PPI, UART, SPI, 2 SPORTs, 3 timers, 16 GPIOs					
ADSP-BF531SBB400	169-PBGA	400	-40°C to +85°C		
ADSP-BF531SBBC400	160-CSP_BGA	400	-40°C to +85°C		
ADSP-BF531SBBCZ400	160-CSP_BGA	400	-40°C to +85°C	x	
ADSP-BF531SBBZ400	169-PBGA	400	-40°C to +85°C	x	
ADSP-BF531SBSTZ400	176-LQFP	400	-40°C to +85°C	x	
ADSP-BF532 Peripherals: PPI, UART, SPI, 2 SPORTs, 3 timers, 16 GPIOs					
ADSP-BF532SBB400	169-PBGA	400	-40°C to +85°C		
ADSP-BF532SBBC400	160-CSP_BGA	400	-40°C to +85°C		

What are Blackfin Processors?

Table 1-1. Summary of Blackfin Processor Specifications (Cont'd)

Blackfin Family Matrix	Package	Clock Speed MHZ Max	Temp Range Ambient	RoHS Compliant	Key Peripherals ¹
ADSP-BF532SBBCZ400	160-CSP_BGA	400	-40°C to +85°C	x	
ADSP-BF532SBBZ400	169-PBGA	400	-40°C to +85°C	x	
ADSP-BF532SBSTZ400	176-LQFP	400	-40°C to +85°C	x	
ADSP-BF533 Peripherals: PPI, UART, SPI, 2 SPORTs, 3 timers, 16 GPIOs					
ADSP-BF533SBB500	160-CSP_BGA	500	-40°C to +85°C		
ADSP-BF533SBBC-5V	160-CSP_BGA	533	-40°C to +85°C		
ADSP-BF533SBBC400	160-CSP_BGA	400	-40°C to +85°C		
ADSP-BF533SBBC500	160-CSP_BGA	500	-40°C to +85°C		
ADSP-BF533SBBCZ-5V	160-CSP_BGA	533	-40°C to +85°C	x	
ADSP-BF533SBBCZ400	160-CSP_BGA	400	-40°C to +85°C	x	
ADSP-BF533SBBCZ500	160-CSP_BGA	500	-40°C to +85°C	x	
ADSP-BF533SBBZ400	169-PBGA	400	-40°C to +85°C	x	

Table 1-1. Summary of Blackfin Processor Specifications (Cont'd)

Blackfin Family Matrix	Package	Clock Speed MHZ Max	Temp Range Ambient	RoHS Comp- liant	Key Peripherals ¹
ADSP-BF533SBBZ500	169-PBGA	500	-40°C to +85°C	x	
ADSP-BF533SBSTZ400	176-PBGA	400	-40°C to +85°C	x	
ADSP-BF533SKBC-6V	160-CSP_BGA	600	0°C to +70°C		
ADSP-BF533SKBCZ-6V	160-CSP_BGA	600	0°C to +70°C	x	
ADSP-BF534 Peripherals: CAN, PPI/SPI, TWI, 8 timers, 48 GPIOs, 2 SPORTs/UARTs					
ADSP-BF534BBC-4A	182-CSP_BGA	400	-40°C to +85°C		
ADSP-BF534BBCZ-4A	182-CSP_BGA	400	-40°C to +85°C	x	
ADSP-BF534BBCZ-4B	208-CSP_BGA	400	-40°C to +85°C	x	
ADSP-BF534BBC-5A	182-CSP_BGA	500	-40°C to +85°C		
ADSP-BF534BBCZ-5A	182-CSP_BGA	500	-40°C to +85°C	x	
ADSP-BF534BBCZ-5B	208-CSP_BGA	500	-40°C to +85°C	x	
ADSP-BF534YBCZ-4B	208-CSP_BGA	400	-40°C to +105°C	x	

What are Blackfin Processors?

Table 1-1. Summary of Blackfin Processor Specifications (Cont'd)

Blackfin Family Matrix	Package	Clock Speed MHZ Max	Temp Range Ambient	RoHS Comp- liant	Key Peripherals ¹
ADSP-BF535 Peripherals: 2 SPIs, 2 SPORTs, USB device, PCI					
ADSP-BF535PBB-200	260-PBGA	200	-40°C to +85°C		
ADSP-BF535PBB-300	260-PBGA	300	-40°C to +85°C		
ADSP-BF535PBBZ-200	260-PBGA	200	-40°C to +85°C	x	
ADSP-BF535PKB-300	260-PBGA	300	0°C to +70°C		
ADSP-BF535PKB-350	260-PBGA	350	0°C to +70°C		
ADSP-BF535PKBZ-300	260-PBGA	300	0°C to +70°C	x	
ADSP-BF535PKBZ-350	260-PBGA	350	0°C to +70°C	x	
ADSP-BF536 Peripherals: 10/100 Ethernet, CAN, PPI, TWI, 8 timers, 48 GPIOs, 2 SPORTs/UARTs, SPI					
ADSP-BF536BBC-3A	182-CSP_BGA	300	-40°C to +85°C		
ADSP-BF536BBC-4A	182-CSP_BGA	400	-40°C to +85°C		
ADSP-BF536BBCZ-3A	182-CSP_BGA	300	-40°C to +85°C	x	

Table 1-1. Summary of Blackfin Processor Specifications (Cont'd)

Blackfin Family Matrix	Package	Clock Speed MHZ Max	Temp Range Ambient	RoHS Comp- liant	Key Peripherals ¹
ADSP-BF536BBCZ-3B	208-CSP_BGA	300	-40°C to +85°C	x	
ADSP-BF536BBCZ-4A	182-CSP_BGA	400	-40°C to +85°C	x	
ADSP-BF536BBCZ-4B	208-CSP_BGA	400	-40°C to +85°C	x	
ADSP-BF537 Peripherals: 10/100 Ethernet, CAN, PPI, TWI, 8 timers, 48 GPIOs, 2 SPORTs/UARTs, SPI					
ADSP-BF537BBC-5A	182-CSP_BGA	500	-40°C to +85°C		
ADSP-BF537BBCZ-5A	182-CSP_BGA	500	-40°C to +85°C	x	
ADSP-BF537BBCZ-5AV	182-CSP_BGA	533	-40°C to +85°C	x	
ADSP-BF537BBCZ-5B	208-CSP_BGA	500	-40°C to +85°C	x	
ADSP-BF537BBCZ-5BV	208-CSP_BGA	533	-40°C to +85°C	x	
ADSP-BF537KBCZ-6AV	182-CSP_BGA	600	-0°C to +70°C	x	
ADSP-BF537KBCZ-6BV	208-CSP_BGA	600	-0°C to +70°C	x	

What are Blackfin Processors?

Table 1-1. Summary of Blackfin Processor Specifications (Cont'd)

Blackfin Family Matrix	Package	Clock Speed MHZ Max	Temp Range Ambient	RoHS Comp- liant	Key Peripherals ¹
ADSP-BF538 Peripherals: CAN 2.0B, 54 GPIOs, 4 SPORTs, 3 UARTs, 3 SPIs, 2 TWIs, PPI, flash					
ADSP-BF538BBCZ-4A	316-CSP_BGA	400	-40°C to +85°C	x	
ADSP-BF538BBCZ-4F8	316-CSP_BGA	400	-40°C to +85°C	x	
ADSP-BF538BBCZ-5A	316-CSP_BGA	533	-40°C to +85°C	x	
ADSP-BF538BBCZ-5F8	316-CSP_BGA	533	-40°C to +85°C	x	
ADSP-BF539 Peripherals: MXVR, CAN, 54 GPIOs, 4 SPORTs, 3 UARTs, 3 SPIs, 2 TWIs, PPI, flash					
ADSP-BF539BBCZ-5A	316-CSP_BGA	533	-40°C to +85°C	x	
ADSP-BF539BBCZ-5F8	316-CSP_BGA	533	-40°C to +85°C	x	
ADSP-BF542 Peripherals: CAN, 4 HS USB OTG, 3 EPPIs, Pixel comp, ATAPI-6, Lockbox					
ADSP-BF542BBCZ-5A	400-CSP_BGA	533	-40°C to +85°C	x	
ADSP-BF542KBCZ-6A	400-CSP_BGA	600	0°C to +70°C	x	
ADSP-BF542MBBCZ-5M	400-CSP_BGA	533	-40°C to +85°C	x	

Table 1-1. Summary of Blackfin Processor Specifications (Cont'd)

Blackfin Family Matrix	Package	Clock Speed MHZ Max	Temp Range Ambient	RoHS Comp- liant	Key Peripherals ¹
ADSP-BF544 Peripherals: CAN, 4 Host DMA, 3 EPPIs, Pixel comp, Lockbox					
ADSP-BF544BBCZ-5A	400-CSP_BGA	533	-40°C to +85°C	x	
ADSP-BF544MBBCZ-5M	400-CSP_BGA	533	-40°C to +85°C	x	
ADSP-BF547 Peripherals: HS USB OTC, 3 EPPIs, Pixel comp, ATAPI-6, Lockbox					
ADSP-BF547BBCZ-5A	400-CSP_BGA	533	-40°C to +85°C	x	
ADSP-BF547KBCZ-6A	400-CSP_BGA	600	0°C to +70°C	x	
ADSP-BF547MBBCZ-5M	400-CSP_BGA	533	-40°C to +85°C	x	
ADSP-BF548 Peripherals: HS USB OTG, 3 EPPIs, Pixel comp, ATAPI-6, Lockbox, CAN					
ADSP-BF548BBCZ-5A	400-CSP_BGA	533	-40°C to +85°C	x	
ADSP-BF548MBBCZ-5M	400-CSP_BGA	533	-40°C to +85°C	x	

What are Blackfin Processors?

Table 1-1. Summary of Blackfin Processor Specifications (Cont'd)

Blackfin Family Matrix	Package	Clock Speed MHZ Max	Temp Range Ambient	RoHS Comp- liant	Key Peripherals ¹
ADSP-BF549 Peripherals: MXVR, CAN, HS USB OTG, ATAPI-6, 3 EPPIs, Pixel comp, Lockbox					
ADBF549WBBCZ-5xx	400-CSP_BGA	533	-40°C to +85°C	x	
ADSP-BF561 Peripherals: 2 PPIs, UART, 12 timers, 2 SPORTs					
ADSP-BF561SBB500	297-PBGA	500	-40°C to +85°C		
ADSP-BF561SBB600	297-PBGA	600	-40°C to +85°C		
ADSP-BF561SBBCZ-5A	256-CSP_BGA	500	-40°C to +85°C	x	
ADSP-BF561SBBZ500	297-PBGA	500	-40°C to +85°C	x	
ADSP-BF561SBBZ600	297-PBGA	600	-40°C to +85°C	x	
ADSP-BF561SKBCZ-5A	256-CSP_BGA	500	0°C to +70°C	x	
ADSP-BF561SKBCZ-5V	256-CSP_BGA	533	0°C to +70°C	x	
ADSP-BF561SKBZ500	297-PBGA	500	0°C to +70°C	x	
ADSP-BF561SKBZ600	297-PBGA	600	0°C to +70°C	x	

Table 1-1. Summary of Blackfin Processor Specifications (Cont'd)

Blackfin Family Matrix	Package	Clock Speed MHZ Max	Temp Range Ambient	RoHS Comp- liant	Key Peripherals ¹
ADSP-BF561SKBCZ-6A	256-CSP_BGA	600	0°C to +70°C	x	
ADSP-BF561SKBCZ-6V	256-CSP_BGA	600	0°C to +70°C	x	

¹ Lists peripherals common to all models in the Blackfin series. Additional peripherals are listed in the row for each individual model.

Future Blackfin Processor Releases

Increased performance and a feature-rich variety of new peripherals are the focus for future Blackfin releases.

Blackfin Processor Features

Blackfin processors represent a class of devices that combine an extremely capable single-instruction, multiple-data (SIMD) processor engine with powerful features such as a memory protection unit, watchdog timer, real-time clock, variable-length RISC instructions, UARTs, and SPI ports. These features are typically found only in microcontrollers and microprocessors.

Because Blackfin processors possess all the power of a signal processor and are full featured, they can replace other classes of signal processors and 32-bit RISC MCUs or an ASIC in designs.

At the core, Blackfin processors have a 16-bit, dual MAC (multiply/accumulate) architecture with 32-bit registers and 64-bit internal data paths. This core is surrounded by high-speed memory and high-speed peripherals

Blackfin Processor Features

including 100 Mbps serial ports (SPORTs), a high-speed parallel peripheral interface (PPI) capable of moving digital video on and off chip (ITU-R/CCIR-656 compliant), UART with IrDA[®] support, SPI port, and an external memory interface for connection to SDRAM or DDR SDRAM, flash, SRAM, and so on.

In addition to its advanced peripherals, Blackfin processors include a software-programmable, on-chip phase-lock loop (PLL) that allows software to control the core and system clock speeds. Many Blackfin processors also feature an on-chip switching regulator to provide software control of core voltage as well. Either of these features used individually, or both used in tandem, can result in significant power savings because the clock and/or the voltage can be constantly varied, depending on the task at hand.

Because Blackfin processors can be used for both control/data processing and signal processing, the efficiency of data movement and storage has a high impact on performance. Efficient numerical precision is important, although efficiency of data movement is equally important. The measured width of a signal processing device is often based on the type of data it processes most efficiently. The width of a processor is typically measured by its data paths and register widths. Blackfin processors support 8-, 16-, and 32-bit arithmetic operations in hardware, but are optimized for (and have the most support for) 16-bit operations. Thus, Blackfin processors are considered to be 16/32-bit processors.

Performance

Processors can no longer be judged solely on core clock speed, MHz, MIPS, MACS, FLOPS, and so on. Newer Blackfin processors run at core clock frequencies starting at 300 MHz. Their internal memory is L1, which means that memory also runs at the core clock rate, providing large amounts of bandwidth between a processor's core and its internal memory. The core supports two 16-bit multiply/accumulates per cycle sustained, providing 1.2 GMACs at 600 MHz.

Although these numbers provide a rough idea of a device's performance, they do not measure how an application runs on a device because they do not take into account memory efficiency or instruction set efficiency. Often, these peak specifications occur only momentarily (that is, they are not sustained), and the sustained values are much lower. This is where benchmark data can be useful. [“Benchmarks Against Other Processors” on page 1-30](#) describes performance measurements reported by third parties.

System developers can leverage the wide range of performance options available with Blackfin processors. Lower frequency, signal-core devices scale up to high-frequency, high-bandwidth, dual-core devices.

ADSP-BF561 Blackfin processors provide additional options for power management. Because this symmetric processor contains two identical cores, traditional processing-intensive applications can be split equally to run on each of the two cores. In this model, code running on each core is identical; only the data being processed is different. In a channel-streaming application, the first core processes half of the channels and the other core processes the other channels. In video and imaging applications, this technique can be used to process alternate frames on each of the cores.

Dual-core processing melds with the Blackfin processor's additional power savings features. The energy consumed by a processor is based on static and dynamic components. Even when the application fits on a single-core processor, you can employ a dual-core processor to reduce overall energy consumption. Specifically, by running an application at half the frequency of a single-core system, the processor core voltages can also be dropped to values as low as 0.9 V. This is possible because of the Blackfin processor's wide voltage operating range. Dual-core Blackfin processors contain large amounts of on-chip memory along with data paths and DMA controllers that have been sized specifically to handle a shared processing load. This combination allows an algorithm to be split easily without the loss of efficiency that can be felt on multicore solutions with different processors.

Benchmarks Against Other Processors

When evaluating processors, it can be confusing to look at data sheets and compare the specifications. We recommend that you refer to accepted industry-standard benchmarks like Dhrystone, Whetstone, and nbench.

 The Dhrystone, Whetstone, and nbench benchmarks run under the Linux platform.

The benchmarks are presented in the following sections.

Dhrystone

The Dhrystone benchmark was designed to test performance factors important to non-numeric systems programming (operating systems, compilers, word processors, and so forth). The benchmark is notable in that:

- It contains no floating-point operations.
- A considerable percentage of time is spent in string functions making the test very dependent upon the way such operations are performed (for example, by in-line code, routines written in assembly language, and so on), making it susceptible to manufacturers “tweaking” of critical routines.
- It contains hardly any tight loops so in the case of very small caches, the majority of instruction accesses are misses; however, the situation changes radically as soon as the cache reaches a critical size and can hold the main measurement loop.
- Only a small amount of global data is manipulated (as opposed to Whetstone).

There are two versions of the Dhrystone benchmark. A deprecated version (Version 1.1) contained some “dead code” that could be removed by optimizing compilers. Version 2.1 corrected this and should be the version used in practice (and is the one that is in the μ Clinux distribution). Some manufacturers, however, still quote the (better) results of Version 1.1, so care must be taken when comparing Dhrystone performance figures to check which version was used.

Recent Dhrystone test results can be found at:

<https://docs.blackfin.uclinux.org/doku.php?id=uclinux-dist:dhrystone>

Whetstone

The Whetstone benchmark was first written to measure computer performance and was later designed to simulate floating-point numerical applications. The Whetstone benchmark is notable in that:

- It contains a large percentage of floating-point data and instructions.
- A high percentage of execution time (approximately 50%) is spent in mathematical library functions.
- The majority of its variables are global and the test does not show up the advantages of architectures such as RISC where the large number of processor registers enhance the handling of local variables.
- It contains a number of very tight loops; the use of even fairly small instruction caches will enhance performance considerably.
- The original program was written in Fortran using single- or double-precision calculations.

Benchmarks Against Other Processors

Recent Whetstone test results can be found at:

<https://docs.blackfin.uclinux.org/doku.php?id=uclinux-dist:whetstone>

nbench

nbench is a Linux/Unix port of release 2 of *BYTE Magazine's* BYTEmark benchmark program (previously known as BYTE's Native Mode Benchmarks). These are native mode (also known as algorithm level) tests. They are benchmarks designed to expose the capabilities of a system's CPU, FPU, and memory system.

This benchmark program takes less than ten minutes to run (on most machines) and compares the system it is run against to two benchmark systems (a Dell Pentium 90 with 256 KB cache running MSDOS, and an AMD K6/233 with 512 KB cache running Linux). The following listing shows the nbench Blackfin compilation results.

Listing 1-1. nbench Blackfin Compilation Results

```
root:~> nbench

BYTEmark* Native Mode Benchmark ver. 2 (10/95)
Index-split by Andrew D. Balsa (11/97)
Linux/Unix* port by Uwe F. Mayer (12/96,11/97)

TEST                : Iterations/sec.   : Old Index   : New Index
                    :                   : Pentium 90* : AMD K6/233*
-----:-----:-----:-----:-----
NUMERIC SORT        :          116.12   :      2.98   :      0.98
STRING SORT         :          3.8685   :      1.73   :      0.27
BITFIELD            :      4.7085e+07   :      8.08   :      1.69
FP EMULATION        :          22.923   :     11.00   :      2.54
FOURIER             :          94.582   :      0.11   :      0.06
```



```
ASSIGNMENT      :          1.6106 :          6.13 :          1.59
IDEA            :          355.45 :          5.44 :          1.61
HUFFMAN        :          146.31 :          4.06 :          1.30
NEURAL NET     :          0.10077 :          0.16 :          0.07
LU DECOMPOSITION :          3.5476 :          0.18 :          0.13
```

```
=====ORIGINAL BYTEMARK RESULTS=====
```

```
INTEGER INDEX      : 4.836
FLOATING-POINT INDEX: 0.147
Baseline (MSDOS*)  : Pentium* 90, 256 KB L2-cache, Watcom* compiler 10.0
```

```
=====LINUX DATA BELOW=====
```

```
CPU                :
L2 Cache           :
OS                 : Linux 2.6.19.3-ADI-2007R1-pre-svn2773
C compiler         : bfin-linux-uclibc-gcc
libc               : static
MEMORY INDEX       : 0.895
INTEGER INDEX      : 1.509
FLOATING-POINT INDEX: 0.082
Baseline (LINUX)   : AMD K6/233*, 512 KB L2-cache, gcc 2.7.2.3,
libc-5.4.38
```

* Trademarks are property of their respective holder.

EEMBC

If the application demands the performance of a signal processing engine and a microcontroller, examine what the Embedded Microprocessor Benchmark Consortium (EEMBC) says about Blackfin processors.

These test results were obtained using a VisualDSP++ compiler.

The following paragraphs are taken from the EEMBC Web site.

EEMBC, the Embedded Microprocessor Benchmark Consortium, was formed in 1997 to develop meaningful performance benchmarks for the hardware and software used in embedded systems. Through the combined efforts of its members,

Benchmarks Against Other Processors

EEMBC® benchmarks have become an industry standard for evaluating the capabilities of processors, compilers, and Java implementations according to objective, clearly defined, application-based criteria.

Since releasing its first certified benchmark scores in April 2000, EEMBC scores have effectively replaced the obsolete Dhrystone mips, especially in situations where real engineering value is important. EEMBC benchmarks reflect real-world applications and the demands that embedded systems encounter in these environments. The result is a collection of “algorithms” and “applications” organized into benchmark suites targeting telecommunications, networking, digital media, Java, automotive/industrial, consumer, and office equipment products. An additional suite of algorithms specifically targets the capabilities of 8- and 16-bit microcontrollers.

EEMBC’s certification rules represent another break with the past. For a processor’s scores to be published, the EEMBC Certification Laboratories (ECL) must execute benchmarks run by the manufacturer. ECL certification ensures that scores are repeatable, obtained fairly, and according to EEMBC’s rules. Scores for devices that have been tested and certified by ECL can be searched from our Benchmark Search page.

To find out more about how Blackfin processors perform compared to the competition, go to the following EEMBC Web page:

<http://www.eembc.org>

Based on recent EEMBC data, [Figure 1-3](#) shows results of various EEMBC benchmarks.

Benchmarks

Processor	Blackfin	ARM1136JF-S™	ARM926EJ-S™
Product	BF533	i.MX31	i.MX21
Clock Frequency (MHz)	594	532	266
Certified on Hardware?	yes	yes	yes
EEMBC Networking 2.0*			
IPmark**	45	50.4	24.4
TCPmark**	117	68.5	29.2 ^a
EEMBC AutoBench 1.1*			
Automark**	183.1	126.6	29.6
EEMBC ConsumerBench 1.1*			
Consumermark**	54.9	26.6	13.7
EEMBC OABench 1.1*			
OAmark**	352	341	152
EEMBC TeleBench 1.1*			
Telemark**	11.7	6.1	2.5
EEMBC DENBench 1.0*			
MPEG Decodemark**	337	231	112
MPEG Encodemark**	392	243	100
Cryptomark**	257	219	104
Imagemark**	352	315	154
DENmark**	57.5	45.5	21.6
Geometric Mean	138.7	99.3	42.6

* Out-of-the-box category
 ** bigger is better

^ai.MX21 TCPmark contains an estimate for one subtest whose result is filed n/a at EEMBC. (Estimate was 1/2 i.MX31 performance.)

Figure 1-3. EEMBC: Assorted Benchmark Results

Analog Devices Benchmarks

Analog Devices has assembled benchmarks to test Blackfin processors. The synergy of the Blackfin processor architecture and the VisualDSP++ compiler yields high-density code.

Benchmarks Against Other Processors

Links to Comparative Benchmarks

Access comparative data to see how Blackfin processors compare to other manufacturers' parts.

Open your browser and access the following Web page, which contains links to the EEMBC Web sites:

<http://www.analog.com/processors/blackfin/overview/benchmarks/index.html>

Blackfin Processor Compiler and Code Density

Blackfin processors coupled with the powerful VisualDSP++ software development tools now make it possible to develop code in C/C++ more easily and efficiently than before. The high MIPS availability from the core processor allows for initial versions of software to be compiled and run on the processor much earlier in the design cycle, thus allowing for quicker overall system debug to shorten time to market. The goal is to alleviate software as a potential critical path element in system development.

Figure 1-4 shows an example of the code development efficiency on Blackfin processors using an adaptive multi-rate (AMR) encoder.

COMPILER RESULTS IN FULLY FUNCTIONAL CODE FROM FIRST WEEK OF IMPLEMENTATION.

PERSON MONTHS	PERCENTAGE IN C	PERCENTAGE OVERHEAD
0.25	100	366
3.00	75	36
5.00	65	20
12.00	0	0

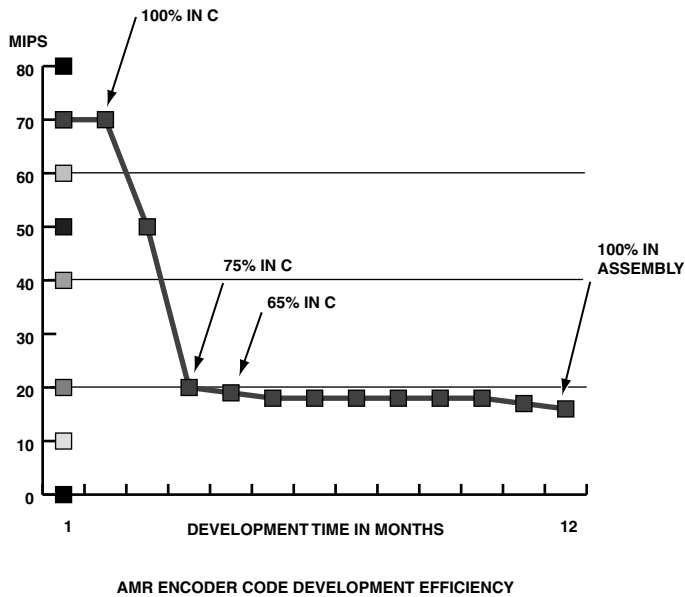

Figure 1-4. The VisualDSP++ Compiler Yields High-Density Code

Benchmarks Against Other Processors

2 THE EVALUATION PROCESS

This chapter introduces software and hardware tools that are currently available. Topics include:

- [“Selecting Software Development Tools” on page 2-1](#)
- [“Selecting Hardware Development Tools” on page 2-23](#)
- [“Selecting the Right Combination of Tools” on page 2-84](#)

Selecting Software Development Tools

This section examines the process through which Blackfin processor applications are developed. Various tools are used at each stage, where typical application development occurs over multiple stages. The section provides a summary of the available software development tools for Blackfin processors.

Most users acquire a set of *software development tools* first. The software development tools run on a PC and provide code generation and debug utilities such as a compiler, assembler, linker, simulator, debugger, and libraries.

Currently, three sets of software development tools are available for the Blackfin processor architecture:

- VisualDSP++ 5.0 from Analog Devices
- Open source GCC tool chain and μ Clinux

Selecting Software Development Tools

Each offers advantages for different types of applications. Other software development tools are available in languages such as Japanese and Chinese. Contact your local Analog Devices sales office or distributor for more information. [Figure 2-1](#) shows the tool selection workflow.

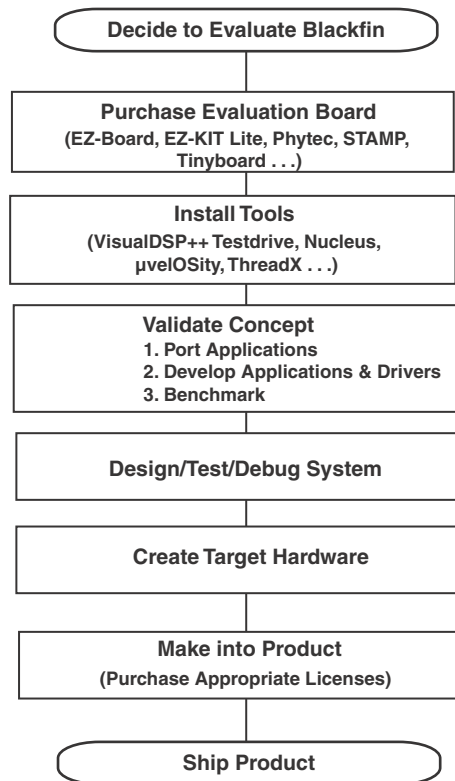

Figure 2-1. Tool Selection Workflow

VisualDSP++ From Analog Devices

VisualDSP++ is an easy-to-install and easy-to-use integrated software development and debugging environment (IDDE) that enables efficient management of projects from start to finish from within a single interface.

Because project development and debugging is integrated, you can move quickly and easily between editing, building, and debugging activities. Key features include the native C/C++ compiler, advanced graphical plotting tools, statistical profiling, and the VisualDSP++ kernel (VDK), which allows a user's code to be implemented in a more structured and easier-to-scale manner. Other features include assembler, linker, libraries, splitter, cycle-accurate and functional-accurate simulators, emulator support, and more. VisualDSP++ offers programmers a powerful yet easy-to-use programming tool with flexibility that significantly reduces the time to market.

Platform and Processor Support

VisualDSP++ supports Blackfin processors from Analog Devices. Windows® System 7 (as of VisualDSP++ 5.0 Update 8), Windows® Vista, Windows® XP, and Windows® 2000 hosts are supported.

Develop High-Performance Applications Quickly

At the heart of VisualDSP++ is a robust and powerful C/C++ compiler. The compiler consistently delivers industry-leading performance on standard benchmarks, ensuring that all but the most performance-demanding applications can be written entirely in the C language, accelerating development time while maintaining a portable code base. The compiler is backed by a rich library of signal processing routines, allowing easy access to hand-coded, optimized implementations of FFTs, FIRs, and so forth.

Selecting Software Development Tools

The ANSI-C compiler is also augmented with popular language extensions and enhancements to make it more amiable to existing code bases. Examples include GNU GCC extensions, ETSI fractional libraries, and multiple heap support.

A compiler's overriding mission is to produce correct code, so there are occasions when the compiler must take a conservative approach to a code sequence when a more aggressive approach could have been taken if certain constraints could be guaranteed by the programmer. The VisualDSP++ compiler supports a broad range of pragmas that allow the programmer to better exploit the compiler while maintaining C language neutrality. Just as important, the compiler has the ability to feed back advisory information to the programmer, offering further improvements to a code sequence, should the programmer be able to make certain guarantees about it. This information is displayed seamlessly in the VisualDSP++ main editor window. This removes the black box label that compilers sometimes have.

Backing the compiler is powerful assembler and linker technology. Processors from Analog Devices are noted for their intuitive algebraic assembly language syntax, and the VisualDSP++ assembler extends that ease of use with the ability to import C header files, allowing for symbolic references into arbitrarily complex C data structures. Binary data can be included directly into assembly source files, creating an easy way to add blocks of static data (such as audio samples and bitmaps) to an application. The VisualDSP++ linker is fully multicore and multiprocessor (MP) aware, allowing for the creation of cross-linked, multi-executable applications in a single pass. Other powerful capabilities of the linker include dead code and data elimination, code and data overlays, section spilling (that is, automatic overflow from internal to external memory), and automatic short-to-long call expansion.

Leverage-Proven Application Infrastructure

VisualDSP++ goes beyond robust code generation tools, providing considerable application infrastructure and middleware out of the box to speed application development. The VisualDSP++ kernel (VDK) is a robust, royalty-free, real-time operating system (RTOS) kernel. It provides essential kernel features in a minimal footprint. Features include a fully pre-emptive scheduler (time slicing and cooperative scheduling are also supported), thread creation, semaphores, interrupt management, inter-thread messaging, events, and memory management (memory pools and multiple heaps). In MP environments, messaging is also provided. Configuration of these elements is done graphically, with code wizards to speed the creation of new threads and interrupt handlers. VDK has been available for multiple releases of VisualDSP++ and is now a key component of products shipping from several high-volume vendors.

Blackfin processors can take advantage of the system services library, which provides consistent, easy C language access to Blackfin features such as the interrupt manager, direct memory access (DMA), and power management units. Clock frequency and voltage can be changed easily at run time through a set of simple APIs. Interrupt handling can be live, fired at the time of the event, or deferred to a later time of the application's choosing. A device manager integrates device drivers for on- and off-chip peripherals. VisualDSP++ includes device driver support for all on-chip peripherals and off-chip devices found on Analog Devices EZ-KIT Lite and EZ-Extender products. The system services library is OS-neutral and can be run standalone or in conjunction with an RTOS.

As embedded applications become increasingly part of the connected world, the ability to rapidly add reliable ethernet or USB connectivity to an application can often make or break a development schedule. For Blackfin processors, VisualDSP++ includes a tuned port of the open source LwIP TCP/IP stack. An example application showcasing an embedded Web server is among the highlights of this support. USB 2.0

Selecting Software Development Tools

device connectivity is provided. Bulk and asynchronous transfer modes are supported out of the box. Host applications are provided with full source code.

The VisualDSP++ state-of-the-art integrated development and debugging environment (IDDE) includes full-featured editing and project management tools. It uses incremental builds, multiple build configurations (“Debug” and “Release,” for example), a syntax-coloring editor, and many other code editing features. Makefiles can be imported and exported freely. Many application attributes can be configured graphically, enabling point-and-click access to SDRAM setup, stack and heap placement, power management, clock speed, cache setup, and more.

Debug and Tune Your Application With Ease

The ability to develop a high-performance application is often gated by the visibility into your running system that your debugger provides. VisualDSP++ excels in this regard, with best-in-class debugging and inspection support. Robust fundamental C language source debugging (source-level stepping and breakpoints, stack unwinding, local variable and C-expression support, memory and register windows) serves as a foundation upon which multiple innovative and unique tools rest.

VisualDSP++ supports a variety of debug targets. Most common is a JTAG connection to an EZ-KIT Lite board or to a custom target board by means of Analog Devices emulator products. However, there will be occasions where closer inspection in a simulated environment may be required. VisualDSP++ provides cycle-accurate simulators, allowing inspection of every nuance of activity within the processor core, including visualization of the processor’s pipeline and cache. These simulators are robust and highly accurate, so much so that silicon designers at Analog Devices use them for validation. A second simulator is available to Blackfin processor users—a high-speed, functional simulator. Using proprietary just-in-time (JIT) technology, the simulators have the ability to model millions of

cycles per second on the most modest of host PCs. Effectively, this means that what used to be an overnight run is now a 10-minute coffee break, and what was once a coffee break is now a near-instantaneous simulation.

As many of the most performance-demanding applications process a signal of some sort, comprehensive memory plotting is a cornerstone of VisualDSP++ debugger support. VisualDSP++ provides multiple views, from basic (line plots) to sophisticated (eye diagrams and waterfalls), to pinpoint anomalous data sequences in your application. Image viewing in a number of data formats is also available.

Users of the VDK get unparalleled visibility into the internals of the kernel. Status on a per-thread basis is available, as is a comprehensive pictorial history of kernel events and CPU loading. Thread changes, posted and pended semaphores, and other kernel events are captured in this display.

Inspection, or even application stimulation, from the debugger at run time is possible through the use of the processor's background telemetry channels (BTCs). BTCs allow for an arbitrary number of communication channels to be established between the host debugger and the application. Channels may go in either direction, so BTCs can be used to read and write data as the processor runs. Scalar values or entire arrays may be serviced by a channel. Arrays read from the target can even be plotted in real time.

Multiprocessor (MP) users get the same set of debugging features across all processors, unified into a single debugging interface. Individual windows can be made to float their focus to whichever processor currently is the debugger's focus, or they can be pinned to a specific processor so their contents do not follow the debugger's focus. To further aid MP debug, synchronous run, step, halt, and reset are also provided.

The patented statistical profiler from Analog Devices offers unprecedented and unique visibility into a running application. Operating completely non-intrusively to the application, the application is polled thousands of

Selecting Software Development Tools

times per second and a statistical view of where an application is spending the majority of its time is quickly assembled. This tool can be used to easily inspect an application for unexpected hotspots (for example, suggesting the need to move a key routine from external to internal memory). Simulator targets provide a completely linear profiling view. For Blackfin processors, traditional instrumented profiling is also available.

Going even further, the VisualDSP++ compiler is able to act upon profiling information. Profile-guided optimization (PGO) is a technique that allows the compiler to instrument an application, run the application, and then make a second pass compilation, exploiting the information that was gathered during the previous run of the application. This gives the compiler unique insight on a block-by-block basis, allowing it to optimize with a level of granularity that is not possible with a tool that operates only on a file-by-file basis.

Integrate Into Your Existing Environment

A development tool suite is always a part of an organization's larger software engineering environment. VisualDSP++ has been designed to operate in a larger environment.

An embedded systems engineer is often developing on a new platform while maintaining existing products that were likely developed with an earlier version of the tools. VisualDSP++ can be installed discretely an arbitrary number of times at a variety of release levels, allowing engineering to easily switch between current and legacy versions of VisualDSP++.

To better integrate to source code control (SCC) systems, VisualDSP++ is able to connect to any SCC provider that supports the Microsoft® common source code control (MCSCC) interface. This interface is supported by all leading SCC vendors. VisualDSP++ goes one step further by supporting the control of VisualDSP++ itself within a source code control system.

The ability to robustly test an embedded application is enabled through a comprehensive automation application programmers interface (API). Using Microsoft's language-neutral automation technology, nearly every feature of the graphical environment is available to script authors. Applications can be rebuilt, downloaded, and run from a simple script executed from the command line or from within a custom test harness framework. The automation API is supported by C++ and VBScript examples for all API calls, though any automation-aware language can be used.

For prototype runs and/or small volume deployment, an Analog Devices emulator can be used to flash a program onto your custom system. Accessible through the automation API, the flash programmer can be scripted, making it possible to develop a turnkey user interface for use by a production floor technician or other individual not familiar with VisualDSP++. Device drivers are provided for all flash devices found on EZ-KIT Lite products, and these drivers can be easily adjusted to support an arbitrary flash device.

Get Help and Stay Up to Date

Analog Devices is aware that best-in-class customer support is ultimately in the interest of both customers and Analog Devices in the long run. Analog Devices is committed to this customer support for VisualDSP++.

VisualDSP++ includes a comprehensive, indexed, searchable online Help system. In addition to information concerning VisualDSP++, manuals for Analog Devices processors, application notes, and more are included in the Help system. The .pdf file versions of these documents are also available on the installation CD or online at:

http://www.analog.com/technical_library

Licensed users of VisualDSP++ are entitled to free technical support. The support staff is dedicated to VisualDSP++ and has specific expertise regarding it. There is never a per-incident or maintenance fee; support remains free regardless of how long you have owned your software.

Selecting Software Development Tools

Major and minor upgrades and updates to VisualDSP++ are also free and are released through the Analog Devices Web site.

Use Third Parties

Use the independent network of third-party developers. [For more information, see “Find a Third Party—Faster Time To Market” on page 3-23.](#)

Install VisualDSP++

Use VisualDSP++ free for 90 days. Either download VisualDSP++, request a CD from the Analog Devices DSP Tools Web site at <http://www.analog.com/processors/tools/testdrive>, or contact your local Analog Devices sales representative/distributor.

Analog Devices Tools

CROSSCORE® (development tools from Analog Devices) provides easier and more robust methods for engineers to develop and optimize systems by shortening product development cycles for faster time to market. The CROSSCORE components include the VisualDSP++ software development environment, EZ-Board evaluation boards, EZ-KIT Lite evaluation systems, EZ-Extender daughterboards, and emulators for rapid on-chip debugging. For more information on development tools, visit the Analog Devices Web site at:

<http://www.analog.com/processors/tools>

Embedded Processors and DSPs

Blackfin processors and integrated mixed-signal DSPs are ideal for an ever-increasing spectrum of applications. Advances in design from Analog Devices provide faster processing, more memory, lower power consumption, and simplified system integration. Analog Devices products and technology provide a competitive edge complete with expert technical support, comprehensive development tools, and third-party developers.

Code Examples

Specific code examples for many DSP algorithms optimized for Blackfin processors are currently available. The code examples are contained in .zip files available from the following Web page:

http://www.analog.com/en/embedded-processing-dsp/blackfin/content/blackfin_code_examples/fca.html

The examples are grouped into the following categories: multi-rate filters, Fourier and discrete cosine function sets, convolution encoder sets, speech- and audio-related algorithms, image processing function sets, image analysis, audio/video, and so on.

To receive automatic notification by e-mail when any of these code examples are updated, register for [MyAnalog.com](http://www.analog.com) and select **Blackfin** as the “product category” and **Code Examples** as the “publication type”.

Device Drivers and System Services

Powerful system services are available to applications through the system services library, which can be used to control the Blackfin processor’s dynamic power management capabilities as well as control external asynchronous and synchronous memories, and manage interrupt processing. Applications can utilize the services of the DMA and callback services to easily schedule peripheral and memory DMA transfers, and defer non-critical, event-driven processing to a lower priority.

Open Source Software for Blackfin Processor

There is a large variety of Open Source software available for the Blackfin processor. This section describes some of the packages available. It contains the following subsections:

- [GNU Toolchain](#)
- [Linux and GNU Toolchain Help: The Blackfin Koop](#)
- [Eclipse IDE](#)
- [μClinix Distribution](#)
- [Analog Devices Processors Supported for μClinix](#)
- [Board Support Packages](#)
- [Daughter Cards](#)
- [GNU Toolchain](#)

GNU Toolchain

The components of the GNU toolchain consist of:

- The GNU Binutils, which is a collection of binary tools, the main ones being as (the GNU assembler) and ld (the GNU linker). The mainline binutils project can be found on the GNU pages, where a comprehensive manual can also be found.
- The GNU Compiler Collection (gcc), which includes front ends for C, C++, Fortran. The mainline gcc project can be found on the GNU pages, where a comprehensive manual can also be found.
- The GNU Debugger (gdb), allows you to see what is occurring inside another program while it executes or what another program was doing when it crashed. The mainline project can be found on the GNU pages.

- The generation of μ Clinux's flat format – elf2flt
- Tools to support embedded file system generation for a variety of types. These include:
 - ext2 with genext2fs
 - cram with cramfs
- Tools to support bare metal application development and booting, called ldr-utils. These tools take standard gcc elf files, and convert them into a format that the Blackfin bootloader can interpret.
- Libraries, including libdsp, newlib, libgloss, and μ Clibc.
- Toolchain components that support the Canadian Cross Compiler. This means you no longer need to have a Linux host. You can develop bare metal applications and Linux applications (not kernel) on a Microsoft Windows PC.
- JTAG tools (both urjtag and gdbproxy) to program flash over JTAG, or debug a standalone application.
- Integrated Development Environments (IDE). The Blackfin GNU Toolchain plugs into many IDEs and graphical debuggers.

Linux and μ Clinux

μ Clinux stands for microcontroller Linux. (μ is the Greek letter mu denoting micro and C for controller.) The name μ Clinux normally refers to the complete distribution, and is not the name of the kernel. Similar to Red-Hat, Debian, Gentoo, or Damn Small Linux, μ Clinux is the name of the collection of userspace applications, userspace libraries, the system libraries, and the Linux kernel.

Selecting Software Development Tools

For more information about the difference between Linux and μ Clinux, visit this URL:

http://docs.blackfin.uclinux.org/doku.php?id=uclinux-dist:difference_from_linux

Linux and GNU Toolchain Help: The Blackfin Koop

The Blackfin Koop is the central location for open source and free software and hardware projects targeted for use with certain members of the Analog Devices Blackfin processor family, and Analog Devices peripherals (and their associated Linux drivers). In addition to a wide range of applications, the Koop also focuses on supporting Open Source hardware and software tools, including the GNU GCC toolchain and the μ Clinux distribution. It is sponsored and supported by a small team from Analog Devices. The URL is:

<http://blackfin.uclinux.org/gf/>

The Blackfin Koop provides support (including user assistance and defect correction) for the GNU Toolchain, Das U-Boot, the Linux Kernel, the μ Clinux Distribution and the schematics. These items can be found on this Web site:

<http://blackfin.uclinux.org/>

If you have a question, or think you have found a defect, please use the Help or Bugs links found on the home page.

Eclipse IDE

Eclipse is an integrated development environment (IDE) that provides support for managing projects, editing and debugging source code, and using external build tools. Eclipse can be downloaded from The Eclipse Foundation at:

<http://eclipse.org/downloads>

It is available for a variety of platforms including Windows, Linux, and Mac OS X.

Blackfin-specific plug ins can be found at:

<http://blackfin.uclinux.org/eclipse/>

μClinux Distribution

Blackfin processors target embedded applications such as networking and internet appliances, automotive telematics, and portable devices. Many developers want more than just the processor and a software tool chain. To speed time to market, processor selection often hinges on operating system (OS) availability and existing software support.

μClinux is an open source OS that has been gaining significant attention and popularity over the past few years. There are several drivers for μClinux's expanding user base—source code availability, royalty-free licenses, reliability, open source community support, tools availability, networking support, portability, and an extensive application base.

To foster the sharing of this knowledge, the <http://blackfin.uclinux.org/> Web site was launched in February, 2004. The site serves as a central repository for all μClinux Blackfin processor projects worldwide and hosts code examples, question and answer forums, and bug tracking. By creating an open source solution, embedded applications developers are able to leverage a wealth of knowledge and support from the open source community.

Blackfin μClinux

This section provides information about Blackfin support for μClinux. It also provides tables containing information about hardware and software support for μClinux projects.

Selecting Software Development Tools

Analog Devices Processors Supported for μ Clinux

μ Clinux has been ported and supports the following Analog Devices processors:

- ADSP-BF522/3/4/5/6/7 (revision 0.1 or higher)
- ADSP-BF531/2/3 (revision 0.3 or higher)
- ADSP-BF534/6/7 (revision 0.2 or higher)
- ADSP-BF542/4/7/8/9 (revision 0.1 or higher)
- ADSP-BF561 (revision 0.3 or higher)

Latest Versions of Linux and Corresponding URLs

These are the approximate versions of Linux to date. Check out their corresponding URLs for the precise version numbers.

- Linux kernel: 2.6.x
<http://blackfin.uclinux.org/gf/project/uclinux-dist/frs>
- Tool chain: gcc 4.x
<http://blackfin.uclinux.org/gf/project/toolchain/frs>
- Das U-Boot: 1.x
<http://blackfin.uclinux.org/gf/project/u-boot/frs>

μ Clinux Footprint

The default kernel is 500 Kbytes – 1 MB

Recommended Flash Size

A workable image will fit in 4 MB of flash memory (serial, NAND, or parallel NOR).

Supported Debugging Tools

The following debugging tools are supported:

- GDB with simulation and JTAG support
- KGDB (for kernel and driver development)
- GDBSERVER (over ethernet or serial port)
- ICEBear USB ICE (for use with GBD). Visit this URL:
<http://www.section5.ch/icebear>
- gnICE USB JTAG In-Circuit-Emulator. Visit this URL:
<http://www.bluetechnix.com/>

Real-Time and General-Purpose Kernels

ADEOS has been ported to the Blackfin processor. ADEOS is a hardware abstraction layer allowing a real-time kernel and a general-purpose kernel to coexist. ADEOS supports the kinds of dual-OS Linux environments that are achieved using RTLinux or RTAI, without making use of the technology that is the subject of the RTLinux patent.

Linux Software Projects

[Table 2-1](#) describes Linux software projects that work with Blackfin processors. For an enhanced version of this table that includes URLs for each project, visit:

<http://docs.blackfin.uclinux.org/doku.php?id=projects>

Selecting Software Development Tools

Table 2-1. Linux Software Projects

Name	Description
Arbitrary Waveform Generator	A simple arbitrary waveform generator – define a plot via a Web interface, generate data, and send it to a DAC.
Asterisk PBX	A complete PBX in software. μ Casterisk is one part of a project to build a completely open telephony hardware platform.
QT GUI Library	A multi-platform C++ GUI toolkit created and maintained by Trolltech. It is enabled on Blackfin/ μ Clinux.
Nano-X window system	An open source project aimed at bringing the features of modern graphical windowing environments to smaller devices and platforms. Nano-X allows applications to be built and tested on the Linux desktop, as well as cross-compiled for the target device.
Browsers	Two open source http text browsers are known to work on Blackfin/ μ Clinux: links, and lynx. One is a graphic Web browser (Konqueror3) embedded. Included is documentation to download these applications, configure them for Blackfin/ μ Clinux, and run them on the Blackfin processor.
LinPhone Voice over IP Phone	Use the console version of Linphone to make voice calls over the Internet.
Net Audio Player	Mount a Windows Share over the network, and play compressed audio files, controlled via a Web browser.
Networked Scope	A simple networked oscilloscope – capture data with a ADC, plot it with gnuplot, and pass it as a Web page with boa or thttpd.
PocketSphinx	A version of the open source Sphinx-II speech recognition system which runs on handheld and embedded devices. This snapshot is now running under real time on the Blackfin/ μ Clinux.

Table 2-1. Linux Software Projects (Cont'd)

Name	Description
Adeos and Xenomai	Adeos provides a flexible environment for sharing hardware resources among multiple operating systems, or among multiple instances of a single OS. Xenomai is a real-time development framework cooperating with the Linux kernel. It provides real-time support to user-space applications, seamlessly integrated into the GNU/Linux environment. Xenomai is based on Adeos.
kaffe	A clean room implementation of the Java virtual machine, plus the associated class libraries needed to provide a Java run-time environment.
xmame/xmess	Ports of MAME, the multiple arcade machine emulator and MESS, the multi-emulator super system.
BlueZ	An implementation of the Bluetooth™ wireless standards specifications for Linux. The code is licensed under the GNU general public license (free) and is now included in the Linux 2.4 and Linux 2.6 kernel series.
FFmpeg & vlc	FFmpeg is a very fast video and audio converter. It can also grab from a live audio/video source. On the Blackfin processor, we couple it with vlc (video LAN client) to make a free IP camera.

Board Support Packages

Existing ports for Blackfin processors can be downloaded at no cost from:

<http://blackfin.uclinux.org>

The open source GNU tool chain has been ported to Blackfin processors and can also be downloaded from the same site.

The latest release can be downloaded from the SVN tree or from the files section of the “GNU tool chain” project.

Selecting Software Development Tools

The community of open source developers for the Blackfin processor has been growing quickly. To find active development communities go to:

<http://blackfin.uclinux.org>

For more information, see “ [\$\mu\$ Clinux Distribution](#)” on page 2-15.

Daughter Cards

Several daughter cards developed for the ADI development boards are currently available. These cards provide features such as audio and video codecs, interfaces to standard connectors, and data acquisition capabilities. As the project expands, new daughter cards will continue to become available so check here often:

http://docs.blackfin.uclinux.org/doku.php?id=buy_stuff

Linux Hardware Projects

[Table 2-2](#) describes Linux hardware projects that work with the Blackfin processor. For an enhanced version of this table that includes URLs for each project, visit the URL below:

<http://docs.blackfin.uclinux.org/doku.php?id=projects>



Note that this enhanced table is on the same page as the Linux software projects table.

Table 2-2. Linux Hardware Projects

Name	Description
CF / IDE / NAND Card	Multifunction interface cards, which includes CompactFlash (attribute memory, common memory, TRUE IDE MODE, PC Card I/O); IDE for hard drive and CD-ROM; and NAND flash
AD7476A Card	This implements an A/D converter with (AC or DC input) a 2 MHz anti-aliasing filter, connecting to the serial peripheral interface (SPI) connector on the STAMP board.
AD1836A Card	The first audio card is an AD1836A – 6 analog channels of output, 4 analog channels of input, and SPDIF in/out.
AD73311L Card	This audio card has an AD73311 that provides one 16-bit input and one 16-bit output.
AD5443 Card	This implements a D/A converter connecting to the serial peripheral interface (SPI) connector on the STAMP board.
USB Card	This card features two different USB host/device/OTG controllers – ISP1362 and SL811HS for Blackfin STAMP and EZ-KIT Lites.
TWI cards	These TWI (aka I2C) cards provide ease of connectivity to all kinds of low-speed peripherals such as LCD character displays (HD44780), keypad matrices, LEDs, and so on for Blackfin STAMP cards and ADSP-BF537 EZ-KIT Lites.
TFT LCD Card	An introduction on how to use SHARP TFT LCD in μ Clinux for Blackfin ADSP-BF537 STAMP boards.

Selecting Software Development Tools

Summary: Software Development Tools

Table 2-3 compares available Blackfin processor development tools suites.

Table 2-3. Summary of Software Development Tools

Function	VisualDSP++	MULTI	GNU Compiler Collection
Processors	All Blackfin processors	BF51x BF523/525/527 BF53x (except BF535) BF54x BF561	All Blackfin processors (except BF535)
License Model	Proprietary	Proprietary	Zero Cost
Business Model	Perpetual License / Machine	Varied	Open Source
Support	Free with license	Annual Fee	Open Source Forum
IDDE	Proprietary	Proprietary or Eclipse	Eclipse
Simulator	Cycle Accurate Simu- lator Fast Functional Simu- lator	Integrates ADI's Cycle Accurate and Fast Func- tional Simulators	Functional Simulator
Vendor Sup- ported Operat- ing System	VDK	μ Velocity, Velocity, Integrity	μ Clinux

Examples Included With VisualDSP++

VisualDSP++ includes scores of examples built for Blackfin processors. Folders contain programs for signal processing, overlays, scripting, VDK, BTC, and more. Other folders provide example programs that run on EZ-KIT Lite evaluation systems.

The programs help you learn about processor core and peripherals, audio effects, signal processing, video and graphics, kernel and operating systems, and automation and scripting.

Software Modules

Analog Devices has a wide range of tested and optimized software modules, including decoders, encoders, codecs and other algorithms that provide multimedia functions for the Blackfin family. The software modules allow engineers to quickly and easily incorporate these functions, providing a faster development path to the end product. In addition, the highly-optimized software modules feature a consistent API and framework to ensure rapid development of multiple functions.

For more information about software modules, visit:

http://www.analog.com/en/embedded-processing-dsp/blackfin/content/blackfin_software_modules/fca.html

Selecting Hardware Development Tools

Users acquire a *hardware tool* to begin testing the application on a Blackfin processor. Development boards typically provide expansion headers, allowing you to prototype basic hardware without customized user hardware.

Hardware development tools include development and evaluation boards (such as EZ-KIT Lite or STAMP), expansion boards, and JTAG emulators.

EZ-KIT Lite and EZ-Board Evaluation Systems

Typically, development and evaluation boards are standalone printed circuit boards (PCBs) that contain a Blackfin processor with other devices.

Selecting Hardware Development Tools

Analog Devices offers two evaluation systems, EZ-KIT Lite and EZ-Board, for each series of Blackfin processors.

Each EZ-KIT Lite and EZ-Board system includes a board, cable, power supply, documentation, software, and a license key.

EZ-KIT Lite Evaluation System

The EZ-KIT Lite board is a low-cost hardware platform that includes a Blackfin processor surrounded by several other devices such as audio codecs, video encoders, video decoders, flash, SDRAM, and so on.

Each EZ-KIT Lite board also includes an on-board JTAG emulator with a USB 2.0 connector and a standard 13-pin, 100-mil, JTAG header for use with high-performance JTAG emulators available from Analog Devices. Via the processor's JTAG port and the VisualDSP++ software, you can set breakpoints, single-step through code, view memory, fill/dump memory, perform real-time data manipulation, profile execution and memory access, plot data, and use standard I/O.

EZ-KIT Lite evaluation systems include a serial number, that when registered, yields full VisualDSP++ license status for 90 days from the date of installation. After 90 days, the license changes to restricted status, which limits the size of the application that can be built and supports debug agent connectivity only. Refer to [“Selecting Software Development Tools”](#) to see where the EZ-KIT Lite fits into the phases of program development.

Most EZ-KIT Lite boards include three expansion connectors configured in the shape of a “U”. Several third-party expansion boards connect to the EZ-KIT Lite board via these connectors. See [“EZ-KIT Lite Expansion Boards”](#) on page 2-50 for details.

EZ-Board Evaluation System

Blackfin EZ-Board evaluation boards provide developers with a low-cost platform for initial evaluation of Blackfin processors via an external JTAG emulator or standalone debug agent board. The EZ-Board also supports μ Clinux™. EZ-Board is a licensed product that offers an unrestricted evaluation license for the first 90 days.

 To debug, you must have a Debug Agent Board or an emulator. The EZ-Board has an expansion interface that allows for modularity with different EZ-Extender boards.

Table 2-4 compares EZKIT-Lite features to those of the EZ-Board.

Table 2-4. Evaluation Boards Compared

	Standalone Debug Agent Board?	Supports μ Clinux Evaluation Tools?	90-Day VisualDSP++ Evaluation License?	Cables Included?
EZ-Kit Lite	Y	Y	Y	Y
EZ-Board	N	Y	Y	Y

Currently EZ-Boards are available only with the ADSP-BF512/F, ADSP-BF514F, ADSP-BF516F, ADSP-BF518F, ADSP-BF522, ADSP-BF524, and ADSP-BF526 processors.

The following sections briefly describe EZ-KIT Lite and EZ-Board development systems that are currently available for Blackfin processors.

Selecting Hardware Development Tools

ADSP-BF592 EZ-KIT Lite From Analog Devices

Part Number: ADZS-BF592-EZLITE



Figure 2-2. ADSP-BF592 EZ-KIT Lite Evaluation System

The ADSP-BF592 EZ-KIT Lite evaluation system, as shown in [Figure 2-2](#), provides developers with a cost-effective method for initial evaluation of the ADSP-BF592 Blackfin processors via a USB-based, PC-hosted tool set. With this EZ-KIT Lite, users can learn more about the Analog Devices (ADI) ADSP-BF592 hardware and software development, and quickly prototype a wide range of applications.

The EZ-KIT Lite includes an ADSP-BF592 Blackfin processor desktop evaluation board along with an evaluation suite of the VisualDSP++ development and debugging environment, including the C/C++ compiler, assembler, and linker. The evaluation suite of VisualDSP++ is designed to be used with the EZ-KIT Lite only.

The EZ-KIT Lite also comes with a standalone debug agent board that is removable to allow a user to plug-in an external emulator.

Features

- Analog Devices ADSP-BF592 Blackfin processor
- Programmable VDDINT core power: AD5258 TWI digital potentiometer and ADP1715 low dropout linear regulator
- SPI flash memory: Numonyx M25P16, 16 Mb
- Audio codec: Analog Devices SSM2603 stereo, 24-bit analog-to-digital and digital-to-analog converters, highly efficient headphone amplifier, stereo line input and monaural microphone input
- Universal asynchronous receiver/transmitter (UART): ADM3202 RS-232 line driver/receiver, DB9 female connector
- LEDs: 8 LEDs: 1 power (green), 1 board reset (red), 1 battery good indicator (green), 1 battery low indicator (amber), 1 battery charging indicator (amber), and 3 general purpose (amber)
- Push buttons: 4 push buttons: 1 reset, 2 programmable flags, and 1 wake-up with debounce logic
- Expansion interface II: Next generation of the expansion interface design, provides access to most of the processor signals
- JTAG ICE 14-pin header

Selecting Hardware Development Tools

ADSP-BF506F EZ-KIT Lite From Analog Devices

Part Number: ADZS-BF506F-EZLITE

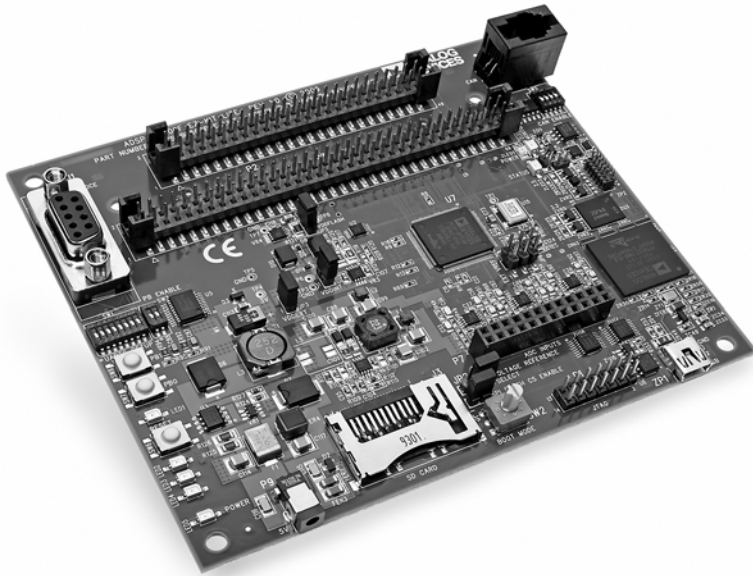

Figure 2-3. ADSP-BF506F EZ-KIT Lite Evaluation System

The ADSP-BF506F EZ-KIT Lite evaluation system, as shown in [Figure 2-3](#), provides developers with a cost-effective method for initial evaluation of the ADSP-BF504/F and BF506F Blackfin processors via a USB-based, PC-hosted tool set. With this EZ-KIT Lite, users can learn more about the Analog Devices (ADI) ADSP-BF506F hardware and software development, and quickly prototype a wide range of applications.

The EZ-KIT Lite includes an ADSP-BF506F Blackfin processor desktop evaluation board along with an evaluation suite of the VisualDSP++ development and debugging environment, including the C/C++ compiler, assembler, and linker. The evaluation suite of VisualDSP++ is designed to be used with the EZ-KIT Lite only.

Features

- Analog Devices ADSP-BF506F Blackfin processor
- Programmable VDDINT core power: AD5258 TWI digital potentiometer and ADP1715 low dropout linear regulator
- Internal parallel flash memory: 4 MB (2M x 16 bits)
- SPI flash memory: Numonyx M25P16, 16 Mb
- Internal ADC: 2 MSPS, 12-bit, 3-channel SAR analog-to-digital converter, 12 single ended inputs, 6 differential inputs
- Universal asynchronous receiver/transmitter (UART): ADM3202 RS-232 line driver/receiver, DB9 female connector
- LEDs: 5 LEDs: 1 power (green), 1 board reset (red), 3 general purpose (amber)
- Push buttons: 3 push buttons: 1 reset and 2 programmable flags with debounce logic
- Expansion interface II: Next generation of the expansion interface design, provides access to most of the processor signals

Selecting Hardware Development Tools

ADSP-BF518F EZ-KIT Lite From Analog Devices

Part Number: ADZS-BF518F-EZLITE

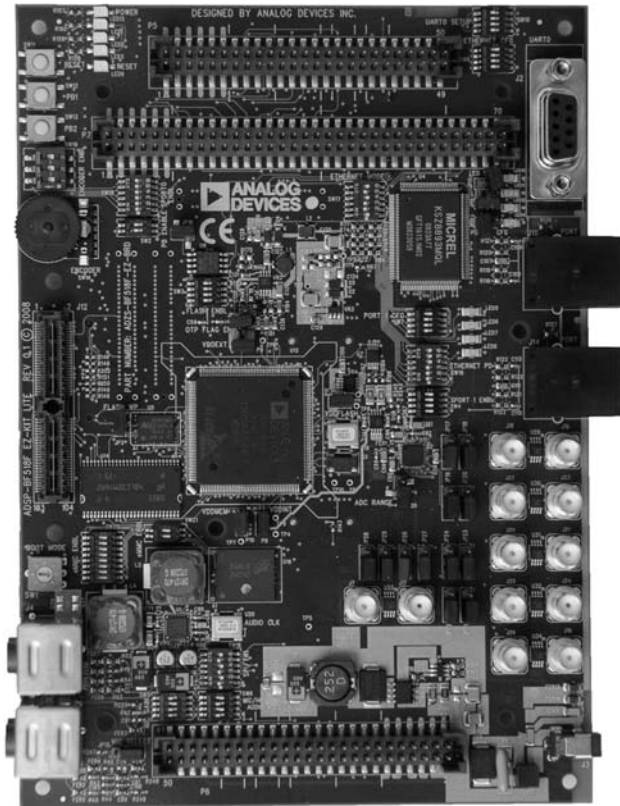

Figure 2-4. ADSP-BF518F EZ-KIT Lite Evaluation System

The ADSP-BF518F EZ-KIT Lite evaluation system, as shown in [Figure 2-4](#), provides developers with a cost-effective method for initial evaluation of the ADSP-BF512/F, BF514/F, BF516/F, BF518/F Blackfin processors via a USB-based, PC-hosted tool set. With this EZ-KIT Lite,

users can learn more about the ADSP-BF518F Blackfin processor hardware and software development, and quickly prototype a wide range of applications.

The EZ-KIT Lite includes an ADSP-BF518F Blackfin processor desktop evaluation board along with an evaluation suite of the VisualDSP++ development and debugging environment, including the C/C++ compiler, assembler, and linker. The evaluation suite of VisualDSP++ is designed to be used with the EZ-KIT Lite only.

The EZ-KIT Lite also comes with a standalone debug agent board that is removable to allow a user to plug in an external emulator.

Features

- 400 MHz, 176 Lead LQFP ADSP-BF518F Blackfin processor
- 64 MB (32M x 16 bits) Micron MT48LC32M16A2TG 3.3 V SDRAM
- 4 MB (2M x 16 bits) ST Micro M29W320DB 3.3 V, FBGA48 flash memory
- 4 MB on-chip SPI 1.8V SPI flash
- ADI SSM2602 CODEC 3.3 V, 12 MHz input audio CODEC
- AD7266, Differential/Single-Ended Input, Dual 2 MSPS, 12 bit 3 Channel A/D converter
- Precision resistors to measure VDDINT, VDDEXT, VDDMEM, VDDFLASH power analysis interface
- Micrel 8893M 3 port MAC/PHY switch ethernet PHY
- 13 LEDs: 1 power (green), 1 board reset (red), 3 general purpose (amber), 8 ethernet (amber)

Selecting Hardware Development Tools

- RTC Battery: 3.0 V Li-ION, CR2430 (270 mAh)
- Connectors: ethernet, SD, EBIU Expansion, Group 1A and 1B Expansion, Group 2A Expansion

ADSP-BF526 EZ-Board From Analog Devices

Part Number: ADZS-BF526-EZBRD

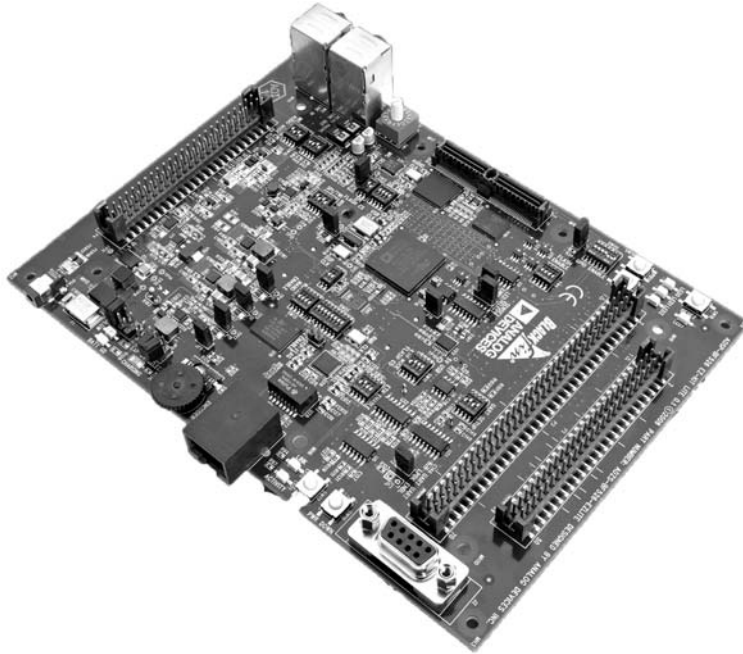

Figure 2-5. ADSP-BF526 EZ-Board

The ADSP-BF526 EZ-Board evaluation system, as shown in [Figure 2-5](#), provides developers with a low-cost platform for initial evaluation of the ADSP-BF522/BF524/BF526 Blackfin processors via an external emulator, standalone debug agent board, or μ CLinux.



This board is not equipped with a JTAG debug interface. To debug, you must have a debug agent board or emulator. The ADSP-BF526 EZ-Board has an expansion interface that allows for modularity with different EZ-Extender boards.

Selecting Hardware Development Tools

This evaluation system includes an ADSP-BF526 Blackfin processor desktop evaluation board and fundamental debugging software to facilitate architecture evaluations via a USB-based PC-hosted tool set. With this board, you can learn more about the ADSP-BF526 Blackfin processor hardware and software development and prototype applications. The EZ-Board provides an evaluation suite of the VisualDSP++ integrated development and debug environment (IDDE) with the C/C++ compiler, advanced plotting tools, statistical profiling, and the VisualDSP++ kernel (VDK). Other features include: assembler, linker, libraries, loader, and splitter. VisualDSP++ offers programmers a powerful programming tool with flexibility that shortens time to market.

Features

- ADSP-BF526: 208-ball BGA, 400 MHz, 17mmX17mm/0.8 pitch
- Mobile SDRAM 1.8 V, 64 MB, 32M x 16, VFBGA 54-ball, Micron MT48H32M16LFCJ-75 SDRAM
- 4 MB (2M x 16), Numonyx M58WR032KB 1.8 V, VFBGA56 flash
- 2 GB 1.8 V, 256 MB x 8, TFBGA63, Numonyx NAND02G-B2C 1.8 V NAND flash
- 4 MB SST 1.8 V, SST25WF040 SPI flash
- ADI SSM2602 1.8 V low power audio codec
- Sense resistors to measure VDDINT, VDDEXT, VDDMEM, SDRAM power analysis interface
- SMSC (RMII) 3.3 V with internal 1.8 V regulator, LAN8700 ethernet PHY
- ADP2291, 1.5A linear charger, single cell LI battery charger
- Lithium ION, 740mAh, Ultralife UBBP005 battery

- Panasonic, Rotary Encoder, 2-Bit Binary, EVQ-WKA001 thumbwheel
- USB OTG, ethernet, HOST, EBIU Expansion, Group 1 Expansion, Group 2 Expansion, Group 3 Expansion connectors
- Benchmarq (TI), I2C interface BQ2750 fuel gauge
- ADM1385 RS-232 line driver/receiver 3.3 V, DB9 female connector UART
- 9 LEDs: 1 board reset (red), 3 general-purpose (amber), 3 battery status, 2 ethernet (amber)
- 5 push buttons w/ debounce logic: 1 reset, 2 programmable flag, 1 wake and 1 power down
- USB OTG, ethernet, Host, EBIU Expansion, Group 1 Expansion, Group 2 Expansion, Group 3 Expansion, land grid array connectors
- JTAG ICE 14-pin header, USB cable, ethernet cable
- Power supply, CE compliant external power supply (US or European)
- μ Clinux distribution CD

ADSP-BF527 EZ-KIT Lite From Analog Devices

Part Number: ADZS-BF527-EZLITE

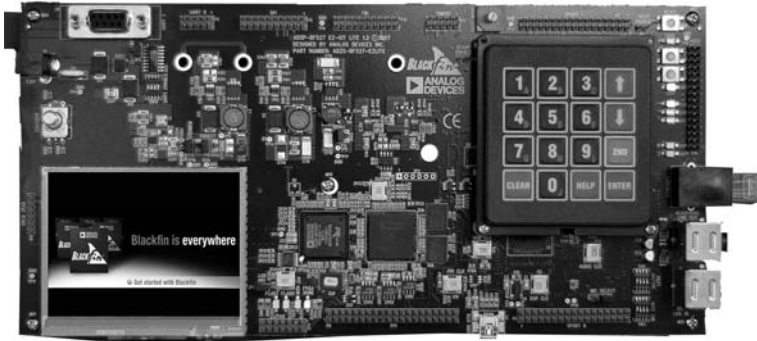

Figure 2-6. ADSP-BF527 EZ-KIT Lite Evaluation System

The ADSP-BF527 EZ-KIT Lite, as shown in [Figure 2-6](#), is a low-cost evaluation platform for the ADSP-BF527 embedded processor, the VisualDSP++ development tools, and associated application software.

This evaluation platform satisfies the needs of portable handheld vertical requirements. All of the STAMP interfaces are fully supported on this EZ-KIT Lite platform.

The evaluation board ships with a landscape, low-power QVGA touch-screen LCD panel. Also included are a set of stereo headphones and the necessary supplemental cables (USB, ethernet, and so on) required to run the VisualDSP++ examples programs.

- ⓘ All versions of ADSP-BF523, ADSP-BF525, and ADSP-BF527 Blackfin processors, which are pin-compatible, have similar memory maps. Software development for any of these devices can be performed on the ADSP-BF527 EZ-KIT Lite evaluation system.

Features

- ADSP-BF527 Blackfin processor
- 64 MB SDRAM (32M x 16 bits)
- ST Micro NAND04 – 4 GB NAND flash memory
- ST Micro M25P16 – 16 MB SPI flash memory
- USB-based debugger interface
- JTAG ICE 14-pin header
- SPORT0 connector
- Evaluation suite of VisualDSP++
- 13 LEDs: 1 power (green), 1 board reset (red), 8 general-purpose (amber), 1 USB monitor (amber), 2 ethernet (amber)
- CE certified
- 3 push buttons with one reset
- 2 programmable flags
- μ Clinux distribution CD

ADSP-BF548 EZ-KIT Lite From Analog Devices

Part Number: ADZS-BF548-EZLITE

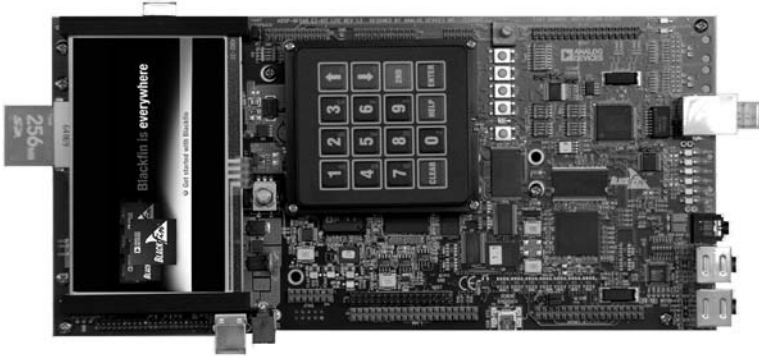

Figure 2-7. ADSP-BF548 EZ-KIT Lite Evaluation System

The ADSP-BF548 EZ-KIT Lite evaluation system, as shown in [Figure 2-7](#), is a low-cost platform for the ADSP-BF548 Blackfin processor. This processor includes an 8x8 keypad interface, optical thumbwheel interface, ATA/ATAPI-6 interface, and an SD/SDIO interface. The ADSP-BF548 EZ-KIT Lite includes a QVGA touch screen LCD and a 40-Gbyte hard drive.

i ADSP-BF542, ADSP-BF544, ADSP-BF547, ADSP-BF548, and ADSP-BF549 Blackfin processors, which are pin-compatible, have similar memory maps. Software development for any of these devices can be performed on the ADSP-BF548 EZ-KIT Lite evaluation system.

Features

- ADSP-BF548 Blackfin processor
- 64 MB SDRAM (8M x 16 bits)
- Flash memory (32 MB burst, 2 Gbytes NAND, 16 Mbit SPI)
- USB-based debugger interface
- JTAG ICE 14-pin header
- SPORT0 connector
- Evaluation suite of VisualDSP++
- 10 LEDs: 1 power (green), 1 board reset (red), 1 USB (red), 6 general-purpose (amber), and 1 USB monitor (amber)
- CE certified
- Hard drive: 40 Gbytes 2.5 inch 5 V drive
- 5 push buttons with one reset
- 4 programmable flags
- μ Clinux distribution CD

Selecting Hardware Development Tools

ADSP-BF538F EZ-KIT Lite From Analog Devices

Part Number: ADZS-BF538F-EZLITE

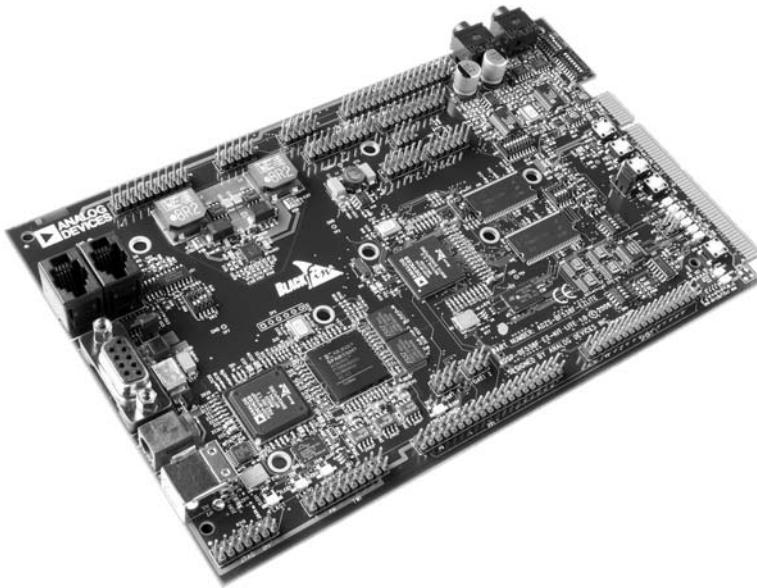

Figure 2-8. ADSP-BF538F EZ-KIT Lite Evaluation System

The ADSP-BF538F EZ-KIT Lite evaluation system, as shown in [Figure 2-8](#), provides developers with a cost-effective method for initial evaluation of ADSP-BF538F Blackfin processors via a USB-based, PC-hosted tool set. With this EZ-KIT Lite, users can learn more about the ADSP-BF538F hardware and software development, and quickly prototype a wide range of applications.

The EZ-KIT Lite includes an ADSP-BF538F Blackfin processor desktop evaluation board along with an evaluation suite of the VisualDSP++ development and debugging environment, including the C/C++ compiler, assembler, and linker. The evaluation suite of VisualDSP++ is designed to be used with the EZ-KIT Lite only.

Features

- Analog Devices ADSP-BF538F Blackfin processor
 - ✓ Core performance up to 600 MHz
 - ✓ External bus performance to 133 MHz
 - ✓ 182-pin mini-BGA package
 - ✓ 25 MHz crystal
- Synchronous dynamic random access memory (SDRAM)
 - ✓ MT48LC32M8 – 64 MB (8M x 8 bits x 4 banks) x 2 chips
- Flash memory
 - ✓ 4MB (2M x 16 bits)
- Analog audio interface
 - ✓ AD1871 96 kHz analog-to-digital codec (ADC)
 - ✓ AD1854 96 kHz digital-to-audio codec (DAC)
 - ✓ 1 input stereo jack
 - ✓ 1 output stereo jack
- Controller Area Network (CAN) interface
 - ✓ Philips TJA1041 high-speed CAN transceiver
- National Instruments Educational Laboratory Virtual Instrumentation Suite (ELVIS) interface
 - ✓ LabVIEW™-based virtual instruments
 - ✓ Multifunction data acquisition device
 - ✓ Bench-top workstation and prototype board



Note that the ELVIS interface is also available on the ADSP-BF537 EZ-KIT Lite.

Selecting Hardware Development Tools

- Universal asynchronous receiver/transmitter (UART)
 - ✓ ADM3202 RS-232 line driver/receiver
 - ✓ DB9 female connector
- LEDs
 - ✓ 10 LEDs: 1 power (green), 1 board reset (red), 1 USB (red), 5 general-purpose (amber), and 1 USB monitor (amber)
- Push buttons
 - ✓ 5 push buttons: 1 reset, 4 programmable flags with debounce logic
- Expansion interface
 - ✓ All processor signals
- Other features
 - ✓ JTAG ICE 14-pin header
 - ✓ μ Clinux distribution CD

ADSP-BF537 EZ-KIT Lite From Analog Devices

Part Number: ADZS-BF537-EZLITE



Figure 2-9. ADSP-BF537 EZ-KIT Lite Evaluation System

The ADSP-BF537 EZ-KIT Lite evaluation system, as shown in [Figure 2-9](#), provides developers with a cost-effective method for initial evaluation of the ADSP-BF537 Blackfin processor. The EZ-KIT Lite includes an ADSP-BF537 Blackfin processor desktop evaluation board and fundamental debugging software to facilitate architecture evaluations via a USB-based, PC-hosted tool set. With this EZ-KIT Lite, users can learn more about ADSP-BF537 Blackfin processor hardware and software development and prototype applications. The ADSP-BF537 EZ-KIT Lite

Selecting Hardware Development Tools

provides an evaluation suite of the VisualDSP++ development environment with the C/C++ compiler, assembler, loader, and linker. All software tools are limited to use with the EZ-KIT Lite.



The ADSP-BF537 EZ-KIT Lite is also used for evaluation of the ADSP-BF536 and ADSP-BF534 Blackfin processors.

Features

- ADSP-BF537 Blackfin processor
- 64 MB SDRAM (8M x 8 bits x 4 banks) x 2 chips
- 4 MB (2M x 16 bits) flash memory
- AD1854 96 kHz digital-to-audio codec (DAC)
- Philips TJA1041 high-speed CAN transceiver
- USB-based debugger interface
- JTAG ICE 14-pin header
- SPORT0 connector
- Evaluation suite of VisualDSP++
- 10 LEDs: 1 power, 1 board reset, 1 USB reset, 1 USB monitor, and 6 general-purpose
- CE certified
- Standalone operation
- 4 programmable flags
- μ Clinux distribution CD

ADSP-BF561 EZ-KIT Lite From Analog Devices

Part Number: ADZS-BF561-EZLITE

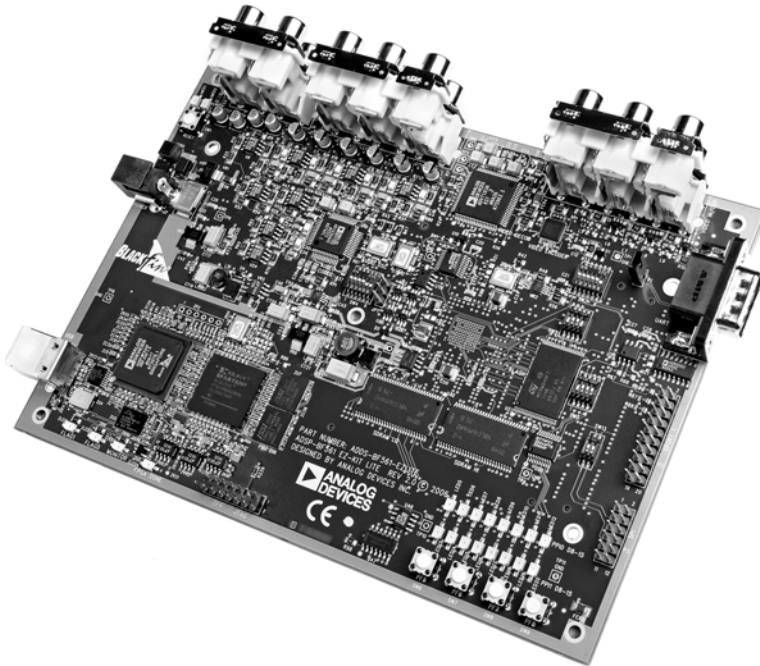

Figure 2-10. ADSP-BF561 EZ-KIT Lite Evaluation System

The ADSP-BF561 EZ-KIT Lite, as shown in [Figure 2-10](#), provides a cost-effective method for initial evaluation of the ADSP-BF561 Blackfin processor for audio and video applications via a USB-based, PC-hosted tool set. Evaluation of analog audio applications is achieved by using the on-board AD1836 multichannel 96 kHz audio codec. By utilizing the on-board ADV7183A advanced 10-bit video decoder and ADV7179 chip-scale NTSC/PAL video encoder, you can evaluate video applications such as simultaneous input and output video processing enabled by the dual-core architecture of the ADSP-BF561 Blackfin processor. Use this

Selecting Hardware Development Tools

development system to learn more about ADSP-BF561 Blackfin processor hardware and software development and to quickly prototype applications.

The EZ-KIT Lite includes an ADSP-BF561 Blackfin processor desktop evaluation board along with an evaluation suite of the VisualDSP++ development and debugging environment with the C/C++ compiler, assembler, loader, and linker. It also includes sample processor application programs, a CE-approved power supply, and a USB cable.

Features

- ADSP-BF561 Blackfin processor
- 64 MB (16M x 16 bits x 2 chips) SDRAM
- 8 MB (4M x 16 bits) flash memory
- AD1836 A – Analog Devices 96 kHz audio codec
- 5 push buttons with debounce logic: 1 reset and 4 programmable flags
- USB-based debugger interface
- JTAG ICE 14-pin header
- SPORT0 connector
- Evaluation suite of VisualDSP++
- 20 LEDs: 1 power (green), 1 board reset (red), 1 USB (red), 16 general-purpose (amber), and 1 USB monitor (amber)
- CE certified
- Standalone operation
- μ Clinux distribution CD

ADSP-BF533 EZ-KIT Lite From Analog Devices

Part Number: ADZS-BF533-EZLITE

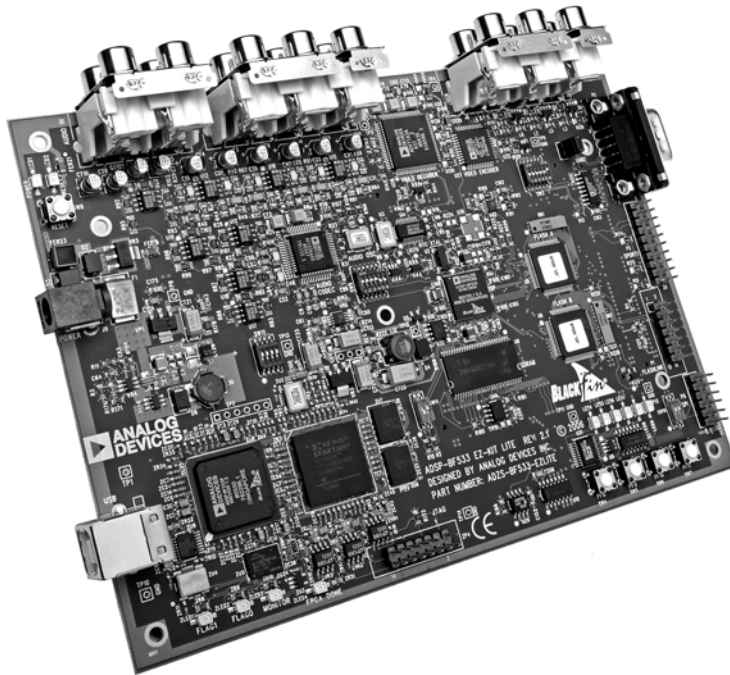

Figure 2-11. ADSP-BF533 EZ-KIT Lite Evaluation System

The ADSP-BF533 EZ-KIT Lite evaluation system, as shown in [Figure 2-11](#), provides developers with a cost-effective method for initial evaluation of the ADSP-BF533 Blackfin processor for a wide range of applications including audio and video processing.

This evaluation system includes an ADSP-BF533 Blackfin processor desktop evaluation board and fundamental debugging software to facilitate architecture evaluations by using a USB-based, PC-hosted tool set. With this EZ-KIT Lite, you can learn more about the ADSP-BF533 Blackfin processor hardware and software development and prototype applications.

Selecting Hardware Development Tools

The EZ-KIT Lite provides an evaluation suite of the VisualDSP++ integrated development and debug environment (IDDE) with the C/C++ compiler, advanced plotting tools, statistical profiling, and the VisualDSP++ kernel (VDK). Other features include: assembler, linker, libraries, loader, and splitter. VisualDSP++ offers programmers a powerful programming tool with flexibility that shortens time to market.

Features

- ADSP-BF533 Blackfin processor
- 32 MB (16M x 16 bits) SDRAM
- 2 MB (512 Kbytes x 16 bits x 2) flash memory
- AD1836 96 kHz audio codec with 4 input and 6 output RCA jacks (24 bits)
- ADV7183 video decoder with 3 input RCA jacks
- ADV7171 video encoder with 3 output RCA jacks
- ADM3202 RS-232 line driver/receiver
- DB9 male connector
- USB-based debugger interface
- JTAG ICE 14-pin header
- SPORT0 connector
- Evaluation suite of VisualDSP++
- 10 LEDs: 1 power, 1 board reset, 1 USB reset, 1 USB monitor, and 6 general-purpose
- 5 push buttons with debounce logic: 1 reset, 4 programmable flags

- Three 90-pin connectors providing PPI, SPI, EBIU, timers 0-2, UART, programmable flags, SPORT0, and SPORT1 expansion interfaces for analyzing and interfacing
- CE certified
- Standalone operation

The ADSP-BF531, ADSP-BF532, and ADSP-BF533 Blackfin processors, which are pin-compatible, have similar memory maps. (The ADSP-BF532 is a memory subset of the ADSP-BF533, and the ADSP-BF531 is a memory subset of the ADSP-BF532.) Software development for any of these devices can be performed on the ADSP-BF533 Blackfin processor. Thus, this EZ-KIT Lite evaluation system may be used for any of these devices.

EZ-KIT Lite Expansion Boards

EZ-KIT Lite expansion boards enhance and extend EZ-KIT Lite features and functionalities. The following EZ-KIT Lite expansion boards are currently available.

Blackfin EZ-Extender

Part Number: ADZS-BF-EZEXT-1

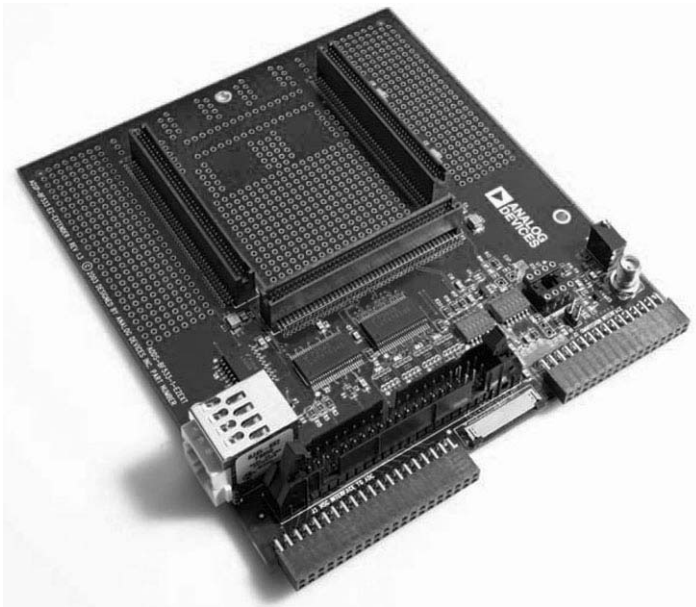

Figure 2-12. Blackfin EZ-Extender

The Blackfin EZ-Extender, as shown in [Figure 2-12](#), is a separately sold assembly that plugs into an ADSP-BF533 EZ-KIT Lite evaluation system's expansion interface.

The board extends the capabilities of the EZ-KIT Lite evaluation system by providing a connection between the parallel peripheral interface (PPI) of the ADSP-BF533 EZ-KIT Lite, an Analog Devices high-speed converter (HSC) evaluation board, an OmniVision camera evaluation board, and an LCD display device. Moreover, the extender broadens the range of EZ-KIT Lite applications by providing surface-mounted (SMT) footprints for breadboard capabilities and access to all pins on the EZ-KIT Lite board's expansion interface.

The Blackfin EZ-Extender features include:

- OmniVision camera interface
- High-speed converter (HSC) evaluation board interface
- LCD interface
- SMT footprint area

Selecting Hardware Development Tools

Blackfin USB-LAN EZ-Extender Board

Part Number: ADZS-USBLAN-EZEXT

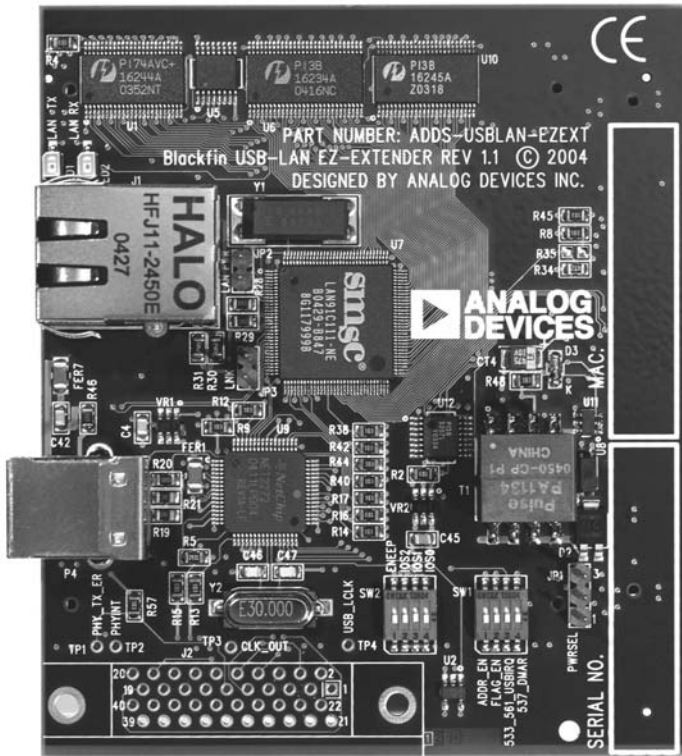

Figure 2-13. Blackfin USB-LAN EZ-Extender Board

The Blackfin USB-LAN EZ-Extender board, as shown in [Figure 2-13](#), provides a solution for users to evaluate different peripherals on ADSP-BF533 and ADSP-BF537 Blackfin processors. The EZ-Extender connects to ADSP-BF533 EZ-KIT Lite or ADSP-BF537 EZ-KIT Lite evaluation systems.

The card includes peripherals that support USB 2.0 and ethernet. The card also supports USB bus power and includes a μ Clinux distribution CD. The components for bus power on the ADZS-USBLAN-EZEXT card are not populated during shipping. For bus power to work, the card must be connected to an EZ-KIT Lite evaluation system that also supports USB bus power. Currently, the ADSP-BF561 EZ-KIT Lite and the ADSP-BF533 EZ-KIT Lite do not support USB bus power.

The Blackfin USB-LAN EZ-Extender card is a small (approximately 4.5” x 3.5”) printed circuit board that connects directly to an EZ-KIT Lite board. The card includes the hardware, USB cable, USB software, and ethernet software to begin evaluating the card immediately. Power is derived by plugging the card into the EZ-KIT Lite board.

Blackfin FPGA EZ-Extender Daughter Board

Part Number: ADZS-BFFPGA-EZEXT

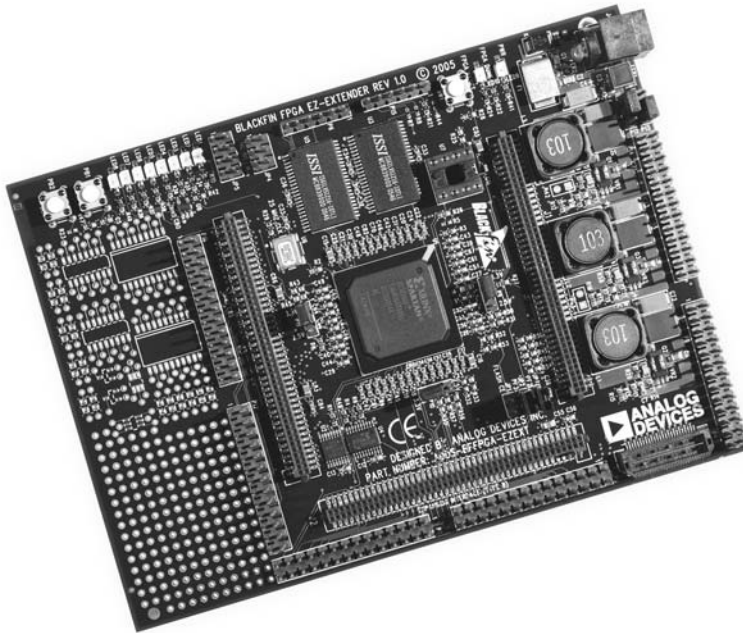

Figure 2-14. Blackfin FPGA EZ-Extender Daughter Board

The Blackfin FPGA EZ-Extender daughter board, as shown in [Figure 2-14](#), aids the design and prototype phases of Blackfin ADSP-BF533, ADSP-BF537, or ADSP-BF561 processor-targeted applications. The EZ-Extender connects to the ADSP-BF527 EZ-KIT Lite, ADSP-BF533 EZ-KIT Lite, ADSP-BF537 EZ-KIT Lite, and the ADSP-BF548 EZ-KIT Lite. The board extends the evaluation system by providing a Xilinx FPGA with external memory, IDC connectors for off-board connections, and a small breadboard area. Applications and information about the use and connection of the various interfaces on the Blackfin FPGA EZ-Extender are available from Analog Devices.

The Blackfin FPGA EZ-Extender features:

- μ Clinux distribution CD
- Xilinx Spartan III Field-Programmable Gate Array
 - ✓ XC3S1000
 - ✓ FG456 package
- Asynchronous static random access memory (SRAM)
 - ✓ Directly connected to FPGA
 - ✓ 2 MB (512K x 16 bits x 2 chips)
 - ✓ TSOP44 package
- 25 MHz oscillator
 - ✓ Directly connected to global clock of FPGA
- Socket for auxiliary oscillator
 - ✓ Directly connected to global clock of FPGA
- IDC through-hole connectors
 - ✓ Allows quick access to Blackfin and FPGA pins for probing
 - ✓ Allows access to Blackfin and FPGA pins for off-board connections
- High-speed connector
 - ✓ Allows access to Blackfin and FPGA pins for high-speed application
- Expansion interface connectors
 - ✓ Allows access to Analog Devices family of Blackfin EZ-Extenders

Selecting Hardware Development Tools

- 2 push buttons
 - ✓ Directly connected to FPGA
 - ✓ 1 with external debounce circuitry and 1 without
- 8 flag LEDs
 - ✓ Directly connected to FPGA

Blackfin Landscape LCD EZ-Extender Daughter Board

Part Number: ADZS-BFLLCD-EZEXT

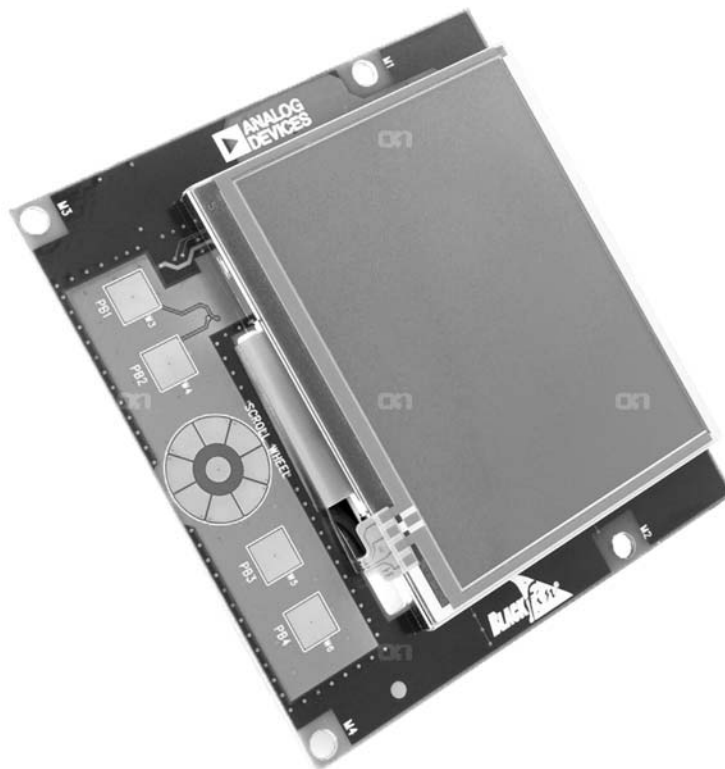

Figure 2-15. Blackfin Landscape LCD EZ-Extender Daughter Board

The Blackfin Landscape LCD EZ-Extender daughter board, as shown in [Figure 2-15](#), extends the capabilities of the EZ-KIT Lite by allowing you to connect to a landscape LCD on ADSP-BF52x, ADSP-BF53x, and ADSP-BF54x Blackfin processors. The Landscape LCD EZ-Extender connects to the ADSP-BF526 EZ-KIT Lite, ADSP-BF537 EZ-KIT Lite, ADSP-BF538 EZ-KIT Lite, and the ADSP-BF548 EZ-KIT Lite evaluation systems.

Selecting Hardware Development Tools

The Landscape LCD EZ-Extender supports a 3.5" landscape QVGA (320 x 240) display from SHARP. This LCD display can operate at VDDIO from 1.6 V to 3.6 V, allowing this LCD to be a good fit for normal use as well as for low-power applications. The Analog Devices AD7879 is used as the low-cost touchscreen controller for the LCD display. The AD7879 on the Landscape LCD EZ-Extender is a small 16-pin LFCSP package and is ideal for low-power applications.

The Landscape LCD EZ-Extender also has an Analog Devices AD7147-1 programmable controller for capacitive touch sensors. The capacitive controller interfaces to the Blackfin processor via a simple TWI (two-wire interface). The other end of the controller interfaces to external capacitance sensors, implementing functions such as capacitive buttons and scroll wheel.

The following lists Blackfin Landscape LCD EZ-Extender features.

- LCD display with touch capabilities:
 - ✓ Sharp LQ035Q1DH02 3.5-inch LCD with resistive touch
 - ✓ 320 (horizontal) x 240 (vertical) landscape
 - ✓ 1.8 V to 3.6 V I/O operation
 - ✓ LCD backlight
- LCD touch controller:
 - ✓ Analog Devices AD7879 touchscreen controller
 - ✓ 1.8 V to 3.3 V I/O operation
- Capacitive touch controller:
 - ✓ Analog Devices AD7147 capacitive touch controller
 - ✓ 4 push buttons and 1 scroll wheel
 - ✓ 1.8 V to 3.3 V I/O operation

- No power supply required: power is derived from the EZ-KIT Lite/EZ-Board
- μ Clinux distribution CD
- CE certified
- Dimensions: 3.75 in. (height) x 3.5 in. (width)

Selecting Hardware Development Tools

Blackfin Audio EZ-Extender Daughter Board

Part Number: ADZS-BFAUDIO-EZEXT

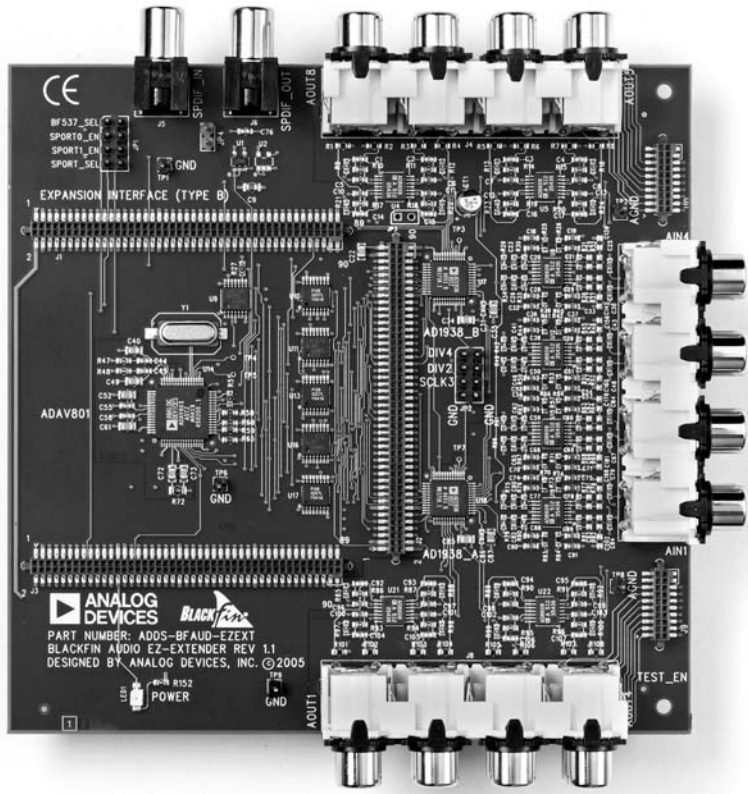

Figure 2-16. Audio EZ-Extender Daughter Board

The Blackfin Audio EZ-Extender daughter board, as shown in [Figure 2-16](#), aids the design and prototype phases of ADSP-BF533 and ADSP-BF537 Blackfin processor-targeted audio applications. The Audio EZ-Extender connects to the ADSP-BF533 EZ-KIT Lite and the ADSP-BF537 EZ-KIT Lite evaluation systems. The board extends the capabilities of the evaluation system by providing a connection to the

audio codecs, including two analog audio codecs and one dual analog/digital audio codec with an interface to digital Sony Philips Digital Interface (SPDIF) audio. Applications and information about the use and connection of the various interfaces on the Blackfin Audio EZ-Extender are available from Analog Devices.

The following is a list of the Blackfin Audio EZ-Extender board interfaces.

- Analog audio interface
 - ✓ 2 AD1938 – Analog Devices 192 kHz audio codecs
 - ✓ 4 stereo analog audio inputs via RCA jacks
 - ✓ 8 stereo analog audio outputs via RCA jacks
- Digital audio interface
 - ✓ 1 ADAV801 – Analog Devices SPDIF transceiver with sample rate converter
 - ✓ 1 SPDIF input via a RCA jack
 - ✓ 1 SPDIF output via a RCA jack
- Expansion interface on both sides of the board for stacking other EZ-Extender boards

Blackfin A-V EZ-Extender Board

Part Number: ADZS-BFAV-EZEXT

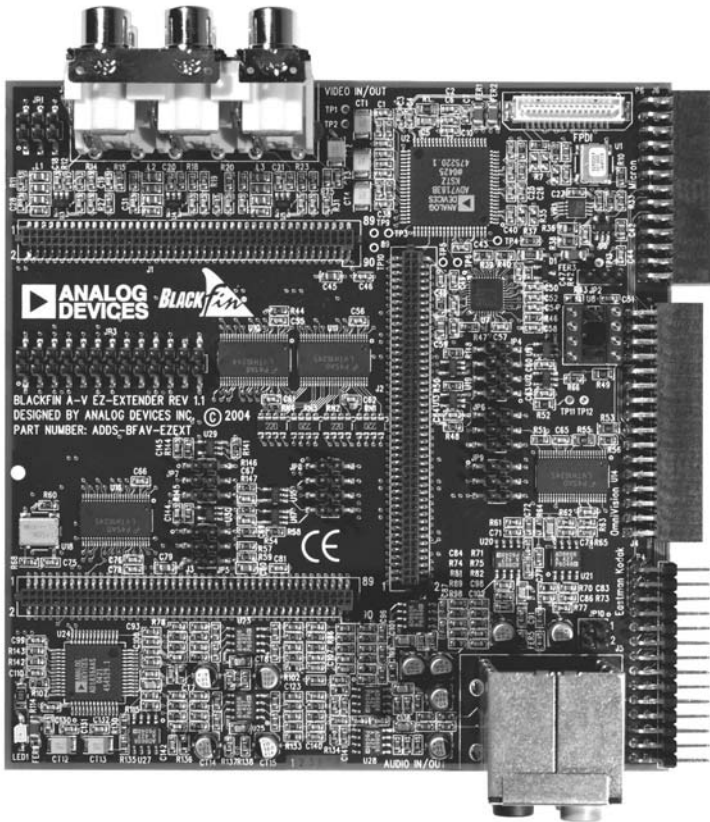

Figure 2-17. A-V EZ-Extender Board

The Blackfin A-V EZ-Extender board, as shown in [Figure 2-17](#), provides a solution for users to evaluate audio and video peripherals and CMOS image sensors for the ADSP-BF533, ADSP-BF537, ADSP-BF538F, and

ADSP-BF561 Blackfin processors. The A-V EZ-Extender connects to the ADSP-BF527 EZ-KIT Lite, ADSP-BF533 EZ-KIT Lite, ADSP-BF537 EZ-KIT Lite, and the ADSP-BF548 EZ-KIT Lite.

The card includes peripherals that support video encoders, video decoders, and multichannel audio codecs. The card also supports connectivity to three different CMOS image sensors: Micron, Omnivision, and Kodak. The A-V EZ-Extender card is a compact board that connects directly to an EZ-KIT Lite board.

Blackfin Bluetooth EZ-Extender Daughter Board

Part Number: ADZS-BFBLUET-EZEXT

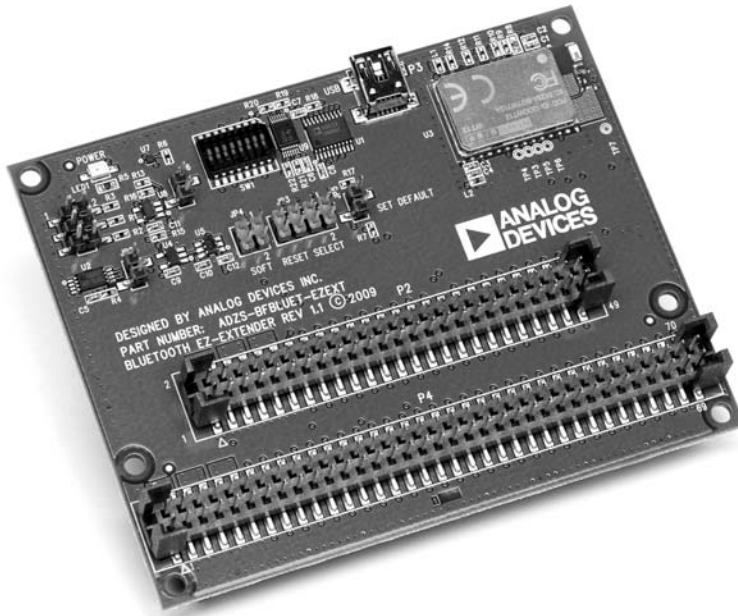

Figure 2-18. Blackfin Bluetooth EZ-Extender Daughter Board

The Blackfin Bluetooth EZ-Extender daughter board, as shown in [Figure 2-18](#), plugs onto the compatible EZ-Board, EZ-KIT Lites, and STAMP board. The Blackfin Bluetooth EZ-Extender extends the capabilities of the Blackfin boards by providing a connection to a Bluetooth module. It also isolates the low-level configuration and communication tasks of integrating Bluetooth and radio frequency (RF) wireless technologies in your Blackfin board designs.

The Bluetooth EZ-Extender is designed to be used in conjunction with an EZ-Board, EZ-KIT Lite or STAMP board running the open source Linux operating system (OS). For more information about running Linux OS on a Blackfin processor, go to:

<http://blackfin.uclinux.org/gf/>

Features

- Bluegiga WT12 module based on CSR's BC04 chipset
- Bluetooth radio antenna, fully implemented protocol stack, HCI and iWRAP firmware
- Full speed USB interface for communicating with other compatible digital devices. The module acts as a USB peripheral.
- Standard UART interface for communicating with other serial devices. Supports hardware flow control.
- Expansion interface. Allows other EZ-Extenders to be stacked.
- Compatible boards: BF518 and BF526 EZ-Board and EZ-KIT Lites, BF537 and BF548 EZ-KIT Lites and BF537 STAMP board

System Requirements

- Linux kernel development host
- 512 MB RAM and 2 GB available hard disk space

ADSP-BF537 STAMP Board Support Package (BSP)

Part Number: ADZS-BF537-STAMP

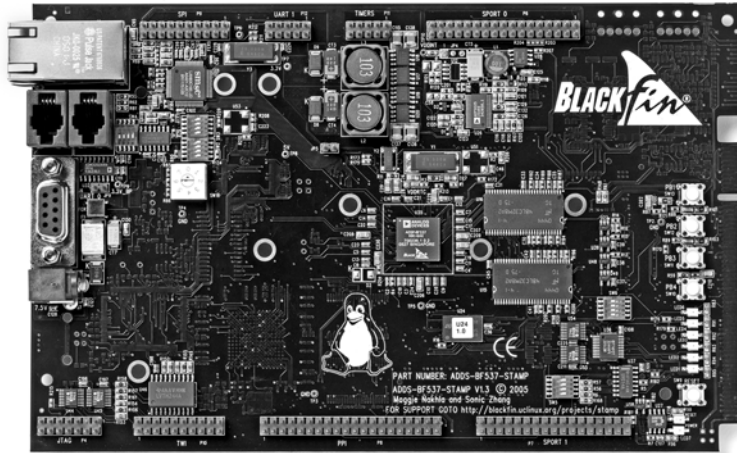

Figure 2-19. ADSP-BF537 STAMP Board

The ADSP-BF537 STAMP μ Clinux kernel board support package, as shown in [Figure 2-19](#), provides a cost-effective environment to develop embedded systems around ADSP-BF537 Blackfin processors. The STAMP board connects to the ADSP-BF537 EZ-KIT Lite evaluation system. The STAMP board is specifically designed to support the development and porting of open source μ Clinux applications and includes the full complement of memory along with serial and network interfaces. A variety of available daughterboards plug into this board, adding interface functions such as audio, video, and analog input or output.

i This product is not available for direct purchase from Analog Devices. For pricing, availability, and purchase information, contact your local Analog Devices distributor.

Besides an ADSP-BF537 500 MHz Blackfin processor, the board includes:

- 64 MB SDRAM (64M x 16 bits)
- 4 MB flash memory
- Integrated ethernet MAC/PHY
- RS-232 serial interface
- I/O connectors for these Blackfin peripherals: PPI, SPORT0 and SPORT1, SPI, timers, IrDA, and two-wire interface
- JTAG interface for debug and flash programming
- 3 LEDs and 3 push buttons

Together with the ADSP-BF537 STAMP development board, the package includes a recent copy of the open source development tools (GCC 4.x) and the μ Clinux 2.6.x kernel. It also includes a CD with documentation and the board schematics, Gerbers, and layout files. The latest version of all the tools can be found on the <http://blackfin.uclinux.org/> Web site. This Web site also hosts open source application projects based on the STAMP board and daughterboards (such as a networked audio media node), a networked oscilloscope, and a Blackfin XMAME game console.

Blackfin/SHARC USB EZ-Extender

Part Number: ADZS-BFSHUSB-EZEXT

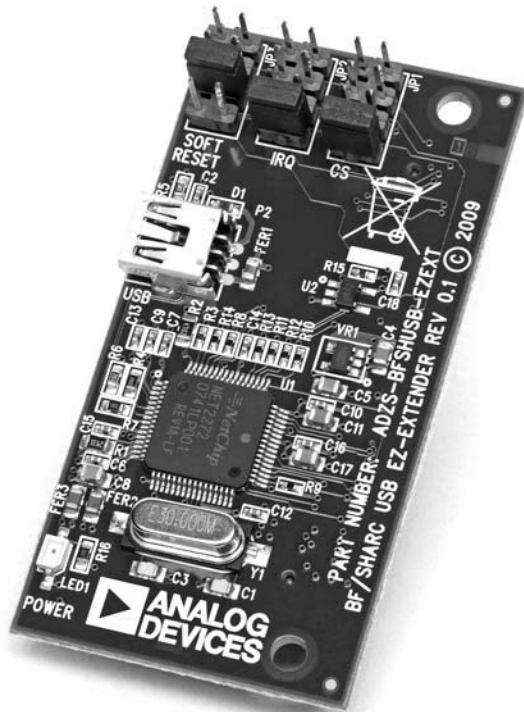

Figure 2-20. Blackfin/SHARC USB EZ-Extender

The Blackfin/SHARC USB EZ-Extender, as shown in [Figure 2-20](#), plugs onto the expansion interface of the ADSP-BF518F, ADSP-BF526, and ADSP-21469 EZ-Board and EZ-KIT Lite's. The EZ-Extender aids the design and prototyping phases of the processor-targeted applications and

extends the capabilities of the evaluation system by providing a connection between the asynchronous memory bus of the Blackfin/SHARC processor and a USB 2.0 device.

Features

- USB 2.0 interface
- USB driver and application code
- CE-certified
- PLX Technology NET2272 device

System Requirements

- Windows 2000 SP4, Windows XP SP2 or Windows Vista Business/ Enterprise/ Ultimate editions
- Intel Pentium processor (x86 compatible), 1 GHz or faster
- 512 MB RAM and 2 GB available hard disk space
- VisualDSP++ 5.0 Update 7

Standalone Debug Agent Board

Part Number: ADZS-DBGAGENT-BRD

The Standalone Debug Agent board, as shown in [Figure 2-21](#), provides a modular low-cost emulation solution for EZ-Boards as well as evaluation boards designed by third parties. The Standalone Debug Agent is similar to the debug agent that is on existing EZ-KIT Lite evaluation systems, but it has the flexibility to be moved from one board to another.

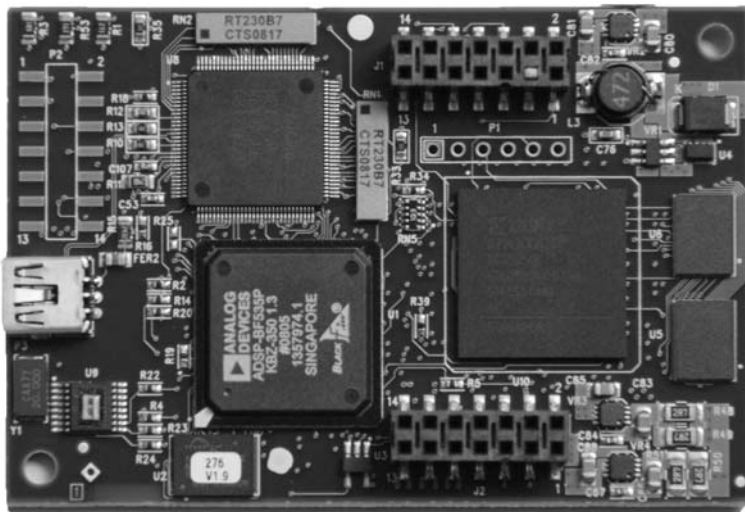

Figure 2-21. Standalone Debug Agent Board

The Standalone Debug Agent works only on EZ-Boards or approved third-party boards.

JTAG Emulators

JTAG (Joint Test Action Group) is defined by the IEEE 1149.1 standard for a test access port for testing electronic devices. This standard defines a method for serially scanning the I/O status of each pin on the device as well as controlling internal operation of the device.

Boundary-scan testing was developed in the mid 1980s as the JTAG interface to solve physical access problems on PCBs caused by increasingly crowded assemblies due to novel packaging technologies. Boundary-scan embeds test circuitry at chip level to form a complete board-level test protocol. With boundary-scan—industry standard IEEE 1149.1 since 1990—you can access the most complex assemblies for testing, debugging, in-system device programming, and diagnosing hardware problems.

Blackfin processors are equipped with a JTAG port and thus support the IEEE 1149.1 standard for system test.

Through the JTAG port, you can run and halt the processor remotely. The internal and external processor memory can be read or written, and breakpoints can be set.

Most development boards include some built-in JTAG emulation circuitry. Your own hardware, most likely, does not contain this circuitry.

Selecting Hardware Development Tools

High-Performance USB 2.0 JTAG Emulator

Part Number: ADZS-HPUSB-ICE



Figure 2-22. High-Performance USB 2.0 JTAG Emulator

The Analog Devices high-speed, high-performance, universal serial bus-based emulator (HP-USB), as shown in [Figure 2-22](#), provides a portable, non-intrusive, target-based debugging solution for Analog Devices JTAG processors.

These easy-to-use USB-based emulators perform a wide range of emulation functions, including single-step and full-speed execution with predefined breakpoints, and viewing and/or altering of register and

memory contents. With the ability to automatically detect and support multiple I/O voltages, the HP-USB emulator enables you to communicate with all of the Analog Devices JTAG processors using a full-speed USB 1.0 or high-speed USB 2.0 port on the host PC.

Applications and data can be tested and transferred easily (and rapidly, when the HP-USB emulator is connected to a high-speed USB 2.0 port on your host PC) between the emulators and the separately available VisualDSP++ development and debugging environment.

The plug-and-play architecture of USB allows the emulators to be detected automatically and configured by the host operating system. It can also be connected to (and disconnected from) the host without opening the PC or turning off the power to the PC. A 3-meter (9-foot) cable is included to connect the emulators to the host PC, providing abundant accessibility.

Features

- High-speed USB 2.0 (backward compatible with full-speed USB 1.0) interface and connector
- JTAG clock operation from 10 MHz to 50 MHz
- Support for all Analog Devices JTAG processors
- Multiple processor I/O voltage support with automatic detection
- 1.8 V, 2.5 V, and 3.3 V compliant and tolerant

Selecting Hardware Development Tools

- 5 V tolerant and 3.3 V compliant for 5 V processors
- Multiprocessor support
- 14-pin JTAG connector
- 3-meter USB cable for difficult-to-reach targets

USB-Based JTAG Emulator

Part Number: ADZS-USB-ICE



Figure 2-23. USB-Based 1.1 JTAG Emulator

The cost-effective universal serial bus (USB)-based 1.1 JTAG emulator, as shown in [Figure 2-23](#), from Analog Devices provides a portable, non-intrusive, target-based debugging solution for Analog Devices JTAG processors.

This USB-based emulator performs a wide range of emulation functions, including single-step and full-speed execution with predefined break-points, and viewing and/or altering of register and memory contents.

Selecting Hardware Development Tools

With the ability to automatically detect and support multiple I/O voltages, the USB emulator enables users to communicate with all of the Analog Devices JTAG processors using a USB 1.0 or high-speed USB 2.0 port on the host PC. Applications and data can easily be tested and transferred between the emulator and the separately available VisualDSP++ development and debugging environment.

The plug-and-play architecture of USB allows the emulators to be detected automatically and configured by the host operating system. The USB can also be connected to (and disconnected from) the host without opening the PC or turning off the power to the PC. A 3-meter (9-foot) cable is included to connect the emulators to the host PC, providing abundant accessibility.

Features

- Full-speed USB 1.1 compliant (forward compatible with high-speed USB 2.0 interface and connector)
- Support for all Analog Device JTAG processors
- Multiple processor I/O voltage support with automatic detection
- 1.8 V, 2.5 V, and 3.3 V compliant and tolerant
- 5 V tolerant and 3.3 V compliant for 5 V processors
- Multiprocessor support
- 14-pin JTAG connector
- 3-meter USB cable for difficult-to-reach targets

Analog Devices Blackfin Emulator

Part Number: ADZS-ICE-100B

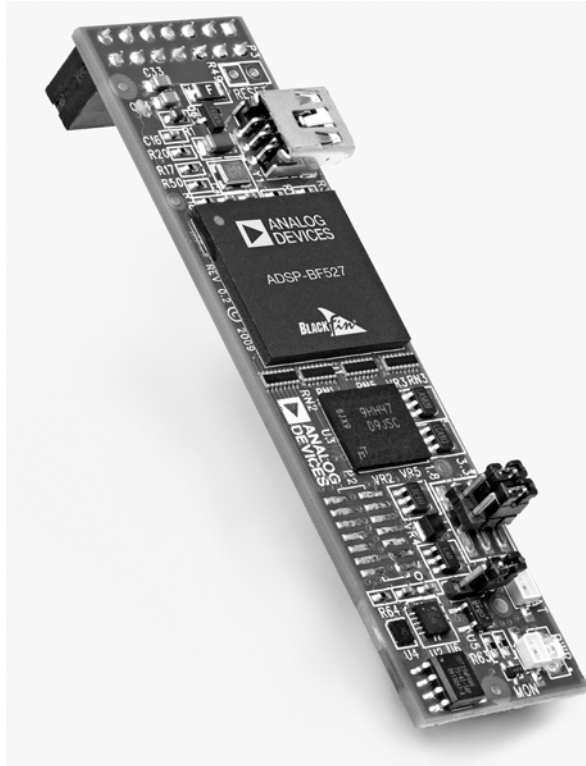

Figure 2-24. Analog Devices Blackfin Emulator

Analog Devices Blackfin emulator, as shown in [Figure 2-24](#), is an easy, portable, nonintrusive, target-based debugging solution. The emulator performs a wide range of emulation functions, including single-step and full-speed execution with predefined breakpoints, and viewing and/or altering of register and memory contents.

Selecting Hardware Development Tools

The Blackfin emulator enables users to communicate with Analog Devices Blackfin processors using a high speed USB 2.0 port on the host PC. Applications and data can easily and rapidly be tested and transferred between the emulator and the separately available VisualDSP++ development and debugging environment (sold separately).

The plug-and-play architecture of USB allows the emulators to be automatically detected and configured by the host operating system. It can also be connected to and disconnected from the host without opening the PC or turning off the power to the PC.

The Blackfin emulator is also bus powered so users no longer need to have an extra power supply to power the emulator, making it easier for busy users.

Features

- 5 MHz JTAG TCLK frequency
- Support for ADI Blackfin processors only
- USB 2.0 interface enabling download speeds of up to 255 KB per second
- 1.8 V, 2.5 V, and 3.3 V compliant and tolerant
- Multiprocessor support
- IEEE 1149.1 14-pin JTAG connector
- PlugFest certified USB bus-powered design
- CE-certified
- ROHS compliant
- Solder points for attaching a wire to reset the target board

System Requirements

- Windows 2000 SP4, Windows XP SP2 or Windows Vista Business/ Enterprise/ Ultimate editions
- Intel Pentium® processor (x86 compatible), 1 GHz or faster
- 512 MB RAM and 2 GB available hard disk space
- VisualDSP++ 5.0 Update 7

Third-Party Boards

PHYTEC phyCORE-BF537 SBC

Ordering Information: See below

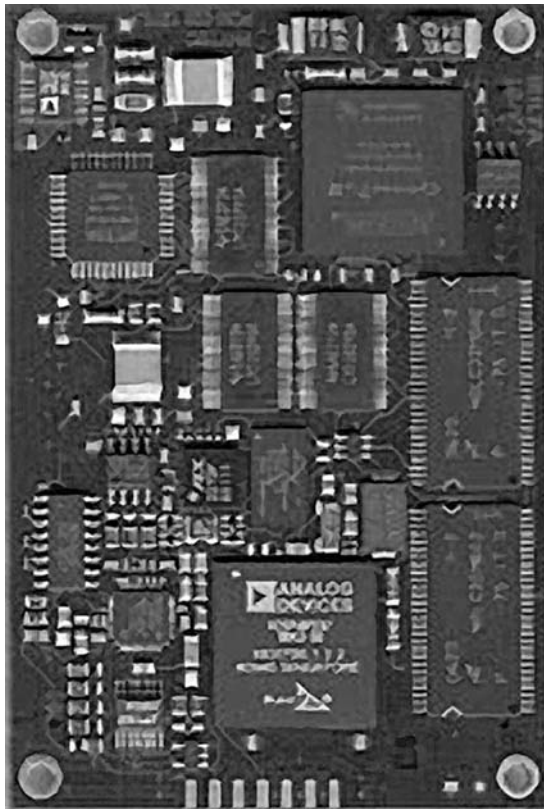

Figure 2-25. PHYTEC phyCORE Single-Board Computer

The PHYTEC phyCORE-BF537, as shown in [Figure 2-25](#), is an insert-ready, single-board-computer (SBC) subassembly in miniature dimensions, populated with an Analog Devices ADSP-BF537 Blackfin processor. Integrated chip peripherals include: 10/100 ethernet, CAN, PPI and TWI, SPI, UART interfaces, timers, and an RTC.

All applicable data/address lines and signals extend from the underlying logic devices on the phyCORE SBC to two high-density Molex SMT pin header connectors (pin width is 0.635 mm/25 mil) lining the circuit board edges. This enables the phyCORE-BF537 to be plugged like a “big chip” into target hardware.

Primary interfaces include a CAN bus and dual RS-232, as well as an SMSC LAN8700I 10/100BaseT ethernet PHY and a PLX NET2272 USB transceiver.

The VisualDSP++ integrated development and debugging environment (IDDE) enables easy generation of code and on-board download of user programs to the phyCORE-BF537 target hardware when mounted on the phyCORE-BF537 carrier board.

Features

- Analog Devices ADSP-BF537 Blackfin processor
- 500 MHz core frequency with up to 1,000 MMACs
- Memory management unit (MMU)
- Memory and DMA controllers
- CAN controller
- 10/100 Mbit ethernet MAC
- 10/100 Mbit ethernet PHY
- High-speed USB 2.0 device controller

Selecting Hardware Development Tools

- PPI supporting ITU-R 656 video data formats
- I²C / 2x I²S
- SPI
- 2 UARTS (RS-232 or IrDA)
- RTC and watchdog timer
- 8-channel / 12-bit (200 kSPS [kilo samples per second]) ADC
- Altera FPGA device (max 8256 logic elements)
- Memory configuration:
 - 132 Kbytes internal memory
 - SDRAM: 16 to 128 MB
 - NOR-flash: 1 to 4 MB
 - I²C EEPROM: 32 K
- JTAG interface
- Single supply 3.3 V with on-board power management
- Module connector: 0.635 mm pitch, 2x 200-pin Molex
- Dimensions: 59 mm x 84 mm
- Extended temperature range (-20° to +85°C)

Rapid Development Kits

Each kit contains an SBC module mounted on an applicable carrier board that features hardware needed for immediate start-up of the module, as well as external break-out of applicable signals from the SBC. The

included PHYTEC Spectrum CD-ROM provides complete electronic documentation, demo programs, and evaluation software development tools.

This PHYTEC rapid development kit provides the necessary ingredients with which to jump-start an embedded design, reduce time to market, and move a concept to a prototype and then to finished product.

For ordering information, please visit PHYTEC at:

<http://www.phytec.com/>

Selecting the Right Combination of Tools

Knowing which tools to use is critical to ensuring a quick development cycle. There are many options for software and hardware development tools. Two of the most common scenarios described in this section contain circumstances encountered by other developers along with recommended solutions. Your needs may be similar to one of the following scenarios.

Scenario 1

Question. *We are a small design house with one software engineer and one hardware engineer for this project. We cannot afford a substantial initial investment in tools. What do you recommend?*

Answer. Purchase an ADSP-BF533 EZ-KIT Lite evaluation system (p/n: ADZS-BF533-EZLITE).

This hardware platform allows you to begin software development. By interfacing components to the board's expansion headers, the platform can serve as the basis for a hardware prototype. The EZ-KIT Lite evaluation system includes VisualDSP++, but the software license restricts various capabilities (debug agent connectivity only and reduced program size allowance).

Obtain a test drive serial number on the Analog Devices Web site at:

<http://www.analog.com/testdrive>

When the license expires, consider purchasing a full seat of VisualDSP++ (p/n: VDSP-BLKFN-PC-FULL).

After you have finished constructing your hardware, purchase a low-cost USB emulator (p/n: ADZS-USB-ICE) from Analog Devices.

Scenario 2

Question. *We have a team of five software engineers who are developing code for the Blackfin processor, but no more than three are likely to be using the tools at any given time. How do we handle licensing? Does each engineer need a license?*

Answer. A floating license may be right for you. VisualDSP++ may be installed on many machines. A developer checks out a floating license from a license server onto any machine. With three floating licenses, up to three people can use VisualDSP++ at the same time. A strong network connection to the floating license server is recommended.

Order a floating license (p/n: VDSP-BLKFN-PCFLOAT).

Selecting the Right Combination of Tools

3 SUPPORT OPTIONS

As new information, such as data sheets, manuals, online Help, training, Web content, or automatic e-mail notifications are prepared/revised, Analog Devices makes them available to its customers and other interested parties. This chapter addresses the support options available for users during the evaluation process and after you have purchased a Blackfin processor.

This chapter lists the various types of support available to users and prospective users of Blackfin products.

Available Support

The Blackfin processor architecture provides many advanced features. As next-generation processors, these parts are becoming increasingly complex. With that in mind, Analog Devices provides a wide variety of support options in the form of online information, as well as in training. This wealth of information is available to aid evaluators of software/hardware solutions (at the beginning of the evaluation process), design engineers (while developing a system), or support engineers, while resolving compatibility and usability issues (after product release).

This chapter highlights some support, information, and training options available to Analog Devices users at any stage of development.

Available Support

Since information about Analog Devices products changes and increases rapidly, Analog Devices makes this information readily available and encourages you to keep up to date with new developments, especially with our online options.

Analog Devices Web Site

Your first point of reference for the most recent information is always the Analog Devices Web site. The following kinds of information are available:

- [“Processor and Tools Selection Information”](#)
- [“Getting Started Information”](#)
- [“Applications Notes, EE-Notes, and Other Articles”](#)
- [“Communities-Related Information”](#)
- [“Platform-Related Information”](#)

Visit the Blackfin processor home page at:

<http://www.analog.com/blackfin>

The Analog Devices Embedded Processing and DSP page, which offers access to other processor families, is located at:

<http://www.analog.com/processors>

To visit the knowledge base, use your browser to access:

<http://www.analog.com/processors/knowledgebase>

This information is available to all classes of users, Analog Devices customers, and interested parties.

Processor and Tools Selection Information

For processor-specific information start at the Web site's Blackfin processor page (<http://www.analog.com/blackfin>), and then check Blackfin processor offerings with regards to package, speed, or temperature specifications. Links provide access to additional processor selection information (such as peripherals and memory), tools selection information, and other materials.

Getting Started Information

The Blackfin processor page (<http://www.analog.com/blackfin>) provides links under the heading “Getting Started” that instruct you about Blackfin processor architecture and targeted applications. To find out about the processor's core and peripherals, refer to this Web site topic at the Analog Devices Web site. You may also want to check the benchmark data available from independent testers. (See “[Benchmarks Against Other Processors](#)” on page 1-30.) A link to training and events provides an up to date list of local training seminars and upcoming events where you can learn more about Blackfin processor products.

Applications Notes, EE-Notes, and Other Articles

Some of the most useful documents available are EE-Notes (engineer-to-engineer notes), sometimes called application notes. These documents provide detailed technical information about using Blackfin processors. Many of these documents include a .zip file with example code. These materials are available by download from the Analog Devices Web site.

These documents supplement the standard documentation for processors and tools. EE-Notes focus on a very narrow or specific topic. Articles are grouped under the headings “Processor-Specific”, “Tools-Specific”, and “Application Hints”. Note that you can also use VisualDSP++ Help to search, locate, and view this collection of articles, as well as the entire list of EE-Notes.

Available Support

Additional links are provided to recent articles, many of which have been featured in trade magazines. Please point your browser to the technical library:

http://www.analog.com/processors/technical_library

Communities-Related Information

For information about application-specific development types, refer to the “Communities” topic at the Blackfin processor Web site. Here you can find information about a particular application theme, such as automotive telematics, or video/imaging. Visit the following sites:

<http://blackfin.org/>

<http://blackfin.uclinux.org/>

Visual Learning and Development (VLD) - On-Demand Video Tutorials

The Analog Devices Web site offers free on-demand video tutorials. Subjects include:

- Blackfin core architecture
- Basics of building a Blackfin application
- Interfacing Blackfin processors with audio and video peripherals
- Introduction to VDK
- Introduction to VisualDSP++ tools
- Multimedia starter kit
- Lockbox secure technology on Blackfin processors
- Blackfin optimizations for performance and power consumption

- Blackfin device drivers
- Blackfin system services
- Introduction to the National Instruments LabVIEW embedded module for Blackfin processors
- Rapid development of a Blackfin-based video application
- Performance tuning on the Blackfin processor
- Programming and optimizing C code on Blackfin processors

Viewing these Blackfin online learning and development (BOLD) video tutorials requires a free one-time registration. Visit <http://www.analog.com> and search for online videos.

Platform-Related Information

When information about the Blackfin processor and its use with other hardware or software solutions becomes available, we refer to that as “Platform-Related Information.” Refer to the “Platform-Related” topic for this information.

Workshops and Seminars

The most efficient way to learn about the Blackfin processor architecture is by attending a 3½-day (or 1-day) Blackfin seminar. A Blackfin seminar provides a mixture of lectures and demonstrations. The 3½-day workshop provides hands-on exercises and serves as an excellent starting point for both hardware and software development.

However, a variety of training options are available in both online and in a classroom setting. For users who prefer live training sessions, a variety of venues is available.

Available Support

Blackfin Processor Workshops

Blackfin processor workshops are designed to develop a strong working knowledge of Analog Devices processors through lecture and hands-on exercises in a classroom setting.

These practical courses teach how to use the latest software development tools. First, the core elements of the processor, which includes the computational units, the data address generators, and the program sequencer, are examined along with the relevant assembly code instructions. A number of simulator labs help in understanding the operation of individual elements. Memory configuration (both internal and external) is discussed next. Advanced instructions are presented with a follow on lab session about code optimization. The I/O peripherals, which include the SPORTS, link ports, and external port, are discussed in detail along with DMA operation between these peripherals and internal memory.

Workshops are offered through Kaztek Engineering throughout the world. Visit the Kaztek Web site for the schedule of upcoming workshops and pricing information at:

<http://www.kaztek.com/>

Blackfin Processor Seminars

The Blackfin processor seminar is a subset of the Blackfin Processor Workshop slide set and does not include hands-on exercises. A Blackfin seminar is often accompanied by tools and software demonstrations running on hardware (sometimes by key Analog Devices third-party partners).

Contact your local Analog Devices sales office or distribution partner for information on Blackfin seminars or refer to:

<http://www.analog.com/processors/learning/index.html>

TechOnLine Seminars

If you cannot attend a workshop or seminar, check online Blackfin seminars. To access these seminars go to <http://www.analog.com>, search for **Visual Learning & Development (VLD)**. When you locate VLD, select the Blackfin course you want.

You can also request a copy of the Blackfin seminar and/or workshop material from Analog Devices. This includes all of the slides, associated notes, and exercises. Contact your local Analog Devices sales office for more information.

μ Clinux on the Blackfin Processor 3-Day Workshop

This course is an introduction to all aspects of programming with μ Clinux based on the Blackfin processor STAMP board. The course is presented by System Design and Consulting Services in various locations.

The course covers the following subjects: development tools, compiler, linker, Blackfin processor assembler and debugger, bootloader (U-boot), μ Clinux source distribution, μ Clinux libraries, Linux boot-up, Linux kernel 2.6.x, flash memory and flash file systems, introduction to device drivers, μ Clinux debugging, network applications, and example user applications.

Processor Documentation

Three documents accompany each Blackfin processor: a data sheet, a hardware reference, and a programming reference. These documents enable you to design software and hardware.

Blackfin Processor Manuals

Two kinds of manuals provide detailed information about the Blackfin processor: hardware reference manuals and a programming reference.

Available Support

Hardware Reference Manuals

Each processor's hardware reference manual provides architectural information about that particular Blackfin processor. The descriptions cover functional blocks, buses, and ports, including all features and processes that they support.

Typically, a hardware reference manual (HRM) is available for each processor series. For example, Analog Devices provides one HWR for ADSP-BF531/532/533 devices (entitled *ADSP-BF533 Blackfin Processor Hardware Reference*).

Some processors, such as the ADSP-BF542/544/547/548/549 devices, have two manuals, *ADSP-BF54x Blackfin Processor Hardware Reference* and *ADSP-BF54x Blackfin Processor Peripheral Hardware Reference*.

The VisualDSP++ Help system also includes a copy of each hardware reference manual and provides powerful search facilities to help you locate information.

You can find Blackfin processor hardware reference manuals at:

http://www.analog.com/processors/technical_library

Blackfin Processor Programming Reference

The *Blackfin Processor Programming Reference* contains information about the processor architecture and assembly language for Blackfin processors. The manual provides information on how assembly instructions execute on the Blackfin processor's architecture, along with reference information about processor operations.

If you intend to program in C only, this document is of no value to you. However, if you intend to author some assembly code, refer to this book.

The processor core and instruction set, which is common to all Blackfin processors, is documented in this manual.

The VisualDSP++ Help system also includes a searchable version of this manual so you can locate information quickly.

You can find the *Blackfin Processor Programming Reference* at:

http://www.analog.com/processors/technical_library

Open Source Software on the Blackfin Processor Manual

This manual attempts to provide a quick-and-easy guide to help users get started in the Blackfin/ μ Clinux open source community. It provides details on how to use essential tools such as the STAMP board, the Blackfin toolchain, U-Boot, μ Clinux, and the μ Clinux Web site. This manual is not a replacement for a Blackfin hardware reference or programming reference. This document gives an overview of the components essential to working with μ Clinux for Blackfin devices.

Access this manual by visiting this site:

<http://docs.blackfin.uclinux.org>

Data Sheets

Data sheets are created for each Blackfin processor and for each release of a single product. Each Blackfin processor data sheet provides:

- A high-level overview of the processor
- A description of processor pins
- Electrical, power, and timing characteristics/requirements
- Device package dimensions
- Environmental (temperature) information

To obtain data sheets for Blackfin processors, access this site:

<http://www.analog.com/processors/blackfin>

Available Support

Anomalies Lists for Processors and Tools

Analog Devices maintains an anomalies list for each Blackfin processor series and also maintains an anomalies list for tools. These lists are updated as new information becomes available.

Processor anomalies represent the currently-known differences between revisions of Blackfin devices and the functionality specified in the Blackfin processor data sheets and hardware manuals. A revision number with the form “-x.x” is branded on all parts to identify them according to silicon revisions.

For processor anomalies, refer to:

http://www.analog.com/processors/technical_library

For tools anomalies, refer to:

<http://www.analog.com/processors/tools-anomalies.html>

BSDL Files

Boundary scan description language (BSDL) files are necessary for the application of boundary-scan for board and system-level testing and in-system programming. BSDL files are the electronic data sheets that describe the IEEE 1149.1 or JTAG design within an IC, and are provided by the IC vendors as part of their device specifications. Use BSDL files to describe the test logic and generate a test for a loaded board.

IBIS Models

I/O buffer information specification (IBIS) models are used with various IBIS-based simulators for transmission line simulation of digital systems. These models accurately simulate I/O buffers, termination, and circuit board traces. The simulation time is much faster than SPICE (Simulation program with integrated circuit emphasis) simulations, because it is a

behavioral model that relies on tabulated current versus voltage characteristics. For more information about IBIS models, see the main ANSI/EIA IBIS home page at:

<http://www.eigroup.org/IBIS>

CROSSCORE Tools Documentation

Documentation in electronic form describes the various components of the CROSSCORE software and hardware tools. Analog Devices offers a software tools environment (VisualDSP++) and an assortment of hardware development tools.

For software tools, each release of VisualDSP++ includes a complete set of online manuals, describing the entire software development toolchain.

“[Hardware Tools Documentation](#)” on page 3-16 describes EZ-KIT Lite evaluation systems, emulators, and extender boards.

VisualDSP++ Documentation

This section briefly describes the VisualDSP++ manual set. Electronic versions of documents are available from the VisualDSP++ installation CD-ROM or via download from the following Web page:

http://www.analog.com/processors/technical_library

VisualDSP++ Help incorporates a searchable version of the VisualDSP++ manual set plus processor documentation and other tools manuals. See “[VisualDSP++ Help](#)” on page 3-22 for details.

VisualDSP++ Installation Quick Reference Card

The VisualDSP++ Installation Quick Reference Card provides system requirements and installation instructions.

Available Support

VisualDSP++ Product Release Bulletin

The VisualDSP++ Product Release Bulletin describes the new features and enhancements provided by VisualDSP++. It also describes the differences (obsolete features and functions) between the current and previous VisualDSP++ releases.

VisualDSP++ User's Guide

The VisualDSP++ User's Guide describes the features, components, and functions of VisualDSP++. Use this guide as a reference for developing programs for Blackfin processors. This manual does not include detailed procedures for building and debugging projects. For how-to information, refer to VisualDSP++ online Help and the *VisualDSP++ Getting Started Guide*.

VisualDSP++ Licensing Guide

VisualDSP++ is a licensed product from Analog Devices. This manual describes how to manage your license(s) for VisualDSP++ software. For users who purchase floating licenses, this guide describes the license server manager.

This manual describes the licensing options available. For node-locked licenses, it explains how to obtain a serial number, and how to install, register, and validate your license. For floating licenses, it explains how to obtain a serial number, install a floating license server, and register and validate your license. This manual also includes troubleshooting information and FAQs for licensing issues.

If you experience a problem after having tried to solve it using the information in this guide, the manual provides Analog Devices Customer Support contact information for further assistance.

VisualDSP++ Getting Started Guide

This manual provides step-by-step, 15-minute tutorials that highlight VisualDSP++ features. By completing the tutorials, users can become familiar with the VisualDSP++ environment quickly, and see how easy it is to use several tools in your own digital signal processing (DSP) development projects.

This manual and accompanying software provide an excellent starting point to gain a high level of understanding of the VisualDSP++ suite of project management and application development tools.

VisualDSP++ Assembler and Preprocessor Manual

This manual focuses on assembly programming for Blackfin processors that support a media instruction set computing (MISC) architecture.

The manual provides how-to information for writing assembly programs for Blackfin processors and reference information about related development software. It also provides information on new and legacy syntax for assembler and preprocessor directives and comments, as well as command-line switches.

VisualDSP++ C/C++ Compiler and Library Manual for Blackfin Processors

This manual contains information about the C/C++ compiler and run-time libraries for Blackfin processors.

The manual provides information on compiler options, language extensions, and C/C++/assembly interfacing, and shows how to optimize compiler operation. It explains how to use library functions and provides a complete C/C++ library function reference.

The manual describes the DSP run-time library, which contains a broad collection of functions commonly required by signal processing applications. The services provided by the DSP run-time library include support

Available Support

for general-purpose signal processing such as companders, filters, and Fast Fourier Transform (FFT) functions. All these services are Analog Devices extensions to ANSI standard C. These functions are in addition to the C/C++ run-time library functions.

Additionally, the manual describes the dual-core ADSP-BF561 Blackfin processor architecture, and then two approaches to application development using VisualDSP++. It also offers guidelines for developing systems on ADSP-BF561 Blackfin processors.

VisualDSP++ Linker and Utilities Manual

This manual provides information on the linking process and describes the syntax for the linker's command language—a scripting language that the linker reads from the linker description file (.ldf). The manual leads you through using the linker, archiver, and loader to produce processor programs. It also provides reference information on file utility software.

The manual also describes how overlays and advanced .ldf commands are used for memory management. In addition, it describes the expert linker, an interactive graphical tool to set up and map processor memory.

VisualDSP++ Loader and Utilities Manual

This manual contains information on how to use the loader/splitter to convert executable files into boot-loadable (or non-bootable) files. These files are then programmed/burned into an external memory device within your target system.

The manual begins by examining where loading/splitting fits in the typical program development activities. It discusses boot modes, boot streams, and second stage kernels. This manual contains the details you need to know about booting each particular series of Blackfin processors.

VisualDSP++ Device Driver and System Services Libraries Manual for Blackfin Processors

This manual describes device drivers and system services. Included is an overview and detailed description of the device driver model. It covers the device driver API and the various data flow methods that devices use to transfer data into and out of the processor. Included are examples of both DMA-driven and interrupt-driven drivers, and tutorials that show how to quickly write efficient device drivers that comply with the model.

Also included in this manual are the details of powerful system services that are available to applications through the system services library. This manual describes how applications can use the system services library to control the Blackfin processor's dynamic power management capabilities, control external asynchronous and synchronous memories, and manage interrupt processing. The manual also describes how applications can utilize the services of the DMA and callback to easily schedule both peripheral and memory DMA transfers, and defer noncritical, event-driven processing to a lower priority. Details on the APIs for the system services are provided as well as examples that demonstrate how applications can leverage these services.

VisualDSP++ Kernel (VDK) User's Guide

This manual contains information about the VisualDSP++ kernel, a real-time operating system kernel integrated with the VisualDSP++ development tools. The VDK incorporates state of the art scheduling and resource allocation techniques tailored specifically for the memory and timing constraints of DSP programming. Using frameworks of template files, the kernel facilitates development of performance-structured applications. The kernel is designed for effective operations on Analog Devices processors.

Available Support

The majority of the information in this manual is generic. Information applicable to a particular target processor, or to a particular processor series, is provided in Appendix A, “Processor-Specific Notes.” This manual explains the kernel internal structure and operation.

Hardware Tools Documentation

Each hardware tool (EZ-KIT Lite evaluation system, emulator, extender board, or STAMP board) available from Analog Devices includes electronic documentation. Typically this documentation contains schematics, a short description of switch and jumper settings, and a bill of materials.

Download electronic versions of the documentation (.pdf file format) from the following Web page:

http://www.analog.com/processors/technical_library

Getting Started With the ADSP-BF537 EZ-KIT Lite Manual

This manual provides exercises for the ADSP-BF537 Blackfin processor while working within the VisualDSP++ development system. In half a day, you can:

- Connect the EZ-KIT Lite (or EZ-Board) to your PC and write your first program
- Measure the performance and the impact of memory hierarchy and voltage on performance
- Use the TCP/IP peripheral of the ADSP-BF537 Blackfin processor
- Connect to your network and build the LwIP stack tailored to your application
- Create a Caesar Cipher application using VDK and LwIP
- Connect to the application with telnet

- Create an audio talk-through application with TCP/IP
- Change the audio and control volume via telnet
- Change clock frequency via telnet

Getting Started With the ADSP-BF548 EZ-KIT Lite Manual

This manual familiarizes users with the hardware capabilities of the evaluation system and demonstrates how to access these capabilities in the VisualDSP++ environment.

EZ-KIT Lite users should use this manual in conjunction with the *ADSP-BF548 EZ-KIT Lite Evaluation System Manual*, which describes the evaluation system's components in greater detail.

ADSP-BF506F EZ-Board Evaluation System Manual

This manual provides instructions for installing the product hardware (board) and software on your PC. The text describes operation and configuration of the board components and provides guidelines for running your own code on the ADSP-BF506F EZ-Board. Finally, a schematic and a bill of materials are provided as reference for future designs.

This manual provides information on the EZ-Board from a programmer's perspective and provides a memory map of the board.

ADSP-BF518F EZ-Board Evaluation System Manual

This manual provides instructions for installing the product hardware (board) and software on your PC. The text describes operation and configuration of the board components and provides guidelines for running your own code on the ADSP-BF518F EZ-Board. Finally, a schematic and a bill of materials are provided as reference for future designs.

This manual provides information on the EZ-Board from a programmer's perspective and provides a memory map of the board.

ADSP-BF526 EZ-Board Evaluation System Manual

This manual provides instructions for installing the product hardware (board) and software on your PC. The text describes operation and configuration of the board components and provides guidelines for running your own code on the ADSP-BF526 EZ-Board. Finally, a schematic and a bill of materials are provided as reference for future designs.

This manual provides information on the EZ-Board from a programmer's perspective and provides a memory map of the board.

ADSP-BF527 EZ-KIT Lite Evaluation System Manual

This manual provides instructions for installing the product hardware (board) and software on your PC. The text describes operation and configuration of the board components and provides guidelines for running your own code on the ADSP-BF527 EZ-KIT Lite. Finally, a schematic and a bill of materials are provided as reference for future designs.

This manual provides information on the EZ-KIT Lite from a programmer's perspective and provides a memory map of the board.

ADSP-BF533 EZ-KIT Lite Evaluation System Manual

This manual provides instructions for using the hardware and installing the software on your PC. This manual also provides guidelines for running your own code on the ADSP-BF533 EZ-KIT Lite. In addition, the manual describes the operation and configuration of the evaluation board's components. Finally, a schematic and a bill of materials are provided as reference for future ADSP-BF533 Blackfin processor board designs.

This manual provides information on the EZ-KIT Lite from a programmer's perspective and provides a memory map of the board.

ADSP-BF537 EZ-KIT Lite Evaluation System Manual

This manual provides instructions for using the hardware and installing the software on your PC. This manual also provides guidelines for running your own code on the ADSP-BF537 EZ-KIT Lite. In addition, the manual describes the operation and configuration of the evaluation board's components. Finally, a schematic and a bill of materials are provided as reference for future ADSP-BF537 Blackfin processor board designs.

This manual provides information on the EZ-KIT Lite from a programmer's perspective and provides a memory map of the board.

ADSP-BF538F EZ-KIT Lite Evaluation System Manual

This manual provides instructions for using the hardware and installing the software on your PC. This manual also provides guidelines for running your own code on the ADSP-BF538F EZ-KIT Lite. In addition, the manual describes the operation and configuration of the evaluation board's components. Finally, a schematic and a bill of materials are provided as reference for future ADSP-BF538F Blackfin processor board designs.

This manual provides information on the EZ-KIT Lite from a programmer's perspective and provides a memory map of the board.

ADSP-BF548 EZ-KIT Lite Evaluation System Manual

This manual provides instructions for using the hardware and installing the software on your PC. This manual also provides guidelines for running your own code on the ADSP-BF548 EZ-KIT Lite. In addition, the manual describes the operation and configuration of the evaluation board's components. Finally, a schematic and a bill of materials are provided as reference for future ADSP-BF548 Blackfin processor board designs.

Available Support

This manual provides information on the EZ-KIT Lite from a programmer's perspective and provides a memory map of the board.

ADSP-BF561 EZ-KIT Lite Evaluation System Manual

This manual provides instructions for using the hardware and installing the software on your PC. This manual also provides guidelines for running your own code on the ADSP-BF561 EZ-KIT Lite board. In addition, the manual describes the operation and configuration of the evaluation board's components. Finally, a schematic and a bill of materials are provided as reference for future ADSP-BF561 Blackfin processor designs.

This manual provides information on the EZ-KIT Lite from a programmer's perspective and provides a memory map of the board.

ADSP-BF592 EZ-KIT Lite Evaluation System Manual

This manual provides instructions for using the hardware and installing the software on your PC. This manual also provides guidelines for running your own code on the ADSP-BF592 EZ-KIT Lite board. In addition, the manual describes the operation and configuration of the evaluation board's components. Finally, a schematic and a bill of materials are provided as reference for future ADSP-BF592 Blackfin processor designs.

This manual provides information on the EZ-KIT Lite from a programmer's perspective and provides a memory map of the board.

EZ-Extender Manuals

The following manuals provide information about the capabilities of the EZ-Extender boards.

Blackfin A-V EZ-Extender Manual

This manual describes the operation and configuration of the components on the extension board. A schematic and a bill of materials are provided as reference for future Blackfin processor board designs.

Blackfin Audio EZ-Extender Manual

This manual describes the operation and configuration of the components on the extension board. A schematic and a bill of materials are provided as reference for future Blackfin processor board designs.

Blackfin Bluetooth EZ-Extender Manual

This manual describes the operation and configuration of the components on the extension board. A schematic and a bill of materials are provided as reference for future Blackfin processor board designs.

Blackfin EZ-Extender Manual

This manual describes the operation and configuration of the components on the extension board. A schematic and a bill of materials are provided as reference for future ADSP-BF533 and ADSP-BF561 Blackfin processor board designs.

Blackfin FPGA EZ-Extender Manual

This manual describes the operation and configuration of the components on the extension board. A schematic and a bill of materials are provided as reference for future Blackfin processor board designs.

Blackfin Landscape LCD EZ-Extender Manual

This manual describes operation and configuration of the extender board's components. A schematic and a bill of materials are provided as reference for future Blackfin processor board designs.

Available Support

Blackfin/SHARC EZ-Extender System Manual

This manual describes the operation and configuration of the components on the extension board. The Blackfin/SHARC USB EZ-Extender is a separately sold extender board that plugs onto the expansion interface of the ADSP-BF518F, ADSP-BF526, and ADSP-21469 EZ-Board evaluation systems.

Blackfin USB-LAN EZ-Extender Manual

This manual describes the operation and configuration of the components on the extension board. A schematic and a bill of materials are provided as reference for future Blackfin processor board designs.

VisualDSP++ Help

VisualDSP++ online Help is a powerful search tool. It combines the following documents and much more in one place:

- Complete VisualDSP++ manual set
- Processor hardware manuals and hardware tools manuals
- Over 200 hundred technical articles (EE-Notes)

The Help system is integrated into the VisualDSP++ graphical user interface and also provides context information (for debugging windows, tools, and dialog boxes). Each task is described in clear step-by-step detail.

Best of all, VisualDSP++ Help provides a single access point to just about every processor hardware and tools document produced by Analog Devices.

The search engine in Help enables you to find information quickly.

VisualDSP++ Help, built around the familiar Microsoft HTML Help standard, enables you to:

- Copy code examples from Help into your source documents
- Bookmark and print topics
- Perform a full text search, or refine a search with wildcards, nested expressions, or Boolean operators

Find a Third Party—Faster Time To Market

Analog Devices third-party developers network consists of companies all over the world that provide hardware products, software products, algorithms and design services for a wide variety of applications and markets. The third-party search on our website (<http://analog.com/3rdparty>) allows you to quickly find the third parties that offer services for our embedded processors and DSPs. The interface also allows you to easily filter our third-party network by ADI processor(s) supported, offerings, regions supported and markets and applications supported. You can also perform a keyword search of all the third-party listings.

MyAnalog.com

MyAnalog.com is a free feature of the Analog Devices Web site that allows customization of a Web page to display only the latest information on products you are interested in. You can also choose to receive weekly e-mail notifications containing updates to the Web pages that meet your interests, including documentation errata against all manuals.

MyAnalog.com provides access to books, application notes, data sheets, code examples, and more.

Available Support

Registration

Visit MyAnalogue.com to sign up. Click **Register** to use the site. Registration takes about five minutes and serves as a means to select the information you want to receive.

If you are already a registered user, just log on. Your user name is your e-mail address.

I INDEX

A

ADSP-BF506F processors

EZ-KIT Lite evaluation system, [2-28](#)

ADSP-BF50x processors

about, [1-9](#)

available models, [1-10](#)

ADSP-BF518F processors

EZ-KIT Board evaluation system, [2-30](#)

ADSP-BF51x processors

about, [1-8](#)

available processors, [1-11](#)

ADSP-BF522 processors

available models, [1-15](#)

ADSP-BF523 processors

available models, [1-16](#)

ADSP-BF524 processors

available models, [1-16](#)

ADSP-BF525 processors

available models, [1-17](#)

ADSP-BF526 processors

available models, [1-18](#)

EZ-KIT Board evaluation system, [2-33](#),
[2-64](#)

ADSP-BF527 processors

available models, [1-18](#)

ADSP-BF52x processors

about, [1-8](#)

ADSP-BF526 EZ-Board, [2-33](#)

EZ-KIT Lite evaluation system, [2-36](#)

ADSP-BF531 processors

available models, [1-19](#)

ADSP-BF532 processors

available models, [1-19](#)

ADSP-BF533 processors

available models, [1-20](#)

EZ-KIT Lite evaluation system, [2-47](#)

ADSP-BF534 processors

available models, [1-21](#)

ADSP-BF535 processors

available models, [1-22](#)

ADSP-BF536 processors

available models, [1-22](#)

ADSP-BF537 processors

available models, [1-23](#)

EZ-KIT Lite evaluation system, [2-43](#)

STAMP board support package, [2-66](#)

ADSP-BF538F processors

EZ-KIT Lite evaluation system, [2-40](#)

ADSP-BF538 processors

available models, [1-24](#)

ADSP-BF539 processors

available models, [1-24](#)

ADSP-BF542 processors

available models, [1-24](#)

ADSP-BF544 processors

available models, [1-25](#)

ADSP-BF547 processors

available models, [1-25](#)

ADSP-BF548 processors

available models, [1-25](#)

ADSP-BF549 processors

available models, [1-26](#)

diagram of, [1-2](#)

Index

- ADSP-BF54x processors
 - about, [1-8](#)
 - EZ-KIT Lite evaluation system, [2-38](#)
- ADSP-BF561 processors
 - about, [1-9](#)
 - application development, [3-14](#)
 - available models, [1-26](#)
 - EZ-KIT Lite evaluation system, [2-45](#)
- ADSP-BF592 processors
 - about, [1-9](#)
 - available models, [1-10](#)
 - EZ-KIT Lite evaluation system, [2-26](#)
- algorithms, [2-11](#)
- anomalies lists, [3-10](#)
- application development
 - ADSP-BF561, [3-14](#)
 - stages of, [2-1](#)
- application notes, [3-3](#)
- applications
 - control, [1-5](#)
 - signal processing, [1-5](#)
- assembler, [3-13](#)
- assembly coding, [1-5](#)
- assembly language, [3-8](#)
- audio algorithms, [2-11](#)
- Audio EZ-Extender daughter board, [2-60](#)
- A-V EZ-Extender board, [2-62](#)

B

- benchmarks
 - advantages of, [1-29](#)
 - Dhrystone, [1-30](#)
 - EEMBC, [1-33](#)
 - Linux, [1-30](#)
 - nbench, [1-32](#)
 - processor algorithms, [2-11](#)
 - URL showing Blackfin performance, [1-36](#)
 - Whetstone, [1-31](#)

- Blackfin
 - ADSP-BF537 STAMP board support
 - package, [2-66](#)
 - application development, [2-1](#)
 - architecture, [1-2](#), [1-27](#)
 - Audio EZ-Extender daughter board, [2-60](#)
 - A-V EZ-Extender board, [2-62](#)
 - core, [1-28](#)
 - data sheets, [3-9](#)
 - documentation, [3-11](#)
 - dual-core devices, [1-6](#)
 - EZ-Extender, [3-20](#)
 - EZ-Extender board, [2-50](#)
 - FPGA EZ-Extender daughter board, [2-54](#)
 - interfaces, [1-28](#)
 - Koop, [2-14](#)
 - Landscape LCD EZ-Extender daughter board, [2-57](#)
 - memory protection, [1-6](#)
 - operating systems, [1-2](#)
 - optimization, [1-5](#)
 - scalability, [1-29](#)
 - selection information, [3-3](#)
 - specifications, [1-10](#), [3-9](#)
 - speed, [1-28](#)
 - standalone debug agent, [2-68](#), [2-70](#), [2-77](#)
 - training, [3-5](#)
 - USB-LAN EZ-Extender board, [2-52](#)
 - µClinux support, [2-15](#)
- Blackfin FPGA EZ-Extender daughter board, [2-54](#)
- Blackfin USB-LAN EZ-Extender board, [2-52](#)
- boards
 - Audio EZ-Extender, [2-60](#)
 - A-V EZ-Extender, [2-62](#)
 - EZ-Extender, [2-50](#)
 - FPGA EZ-Extender, [2-54](#)

boards *(continued)*
 Landscape LCD EZ-Extender, 2-57
 STAMP, 2-66
 standalone debug agent, 2-68, 2-70, 2-77
 third-party, 2-80
 USB-LAN EZ-Extender, 2-52
 board support packages, 2-19
 BSDL files, 3-10

C

cache memory controller support, 1-4
 C/C++ compiler, 3-13
 codecs, 2-23
 code density
 Blackfin benefit, 1-5
 comparative graphic, 1-34
 compiler, 1-36
 graph of efficiency, 1-36
 code examples
 EZ-KIT Lite, 2-22
 compiler
 code density, 1-36
 manual, 3-13
 convolution, 2-11
 courses, 3-5
 CROSSCORE tools, documentation, 3-11

D

data sheets, 3-9
 debug agent
 standalone, 2-68, 2-70, 2-77
 decoders, 2-23
 Dhrystone benchmarks, 1-30
 discrete cosine functions, 2-11
 documentation, 3-11
 ADSP-BF518F EZ-Board, 3-17
 ADSP-BF526 EZ-Board, 3-18
 ADSP-BF527 EZ-KIT Lite, 3-18
 ADSP-BF533 EZ-KIT Lite, 3-18

documentation *(continued)*
 ADSP-BF537 EZ-KIT Lite, 3-19
 ADSP-BF538F EZ-KIT Lite, 3-19
 ADSP-BF548 EZ-KIT Lite, 3-19
 ADSP-BF561 EZ-KIT Lite, 3-20
 ADSP-BF592 EZ-KIT Lite, 3-20
 Blackfin Audio EZ-Extender, 3-21
 Blackfin A-V EZ-Extender, 3-20
 Blackfin Bluetooth 2EZ-Extender, 3-21
 Blackfin FPGA EZ-Extender, 3-21
 Blackfin Landscape LCD EZ-Extender,
 3-21
 Blackfin/SHARC EZ-Extender, 3-22
 Blackfin USB-LAN EZ-Extender, 3-22
 CROSSCORE tools, 3-11
 data sheets, 3-9
 EZ-Extender manuals, 3-20
 Getting Started With the ADSP-BF537
 EZ-KIT Lite, 3-16
 Getting Started With the ADSP-BF548
 EZ-KIT Lite, 3-17
 hardware references, 3-8
 hardware tools, 3-16
 instruction set, 3-8
 processor, 3-7
 programming reference, 3-8
 VisualDSP++, 3-11
 VisualDSP++ Assembler and
 Preprocessor, 3-13
 VisualDSP++ C/C++ Compiler and
 Library for Blackfin Processors, 3-13
 VisualDSP++ Device Drivers and System
 Services Libraries for Blackfin
 Processors, 3-15
 VisualDSP++ Help, 3-22
 VisualDSP++ Kernel (VDK), 3-15
 VisualDSP++ Linker and Utilities, 3-14
 VisualDSP++ Loader and Utilities, 3-14
 DSP. *See* processors

Index

dual-core processors
 advantages, [1-29](#)
 flexibility of, [1-6](#)
 power-savings advantages, [1-29](#)

E

Educational Laboratory Virtual Instrumentation Suite interface. *See* ELVIS

EEMBC benchmarks, [1-33](#)

EE-Notes, [3-3](#)

ELVIS (Educational Laboratory Virtual Instrumentation Suite)
 interface, [2-41](#)

Embedded Microprocessor Benchmark Consortium (EEMBC), [1-33](#)

emulators, [2-71](#)
 high-performance USB JTAG, [2-72](#)
 JTAG, [2-24](#)
 USB-based JTAG, [2-75](#)

encoders, [2-23](#)

evaluation system. *See* EZ-KIT Lite evaluation systems

examples
 included with VisualDSP++, [2-22](#)

exception handling, [1-4](#)

expansion boards, [2-50](#)

EZ-Board evaluation systems
 ADSP-BF518F, [2-30](#)
 ADSP-BF526, [2-33](#), [2-64](#)

EZ-Extender, [3-20](#)

EZ-Extender board, [2-50](#)
 features and photograph, [2-50](#)

EZ-KIT Lite evaluation systems
 ADSP-BF506F, [2-28](#)
 ADSP-BF527, [2-36](#)
 ADSP-BF533, [2-47](#)
 ADSP-BF537, [2-43](#)
 ADSP-BF538F, [2-40](#)
 ADSP-BF548, [2-38](#)

EZ-KIT Lite eval systems *(continued)*
 ADSP-BF561, [2-45](#)
 ADSP-BF592, [2-26](#)
 defined, [2-23](#)
 expansion boards, [2-50](#)
 licensing, [2-24](#)
 programs for, [2-22](#)

F

filters, [2-11](#)

Fourier cosine functions, [2-11](#)

FPGA EZ-Extender daughter board, [2-54](#)

G

GCC toolchain, [2-12](#)

GNU toolchain, [2-12](#)

H

hardware reference manuals, [3-8](#)

hardware tools, [2-23](#)
 documentation, [3-16](#)
 selecting, [2-23](#)

Help (online), [3-22](#)

high-performance USB 2.0 JTAG emulator (HPUSB)
 features and photographs, [2-72](#)

I

IBIS models, [3-10](#)

image processing and analysis, [2-11](#)

instruction set
 documentation, [3-8](#)

interfaces
 Blackfin processor, [1-28](#)

interrupt processing, [1-4](#), [1-5](#)

J

JTAG emulators, [2-24](#)
 JTAG (Joint Test Action Group) emulators
 defined, [2-71](#)

K

Koop, [2-14](#)

L

LabVIEW virtual instruments, [2-41](#)
 Landscape LCD EZ-Extender daughter
 board, [2-57](#)
 LDF commands, [3-14](#)
 licenses
 described, [2-24](#)
 floating, [2-85](#)
 test drive, [2-10](#)
 linking, [3-14](#)
 Linux
 versus μ Clinux, [2-13](#)
 Linux operating system
 Blackfin advanced memory
 management, [1-2](#)
 Dhrystone benchmark, [1-31](#)
 nbench benchmark, [1-32](#)
 loader, [3-14](#)
 LockBox secure technology, [1-8](#)

M

magazine articles, [3-3](#)
 manuals. *See* documentation
 MCU (microcomputer unit) operation, [1-4](#)
 memory management, [1-2](#), [1-4](#)
 memory protection, [1-6](#)
 Micro Signal Architecture (MSA), [1-2](#)
 multi-rate filters, [2-11](#)

N

nbench benchmark, [1-32](#)

O

online Help, [3-22](#)
 open source software, [2-12](#)
 operating systems support, [1-2](#), [1-5](#)

P

PGO (profile-guided optimization), [2-8](#)
 PHYTEC phyCORE-BF537 SBC, [2-80](#)
 processors
 algorithms, [2-11](#)
 anomalies lists, [3-10](#)
 data sheets, [3-9](#)
 programming, [1-4](#)
 RoHS compliant, [1-10](#)
 selection charts, [3-3](#)
 profile-guided optimization (PGO), [2-8](#)
 protected memory, [1-6](#)
 protected mode, [1-4](#)

R

RISC
 instruction set, [1-2](#)
 processing, [1-28](#)
 RoHS compliant processors, [1-10](#)

S

seminars, [3-5](#)
 seminars, TechOnLine, [3-7](#)
 signal processing, [1-4](#)
 software development tools, [2-22](#)
 software licenses, [2-24](#)
 specifications
 data sheets, [3-9](#)
 key features, [1-10](#)

Index

speech algorithms, [2-11](#)
STAMP board, [2-66](#)
standalone debug agent, [2-68](#), [2-70](#), [2-77](#)
system services
 manual, [3-15](#)

T

TechOnLine seminars, [3-7](#)
test drive license, [2-10](#), [2-84](#)
third-party developer network, [2-10](#), [3-23](#)
toolchain
 GNU, [2-12](#)
toolchains
 comparison, [2-22](#)
tools
 anomalies list, [3-10](#)
 comparison of, [2-22](#)
 CROSSCORE, [2-10](#), [3-11](#)
 GCC, [2-19](#)
 hardware development, [2-23](#)
 selecting, [2-1](#), [2-84](#)
trade magazine articles, [3-3](#)
training, [3-5](#)

U

USB 1.1 JTAG Emulator
 features and photograph, [2-75](#)
USB-based JTAG emulators, [2-75](#)
USB-LAN EZ-Extender board, [2-52](#)

V

VDK, defined, [3-15](#)
video processing, [1-2](#)
VisualDSP++
 documentation, [3-22](#)
 features, [2-3](#)
 Help, [3-9](#), [3-22](#)
 platform and processor support, [2-3](#)
 profile-guided optimization (PGO), [2-8](#)

W

Whetstone benchmarks, [1-31](#)
workshops, [3-5](#)

Z

µClinux
 Dhrystone benchmark, [1-31](#)
 distribution, [2-15](#)
 nbench benchmark, [1-32](#)
 versus Linux, [2-13](#)
 workshop for Blackfin, [3-7](#)
µClinux kernel board support package,
 [2-66](#)