

Low Emission, 5 kV Isolated DC-to-DC Converters

FEATURES

- ▶ isoPower integrated, isolated dc-to-dc converter
- ▶ 100 mA output current for ADuM6020
- ▶ 60 mA output current for ADuM6028
- ▶ AEC-Q100 qualified for automotive applications
- ▶ Meets CISPR22 Class B emissions limits at full load on a 2-layer PCB
- ▶ 16-lead SOIC_IC package with 8.3 mm minimum creepage
- ▶ 8-lead SOIC_IC package with 8.3 mm minimum creepage
- ▶ High temperature operation: 125°C maximum
- ▶ Safety and regulatory approvals
 - ▶ UL recognition
 - ▶ 5000 V rms for 1 minute per UL 1577
 - ▶ CSA Component Acceptance Notice 5A
 - ▶ VDE certificate of conformity
 - ▶ VDE V 0884-10
 - ▶ $V_{IORM} = 565$ V peak
 - ▶ CQC certification per GB4943.1-2011

APPLICATIONS

- ▶ RS-485/RS-422/CAN transceiver power
- ▶ Power supply start-up bias and gate drives
- ▶ Isolated sensor interfaces
- ▶ Automotive on-board charger (OBC) and dc to dc
- ▶ Industrial PLCs

GENERAL DESCRIPTION

The ADuM6020/ADuM6028¹ are isoPower®, integrated, isolated dc-to-dc converters. Based on the Analog Devices, Inc., iCoupler® technology, these dc-to-dc converters provide regulated, isolated power that is below CISPR22 Class B limits at full load on a 2-layer printed circuit board (PCB) with ferrites. Common voltage combinations and the associated current output levels are shown in Table 1 through Table 4.

The ADuM6020/ADuM6028 eliminate the need to design and build isolated dc-to-dc converters in applications up to 500 mW. The iCoupler chip scale transformer technology is used for the magnetic components of the dc-to-dc converter. The result is a small form factor, isolated solution.

The ADuM6020/ADuM6028 isolated dc-to-dc converters provide two different package variants: the ADuM6020 in a wide-body, 16-lead SOIC_IC package, and the ADuM6028 in the space-saving, 8-lead, wide-body SOIC_IC package. For 5 V input operations, use the ADuM6020-5BRIZ and the ADuM6028-5BRIZ. For 3.3 V

FUNCTIONAL BLOCK DIAGRAMS

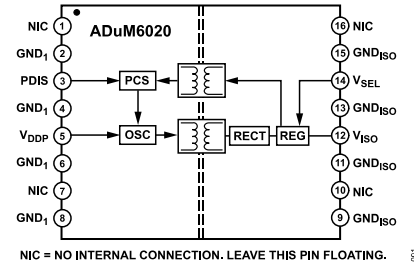

Figure 1. ADuM6020 Functional Block Diagram

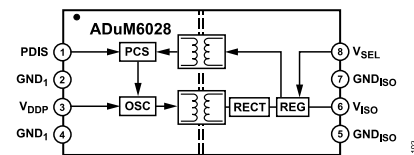

Figure 2. ADuM6028 Functional Block Diagram

input to 3.3 V output operations, use the ADuM6020-3BRIZ and the ADuM6028-3BRIZ. See the Pin Configuration and Function Descriptions section and the Ordering Guide for more information.

¹ Protected by U.S. Patents 5,952,849; 6,873,065; 6,903,578; and 7,075,329. Other patents are pending.

Rev. C

DOCUMENT FEEDBACK

TECHNICAL SUPPORT

Information furnished by Analog Devices is believed to be accurate and reliable "as is". However, no responsibility is assumed by Analog Devices for its use, nor for any infringements of patents or other rights of third parties that may result from its use. Specifications subject to change without notice. No license is granted by implication or otherwise under any patent or patent rights of Analog Devices. Trademarks and registered trademarks are the property of their respective owners.

TABLE OF CONTENTS

Features.....	1	Recommended Operating Conditions.....	10
Applications.....	1	Absolute Maximum Ratings.....	11
Functional Block Diagrams.....	1	ESD Caution.....	11
General Description.....	1	Pin Configuration and Function Descriptions.....	12
Specifications.....	3	Truth Table.....	12
Electrical Characteristics—5 V Primary		Typical Performance Characteristics.....	13
Input Supply/5 V Secondary Isolated		Theory of Operation.....	16
Supply.....	3	Applications Information.....	17
Electrical Characteristics—5 V Primary		PCB Layout.....	17
Input Supply/3.3 V Secondary Isolated		Thermal Analysis.....	17
Supply.....	4	EMI Considerations.....	18
Electrical Characteristics—3.3 V Primary		Insulation Lifetime.....	18
Input Supply/3.3 V Secondary Isolated		Start-Up Behavior and Power Sequencing.....	19
Supply.....	5	Outline Dimensions.....	20
Regulatory Approvals.....	6	Ordering Guide.....	20
Insulation and Safety Related Specifications.....	7	Evaluation Boards.....	21
Package Characteristics.....	8	Automotive Products.....	21
DIN V VDE V 0884-10 (VDE V 0884-10)			
Insulation Characteristics.....	8		

REVISION HISTORY**3/2022—Rev. B to Rev. C**

Changes to Features Section.....	1
Changes to Applications Section.....	1
Changes to General Description Section.....	1
Added Undervoltage Lockout Parameter, Table 1 and Table 2.....	3
Added Undervoltage Lockout Parameter, Table 3 and Table 4.....	4
Added Undervoltage Lockout Parameter, Table 5 and Table 6.....	5
Changes to Table 7.....	6
Changes to Table 14.....	10
Change to Note 2, Table 15.....	11
Changes to Table 17 and Table 18.....	12
Changes to Theory of Operation Section.....	16
Changes to Figure 23, Figure 24, Table 20, Figure 25, and Figure 26.....	17
Added Start-Up Behavior and Power Sequencing Section.....	19
Changes to Ordering Guide.....	20
Added Automotive Products Section.....	21

SPECIFICATIONS

ELECTRICAL CHARACTERISTICS—5 V PRIMARY INPUT SUPPLY/5 V SECONDARY ISOLATED SUPPLY

All typical specifications are at $T_A = 25^\circ\text{C}$, $V_{DDP} = V_{ISO} = 5\text{ V}$. Minimum and maximum specifications apply over the entire recommended operation range, which is $4.5\text{ V} \leq V_{DDP} \leq 5.5\text{ V}$, $4.5\text{ V} \leq V_{ISO} \leq 5.5\text{ V}$, and $-40^\circ\text{C} \leq T_A \leq +125^\circ\text{C}$, unless otherwise noted.

Table 1. ADuM6020-5BRIZ DC-to-DC Converter Static Specifications

Parameter	Symbol	Min	Typ	Max	Unit	Test Conditions/Comments
DC-TO-DC CONVERTER SUPPLY						
Setpoint	V_{ISO}	4.75	5.0	5.25	V	V_{ISO} output current (I_{ISO}) = 10 mA
Line Regulation	V_{ISO} (LINE)		2		mV/V	$I_{ISO} = 50\text{ mA}$, $V_{DDP} = 4.5\text{ V}$ to 5.5 V
Load Regulation ¹	V_{ISO} (LOAD)		1	5	%	$I_{ISO} = 10\text{ mA}$ to 90 mA
Output Ripple ¹	V_{ISO} (RIP)		75		mV p-p	20 MHz bandwidth, bypass output capacitance (C_{BO}) = $0.1\ \mu\text{F}$ $10\ \mu\text{F}$, $I_{ISO} = 90\text{ mA}$
Output Noise ¹	V_{ISO} (NOISE)		200		mV p-p	$C_{BO} = 0.1\ \mu\text{F}$ $10\ \mu\text{F}$, $I_{ISO} = 90\text{ mA}$
Switching Frequency	f_{OSC}		180		MHz	
Pulse-Width Modulation (PWM) Frequency	f_{PWM}		625		kHz	
Output Supply Current ¹	I_{ISO} (MAX)	50			mA	$4.75\text{ V} < V_{ISO} < 5.25\text{ V}$
		100			mA	$4.5\text{ V} < V_{ISO} < 5.25\text{ V}$
Efficiency at I_{ISO} (MAX)			33		%	$I_{ISO} = 100\text{ mA}$, $T_A = 25^\circ\text{C}$
V_{DDP} Supply Current						
No V_{ISO} Load	I_{DDP} (Q)		8	25	mA	
Full V_{ISO} Load	I_{DDP} (MAX)		310		mA	
Undervoltage Lockout						
V_{DDP}						
Rising Threshold		3.6	4.1	4.4	V	
Falling Threshold		2.8	3.3	4.2	V	
V_{ISO}						
Rising Threshold			5.1		V	
Falling Threshold			2.48		V	
Thermal Shutdown						
Shutdown Temperature			154		$^\circ\text{C}$	
Thermal Hysteresis			10		$^\circ\text{C}$	

¹ Maximum V_{ISO} output current is derated by $1.75\text{ mA}/^\circ\text{C}$ for $T_A > 85^\circ\text{C}$.

Table 2. ADuM6028-5BRIZ DC-to-DC Converter Static Specifications

Parameter	Symbol	Min	Typ	Max	Unit	Test Conditions/Comments
DC-TO-DC CONVERTER SUPPLY						
Setpoint	V_{ISO}	4.75	5.0	5.25	V	$I_{ISO} = 10\text{ mA}$
Line Regulation	V_{ISO} (LINE)		2		mV/V	$I_{ISO} = 30\text{ mA}$, $V_{DDP} = 4.5\text{ V}$ to 5.5 V
Load Regulation ¹	V_{ISO} (LOAD)		1	5	%	$I_{ISO} = 6\text{ mA}$ to 54 mA
Output Ripple ¹	V_{ISO} (RIP)		75		mV p-p	20 MHz bandwidth, $C_{BO} = 0.1\ \mu\text{F}$ $10\ \mu\text{F}$, $I_{ISO} = 54\text{ mA}$
Output Noise ¹	V_{ISO} (NOISE)		200		mV p-p	$C_{BO} = 0.1\ \mu\text{F}$ $10\ \mu\text{F}$, $I_{ISO} = 54\text{ mA}$
Switching Frequency	f_{OSC}		180		MHz	
PWM Frequency	f_{PWM}		625		kHz	
Output Supply Current ¹	I_{ISO} (MAX)	60			mA	$4.75\text{ V} < V_{ISO} < 5.25\text{ V}$
Efficiency at I_{ISO} (MAX)			33		%	$I_{ISO} = 60\text{ mA}$, $T_A = 25^\circ\text{C}$
V_{DDP} Supply Current						
No V_{ISO} Load	I_{DDP} (Q)		8	25	mA	

SPECIFICATIONS

Table 2. ADuM6028-5BRIZ DC-to-DC Converter Static Specifications

Parameter	Symbol	Min	Typ	Max	Unit	Test Conditions/Comments
Full V_{ISO} Load	$I_{DDP (MAX)}$		190		mA	
Undervoltage Lockout						
V_{DDP}						
Rising Threshold		3.6	4.1	4.4	V	
Falling Threshold		2.8	3.3	4.2	V	
V_{ISO}						
Rising Threshold			5.1		V	
Falling Threshold			2.48		V	
Thermal Shutdown						
Shutdown Temperature			154		°C	
Thermal Hysteresis			10		°C	

¹ Maximum V_{ISO} output current is derated by 1 mA/°C for $T_A > 85^\circ\text{C}$.

ELECTRICAL CHARACTERISTICS—5 V PRIMARY INPUT SUPPLY/3.3 V SECONDARY ISOLATED SUPPLY

All typical specifications are at $T_A = 25^\circ\text{C}$, $V_{DDP} = 5.0\text{ V}$, $V_{ISO} = 3.3\text{ V}$. Minimum and maximum specifications apply over the entire recommended operation range, which is $4.5\text{ V} \leq V_{DDP} \leq 5.5\text{ V}$, $3.0\text{ V} \leq V_{ISO} \leq 3.6\text{ V}$, and $-40^\circ\text{C} \leq T_A \leq +125^\circ\text{C}$, unless otherwise noted.

Table 3. ADuM6020-5BRIZ DC-to-DC Converter Static Specifications

Parameter	Symbol	Min	Typ	Max	Unit	Test Conditions/Comments
DC-TO-DC CONVERTER SUPPLY						
Setpoint	V_{ISO}	3.135	3.3	3.465	V	$I_{ISO} = 10\text{ mA}$
Line Regulation	$V_{ISO (LINE)}$		2		mV/V	$I_{ISO} = 50\text{ mA}$, $V_{DDP} = 3.0\text{ V to } 3.6\text{ V}$
Load Regulation ¹	$V_{ISO (LOAD)}$		1	5	%	$I_{ISO} = 10\text{ mA to } 90\text{ mA}$
Output Ripple ¹	$V_{ISO (RIP)}$		50		mV p-p	20 MHz bandwidth, $C_{BO} = 0.1\ \mu\text{F} 10\ \mu\text{F}$, $I_{ISO} = 90\text{ mA}$
Output Noise ¹	$V_{ISO (NOISE)}$		130		mV p-p	$C_{BO} = 0.1\ \mu\text{F} 10\ \mu\text{F}$, $I_{ISO} = 90\text{ mA}$
Switching Frequency	f_{OSC}		180		MHz	
PWM Frequency	f_{PWM}		625		kHz	
Output Supply Current ¹	$I_{ISO (MAX)}$	50			mA	$3.135\text{ V} < V_{ISO} < 3.465\text{ V}$
		100			mA	$3.0\text{ V} < V_{ISO} < 3.465\text{ V}$
Efficiency at $I_{ISO (MAX)}$			27		%	$I_{ISO} = 100\text{ mA}$, $T_A = 25^\circ\text{C}$
V_{DDP} Supply Current						
No V_{ISO} Load	$I_{DDP (Q)}$		5	18	mA	
Full V_{ISO} Load	$I_{DDP (MAX)}$		250		mA	
Undervoltage Lockout						
V_{DDP}						
Rising Threshold		3.6	4.1	4.4	V	
Falling Threshold		2.8	3.3	4.2	V	
V_{ISO}						
Rising Threshold			3.28		V	
Falling Threshold			2.45		V	
Thermal Shutdown						
Shutdown Temperature			154		°C	
Thermal Hysteresis			10		°C	

¹ Maximum V_{ISO} output current is derated by 1.75 mA/°C for $T_A > 85^\circ\text{C}$.

SPECIFICATIONS

Table 4. ADuM6028-5BRIZ DC-to-DC Converter Static Specifications

Parameter	Symbol	Min	Typ	Max	Unit	Test Conditions/Comments
DC-TO-DC CONVERTER SUPPLY						
Setpoint	V_{ISO}	3.135	3.3	3.465	V	$I_{ISO} = 10 \text{ mA}$
Line Regulation	$V_{ISO} \text{ (LINE)}$		2		mV/V	$I_{ISO} = 30 \text{ mA}$, $V_{DDP} = 3.0 \text{ V to } 3.6 \text{ V}$
Load Regulation ¹	$V_{ISO} \text{ (LOAD)}$		1	5	%	$I_{ISO} = 6 \text{ mA to } 54 \text{ mA}$
Output Ripple ¹	$V_{ISO} \text{ (RIP)}$		50		mV p-p	20 MHz bandwidth, $C_{BO} = 0.1 \mu\text{F} 10 \mu\text{F}$, $I_{ISO} = 54 \text{ mA}$
Output Noise ¹	$V_{ISO} \text{ (NOISE)}$		130		mV p-p	$C_{BO} = 0.1 \mu\text{F} 10 \mu\text{F}$, $I_{ISO} = 54 \text{ mA}$
Switching Frequency	f_{OSC}		180		MHz	
PWM Frequency	f_{PWM}		625		kHz	
Output Supply Current ¹	$I_{ISO} \text{ (MAX)}$	30			mA	$3.135 \text{ V} < V_{ISO} < 3.465 \text{ V}$
		60			mA	$3.0 \text{ V} < V_{ISO} < 3.465 \text{ V}$
Efficiency at $I_{ISO} \text{ (MAX)}$			27		%	$I_{ISO} = 60 \text{ mA}$, $T_A = 25^\circ\text{C}$
V_{DDP} Supply Current						
No V_{ISO} Load	$I_{DDP} \text{ (Q)}$		5	18	mA	
Full V_{ISO} Load	$I_{DDP} \text{ (MAX)}$		150		mA	
Undervoltage Lockout						
V_{DDP}						
Rising Threshold		3.6	4.1	4.4	V	
Falling Threshold		2.8	3.3	4.2	V	
V_{ISO}						
Rising Threshold			3.28		V	
Falling Threshold			2.45		V	
Thermal Shutdown						
Shutdown Temperature			154		$^\circ\text{C}$	
Thermal Hysteresis			10		$^\circ\text{C}$	

¹ Maximum V_{ISO} output current is derated by 1 mA/ $^\circ\text{C}$ for $T_A > 85^\circ\text{C}$.

ELECTRICAL CHARACTERISTICS—3.3 V PRIMARY INPUT SUPPLY/3.3 V SECONDARY ISOLATED SUPPLY

All typical specifications are at $T_A = 25^\circ\text{C}$, $V_{DDP} = 3.3 \text{ V}$, $V_{ISO} = 3.3 \text{ V}$. Minimum and maximum specifications apply over the entire recommended operation range, which is $3.0 \text{ V} \leq V_{DDP} \leq 3.6 \text{ V}$, $3.0 \text{ V} \leq V_{ISO} \leq 3.6 \text{ V}$, and $-40^\circ\text{C} \leq T_A \leq +125^\circ\text{C}$, unless otherwise noted.

Table 5. ADuM6020-3BRIZ DC-to-DC Converter Static Specifications

Parameter	Symbol	Min	Typ	Max	Unit	Test Conditions/Comments
DC-TO-DC CONVERTER SUPPLY						
Setpoint	V_{ISO}	3.135	3.3	3.465	V	$I_{ISO} = 10 \text{ mA}$
Line Regulation	$V_{ISO} \text{ (LINE)}$		2		mV/V	$I_{ISO} = 50 \text{ mA}$, $V_{DDP} = 3.0 \text{ V to } 3.6 \text{ V}$
Load Regulation ¹	$V_{ISO} \text{ (LOAD)}$		1	5	%	$I_{ISO} = 7 \text{ mA to } 63 \text{ mA}$
Output Ripple ¹	$V_{ISO} \text{ (RIP)}$		50		mV p-p	20 MHz bandwidth, $C_{BO} = 0.1 \mu\text{F} 10 \mu\text{F}$, $I_{ISO} = 90 \text{ mA}$
Output Noise ¹	$V_{ISO} \text{ (NOISE)}$		130		mV p-p	$C_{BO} = 0.1 \mu\text{F} 10 \mu\text{F}$, $I_{ISO} = 90 \text{ mA}$
Switching Frequency	f_{OSC}		180		MHz	
PWM Frequency	f_{PWM}		625		kHz	
Output Supply Current ¹	$I_{ISO} \text{ (MAX)}$	35			mA	$3.135 \text{ V} < V_{ISO} < 3.465 \text{ V}$
		70			mA	$3.0 \text{ V} < V_{ISO} < 3.465 \text{ V}$
Efficiency at $I_{ISO} \text{ (MAX)}$			33		%	$I_{ISO} = 70 \text{ mA}$, $T_A = 25^\circ\text{C}$
V_{DDP} Supply Current						
No V_{ISO} Load	$I_{DDP} \text{ (Q)}$		5	15	mA	
Full V_{ISO} Load	$I_{DDP} \text{ (MAX)}$		225		mA	

SPECIFICATIONS

Table 5. ADuM6020-3BRIZ DC-to-DC Converter Static Specifications

Parameter	Symbol	Min	Typ	Max	Unit	Test Conditions/Comments
Undervoltage Lockout						
V_{DDP}						
Rising Threshold		2.6	2.9	3.0	V	
Falling Threshold		2.1	2.5	2.95	V	
V_{ISO}						
Rising Threshold			3.28		V	
Falling Threshold			2.45		V	
Thermal Shutdown						
Shutdown Temperature			154		°C	
Thermal Hysteresis			10		°C	

¹ Maximum V_{ISO} output current is derated by 2 mA/°C for $T_A > 105^\circ\text{C}$.

Table 6. ADuM6028-3BRIZ DC-to-DC Converter Static Specifications

Parameter	Symbol	Min	Typ	Max	Unit	Test Conditions/Comments
DC-TO-DC CONVERTER SUPPLY						
Setpoint	V_{ISO}	3.135	3.3	3.465	V	$I_{ISO} = 10\text{ mA}$
Line Regulation	$V_{ISO}(\text{LINE})$		2		mV/V	$I_{ISO} = 30\text{ mA}$, $V_{DDP} = 3.0\text{ V to }3.6\text{ V}$
Load Regulation ¹	$V_{ISO}(\text{LOAD})$		1	5	%	$I_{ISO} = 6\text{ mA to }54\text{ mA}$
Output Ripple ¹	$V_{ISO}(\text{RIP})$		50		mV p-p	20 MHz bandwidth, $C_{BO} = 0.1\ \mu\text{F} 10\ \mu\text{F}$, $I_{ISO} = 54\text{ mA}$
Output Noise ¹	$V_{ISO}(\text{NOISE})$		130		mV p-p	$C_{BO} = 0.1\ \mu\text{F} 10\ \mu\text{F}$, $I_{ISO} = 54\text{ mA}$
Switching Frequency	f_{OSC}		180		MHz	
PWM Frequency	f_{PWM}		625		kHz	
Output Supply Current ¹	$I_{ISO}(\text{MAX})$	30			mA	$3.135\text{ V} < V_{ISO} < 3.465\text{ V}$
		60			mA	$3.0\text{ V} < V_{ISO} < 3.465\text{ V}$
Efficiency at $I_{ISO}(\text{MAX})$			33		%	$I_{ISO} = 60\text{ mA}$, $T_A = 25^\circ\text{C}$
V_{DDP} Supply Current						
No V_{ISO} Load	$I_{DDP}(\text{Q})$		5	15	mA	
Full V_{ISO} Load	$I_{DDP}(\text{MAX})$		190		mA	
Undervoltage Lockout						
V_{DDP}						
Rising Threshold		2.6	2.9	3.0	V	
Falling Threshold		2.1	2.5	2.95	V	
V_{ISO}						
Rising Threshold			3.28		V	
Falling Threshold			2.45		V	
Thermal Shutdown						
Shutdown Temperature			154		°C	
Thermal Hysteresis			10		°C	

¹ Maximum V_{ISO} output current is derated by 2 mA/°C for $T_A > 105^\circ\text{C}$.

REGULATORY APPROVALS

Table 7.

UL ¹	CSA	VDE ²	CQC
Recognized Under 1577 Component Recognition Program	Approved under CSA Component Acceptance Notice 5A	DIN V VDE V 0884-10 (VDE V 0884-10):2006-12	Certified under CQC11-471543-2015

SPECIFICATIONS

Table 7.

UL ¹	CSA	VDE ²	CQC
Single Protection, 5000 V rms Isolation Voltage File E214100	CSA 60950-1-07+A1+A2 and IEC 60950-1, second edition, +A1+A2 Basic insulation at 830 V rms (1173 V peak) Reinforced insulation at 415 V rms (586 V peak) IEC 60601-1 Edition 3.1: Reinforced insulation (2 MOPP), 250 V rms (353 V peak) CSA 61010-1-12 and IEC 61010-1 third edition Basic insulation at 600 V rms mains, 830 V secondary (1173 V peak) Reinforced insulation at 300 V rms mains, 415 V secondary (586 V peak) File 205078	Reinforced insulation 565 V peak, surge isolation voltage (V_{IOSM}) = 6250 V peak Transient voltage (V_{IOTM}) = 8000 V peak File 2471900-4880-0001	GB4943.1-2011: Basic insulation at 830 V rms (1174 V peak) Reinforced insulation at 415 V rms (587 V peak) File CQC21001283892 (ADuM6028) File (Pending) (ADuM6020)

¹ In accordance with UL 1577, each ADuM6020 and ADuM6028 are proof tested by applying an insulation test voltage ≥ 6000 V rms for 1 sec.

² In accordance with DIN V VDE V 0884-10, each ADuM6020 and ADuM6028 are proof tested by applying an insulation test voltage ≥ 1059 V peak for 1 sec (partial discharge detection limit = 5 pC). The * marking branded on the component designates DIN V VDE V 0884-10 approval.

INSULATION AND SAFETY RELATED SPECIFICATIONS

For additional information, see www.analog.com/icouplersafety.

Table 8. ADuM6020 Insulation and Safety

Parameter	Symbol	Value	Unit	Test Conditions/Comments
Rated Dielectric Insulation Voltage		5000	V rms	1-minute duration
Minimum External Air Gap (Clearance)	L (I01)	8.3	mm min	Measured from input terminals to output terminals, shortest distance through air
Minimum External Tracking (Creepage)	L (I02)	8.3	mm min	Measured from input terminals to output terminals, shortest distance path along body
Minimum Clearance in the Plane of the Printed Circuit Board (PCB Clearance)	L (PCB)	8.3	mm min	Measured from input terminals to output terminals, shortest distance through air, line of sight, in the PCB mounting plane
Minimum Internal Gap (Internal Clearance)		25.5	μ m min	Insulation distance through insulation
Tracking Resistance (Comparative Tracking Index)	CTI	>600	V	DIN IEC 112/VDE 0303 Part 1
Material Group		I		Material Group (DIN VDE 0110, 1/89, Table 1)

Table 9. ADuM6028 Insulation and Safety

Parameter	Symbol	Value	Unit	Test Conditions/Comments
Rated Dielectric Insulation Voltage		5000	V rms	1-minute duration
Minimum External Air Gap (Clearance)	L (I01)	8.3	mm min	Measured from input terminals to output terminals, shortest distance through air
Minimum External Tracking (Creepage)	L (I02)	8.3	mm min	Measured from input terminals to output terminals, shortest distance path along body
Minimum Clearance in the Plane of the Printed Circuit Board (PCB Clearance)	L (PCB)	8.3	mm min	Measured from input terminals to output terminals, shortest distance through air, line of sight, in the PCB mounting plane
Minimum Internal Gap (Internal Clearance)		25.5	μ m min	Insulation distance through insulation

SPECIFICATIONS

Table 9. ADuM6028 Insulation and Safety

Parameter	Symbol	Value	Unit	Test Conditions/Comments
Tracking Resistance (Comparative Tracking Index)	CTI	>600	V	DIN IEC 112/VDE 0303 Part 1
Material Group		I		Material Group (DIN VDE 0110, 1/89, Table 1)

PACKAGE CHARACTERISTICS

Table 10. ADuM6020 Package Characteristics

Parameter	Symbol	Min	Typ	Max	Unit	Test Conditions/Comments
Resistance (Input to Output) ¹	R _{I-O}		10 ¹³		Ω	
Capacitance (Input to Output) ¹	C _{I-O}		2.2		pF	f = 1 MHz
Input Capacitance ²	C _I		4.0		pF	
IC Junction to Ambient Thermal Resistance	θ _{JA}		45		°C/W	Thermocouple located at center of package underside ³

¹ This device is considered a 2-terminal device: Pin 1 through Pin 8 are shorted together, and Pin 9 through Pin 16 are shorted together.

² Input capacitance is from any input data pin to ground.

³ The value of θ_{JA} is based on devices mounted on a JEDEC JESD-51 standard 2s2p board and still air.

Table 11. ADuM6028 Package Characteristics

Parameter	Symbol	Min	Typ	Max	Unit	Test Conditions/Comments
Resistance (Input to Output) ¹	R _{I-O}		10 ¹³		Ω	
Capacitance (Input to Output) ¹	C _{I-O}		2.2		pF	f = 1 MHz
Input Capacitance ²	C _I		4.0		pF	
IC Junction to Ambient Thermal Resistance	θ _{JA}		80		°C/W	Thermocouple located at center of package underside ³

¹ This device is considered a 2-terminal device: Pin 1 through Pin 4 are shorted together, and Pin 5 through Pin 8 are shorted together.

² Input capacitance is from any input data pin to ground.

³ The value of θ_{JA} is based on devices mounted on a JEDEC JESD-51 standard 2s2p board and still air.

DIN V VDE V 0884-10 (VDE V 0884-10) INSULATION CHARACTERISTICS

These isolators are suitable for reinforced electrical isolation only within the safety limit data. Maintenance of the safety data is ensured by the protective circuits. The asterisk (*) marking on packages denotes DIN V VDE V 0884-10 approval.

Table 12. ADuM6020 VDE Characteristics

Description	Test Conditions/Comments	Symbol	Characteristic	Unit
Installation Classification per DIN VDE 0110			I to IV	
For Rated Mains Voltage ≤ 150 V rms			I to III	
For Rated Mains Voltage ≤ 300 V rms			I to II	
For Rated Mains Voltage ≤ 400 V rms				
Climatic Classification			40/125/21	
Pollution Degree per DIN VDE 0110, Table 1			2	
Maximum Working Insulation Voltage		V _{IORM}	565	V peak
Input to Output Test Voltage, Method b1	V _{IORM} × 1.875 = V _{PR} , 100% production test, t _m = 1 sec, partial discharge < 5 pC	V _{PR}	1059	V peak
Input to Output Test Voltage, Method a				
After Environmental Tests Subgroup 1	V _{IORM} × 1.5 = V _{pd(m)} , t _{ini} = 60 sec, t _m = 10 sec, partial discharge < 5 pC	V _{pd(m)}	848	V peak
After Input or Safety Test Subgroup 2 and Subgroup 3	V _{IORM} × 1.2 = V _{pd(m)} , t _{ini} = 60 sec, t _m = 10 sec, partial discharge < 5 pC	V _{pd(m)}	678	V peak
Highest Allowable Overvoltage	Transient overvoltage, t _{TR} = 10 sec	V _{IOTM}	8000	V peak

SPECIFICATIONS

Table 12. ADuM6020 VDE Characteristics

Description	Test Conditions/Comments	Symbol	Characteristic	Unit
Withstand Isolation Voltage	1 minute withstand rating	V_{ISO}	5000	V rms
Surge Isolation Voltage Reinforced	$V_{IOSM(TEST)} = 10$ kV; 1.2 μ s rise time; 50 μ s, 50% fall time	V_{IOSM}	6250	V peak
Safety Limiting Values	Maximum value allowed in the event of a failure (see Figure 3)			
Case Temperature		T_S	150	$^{\circ}$ C
Total Power Dissipation at 25 $^{\circ}$ C		I_{S1}	2.78	W
Insulation Resistance at T_S	$V_{IO} = 500$ V	R_S	$>10^9$	Ω

Table 13. ADuM6028 VDE Characteristics

Description	Test Conditions/Comments	Symbol	Characteristic	Unit
Installation Classification per DIN VDE 0110			I to IV	
For Rated Mains Voltage ≤ 150 V rms			I to III	
For Rated Mains Voltage ≤ 300 V rms			I to II	
For Rated Mains Voltage ≤ 400 V rms			40/125/21	
Climatic Classification			2	
Pollution Degree per DIN VDE 0110, Table 1				
Maximum Working Insulation Voltage		V_{IORM}	565	V peak
Input to Output Test Voltage, Method b1	$V_{IORM} \times 1.875 = V_{PR}$, 100% production test, $t_m = 1$ sec, partial discharge < 5 pC	V_{PR}	1059	V peak
Input to Output Test Voltage, Method a				
After Environmental Tests Subgroup 1	$V_{IORM} \times 1.5 = V_{pd(m)}$, $t_{ini} = 60$ sec, $t_m = 10$ sec, partial discharge < 5 pC	$V_{pd(m)}$	848	V peak
After Input and/or Safety Test Subgroup 2 and Subgroup 3	$V_{IORM} \times 1.2 = V_{pd(m)}$, $t_{ini} = 60$ sec, $t_m = 10$ sec, partial discharge < 5 pC	$V_{pd(m)}$	678	V peak
Highest Allowable Overvoltage	Transient overvoltage, $t_{TR} = 10$ sec	V_{IOTM}	8000	V peak
Withstand Isolation Voltage	1 minute withstand rating	V_{ISO}	5000	V rms
Surge Isolation Voltage Reinforced	$V_{IOSM(TEST)} = 10$ kV; 1.2 μ s rise time; 50 μ s, 50% fall time	V_{IOSM}	6250	V peak
Safety Limiting Values	Maximum value allowed in the event of a failure (see Figure 4)			
Case Temperature		T_S	150	$^{\circ}$ C
Total Power Dissipation at 25 $^{\circ}$ C		I_{S1}	1.56	W
Insulation Resistance at T_S	$V_{IO} = 500$ V	R_S	$>10^9$	Ω

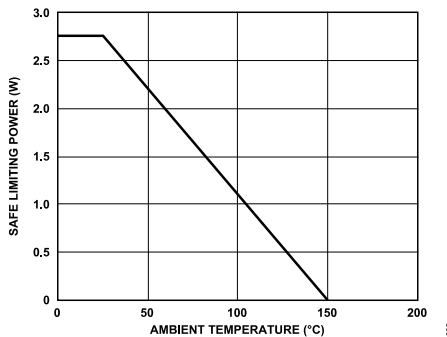

Figure 3. ADuM6020 Thermal Derating Curve, Dependence of Safety Limiting Values with Ambient Temperature, per DIN V VDE V 0884-10

SPECIFICATIONS

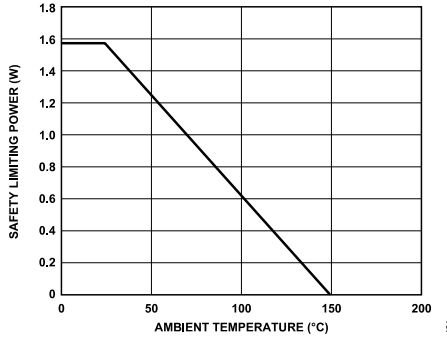

Figure 4. ADuM6028 Thermal Derating Curve, Dependence of Safety Limiting Values with Ambient Temperature per DIN V VDE V 0884-10

RECOMMENDED OPERATING CONDITIONS

Table 14.

Parameter	Symbol	Min	Typ	Max	Unit
Operating Temperature ¹	T_A	-40		+125	°C
Supply Voltages ²	V_{DDP}				
ADuM6020-5BRIZ, ADuM6028-5BRIZ, V_{DDP} at $V_{ISO} = 3.135$ V to 3.465 V		4.5		5.5	V
ADuM6020-3BRIZ, ADuM6028-3BRIZ, V_{DDP} at $V_{ISO} = 3.135$ V to 3.465 V		3.0		3.6	V
ADuM6020-5BRIZ, ADuM6028-5BRIZ, V_{DDP} at $V_{ISO} = 4.75$ V to 5.25 V		4.5		5.5	V

¹ Operation at >85°C requires reduction of the maximum load current.

² Each voltage is relative to its respective ground.

ABSOLUTE MAXIMUM RATINGS

$T_A = 25^\circ\text{C}$, unless otherwise noted.

Table 15.

Parameter	Rating
Storage Temperature (T_{ST})	-55°C to $+150^\circ\text{C}$
Ambient Operating Temperature (T_A)	-40°C to $+125^\circ\text{C}$
Supply Voltages (V_{DDP} , V_{ISO}) ¹	-0.5 V to $+7.0\text{ V}$
V_{ISO} Supply Current	
ADuM6020	100 mA
ADuM6028	60 mA
Input Voltage (PDIS, V_{SEL}) ^{1,2}	-0.5 V to $V_{DDP} + 0.5\text{ V}$
Common-Mode Transients ³	$-200\text{ kV}/\mu\text{s}$ to $+200\text{ kV}/\mu\text{s}$

¹ All voltages are relative to their respective ground.

² V_{DDP} is the input side supply voltage.

³ Common-mode transients refer to common-mode transients across the isolation barrier. Common-mode transients exceeding the absolute maximum ratings may cause latch-up or permanent damage.

Stresses at or above those listed under Absolute Maximum Ratings may cause permanent damage to the product. This is a stress rating only; functional operation of the product at these or any other conditions above those indicated in the operational section of this specification is not implied. Operation beyond the maximum operating conditions for extended periods may affect product reliability.

Table 16. Maximum Continuous Working Voltage Supporting 50-Year Minimum Lifetime¹

Parameter	Max	Unit	Applicable Certification
AC Voltage			
Bipolar Waveform	560>	V peak	50-year operation
Unipolar Waveform			
Basic Insulation	560	V peak	50-year operation
DC Voltage			
Basic Insulation	1000	V peak	50-year operation
Reinforced Insulation	830	V peak	Limited by creepage

¹ Maximum continuous working voltage refers to the continuous voltage magnitude imposed across the isolation barrier. See the [Insulation Lifetime](#) section for more information.

ESD CAUTION



ESD (electrostatic discharge) sensitive device. Charged devices and circuit boards can discharge without detection. Although this product features patented or proprietary protection circuitry, damage may occur on devices subjected to high energy ESD. Therefore, proper ESD precautions should be taken to avoid performance degradation or loss of functionality.

PIN CONFIGURATION AND FUNCTION DESCRIPTIONS

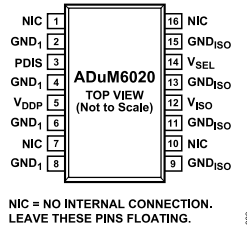

Figure 5. ADuM6020 Pin Configuration

Table 17. ADuM6020 Pin Function Descriptions

Pin No.	Mnemonic	Description
1, 7, 10, 16	NIC	No Internal Connection. Leave these pins floating.
2, 4, 6, 8	GND ₁	Ground 1. Ground reference for the primary. It is recommended that these pins be connected to a common ground.
3	PDIS	Power Disable. When tied to any GND ₁ pin, the V _{ISO} output voltage is active. When a logic high voltage is applied, the V _{ISO} output voltage is shut down. Do not leave this pin floating.
5	V _{DDP}	Primary Supply Voltage. The supply range is 4.5 V to 5.5 V for the ADuM6020-5 models and 3.0 V to 3.6 V for the ADuM6020-3 models.
9, 11, 13, 15	GND _{ISO}	Ground Reference for V _{ISO} on Side 2. It is recommended that these pins be connected to a common ground.
12	V _{ISO}	Secondary Supply Voltage Output for External Loads.
14	V _{SEL}	Output Voltage Selection. Connect V _{SEL} to V _{ISO} for 5 V output or connect V _{SEL} to GND _{ISO} for 3.3 V output. This pin has a weak internal pull-up. Therefore, do not leave this pin floating. It is recommended that the ADuM6020-3BRIZ be used only for 3.3 V input to 3.3 V output operation. Therefore, connect V _{SEL} to GND _{ISO} .

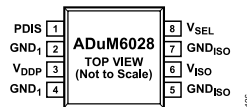

Figure 6. ADuM6028 Pin Configuration

Table 18. ADuM6028 Pin Function Descriptions

Pin No.	Mnemonic	Description
1	PDIS	Power Disable. When tied to any GND ₁ pin, the V _{ISO} output voltage is active. When a logic high voltage is applied, the V _{ISO} output voltage is shut down. Do not leave this pin floating.
2, 4	GND ₁	Ground 1. Ground reference for the primary. It is recommended that these pins be connected to a common ground.
3	V _{DDP}	Primary Supply Voltage. The supply range is 4.5 V to 5.5 V for the ADuM6028-5 models and 3.0 V to 3.6 V for the ADuM6028-3 models.
5, 7	GND _{ISO}	Ground Reference for V _{ISO} on Side 2. It is recommended that these pins be connected together.
6	V _{ISO}	Secondary Supply Voltage Output for External Loads.
8	V _{SEL}	Output Voltage Selection. Connect V _{SEL} to V _{ISO} for 5 V output or connect V _{SEL} to GND _{ISO} for 3.3 V output. This pin has a weak internal pull-up. Therefore, do not leave this pin floating. It is recommended that the ADuM6028-3BRIZ be used only for 3.3 V input to 3.3 V output operation. Therefore, connect V _{SEL} to GND _{ISO} .

TRUTH TABLE

Table 19. Truth Table (Positive Logic)

V _{DDP} (V)	V _{SEL} Input	PDIS Input	V _{ISO} Output (V)	Notes
5	High	Low	5	
5	Low	Low	3.3	
5	Don't care	High	0	
3.3	Low	Low	3.3	
3.3	High	Low	5	Configuration not recommended
3.3	Don't care	High	0	

TYPICAL PERFORMANCE CHARACTERISTICS

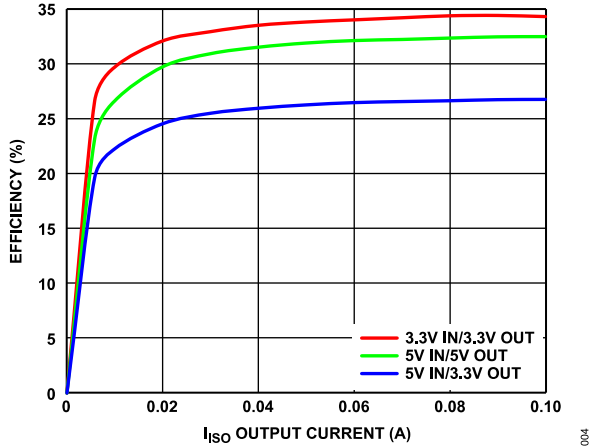

Figure 7. Typical Power Supply Efficiency in Supported Supply Configurations

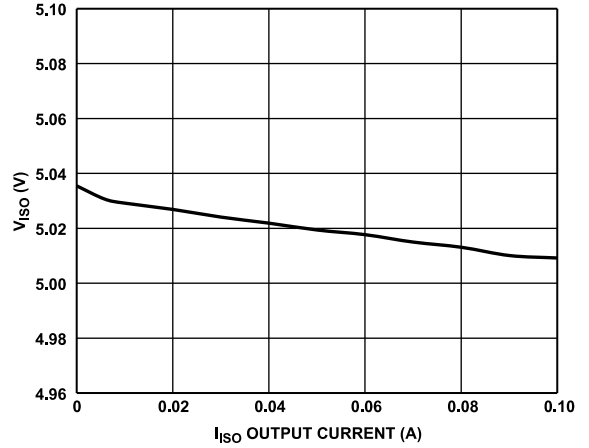

Figure 10. V_{ISO} vs. I_{ISO} Output Current, Input = 5 V, V_{ISO} = 5 V

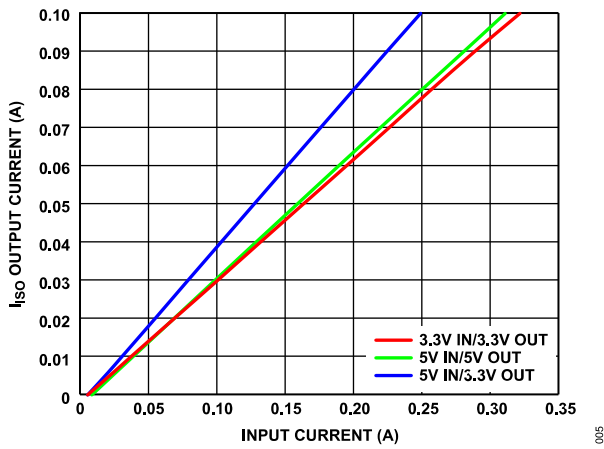

Figure 8. I_{ISO} Output Current vs. Input Current in Supported Power Configurations

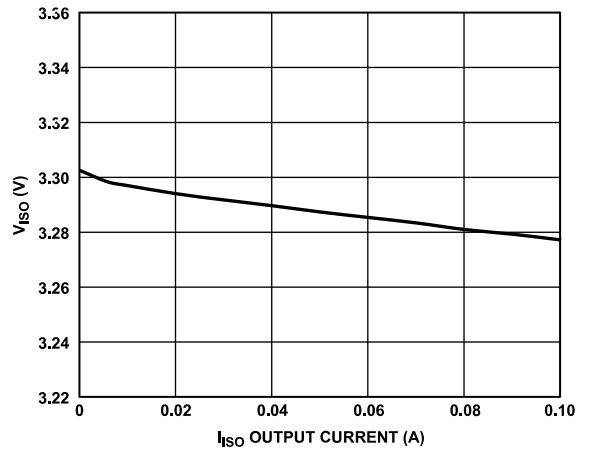

Figure 11. V_{ISO} vs. I_{ISO} Output Current, Input = 5 V, V_{ISO} = 3.3 V

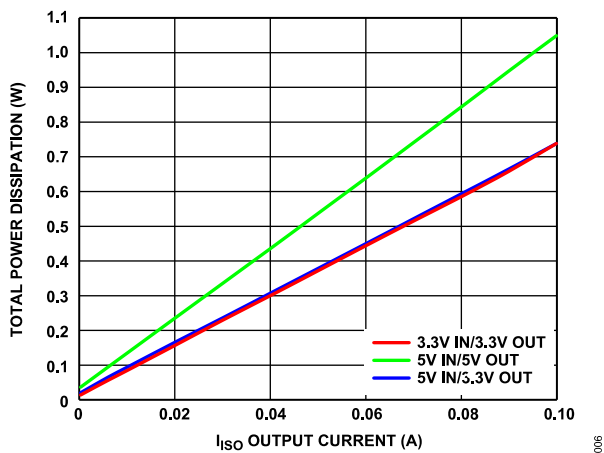

Figure 9. Total Power Dissipation vs. I_{ISO} Output Current in Supported Power Configurations

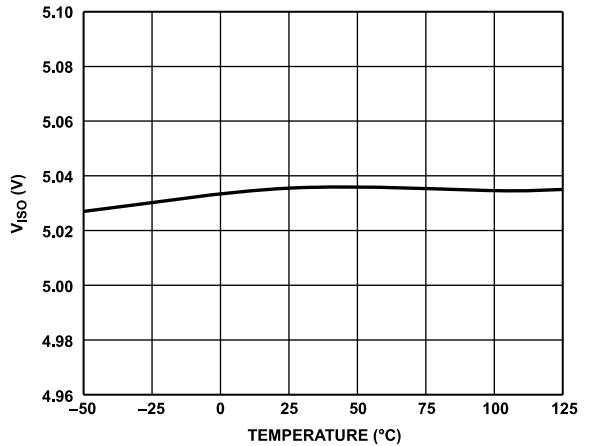

Figure 12. V_{ISO} vs. Temperature, Input = 5 V, V_{ISO} Output = 5 V

TYPICAL PERFORMANCE CHARACTERISTICS

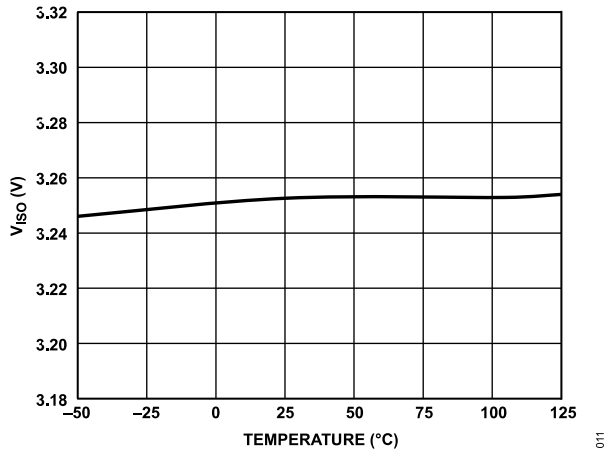

Figure 13. V_{ISO} vs. Temperature, Input = 3.3 V, V_{ISO} Output = 3.3 V

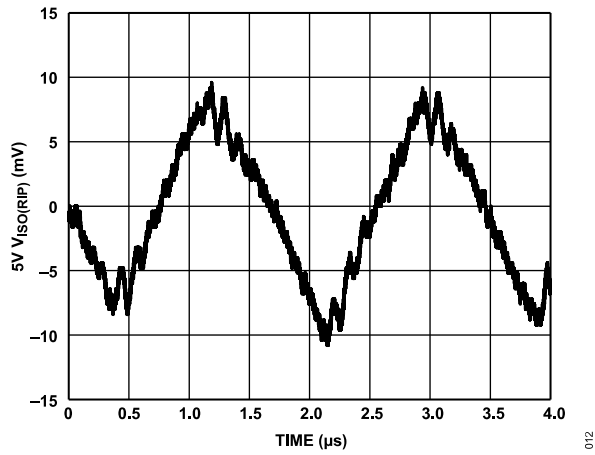

Figure 14. V_{ISO} Ripple, 5 V Input to 5 V Output at 90% Load, Bandwidth = 20 MHz

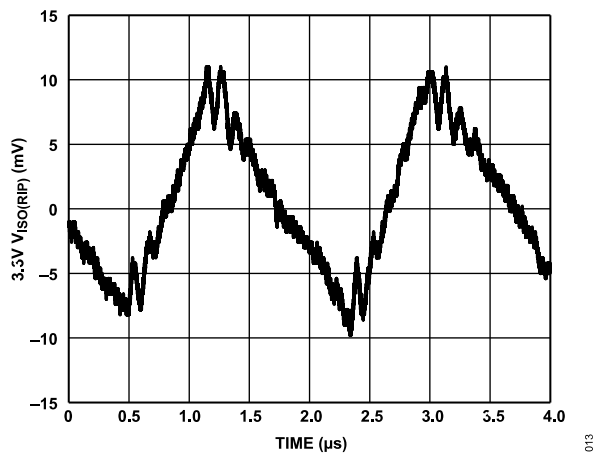

Figure 15. V_{ISO} Ripple, 5 V Input to 3.3 V Output at 90% Load, Bandwidth = 20 MHz

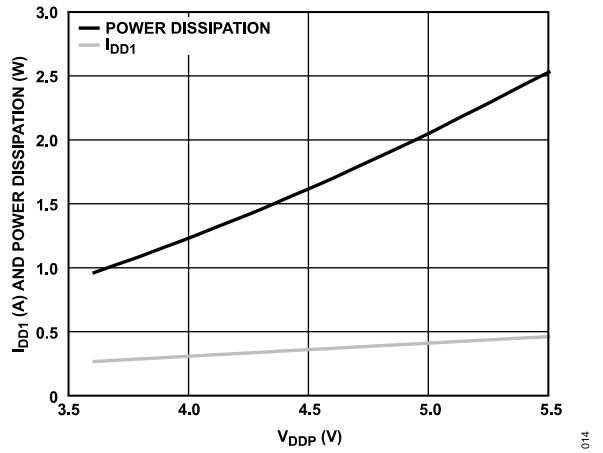

Figure 16. Short-Circuit Input Current (I_{DD1}) and Power Dissipation vs. V_{DDP}

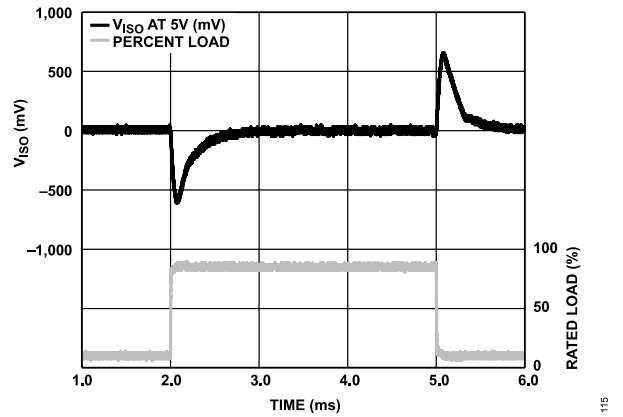

Figure 17. V_{ISO} Transient Load Response, 5 V Input to 5 V Output, 10% to 90% Load Step

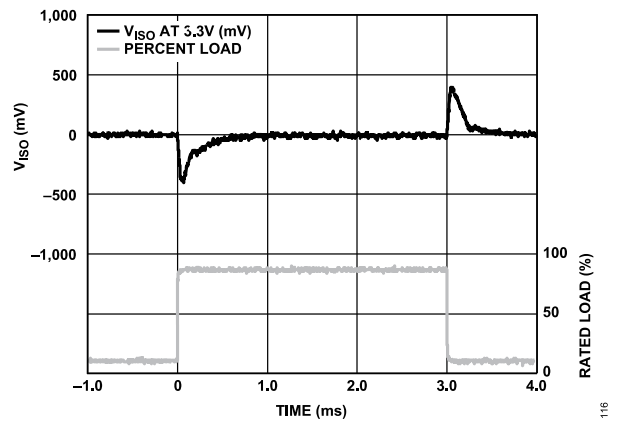

Figure 18. V_{ISO} Transient Load Response, 5 V Input to 3.3 V Output, 10% to 90% Load Step

TYPICAL PERFORMANCE CHARACTERISTICS

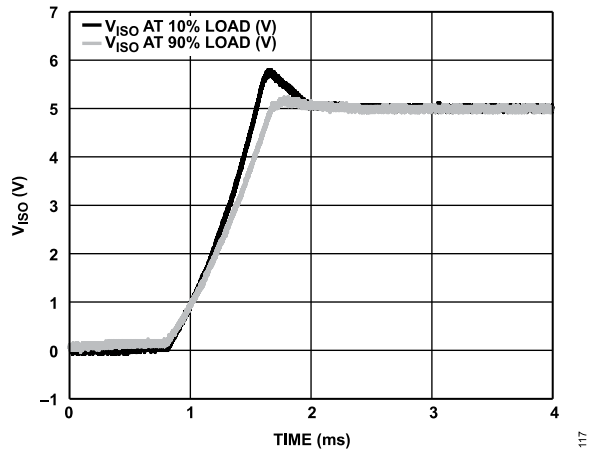

Figure 19. 5 V Input to 5 V Output V_{ISO} Start-Up Transient at 10% and 90% Load

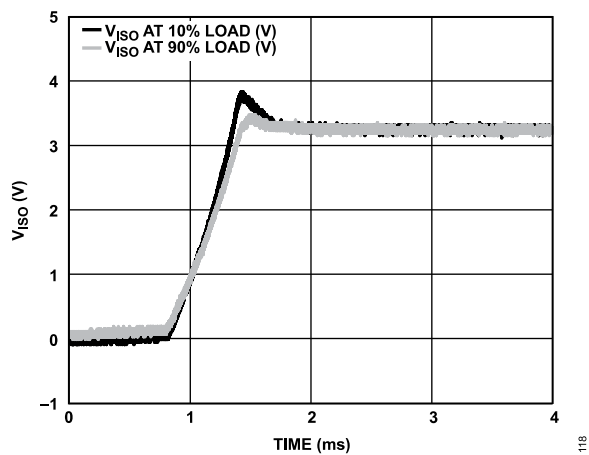

Figure 20. 5 V Input to 3.3 V Output V_{ISO} Start-Up Transient at 10% and 90% Load

THEORY OF OPERATION

The ADuM6020/ADuM6028 dc-to-dc converters work on principles that are common to most standard power supplies. The converters have a split controller architecture with isolated PWM feedback.

V_{DDP} power is supplied to an oscillating circuit that switches current into a chip scale air core transformer. Power transferred to the secondary side is rectified and regulated to 3.3 V or 5.0 V, depending on the setting of the V_{SEL} pin. Note that the ADuM6020-3BRIZ and the ADuM6028-3BRIZ can only be used for 3.3 V input to 3.3 V output applications, and the ADuM6020-5BRIZ and the ADuM6028-5BRIZ operate best for 5 V input applications. The secondary (V_{ISO}) side controller regulates the output by creating a PWM control signal that is sent to the primary (V_{DDP}) side by a dedicated iCoupler data channel. The PWM modulates the oscillator circuit to control the power being sent to the secondary side. Feedback allows significantly higher power and efficiency.

The ADuM6020/ADuM6028 implement undervoltage lockout (UVLO) with hysteresis on the primary and secondary side input and output pins. The UVLO feature ensures that the converters do not go into oscillation due to noisy input power or slow power-on ramp rates.

APPLICATIONS INFORMATION

PCB LAYOUT

The ADuM6020/ADuM6028 isoPower integrated dc-to-dc converters require power supply bypassing at the input and output supply pins (see Figure 21 and Figure 22). Low effective series resistance (ESR) 0.1 μF bypass capacitors are required between the V_{DDP} pin and GND₁ pin, as close to the chip pads as possible. Low ESR 0.1 μF or 0.22 μF capacitors are required between the V_{ISO} pin and GND_{ISO} pin, as close to the chip pads as possible (see the C_{ISO} note in Figure 23 and Figure 24 for more information). The isoPower inputs require multiple passive components to bypass the power effectively, as well as set the output voltage and bypass the core voltage regulator (see Figure 21 through Figure 26).

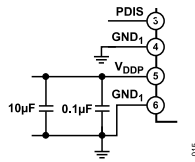

Figure 21. ADuM6020 V_{DDP} Bias and Bypass Components

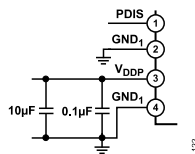

Figure 22. ADuM6028 V_{DDP} Bias and Bypass Components

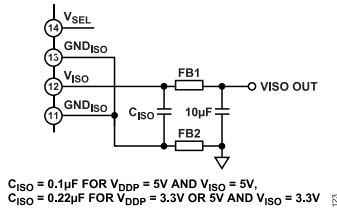

Figure 23. ADuM6020 V_{ISO} Bias and Bypass Components

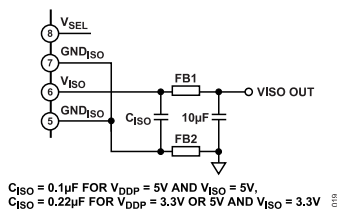

Figure 24. ADuM6028 V_{ISO} Bias and Bypass Components

The power supply section of the ADuM6020/ADuM6028 uses a 180 MHz oscillator frequency to efficiently pass power through its chip scale transformers. Bypass capacitors are required for several operating frequencies. Noise suppression requires a low inductance, high frequency capacitor, whereas ripple suppression and proper regulation require a large value capacitor. These capacitors are most conveniently connected between the V_{DDP} pin and GND₁ pin, and between the V_{ISO} pin and GND_{ISO} pin. To suppress noise and reduce ripple, a parallel combination of at least two capacitors

is required. The recommended capacitor values are 0.1 μF and 10 μF for V_{DDP}. The smaller capacitor must have a low ESR. For example, use of a ceramic capacitor is advised. The total lead length between the ends of the 0.1 μF low ESR capacitors, and the power supply pins must not exceed 2 mm.

To reduce the level of electromagnetic radiation, the impedance to high frequency currents between the V_{ISO} and GND_{ISO} pins and the PCB trace connections can be increased. Using this method of electromagnetic interference (EMI) suppression controls the radiating signal at its source by placing surface-mount ferrite beads in series with the V_{ISO} and GND_{ISO} pins, as shown in Figure 25 and Figure 26. The impedance of the ferrite bead is chosen to be about 1.8 kΩ between the 100 MHz and 1 GHz frequency range to reduce the emissions at the 180 MHz primary switching frequency and the 360 MHz secondary side rectifying frequency and harmonics. See Table 20 for examples of appropriate surface-mount ferrite beads.

Table 20. Surface-Mount Ferrite Beads Example

Manufacturer	Part No.	Size	DCR (Ω)
Taiyo Yuden	BKH1005LM182-T	0402	2.0
Murata Electronics	BLM15HD182SN1	0402	2.2
Murata Electronics	BLM18HE152SN1	0602	0.5

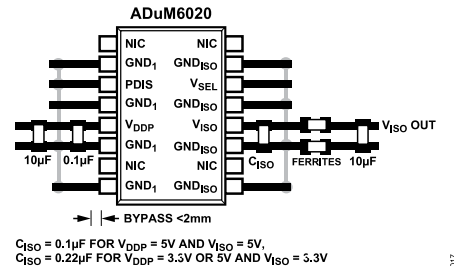

C_{ISO} = 0.1μF FOR V_{DDP} = 5V AND V_{ISO} = 5V,
C_{ISO} = 0.22μF FOR V_{DDP} = 3.3V OR 5V AND V_{ISO} = 3.3V

Figure 25. Recommended ADuM6020 PCB Layout

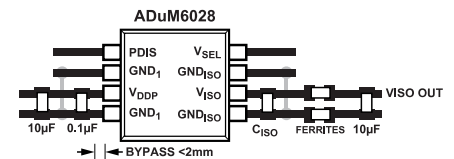

C_{ISO} = 0.1μF FOR V_{DDP} = 5V AND V_{ISO} = 5V,
C_{ISO} = 0.22μF FOR V_{DDP} = 3.3V OR 5V AND V_{ISO} = 3.3V

Figure 26. Recommended ADuM6028 PCB Layout

In applications involving high common-mode transients, ensure that board coupling across the isolation barrier is minimized. Furthermore, design the board layout such that any coupling that does occur equally affects all pins on a given component side. Failure to ensure these steps can cause voltage differentials between pins, exceeding the absolute maximum ratings specified in Table 15, thereby leading to latch-up or permanent damage.

THERMAL ANALYSIS

The ADuM6020/ADuM6028 each consists of three internal die attached to a split lead frame. For thermal analysis, the die is treated as a thermal unit, with the highest junction temperature reflected in

APPLICATIONS INFORMATION

the θ_{JA} values, shown in [Table 10](#) and [Table 11](#). The value of θ_{JA} is based on measurements taken with the devices mounted on a JEDEC standard, 4-layer board with fine width traces and still air. Under normal operating conditions, the ADuM6020/ADuM6028 can operate at full load, but at temperatures greater than 85°C, derating the output current may be needed, as shown in [Figure 3](#) and [Figure 4](#).

EMI CONSIDERATIONS

The ADuM6020/ADuM6028 dc-to-dc converters must, of necessity, operate at a high frequency to allow efficient power transfer through the small transformers. This high frequency operation creates high frequency currents that can propagate in circuit board ground and power planes, requiring proper power supply bypassing at the input and output supply pins (see [Figure 25](#) and [Figure 26](#)). Using proper layout, bypassing techniques, and surface-mount ferrite beads in series with the V_{ISO} and GND_{ISO} pins, the dc-to-dc converters are designed to provide regulated, isolated power that is below CISPR22 Class B limits at full load on a 2-layer PCB with ferrites.

INSULATION LIFETIME

All insulation structures eventually break down when subjected to voltage stress over a sufficiently long period. The rate of insulation degradation is dependent on the characteristics of the voltage waveform applied across the insulation, as well as on the materials and material interfaces.

The two types of insulation degradation of primary interest are breakdown along surfaces exposed to the air and insulation wear out. Surface breakdown is the phenomenon of surface tracking and the primary determinant of surface creepage requirements in system level standards. Insulation wear out is the phenomenon where charge injection or displacement currents inside the insulation material cause long-term insulation degradation.

Surface Tracking

Surface tracking is addressed in electrical safety standards by setting a minimum surface creepage based on the working voltage, the environmental conditions, and the properties of the insulation material. Safety agencies perform characterization testing on the surface insulation of components that allows the components to be categorized in different material groups. Lower material group ratings are more resistant to surface tracking and, therefore, can provide adequate lifetime with smaller creepage. The minimum creepage for a given working voltage and material group is in each system level standard and is based on the total rms voltage across the isolation, pollution degree, and material group. The material group and creepage for the ADuM6020 and ADuM6028 are presented in [Table 8](#) and [Table 9](#).

Insulation Wear Out

The lifetime of insulation caused by wear out is determined by its thickness, material properties, and the voltage stress applied. It

is important to verify that the product lifetime is adequate at the application working voltage. The working voltage supported by an isolator for wear out may not be the same as the working voltage supported for tracking. The working voltage applicable to tracking is specified in most standards.

Testing and modeling show that the primary driver of long-term degradation is displacement current in the polyimide insulation causing incremental damage. The stress on the insulation can be grouped into broad categories, such as dc stress, which causes very little wear out because there is no displacement current, and an ac component time varying voltage stress, which causes wear out.

The ratings in certification documents are usually based on a 60 Hz sinusoidal waveform because this stress reflects isolation from line voltage. However, many practical applications have combinations of 60 Hz ac and dc across the barrier as shown in [Equation 1](#). Because only the ac portion of the stress causes wear out, the equation can be rearranged to solve for the ac rms voltage, as shown in [Equation 2](#). For insulation wear out with the polyimide materials used in these products, the ac rms voltage determines the product lifetime.

$$V_{RMS} = \sqrt{V_{AC\ RMS}^2 + V_{DC}^2} \quad (1)$$

or

$$V_{AC\ RMS} = \sqrt{V_{RMS}^2 - V_{DC}^2} \quad (2)$$

where:

V_{RMS} is the total rms working voltage.

$V_{AC\ RMS}$ is the time varying portion of the working voltage.

V_{DC} is the dc offset of the working voltage.

Calculation and Use of Parameters Example

The following example frequently arises in power conversion applications. Assume that the line voltage on one side of the isolation is 240 V ac rms and a 400 V dc bus voltage is present on the other side of the isolation barrier. The isolator material is polyimide. To establish the critical voltages in determining the creepage, clearance, and lifetime of a device, see [Figure 27](#) and the following equations.

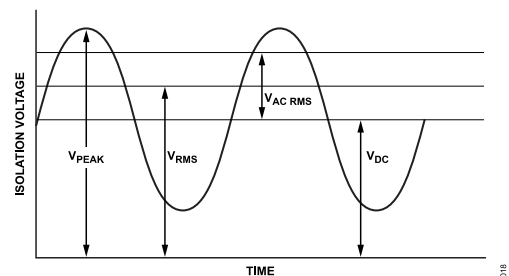

Figure 27. Critical Voltage Example

The working voltage across the barrier from [Equation 1](#) is

APPLICATIONS INFORMATION

$$V_{RMS} = \sqrt{V_{AC\ RMS}^2 + V_{DC}^2}$$

$$V_{RMS} = \sqrt{240^2 + 400^2}$$

$$V_{RMS} = 466\ \text{V}$$

This V_{RMS} value is the working voltage used together with the material group and pollution degree when looking up the creepage required by a system standard.

To determine if the lifetime is adequate, obtain the time varying portion of the working voltage. To obtain the ac rms voltage, use Equation 2.

$$V_{AC\ RMS} = \sqrt{V_{RMS}^2 - V_{DC}^2}$$

$$V_{AC\ RMS} = \sqrt{466^2 - 400^2}$$

$$V_{AC\ RMS} = 240\ \text{V rms}$$

In this case, the ac rms voltage is simply the line voltage of 240 V rms. This calculation is more relevant when the waveform is not sinusoidal. The value is compared to the limits for working voltage in Table 16 for the expected lifetime, which is less than a 60 Hz sine wave, and it is well within the limit for a 50-year service life.

Note that the dc working voltage limit is set by the creepage of the package as specified in IEC 60664-1. This value can differ for specific system level standards.

START-UP BEHAVIOR AND POWER SEQUENCING

The start-up behavior of the isolated dc-to-dc converter is dependent on several external factors, including input voltage ramp rate, source current capability, output voltage level, and output load impedance. In general, the power-on sequence expects the output voltage to be near 0 V and the input voltage to transition from near 0 V to the rated operating voltage with a positive monotonic characteristic.

When the external input voltage rises above the internal UVLO voltage, the primary side of the dc-to-dc converter begins to turn on. Because the output is not powered on at this point and therefore not able to provide any feedback information, the regulator PWM circuit is ramped in a linear fashion from 0% duty cycle toward 100% duty cycle, effectively ramping the output voltage from zero to full open circuit voltage. This ramping is commonly referred to as a slow start, a technique used in power conversion circuits where insufficient information is available to the regulator to properly control the start-up process. This technique has the secondary benefit of limiting the input transient (inrush) current caused by capacitive loading.

As the output voltage rises, the secondary side UVLO threshold is crossed, enabling the feedback circuits. When the output voltage reaches its setpoint, 3.3 V or 5 V, the secondary side feedback synchronizes with the primary side PWM and takes over control

to regulate the output voltage. The synchronization process takes a finite amount of time, which results in the output voltage overshooting the programmed voltage. The amount of overshoot is dependent on the load. At light loads, the overshoot tends to be higher than at the rated load and generally does not exceed the expected voltage by more than 10% to 20%. This behavior can be observed in Figure 19 and Figure 20.

Several conditions can cause the start-up process to not proceed as previously described, potentially resulting in excessive output voltage overshoot. The two most common conditions to avoid are multiple transitions of the input supply voltage above and below the input UVLO threshold during the slow start time and the output voltage starting above the secondary side UVLO point when the turn-on process is initiated.

A nonmonotonic input voltage during turn-on can be caused by several reasons. It can be an intentional, repeated turn-on and turn-off of the input voltage or toggling of the PDIS pin, or it can be due to insufficient input decoupling capacitance or high source impedance, causing the input voltage to droop during the time the output capacitance is being charged. The input current can be much higher than the steady state operation during the turn-on of the converter due to the load capacitance and must be considered at the system level.

An output voltage higher than the secondary UVLO point during turn-on can also be an issue. This issue is commonly caused by excessive output decoupling capacitance that is unable to discharge below the UVLO point between power-down and power-up cycles. This issue can also be caused by an output voltage being externally forced during turn-on to be higher than the secondary UVLO point. It is recommended that the output decoupling capacitance be kept to $\leq 33\ \mu\text{F}$ and to allow sufficient time for the output voltage to decay to near zero before reapplying the input voltage.

If these operating conditions for proper turn-on cannot be met due to system constraints or otherwise, it is recommended to observe the output voltage during startup in the application for all operating conditions. If voltage overshoot that exceeds approximately 6 V is observed, it is recommended to add a 6.2 V Zener diode from V_{ISO} to GND_{ISO} .

OUTLINE DIMENSIONS

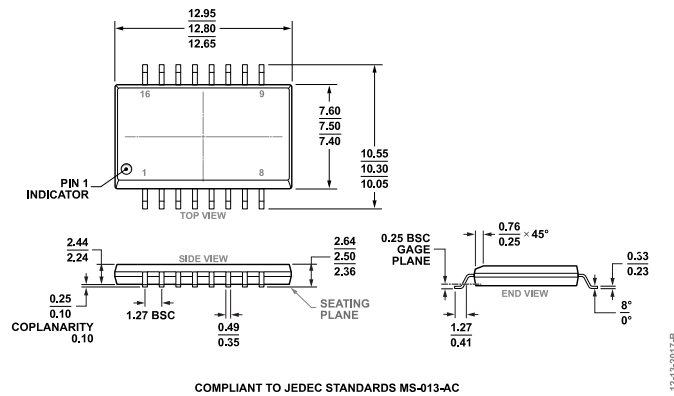

Figure 28. 16-Lead Standard Small Outline Package, with Increased Creepage [SOIC_IC] Wide Body (RI-16-2) Dimensions shown in millimeters

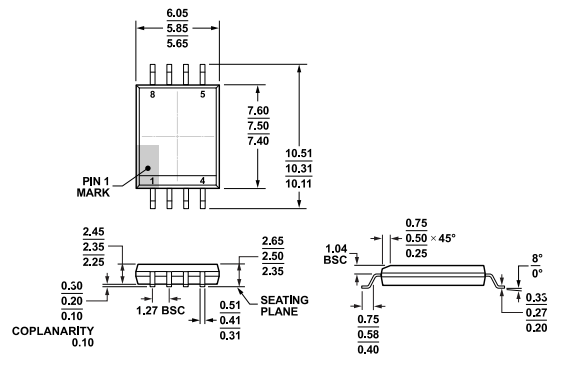

Figure 29. 8-Lead Standard Small Outline Package, with Increased Creepage [SOIC_IC] Wide Body (RI-8-1) Dimensions shown in millimeters

Updated: March 17, 2022

ORDERING GUIDE

Model ¹	Temperature Range	Package Description	Packing Quantity	Package Option
ADUM6020-3BRIZ	-40°C to +125°C	16-Lead SOIC (Increased Creepage)	Tube	RI-16-2
ADUM6020-3BRIZ-RL	-40°C to +125°C	16-Lead SOIC (Increased Creepage)	Reel, 1000	RI-16-2
ADUM6020-5BRIZ	-40°C to +125°C	16-Lead SOIC (Increased Creepage)	Tube	RI-16-2
ADUM6020-5BRIZ-RL	-40°C to +125°C	16-Lead SOIC (Increased Creepage)	Reel, 1000	RI-16-2
ADUM6020-5WBRIZ	-40°C to +125°C	16-Lead SOIC (Increased Creepage)	Tube	RI-16-2
ADUM6020-5WBRIZ-RL	-40°C to +125°C	16-Lead SOIC (Increased Creepage)	Reel, 1000	RI-16-2
ADUM6028-3BRIZ	-40°C to +125°C	8-Lead SOIC (Increased Creepage)	Tube	RI-8-1
ADUM6028-3BRIZ-RL	-40°C to +125°C	8-Lead SOIC (Increased Creepage)	Reel, 1500	RI-8-1
ADUM6028-5BRIZ	-40°C to +125°C	8-Lead SOIC (Increased Creepage)	Tube	RI-8-1
ADUM6028-5BRIZ-RL	-40°C to +125°C	8-Lead SOIC (Increased Creepage)	Reel, 1500	RI-8-1
ADUM6028-5WBRIZ	-40°C to +125°C	8-Lead SOIC (Increased Creepage)	Tube	RI-8-1
ADUM6028-5WBRIZ-RL	-40°C to +125°C	8-Lead SOIC (Increased Creepage)	Reel, 1500	RI-8-1

¹ Z = RoHS Compliant Part.

OUTLINE DIMENSIONS

EVALUATION BOARDS

Model ^{1, 2, 3}	Description
EVAL-ADuM5020EBZ	ADuM5020 Evaluation Board
EVAL-ADuM5028EBZ	ADuM5028 Evaluation Board

¹ Z = RoHZ Compliant Part.

² The [EVAL-ADuM5020EBZ](#) is packaged with the [ADuM5020-5BRWZ](#) installed and can be used for evaluating the ADuM6020.

³ The [EVAL-ADuM5028EBZ](#) is packaged with the [ADuM5028-5BRIZ](#) installed and can be used for evaluating the ADuM6028.

AUTOMOTIVE PRODUCTS

The ADuM6020-5W and ADuM6028-5W models are available with controlled manufacturing to support the quality and reliability requirements of automotive applications. Note that the automotive models may have specifications that differ from the commercial models; therefore, designers should review the [Specifications](#) section of this data sheet carefully. Only the automotive grade products shown are available for use in automotive applications. Contact your local Analog Devices account representative for specific product ordering information and to obtain the specific Automotive Reliability reports for these models.