



# High Accuracy $\pm 1 g$ to $\pm 5 g$ Single Axis *i*MEMS<sup>®</sup> Accelerometer with Analog Input

## ADXL105\*

### FEATURES

- Monolithic IC Chip
- 2 mg Resolution
- 10 kHz Bandwidth
- Flat Amplitude Response ( $\pm 1\%$ ) to 5 kHz
- Low Bias and Sensitivity Drift
- Low Power 2 mA
- Output Ratiometric to Supply
- User Scalable  $g$  Range
- On-Board Temperature Sensor
- Uncommitted Amplifier
- Surface Mount Package
- +2.7 V to +5.25 V Single Supply Operation
- 1000  $g$  Shock Survival

### APPLICATIONS

- Automotive
- Accurate Tilt Sensing with Fast Response
- Machine Health and Vibration Measurement
- Affordable Inertial Sensing of Velocity and Position
- Seismic Sensing
- Rotational Acceleration

### GENERAL DESCRIPTION

The ADXL105 is a high performance, high accuracy and complete single-axis acceleration measurement system on a single monolithic IC. The ADXL105 offers significantly increased bandwidth and reduced noise versus previously available micro-machined devices. The ADXL105 measures acceleration with a full-scale range up to  $\pm 5 g$  and produces an analog voltage output. Typical noise floor is  $225 \mu g/\sqrt{\text{Hz}}$  allowing signals below 2 mg to be resolved. A 10 kHz wide frequency response enables vibration measurement applications. The product exhibits significant reduction in offset and sensitivity drift over temperature compared to the ADXL05.

### FUNCTIONAL BLOCK DIAGRAM

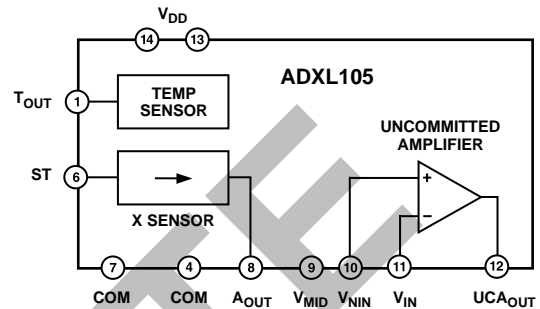

The ADXL105 can measure both dynamic accelerations, (typical of vibration) or static accelerations (such as inertial force, gravity or tilt).

Output scale factors from 250 mV/g to 1.5 V/g are set using the on-board uncommitted amplifier and external resistors. The device features an on-board temperature sensor with an output of 8 mV/°C for optional temperature compensation of offset vs. temperature for high accuracy application.

The ADXL105 is available in a hermetic 14-lead surface mount Cerpak with versions specified for the 0°C to +70°C, and -40°C to +85°C temperature ranges.

\*Patent Pending.

*i*MEMS is a registered trademark of Analog Devices, Inc.

### REV. A

Information furnished by Analog Devices is believed to be accurate and reliable. However, no responsibility is assumed by Analog Devices for its use, nor for any infringements of patents or other rights of third parties which may result from its use. No license is granted by implication or otherwise under any patent or patent rights of Analog Devices.

One Technology Way, P.O. Box 9106, Norwood, MA 02062-9106, U.S.A.  
Tel: 781/329-4700 World Wide Web Site: <http://www.analog.com>  
Fax: 781/326-8703 © Analog Devices, Inc., 1999

# ADXL105—SPECIFICATIONS ( $T_A = T_{MIN}$ to $T_{MAX}$ , $T_A = +25^\circ\text{C}$ for J Grade Only, $V_S = +5\text{ V}$ , @ Acceleration = $0\text{ g}$ , unless otherwise noted)

| Parameter  | Conditions                                | ADXL105J/A |      |                       | Units                 |
|--|---|------------|------|-----------------------|-----------------------|
|  |   | Min        | Typ  | Max                   |                       |
| <b>SENSOR INPUT</b>                                |   |            |      |                       |                       |
| Measurement Range <sup>1</sup>                     | Best Fit Straight Line<br>Z Axis, @ +25°C | ±5         | ±7   |                       | g                     |
| Nonlinearity                                       |   |            | 0.2  |                       | % of FS               |
| Alignment Error <sup>2</sup>                       |   |            | ±1   |                       | Degrees               |
| Cross Axis Sensitivity <sup>3</sup>                |   |            | ±1   | ±5                    | %                     |
| <b>SENSITIVITY<sup>4</sup> (Ratiometric)</b>       |   |            |      |                       |                       |
| Initial  | At A <sub>OUT</sub>                       | 225        | 250  | 275                   | mV/g                  |
| vs. Temperature <sup>5, 6</sup>                    | V <sub>S</sub> = 2.7 V                    | 80         | 105  | 120                   | mV/g                  |
|  |   |            | ±0.5 |                       | %                     |
| <b>ZERO g BIAS LEVEL<sup>5</sup> (Ratiometric)</b> |   |            |      |                       |                       |
| Zero g Offset Error                                | At A <sub>OUT</sub>                       | -625       |      | +625                  | mV                    |
| vs. Supply   | From +2.5 V Nominal                       | -20        |      | +20                   | mV/V <sub>DD</sub> /V |
| vs. Temperature <sup>5, 7</sup>                    |   |            | 50   |                       | mV                    |
| <b>NOISE PERFORMANCE</b>                           |   |            |      |                       |                       |
| Voltage Density <sup>7</sup>                       | @ +25°C                                   |            | 225  | 325                   | μg/√Hz                |
| Noise in 100 Hz Bandwidth                          |   |            | 2.25 |                       | mg rms                |
| <b>FREQUENCY RESPONSE</b>                          |   |            |      |                       |                       |
| 3 dB Bandwidth                                     |   | 10         | 12   |                       | kHz                   |
| Sensor Resonant Frequency                          |   | 13         | 18   |                       | kHz                   |
| <b>TEMP SENSOR<sup>4</sup> (Ratiometric)</b>       |   |            |      |                       |                       |
| Output Error at +25°C                              | From +2.5 V Nominal                       | -100       |      | +100                  | mV                    |
| Nominal Scale Factor                               |   |            | 8    |                       | mV/°C                 |
| Output Impedance                                   |   |            | 10   |                       | kΩ                    |
| <b>V<sub>MID</sub><sup>4</sup> (Ratiometric)</b>   |   |            |      |                       |                       |
| Output Error                                       | From +2.5 V Nominal                       | -15        |      | +15                   | mV                    |
| Output Impedance                                   |   |            | 10   |                       | kΩ                    |
| <b>SELF-TEST (Proportional to V<sub>DD</sub>)</b>  |   |            |      |                       |                       |
| Voltage Delta at A <sub>OUT</sub>                  | Self-Test "0" to "1"                      | 100        |      | 500                   | mV                    |
| Input Impedance <sup>8</sup>                       |   | 30         | 50   |                       | kΩ                    |
| <b>A<sub>OUT</sub></b>                             |   |            |      |                       |                       |
| Output Drive                                       | I = ±50 μA                                | 0.50       |      | V <sub>S</sub> - 0.5  | V                     |
| Capacitive Load Drive                              |   | 1000       |      |                       | pF                    |
| <b>UNCOMMITTED AMPLIFIER</b>                       |   |            |      |                       |                       |
| Initial Offset                                     |   | -25        |      | +25                   | mV                    |
| Initial Offset vs. Temperature                     |   |            | 5    |                       | μV/°C                 |
| Common-Mode Range                                  |   | 1.0        |      | 4.0                   | V                     |
| Input Bias Current <sup>9</sup>                    |   |            | 25   |                       | nA                    |
| Open Loop Gain                                     |   |            | 100  |                       | V/mV                  |
| Output Drive                                       | I = ±100 μA                               | 0.25       |      | V <sub>S</sub> - 0.25 | V                     |
| Capacitive Load Drive                              |   | 1000       |      |                       | pF                    |
| <b>POWER SUPPLY</b>                                |   |            |      |                       |                       |
| Operating Voltage Range                            |   | 2.70       |      | 5.25                  | V                     |
| Quiescent Supply Current                           | At 5.0 V                                  |            | 1.9  | 2.6                   | mA                    |
|  | At 2.7 V                                  |            | 1.3  | 2.0                   | mA                    |
| Turn-On Time                                       |   |            | 700  |                       | μs                    |
| <b>TEMPERATURE RANGE</b>                           |   |            |      |                       |                       |
| Operating Range J                                  |   | 0          |      | +70                   | °C                    |
| Specified Performance A                            |   | -40        |      | +85                   | °C                    |

## NOTES

<sup>1</sup>Guaranteed by tests of zero g bias, sensitivity and output swing.

<sup>2</sup>Alignment of the X axis is with respect to the long edge of the bottom half of the Cerpak package.

<sup>3</sup>Cross axis sensitivity is measured with an applied acceleration in the Z axis of the device.

<sup>4</sup>This parameter is ratiometric to the supply voltage V<sub>DD</sub>. Specification is shown with a 5.0 V V<sub>DD</sub>. To calculate approximate values at another V<sub>DD</sub>, multiply the specification by V<sub>DD</sub>/5 V.

<sup>5</sup>Specification refers to the maximum change in parameter from its initial value at +25°C to its worst case value at T<sub>MIN</sub> to T<sub>MAX</sub>.

<sup>6</sup>See Figure 3.

<sup>7</sup>See Figure 2.

<sup>8</sup>CMOS and TTL Compatible.

<sup>9</sup>UCA input bias current is tested at final test.

All min and max specifications are guaranteed. Typical specifications are not tested or guaranteed.

Specifications subject to change without notice.

### ABSOLUTE MAXIMUM RATINGS\*

|  |                  |
|--|------------------|
| Acceleration (Any Axis, Unpowered for 0.5 ms) . . . . .        | 1000 g           |
| Acceleration (Any Axis, Powered for 0.5 ms) . . . . .          | 500 g            |
| +V <sub>S</sub> . . . . .                                      | -0.3 V to +7.0 V |
| Output Short Circuit Duration<br>(Any Pin to Common) . . . . . | Indefinite       |
| Operating Temperature . . . . .                                | -55°C to +125°C  |
| Storage Temperature . . . . .                                  | -65°C to +150°C  |

\*Stresses above those listed under Absolute Maximum Ratings may cause permanent damage to the device. This is a stress rating only; the functional operation of the device at these or any other conditions above those indicated in the operational sections of this specification is not implied. Exposure to absolute maximum rating conditions for extended periods may affect device reliability.

### Package Characteristics

| Package        | $\theta_{JA}$ | $\theta_{JC}$ | Device Weight |
|----------------|---------------|---------------|---------------|
| 14-Lead Cerpak | 110°C/W       | 30°C/W        | <2 Grams      |

### ORDERING GUIDE

| Model      | Temperature Range | Package Option |
|------------|-------------------|----------------|
| ADXL105JQC | 0°C to +70°C      | QC-14          |
| ADXL105AQC | -40°C to +85°C    | QC-14          |

### CAUTION

ESD (electrostatic discharge) sensitive device. Electrostatic charges as high as 4000 V readily accumulate on the human body and test equipment and can discharge without detection. Although the ADXL105 features proprietary ESD protection circuitry, permanent damage may occur on devices subjected to high energy electrostatic discharges. Therefore, proper ESD precautions are recommended to avoid performance degradation or loss of functionality.



Drops onto hard surfaces can cause shocks of greater than 1000 g and exceed the absolute maximum rating of the device. Care should be exercised in handling to avoid damage.

### PIN FUNCTION DESCRIPTIONS

| Pin No. | Name               | Description                          |
|---------|--------------------|--------------------------------------|
| 1       | T <sub>OUT</sub>   | Temperature Sensor Output            |
| 2, 3, 5 | NC                 | No Connect                           |
| 4       | COM                | Common                               |
| 6       | ST                 | Self-Test                            |
| 7       | COM                | Common (Substrate)                   |
| 8       | A <sub>OUT</sub>   | Accelerometer Output                 |
| 9       | V <sub>MID</sub>   | V <sub>DD</sub> /2 Reference Voltage |
| 10      | V <sub>NIN</sub>   | Uncommitted Amp Noninverting Input   |
| 11      | V <sub>IN</sub>    | Uncommitted Amp Inverting Input      |
| 12      | UCA <sub>OUT</sub> | Uncommitted Amp Output               |
| 13, 14  | V <sub>DD</sub>    | Power Supply Voltage                 |

### PIN CONFIGURATION

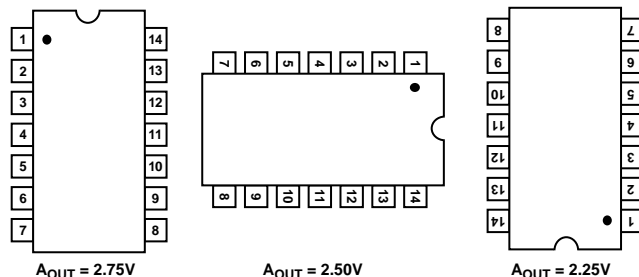
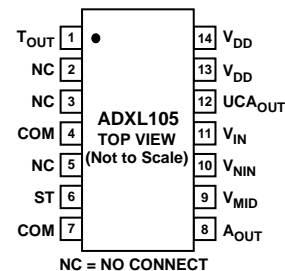

Figure 1. ADXL105 Response Due to Gravity

# ADXL105—Typical Performance Characteristics

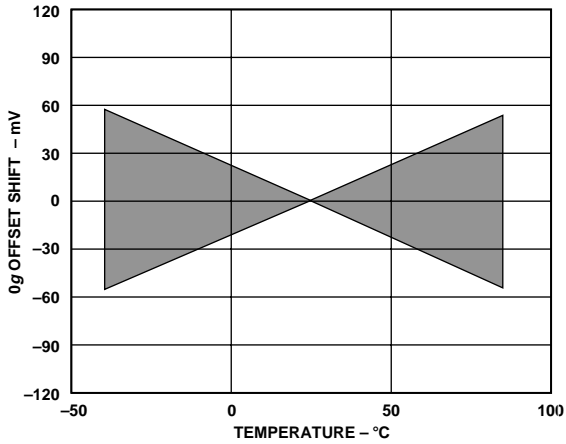

Figure 2. Typical 0 g Shift vs. Temperature\*

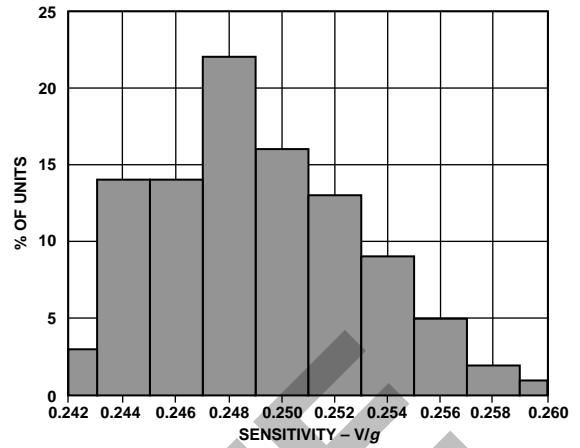

Figure 5. Sensitivity Distribution\*

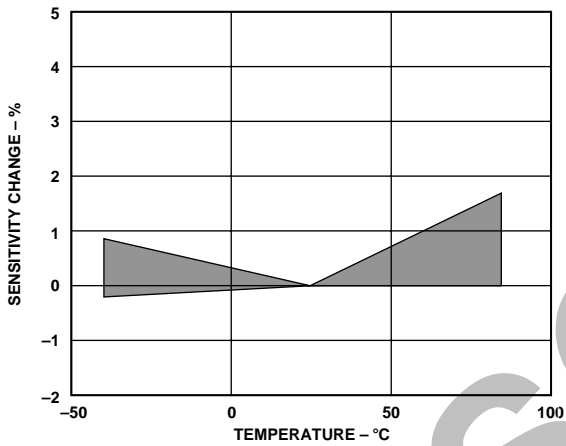

Figure 3. Typical Sensitivity Shift vs. Temperature\*

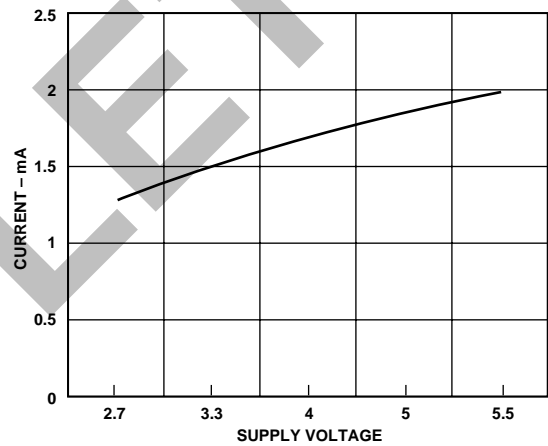

Figure 6. Typical Supply Current vs. Supply Voltage

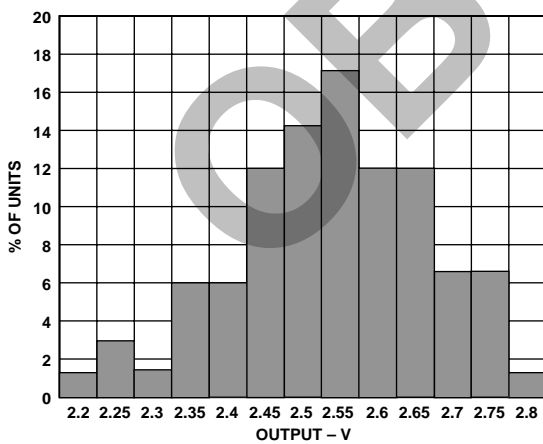

Figure 4. 0 g Output Distribution\*

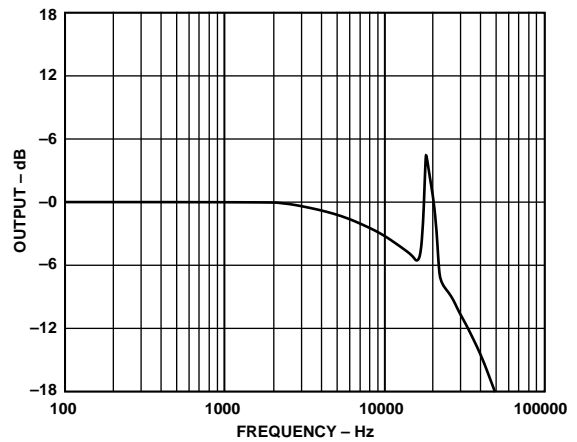

Figure 7. Noise Graph

\*Data from several characterization lots.

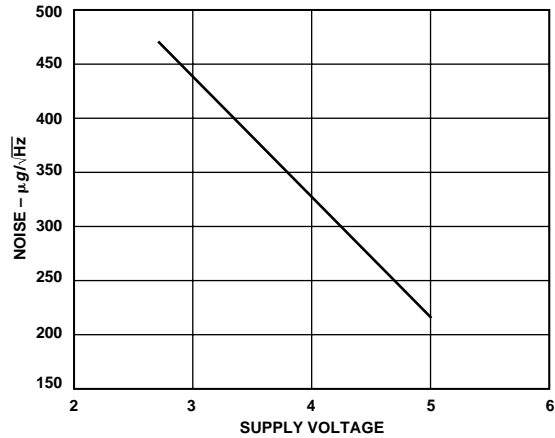

Figure 8. Typical Noise Density vs. Supply Voltage

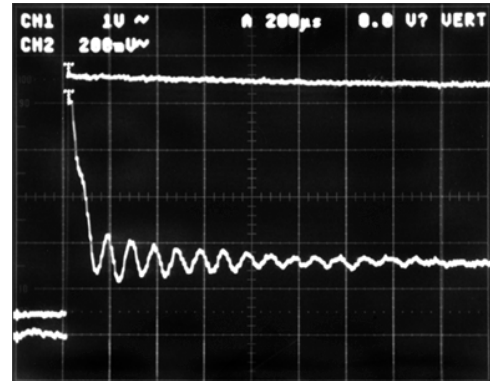

Figure 11. Typical Self-Test Response at  $V_{DD} = 5V$

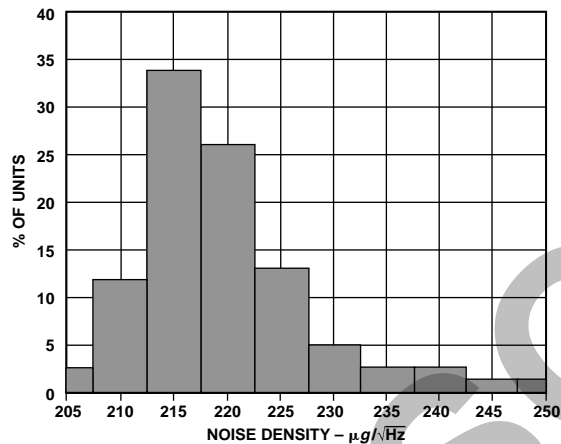

Figure 9. Noise Distribution\*

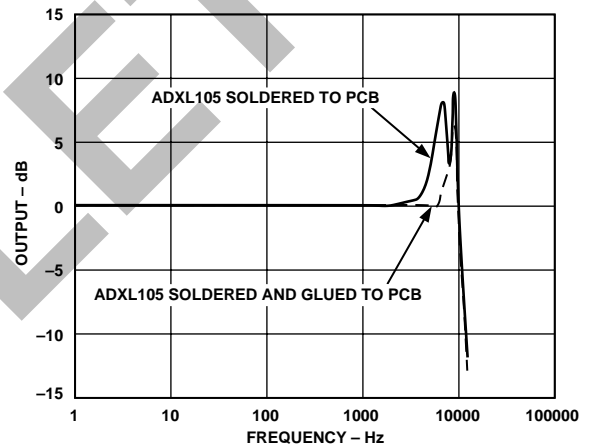

Figure 12. Frequency Response



Figure 10. Rotational Die Alignment\*

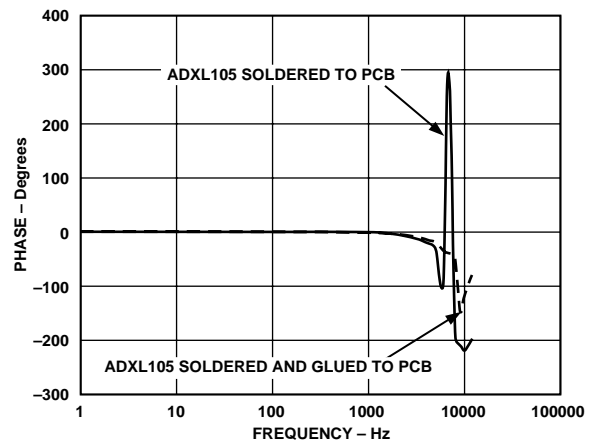

Figure 13. Phase Response

\*Data from several characterization lots.

# ADXL105

## THEORY OF OPERATION

The ADXL105 is a complete acceleration measurement system on a single monolithic IC. It contains a polysilicon surface-micromachined sensor and BiMOS signal conditioning circuitry to implement an open loop acceleration measurement architecture. The ADXL105 is capable of measuring both positive and negative accelerations to a maximum level of  $\pm 5 g$ . The accelerometer also measures static acceleration such as gravity, allowing it to be used as a tilt sensor.

The sensor is a surface micromachined polysilicon structure built on top of the silicon wafer. Polysilicon springs suspend the structure over the surface of the wafer and provide a resistance against acceleration-induced forces. Deflection of the structure is measured with a differential capacitor structure that consists of two independent fixed plates and a central plate attached to the moving mass. A  $180^\circ$  out-of-phase square wave drives the fixed plates. An acceleration causing the beam to deflect, will unbalance the differential capacitor resulting in an output square wave whose amplitude is proportional to acceleration. Phase sensitive demodulation techniques are then used to rectify the signal and determine the direction of the acceleration.

An uncommitted amplifier is supplied for setting the output scale factor, filtering and other analog signal processing.

A ratiometric voltage output temperature sensor measures the exact die temperature and can be used for optional calibration of the accelerometer over temperature.

### $V_{DD}$

The ADXL105 has two power supply ( $V_{DD}$ ) pins, 13 and 14. The two pins should be connected directly together. The output of the ADXL105 is ratiometric to the power supply. Therefore a  $0.22 \mu F$  decoupling capacitor between  $V_{DD}$  and COM is required to reduce power supply noise. To further reduce noise, insert a resistor (and/or a ferrite bead) in series with the  $V_{DD}$  pin. See the EMC and Electrical Noise section for more details.

### COM

The ADXL105 has two common (COM) pins, 4 and 7. These two pins should be connected directly together and Pin 7 grounded.

### ST

The ST pin (Pin 6) controls the self-test feature. When this pin is set to  $V_{DD}$ , an electrostatic force is exerted on the beam of the accelerometer causing the beam to move. The change in output resulting from movement of the beam allows the user to test for mechanical and electrical functionality. This pin may be left open-circuit or connected to common in normal use. The self-test input is CMOS and TTL compatible.

### $A_{OUT}$

The accelerometer output (Pin 8) is set to a nominal scale factor of  $250 \text{ mV/g}$  (for  $V_{DD} = 5 \text{ V}$ ). Note that  $A_{OUT}$  is guaranteed to source/sink a minimum of  $50 \mu A$  (approximately  $50 \text{ k}\Omega$  output impedance). So a buffer may be required between  $A_{OUT}$  and some A-to-D converter inputs.

### $V_{MID}$

$V_{MID}$  is nominally  $V_{DD}/2$ . It is primarily intended for use as a reference output for the on board uncommitted amplifier (UCA) as shown in Figures 14a and 14b. Its output impedance is approximately  $10 \text{ k}\Omega$ .

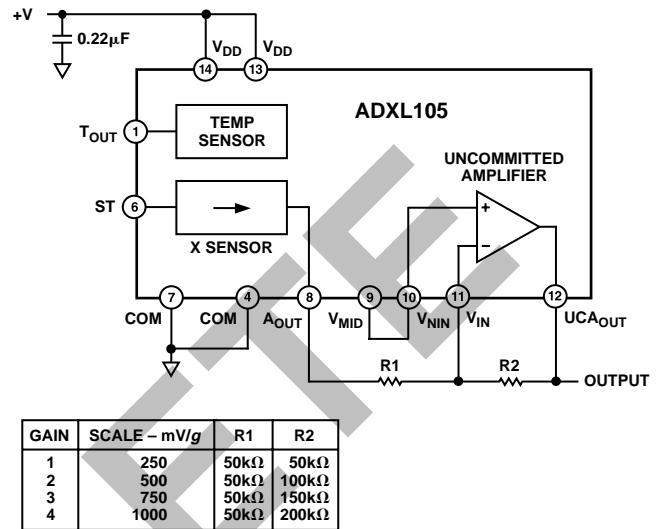

a. Using the UCA to Change the Scale Factor

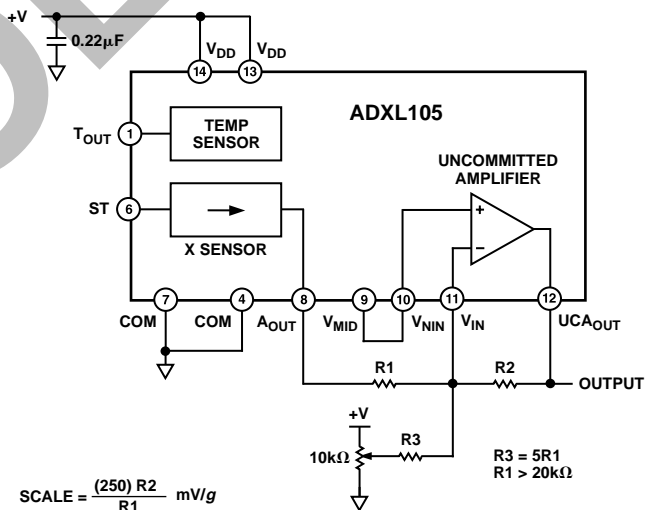

b. Using the UCA to Change the Scale Factor and Zero g Bias

Figure 14. Application Circuit for Increasing Scale Factor

### $T_{OUT}$

The temperature sensor output is nominally  $2.5 \text{ V}$  at  $+25^\circ\text{C}$  and typically changes  $8 \text{ mV}/^\circ\text{C}$ , and is optimized for repeatability rather than accuracy. The output is ratiometric with supply voltage.

### Uncommitted Amplifier (UCA)

The uncommitted amplifier has a low noise, low drift bipolar front end design. The UCA can be used to change the scale factor of the ADXL105 as shown in Figure 14. The UCA may also be used to add a 1- or 2-pole active filter as shown in Figures 15a through 15d.

## Output Scaling

The acceleration output ( $A_{OUT}$ ) of the ADXL105 is nominally 250 mV/g. This scale factor may not be appropriate for all applications. The UCA may be used to increase the scale factor. The simplest implementation would be as shown in Figure 14a.

Since the 0 g offset of the ADXL105 is  $2.5\text{ V} \pm 625\text{ mV}$ , using a gain of greater than 4 could result in having the UCA output at 0 V or 5 V at 0 g. The solution is to add R3 and VR1, as shown in Figure 14b, turning the UCA into a summing amplifier. VR1 is adjusted such that the UCA output is  $V_{DD}/2$  at 0 g.

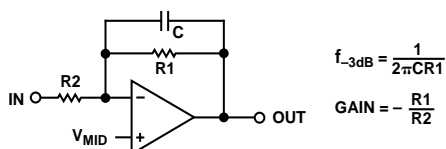

$$f_{-3dB} = \frac{1}{2\pi CR1}$$

$$GAIN = -\frac{R1}{R2}$$

a. 1-Pole Low-Pass Filter

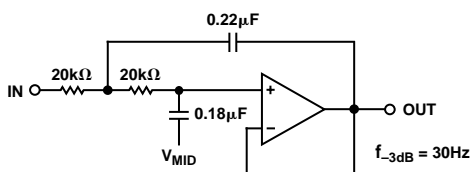

$$f_{-3dB} = 30\text{Hz}$$

b. 2-Pole Bessel Low-Pass Filter

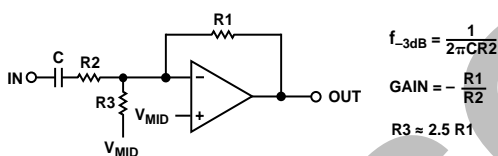

$$f_{-3dB} = \frac{1}{2\pi CR2}$$

$$GAIN = -\frac{R1}{R2}$$

$$R3 \approx 2.5 R1$$

c. 1-Pole High-Pass Filter

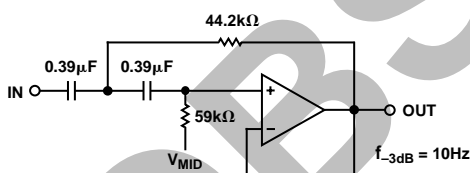

$$f_{-3dB} = 10\text{Hz}$$

d. 2-Pole Bessel High-Pass Filter

Figure 15. UCA Used as Active Filters\*

## Device Bandwidth vs. Resolution

In general the bandwidth selected will determine the noise floor and hence, the measurement resolution (smallest detectable acceleration) of the ADXL105. Since the noise of the ADXL105 has the characteristic of white Gaussian noise that contributes equally at all frequencies, the noise amplitude may be reduced by simply reducing the bandwidth. So the typical noise of the ADXL105 is:

$$Noise (rms) = (225 \mu g/\sqrt{Hz}) \times (\sqrt{Bandwidth \times K})$$

Where

$K \approx 1.6$  for a single-pole filter

$K \approx 1.4$  for a 2-pole filter

\*For other corner frequencies, consult an active filter handbook.

So given a bandwidth of 1000 Hz, the typical rms noise floor of an ADXL105 will be:

$$Noise = (225 \mu g/\sqrt{Hz}) \times (\sqrt{1000 \times 1.6})$$

$$= 9\text{ mg rms for a single-pole filter}$$

and

$$Noise = (225 \mu g/\sqrt{Hz}) \times (\sqrt{1000 \times 1.4})$$

$$= 8.4\text{ mg rms for 2-pole filter}$$

Often the peak value of the noise is desired. Peak-to-peak noise can only be estimated by statistical means. Table I may be used for estimating the probabilities of exceeding various peak values given the rms value. The peak-to-peak noise value will give the best estimate of the uncertainty in a single measurement.

Table I. Estimation of Peak-to-Peak Noise

| Nominal Peak-to-Peak Value | % of Time that Noise Will Exceed Peak-to-Peak Value |
|----------------------------|---|
| 2 × rms                    | 32%   |
| 3 × rms                    | 13%   |
| 4 × rms                    | 4.6%  |
| 5 × rms                    | 1.2%  |
| 6 × rms                    | 0.27%   |
| 7 × rms                    | 0.047%  |
| 8 × rms                    | 0.0063%   |

The UCA may be configured to act as an active filter with gain and 0 g offset control as shown in Figure 16.

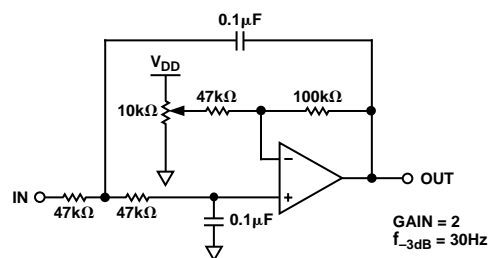

$$GAIN = 2$$

$$f_{-3dB} = 30\text{Hz}$$

Figure 16. UCA Configured as an Active Low-Pass Filter with Gain and Offset

## EMC and Electrical Noise

The design of the ADXL105 is such that EMI or magnetic fields do not normally affect it. Since the ADXL105 is ratiometric, conducted electrical noise on  $V_{DD}$  does affect the output. This is particularly true for noise at the ADXL105's internal clock frequency (200 kHz) and its odd harmonics. So maintaining a clean supply voltage is key in preserving the low noise and high resolution properties of the ADXL105.

One way to ensure that  $V_{DD}$  contains no high frequency noise is to add an R-C low-pass filter near the  $V_{DD}$  pin as shown in Figure 17. Using the component values shown in Figure 17, noise at 200 kHz is attenuated by approximately -23 dB. Assuming the ADXL105 consumes 2 mA, there will be a 100 mV drop across R1. This can be neglected simply by using the ADXL105's  $V_{DD}$  as the A-to-D converter's reference voltage as shown in Figure 17.

# ADXL105

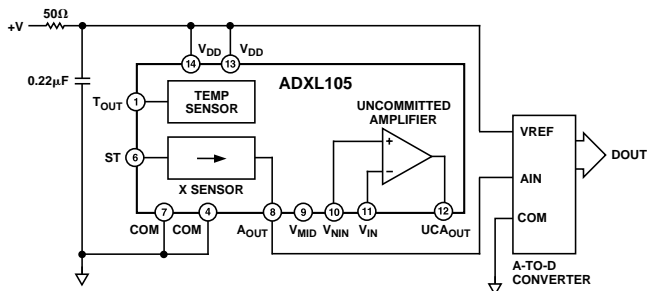

Figure 17. Reducing Noise on  $V_{DD}$

## Dynamic Operation

In applications where only dynamic accelerations (vibration) are of interest, it is often best to ac-couple the accelerometer output as shown in Figures 15c and 15d. The advantage of ac coupling is that 0g offset variability (part to part) and drifts are eliminated.

## Low Power Operation

The most straightforward method of lowering the ADXL105's power consumption is to minimize its supply voltage. By lowering  $V_{DD}$  from 5 V to 2.7 V the power consumption goes from 9.5 mW to 3.5 mW. There may be reasons why lowering the supply voltage is impractical in many applications, in which case the best way to minimize power consumption is by power cycling.

The ADXL105 is capable of turning on and giving an accurate reading within 700  $\mu$ s (see Figure 18). Most microcontrollers can perform an A-to-D conversion in under 25  $\mu$ s. So it is practical to turn on the ADXL105 and take a reading in under 750  $\mu$ s. Given a 100 Hz sample rate the average current required at 2.7 V would be:

$$100 \text{ samples/s} \times 750 \mu\text{s} \times 1.3 \text{ mA} = 97.5 \mu\text{A}$$

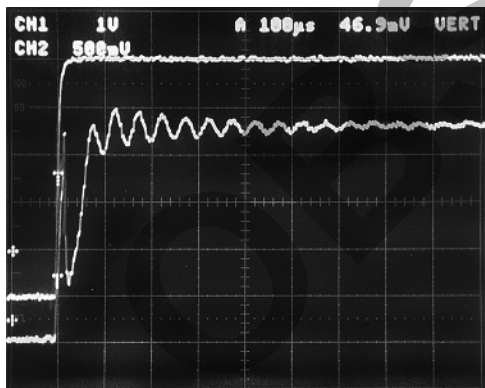

Figure 18. Typical Turn-On Response at  $V_{DD} = 5 \text{ V}$

Note that if a filter is used in the UCA, sufficient time must be allowed for the settling of the filter as well.

## Broadband Operation

The ADXL105 has a number of characteristics that permits operation over a wide frequency range. Its frequency and phase response is essentially flat from dc to 10 kHz (see Figures 12 and 13). Its sensitivity is also constant over temperature (see Figure 3). In contrast, most accelerometers do not have linear response at low frequencies (in many cases, no response at very low frequencies or dc), and often have a large sensitivity temperature coefficient that must be compensated for. In addition, the ADXL105's noise floor is essentially flat from dc to

5 kHz where it gently rolls off (see Figure 7). The beam resonance at 16 kHz can be seen in Figure 7 where there is a small noise peak (+5 dB) at the beam's resonant frequency. There are no other significant noise peaks at any frequency.

The resonant frequency of the beam in the ADXL105 determines its high frequency limit. However the resonant frequency of the Cerpak package is typically around 7 kHz. As a result, it is not unusual to see 6 dB peaks occurring at the package resonant frequency (as shown in Figures 12 and 13). Indeed, the PCB will often have one or more resonant peaks well below 7 kHz. Therefore, if the application calls for accurate operation at or above 6 kHz the ADXL105 should be glued to the PCB in order to eliminate the amplitude response peak due to the package, and careful consideration should be given to the PCB mechanical design.

## CALIBRATING THE ADXL105

The initial value of the offset and scale factor for the ADXL105 will require dc calibration for applications such as tilt measurement.

For low  $g$  applications, the force of gravity is the most stable, accurate and convenient acceleration reference available. An approximate reading of the 0  $g$  point can be determined by orienting the device parallel to the Earth's surface and then reading the output. For high accuracy, a calibrated fixture must be used to ensure exact 90 degree orientation to the 1  $g$  gravity signal.

An accurate sensitivity calibration method is to make a measurement at +1  $g$  and -1  $g$ . The sensitivity can be determined by the two measurements. This method has the advantage of being less sensitive to the alignment of the accelerometer because the on axis signal is proportional to the Cosine of the angle. For example, a 5° error in the orientation results in only a 0.4% error in the measurement.

To calibrate, the accelerometer measurement axis is pointed directly at the Earth. The 1  $g$  reading is saved and the sensor is turned 180° to measure -1  $g$ . Using the two readings and sensitivity is calculated:

$$\text{Sensitivity} = [1 \text{ g Reading} - (-1 \text{ g Reading})]/2 \text{ V/g}$$

## OUTLINE DIMENSIONS

Dimensions shown in inches and (mm).

### 14-Lead Cerpak (QC-14)

