

FEATURES

- $\pm 200 g$ measurement range**
- 160 Hz to 2560 Hz user selectable bandwidth with four-pole antialiasing filter**
- Selectable oversampling ratio**
- Adjustable high-pass filter**
- Ultra low power**
 - Power can be derived from a coin cell battery**
 - 28 μA at 2560 Hz ODR, 3.3 V supply**
 - Low power, wake-up mode for low g activity detection**
 - 1.7 μA instant on mode with adjustable threshold**
 - <0.1 μA standby mode**
- Built in features for system level power savings**
 - Autonomous interrupt processing without processor intervention**
- Ultra low power event monitoring detects impacts and wakes up fast enough to capture the transient events**
- Adjustable, low g threshold activity and inactivity detection**
- Wide operating voltage range: 2.5 V to 3.5 V**
- Acceleration sample synchronization via external trigger**
- SPI digital interface and I²C interface format support**
- 12-bit output at 100 mg/LSB scale factor**
- Wide temperature range: $-40^{\circ}C$ to $+105^{\circ}C$**
- Small, thin, 3 mm \times 3.25 mm \times 1.06 mm package**

APPLICATIONS

- Impact and shock detection**
- Asset health assessment**
- Portable Internet of Things (IoT) edge nodes**
- Concussion and head trauma detection**

GENERAL DESCRIPTION

The ADXL371 is an ultra low power, 3-axis, $\pm 200 g$ microelectromechanical system (MEMS) accelerometer that consumes 28 μA at a 2560 Hz output data rate (ODR). The ADXL371 does not power cycle its front end to achieve its low power operation and therefore does not run the risk of aliasing the output of the sensor.

In addition to its ultra low power consumption, the ADXL371 enables impact detection while providing system level power reduction. Two additional lower power modes with interrupt driven, wake-up features are available for monitoring motion during periods of inactivity. In wake-up mode, acceleration data can be averaged to obtain a low enough output noise to trigger on low g thresholds. In instant on mode, the ADXL371 consumes 1.7 μA while continuously monitoring the environment for impacts. When an impact event that exceeds the internally set threshold is detected, the device switches to normal operating mode fast enough to record the event.

High g applications tend to experience acceleration content over a wide range of frequencies. The ADXL371 includes a four-pole, low-pass antialiasing filter to attenuate out of band signals that are common in high g applications. The ADXL371 also incorporates a high-pass filter to eliminate initial and slow changing errors, such as ambient temperature drift.

The ADXL371 provides 12-bit output data at a 100 mg/LSB scale factor. The user can access configuration and data registers via the serial peripheral interface (SPI) or I²C protocol. The ADXL371 operates over a wide supply voltage range and is available in a 3 mm \times 3.25 mm \times 1.06 mm package.

In this data sheet, multifunction pin names may be referenced by their relevant function only.

FUNCTIONAL BLOCK DIAGRAM

Figure 1.

TABLE OF CONTENTS

Features	1	SPI and I ² C Timing Information.....	24
Applications.....	1	Register Map	27
General Description	1	Register Details	29
Functional Block Diagram	1	Analog Devices ID Register	29
Revision History	3	Analog Devices MEMS ID Register.....	29
Specifications.....	4	Device ID Register	29
Absolute Maximum Ratings.....	6	Product Revision ID Register	29
Thermal Resistance	6	Status Register.....	30
Recommended Soldering Profile	6	Activity Status Register.....	30
Electrostatic Discharge (ESD) Ratings	6	X-Axis Data Register, MSB	30
ESD Caution.....	6	X-Axis Data Register, LSB.....	31
Pin Configuration and Function Descriptions.....	7	Y-Axis Data Register, MSB	31
Typical Performance Characteristics	8	Y-Axis Data Register, LSB.....	31
Theory of Operation	13	Z-Axis Data Register, MSB	31
Mechanical Device Operation	13	Z-Axis Data Register, LSB	32
Operating Modes.....	13	Offset Trim Registers	32
Bandwidth	14	X-Axis Offset Trim Register, LSB.....	32
Power/Noise Trade-Off.....	14	Y-Axis Offset Trim Register, LSB.....	32
Power Savings	14	Z-Axis Offset Trim Register, LSB.....	32
Autonomous Event Detection.....	15	X-Axis Activity Threshold Register, MSB.....	33
Activity and Inactivity.....	15	X-Axis of Activity Threshold Register, LSB.....	33
Motion Warning	17	Y-Axis Activity Threshold Register, MSB.....	33
Impact Detection Features	18	Y-Axis of Activity Threshold Register, LSB.....	34
Wide Bandwidth.....	18	Z-Axis Activity Threshold Register, MSB.....	34
Instant On Impact Detection.....	18	Z-Axis of Activity Threshold Register, LSB	34
Interrupts	19	Activity Time Register	35
Interrupt Pins.....	19	X-Axis Inactivity Threshold Register, MSB.....	35
Types of Interrupts	20	X-Axis of Inactivity Threshold Register, LSB.....	36
Additional Features	21	Y-Axis Inactivity Threshold Register, MSB.....	36
Using an External Clock.....	21	Y-Axis of Inactivity Threshold Register, LSB	36
Synchronized Data Sampling.....	21	Z-Axis Inactivity Threshold Register, MSB	37
Self Test	21	Z-Axis of Inactivity Threshold Register, LSB	37
User Register Protection.....	22	Inactivity Time Registers.....	37
User Offset Trims	22	Inactivity Timer Register, MSB	37
Serial Communications	23	Inactivity Timer Register, LSB.....	38
Serial Interface	23	X-Axis Motion Warning Threshold Register, MSB.....	38
Multibyte Transfers	23	X-Axis of Motion Warning Notification Register, LSB.....	38
Invalid Addresses and Address Folding	23		

Y-Axis Motion Warning Notification Threshold Register, MSB.....	39
Y-Axis of Motion Warning Notification Register, LSB.....	39
Z-Axis Motion Warning Notification Threshold Register, MSB.....	39
Z-Axis Motion Warning Notification Register, LSB.....	40
High-Pass Filter Settings Register.....	40
Interrupt Pin Function Map Registers.....	41
INT2 Function Map Register.....	41
External Timing Control Register.....	42
Measurement Control Register.....	43
Power Control Register.....	44

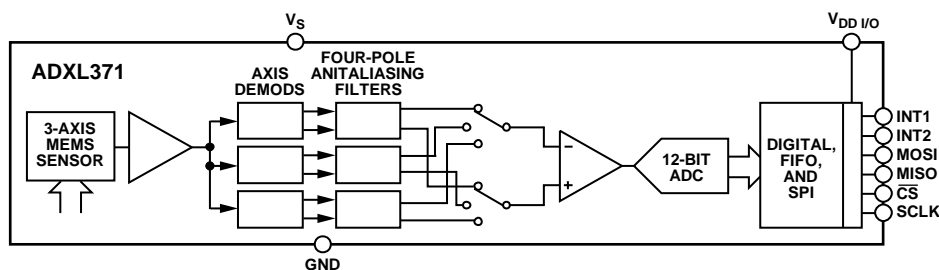
Self Test Register.....	44
RESET (Clears) Register, Part in Standby Mode.....	45
Applications Information.....	46
Application Examples.....	46
Operation at Voltages Other than 3.3 V.....	47
Operation at Temperatures Other than Ambient.....	47
Mechanical Considerations for Mounting.....	47
Axes of Acceleration Sensitivity.....	48
Layout and Design Recommendations.....	48
Outline Dimensions.....	49
Ordering Guide.....	49

REVISION HISTORY

3/2021—Revision 0: Initial Version

SPECIFICATIONS

$T_A = 25^\circ\text{C}$, $V_S = 3.3\text{ V}$, $V_{DDIO} = 3.3\text{ V}$, 2560 Hz ODR, 1280 Hz bandwidth, acceleration = 0 g, and default register settings but with high-pass filter (HPF) turned off. All minimum and maximum specifications are guaranteed. Typical specifications may not be guaranteed.

Table 1.

Parameter	Test Conditions/Comments	Min	Typ	Max	Unit
SENSOR INPUT	Each axis				
Measurement Range			±200		g
Nonlinearity	Percentage of full scale		±0.5		%
Sensor Resonant Frequency			16		kHz
Cross Axis Sensitivity ¹			±2.5		%
OUTPUT RESOLUTION	Each axis				
All Operating Modes			12		Bits
SCALE FACTOR	Each axis				
Scale Factor Calibration Error				±10	%
Scale Factor at X_{OUT} , Y_{OUT} , Z_{OUT}	Expressed in mg/LSB		100		mg/LSB
	Expressed in LSB/g		10		LSB/g
Scale Factor Change Due to Temperature ²			0.1		%/°C
0 g OFFSET	Each axis				
0 g Output	X_{OUT} , Y_{OUT} , and Z_{OUT} , and at 5120 Hz ODR, 2560 Hz bandwidth				
	$V_S = 3.3\text{ V}$	-3	±1	+3	g
	$2.5\text{ V} \leq V_S \leq 3.5\text{ V}$	-8	±1	+8	g
0 g Offset vs. Temperature ²	X_{OUT} , Y_{OUT} , Z_{OUT}		±30		mg/°C
NOISE PERFORMANCE					
Noise Bandwidth	Each axis				
Normal Operation			6.5		mg/√Hz
Low Noise Mode			5.5		mg/√Hz
BANDWIDTH	User selectable				
ODR		320		5120	Hz
High-Pass Filter, -3 dB Corner ³		0.19		24.38	Hz
Low-Pass (Antialiasing) Filter, -3 dB Corner ⁴	Four-pole low-pass filter	160		2560	Hz
POWER SUPPLY					
Operating Voltage Range (V_S)		2.5	3.3	3.5	V
Input and Output Voltage Range (V_{DDIO}) ^{5,6}		2.5	3.3	$V_S + 0.3$	V
Supply Current					
Measurement Mode	2560 Hz ODR				
Normal Operation			28		μA
Low Noise Mode			37		μA
Instant On Mode			1.7		μA
Wake-Up Mode	Varies with wake-up rate				
	At slowest wake-up rate		1		μA
Standby Mode			<0.1		μA
Power Supply Rejection Ratio (PSRR)	Source capacitance (C_S) = 1.1 μF, input and output capacitance (C_{IO}) = 1.1 μF, and input is 100 mV sine wave on V_S				
Input Frequency					
100 Hz to 1 kHz			-20		dB
1 kHz to 250 kHz			-17		dB

Parameter	Test Conditions/Comments	Min	Typ	Max	Unit
Turn-On Time	2560 Hz ODR				
Power-Up to Standby	$C_S = 1.1 \mu\text{F}$ and $C_{IO} = 1.1 \mu\text{F}$		6.25		ms
Measurement Mode Instruction to First Data Output ⁷	Filter settle bit = 1		1		ms
	Filter settle bit = 0		462.5		ms
Instant On Ultra Low Power (ULP) Monitoring to Full Bandwidth Data			1.25		ms
ENVIRONMENTAL TEMPERATURE					
Operating Temperature Range		-40		+105	°C

¹ Cross axis sensitivity is defined as coupling between any two axes.

² The scale factor may change 0.1%/°C (typical) in the -40°C to +25°C or +25°C to +105°C temperature ranges.

³ This parameter has an available corner frequency scale with the ODR setting.

⁴ Bandwidth and ODR are set independent of each other.

⁵ This value is limited to 3.6 V, maximum.

⁶ The operating voltage range to all other pins (digital input/outputs (I/Os)) is limited to the absolute maximum ratings (see Table 2).

⁷ Data output before the 5th sample may be invalid due to filter settling.

ABSOLUTE MAXIMUM RATINGS

Table 2.

Parameter	Rating
Acceleration	
Any Axis, Unpowered	10,000 g for 0.1 ms
Any Axis, Powered	10,000 g for 0.1 ms
V _S	-0.3 V to +3.6 V
V _{DDI/O}	-0.3 V to +3.6 V
All Other Pins ¹	-0.3 V to V _{DDIO} + 0.3 V
Output Short-Circuit Duration (Any Pin to Ground)	Indefinite
Temperature Range	
Storage	-50°C to +150°C
Powered	-40°C to +125°C

¹ This value is limited to 3.6 V, maximum.

Stresses at or above those listed under Absolute Maximum Ratings may cause permanent damage to the product. This is a stress rating only; functional operation of the product at these or any other conditions above those indicated in the operational section of this specification is not implied. Operation beyond the maximum operating conditions for extended periods may affect product reliability.

THERMAL RESISTANCE

Thermal performance is directly linked to printed circuit board (PCB) design and operating environment. Careful attention to PCB thermal design is required.

θ_{JA} is the natural convection, junction to ambient thermal resistance measured in a one cubic foot sealed enclosure. θ_{JC} is the junction to case thermal resistance.

Table 3.

Package Type ¹	θ_{JA}	θ_{JC}	Unit	Device Weight
CC-16-4	150	85	°C/W	18 mg

¹ Thermal impedance simulated values are based on a JEDEC 252P thermal test board with four thermal vias. See JEDEC JESD51.

RECOMMENDED SOLDERING PROFILE

Figure 2 and Table 4 provide details about the recommended soldering profile.

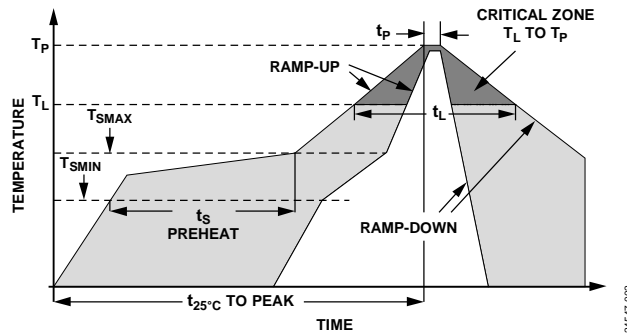

Figure 2. Recommended Soldering Profile

Table 4. Recommended Soldering Profile

Profile Feature	Condition	
	Sn63/Pb37	Pb-Free
Average Ramp Rate (TL to TP)	3°C/sec max	3°C/sec max
Preheat		
Minimum Temperature (T _{SMIN})	100°C	150°C
Maximum Temperature (T _{SMAX})	150°C	200°C
Time (T _{SMIN} to T _{SMAX}) (ts)	60 sec to 120 sec	60 sec to 180 sec
T _{SMAX} to TL Ramp-Up Rate	3°C/sec max	3°C/sec max
Time Maintained Above Liquidous (TL)		
Liquidous Temperature (TL)	183°C	217°C
Time (tL)	60 sec to 150 sec	60 sec to 150 sec
Peak Temperature (TP)	240 + 0/-5°C	260 + 0/-5°C
Time Within 5°C of Actual Peak Temperature (tp)	10 sec to 30 sec	20 sec to 40 sec
Ramp-Down Rate	6°C/sec max	6°C/sec max
Time 25°C to TP	6 min max	8 min max

ELECTROSTATIC DISCHARGE (ESD) RATINGS

The following ESD information is provided for handling of ESD-sensitive devices in an ESD protected area only.

Human body model (HBM) per ANSI/ESDA/JEDEC JS-001.

ESD Ratings for ADXL371

Table 5. ADXL371, 16-Terminal LGA

ESD Model	Withstand Threshold (V)	Class
HBM	2000	1C

ESD CAUTION



ESD (electrostatic discharge) sensitive device. Charged devices and circuit boards can discharge without detection. Although this product features patented or proprietary protection circuitry, damage may occur on devices subjected to high energy ESD. Therefore, proper ESD precautions should be taken to avoid performance degradation or loss of functionality.

PIN CONFIGURATION AND FUNCTION DESCRIPTIONS

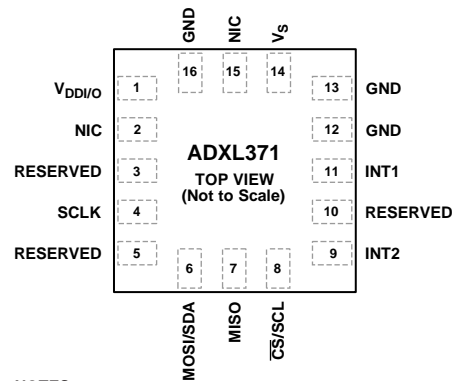

NOTES
1. NIC = NO INTERNAL CONNECTION. THIS PIN IS NOT INTERNALLY CONNECTED.

24547-003

Figure 3. Pin Configuration (Top View)

Table 6. Pin Function Descriptions

Pin No.	Mnemonic	Description
1	V _{DDI/O}	Supply Voltage for Digital Input and Output.
2	NIC	No Internal Connection. This pin is not internally connected.
3	RESERVED	Reserved. This pin can be left unconnected or connected to GND.
4	SCLK	SPI Serial Communications Clock.
5	RESERVED	Reserved. This pin can be left unconnected or connected to GND.
6	MOSI/SDA	SPI Master Output, Slave Input (MOSI). I ² C Serial Data (SDA).
7	MISO	SPI Master Input, Slave Output.
8	\overline{CS} /SCL	SPI Chip Select (\overline{CS}). I ² C Serial Communications Clock (SCL).
9	INT2	Interrupt 2 Output. This pin also serves as an input for synchronized sampling.
10	RESERVED	Reserved. This pin can be left unconnected or connected to GND.
11	INT1	Interrupt 1 Output. This pin also serves as an input for external clocking.
12	GND	Ground. This pin must be connected to ground.
13	GND	Ground. This pin must be connected to ground.
14	V _s	Supply Voltage.
15	NIC	No Internal Connection. This pin is not internally connected.
16	GND	Ground. This pin must be connected to ground.

TYPICAL PERFORMANCE CHARACTERISTICS

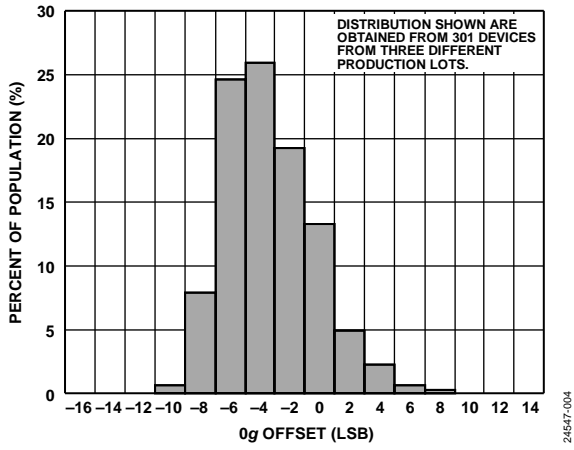

Figure 4. X-Axis 0 g Offset (LSB) at 25°C, $V_S = 3.3 V$

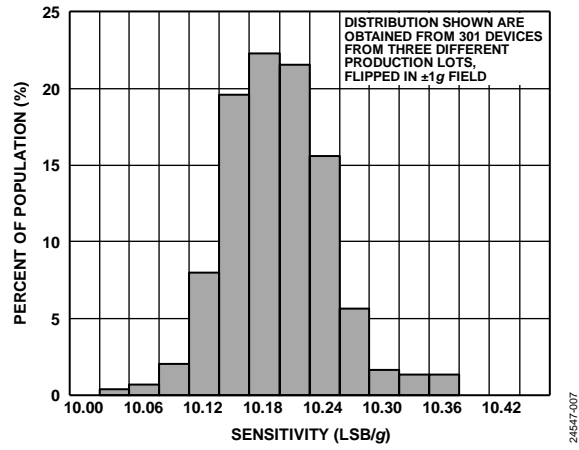

Figure 7. X-Axis Sensitivity at 25°C, $V_S = 3.3 V$

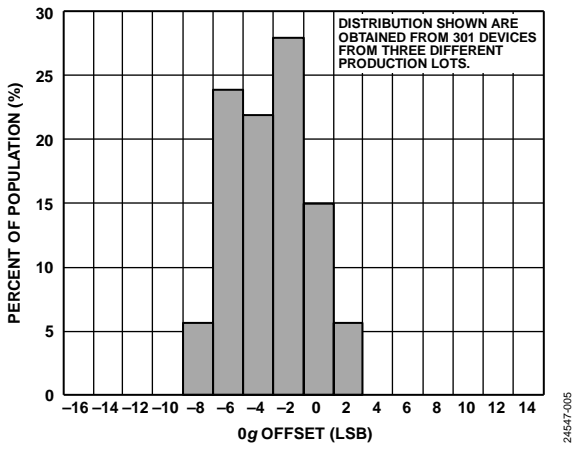

Figure 5. Y-Axis 0 g Offset (LSB) at 25°C, $V_S = 3.3 V$

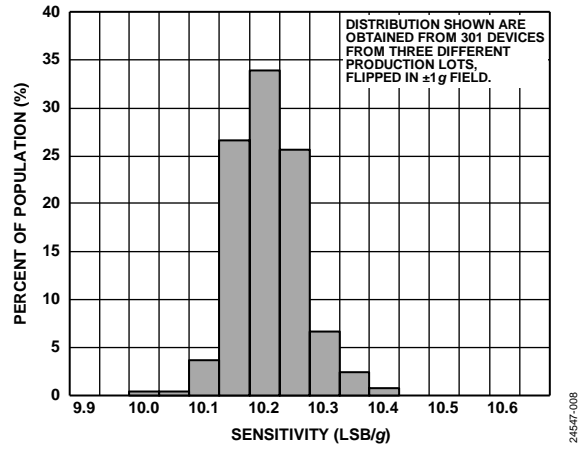

Figure 8. Y-Axis Sensitivity at 25°C, $V_S = 3.3 V$

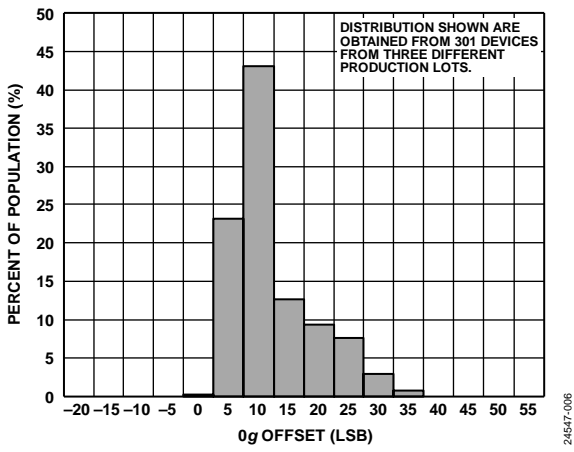

Figure 6. Z-Axis 1 g Offset (LSB) at 25°C, $V_S = 3.3 V$

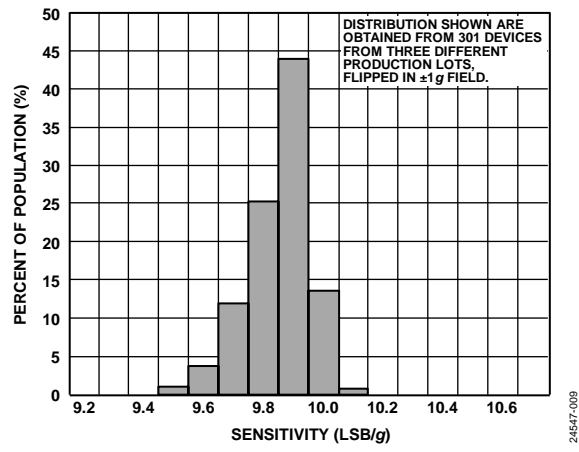

Figure 9. Z-Axis Sensitivity at 25°C, $V_S = 3.3 V$

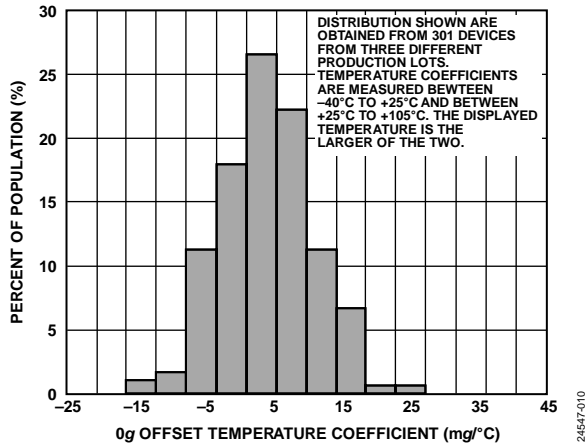

Figure 10. X-Axis 0 g Offset Temperature Coefficient (mg/°C), $V_S = 3.3 V$

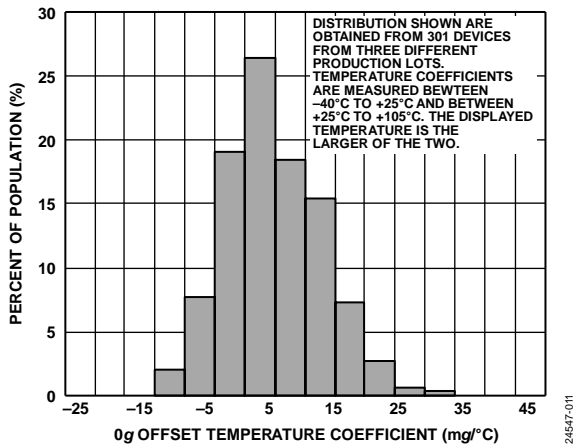

Figure 11. Y-Axis 0 g Offset Temperature Coefficient (mg/°C), $V_S = 3.3 V$

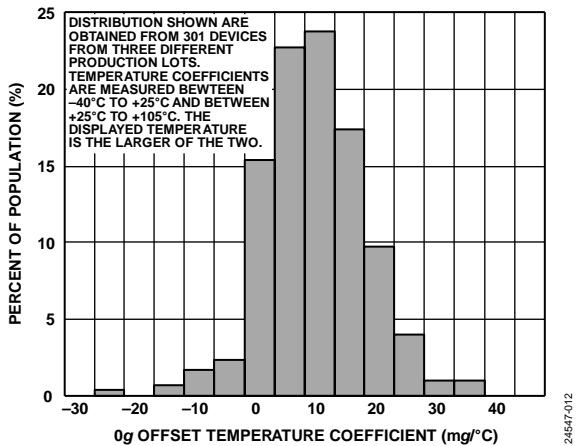

Figure 12. Z-Axis 0 g Offset Temperature Coefficient, $V_S = 3.3 V$

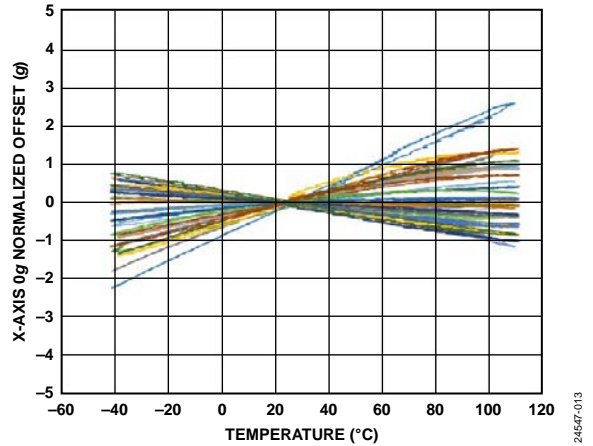

Figure 13. X-Axis 0 g Normalized Offset vs. Temperature, 36 Devices Soldered to PCB, ODR = 2560 Hz

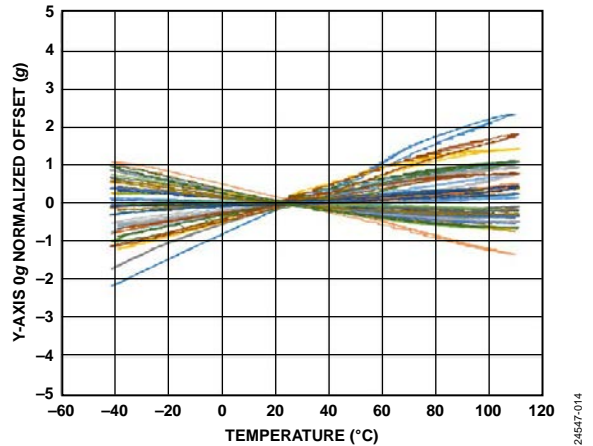

Figure 14. Y-Axis 0 g Normalized Offset vs. Temperature, 36 Devices Soldered to PCB, ODR = 2560 Hz

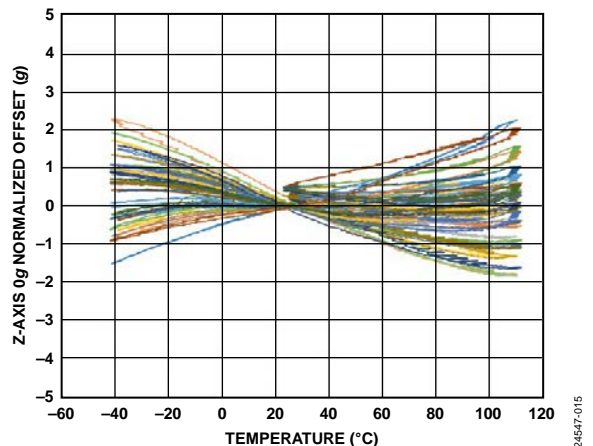
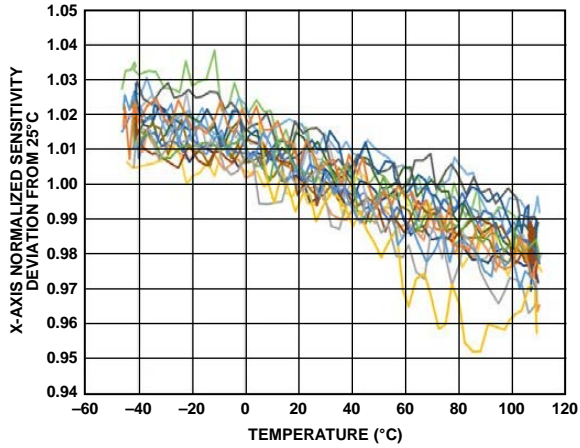
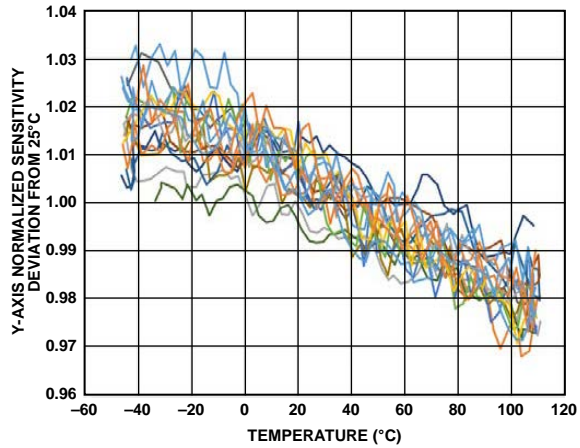

Figure 15. Z-Axis 0 g Normalized Offset vs. Temperature, 36 Devices Soldered to PCB, ODR = 2560 Hz



24547-016

Figure 16. X-Axis Normalized Sensitivity Deviation from 25°C vs. Temperature, 18 Devices Soldered to PCB, ODR = 2560 Hz



24547-017

Figure 17. Y-Axis Normalized Sensitivity Deviation from 25°C vs. Temperature, 17 Devices Soldered to PCB, ODR = 2560 Hz

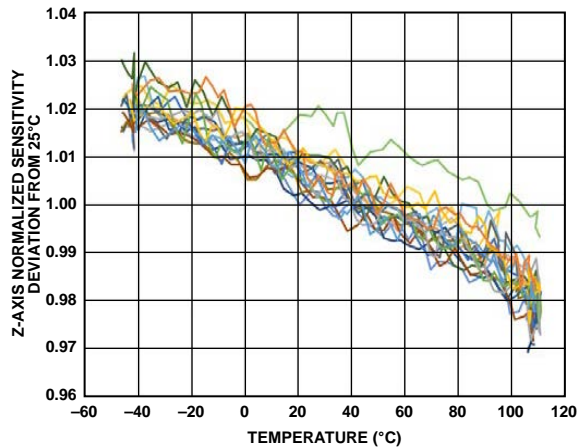

24547-018

Figure 18. Z-Axis Normalized Sensitivity Deviation from 25°C vs. Temperature, 18 Devices Soldered to PCB, ODR = 2560 Hz

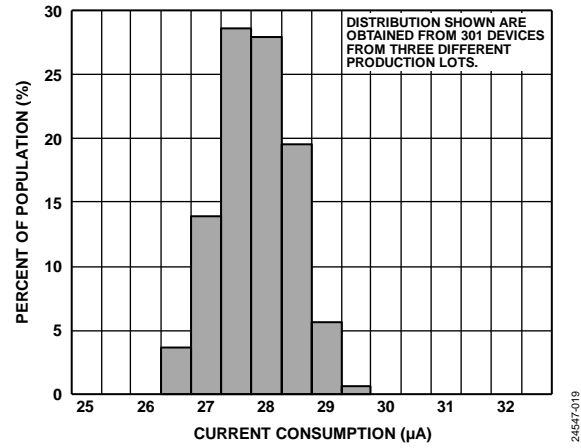

24547-019

Figure 19. Current Consumption at 25°C, Normal Mode, 2560 Hz Output Data Rate, $V_S = 3.3 V$

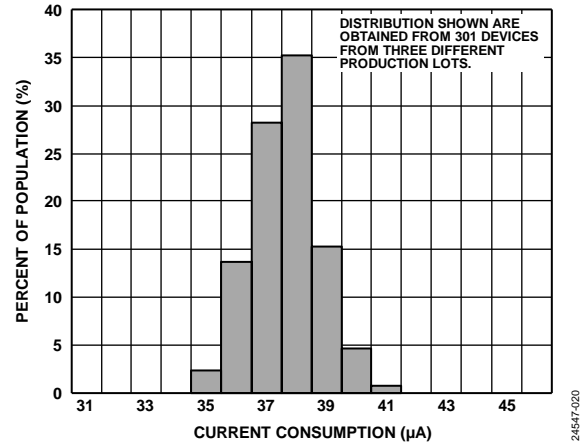

24547-020

Figure 20. Current Consumption at 25°C, Low Noise Mode, 2560 Hz Output Data Rate, $V_S = 3.3 V$

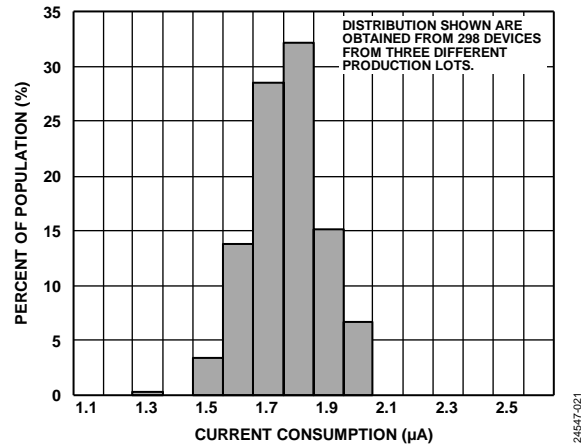

24547-021

Figure 21. Current Consumption at 25°C, Instant On Mode, $V_S = 3.3 V$

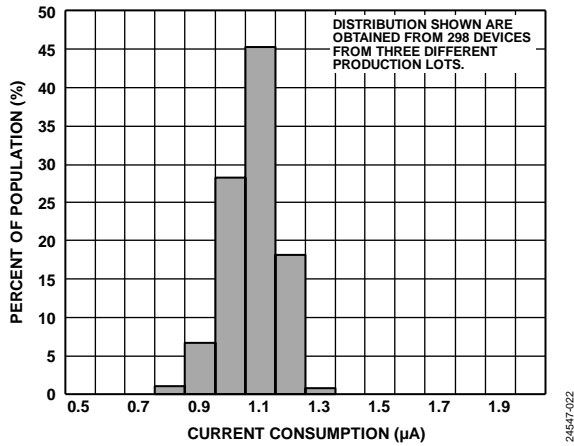

Figure 22. Current Consumption at 25°C, Wake-Up Mode, $V_S = 3.3\text{ V}$

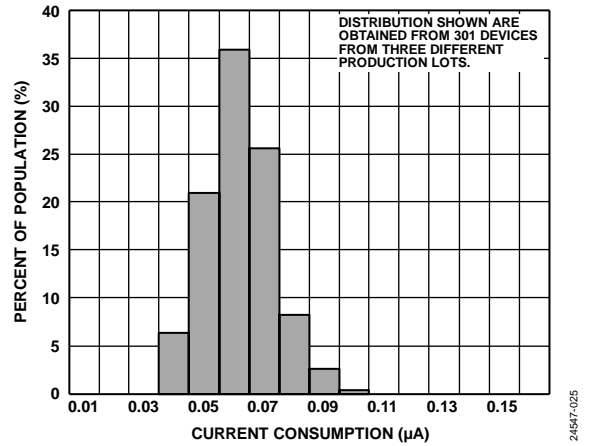

Figure 25. Current Consumption at 25°C, Standby Mode, $V_S = 3.3\text{ V}$

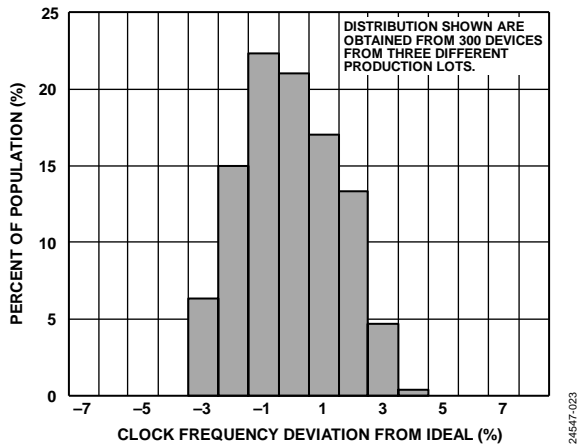

Figure 23. Clock Frequency Deviation from Ideal at 25°C, ODR = 2560 Hz, $V_S = 3.3\text{ V}$

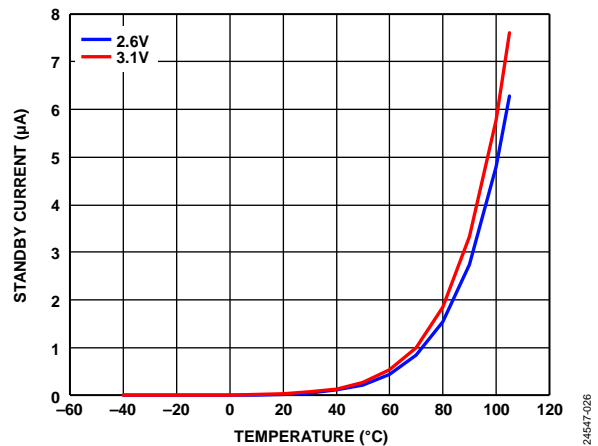

Figure 26. Standby Current vs. Temperature

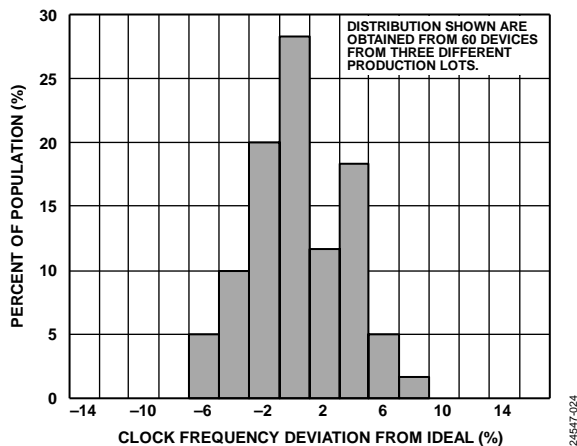

Figure 24. Clock Frequency Deviation from Ideal at 25°C, ODR = 5120 Hz, $V_S = 3.3\text{ V}$

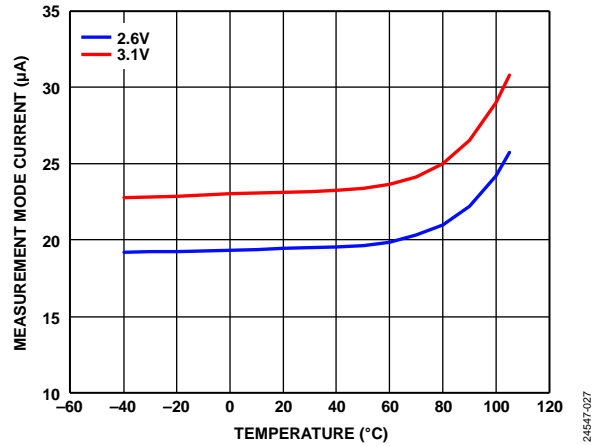

Figure 27. Measurement Mode Current vs. Temperature

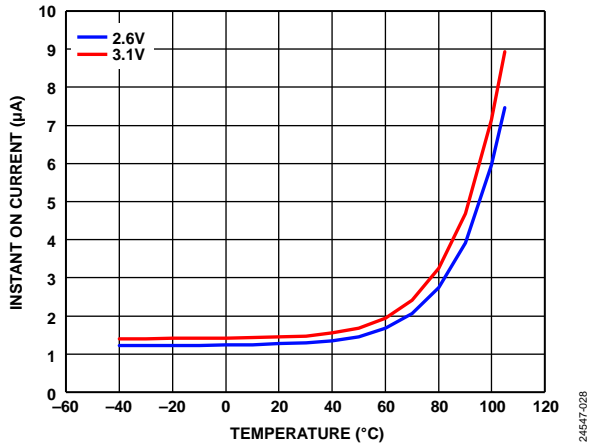

Figure 28. Instant On Current vs. Temperature

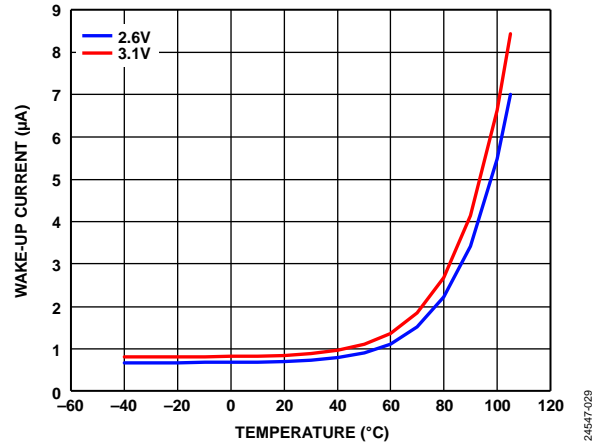

Figure 29. Wake-Up Current vs. Temperature

THEORY OF OPERATION

The ADXL371 is a complete 3-axis acceleration measurement system that operates at extremely low power levels. Acceleration is reported digitally, and the device communicates via the SPI and I²C protocols. Built in digital logic enables autonomous operation and implements functions that enhance system level power savings.

MECHANICAL DEVICE OPERATION

The moving component of the sensor is a polysilicon surface micromachined structure built on top of a silicon wafer.

Polysilicon springs suspend the structure over the surface of the wafer and provide a resistance against acceleration forces.

Deflection of the structure is measured using differential capacitors that consist of independent fixed plates and plates attached to the moving mass. Acceleration deflects the structure and unbalances the differential capacitor, resulting in a sensor output whose amplitude is proportional to acceleration. Phase sensitive demodulation determines the magnitude and polarity of the acceleration.

OPERATING MODES

The ADXL371 has three operating modes: a measurement mode for continuous, wide bandwidth sensing, an instant on mode for low power impact detection, and a wake-up mode for limited bandwidth, low *g* activity detection. Measurement can be suspended by placing the device in standby mode.

Measurement Mode

Measurement mode is the default operating mode of the ADXL371. In this mode, acceleration data is read continuously, and the accelerometer consumes 28 μA (typical) at an ODR of 2560 Hz when using a 3.3 V supply. Actual current consumption is dependent on the ODR chosen. All features described in this data sheet are available when operating the ADXL371 in this mode. After entering measurement mode, the first output value does not appear until after the filter settling time has passed. This time is selectable using the FILTER_SETTLE bit in the POWER_CTL register. See Filter Settling Time section for more details.

Instant On Mode

Instant on mode enables extremely low power impact detection. In this mode, the accelerometer constantly monitors the environment while consuming a low current of 1.7 μA (typical). When an event that exceeds an internal threshold is detected, the device switches into measurement mode to record the event. The target default threshold is 10 *g* to 15 *g*, but it can vary. A register option allows the threshold to be increased to a target of 30 *g* to 40 *g* if the default threshold is too low.

To save power, no new digital acceleration data is made available until the accelerometer switches into normal operation. However, all registers have normal read and write functionality.

Wake-Up Mode

Wake-up mode is ideal for simple detection of the presence or absence of motion at an extremely low power consumption. Wake-up mode is particularly useful for the implementation of a low *g* motion activated on and off switch, allowing the rest of the system to be powered down until sustained activity is detected.

In wake-up mode, the device is powered down for a duration of time equal to the wake-up timer, set by the WAKEUP_RATE bits in the TIMING register, and then turns on for a duration equal to the filter settling time (see the Filter Settling Time section). The current drawn in this mode is determined by both of these parameters.

Table 7. Wake-Up Current in μA at Different Wake-Up Timer and Filter Settings

Wake-Up Timer (ms)	Filter Settling Time	
	20 ms	462.5 ms
65	1.3 μA	16.7 μA
130	0.98 μA	15 μA
260	0.84 μA	12.4 μA
640	0.76 μA	8.4 μA
2560	0.71 μA	3.5 μA
5120	0.71 μA	2.2 μA
10,240	0.7 μA	1.5 μA
30,720	0.7 μA	1 μA

If motion is detected, the accelerometer can respond autonomously in several ways, depending on the device configuration, including the following:

- Switch into full bandwidth measurement mode
- Signal an interrupt to a microcontroller
- Wake up downstream circuitry

While in wake-up mode, all registers have normal read and write functionality, and real-time data can be read from the data registers at the reduced wake-up rate. However, there are no interrupts available in wake-up mode.

Standby

Placing the ADXL371 in standby mode suspends measurement and reduces current consumption to less than 100 nA. All interrupts are cleared, and no new interrupts are generated. The ADXL371 powers up in standby mode with all sensor functions turned off.

BANDWIDTH

Low-Pass Antialiasing Filter

High g events often include acceleration content over a wide range of frequencies. The analog-to-digital converter (ADC) of the ADXL371 samples the input acceleration at the user selected ODR. In the absence of antialiasing filters, input signals whose frequency is more than half the ODR alias or that fold into the measurement bandwidth can lead to inaccurate measurements. To mitigate this inaccuracy, a four-pole, low-pass filter is provided at the input of the ADC. The filter bandwidth is user selectable, and the default bandwidth is 160 Hz. The maximum bandwidth is constrained to at most half of the ODR, to ensure that the Nyquist criteria is not violated.

High-Pass Filter

The ADXL371 offers a one-pole, high-pass filter with a user selectable -3 dB frequency. Applications that do not require dc acceleration measurements can use the high-pass filter to minimize constant or slow varying offset errors including initial bias, bias drift due to temperature, and bias drift due to supply voltage.

The high-pass filter is a first-order infinite impulse response (IIR) filter. Table 8 lists the available -3 dB frequencies, which are user selectable and dependent on the output data rate. The high-pass and low-pass filters can be used simultaneously to set up a band-pass option.

Table 8. High-Pass Filter -3 dB Corner Frequencies

Setting	ODR (Hz)				
	5120	2560	1280	640	320
00	24.38	12.19	6.09	3.05	1.52
01	12.46	6.23	3.11	1.55	0.78
10	6.30	3.15	1.58	0.78	0.39
11	3.17	1.58	0.79	0.39	0.19

Filter Settling Time

After entering measurement mode, the first output value does not appear until after the filter settling time has passed. This time is selectable using the FILTER_SETTLE bit in the POWER_CTL register. The recommended (and default) settling time to acquire valid data when using either the high-pass filter or the low-pass activity detect filter is 462.5 ms. The filter settling time of 20 ms is ideal for when both the high-pass filter and low-pass activity detect filter are disabled.

Selectable ODR

The ADXL371 can report acceleration data at 320 Hz, 640 Hz, 1280 Hz, 2560 Hz, or 5120 Hz. The ODR is user selectable, and the default is 320 Hz. If the user selects an antialiasing filter bandwidth greater than half the ODR, the device defaults the bandwidth to 50% of the ODR. Increasing or decreasing the

ODR increases or decreases the current consumption, accordingly, as shown in Figure 30.

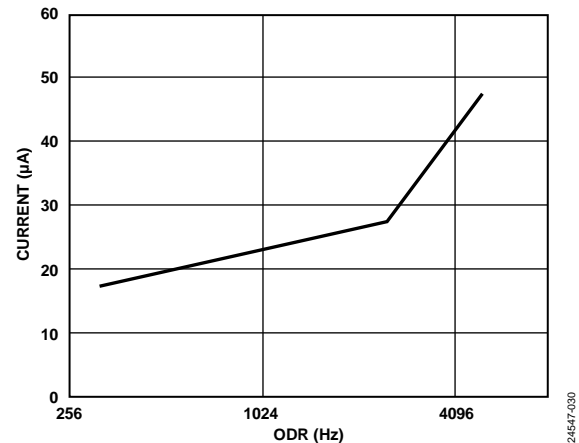

Figure 30. Typical Measurement Mode Current vs. ODR

POWER/NOISE TRADE-OFF

The noise performance of the ADXL371 in normal operation, typically $6.5 \text{ mg}/\sqrt{\text{Hz}}$ at 2560 Hz ODR and 1280 Hz bandwidth, is adequate for most applications, depending on bandwidth and the desired resolution. For cases where lower noise is needed, the ADXL371 provides a lower noise operating mode that trades reduced noise for a somewhat higher current consumption. In all cases, operating at a higher bandwidth setting increases the rms noise and operating at a lower bandwidth settling decreases the rms noise. Table 9 lists the current consumption and noise densities obtained for normal operation and the lower noise mode at a typical 3.3 V supply.

Table 9. Noise and Current Consumption for $V_S = 3.3 \text{ V}$

Mode	Typical Noise Bandwidth ($\text{mg}/\sqrt{\text{Hz}}$)	Typical Current Consumption (μA)
Normal Operation ¹	6.5	28
Low Noise ¹	5.5	37

¹ $V_S = 3.3 \text{ V}$, ODR = 2560 Hz, and bandwidth = 1280 Hz.

POWER SAVINGS

The digital interface of the ADXL371 is implemented with system level power savings in mind. The following features enhance power savings:

- Burst reads and writes reduce the number of SPI communication cycles required to configure the device and retrieve data.
- Concurrent operation of activity and inactivity detection enables set it and forget it operation. Loop modes further reduce communications power by enabling the clearing of interrupts without processor intervention.

AUTONOMOUS EVENT DETECTION

ACTIVITY AND INACTIVITY

The ADXL371 features built in logic that detects activity (acceleration more than a user set threshold) and inactivity (acceleration less than a user set threshold). Activity and inactivity events can be used as triggers to manage the accelerometer operating mode, trigger an interrupt to a host processor, and/or autonomously drive a motion switch.

Detection of an activity or inactivity event is indicated in the STATUS2 register and can be configured to generate an interrupt. In addition, the activity status of the device, that is, whether it is moving or stationary, is indicated by the AWAKE bit (STATUS register), described in the Using the AWAKE Bit section.

Activity and inactivity detection can be used when the accelerometer is in either measurement mode or wake-up mode. However, the activity and inactivity interrupts are not available in wake-up mode because the device is inherently looking for activity in this mode, and any changes to the activity or inactivity detection features must be made while the device is in standby mode.

Low-Pass Activity Detect Filter

The ADXL371 combines high *g* impact detection and low *g* movement detection in one device. For low *g* detection, an internal low-pass filter with a -3 dB corner of approximately 8 Hz averages data to reduce the rms noise, allowing accurate detection of activity or inactivity thresholds as low as 500 mg. For high *g* impact detection, the low-pass activity detect filter can be turned off through a register setting. When using both the low-pass activity detect filter and the high-pass filter, the user must select a high-pass filter corner that does not exceed 8 Hz. Otherwise, activity detection data is severely attenuated.

Activity Detection

An activity event is detected when acceleration in at least one enabled axis remains above a specified threshold for a specified time. Enabled axes, thresholds, and time are user selected. Each axis has its own activity threshold, but the activity timer is shared among all three axes. When multiple axes are selected, an over-threshold event on any one enabled axis triggers the activity detection.

Referenced and Absolute Configurations

Activity detection can be configured as referenced or absolute mode for all axes through the ACT_REF bit in the THRESH_ACT_X_L register.

When using absolute activity detection, acceleration samples are compared directly to a user set threshold to determine whether motion is present. For example, if a threshold of 0.5 *g* is set and the acceleration on the z-axis is 1 *g* longer than the user defined activity time, the activity status asserts.

In many applications, it is advantageous for activity detection to be based not on an absolute threshold but on a deviation from a reference point or orientation. The referenced activity detection is particularly useful because it removes the effect on activity detection of the static 1 *g* imposed by gravity as well as any static offset errors, which can be up to several *g*. In absolute activity detection, when the threshold is set to less than 1 *g*, activity is immediately detected in this case.

In the referenced configuration, activity is detected when acceleration samples are more than an internally defined reference by a user defined amount for the user defined amount of time, as described by

$$Abs(Acceleration - Reference) > Threshold$$

where *Abs* is the absolute value.

Consequently, activity is detected only when the acceleration has deviated sufficiently from the initial orientation. The default setting for the accelerometer is in absolute mode. After it is placed in referenced mode through the appropriate register setting, the reference for activity detection is calculated as soon as the full bandwidth measurement mode is turned on. To reset the reference, it is necessary to put the device back into absolute mode and then back into referenced mode. The new reference is set as soon as the device enters full bandwidth measurement mode again. If using both activity and inactivity detection in referenced mode, both must be set back to absolute mode before the reference can be reset.

Activity Timer

Ideally, the intent of activity detection is to wake up a system only when motion is intentional, ignoring noise or small, unintentional movements. In addition to being sensitive to low *g* events, the ADXL371 activity detection algorithm is robust in filtering out undesired triggers.

The ADXL371 activity detection functionality includes a timer to filter out unwanted motion and ensure that only sustained motion is recognized as activity. The timer period depends on the ODR selected. At 2560 Hz and under, it is approximately 8.25 ms, and at 5120 Hz, it is approximately 2.06 ms. For activity detection to trigger, above threshold activity must be sustained for a time equal to the number of activity timer periods specified in the activity time register. For example, a setting of 10 in this register means that above threshold activity must be sustained for 82.5 ms at 2560 Hz ODR. A register value of zero results in single sample activity detection. The maximum allowable activity time is approximately 2.1 sec (or 0.53 sec at 5120 Hz ODR). Note that the activity timer is operational in measurement mode only.

Activity Detection in Wake-Up Mode

If activity detection is enabled while the device is in wake-up mode, the device uses single sample activity detection, no matter the activity time register setting. If activity is detected, the device automatically returns to full bandwidth measurement mode. However, the activity interrupt is not generated unless the activity time setting is zero. If it is not zero, after entering measurement mode, the interrupt is not generated until the device sees sustained activity for the amount of time given in the activity time register. The awake interrupt automatically goes high upon entering measurement mode if the device is in default mode or autosleep mode. If it is in linked or loop mode (but not autosleep), it is linked to the activity interrupt, which behaves as previously mentioned.

After the device automatically enters measurement mode due to activity detection, if autosleep is not on, it must be placed manually back into wake-up mode.

Inactivity Detection

An inactivity event is detected when acceleration in all enabled axes remains less than a specified threshold for a specified time. Enabled axes, threshold, and time are user selected. Each axis has its own inactivity threshold, but the inactivity timer is shared among all three axes. When multiple axes are selected, all enabled axes must stay less than the threshold for the required amount of time to trigger inactivity detection.

Referenced and Absolute Configurations

Inactivity detection is also configurable as referenced or absolute through the INACT_REF bit in the THRESH_INACT_X_L register. When using absolute inactivity detection, acceleration samples are compared directly to a user set threshold for the user set time to determine the absence of motion. Inactivity is detected when enough consecutive samples are all less than the threshold.

When using referenced inactivity detection, inactivity is detected when acceleration samples are within a user specified amount from an internally defined reference for a user defined amount of time.

$$Abs(Acceleration - Reference) < Threshold$$

Referenced inactivity, like referenced activity, is particularly useful for eliminating the effects of the static acceleration due to gravity, as well as other static offsets. With absolute inactivity, if the inactivity threshold is set lower than 1 g, a device resting motionless may never detect inactivity. With referenced inactivity, the same device under the same configuration detects inactivity. The default setting for the accelerometer is in absolute mode. After it is placed in referenced mode through the appropriate register setting, the reference for inactivity detection is calculated as soon as full bandwidth measurement mode is turned on. To reset the reference, it is necessary to put the

device back into absolute mode and then back into referenced mode. The new reference is set as soon as the device enters full bandwidth measurement mode again. If using both inactivity and activity detection in referenced mode, both must be set back to absolute mode before the reference can be reset.

Inactivity Timer

The ADXL371 inactivity detect functionality includes a timer to allow detection of sustained inactivity. The timer period depends on the ODR selected. At 2560 Hz and under, it is approximately 32.5 ms regardless of ODR. For inactivity detection to trigger, under threshold inactivity must be sustained for a time equal to the number of inactivity timer periods specified in the inactivity time registers. For example, a setting of 10 in these registers means that under threshold inactivity must be sustained for 325 ms. A value of zero in these registers results in single sample, inactivity detection. The maximum allowable inactivity time is approximately 35.5 minutes.

Linking Activity and Inactivity Detection

When in measurement mode or wake-up mode, the activity and inactivity detection functions can be used concurrently and processed manually by a host processor, or these functions can be configured to interact in several other ways, such as those described in the following sections.

Default Mode

In default mode, activity and inactivity detection are both available simultaneously, and all interrupts must be serviced by a host processor. That is, a processor must read each interrupt before it is cleared and can be used again. Refer to the Interrupts section for information on clearing interrupts.

The flowchart in Figure 31 illustrates default mode operation.

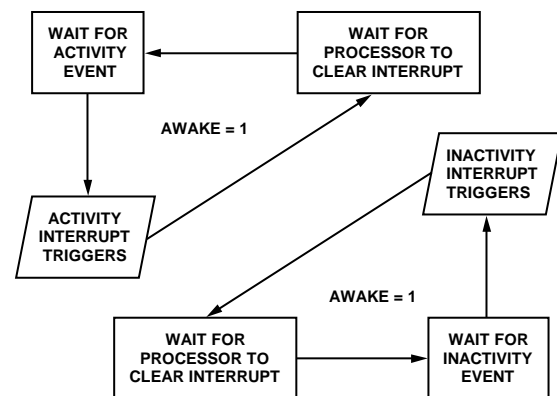

NOTES

1. THE AWAKE BIT DEFAULTS TO 1 WHEN ACTIVITY AND INACTIVITY ARE NOT LINKED.

246547-031

Figure 31. Flowchart Illustrating Activity and Inactivity Operation in Default Mode

Linked Mode

In linked mode, activity and inactivity detection are linked to each other so that only one of the functions is enabled at any given time. As soon as activity is detected, the device is assumed to be moving (or awake) and stops looking for activity. Rather, inactivity is expected as the next event. Therefore, only inactivity detection operates.

Similarly, when inactivity is detected, the device is assumed to be stationary (or asleep). Thus, activity is expected as the next event. Therefore, only activity detection operates.

In linked mode, each interrupt must be serviced by a host processor before the next interrupt is enabled.

The flowchart in Figure 32 illustrates linked mode operation.

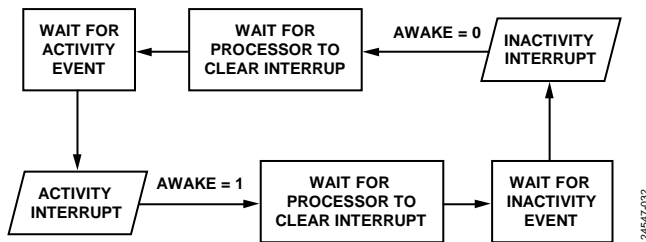

Figure 32. Flowchart Illustrating Activity and Inactivity Operation in Linked Mode

Loop Mode

In loop mode, motion detection operates as described in the Linked Mode section, but interrupts do not need to be serviced by a host processor. This configuration simplifies the implementation of commonly used motion detection and enhances power savings by reducing the amount of power used in bus communication.

The flowchart in Figure 33 illustrates loop mode operation.

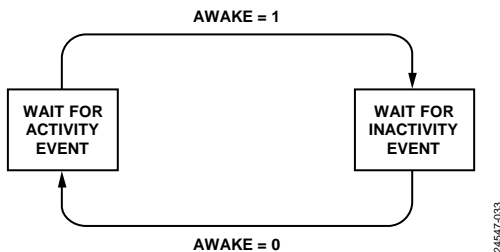

Figure 33. Flowchart Illustrating Activity and Inactivity Operation in Loop Mode

Autosleep

If autosleep is selected, after the device is placed in wake-up mode (see the Wake-Up Mode section), it automatically sets to loop mode and begins looking for activity. When activity is detected, the device automatically enters measurement mode and immediately begins looking for inactivity. When inactivity is detected, the device automatically re-enters wake-up mode. Note that the device must be manually placed in wake-up mode before autosleep can begin functioning. It does not automatically enter wake-up mode if the device is started up manually in measurement mode.

Using the AWAKE Bit

The AWAKE bit is a status bit that indicates whether the ADXL371 is awake or asleep. In default mode or autosleep mode, the AWAKE bit is high whenever the device is in measurement mode. In linked or loop mode, the AWAKE bit is high whenever the device experiences an activity condition, and it is low when the device experiences an inactivity condition.

The awake signal can be mapped to the INT1 pin or the INT2 pin allowing the pin to serve as a status output to connect or disconnect power to downstream circuitry based on the awake status of the accelerometer. Used in conjunction with loop mode, this configuration implements a simple, autonomous motion activated switch.

If the turn-on time of downstream circuitry can be tolerated, this motion switch configuration can save significant system level power by eliminating the standby current consumption of the remainder of the application circuit. This standby current can often exceed the full operating current of the ADXL371.

MOTION WARNING

In addition to the activity threshold previously described, the ADXL371 offers a secondary threshold. This second threshold, the motion warning threshold, can be set independently of the activity threshold. It does not have any functionality related to autosleep, linked, or loop mode, or the device awake status. The purpose of the motion warning functionality is to issue a notification to the system, via the status bit and/or interrupt, that the observed acceleration has exceeded the second threshold. It is controlled by the THRESH_ACT2_x_x registers, and by the ACTIVITY2 interrupt, which is sent only to the INT2 pin. Each axis has its own motion warning threshold. However, the motion warning activity interrupt does not have an activity timer. It is only used for single sample, activity detection. The motion warning threshold also shares the same referenced and absolute configuration as the primary activity detection.

IMPACT DETECTION FEATURES

Impact detection applications often require high g and high bandwidth acceleration measurements, and the ADXL371 is designed with these applications in mind. Several features are included that target impact detection and aim to simplify the system design.

WIDE BANDWIDTH

An impact is a transient event that produces an acceleration pulse with frequency content over a wide range. A sufficiently wide bandwidth is needed to capture the impact event because lowering bandwidth has the effect of reducing the magnitude of the recorded signal, resulting in measurement inaccuracy.

The ADXL371 can operate with bandwidths of up to 2560 Hz at extremely low power levels. A steep filter roll-off is also useful for effective suppression of out of band content, and the ADXL371 incorporates a four-pole, low-pass antialiasing filter for this purpose.

INSTANT ON IMPACT DETECTION

The ADXL371 instant on mode is an ultra low power mode that continuously monitors the environment for impact events that exceed a built in threshold. When an impact is detected, the device switches into full measurement mode and captures the impact profile.

No digital data is available in this mode of operation. The user can configure the device to detect an impact between a threshold level of either 10 g to 15 g or 30 g to 40 g by using the INSTANT_ON_THRESH bit in the POWER_CTL register. When an impact beyond the selected threshold is detected, the ADXL371 switches to full bandwidth measurement mode and begins outputting digital data.

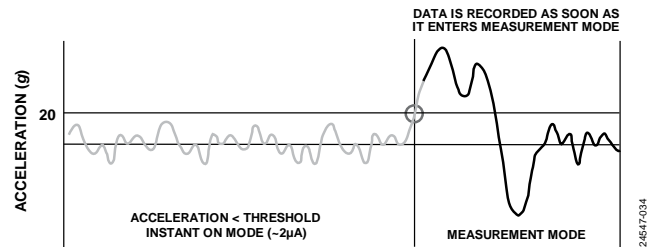

Figure 34. Instant On Mode Using Default Threshold

After the accelerometer is in full bandwidth measurement mode, the mode must be set back into instant on mode manually. The mode cannot return to instant on mode automatically.

INTERRUPTS

Several of the built in functions of the ADXL371 can trigger interrupts to alert the host processor of certain status conditions. The functionality of these interrupts is described in this section.

INTERRUPT PINS

Interrupts can be mapped to either (or both) of two designated output pins, INT1 and INT2, by setting the appropriate bits in the INT1_MAP register and INT2_MAP register, respectively. All functions can be used simultaneously. If multiple interrupts are mapped to one pin, the OR combination of the interrupts determines the status of the pin.

If no functions are mapped to an interrupt pin, that pin is automatically configured to a high impedance (high-Z) state. The INTx pins are also placed in the high-Z state upon a reset.

When a certain status condition is detected, the INTx pin that condition is mapped to activates. The configuration of the INTx pin is active high by default so when the pin is activated, it goes high. However, this configuration can be switched to active low by setting the INTx_LOW bit in the appropriate INTx_MAP register.

The INTx pins can connect to the interrupt input of a host processor where interrupts are responded to with an interrupt routine. Because multiple functions can be mapped to the same pin, the STATUS register can determine which condition caused the interrupt to trigger.

Interrupts are cleared in several of the following ways:

- Reading the STATUS2 register clears ACTIVITY and INACT interrupts. However, if activity detection is operating in default mode, and the activity or inactivity timers are set to 0, the only way to clear the activity or inactivity bits, respectively, is to set the device into standby mode and restart full bandwidth measurement mode.

- Reading the STATUS2 register clears the ACTIVITY2 interrupt. It is not required to set the device back in standby mode to clear this interrupt, no matter what value is set for the activity timer.
- Reading from the data registers clears the DATA_RDY interrupt.

Both INTx pins are push-pull low impedance pins with an output impedance of about 500 Ω (typical) and digital output specifications as shown in Table 10. Both INTx pins have bus keepers that hold the pins to a valid logic state when the pins are in high impedance mode.

To prevent interrupts from being falsely triggered during configuration, disable interrupts while their settings, such as thresholds, timings, or other values, are configured.

Alternate Functions

The INT1 and INT2 pins can be configured for use as input pins instead of for signaling interrupts. INT1 is used as an external clock input when the EXT_CLK bit in the TIMING register is set. INT2 is used as the trigger input for synchronized sampling when the EXT_SYNC bit in the TIMING register is set. One or both of these alternate functions can be used concurrently. However, if an interrupt pin is used for its alternate function, the INTx pin cannot be used simultaneously to signal interrupts.

Table 10. Interrupt Pin (INTx) Digital Outputs

Parameter	Test Conditions/Comments	Limit ¹		Unit
		Min	Max	
Digital Output				
Low Level Output Voltage (V_{OL})	$I_{OL} = 500 \mu A$		$0.2 \times V_{DDI/O}$	V
High Level Output Voltage (V_{OH})	$I_{OH} = -300 \mu A$	$0.8 \times V_{DDI/O}$		V
Low Level Output Current (I_{OL})	$V_{OL} = V_{OL, MAX}$	500		μA
High Level Output Current (I_{OH})	$V_{OH} = V_{OH, MIN}$		-300	μA
Pin Capacitance	Input frequency (f_{IN}) = 1 MHz, input voltage (V_{IN}) = 2.0 V		8	pF
Rise and Fall Time				
Rise Time (t_R) ²	Load capacitance (C_{LOAD}) = 150 pF		210	ns
Fall Time (t_F) ³	$C_{LOAD} = 150 \text{ pF}$		150	ns

¹ Limits based on characterization results, not production tested.

² Rise time is measured as the transition time from $V_{OL, MAX}$ to $V_{OH, MIN}$ of the interrupt pin.

³ Fall time is measured as the transition time from $V_{OH, MIN}$ to $V_{OL, MAX}$ of the interrupt pin.

TYPES OF INTERRUPTS

Activity and Inactivity Interrupts

The ACTIVITY bit and INACT bit are set when activity and inactivity are detected, respectively. Detection procedures and criteria are described in the Autonomous Event Detection section.

Data Ready Interrupt

The DATA_RDY bit is set when new valid data is available, and it is cleared when no new data is available.

The DATA_RDY bit does not set while any of the data registers are being read. If DATA_RDY = 0 prior to a register read and new data becomes available during the register read, DATA_RDY remains 0 until the read completes and then only sets to 1.

If DATA_RDY = 1 prior to a register read, it is cleared at the start of the register read.

If DATA_RDY = 1 prior to a register read and new data becomes available during the register read, DATA_RDY is cleared to 0 at the start of the register read and remains 0 throughout the read. When the read completes, DATA_RDY is set to 1.

ADDITIONAL FEATURES

USING AN EXTERNAL CLOCK

When operating at 2560 Hz ODR or lower, the ADXL371 has a built in 307.2 kHz (typical) clock that, by default, serves as the time base for internal operations. At 5120 Hz ODR, this clock speed increases to 614.4 kHz (typical). If desired, an external clock can be provided instead, for either improved clock frequency accuracy or for control of the output data rate. To use an external clock, set the EXT_CLK bit (Bit 1) in the TIMING register (Register 0x3D) and apply a clock to the INT1 pin.

The external clock can operate at the nominal 307.2 kHz or slower (when using $ODR \leq 2560$ Hz), or 614.4 kHz or slower (when using $ODR = 5120$ Hz) to allow the user to achieve any desired output data rate. Lower external clock rates must be used with caution because it may result in aliasing of high frequency signals that may be present in certain applications.

ODR and bandwidth scale proportionally with the clock. The ADXL371 provides a discrete number of options for ODR. ODRs other than those provided are achieved by selecting an appropriate clock frequency. For example, to achieve a 2048 Hz ODR, use the 2560 Hz setting with a clock frequency that is 80% of nominal, or 245.76 kHz. Bandwidth also scales by the same ratio, therefore, if a 320 Hz bandwidth is selected, the resulting bandwidth is 256 Hz.

SYNCHRONIZED DATA SAMPLING

For applications that require a precisely timed acceleration measurement, the ADXL371 features an option to synchronize acceleration sampling to an external trigger. The EXT_SYNC bit in the TIMING register enables this feature. When the EXT_SYNC bit is set to 1, the INT2 pin automatically reconfigures for use as the sync trigger input.

When external triggering is enabled, it is up to the system designer to ensure that the sampling frequency meets system requirements. Sampling too infrequently causes aliasing. Noise can be lowered by oversampling. However, sampling at too high a frequency may not allow enough time for the accelerometer to process the acceleration data and convert it to valid digital output data.

When the Nyquist criterion is met, signal integrity is maintained. An internal antialiasing filter is available in the ADXL371 and can assist the system designer in maintaining signal integrity. To prevent aliasing, set the filter bandwidth to a frequency no greater than half the sampling rate. For example, when sampling at 1280 Hz, set the filter bandwidth to no higher than 640 Hz.

Because of internal timing requirements, the maximum allowable external trigger frequencies are as follows:

- 1-axis data = 3100 Hz
- 2-axis data = 2700 Hz
- 3-axis data = 2200 Hz

These values are doubled when an ODR rate of 5120 Hz is selected. Additionally, the trigger signal applied to the INT2 pin must meet the following criteria:

- The trigger signal must be active high.
- The pulse width of the trigger signal must be at least 53 μ s.
- The minimum sampling frequency is set only by system requirements. Samples need not be polled at any minimum rate. However, if samples are polled at a rate lower than the bandwidth set by the antialiasing filter, aliasing may occur.

The EXT_SYNC is an active high signal. Due to the asynchronous nature of the internal clock and external sync, there may be a one ODR clock cycle difference between consecutive external sync pulses. The external sync sets the ODR of the system. For example, if sending an external sync at a 2 kHz rate, all three axes (if enabled) are sampled in that 2 kHz window.

SELF TEST

When the self test function is invoked, an electrostatic force is applied to the mechanical sensor. This electrostatic force moves the mechanical sensing element in the same manner as acceleration, and the acceleration experienced by the device increases because of this force. The high-pass filter is automatically disabled for this feature.

Self Test Procedure

The self test function is enabled via the ST bit in the SELF_TEST register, Register 0x40. The ST_DONE bit indicates when the test is completed. Figure 35 describes the self test profile from when ST is set until ST_DONE goes high, which typically takes around 200 ms. Self test is considered successful if ΔST is greater than 5 LSB.

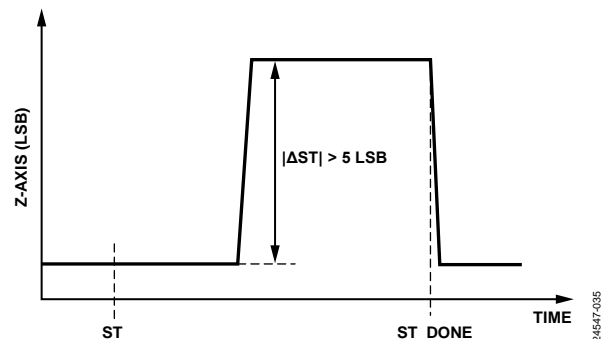

Figure 35. Self Test Waveform

The recommended procedure for using the self test functionality is as follows:

1. Ensure that the low-pass activity filter is enabled.
2. Place the device in measurement mode.
3. Wait until the filter settling time passes.
4. Start the self test by setting the ST bit in the SELF_TEST register (Register 0x40).
5. Read the acceleration data from the z-axis (Register 0x0C and Register 0x0D) and store the data until the self test completes (ST_DONE goes high).
6. Average the first 50 ms of data right after ST is set.
7. Average the last 50 ms of data right before ST_DONE goes high.
8. If the difference between the two averaged values is greater than 5 LSB, the self test passes.

During the deviation of the z-axis, the x-axis and y-axis also show deviation, which is normal. However, the outputs of the x-axis and y-axis cannot be used to qualify pass or fail of the self test.

USER REGISTER PROTECTION

The ADXL371 includes user register protection for single event upsets (SEUs). An SEU is a change of state caused by ions or electromagnetic radiation striking a sensitive node in a micro-electronic device. The state change is a result of the free charge created by ionization in or close to an important node of a logic element (for example, a memory bit). The SEU itself is not considered permanently damaging to transistor or circuit functionality, but it can create erroneous register values. The registers protected from SEU are Register 0x20 to Register 0x3F.

Protection is implemented via a 99-bit error correcting (Hamming type) code and detects both single bit and double bit errors. The

check bits are recomputed any time a write to any of the protected registers occurs. At any time, if the stored version of the check bits is not in agreement with the current check bit calculation, the ERR_USER_REGS status bit is set.

The ERR_USER_REGS bit in the STATUS register starts high when set on an unconfigured device and clears after the first register write.

USER OFFSET TRIMS

The ADXL371 has a 4-bit offset trim for each axis that allows users to add positive or negative offset to the default static acceleration values and correct any deviations from ideal that may result as a consequence of varying the operating parameters of the device. The offset trims have a full-scale range of approximately ± 60 LSB with a trim profile, as shown in Figure 36.

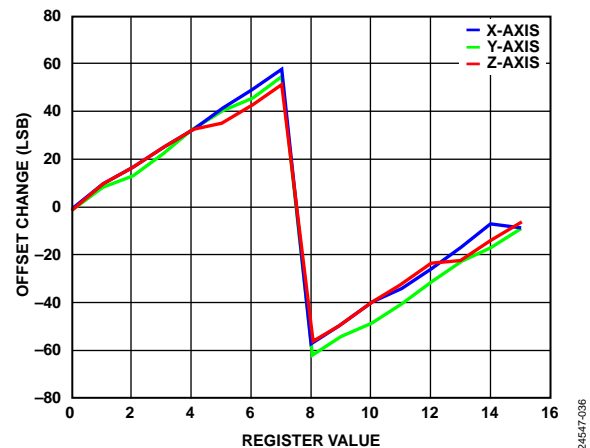

Figure 36. User Offset Trim Profile

SERIAL COMMUNICATIONS

SERIAL INTERFACE

The ADXL371 is designed to communicate in either the SPI or the I²C protocol. It autodetects the format being used, requiring no configuration control to select the format.

SPI Protocol

The timing scheme is as follows: phase (CPHA) = polarity (CPOL) = 0. The ADXL371 supports a SCLK frequency up to 10 MHz. Wire the ADXL371 for SPI communication as shown in Figure 37. For successful communication, follow the logic thresholds and timing parameters in Table 11. The command structure for the read register and write register are shown in Figure 40 and Figure 41, respectively. The read and write register commands support multibyte (burst) read/write access. The waveform diagrams for multibyte read and write commands are shown in Figure 42 and Figure 43, respectively.

Ignore data transmitted from the ADXL371 to the master device during writes to the ADXL371.

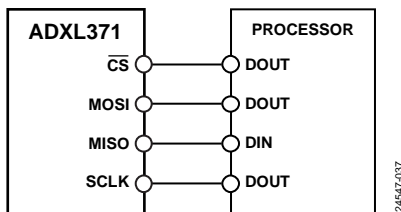

Figure 37. 4-Wire SPI Connection Diagram

I²C Protocol

The ADXL371 supports standard (100 kHz), fast (up to 1 MHz), and high speed (up to 3.4 MHz) data transfer modes if the bus parameters given in Table 12 and shown in Figure 44 are met. There is no minimum SCL frequency, with the exception that when reading data, the clock must be fast enough to read an entire sample set before new data overwrites it. Single-byte or multibyte reads and writes are supported. With the MISO pin low, the I²C address for the device is 0x1D, and an alternate I²C address of 0x53 can be chosen by pulling the MISO pin high.

There are no internal pull-up or pull-down resistors for any unused pins. Therefore, there is no known state or default state for the MISO and SCLK pins if left floating or unconnected. It is a requirement that SCLK be connected to ground when communicating to the ADXL371 using the I²C.

Due to communication speed limitations, the maximum output data rate when using about 6 kHz I²C is 640 Hz and scales linearly with I²C communication speed. Operation at an output

data rate higher than the recommended maximum can result in an undesirable effect on the acceleration data, including missing samples or additional noise.

If other devices are connected to the same I²C bus, the nominal operating voltage level of these other devices cannot exceed V_{DDI/O} by more than 0.3 V. External pull-up resistors (R_P) are necessary for proper I²C operation. Single-byte or multibyte reads and writes are supported, as shown from Figure 45 to Figure 47.

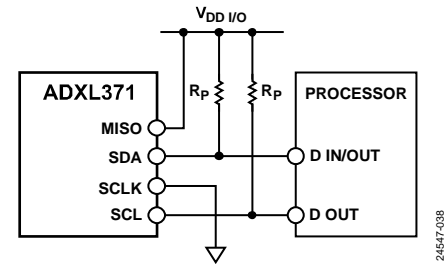

Figure 38. I²C Connection Diagram (ADXL371 Device ID = 0x53)

MULTIBYTE TRANSFERS

Both the SPI and I²C protocols support multibyte transfers, also known as burst transfers. A register read or write begins with the address specified in the command and autoincrements for each additional byte in the transfer. Always read acceleration data using multibyte transfers to ensure that a concurrent and complete set of x-, y-, and z-acceleration data is read.

When writing data to the ADXL371 in I²C mode, the no acknowledge (NACK) bit never generates. Instead, the acknowledge (ACK) bit is sent after every received byte because it is not known how many bytes are included in the transfer. The master decides how many bytes are sent and ends the transaction with the stop condition.

INVALID ADDRESSES AND ADDRESS FOLDING

The ADXL371 has a 6-bit address bus, mapping only 104 registers in the possible 256 register address space. The addresses do not fold to repeat the registers at addresses above 0x104. Attempted access to register addresses above 0x104 are mapped to the invalid register at 0x67 and have no functional effect.

Register 0x00 to Register 0x41 are for customer access, as described in Table 13. Register 0x42 to Register 0x67 are reserved for factory use.

SPI AND I²C TIMING INFORMATION

T_A = 25°C, V_S = 3.3 V, and V_{DDI/O} = 3.3 V, unless otherwise noted.

Table 11. SPI Logic Levels and Timing

Parameter	Description	Min	Typ	Max	Unit
INPUT DC LEVELS					
V _{IL}	Low level input voltage			0.3 × V _{DDI/O}	V
V _{IH}	High level input voltage	0.7 × V _{DDI/O}			V
I _{IL}	Low level input current, V _{IN} = 0 V	-0.1			μA
I _{IH}	High level input current, V _{IN} = V _{DDI/O}			0.1	μA
OUTPUT DC LEVELS					
V _{OL}	Low level output voltage, I _{OL} = I _{OL, MIN}			0.2 × V _{DDI/O}	V
V _{OH}	High level output voltage, I _{OL} = I _{OH, MAX}	0.8 × V _{DDI/O}			V
I _{OL}	Low level output current, V _{OL} = V _{OL, MAX}	-10			mA
I _{OH}	High level output current, V _{OL} = V _{OH, MIN}			4	mA
INPUT AC					
SCLK Frequency		0.1		10	MHz
t _{HIGH}	SCLK high time	40			ns
t _{LOW}	SCLK low time	40			ns
t _{CSS}	$\overline{\text{CS}}$ setup time	20			ns
t _{CSH}	$\overline{\text{CS}}$ hold time	20			ns
t _{CSD}	$\overline{\text{CS}}$ disable time	40			ns
t _{SCLKS}	Rising SCLK setup time	20			ns
t _{SU}	MOSI setup time	20			ns
t _{HD}	MOSI hold time	20			ns
OUTPUT AC					
t _P	Propagation delay, C _{LOAD} = 30 pF			30	ns
t _{EN}	Enable MISO time	30			ns
t _{DIS}	Disable MISO time			20	ns

SPI Timing Diagrams

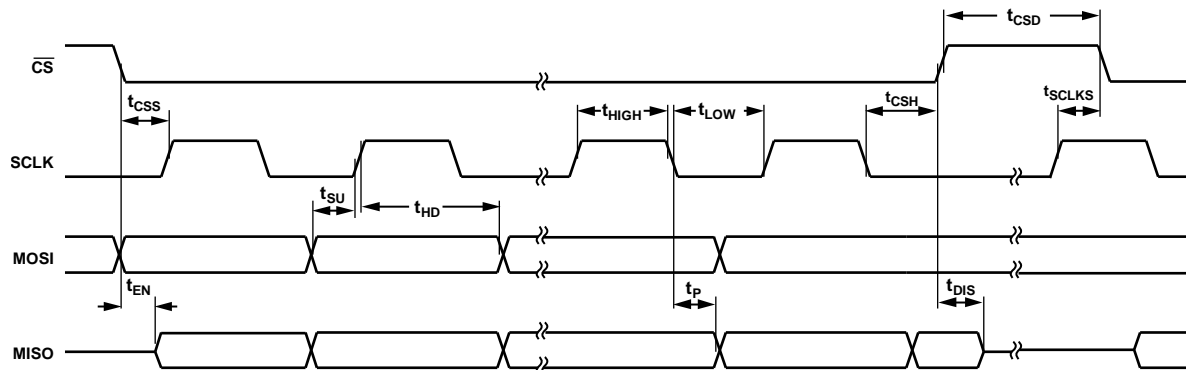

Figure 39. SPI Timing Diagram

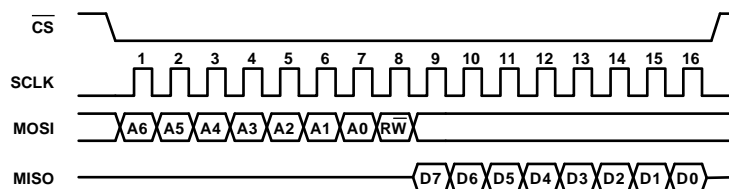

Figure 40. SPI Timing Diagram, Single-Byte Read

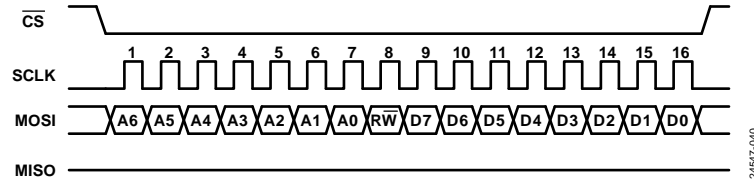

Figure 41. SPI Timing Diagram, Single-Byte Write

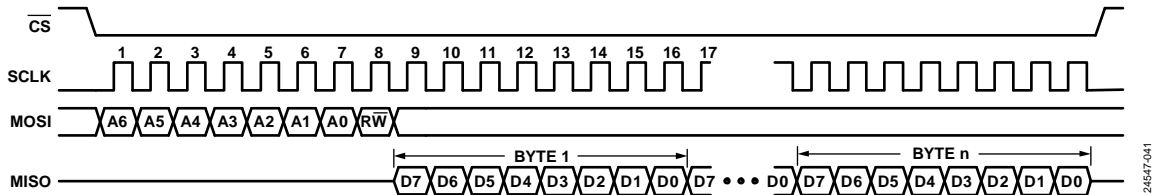

Figure 42. SPI Timing Diagram, Multibyte Read

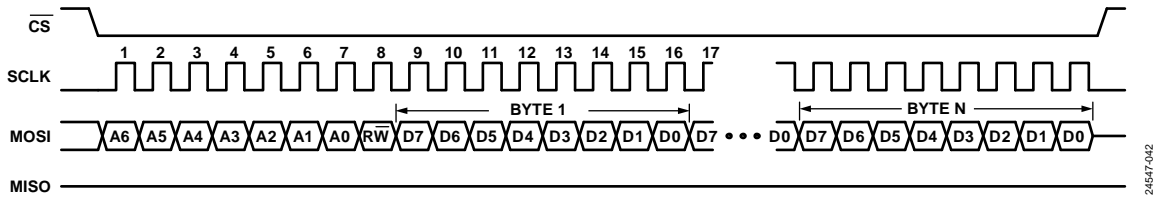

Figure 43. SPI Timing Diagram, Multibyte Write

T_A = 25°C, V_S = 3.3 V, V_{DDI/O} = 3.3 V, unless otherwise noted.

Table 12. I²C Logic Level and Timing

Parameter	Description	I2C_HSM_EN = 0			I2C_HSM_EN = 1			Unit
		Min	Typ	Max	Min	Typ	Max	
INPUT AC								
SCLK Frequency		0		1	0		3.4	MHz
t _{HIGH}	SCLK high time	260			120			ns
t _{LOW}	SCLK low time	500			320			ns
t _{SUSTA}	Start setup time	260			160			ns
t _{HDSTA}	Start hold time	260			160			ns
t _{SUDAT}	Data setup time	50			10			ns
t _{HDDAT}	Data hold time	0			0		150	ns
t _{SUSTO}	Stop setup time	260			160			ns
t _{BUF}	Bus free time	500						ns
t _{RCL}	SCL input rise time			120	20		80	ns
t _{FCL}	SCL input fall time	20 × (V _{DD} /5.5)		120	20		80	ns
t _{RDA}	SDA input rise time			120	20		160	ns
t _{FDA}	SDA input fall time	20 × (V _{DD} /5.5)		120	20		160	ns
OUTPUT AC								
C _{LOAD}				550			400	pF

I²C Timing Diagrams

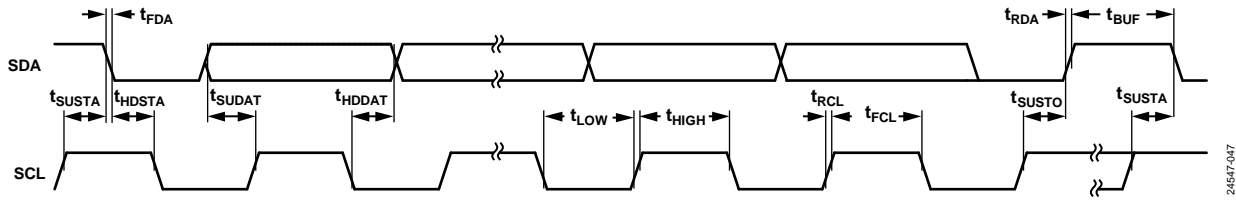

Figure 44. I²C Timing Diagram

24547-047

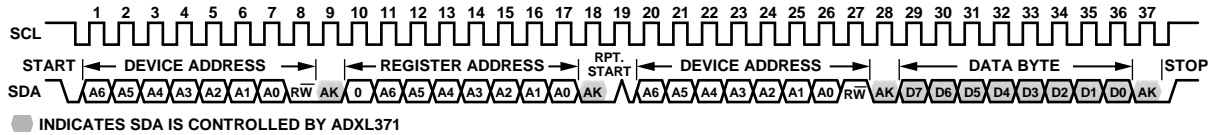

Figure 45. I²C Timing Diagram, Single-Byte Read

24547-043

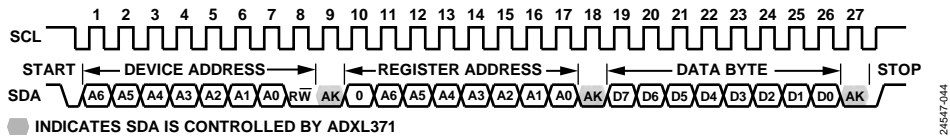

Figure 46. I²C Timing Diagram, Single-Byte Write

24547-044

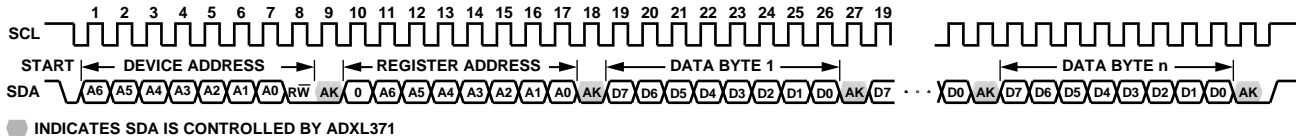

Figure 47. I²C Timing Diagram, Multibyte Write

24547-045

REGISTER MAP

Table 13. Register Map

Reg	Name	Bits	Bit 7	Bit 6	Bit 5	Bit 4	Bit 3	Bit 2	Bit 1	Bit 0	Reset	R/W	
0x00	DEVID_AD	[7:0]	DEVID_AD									0xAD	R
0x01	DEVID_MST	[7:0]	DEVID_MST									0x1D	R
0x02	PARTID	[7:0]	DEVID_PRODUCT									0xFA	R
0x03	REVID	[7:0]	REVID									0xFB	R
0x04	STATUS	[7:0]	ERR_USER_REGS	AWAKE	USER_NVM_BUSY	RESERVED				DATA_RDY	0xA0	R	
0x05	STATUS2	[7:0]	RESERVED	ACTIVITY2	ACTIVITY	INACT	RESERVED				0x00	R	
0x06	RESERVED	[7:0]	RESERVED									0x00	R
0x07	RESERVED	[7:0]	RESERVED									0x00	R
0x08	XDATA_H	[7:0]	XDATA[11:4]									0x00	R
0x09	XDATA_L	[7:0]	XDATA[3:0]				RESERVED				0x00	R	
0x0A	YDATA_H	[7:0]	YDATA[11:4]									0x00	R
0x0B	YDATA_L	[7:0]	YDATA[3:0]				RESERVED				0x00	R	
0x0C	ZDATA_H	[7:0]	ZDATA[11:4]									0x00	R
0x0D	ZDATA_L	[7:0]	ZDATA[3:0]				RESERVED				0x00	R	
0x15 to 0x1A	RESERVED	[7:0]	RESERVED									0x00	R
0x20	OFFSET_X	[7:0]	RESERVED				OFFSET_X				0x00	R/W	
0x21	OFFSET_Y	[7:0]	RESERVED				OFFSET_Y				0x00	R/W	
0x22	OFFSET_Z	[7:0]	RESERVED				OFFSET_Z				0x00	R/W	
0x23	THRESH_ACT_X_H	[7:0]	THRESH_ACT_X[10:3]									0x00	R/W
0x24	THRESH_ACT_X_L	[7:0]	THRESH_ACT_X[2:0]			RESERVED			ACT_REF	ACT_X_EN	0x00	R/W	
0x25	THRESH_ACT_Y_H	[7:0]	THRESH_ACT_Y[10:3]									0x00	R/W
0x26	THRESH_ACT_Y_L	[7:0]	THRESH_ACT_Y[2:0]			RESERVED			ACT_Y_EN	0x00	R/W		
0x27	THRESH_ACT_Z_H	[7:0]	THRESH_ACT_Z[10:3]									0x00	R/W
0x28	THRESH_ACT_Z_L	[7:0]	THRESH_ACT_Z[2:0]			RESERVED			ACT_Z_EN	0x00	R/W		
0x29	TIME_ACT	[7:0]	ACT_COUNT									0x00	R/W
0x2A	THRESH_INACT_X_H	[7:0]	THRESH_INACT_X[10:3]									0x00	R/W
0x2B	THRESH_INACT_X_L	[7:0]	THRESH_INACT_X[2:0]			RESERVED			INACT_REF	INACT_X_EN	0x00	R/W	
0x2C	THRESH_INACT_Y_H	[7:0]	THRESH_INACT_Y[10:3]									0x00	R/W
0x2D	THRESH_INACT_Y_L	[7:0]	THRESH_INACT_Y[2:0]			RESERVED			INACT_Y_EN	0x00	R/W		
0x2E	THRESH_INACT_Z_H	[7:0]	THRESH_INACT_Z[10:3]									0x00	R/W
0x2F	THRESH_INACT_Z_L	[7:0]	THRESH_INACT_Z[2:0]			RESERVED			INACT_Z_EN	0x00	R/W		
0x30	TIME_INACT_H	[7:0]	INACT_COUNT[15:8]									0x00	R/W
0x31	TIME_INACT_L	[7:0]	INACT_COUNT[7:0]									0x00	R/W
0x32	THRESH_ACT2_X_H	[7:0]	THRESH_ACT2_X[10:3]									0x00	R/W
0x33	THRESH_ACT2_X_L	[7:0]	THRESH_ACT2_X[2:0]			RESERVED			ACT2_REF	ACT2_X_EN	0x00	R/W	
0x34	THRESH_ACT2_Y_H	[7:0]	THRESH_ACT2_Y[10:3]									0x00	R/W
0x35	THRESH_ACT2_Y_L	[7:0]	THRESH_ACT2_Y[2:0]			RESERVED			ACT2_Y_EN	0x00	R/W		
0x36	THRESH_ACT2_Z_H	[7:0]	THRESH_ACT2_Z[10:3]									0x00	R/W
0x37	THRESH_ACT2_Z_L	[7:0]	THRESH_ACT2_Z[2:0]			RESERVED			ACT2_Z_EN	0x00	R/W		

Reg	Name	Bits	Bit 7	Bit 6	Bit 5	Bit 4	Bit 3	Bit 2	Bit 1	Bit 0	Reset	R/W	
0x38	HPF	[7:0]	RESERVED						HPF_CORNER		0x00	R/W	
0x39	RESERVED	[7:0]	RESERVED									0x00	R
0x3A	RESERVED	[7:0]	RESERVED									0x00	R
0x3B	INT1_MAP	[7:0]	INT1_LOW	AWAKE_INT1	ACT_INT1	INACT_INT1	RESERVED			DATA_RDY_INT1	0x00	R/W	
0x3C	INT2_MAP	[7:0]	INT2_LOW	AWAKE_INT2	ACT2_INT2	INACT_INT2	RESERVED			DATA_RDY_INT2	0x00	R/W	
0x3D	TIMING	[7:0]	ODR			WAKEUP_RATE		EXT_CLK	EXT_SYNC	0x00	R/W		
0x3E	MEASURE	[7:0]	USER_OR_DISABLE	AUTOSLEEP	LINKLOOP		LOW_NOISE	BANDWIDTH		0x00	R/W		
0x3F	POWER_CTL	[7:0]	I2C_HSM_EN	RESERVED	INSTANT_ON_THRESH	FILTER_SETTLE	LPF_DISABLE	HPF_DISABLE	MODE		0x00	R/W	
0x40	SELF_TEST	[7:0]	RESERVED						ST_DONE	ST	0x00	R/W	
0x41	RESET	[7:0]	RESET									0x00	W

REGISTER DETAILS

ANALOG DEVICES ID REGISTER

Address: 0x00, Reset: 0xAD, Name: DEVID_AD

This register contains the Analog Devices, Inc., ID, 0xAD.

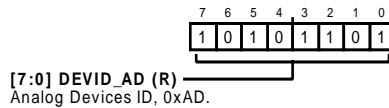

Table 14. Bit Descriptions for DEVID_AD

Bits	Bit Name	Settings	Description	Reset	Access
[7:0]	DEVID_AD		Analog Devices ID, 0xAD.	0xAD	R

ANALOG DEVICES MEMS ID REGISTER

Address: 0x01, Reset: 0x1D, Name: DEVID_MST

This register contains the Analog Devices MEMS ID, 0x1D.

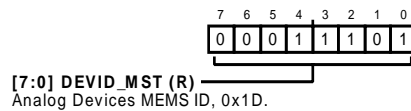

Table 15. Bit Descriptions for DEVID_MST

Bits	Bit Name	Settings	Description	Reset	Access
[7:0]	DEVID_MST		Analog Devices MEMS ID, 0x1D.	0x1D	R

DEVICE ID REGISTER

Address: 0x02, Reset: 0xFA, Name: PARTID

This register contains the device ID, 0xFA (372 octal).

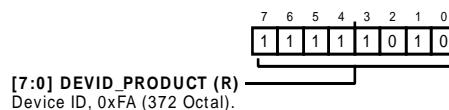

Table 16. Bit Descriptions for PARTID

Bits	Bit Name	Settings	Description	Reset	Access
[7:0]	DEVID_PRODUCT		Device ID, 0xFA (372 Octal).	0xFA	R

PRODUCT REVISION ID REGISTER

Address: 0x03, Reset: 0xFB, Name: REVID

This register contains the mask revision ID, beginning with 0x00 and incrementing for each subsequent revision.

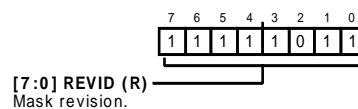

Table 17. Bit Descriptions for REVID

Bits	Bit Name	Settings	Description	Reset	Access
[7:0]	REVID		Mask revision.	0xFB	R

STATUS REGISTER

Address: 0x04, Reset: 0xA0, Name: STATUS

This register includes the following bits that describe various conditions of the ADXL371.

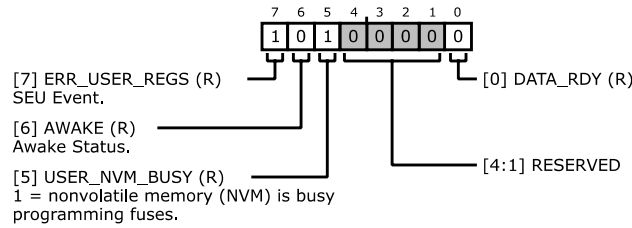

Table 18. Bit Descriptions for STATUS

Bits	Bit Name	Settings	Description	Reset	Access
7	ERR_USER_REGS		SEU Event. An SEU event is detected in a user register.	0x1	R
6	AWAKE		Awake Status. Activity detected, and the device is moving.	0x0	R
5	USER_NVM_BUSY		1 = nonvolatile memory (NVM) is busy programming fuses.	0x1	R
[4:1]	RESERVED		Reserved.	0x0	R
0	DATA_RDY		Status is high after the full data set completes. A complete x, y, and z measurement was made, and results can be read.	0x0	R

ACTIVITY STATUS REGISTER

Address: 0x05, Reset: 0x00, Name: STATUS2

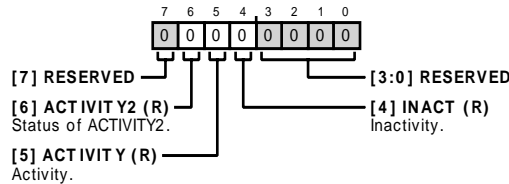

Table 19. Bit Descriptions for STATUS2

Bits	Bit Name	Settings	Description	Reset	Access
7	RESERVED		Reserved.	0x0	R
6	ACTIVITY2		Status of ACTIVITY2.	0x0	R
5	ACTIVITY		Activity. Activity is detected.	0x0	R
4	INACT		Inactivity. Inactivity is detected.	0x0	R
[3:0]	RESERVED		Reserved.	0x0	R

X-AXIS DATA REGISTER, MSB

Address: 0x08, Reset: 0x00, Name: XDATA_H

These two registers contain the x-axis acceleration data. Data is left justified and formatted as twos complement. XDATA_H contains the eight MSBs, and XDATA_L contains the four LSBs of the 12-bit value.

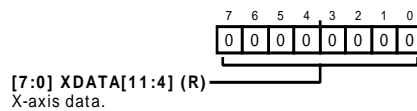

Table 20. Bit Descriptions for XDATA_H

Bits	Bit Name	Settings	Description	Reset	Access
[7:0]	XDATA[11:4]		X-axis data.	0x0	R

X-AXIS DATA REGISTER, LSB

Address: 0x09, Reset: 0x00, Name: XDATA_L

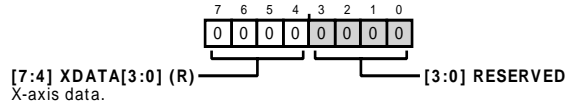

Table 21. Bit descriptions for XDATA_L

Bits	Bit Name	Settings	Description	Reset	Access
[7:4]	XDATA[3:0]		X-axis data.	0x0	R
[3:0]	RESERVED		Reserved.	0x0	R

Y-AXIS DATA REGISTER, MSB

Address: 0x0A, Reset: 0x00, Name: YDATA_H

The YDATA_H and YDATA_L registers contain the y-axis, LSB acceleration data. Data is left justified and formatted as twos complement. YDATA_H contains the eight MSBs, and YDATA_L contains the four LSBs of the 12-bit value.

YDATA_L latches on a read of YDATA_H to ensure data integrity.

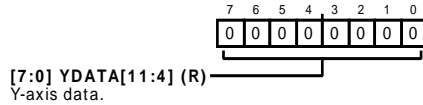

Table 22. Bit Descriptions for YDATA_H

Bits	Bit Name	Settings	Description	Reset	Access
[7:0]	YDATA[11:4]		Y-axis data.	0x0	R

Y-AXIS DATA REGISTER, LSB

Address: 0x0B, Reset: 0x00, Name: YDATA_L

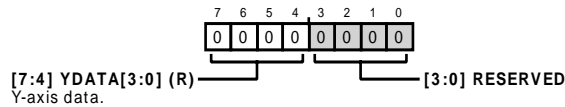

Table 23. Bit Descriptions for YDATA_L

Bits	Bit Name	Settings	Description	Reset	Access
[7:4]	YDATA[3:0]		Y-axis data.	0x0	R
[3:0]	RESERVED		Reserved.	0x0	R

Z-AXIS DATA REGISTER, MSB

Address: 0x0C, Reset: 0x00, Name: ZDATA_H

These two registers contain the z-axis acceleration data. Data is left justified and formatted as twos complement. ZDATA_H contains the eight MSBs, and ZDATA_L contains the four LSBs of the 12-bit value.

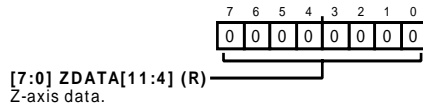

Table 24. Bit Descriptions for ZDATA_H

Bits	Bit Name	Settings	Description	Reset	Access
[7:0]	ZDATA[11:4]		Z-axis data.	0x0	R

Z-AXIS DATA REGISTER, LSB

Address: 0x0D, Reset: 0x00, Name: ZDATA_L

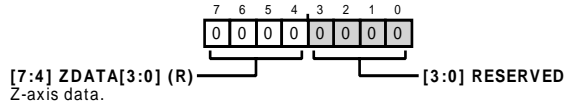

Table 25. Bit Descriptions for ZDATA_L

Bits	Bit Name	Settings	Description	Reset	Access
[7:4]	ZDATA[3:0]		Z-axis data.	0x0	R
[3:0]	RESERVED		Reserved.	0x0	R

OFFSET TRIM REGISTERS

Offset trim registers are each four bits and offer user set, offset adjustments in twos complement format. The scale factor of these registers is shown in Figure 36.

X-AXIS OFFSET TRIM REGISTER, LSB

Address: 0x20, Reset: 0x00, Name: OFFSET_X

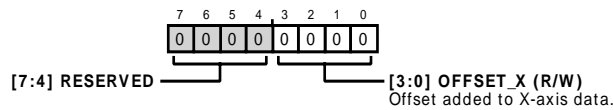

Table 26. Bit Descriptions for OFFSET_X

Bits	Bit Name	Settings	Description	Reset	Access
[7:4]	RESERVED		Reserved.	0x0	R
[3:0]	OFFSET_X		Offset added to X-axis data.	0x0	R/W

Y-AXIS OFFSET TRIM REGISTER, LSB

Address: 0x21, Reset: 0x00, Name: OFFSET_Y

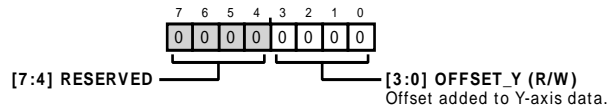

Table 27. Bit Descriptions for OFFSET_Y

Bits	Bit Name	Settings	Description	Reset	Access
[7:4]	RESERVED		Reserved.	0x0	R
[3:0]	OFFSET_Y		Offset added to Y-axis data.	0x0	R/W

Z-AXIS OFFSET TRIM REGISTER, LSB

Address: 0x22, Reset: 0x00, Name: OFFSET_Z

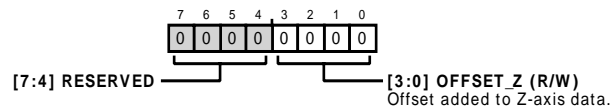

Table 28. Bit Descriptions for OFFSET_Z

Bits	Bit Name	Settings	Description	Reset	Access
[7:4]	RESERVED		Reserved.	0x0	R
[3:0]	OFFSET_Z		Offset added to Z-axis data.	0x0	R/W

X-AXIS ACTIVITY THRESHOLD REGISTER, MSB

Address: 0x23, Reset: 0x00, Name: THRESH_ACT_X_H

This 11-bit unsigned value sets the threshold for activity detection. This value is set in codes and the scale factor is 100 mg per code. To detect activity, the absolute value of the 12-bit acceleration data is compared with the 11-bit (unsigned) activity threshold value. The THRESH_ACT_X_L register contains the least significant bits, and the THRESH_ACT_X_H register contains the most significant byte of the activity threshold value.

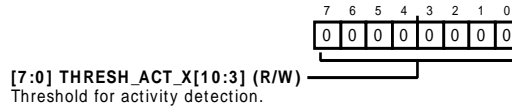

Table 29. Bit Descriptions for THRESH_ACT_X_H

Bits	Bit Name	Settings	Description	Reset	Access
[7:0]	THRESH_ACT_X[10:3]		Threshold for activity detection. The 8 MSBs of x-axis threshold.	0x0	R/W

X-AXIS OF ACTIVITY THRESHOLD REGISTER, LSB

Address: 0x24, Reset: 0x00, Name: THRESH_ACT_X_L

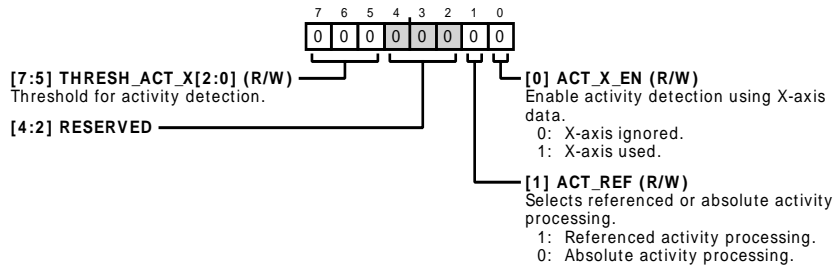

Table 30. Bit Descriptions for THRESH_ACT_X_L

Bits	Bit Name	Settings	Description	Reset	Access
[7:5]	THRESH_ACT_X[2:0]		Threshold for activity detection. The 3 LSBs of x-axis threshold.	0x0	R/W
[4:2]	RESERVED		Reserved.	0x0	R
1	ACT_REF		Selects referenced or absolute activity processing. 1 Referenced activity processing. 0 Absolute activity processing.	0x0	R/W
0	ACT_X_EN		Enable activity detection using X-axis data. 0 X-axis ignored. 1 X-axis used.	0x0	R/W

Y-AXIS ACTIVITY THRESHOLD REGISTER, MSB

Address: 0x25, Reset: 0x00, Name: THRESH_ACT_Y_H

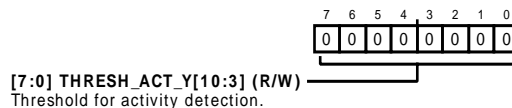

Table 31. Bit Descriptions for THRESH_ACT_Y_H

Bits	Bit Name	Settings	Description	Reset	Access
[7:0]	THRESH_ACT_Y[10:3]		Threshold for activity detection. The 8 MSBs of y-axis threshold.	0x0	R/W

Y-AXIS OF ACTIVITY THRESHOLD REGISTER, LSB

Address: 0x26, Reset: 0x00, Name: THRESH_ACT_Y_L

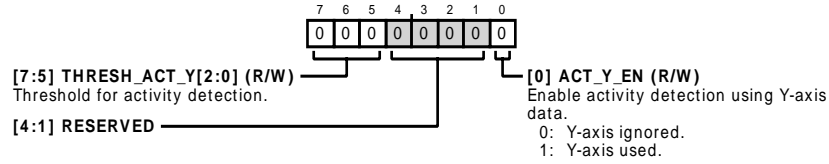

Table 32. Bit Descriptions for THRESH_ACT_Y_L

Bits	Bit Name	Settings	Description	Reset	Access
[7:5]	THRESH_ACT_Y[2:0]		Threshold for activity detection. The 3 LSBs of y-axis threshold.	0x0	R/W
[4:1]	RESERVED		Reserved.	0x0	R
0	ACT_Y_EN	0 1	Enable activity detection using Y-axis data. Y-axis ignored. Y-axis used.	0x0	R/W

Z-AXIS ACTIVITY THRESHOLD REGISTER, MSB

Address: 0x27, Reset: 0x00, Name: THRESH_ACT_Z_H



Table 33. Bit Descriptions for THRESH_ACT_Z_H

Bits	Bit Name	Settings	Description	Reset	Access
[7:0]	THRESH_ACT_Z[10:3]		Threshold for activity detection. The 8 MSBs of z-axis threshold.	0x0	R/W

Z-AXIS OF ACTIVITY THRESHOLD REGISTER, LSB

Address: 0x28, Reset: 0x00, Name: THRESH_ACT_Z_L

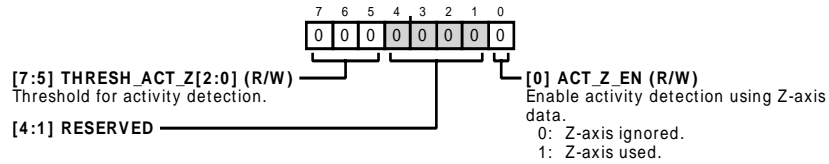

Table 34. Bit Descriptions for THRESH_ACT_Z_L

Bits	Bit Name	Settings	Description	Reset	Access
[7:5]	THRESH_ACT_Z[2:0]		Threshold for activity detection. The 3 LSBs of z-axis threshold.	0x0	R/W
[4:1]	RESERVED		Reserved.	0x0	R
0	ACT_Z_EN	0 1	Enable activity detection using Z-axis data. Z-axis ignored. Z-axis used.	0x0	R/W

ACTIVITY TIME REGISTER

Address: 0x29, Reset: 0x00, Name: TIME_ACT

The activity timer implements a robust activity detection that minimizes false positive motion triggers. When the timer is used, only sustained motion can trigger activity detection. The time (in milliseconds) is given by the following equation:

$$Time = TIME_ACT \times 4.125 \text{ ms per code}$$

where:

TIME_ACT is the value set in this register.

4.125 ms per code is the scale factor of the *TIME_ACT* register for ODR = 5120 Hz. It is 8.25 ms per code for ODR = 2560 Hz and lower. See the Activity Timer section for more information.

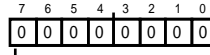

[7:0] ACT_COUNT (R/W)
Number of multiples of 4.125 ms activity timer for which above threshold acceleration is required to detect activity.

Table 35. Bit Descriptions for TIME_ACT

Bits	Bit Name	Settings	Description	Reset	Access
[7:0]	ACT_COUNT		Number of multiples of 4.125 ms activity timer for which above threshold acceleration is required to detect activity. It is 4.125 ms per code for 5120 Hz ODR, and it is 8.25 ms per code for 2560 Hz ODR and lower.	0x0	R/W

X-AXIS INACTIVITY THRESHOLD REGISTER, MSB

Address: 0x2A, Reset: 0x00, Name: THRESH_INACT_X_H

This 11-bit unsigned value sets the threshold for inactivity detection. This value is set in codes, and the scale factor is 100 mg per code. To detect inactivity, the absolute value of the 12-bit acceleration data is compared with the 11-bit (unsigned) inactivity threshold value. The THRESH_INACT_X_L register contains the least significant bits, and the THRESH_INACT_X_H register contains the most significant byte of the inactivity threshold value.

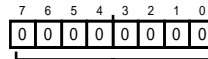

[7:0] THRESH_INACT_X[10:3] (R/W)
Threshold for inactivity detection.

Table 36. Bit Descriptions for THRESH_INACT_X_H

Bits	Bit Name	Settings	Description	Reset	Access
[7:0]	THRESH_INACT_X[10:3]		Threshold for inactivity detection. The 8 MSBs of x-axis.	0x0	R/W

X-AXIS OF INACTIVITY THRESHOLD REGISTER, LSB

Address: 0x2B, Reset: 0x00, Name: THRESH_INACT_X_L

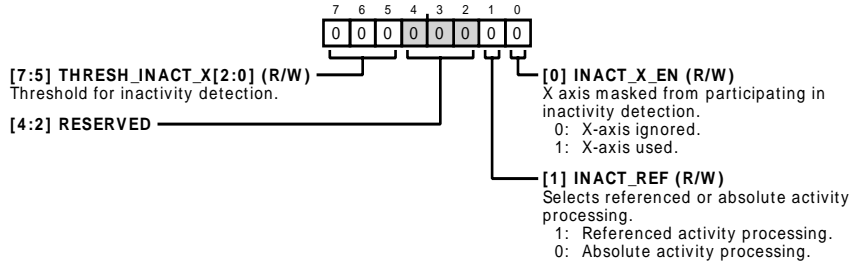

Table 37. Bit Descriptions for THRESH_INACT_X_L

Bits	Bit Name	Settings	Description	Reset	Access
[7:5]	THRESH_INACT_X[2:0]		Threshold for inactivity detection. The 3 LSBs of the x-axis.	0x0	R/W
[4:2]	RESERVED		Reserved.	0x0	R
1	INACT_REF	1 0	Selects referenced or absolute inactivity processing. 1 Referenced inactivity processing. 0 Absolute inactivity processing.	0x0	R/W
0	INACT_X_EN	0 1	X-axis masked from participating in inactivity detection. 0 X-axis ignored. 1 X-axis used.	0x0	R/W

Y-AXIS INACTIVITY THRESHOLD REGISTER, MSB

Address: 0x2C, Reset: 0x00, Name: THRESH_INACT_Y_H

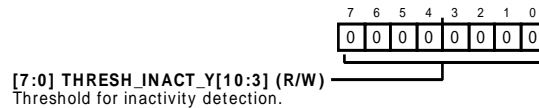

Table 38. Bit Descriptions for THRESH_INACT_Y_H

Bits	Bit Name	Settings	Description	Reset	Access
[7:0]	THRESH_INACT_Y[10:3]		Threshold for inactivity detection. The 8 MSBs of the y-axis.	0x0	R/W

Y-AXIS OF INACTIVITY THRESHOLD REGISTER, LSB

Address: 0x2D, Reset: 0x00, Name: THRESH_INACT_Y_L

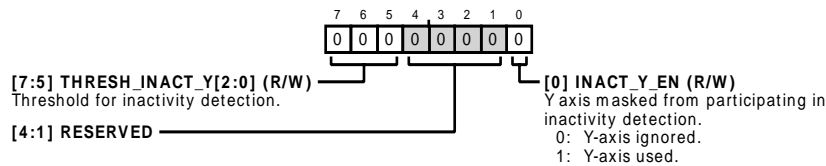

Table 39. Bit Descriptions for THRESH_INACT_Y_L

Bits	Bit Name	Settings	Description	Reset	Access
[7:5]	THRESH_INACT_Y[2:0]		Threshold for inactivity detection. The 3 LSBs of the y-axis.	0x0	R/W
[4:1]	RESERVED		Reserved.	0x0	R
0	INACT_Y_EN	0 1	Y-axis masked from participating in inactivity detection. 0 Y-axis ignored. 1 Y-axis used.	0x0	R/W

Z-AXIS INACTIVITY THRESHOLD REGISTER, MSB

Address: 0x2E, Reset: 0x00, Name: THRESH_INACT_Z_H

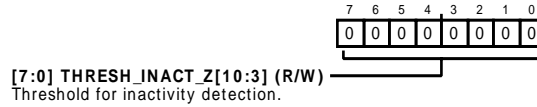

Table 40. Bit Descriptions for THRESH_INACT_Z_H

Bits	Bit Name	Settings	Description	Reset	Access
[7:0]	THRESH_INACT_Z[10:3]		Threshold for inactivity detection. The 8 MSBs of the z-axis.	0x0	R/W

Z-AXIS OF INACTIVITY THRESHOLD REGISTER, LSB

Address: 0x2F, Reset: 0x00, Name: THRESH_INACT_Z_L

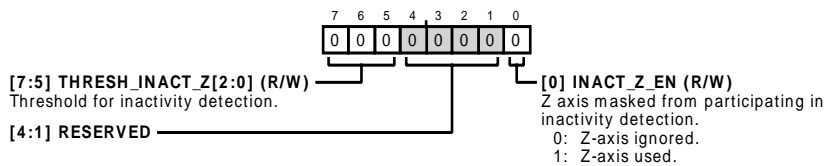

Table 41. Bit Descriptions for THRESH_INACT_Z_L

Bits	Bit Name	Settings	Description	Reset	Access
[7:5]	THRESH_INACT_Z[2:0]		Threshold for inactivity detection. The 3 LSBs of the z-axis.	0x0	R/W
[4:1]	RESERVED		Reserved.	0x0	R
0	INACT_Z_EN	0 1	Z-axis masked from participating in inactivity detection. Z-axis ignored. Z-axis used.	0x0	R/W

INACTIVITY TIME REGISTERS

The 16-bit value in these registers sets the time that all enabled axes must be lower than the inactivity threshold for an inactivity event to be detected. The TIME_INACT_L register holds the eight LSBs, and the TIME_INACT_H register holds the eight MSBs of the 16-bit TIME_INACT value.

Calculate the time as follows:

$$Time = TIME_INACT \times 32.5 \text{ ms per code}$$

where:

TIME_INACT is the 16-bit value set by the TIME_INACT_L register (eight LSBs) and the TIME_INACT_H register (eight MSBs). 32.5 ms per code is the scale factor of the TIME_INACT_L and TIME_INACT_H registers for 2560 Hz and lower. It is 16.25 ms per code of ODR = 5120 Hz. See the Inactivity Timer section for more information.

INACTIVITY TIMER REGISTER, MSB

Address: 0x30, Reset: 0x00, Name: TIME_INACT_H

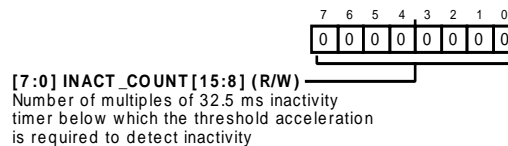

Table 42. Bit Descriptions for TIME_INACT_H

Bits	Bit Name	Settings	Description	Reset	Access
[7:0]	INACT_COUNT[15:8]		Number of multiples of 32.5 ms inactivity timer below which the threshold acceleration is required to detect inactivity. It is 32.5 ms per code for 2560 Hz ODR and lower, and it is 16.25 ms per code for 5120 Hz ODR.	0x0	R/W

INACTIVITY TIMER REGISTER, LSB

Address: 0x31, Reset: 0x00, Name: TIME_INACT_L



[7:0] INACT_COUNT[7:0] (R/W)
Number of multiples of 32.5 ms inactivity timer below which the threshold acceleration is required to detect inactivity

Table 43. Bit Descriptions for TIME_INACT_L

Bits	Bit Name	Settings	Description	Reset	Access
[7:0]	INACT_COUNT[7:0]		Number of multiples of 32.5 ms inactivity timer below which the threshold acceleration is required to detect inactivity.	0x0	R/W

X-AXIS MOTION WARNING THRESHOLD REGISTER, MSB

Address: 0x32, Reset: 0x00, Name: THRESH_ACT2_X_H

This 11-bit unsigned value sets the threshold for motion detection. This value is set in codes, and the scale factor is 100 mg per code. To detect motion, the absolute value of the 12-bit acceleration data is compared with the 11-bit (unsigned) ACTIVITY2 threshold value. The THRESH_ACT2_X_L register contains the least significant bits, and the THRESH_ACT2_X_H register contains the most significant byte of the ACTIVITY2 threshold value.

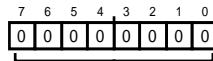

[7:0] THRESH_ACT2_X[10:3] (R/W)
OTN Threshold.

Table 44. Bit Descriptions for THRESH_ACT2_X_H

Bits	Bit Name	Settings	Description ¹	Reset	Access
[7:0]	THRESH_ACT2_X[10:3]		OTN Threshold. The 8 MSBs of the x-axis threshold for motion warning interrupt.	0x0	R/W

¹ OTN stands for other threshold notification.

X-AXIS OF MOTION WARNING NOTIFICATION REGISTER, LSB

Address: 0x33, Reset: 0x00, Name: THRESH_ACT2_X_L

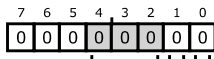

[7:5] THRESH_ACT2_X[2:0] (R/W)
OTN Threshold.

[4:2] RESERVED

[0] ACT2_X_EN (R/W)
X-axis ACT2 enable.
0: X-axis ignored.
1: X-axis used.

[1] ACT2_REF (R/W)
Selects referenced or absolute over threshold notification processing.
1: Referenced activity processing.
0: Absolute activity processing.

Table 45. Bit Descriptions for THRESH_ACT2_X_L

Bits	Bit Name	Settings	Description	Reset	Access
[7:5]	THRESH_ACT2_X[2:0]		OTN Threshold. The 3 LSBs of the x-axis threshold for motion warning interrupt.	0x0	R/W
[4:2]	RESERVED		Reserved.	0x0	R
1	ACT2_REF	1 0	Selects referenced or absolute over threshold notification processing. Referenced activity processing. Absolute activity processing.	0x0	R/W
0	ACT2_X_EN	0 1	X-axis ACT2 enable. When set to 1, the x-axis participates in motion warning notification detection. X-axis ignored. X-axis used.	0x0	R/W

Y-AXIS MOTION WARNING NOTIFICATION THRESHOLD REGISTER, MSB

Address: 0x34, Reset: 0x00, Name: THRESH_ACT2_Y_H

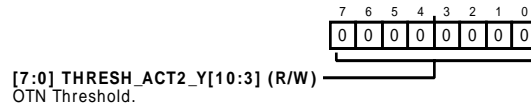

Table 46. Bit Descriptions for THRESH_ACT2_Y_H

Bits	Bit Name	Settings	Description	Reset	Access
[7:0]	THRESH_ACT2_Y[10:3]		OTN Threshold. The 8 MSBs of the y-axis threshold for motion warning interrupt.	0x0	R/W

Y-AXIS OF MOTION WARNING NOTIFICATION REGISTER, LSB

Address: 0x35, Reset: 0x00, Name: THRESH_ACT2_Y_L

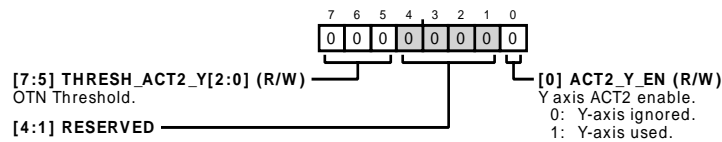

Table 47. Bit Descriptions for THRESH_ACT2_Y_L

Bits	Bit Name	Settings	Description	Reset	Access
[7:5]	THRESH_ACT2_Y[2:0]		OTN Threshold. The 3 LSBs of the y-axis threshold for motion warning interrupt.	0x0	R/W
[4:1]	RESERVED		Reserved.	0x0	R
0	ACT2_Y_EN	0 1	Y-axis ACT2 enable. When 1, the y-axis participates in motion warning notification detection. Y-axis ignored. Y-axis used.	0x0	R/W

Z-AXIS MOTION WARNING NOTIFICATION THRESHOLD REGISTER, MSB

Address: 0x36, Reset: 0x00, Name: THRESH_ACT2_Z_H

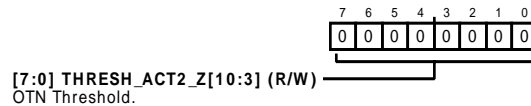

Table 48. Bit Descriptions for THRESH_ACT2_Z_H

Bits	Bit Name	Settings	Description	Reset	Access
[7:0]	THRESH_ACT2_Z[10:3]		OTN Threshold. The 8 MSBs of the z-axis threshold for motion warning interrupt.	0x0	R/W

Z-AXIS MOTION WARNING NOTIFICATION REGISTER, LSB

Address: 0x37, Reset: 0x00, Name: THRESH_ACT2_Z_L

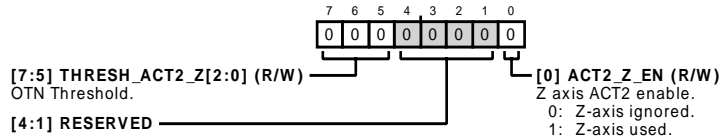

Table 49. Bit Descriptions for THRESH_ACT2_Z_L

Bits	Bit Name	Settings	Description	Reset	Access
[7:5]	THRESH_ACT2_Z[2:0]		OTN Threshold. The 3 LSBs of the z-axis threshold for motion warning interrupt.	0x0	R/W
[4:1]	RESERVED		Reserved.	0x0	R
0	ACT2_Z_EN	0 1	Z-axis ACT2 enable. When 1, the z-axis participates in motion warning notification detection. Z-axis ignored. Z-axis used.	0x0	R/W

HIGH-PASS FILTER SETTINGS REGISTER

Address: 0x38, Reset: 0x00, Name: HPF

Use this register to specify parameters for the internal high-pass filter.

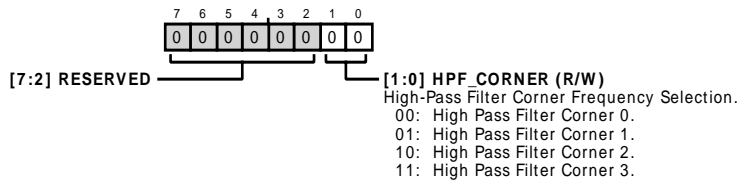

Table 50. Bit Descriptions for HPF

Bits	Bit Name	Settings	Description	Reset	Access
[7:2]	RESERVED		Reserved.	0x0	R
[1:0]	HPF_CORNER	00 01 10 11	High-Pass Filter Corner Frequency Selection. High-Pass Filter Corner 0. At ODR 5120 Hz = 30.48 Hz, at ODR 2560 Hz = 15.24 Hz, at ODR 1280 Hz = 7.61 Hz, at ODR 640 Hz = 3.81 Hz, and at ODR 320 Hz = 1.90 Hz. High-Pass Filter Corner 1. At ODR 5120 Hz = 15.58 Hz, at ODR 2560 Hz = 7.79 Hz, at ODR 1280 Hz = 3.89 Hz, at ODR 640 Hz = 1.94 Hz, and at ODR 320 Hz = 0.97 Hz. High-Pass Filter Corner 2. At ODR 5120 Hz = 7.88 Hz, at ODR 2560 Hz = 3.94 Hz, at ODR 1280 Hz = 1.97 Hz, at ODR 640 Hz = 0.98 Hz, and at ODR 320 Hz = 0.49 Hz. High-Pass Filter Corner 3. At ODR 5120 Hz = 3.96 Hz, at ODR 2560 Hz = 1.98 Hz, at ODR 1280 Hz = 0.99 Hz, at ODR 640 Hz = 0.49 Hz, and at ODR 320 Hz = 0.24 Hz.	0x0	R/W

INTERRUPT PIN FUNCTION MAP REGISTERS

Address: 0x3B, Reset: 0x00, Name: INT1_MAP

The INT1_MAP and INT2_MAP registers configure the INT1 and INT2 interrupt pins, respectively. Bits[6:0] select which function(s) generate an interrupt on the pin. If its corresponding bit is set to 1, the function generates an interrupt on the INTx pin. Bit B7 configures whether the pin operates in active high (B7 low) or active low (B7 high) mode. Any number of functions can be selected simultaneously for each pin. If multiple functions are selected, their conditions are OR'ed together to determine the INTx pin state. The status of each function can be determined by reading the status register. If no interrupts are mapped to an INTx pin, the pin remains in a high impedance state.

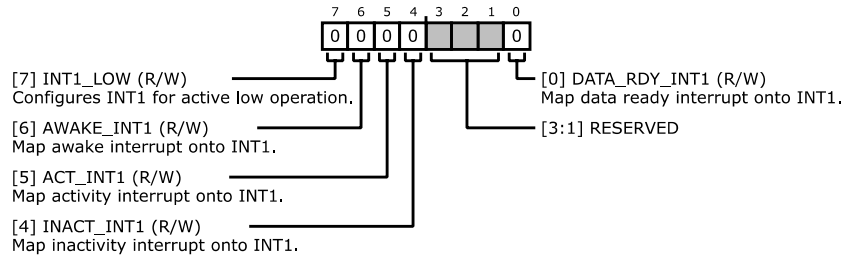

Table 51. Bit Descriptions for INT1_MAP

Bits	Bit Name	Settings	Description	Reset	Access
7	INT1_LOW		Configures INT1 for active low operation.	0x0	R/W
6	AWAKE_INT1		Map awake interrupt onto INT1.	0x0	R/W
5	ACT_INT1		Map activity interrupt onto INT1.	0x0	R/W
4	INACT_INT1		Map inactivity interrupt onto INT1.	0x0	R/W
[3:1]	RESERVED		Reserved.	0x0	R
0	DATA_RDY_INT1		Map data ready interrupt onto INT1.	0x0	R/W

INT2 FUNCTION MAP REGISTER

Address: 0x3C, Reset: 0x00, Name: INT2_MAP

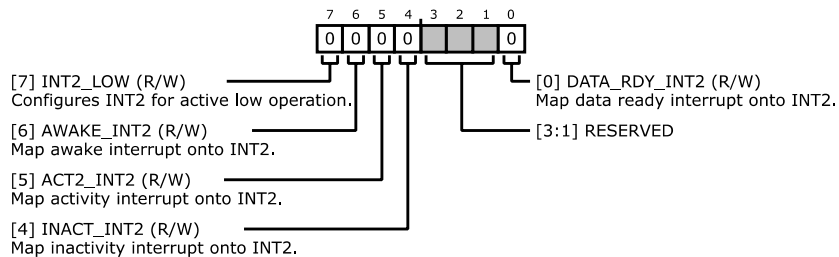

Table 52. Bit Descriptions for INT2_MAP

Bits	Bit Name	Settings	Description	Reset	Access
7	INT2_LOW		Configures INT2 for active low operation.	0x0	R/W
6	AWAKE_INT2		Map awake interrupt onto INT2.	0x0	R/W
5	ACT2_INT2		Map activity interrupt onto INT2.	0x0	R/W
4	INACT_INT2		Map inactivity interrupt onto INT2.	0x0	R/W
[3:1]	RESERVED		Reserved.	0x0	R
0	DATA_RDY_INT2		Map data ready interrupt onto INT2.	0x0	R/W

EXTERNAL TIMING CONTROL REGISTER

Address: 0x3D, Reset: 0x00, Name: TIMING

Use this register to control the ADXL371 timing parameters: ODR and external timing triggers.

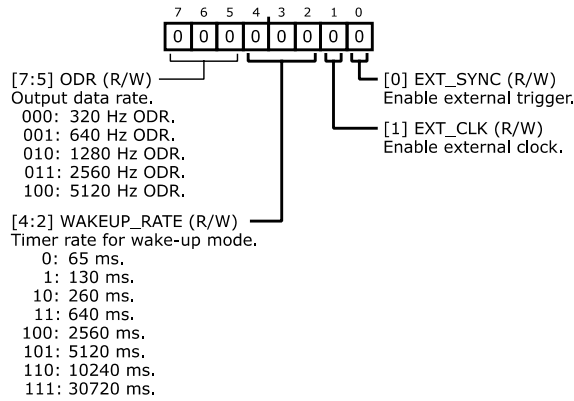

Table 53. Bit Descriptions for TIMING

Bits	Bit Name	Settings	Description	Reset	Access
[7:5]	ODR	000 001 010 011 100	Output data rate. 320 Hz ODR. 640 Hz ODR. 1280 Hz ODR. 2560 Hz ODR. 5120 Hz ODR.	0x0	R/W
[4:2]	WAKEUP_RATE	0 1 10 11 100 101 110 111	Timer rate for wake-up mode. 65 ms. 130 ms. 260 ms. 640 ms. 2560 ms. 5120 ms. 10240 ms. 30720 ms.	0x0	R/W
1	EXT_CLK		Enable external clock.	0x0	R/W
0	EXT_SYNC		Enable external trigger.	0x0	R/W

MEASUREMENT CONTROL REGISTER

Address: 0x3E, Reset: 0x00, Name: MEASURE

Use this register to control several measurement settings.

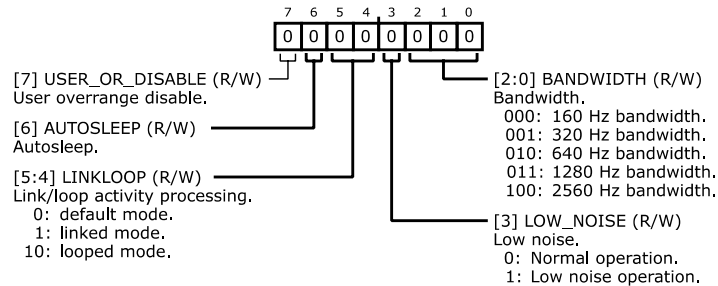

Table 54. Bit Descriptions for MEASURE

Bits	Bit Name	Settings	Description	Reset	Access
7	USER_OR_DISABLE		User overrange disable.	0x0	R/W
6	AUTOSLEEP		Autosleep. When set to 1, autosleep is enabled, and the device enters wake-up mode automatically upon detection of inactivity. Activity and inactivity detection must be in linked mode or loop mode (the LINKLOOP bits in the MEASURE register) to enable autosleep. Otherwise, the bit is ignored.	0x0	R/W
[5:4]	LINKLOOP		Link/loop activity processing. These bits select how activity and inactivity processing are linked. <ul style="list-style-type: none"> 0 Default mode. Activity and inactivity detection, when enabled, operate simultaneously and their interrupts (if mapped) must be acknowledged by the host processor by reading the STATUS register. Autosleep is disabled in this mode. 1 Linked mode. Activity and inactivity detection are linked sequentially so that only one is enabled at a time. Their interrupts (if mapped) must be acknowledged by the host processor by reading the STATUS register. 10 Looped mode. Activity and inactivity detection are linked sequentially so that only one is enabled at a time, and their interrupts are internally acknowledged (do not need to be serviced by the host processor). To use either linked or looped mode, both ACT_x_EN and INACT_x_EN must be set to 1. Otherwise, the default mode is used. For additional information, refer to the Linking Activity and Inactivity Detection section. 	0x0	R/W
3	LOW_NOISE		Low noise. Selects low noise operation. <ul style="list-style-type: none"> 0 Normal operation. Device operates at the normal noise level and ultralow current consumption 1 Low noise operation. Device operates at ~1/3 the normal noise level. 	0x0	R/W
[2:0]	BANDWIDTH		Bandwidth. Select the desired output signal bandwidth. A four-pole low-pass filter at the selected frequency limits the signal bandwidth. <ul style="list-style-type: none"> 000 160 Hz bandwidth. 001 320 Hz bandwidth. 010 640 Hz bandwidth. 011 1280 Hz bandwidth. 100 2560 Hz bandwidth. 	0x0	R/W

POWER CONTROL REGISTER

Address: 0x3F, Reset: 0x00, Name: POWER_CTL

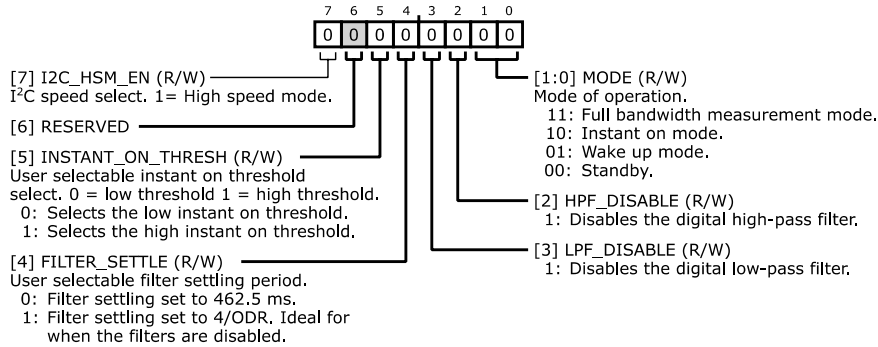

Table 55. Bit Descriptions for POWER_CTL

Bits	Bit Name	Settings	Description	Reset	Access
7	I2C_HSM_EN		I ² C speed select. 1 = High speed mode.	0x0	R/W
6	RESERVED		Reserved.	0x0	R
5	INSTANT_ON_THRESH		User selectable instant on threshold select. 0 = low threshold, 1 = high threshold.	0x0	R/W
		0	Selects the low instant on threshold.		
		1	Selects the high instant on threshold.		
4	FILTER_SETTLE		User selectable filter settling period.	0x0	R/W
		0	Filter settling set to 462.5 ms.		
		1	Filter settling set to 4/ODR. Ideal for when the filters are disabled.		
3	LPF_DISABLE	1	Disables the low-pass filter.	0x0	R/W
2	HPF_DISABLE	1	Disables the digital high-pass filter.	0x0	R/W
[1:0]	MODE		Mode of operation.	0x0	R/W
		11	Full bandwidth measurement mode.		
		10	Instant on mode.		
		01	Wake up mode.		
		00	Standby.		

SELF TEST REGISTER

Address: 0x40, Reset: 0x00, Name: SELF_TEST

Refer to the Self Test section for information on the operation of the self test feature, and see the Self Test Procedure section for guidelines on how to use this functionality.

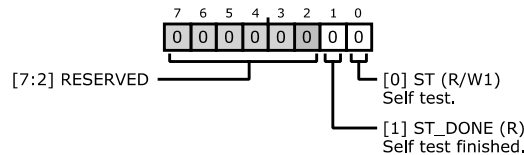
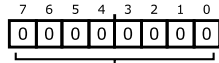

Table 56. Bit Descriptions for SELF_TEST

Bits	Bit Name	Settings	Description	Reset	Access
[7:2]	RESERVED		Reserved.	0x0	R
1	ST_DONE		Self test finished.	0x0	R
0	ST		Self test. Writing a 1 to this bit initiates self test. Writing a 0 clears self test.	0x0	R/W

RESET (CLEARS) REGISTER, PART IN STANDBY MODE

Address: 0x41, Reset: 0x00, Name: RESET



[7:0] RESET (W)
Writing code 0x52 resets the device.

Table 57. Bit Descriptions for RESET

Bits	Bit Name	Settings	Description	Reset	Access
[7:0]	RESET		Writing code 0x52 resets the device.	0x0	W

APPLICATIONS INFORMATION

APPLICATION EXAMPLES

This section includes application circuits highlighting useful features of the ADXL371.

Power Supply Decoupling

Figure 48 shows the recommended bypass capacitors for use with the ADXL371.

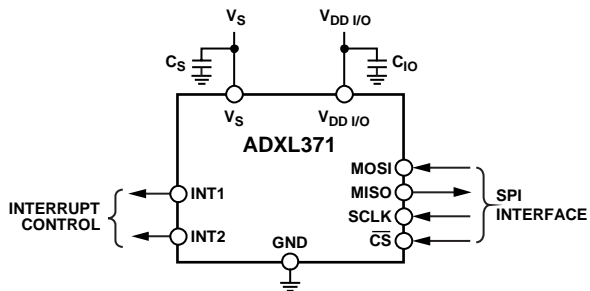

Figure 48. Recommended Bypass Capacitors

A 0.1 μF ceramic capacitor (C_S) at V_S and a 0.1 μF ceramic capacitor (C_{IO}) at $V_{DD I/O}$ placed as close as possible to the ADXL371 supply pins are recommended to adequately decouple the accelerometer from noise on the power supply. It is recommended that V_S and $V_{DD I/O}$ be separate supplies to minimize digital clocking noise on the V_S supply. If separating V_S and $V_{DD I/O}$ is not possible, additional filtering of the supplies may be necessary.

If additional decoupling is necessary, a resistor or ferrite bead, no larger than 100 Ω , in series with V_S , is recommended. Additionally, increasing the bypass capacitance on V_S to a 1 μF tantalum capacitor in parallel with a 0.1 μF ceramic capacitor may also improve noise.

Ensure that the connection from the ADXL371 ground to the power supply ground has low impedance because noise transmitted through ground has an effect similar to noise transmitted through V_S .

Power Supply Requirements

The ADXL371 operates using supply voltage rails ranging from 2.5 V to 3.5 V. The operating voltage range (V_S) specified in Table 1 ranges from 2.5 V to 3.5 V to account for inaccuracies and transients of up to $\pm 10\%$ on the supply voltage.

When power cycling the ADXL371, it is highly recommended to fully discharge the device to ground level ($V_S = 0\text{ V}$) on each power cycle. If this is not possible, care must be taken regarding the following specifications:

- V_S supply start-up threshold
- Hold time
- Rise time

V_S Supply Start-Up Threshold

During start-up or power cycling of the ADXL371, the V_S supply must always be started up from less than 100 mV. When the device is in operation, any time power is removed from the ADXL371 or falls less than 1.6 V, the V_S supply must be discharged lower than 100 mV. The V_S supply start-up threshold specification is a mandatory requirement.

Hold Time

To ensure a successful power-on reset, the V_S supply must be held less than 100 mV for at least 200 ms before reapplying the supply to the device.

Rise Time

For the worst case scenario (a 100 mV V_S at start up and a 200 ms hold time), the V_S supply rise time must be linear and within 250 μs to reach 1.6 V (see Figure 49).

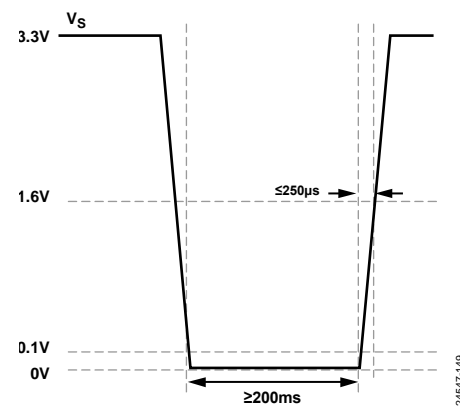

Figure 49. Power Supply Requirements

Notice that fully discharging the power supply to the ground level allows a much more relaxed rise time, $\leq 600\ \mu\text{s}$, from 0 V to 1.6 V for a 200 ms hold time.

To enable supply discharge, it is recommended to power the device from a microcontroller general-purpose input and output (GPIO), connect a shutdown discharge switch to the supply, or use a voltage regulator with a shutdown discharge feature.

Using External Timing Triggers

Figure 50 shows an application diagram for using the INT1 pin as the input for an external clock. In this mode, the external clock determines all accelerometer timing, including the output data rate and bandwidth.

Set the EXT_CLK bit in the TIMING register to enable this feature.

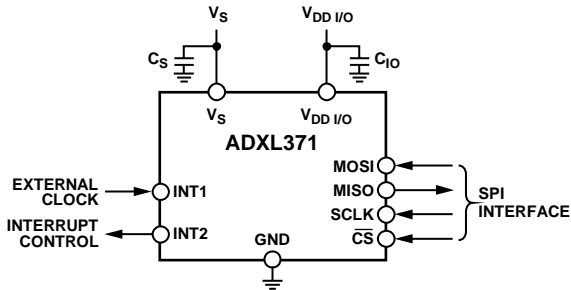

Figure 50. INT1 Pin as Input for External Clock

Figure 51 is an application diagram for using the INT2 pin as a trigger for synchronized sampling. Acceleration samples are produced every time this trigger is activated. Set the EXT_SYNC bit in the TIMING register to enable this feature.

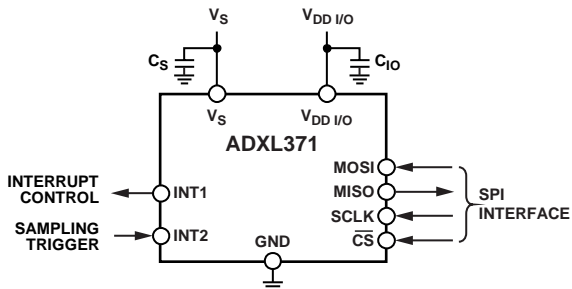

Figure 51. Using the INT2 Pin to Trigger Synchronized Sampling

OPERATION AT VOLTAGES OTHER THAN 3.3 V

The ADXL371 is tested and specified at a supply voltage of $V_S = 3.3$ V. However, it can be powered with a V_S as high as 3.5 V or as low as 2.5 V. Some performance parameters change as the supply voltage changes, including the supply current, noise, offset, and sensitivity.

OPERATION AT TEMPERATURES OTHER THAN AMBIENT

The ADXL371 is tested and specified at an ambient temperature. However, it is rated for temperatures between -40°C and $+105^{\circ}\text{C}$. Some performance parameters change along with temperature, such as offset, sensitivity, clock performance, and current. Some of these temperature variations are characterized in Table 1, and others are shown in the figures within the Typical Performance Characteristics section.

MECHANICAL CONSIDERATIONS FOR MOUNTING

Mount the ADXL371 on the PCB in a location close to a hard mounting point of the PCB to the case. Mounting the ADXL371 at an unsupported PCB location, as shown in Figure 52, can result in large, apparent measurement errors due to undamped PCB vibration. Locating the accelerometer near a hard mounting point ensures that any PCB vibration at the accelerometer is higher than the mechanical sensor resonant frequency of the accelerometer and, therefore, effectively invisible to the accelerometer. Multiple mounting points, close to the sensor, and/or a thicker PCB also help to reduce the effect of system resonance on the performance of the sensor.

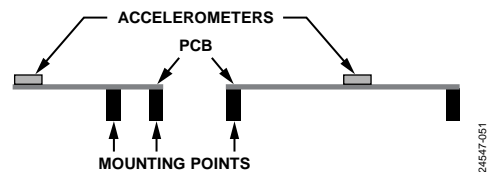

Figure 52. Incorrectly Placed Accelerometers

AXES OF ACCELERATION SENSITIVITY

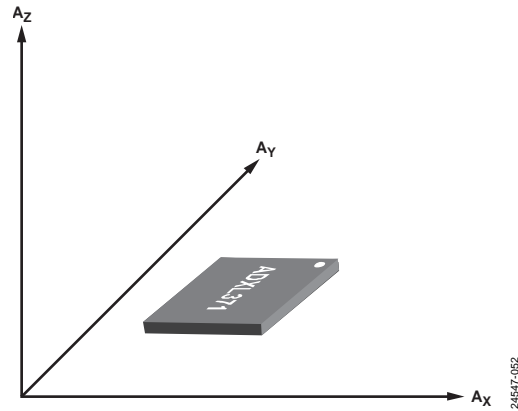

Figure 53. Axes of Acceleration Sensitivity (Corresponding Output Increases when Accelerated Along the Sensitive Axis)

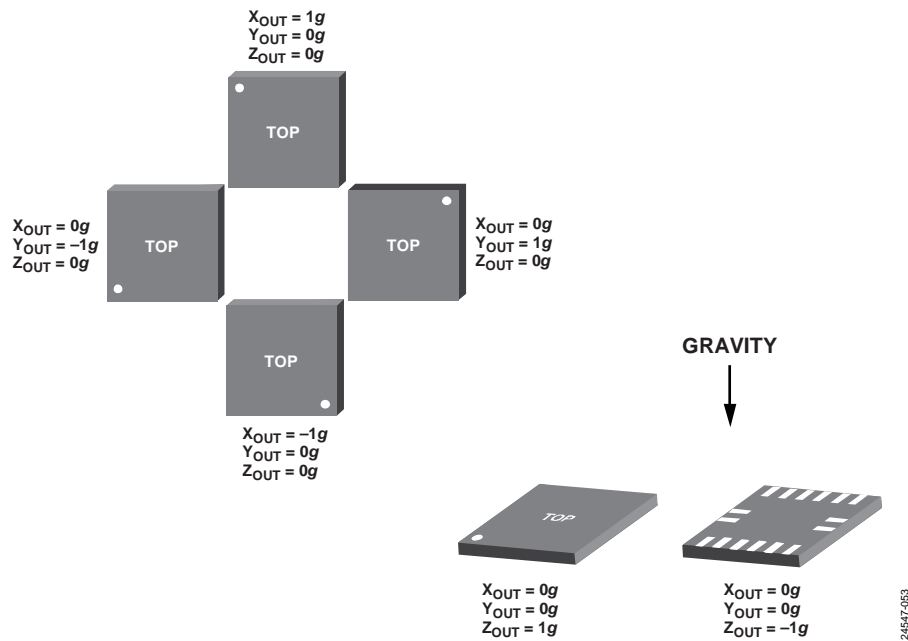

Figure 54. Output Response vs. Orientation to Gravity

LAYOUT AND DESIGN RECOMMENDATIONS

Figure 55 shows the recommended printed wiring board land pattern.

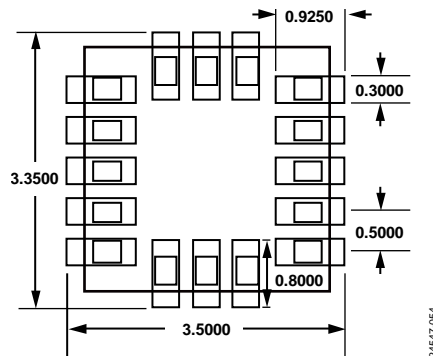

Figure 55. Recommended Printed Wiring Board Land Pattern (Dimensions Shown in Millimeters)

OUTLINE DIMENSIONS

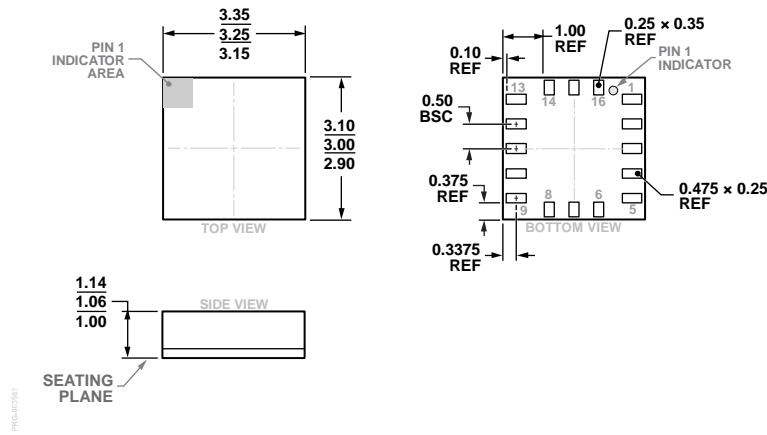

Figure 56. 16-Terminal Land Grid Array [LGA]
(CC-16-4)
Dimensions shown in millimeters

ORDERING GUIDE

Model ¹	Temperature Range	Package Description	Package Option	Quantity
ADXL371BCCZ-RL	-40°C to +105°C	16-Terminal Land Grid Array [LGA]	CC-16-4	5000
ADXL371BCCZ-RL7	-40°C to +105°C	16-Terminal Land Grid Array [LGA]	CC-16-4	1500
EVAL-ADXL371Z		Evaluation Board		

¹ Z = RoHS Compliant Part.

I²C refers to a communications protocol originally developed by Philips Semiconductors (now NXP Semiconductors).