

### FEATURES

- Settling-Time to 12-Bit Accuracy,  $G \leq 2000$  .....  $15\mu\text{s}$  Max
- Overload Recovery Time,  $G = 1000$  .....  $15\mu\text{s}$
- 14-Bit Gain Linearity at  $G \leq 1000$
- On-Board Dual Guard Drivers
- On-Board  $100\mu\text{A}$  Precision Current Source
- Low Bias Current .....  $50\text{pA}$  Max @  $25^\circ\text{C}$   
.....  $20\text{nA}$  Max @  $125^\circ\text{C}$
- Temperature Stable CMR  
.....  $105\text{dB}$  Min Over  $-55^\circ\text{C}$  to  $+125^\circ\text{C}$
- High Slew-Rate with  $500\text{pF}$  Load .....  $5\text{V}/\mu\text{s}$  Min
- Input Overload Protected to  $\pm 30\text{V}$  Differential
- Available in Die Form

### ORDERING INFORMATION†

CERDIP 18-PIN PACKAGE	OPERATING TEMPERATURE RANGE
AMP05AX*	MIL
AMP05BX*	MIL
AMP05EX	IND
AMP05FX	IND

\* For devices processed in total compliance to MIL-STD-883, add /883 after part number. Consult factory for 883 data sheet.

† Burn-in is available on commercial and industrial temperature range parts in CerDIP, plastic DIP, and TO-can packages.

### PIN CONNECTIONS

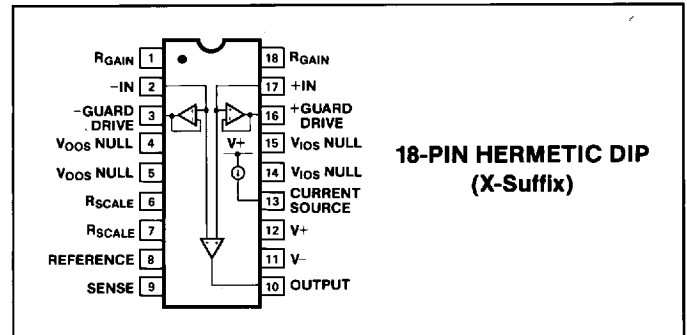

### GENERAL DESCRIPTION

The AMP-05 is a fast JFET instrumentation amplifier designed for high-speed analog signal-processing and analog-multiplexed data acquisition systems. Settling-time to 12-bits is  $15\mu\text{s}$  maximum, with better than 14-bit linearity at all gains up to 1000. Two functions are added to the instrumentation amplifier that reduce external component count in many applications. On-board dual guard drivers maintain good settling-time and common-mode rejection performance when shielded cable connects the input signal to the AMP-05. A precision  $100\mu\text{A}$  current source is also provided for transducer excitation, powering a low-current voltage reference, and other functions.

### SIMPLIFIED SCHEMATIC

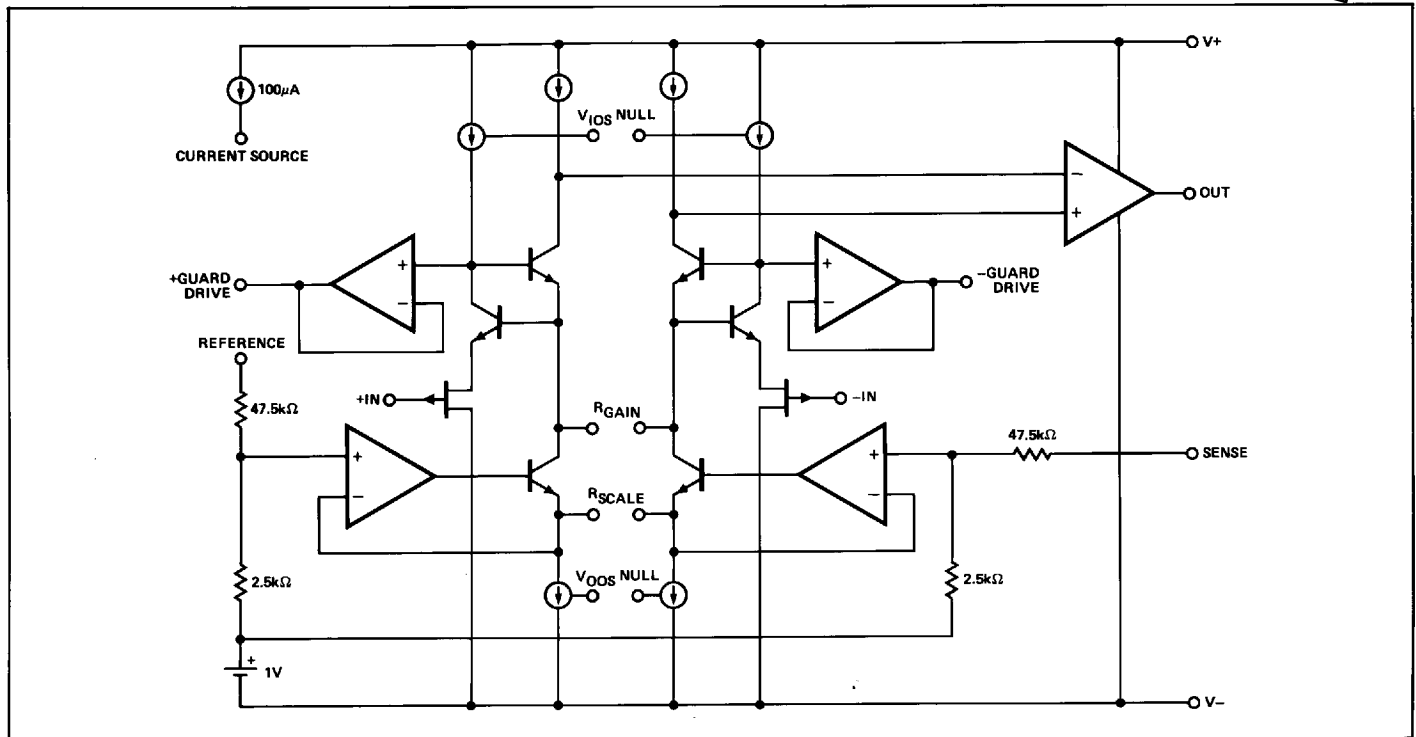

# AMP-05

The AMP-05 employs a current-feedback technique which provides a high and stable common-mode rejection, 105dB minimum over the military temperature range. JFET inputs reduce bias current to 50pA maximum at 25°C and only 20nA maximum at 125°C; low bias current reduces errors due to signal-source resistance. Internal input protection allows a 30V differential overload at all gain settings. The AMP-05 recovers rapidly when an input overload is removed. Recovery time is typically 15µs following a 1000:1 overload, voltage gain set to 1000. AMP-05 voltage gain is set by the ratio of two external resistors over the range 0.1 to 2000 and a low gain temperature-coefficient of 20ppm/°C maximum is achievable in the range 1 to 1000.

The AMP-05's outputs can all drive large capacitive loads without oscillation. The amplifier output is guaranteed stable with loads up to 2,000pF and the guard drivers can tolerate up to 10,000pF without oscillation.

Sense and reference pins complete the output feedback-loop and provide an output ground reference, respectively. The reference pin may be used for zeroing system offsets, where auto-zero hardware is employed. Resistance in series with the reference terminal does not degrade common-mode rejection on PMI's AMP-05, which is a significant problem with instrumentation amplifiers employing the three op-amp configuration.

For applications requiring very low input offset voltage and low offset drift, or higher output drive capability, refer to the AMP-01 data sheet.

## ABSOLUTE MAXIMUM RATINGS (Note 1)

Supply Voltage .....	±18V
Common-Mode Input Voltage .....	Supply Voltage
Differential Input Voltage .....	±30V
(Inputs must not exceed supply voltages.)	
Output Short-Circuit Duration .....	Indefinite
Storage Temperature Range .....	-65°C to +150°C
Operating Temperature Range	
AMP-05A, B .....	-55°C to +125°C
AMP-05E, F .....	-25°C to +85°C
Lead Temperature (Soldering, 60 sec) .....	300°C
Junction Temperature (T <sub>j</sub> ) .....	-65°C to +150°C

PACKAGE TYPE	θ <sub>JA</sub> (Note 2)	θ <sub>JC</sub>	UNITS
18-Pin Hermetic DIP (X)	74	7	°C/W

### NOTES:

1. Absolute ratings apply to both DICE and packaged parts, unless otherwise noted.
2. θ<sub>JA</sub> is specified for worst case mounting conditions, i.e., θ<sub>JA</sub> is specified for device in socket for CerDIP package.

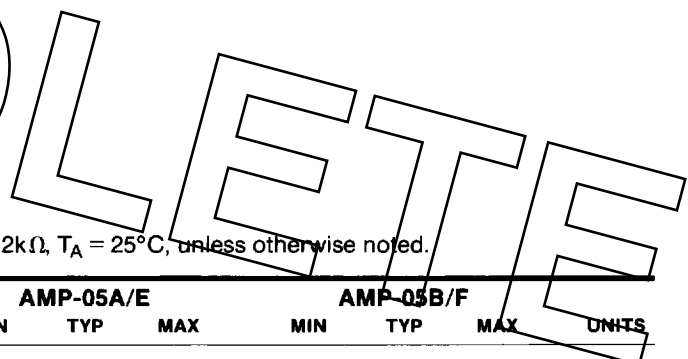

## ELECTRICAL CHARACTERISTICS at V<sub>S</sub> = ±15V, R<sub>S</sub> = 5kΩ, R<sub>L</sub> = 2kΩ, T<sub>A</sub> = 25°C, unless otherwise noted.

PARAMETER	SYMBOL	CONDITIONS	AMP-05A/E			AMP-05B/F			UNITS
			MIN	TYP	MAX	MIN	TYP	MAX	
<b>GAIN</b>									
Gain Range	G <sub>R</sub>		0.1	—	2000	0.1	—	2000	
Gain Equation Accuracy		G = 20 × R <sub>S</sub> /R <sub>G</sub> G = 1 to 1000	—	0.25	0.5	—	0.4	1.0	%
Gain Nonlinearity	G <sub>NL</sub>	G = 1	—	0.001	—	—	0.001	—	%
		G = 10	—	0.002	—	—	0.002	—	
		G = 100	—	0.007	—	—	0.007	—	
		G = 1000	—	0.020	—	—	0.020	—	
Gain Temperature Coefficient	G <sub>TC</sub>	R <sub>L</sub> = 10kΩ							
		G = 100	—	0.004	—	—	0.004	—	%
		G = 1000	—	0.004	—	—	0.004	—	
Gain Temperature Coefficient	G <sub>TC</sub>	G = 1 to 100	—	1.7	10	—	1.7	10	ppm/°C
		G = 1000 (Notes 1, 2)	—	8	20	—	8	20	
<b>OUTPUT RATING</b>									
Output Voltage Swing	V <sub>OUT</sub>	R <sub>L</sub> = 1kΩ	±11	±12	—	±11	±12	—	V
		Over Temperature	±10.5	±12	—	±10.5	±12	—	
Short Circuit Current	I <sub>SC</sub>	Output Shorted to Ground	±20	±35	—	±20	±35	—	mA
Capacitive Load Stability		Full Gain Range No Oscillations	2	10	—	2	10	—	nF

### NOTES:

1. Gain tempco does not include the effects of gain and scale resistor tempco match.
2. Guaranteed but not 100% production tested.

**ELECTRICAL CHARACTERISTICS** at  $V_S = \pm 15V$ ,  $R_S = 5k\Omega$ ,  $R_L = 2k\Omega$ ,  $T_A = 25^\circ C$ , unless otherwise noted. (Continued)

PARAMETER	SYMBOL	CONDITIONS	AMP-05A/E			AMP-05B/F			UNITS	
			MIN	TYP	MAX	MIN	TYP	MAX		
<b>INPUT</b>										
Input Bias Current	$I_B$	$T_A \leq 25^\circ C$	—	20	50	—	30	100	pA	
		$T_A = 85^\circ C$ (E/F Grades)	—	0.5	4	—	1	8	nA	
		$T_A = 125^\circ C$ (A/B Grades)	—	7	20	—	12	30	nA	
Input Offset Current	$I_{OS}$	$T_A \leq 25^\circ C$	—	5	25	—	10	50	pA	
		$T_A = 85^\circ C$ (E/F Grades)	—	0.05	0.5	—	0.1	1	nA	
		$T_A = 125^\circ C$ (A/B Grades)	—	1	5	—	2	10	nA	
Input Resistance	$R_{IN}$		—	$10^{12}$	—	—	$10^{12}$	—	$\Omega$	
Input Capacitance	$C_{IN}$		—	8	—	—	8	—	pF	
Input Voltage Range	IVR	$T_A = 25^\circ C$	$\pm 11$	$\pm 11.5$	—	$\pm 11$	$\pm 11.5$	—	V	
		Over Temperature	$\pm 10$	$\pm 11$	—	$\pm 10$	$\pm 11$	—		
Common Mode Rejection	CMR	$V_{CM} = \pm 11V$								
		$G = 1000$	110	115	—	100	110	—	dB	
		$G = 100$	105	115	—	95	110	—		
		$G = 10$	100	110	—	90	100	—		
		$G = 1$	90	98	—	80	90	—		
		$V_{CM} = \pm 10V$ , Over Temperature								
		$G = 1000$	105	110	—	95	105	—	dB	
		$G = 100$	100	110	—	90	105	—		
$G = 10$	95	105	—	85	95	—				
$G = 1$	85	95	—	75	85	—				
<b>OFFSET VOLTAGE</b>										
Input Offset Voltage	$V_{IOS}$	$V_{CM} = 0V$	—	0.3	1.0	—	0.5	2.0	mV	
		$T_A = 25^\circ C$ Over Temperature	—	0.8	2.0	—	1.0	4.0		
Input Offset Voltage Drift	$TCV_{IOS}$		—	5	10	—	7	20	$\mu V/^\circ C$	
Output Offset Voltage	$V_{OOS}$	$T_A = 25^\circ C$	—	3	15	—	5	25	mV	
		Over Temperature	—	9	25	—	11	40		
Output Offset Voltage Drift	$TCV_{OOS}$		—	50	100	—	70	150	$\mu V/^\circ C$	
Offset Referred to Input vs. Positive Supply $V_+ = +5V$ to $+15V$	+PSR	$G = 1000$	115	120	—	110	115	—	dB	
		$G = 100$	110	118	—	105	110	—		
		$G = 10$	95	105	—	90	100	—		
		$G = 1$	75	85	—	70	80	—		
		Over Temperature								
		$G = 1000$	110	116	—	105	110	—	dB	
		$G = 100$	105	114	—	100	105	—		
		$G = 10$	90	102	—	85	98	—		
$G = 1$	75	84	—	70	80	—				
Offset Referred to Input vs. Negative Supply $V_- = -5V$ to $-15V$	-PSR	$G = 1000$	110	118	—	105	110	—	dB	
		$G = 100$	95	104	—	90	98	—		
		$G = 10$	75	84	—	70	80	—		
		$G = 1$	55	64	—	50	60	—		
		Over Temperature								
		$G = 1000$	105	113	—	100	105	—	dB	
		$G = 100$	95	104	—	90	95	—		
		$G = 10$	75	84	—	70	80	—		
$G = 1$	55	64	—	50	60	—				

# AMP-05

**ELECTRICAL CHARACTERISTICS** at  $V_S = \pm 15V$ ,  $R_S = 5k\Omega$ ,  $R_L = 2k\Omega$ ,  $T_A = 25^\circ C$ , unless otherwise noted. (Continued)

PARAMETER	SYMBOL	CONDITIONS	AMP-05A/E			AMP-05B/F			UNITS	
			MIN	TYP	MAX	MIN	TYP	MAX		
Input Offset Voltage Trim Range		$V_S = \pm 4.5V$ to $\pm 18V$	$\pm 2.5$	$\pm 5$	—	$\pm 2.5$	$\pm 5$	—	mV	
Output Offset Voltage Trim Range		$V_S = \pm 4.5V$ to $\pm 18V$	$\pm 25$	$\pm 40$	—	$\pm 25$	$\pm 40$	—	mV	
<b>SENSE INPUT</b>										
Input Resistance	$R_{IN}$		40	50	60	40	50	60	k $\Omega$	
Input Current	$I_{IN}$	Referenced to V-	—	280	—	—	280	—	$\mu A$	
<b>REFERENCE INPUT</b>										
Input Resistance	$R_{IN}$		40	50	60	40	50	60	k $\Omega$	
Input Current	$I_{IN}$	Referenced to V-	—	280	—	—	280	—	$\mu A$	
Voltage Range			-10.5	—	+20	-10.5	—	+20	V	
Gain to Output			—	1	—	—	1	—	V/V	
<b>NOISE</b>										
Voltage Density RTI	$e_n$	$f_o = 1kHz$ $G \geq 100$ $G = 10$ $G = 1$	—	—	—	—	—	—	—	nV/ $\sqrt{Hz}$
Noise Current Density	$i_n$	$f_o = 1kHz$	—	—	—	—	—	—	—	fA/ $\sqrt{Hz}$
Input Noise Voltage	$e_{np-p}$	Measured at $G = 1000$ , 0.1Hz to 10Hz Bandwidth	—	4	—	—	4	—	—	$\mu V_{p-p}$
Output Noise Voltage	$e_{np-p}$	Measured at $G = 0$ , 0.1Hz to 10Hz Bandwidth	—	7	—	—	7	—	—	$\mu V_{p-p}$
Input Noise Current	$i_{np-p}$	0.1Hz to 10Hz Bandwidth	—	0.12	—	—	0.12	—	—	pA $_{p-p}$
<b>DYNAMIC RESPONSE</b>										
Small Signal Bandwidth (-3dB)	BW	$G = 1$ $G \geq 10$	—	3	—	—	3	—	—	MHz kHz
Slew Rate	SR	$C_L = 500pF$ $G \geq 10$ Over Temperature	5 3.5	7.5 5.5	—	5 3.5	7.5 5.5	—	—	V/ $\mu s$
Settling Time	$t_s$	$1 \leq G \leq 2000$ -10V to +10V Step (Note 1) to 0.1% to 0.05% to 0.025%	—	5 7 10	7 10 15	—	5 7 10	7 10 15	—	$\mu s$
Overload Recovery Time	$t_{rec}$	$G = 1000$ $V_{IN} = 10V$ to 10mV	—	15	—	—	15	—	—	$\mu s$

**NOTE:**

1. Guaranteed but not 100% production tested.

ELECTRICAL CHARACTERISTICS at  $V_S = \pm 15V$ ,  $R_S = 5k\Omega$ ,  $R_L = 2k\Omega$ ,  $T_A = 25^\circ C$ , unless otherwise noted. (Continued)

PARAMETER	SYMBOL	CONDITIONS	AMP-05A/E			AMP-05B/F			UNITS
			MIN	TYP	MAX	MIN	TYP	MAX	
<b>GUARD DRIVERS</b>									
Output Voltage	$V_O$	Volts above respective input over temperature.	0.5	1.2	2.0	0.5	1.2	2.0	V
Peak Output Current			8	15	—	8	15	—	mA
Slew Rate	SR	$C_L = 1000pF$	—	16	—	—	16	—	V/ $\mu s$
Capacitive Load Stability		No Oscillations (Note 1)	10	100	—	10	100	—	nF
<b>CURRENT SOURCE</b>									
Current Output	$I_{OUT}$	Over Full Compliance Range	90	100	120	90	100	120	$\mu A$
Output Compliance Range		$V_{OC}$ Volts Below $V+$ (Irrespective of $V-$ )	4	—	30	4	—	30	V
Output Impedance	$R_{OUT}$	Over Full Compliance Range (Note 1)	1	3	—	1	3	—	G $\Omega$
Temperature Coefficient			—	100	—	—	100	—	ppm/ $^\circ C$
Power Supply Rejection			—	150	—	—	150	—	nA/V
<b>POWER SUPPLY</b> $-25^\circ C \leq T_A \leq +135^\circ C$ for E/F Grades, $-55^\circ C \leq T_A \leq +125^\circ C$ for A/B Grades									
Supply Voltage Range	$V_S$		$\pm 4.5$	—	$\pm 18$	$\pm 4.5$	—	$\pm 18$	V
Quiescent Current	$I_Q$		—	7.0	9.0	—	7.5	10.0	mA

**NOTE:**

1. Guaranteed but not 100% production tested.

# AMP-05

## DICE CHARACTERISTICS

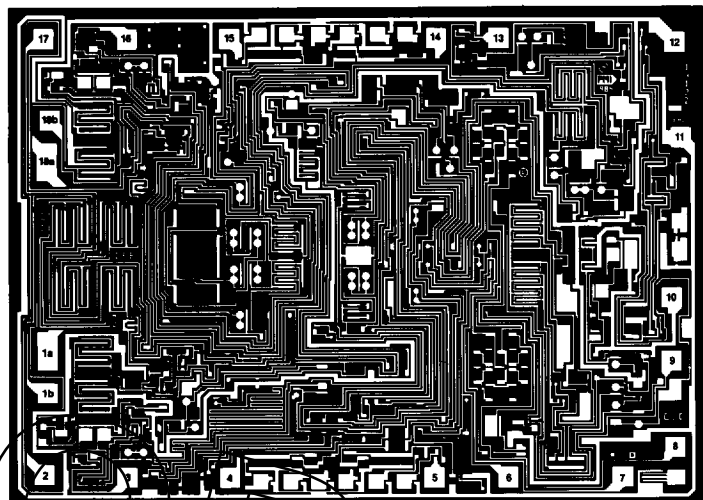

DIE SIZE 0.127 × 0.176 inch, 22,352 sq. mils  
(3.23 × 4.47mm, 14.42 sq. mm)

- |                              |                               |
|------------------------------|-------------------------------|
| 1a. R <sub>GA</sub> IN SENSE | 10. OUTPUT                    |
| 1b. R <sub>GA</sub> IN FORCE | 11. V <sub>-</sub>            |
| 2. -INPUT                    | 12. V <sub>+</sub>            |
| 3. -GUARD DRIVE              | 13. CURRENT SOURCE            |
| 4. V <sub>OO</sub> S NULL    | 14. V <sub>IO</sub> S NULL    |
| 5. V <sub>OO</sub> S NULL    | 15. V <sub>IO</sub> S NULL    |
| 6. R <sub>SC</sub> ALE       | 16. +GUARD DRIVE              |
| 7. R <sub>SC</sub> ALE       | 17. +INPUT                    |
| 8. REFERENCE                 | 18a. R <sub>GA</sub> IN SENSE |
| 9. SENSE                     | 18b. R <sub>GA</sub> IN FORCE |

WAFER TEST LIMITS at V<sub>S</sub> = ±15V, R<sub>S</sub> = 5kΩ, R<sub>L</sub> = 2kΩ, T<sub>A</sub> = 25°C, unless otherwise noted.

PARAMETER	SYMBOL	CONDITIONS	AMP-05GBC LIMIT	UNITS
Input Offset Voltage	V <sub>IO</sub> S	V <sub>CM</sub> = 0	2.0	mV MAX
Output Offset Voltage	V <sub>OO</sub> S		25	mV MAX
Offset Referred to Input vs. Positive Supply	PSR	V <sub>+</sub> = +5V to +15V	110	dB MIN
		G = 1000	105	
		G = 100	90	
		G = 10	70	
		G = 1	70	
Offset Referred to Input vs. Negative Supply	PSR	V <sub>-</sub> = -5V to -15V	105	dB MIN
		G = 1000	90	
		G = 100	70	
		G = 10	70	
		G = 1	50	
Input Bias Current	I <sub>B</sub>		100	pA MAX
Input Offset Current	I <sub>OS</sub>		50	pA MAX
Input Voltage Range	IVR	Guaranteed by CMR Tests	±11	V MIN
Common-Mode Rejection	CMR	V <sub>CM</sub> = ±11V	100	dB MIN
		G = 1000	95	
		G = 100	90	
		G = 10	80	
		G = 1	80	
Gain Equation Accuracy		G = 20 × R <sub>S</sub> /R <sub>G</sub> G = 1 to 100	1.0	% MAX
Output Voltage Swing	V <sub>OUT</sub>	R <sub>L</sub> = 1kΩ	±11	V MIN
Output-Current Limit		Output-to-Ground Short	±20	mA MIN
Current Source	I <sub>OUT</sub>		90	μA MIN
			120	μA MAX
Quiescent Current	I <sub>Q</sub>		±10.0	mA MAX

### NOTE:

Electrical tests are performed at wafer probe to the limits shown. Due to variations in assembly methods and normal yield loss, yield after packaging is not guaranteed for standard product dice. Consult factory to negotiate specifications based on dice lot qualification through sample lot assembly and testing.

**TYPICAL ELECTRICAL CHARACTERISTICS** at  $V_S = \pm 15V$ ,  $R_S = 5k\Omega$ ,  $R_L = 2k\Omega$ ,  $T_A = 25^\circ C$ , unless otherwise noted.

PARAMETER	SYMBOL	CONDITIONS	AMP-05GBC	
			TYPICAL	UNITS
Input Offset Voltage Drift	$TCV_{IOS}$		7	$\mu V/^\circ C$
Output Offset Voltage Drift	$TCV_{OOS}$	$R_G = \infty$	70	$\mu V/^\circ C$
Nonlinearity		$G = 1000$ $R_L = 10k\Omega$	0.004	%
Voltage Noise Density	$e_n$	$G = 1000$ $f_O = 1kHz$	16	$nV/\sqrt{Hz}$
Current Noise Density	$i_n$	$G = 1000$ $f_O = 1kHz$	10	$fA/\sqrt{Hz}$
Voltage Noise	$e_{np-p}$	$G = 1000$ 0.1Hz to 10Hz	4	$\mu V_{p-p}$
Current Noise	$i_{np-p}$	$G = 1000$ 0.1Hz to 10Hz	0.12	$pA_{p-p}$
Small-Signal Bandwidth (-3dB)	BW	$G = 1000$	120	kHz
Slew Rate	SR	$G = 10$	7.5	$V/\mu s$
Settling Time	$t_s$	To 0.025% -10V to +10V Step $1 \leq G \leq 2000$	10	$\mu s$
Overload Recovery Time	$t_{rec}$	$G = 1000$ $V_{IN} = 10V$ to $10mV$	15	$\mu s$

B  
S  
S  
O  
L  
E  
T  
E

## TYPICAL PERFORMANCE CHARACTERISTICS

**INPUT OFFSET VOLTAGE vs TEMPERATURE**

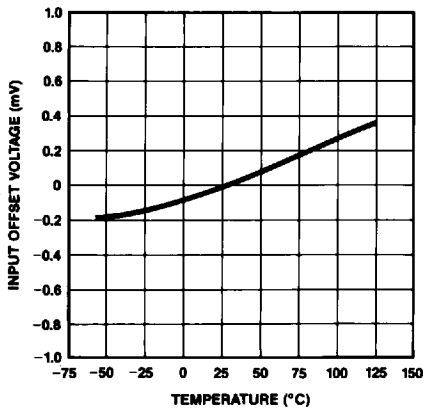

**INPUT OFFSET VOLTAGE vs SUPPLY VOLTAGE**

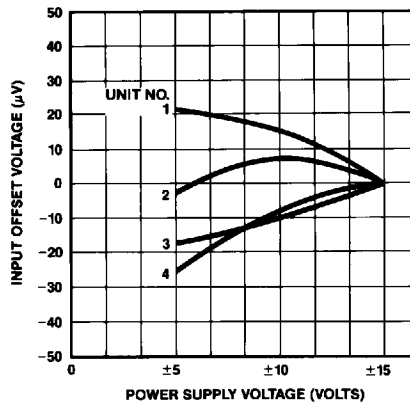

**INPUT OFFSET VOLTAGE WARM-UP DRIFT**

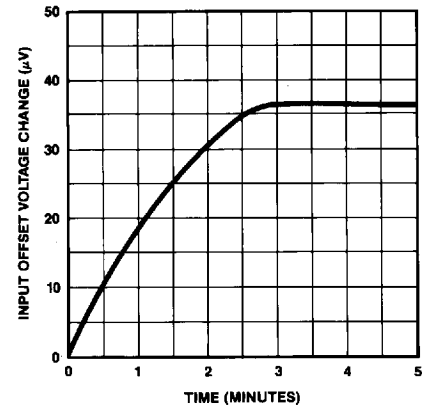

# AMP-05

## TYPICAL PERFORMANCE CHARACTERISTICS

**OUTPUT OFFSET VOLTAGE vs TEMPERATURE**

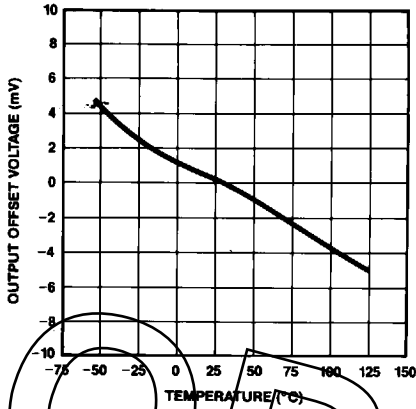

**OUTPUT OFFSET VOLTAGE vs SUPPLY VOLTAGE**

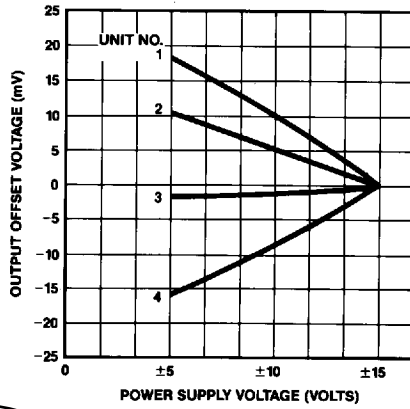

**OUTPUT OFFSET VOLTAGE WARM-UP DRIFT**

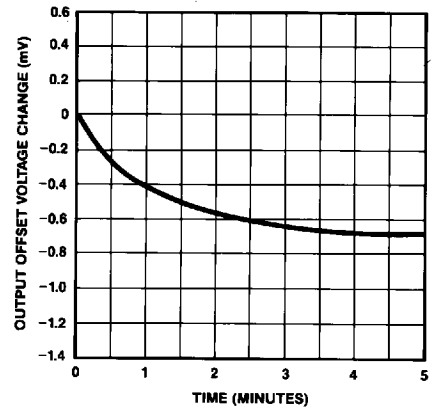

**INPUT BIAS CURRENT vs TEMPERATURE**

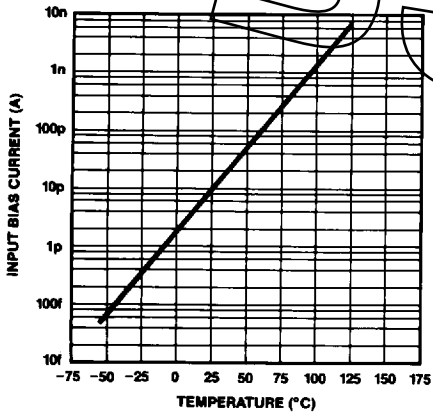

**COMMON-MODE REJECTION vs VOLTAGE GAIN**

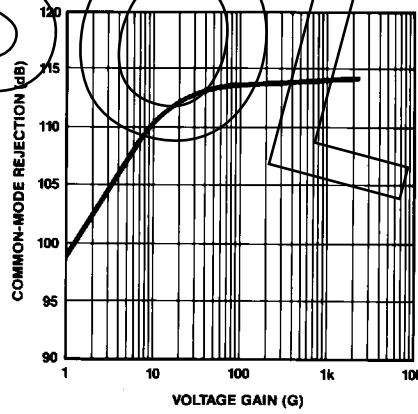

**COMMON-MODE REJECTION vs FREQUENCY**

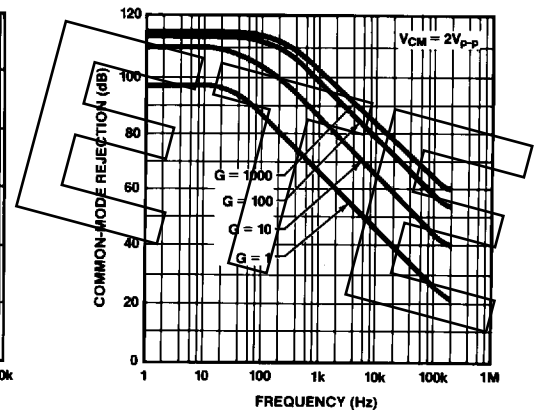

**POSITIVE PSR vs FREQUENCY**

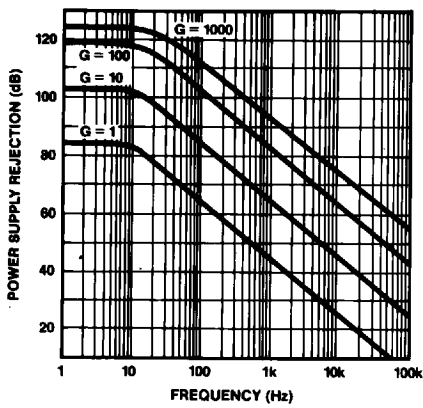

**NEGATIVE PSR vs FREQUENCY**

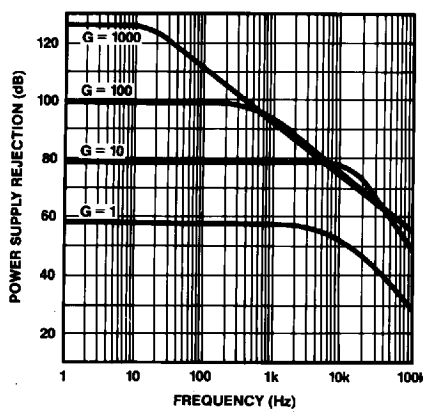

**MAXIMUM POSITIVE OUTPUT VOLTAGE vs LOAD RESISTANCE**

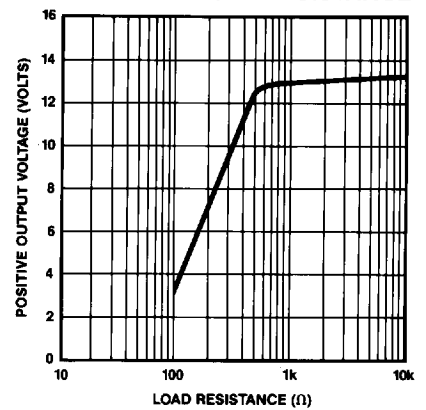



TYPICAL PERFORMANCE CHARACTERISTICS

MAXIMUM NEGATIVE OUTPUT VOLTAGE vs LOAD RESISTANCE

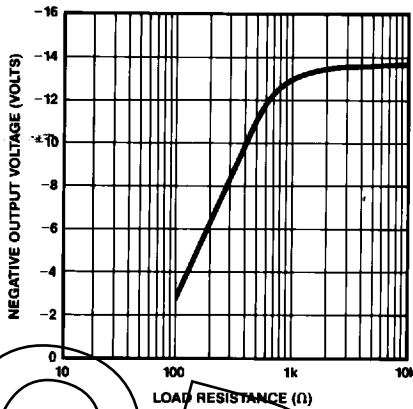

MAXIMUM OUTPUT SWING vs FREQUENCY

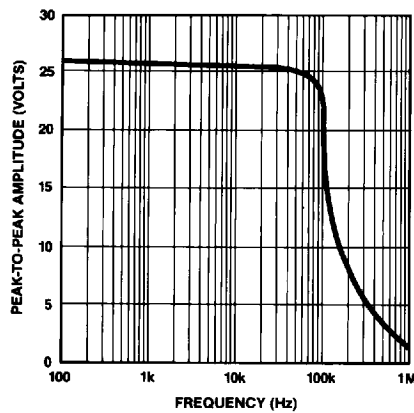

CLOSED-LOOP OUTPUT IMPEDANCE vs FREQUENCY

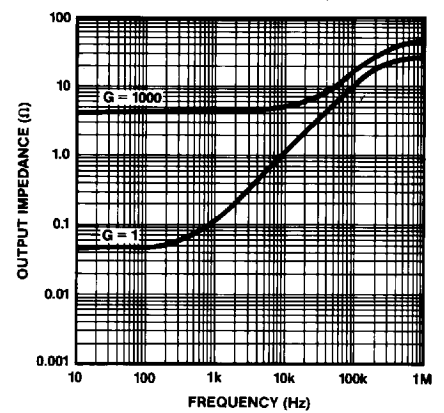

VOLTAGE GAIN vs FREQUENCY

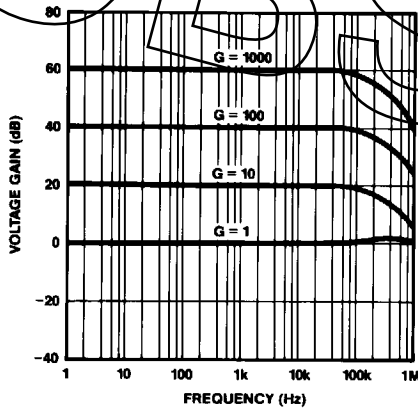

OUTPUT SLEW-RATE vs VOLTAGE GAIN

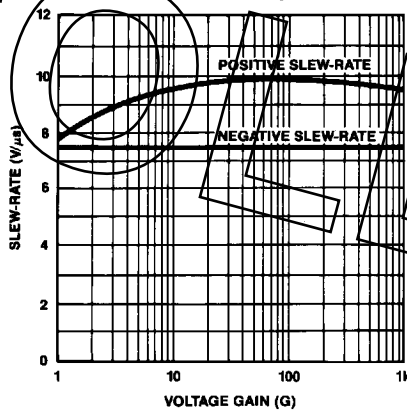

OUTPUT SLEW-RATE vs LOAD CAPACITANCE

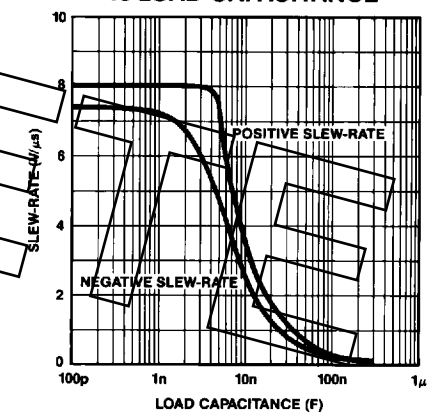

SETTLING-TIME TO 0.025% vs VOLTAGE GAIN

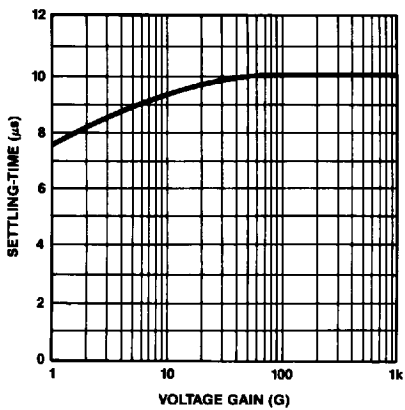

VOLTAGE NOISE DENSITY vs FREQUENCY

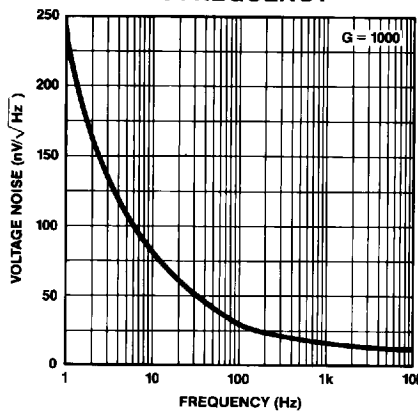

VOLTAGE NOISE DENSITY vs GAIN

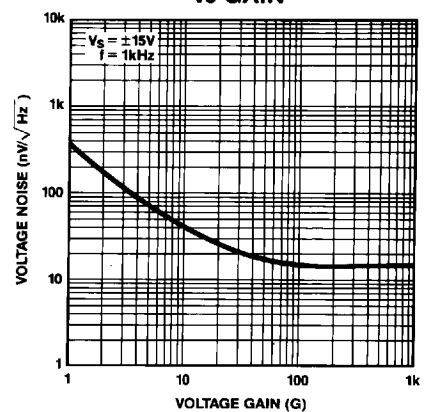

# AMP-05

## TYPICAL PERFORMANCE CHARACTERISTICS

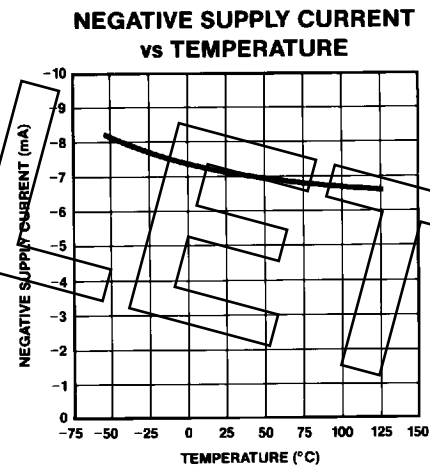
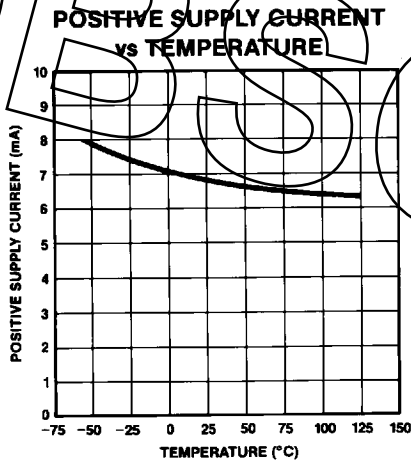
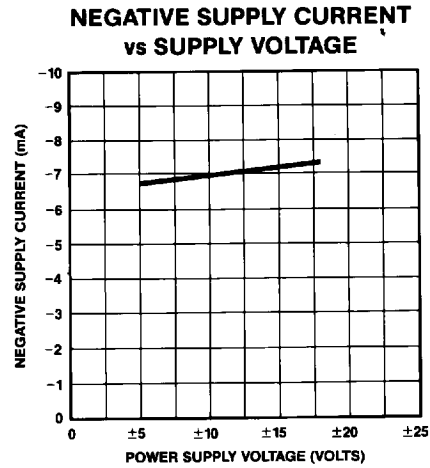
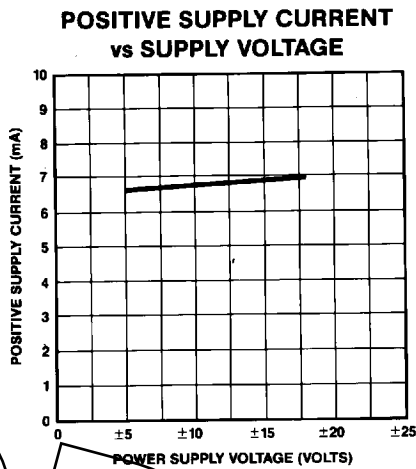

## APPLICATIONS INFORMATION

### VOLTAGE GAIN

The AMP-05 uses two external resistors for setting voltage gain over the range 0.1 to 2000. The magnitudes of the scale resistor,  $R_S$ , and gain-set resistor,  $R_G$ , are related by the formula:  $G = 20 \times R_S / R_G$ , where  $G$  is the selected voltage gain. Figure 1 shows the amplifier connections.  $R_G$  can be selected using the graph in Figure 2.

Circuit performance is characterized using  $R_S = 5k\Omega$  operating on  $\pm 15$  volt supplies and driving a  $\pm 10$  volt output.

Metal-film or wirewound resistors are recommended for  $R_S$  and  $R_G$ . The absolute resistance values and temperature coefficients of resistance are not too important; only the ratio-metric parameters are important for gain accuracy and stability.

**FIGURE 1: Basic AMP-05 Connections For Gains 0.1 to 2000**

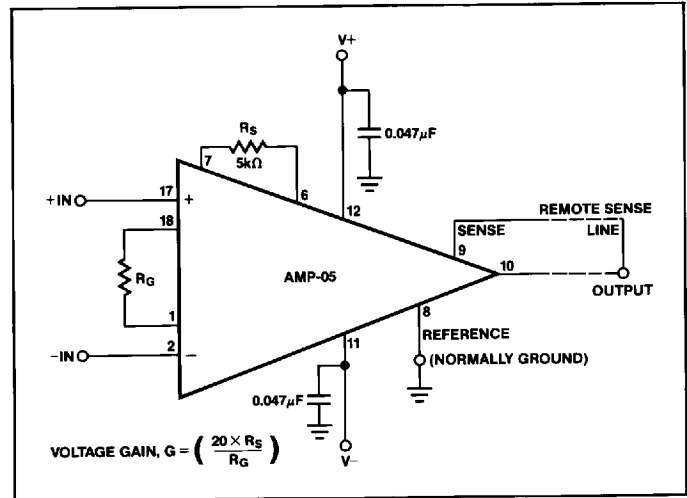
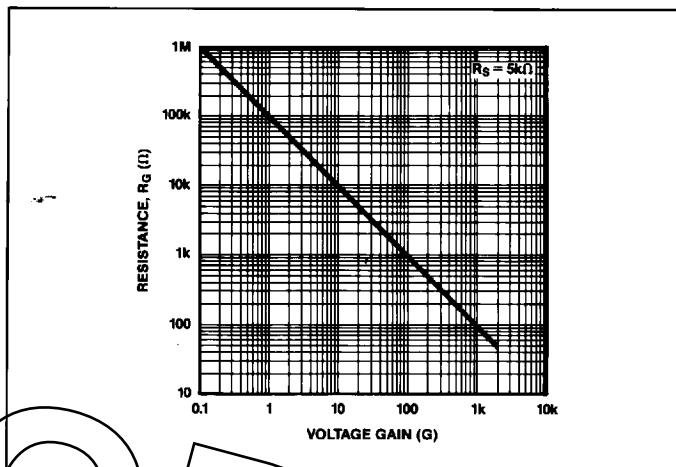

FIGURE 2: Selection of R<sub>GAIN</sub>



AC amplifiers require good gain stability with temperature and time, but DC performance is unimportant. Therefore, low cost metal-film types with TCs of 50ppm/°C are usually adequate for R<sub>S</sub> and R<sub>G</sub>. Realizing the full potential of the AMP-05's gain stability requires precision metal-film or wirewound resistors. Achieving a 25ppm/°C max. gain tempco at all gains will require R<sub>S</sub> and R<sub>G</sub> temperature coefficient matching to 5ppm/°C max.

Gain accuracy is determined by the ratio accuracy of R<sub>S</sub> and R<sub>G</sub> combined with the gain equation error of the AMP-05 (0.5% for A/E grades).

**Note:** The AMP-05 is inherently stable at all gains. However, like all amplifiers with a high gain-bandwidth product, instability can occur if layout precautions are not observed: (a) the amplifier should be decoupled close to the supply pins, and (b) the output must be kept well away from the inputs, the null pins, and R<sub>GAIN</sub>.

The AMP-05 is capable of gain-bandwidth products in the hundreds of megahertz when operated at its highest gain settings. Under these conditions, even a few picofarads of stray feedback to the inputs can cause instability, and the situation is exacerbated if the input signal has a high source impedance. If instability does occur, the problem is easily eliminated by placing a small capacitor directly between the AMP-05's input pins, 2 and 17.

**INPUT AND OUTPUT OFFSET VOLTAGES**

Instrumentation amplifiers have independent offset voltages associated with the input and output stages. While the initial offsets may be adjusted to zero, temperature variations will cause shifts in offsets. Systems with auto-zero can correct for offset errors, so initial adjustment would be unnecessary. However, many high-gain applications do not have auto-zero. For these applications both offsets can be nulled. Nulling has minimal effect on TCV<sub>IOS</sub> and TCV<sub>OOS</sub> (refer to Figure 3 for connections).

FIGURE 3: Input and Output Offset Voltage Nulling

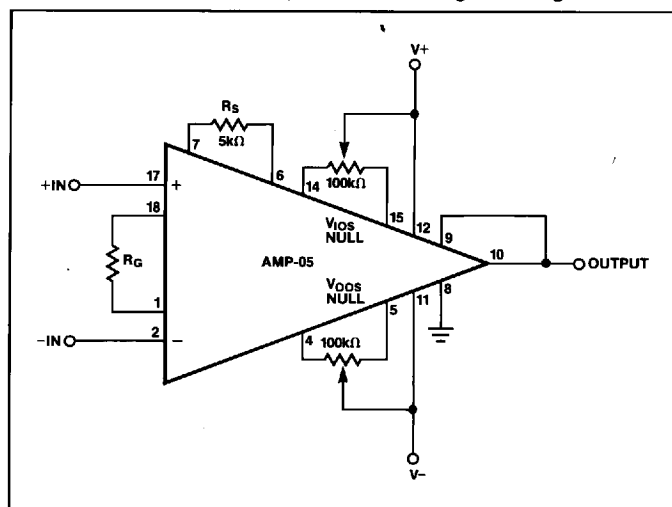

The input offset component is directly multiplied by the amplifier gain, whereas output offset is independent of gain. Therefore, at low gain, output offset errors dominate, while at high gain, input offset errors dominate. Overall offset voltage, V<sub>OS</sub>, referred to the output (RTO) is calculated as follows:

$$V_{OS} (RTO) = V_{IOS} \times G + V_{OOS} \dots \dots \dots (1)$$

where V<sub>IOS</sub> and V<sub>OOS</sub> are the input and the output offset voltage specifications and G is the amplifier gain. Input offset nulling alone can be used for fixed gains above 50. Otherwise, both nulls are required. When nulling both initial offsets, the input offset is nulled first by short-circuiting R<sub>G</sub>, then the output offset is nulled with the short removed.

The overall offset voltage drift, TCV<sub>OOS</sub>, referred to the output, is a combination of input and output drift specifications. Input offset voltage drift is multiplied by the amplifier gain, G, and summed with the output offset drift;

$$TCV_{OS} (RTO) = (TCV_{IOS} \times G) + TCV_{OOS} \dots \dots \dots (2)$$

where TCV<sub>IOS</sub> is the input offset voltage drift, and TCV<sub>OOS</sub> is the output offset voltage drift specification. Frequently, the amplifier drift is referred back to the input (RTI) which is then equivalent to an input signal change;

$$TCV_{OS} (RTI) = TCV_{IOS} + \frac{TCV_{OOS}}{G} \dots \dots \dots (3)$$

For example, the maximum input-referred drift of an AMP-05EX set to G = 100 becomes:

$$TCV_{OS} (RTI) = 10\mu V/^{\circ}C + \frac{100\mu V/^{\circ}C}{100} = 11\mu V/^{\circ}C \text{ max.}$$

# AMP-05

## INPUT BIAS AND OFFSET CURRENTS

Input bias currents are additional error sources which can degrade the input signal. Bias currents flowing through the signal source resistance appear as an additional offset voltage. Equal source resistance on both inputs of an instrumentation amplifier will minimize offset changes due to bias current variations with signal voltage and temperature. However, the difference between the two bias currents, the input offset current, produces a nontrimmable error. The magnitude of the error is the offset current times the source resistance.

The AMP-05 has FET inputs which have negligible bias and offset currents at room temperature and consequently can accurately measure signals from high source impedances. However, like all FET devices, the bias current doubles approximately every 10°C increase in junction temperature and therefore bias and offset currents must be carefully considered when operating up to +125°C.

**Note:** If very high source impedances (~1MΩ) are used and the AMP-05 is used at high gain, then it is recommended that a small capacitor is connected across the inputs to prevent instability.

A current path must always be provided between the differential inputs and analog ground to ensure correct amplifier operation. Floating inputs, such as thermocouples, should be grounded close to the signal source for best common-mode rejection.

## OVERVOLTAGE PROTECTION

The AMP-05 features a unique internal protection circuit which permits differential input voltages of up to ±30V even when set for high gain operation. It should be noted however, that the output state during such an overload is not defined. Typically, at gains above 10, severe overloads (=1000% overrange) will cause the output to sit at about +10V with a low-level oscillation apparent.

Additionally, gross overdriving will cause input currents of up to 100μA to flow in the lower of the two inputs. The increased input current should be borne in mind if interfacing to extremely delicate transducers.

## OVERLOAD RECOVERY TIME

Following an input overload, an amplifier takes a finite time to recover, i.e. the amplifier's output has to return to the linear operating region after limiting at one or other supply. The AMP-05 is designed to recover rapidly from input overloads; typically recovery time is 15μs following a 1000:1 overload; voltage gain set to 1000.

Rapid overload recovery is particularly important in a multiplexed data acquisition system using programmable gain. In this application, it is possible for the input to be switched to a high-level signal with gain set high, thus overloading the amplifier. To maintain system speed, it is vital for the amplifier to recover quickly once the overload is removed by reprogramming the gain.

## COMMON-MODE REJECTION

Ideally, an instrumentation amplifier responds only to the difference between the two input signals and rejects common-mode voltages and noise. In practice, there is a small change in output voltage when both inputs experience the same common-mode voltage change; the ratio of these voltages is called the common-mode gain. Common-mode rejection (CMR) is the logarithm of the ratio of differential-mode gain to common-mode gain, expressed in dB. CMR specifications are normally measured with a full-range input voltage change and a specified source resistance unbalance.

The current-feedback design used in the AMP-05 inherently yields high common-mode rejection. Unlike resistive feedback designs typified by the three-op-amp IA, the CMR is not degraded by small resistances in series with the reference input. A slight, but trimmable, output offset voltage change results from resistance in series with the reference input.

The common-mode input voltage range, CMVR, for linear operation may be calculated from the formula:

$$CMVR = \pm \left( IVR - \frac{|V_{out}|}{2G} \right) \dots \dots \dots (4)$$

IVR is the data sheet specification for input voltage range;  $V_{out}$  is the maximum output signal; and G is the chosen voltage gain. For example, at 25°C, IVR is specified as ±11 volts minimum with ±15 volt supplies. Using a ±10 volt maximum swing output and substituting the figures in (4) simplifies the formula to:

$$CMVR = \pm \left( 11 - \frac{5}{G} \right) \dots \dots \dots (5)$$

For all gains greater than or equal to 5, CMVR is ±10 volt minimum; at gains below 5, CMVR is reduced.

## GUARD DRIVERS

Dual guard drivers are included to restore bandwidth, settling-time, and high frequency common-mode rejection (CMR) when shielded cable is used at the input. The guard drivers can handle large capacitive loads and transient currents, but they are not intended for large DC loads. The DC path to ground should be  $30k\Omega$  or greater; lower values can upset the AMP-05's internal biasing circuits.

Shielded cable is often employed to minimize capacitively coupled noise pickup along the signal path from source to amplifier. When coaxial cable connects a transducer to the amplifier's input, the cable's capacitance interacts with the transducer's source impedance to form a low-pass filter. This filter function reduces the amplifier's bandwidth and degrades settling-time and CMR. The AMP-05's differential guard drivers act as an AC "bootstrap" when attached to the coaxial shields. In bootstrapping, each driver follows its corresponding input, and the driver output signals are buffered to handle large capacitive loads. Each driver will typically slew at  $16V/\mu s$  with a  $1000pF$  load. Bootstrapping reduces the effective input capacitance, since no AC voltage appears between the shield and inner conductor.

The AMP-05's guard drivers can form either a differential or single-ended drive (refer to Figures 4(a) and (b)). In the single-ended arrangement, the two input cable shields are held at the

same potential, the common-mode voltage (Figure 4(b)). As such, the connection is also appropriate for one shielded twisted-pair cable. The single-ended arrangement maintains a high CMR even at high frequencies, but does not reduce high frequency gain degradation as it does not counteract differential-mode capacitance. Single-ended drive is acceptable for gains greater than ten using the circuit in Figure 4(b). However the differential connection, Figure 4(a), offers better overall performance because it effectively reduces both differential and common-mode capacitance. Reduction in these capacitances improves high-frequency CMR, settling-time, and gain.

It should be noted that all shield drive arrangements are potentially positive feedback configurations and under some conditions high frequency ringing may occur. If this proves troublesome, small resistors ( $500\Omega$ - $1k\Omega$ ) in series with the cable shield outputs will improve transient response and settling-time but reduce the effectiveness of the cable shield, particularly at high frequency.

Short circuits from the cable drives to ground will not damage the AMP-05 but will result in malfunction of the AMP-05 until the short is removed. The package pins adjacent to the two inputs,  $R_G$  connections and guard drives, sit within 2 volts of the input signals. This feature reduces leakage currents to the input terminals and eliminates the need for guard-rings which are necessary on many FET input amplifiers.

**FIGURE 4:** Applying the Guard Drivers to shield the inputs, guard driving reduces the effective input capacitance and improves CMR.

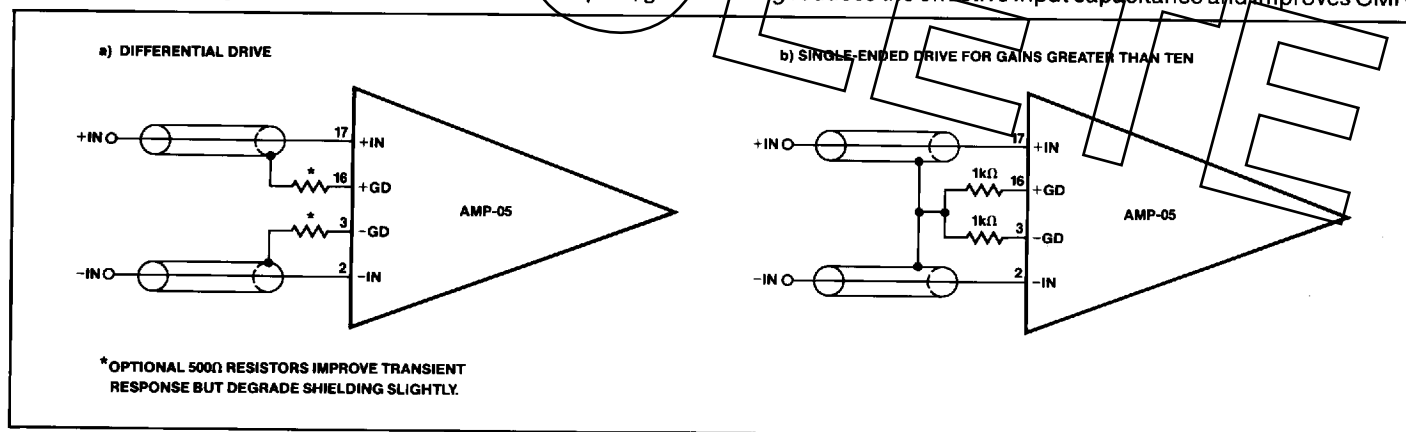

# AMP-05

## GROUNDING

The majority of instruments and data acquisition systems have separate grounds for analog and digital signals. Analog ground may also be divided into two or more grounds which will be tied together at one point, usually the analog power-supply ground. In addition, the digital and analog grounds may be joined, normally at the analog ground pin on the A-to-D converter. Following this basic grounding practice is essential for good circuit performance (Figure 5).

Mixing grounds causes interactions between digital circuits and the analog signals. Since the ground returns have finite resistance and inductance, hundreds of millivolts can be developed between the system ground and the data acquisition components. Using separate ground returns minimizes the current flow in the sensitive analog return path to the system ground point. Consequently, noisy ground currents from logic gates do not interact with the analog signals.

Inevitably, two or more circuits will be joined together with their grounds at differential potentials. In these situations, the differential input of an instrumentation amplifier, with its high CMR, can accurately transfer analog information from one circuit to another.

## MAXIMIZING NEGATIVE PSR

Using well stabilized, low-noise power supplies is always recommended for precision analog circuits. However even with good supplies, there will be small changes in output voltage due to temperature variations and line voltage variations. In turn, these voltage changes will affect the amplifier output due to finite power-supply rejection (PSR).

The AMP-05's PSR can be maximized in critical applications by adding a trim potentiometer (see Figure 6). Positive PSR cannot be trimmed by external means but this is better than negative

PSR by as much as 20dB, and therefore trimming should not be necessary. Adjusting the negative PSR trim potentiometer also affects output offset voltage,  $V_{OOS}$ . Therefore in systems where offset correction is not employed, a  $V_{OOS}$  null potentiometer can be added if needed. In practice, the interaction between these two potentiometers is not a problem.

PSR/ $V_{OOS}$  trimming procedure: 1) adjust both potentiometers to mid-position; 2) superimpose a low-frequency 1V peak-to-peak sine wave on the negative supply; 3) adjust PSR trim potentiometer for minimum output ripple; 4) remove AC signal from the power supply and null the AMP-05's output offset voltage using the  $V_{OOS}$  null potentiometer. Steps 1 and 4 are deleted when only PSR trimming is required.

FIGURE 6: Additional Trim Potentiometer Maximizes Negative PSR

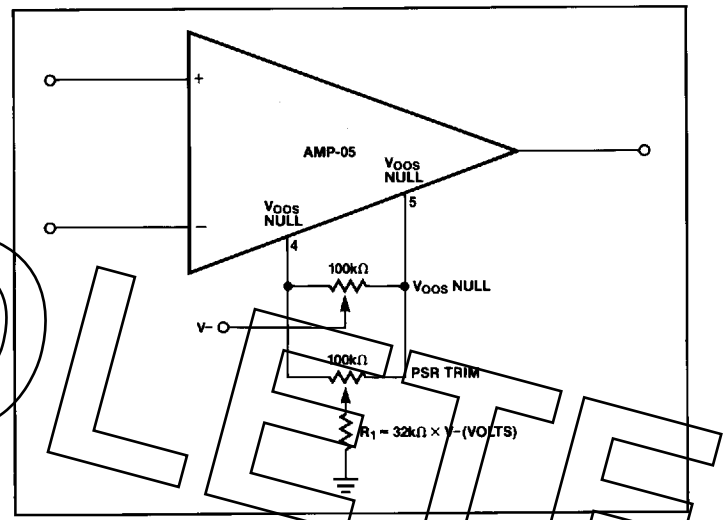
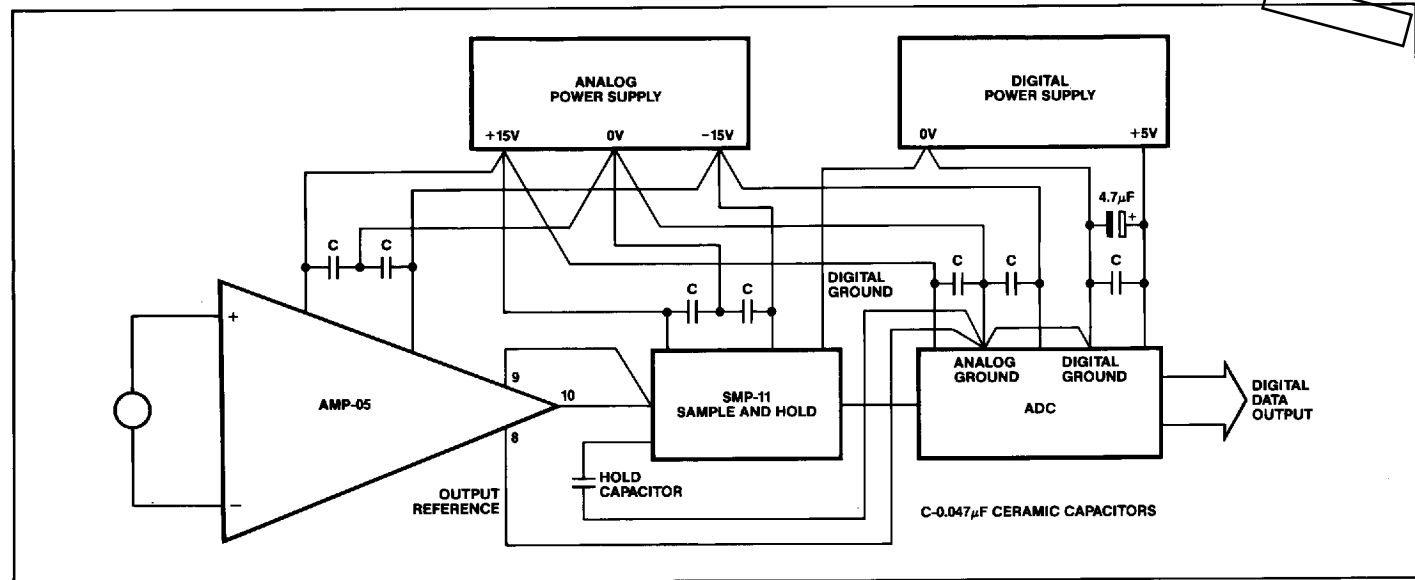

FIGURE 5: Basic Grounding Practice



**CURRENT SOURCE**

The on-board  $100\mu\text{A}$  current source is provided for transducer excitation, powering a low-current voltage reference diode, and other functions. The current source is referenced from the positive supply rail ( $V+$ ), and provides a high voltage compliance from 4 to 30V below  $V+$ . The output should not be pulled below  $V-$ . Output resistance is typically  $3\text{G}\Omega$ . Simple positive and negative voltage references can be generated by adding two resistors and an inexpensive op amp (Figures 7(a) and (b)). Temperature stability can be improved by replacing R1 with a low-current zener or voltage reference diode such as the LM185. The output reference voltage can be increased beyond the zener voltage by adding resistor R3 to add gain around the OP-77.

If the current source is not used it may be left floating or connected to  $V-$ .

**SENSE AND REFERENCE TERMINALS**

The sense terminal completes the feedback path for the instrumentation amplifier output stage and is normally connected directly to the output. The output signal is specified with respect to the reference terminal, which is normally connected to analog ground.

If high output currents are expected and/or the load is situated some distance from the amplifier, voltage drops due to trace or wire resistance will cause errors. Under these conditions, the sense and reference terminals can be used to "remote sense" the load as shown in Figure 8. This method of connection puts the  $I \times R$  drops inside the feedback loop and virtually eliminates the error. An unbalance in the lead resistances from the sense and reference pins does not degrade CMR, but will change the output offset by only  $1\text{mV}$ .

**FIGURE 7:** Generating a Reference Voltage Using the On-Board Current-Source

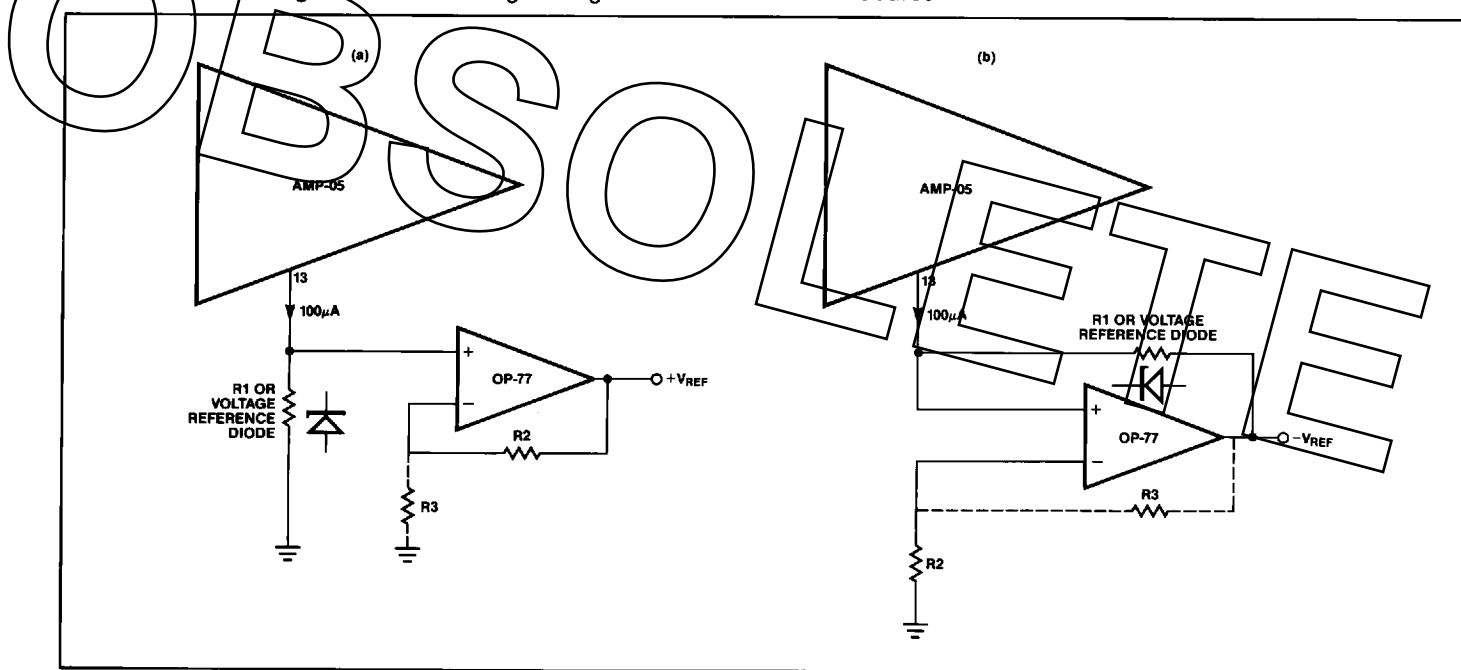

**FIGURE 8:** Remote Load Sensing

