



### Typical Applications

The HMC496LP3 / HMC496LP3E is suitable for various modulation systems:

- Fixed Wireless or WLL
- U-NII Radios
- 802.11a & HiperLAN WLAN
- C-band Microwave Radios

### Features

- Wideband RF Frequency Range
- High Carrier Suppression: 34 dBc
- Very Low Noise Floor: -157 dBm/Hz
- Low LO Power: -3 to +6 dBm
- Differential or Single Ended LO Drive
- Single Low Current Supply: +3.0V @ 93 mA
- 3 x 3 mm QFN SMT Plastic Package

### Functional Diagram

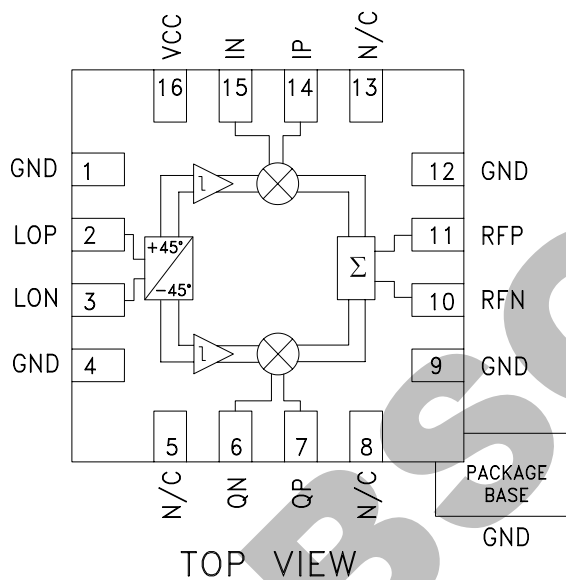

### General Description

The HMC496LP3 & HMC496LP3E are low noise Wideband Direct Quadrature Modulator RFICs which are ideal for digital modulation applications from 4 - 7 GHz including; WLL, U-NII, WLAN & microwave radios. Housed in a compact 3x3 mm (LP3) SMT QFN package, the RFIC requires minimal external components & provides a low cost alternative to more complicated double upconversion architectures. The RF output port is matched to 50 Ohms with no external components. The LO requires -3 to +6 dBm and can be driven in either differential or single-ended mode while the Baseband inputs will support modulation inputs from DC - 250 MHz typical. This device is optimized for a supply voltage of +3V @ 93 mA and will provide stable performance over a +2.7V to +3.3V range.

### Electrical Specifications, See Test Conditions on following page herein.

Parameter	Min.	Typ.	Max.	Min.	Typ.	Max.	Min.	Typ.	Max.	Units
Frequency Range, RF		4.9 - 5.4		5.4 - 5.9			5.9 - 6.4			GHz
Output Power	-1	+2		-1	+2		-2	+1		dBm
Output P1dB		3			4			4		dBm
Output IP3	15	18		14	17		14	17		dBm
Output Noise Floor		-157			-156			-155		dBm/Hz
Carrier Suppression (uncalibrated)		34			34			31		dBc
Sideband Suppression (uncalibrated)		40			39			39		dBc
IM3 Suppression		45			42			41		dBc
RF Port Return Loss		7			9			8		dB
LO Port Return Loss		11			10			10		dB

Information furnished by Analog Devices is believed to be accurate and reliable. However, no responsibility is assumed by Analog Devices for its use, nor for any infringements of patents or other rights of third parties that may result from its use. Specifications subject to change without notice. No license is granted by implication or otherwise under any patent or patent rights of Analog Devices. Trademarks and registered trademarks are the property of their respective owners.

For price, delivery, and to place orders: Analog Devices, Inc., One Technology Way, P.O. Box 9106, Norwood, MA 02062-9106 Phone: 781-329-4700 • Order online at [www.analog.com](http://www.analog.com) Application Support: Phone: 1-800-ANALOG-D



### Electrical Specifications, (continued)

Parameter	Conditions	Min.	Typ.	Max.	Units
<b>RF Output</b>					
RF Frequency Range		4.0		7.0	GHz
RF Return Loss			8		dB
<b>LO Input</b>					
LO Frequency Range		4.0		7.0	GHz
LO Input Power		-3	+3	+9	dBm
LO Port Return Loss			10		dB
<b>Baseband Input Port (Note 1)</b>					
Baseband Port Bandwidth	With 50Ω source & external 10 pF shunt cap to ground. Refer to HMC496LP3 Application Circuit.	DC		250	MHz
Baseband Input DC Voltage (Vbbdc)	This parameter can be varied in order to optimize the device performance over temperature and/or supply.	1.0	1.3	1.6	V
Baseband Input DC Bias Current (Ibbdc)	Single-ended		32		μA
Baseband Input Capacitance	Single-ended. De-embedded to the part pin.		0.8		pF
<b>DC Power Requirements</b> See Test Conditions Below					
Supply Voltage (Vcc)		2.7	3.0	3.3	V
Supply Current (Icc)			93		mA

### Test Conditions: Unless Otherwise Specified, the Following Test Conditions Were Used

Parameter	Condition
Temperature	+25 °C
Baseband Input Frequency	200 kHz
Baseband Input DC Voltage (Vbbdc)	1.3V
Baseband Input AC Voltage (Peak to Peak Differential, I and Q)	1.2V
Baseband Input AC Voltage for OIP3 Measurement (Peak to Peak Differential, I and Q)	600 mV per tone @ 150 & 250 kHz
Frequency Offset for Output Noise Measurements	20 MHz
Supply	+3.0V
LO Input Power	+3 dBm
LO Input Mode	Single-Ended
Mounting Configuration	Refer to HMC496LP3 Application Schematic Herein
Sideband & Carrier Suppression	Uncalibrated
RF Output Mode	Differential

#### Calibrated vs. Uncalibrated Test Results

During the Uncalibrated Sideband and Carrier Suppression tests, care is taken to ensure that the I/Q signal paths from the Vector Signal Generator (VSG) to the Device Under Test (DUT) are equal. The “Uncalibrated, +25 °C” Sideband and Carrier Suppression plots were measured at room temperature, while the “Uncalibrated, over Temperature” Sideband and Carrier Suppression plots represent the worst case uncalibrated suppression levels measured at T= -40 °C, +25 °C, and +85 °C.

The “Calibrated, +25 °C” Sideband Suppression data was plotted after a manual adjustment of the I/Q amplitude balance and I/Q phase offset (skew) at +25C, and an LO input power level of + 3 dBm. This adjustment setting was held constant during tests over LO input power level and temperature. The “Calibrated, over Temperature” plots represent the worst case calibrated Sideband Suppression levels at T= -40 °C, +25 °C, and +85 °C.

The “Calibrated, +25 °C” Carrier Suppression data was plotted after a manual adjustment of the Ip/In & Qp/Qn DC offsets at +25 °C, and an LO input power level of + 3 dBm. This adjustment setting was held constant during tests over LO input power level and temperature. The “Calibrated, over Temperature” plots represent the worst case Carrier Suppression levels measured at T= -40 °C, +25 °C, and +85 °C.

*Note 1: When I leads Q, the output spectrum results in lower sideband as the desired signal.*

Information furnished by Analog Devices is believed to be accurate and reliable. However, no responsibility is assumed by Analog Devices for its use, nor for any infringements of patents or other rights of third parties that may result from its use. Specifications subject to change without notice. No license is granted by implication or otherwise under any patent or patent rights of Analog Devices. Trademarks and registered trademarks are the property of their respective owners.

For price, delivery, and to place orders: Analog Devices, Inc., One Technology Way, P.O. Box 9106, Norwood, MA 02062-9106  
 Phone: 781-329-4700 • Order online at [www.analog.com](http://www.analog.com)  
 Application Support: Phone: 1-800-ANALOG-D



**SiGe WIDEBAND DIRECT MODULATOR RFIC, 4 - 7 GHz**

**Wideband Performance vs. Frequency**

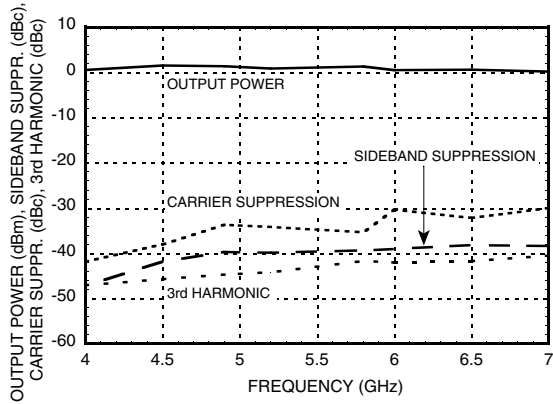

**Output Noise Floor and P1dB vs. Frequency**

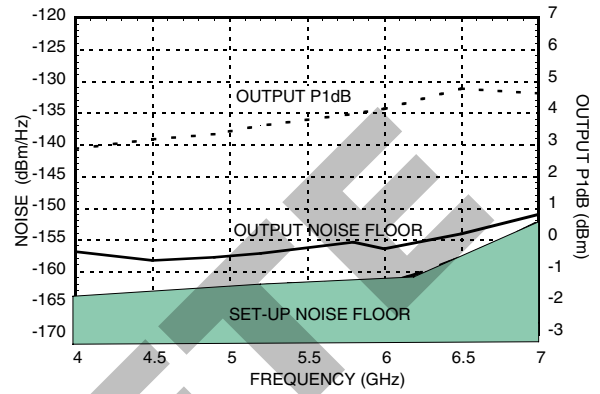

**Output IP3 vs. Frequency**

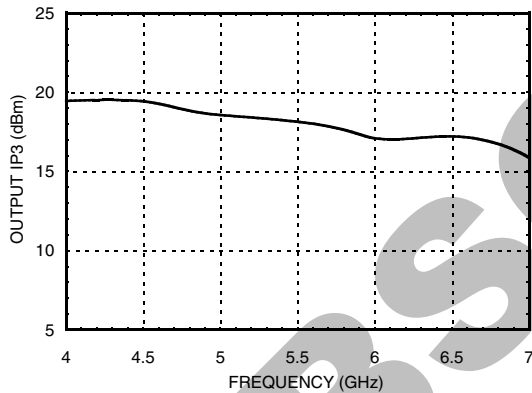

**Return Loss**

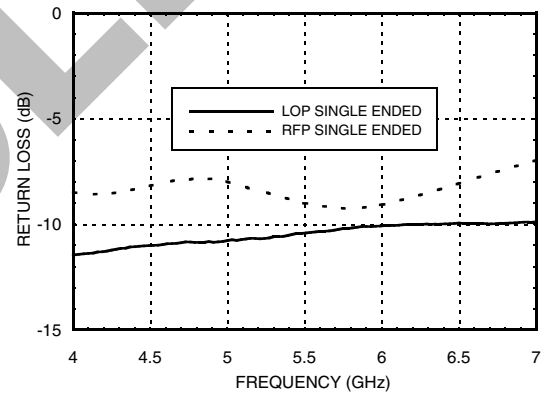

11

MODULATORS - DIRECT QUADRATURE - SMT

Information furnished by Analog Devices is believed to be accurate and reliable. However, no responsibility is assumed by Analog Devices for its use, nor for any infringements of patents or other rights of third parties that may result from its use. Specifications subject to change without notice. No license is granted by implication or otherwise under any patent or patent rights of Analog Devices. Trademarks and registered trademarks are the property of their respective owners.

For price, delivery, and to place orders: Analog Devices, Inc., One Technology Way, P.O. Box 9106, Norwood, MA 02062-9106 Phone: 781-329-4700 • Order online at [www.analog.com](http://www.analog.com) Application Support: Phone: 1-800-ANALOG-D



**SiGe WIDEBAND DIRECT MODULATOR RFIC, 4 - 7 GHz**

**Output IP3 & Output Power vs. LO Power Over Temperature@ 5200 MHz**

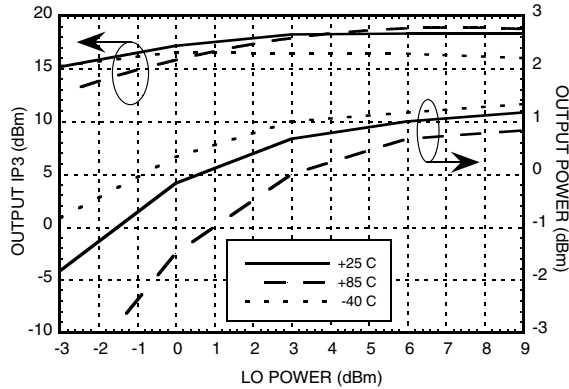

**Output IP3 & Output Power vs. LO Power Over Supply@ 5200 MHz**

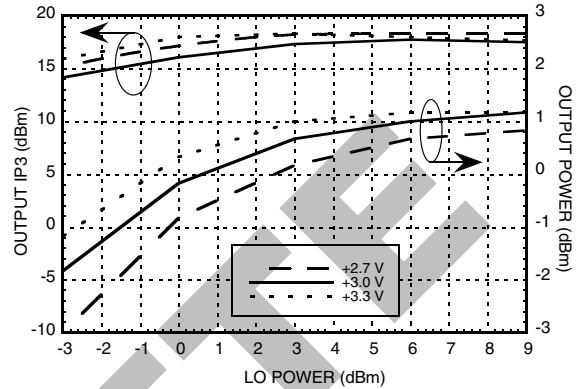

**Output Noise vs. LO Power Over Temperature@ 5200 MHz**

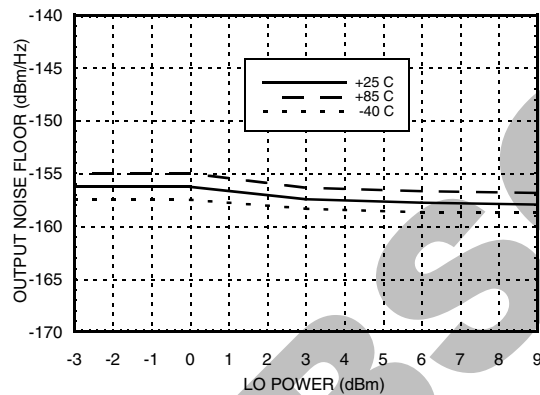

**Output Noise vs. LO Power Over Supply@ 5200 MHz**

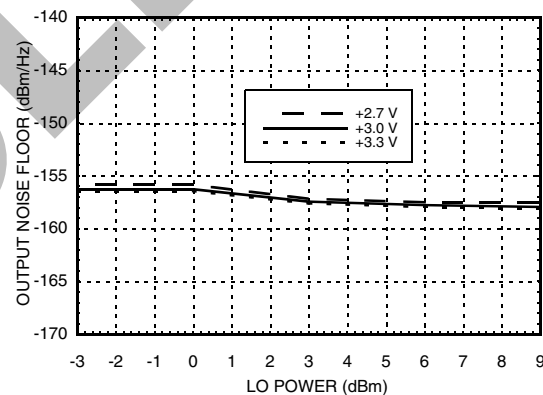

**Sideband Suppression\* vs. LO Power@ 5200 MHz**

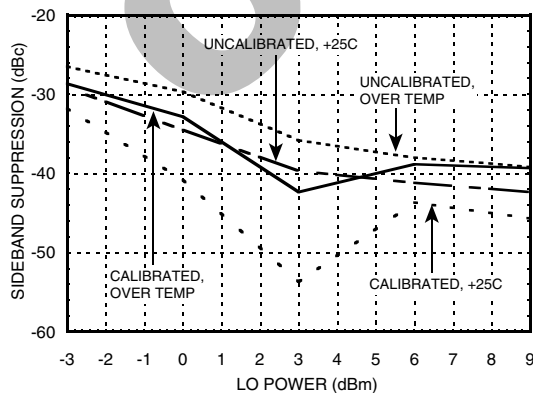

**Carrier Suppression\* vs. LO Power@ 5200 MHz**

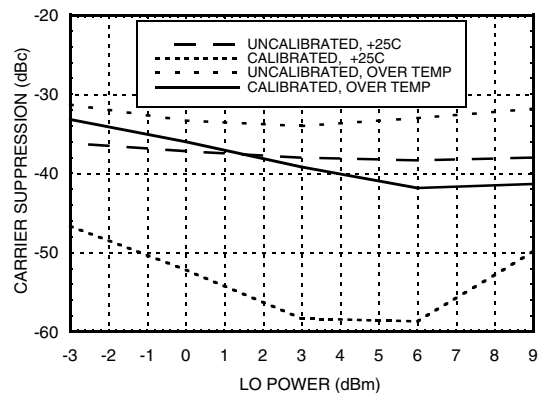

\* See note regarding Calibrated vs. Uncalibrated test results herein.

Information furnished by Analog Devices is believed to be accurate and reliable. However, no responsibility is assumed by Analog Devices for its use, nor for any infringements of patents or other rights of third parties that may result from its use. Specifications subject to change without notice. No license is granted by implication or otherwise under any patent or patent rights of Analog Devices. Trademarks and registered trademarks are the property of their respective owners.

For price, delivery, and to place orders: Analog Devices, Inc., One Technology Way, P.O. Box 9106, Norwood, MA 02062-9106 Phone: 781-329-4700 • Order online at [www.analog.com](http://www.analog.com) Application Support: Phone: 1-800-ANALOG-D



**Output IP3 & Output Power vs. LO Power Over Temperature@ 5800 MHz**

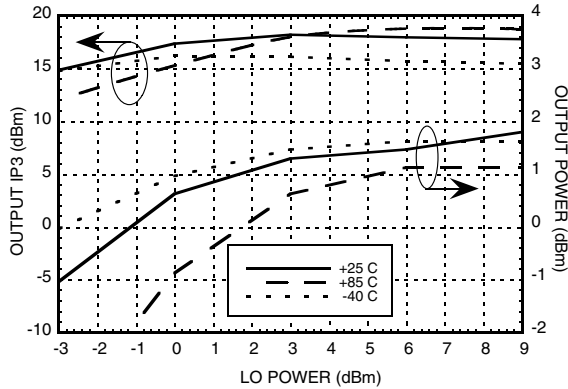

**Output IP3 & Output Power vs. LO Power Over Supply@ 5800 MHz**

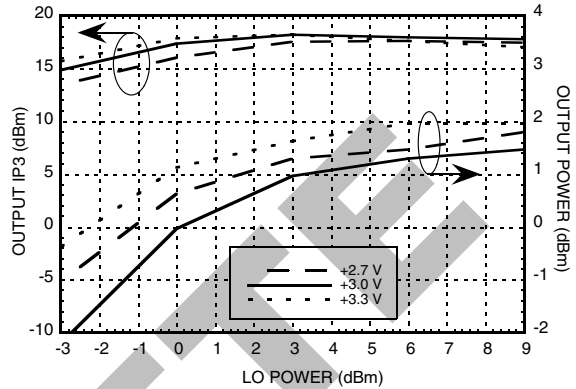

**Output Noise vs. LO Power Over Temperature@ 5800 MHz**

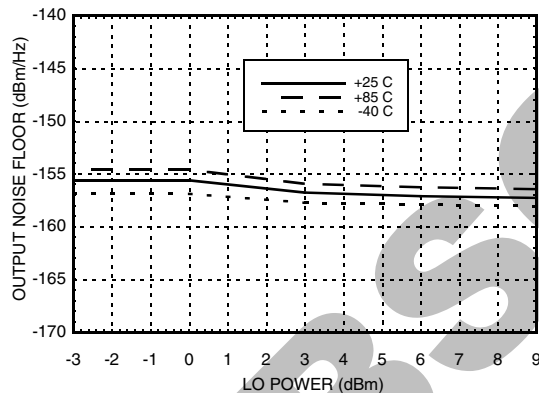

**Output Noise vs. LO Power Over Supply@ 5800 MHz**

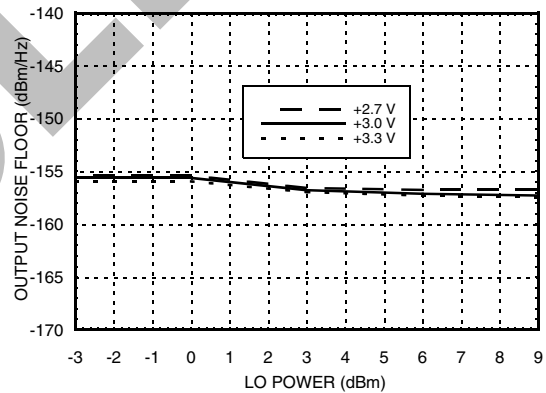

**Sideband Suppression\* vs. LO Power@ 5800 MHz**

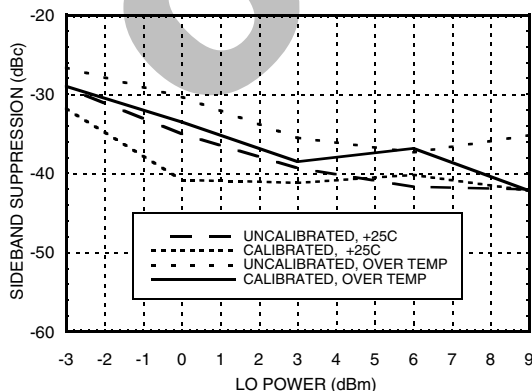

**Carrier Suppression\* vs. LO Power@ 5800 MHz**

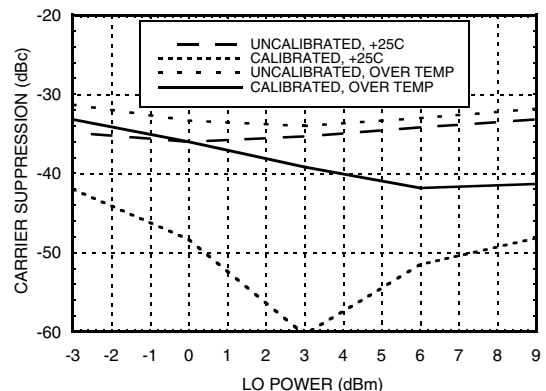

Information furnished by Analog Devices is believed to be accurate and reliable. However, no responsibility is assumed by Analog Devices for its use, nor for any infringements of patents or other rights of third parties that may result from its use. Specifications subject to change without notice. No license is granted by implication or otherwise under any patent or patent rights of Analog Devices. Trademarks and registered trademarks are the property of their respective owners.

For price, delivery, and to place orders: Analog Devices, Inc., One Technology Way, P.O. Box 9106, Norwood, MA 02062-9106 Phone: 781-329-4700 • Order online at [www.analog.com](http://www.analog.com) Application Support: Phone: 1-800-ANALOG-D



### Absolute Maximum Ratings

Vcc	-0.5 to +6.0V
LO Input Power	+10 dBm
Baseband Input Voltage (Reference to GND)	-0.5 to +2.0V
Channel Temperature	150 °C
Continuous P <sub>diss</sub> (T = 85°C) (Derate 110 mW/°C above 85°C)	7 Watts
Thermal Resistance (R <sub>th</sub> ) (junction to lead)	9 °C/Watt
Storage Temperature	-40 to +150 °C
Operating Temperature	-40 to +85 °C



ELECTROSTATIC SENSITIVE DEVICE  
OBSERVE HANDLING PRECAUTIONS

### Outline Drawing

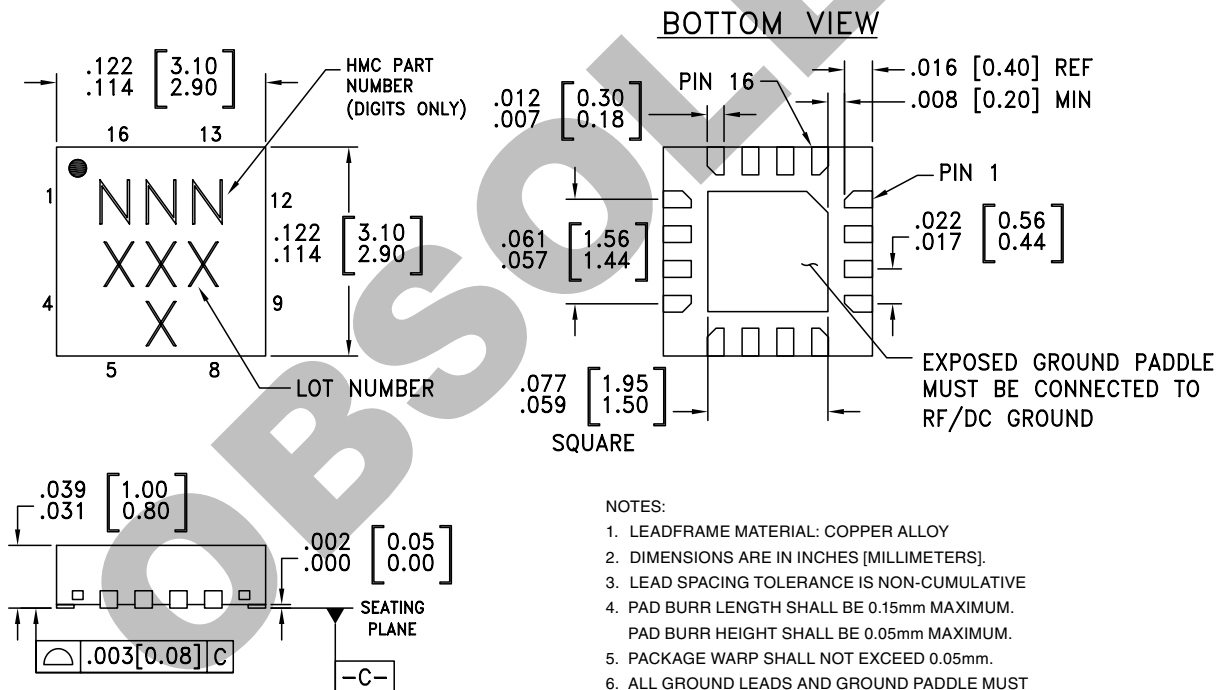

### Package Information

Part Number	Package Body Material	Lead Finish	MSL Rating	Package Marking <sup>[3]</sup>
HMC496LP3	Low Stress Injection Molded Plastic	Sn/Pb Solder	MSL1 <sup>[1]</sup>	496 XXXX
HMC496LP3E	RoHS-compliant Low Stress Injection Molded Plastic	100% matte Sn	MSL1 <sup>[2]</sup>	496 XXXX

[1] Max peak reflow temperature of 235 °C

[2] Max peak reflow temperature of 260 °C

[3] 4-Digit lot number XXXX



### Pin Descriptions

Pin Number	Function	Description	Interface Schematic
1, 4, 9, 12	GND	These pins and the ground paddle must be connected to a high quality RF/DC ground.	
2, 3	LOP, LON	Differential LO input ports. This device may be driven in either differential or single ended mode. In single ended mode, one port should be driven by the LO source while the other port may be terminated with a 50Ω resistor to ground.	
5, 8, 13	N/C	No Connection required. These pins may be connected to RF/DC ground without affecting performance.	
6, 7	QN, QP	Differential Quadrature baseband input. These are high impedance ports. The nominal recommended bias voltage is between 1.2 - 1.4V. The nominal recommended baseband input voltage is 1.2V peak to peak differential. By adjusting the DC bias voltage on ports QN & QP, the Carrier Suppression of the device can be optimized for a specific frequency band and LO power level. The typical offset voltage for optimization is less than 15 mV.  The amplitude and phase difference between the I and Q inputs can be adjusted in order to optimize the Sideband Suppression for a specific frequency band and LO power level.	
10, 11	RFN, RFP	RF Output port. This port is matched to 50 Ohms. A series capacitor should be connected to this port in order to prevent the DC supply voltage from appearing on the customer's PC board.	
14, 15	IP, IN	Differential Quadrature baseband input. These are high impedance ports. The nominal recommended bias voltage is between 1.2 - 1.4V. The nominal recommended baseband input voltage is 1.2V peak to peak differential. By adjusting the DC bias voltage on ports IN & IP, the Carrier Suppression of the device can be optimized for a specific frequency band and LO power level. The typical offset voltage for optimization is less than 15 mV.  The amplitude and phase difference between the I and Q inputs can be adjusted in order to optimize the Sideband Suppression for a specific frequency band and LO power level.	
16	VCC	Supply voltage. Set to 3.0V for nominal operation. The nominal current for this port is 93 mA.	



**Evaluation PCB**

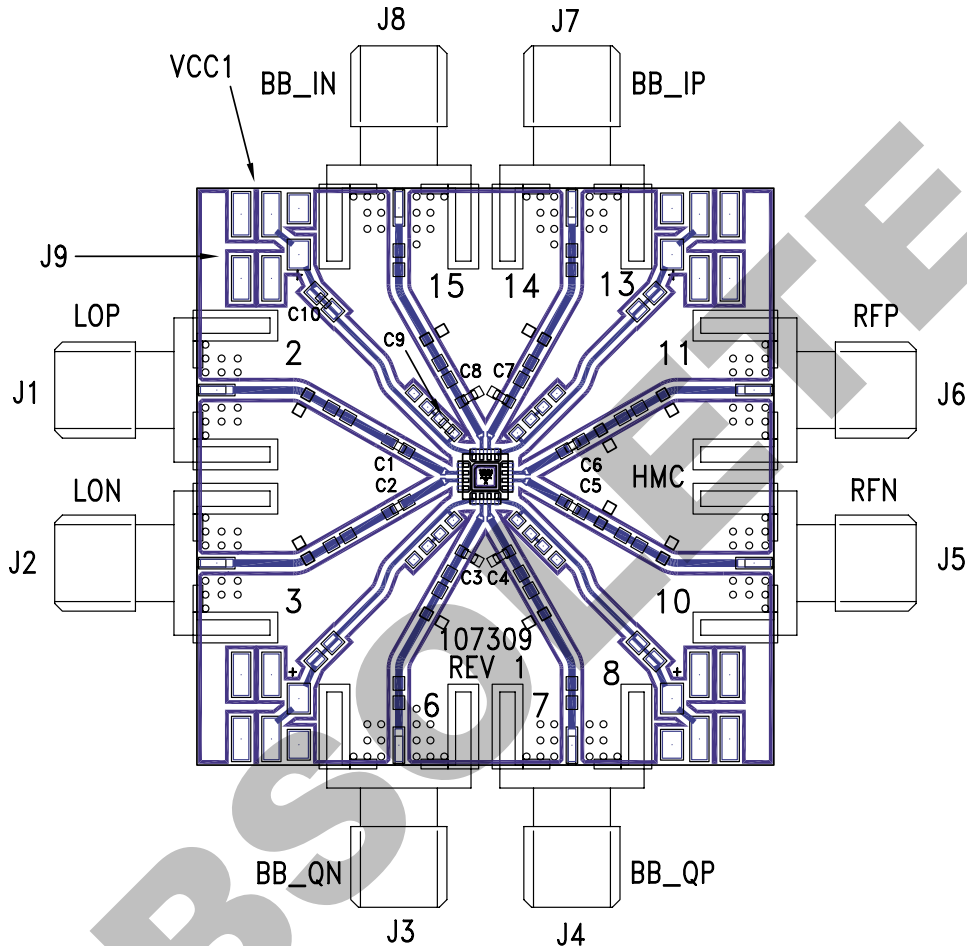

**List of Materials for Evaluation PCB 107871 [1]**

Item	Description
J1 - J8	PCB Mount SMA Connector
J9	DC Molex Connector
C1, C2, C5, C6	100 pF Chip Capacitor, 0402 Pkg.
C9	10k pF Chip Capacitor, 0402 Pkg.
C3, C4, C7, C8	10 pF Chip Capacitor, 0402 Pkg.
C15	4.7 uF, Case A, Tantalum
U1	HMC496LP3 / HMC496LP3E Modulator
PCB [2]	107309 Eval Board

[1] Reference this number when ordering complete evaluation PCB

[2] Circuit Board Material: Rogers 4350

The circuit board used in the final application should use RF circuit design techniques. Signal lines should have 50 ohm impedance while the package ground leads and exposed paddle should be connected directly to the ground plane similar to that shown. A sufficient number of via holes should be used to connect the top and bottom ground planes. The evaluation circuit board shown is available from Hittite upon request.





**Application & Evaluation PCB Schematic**

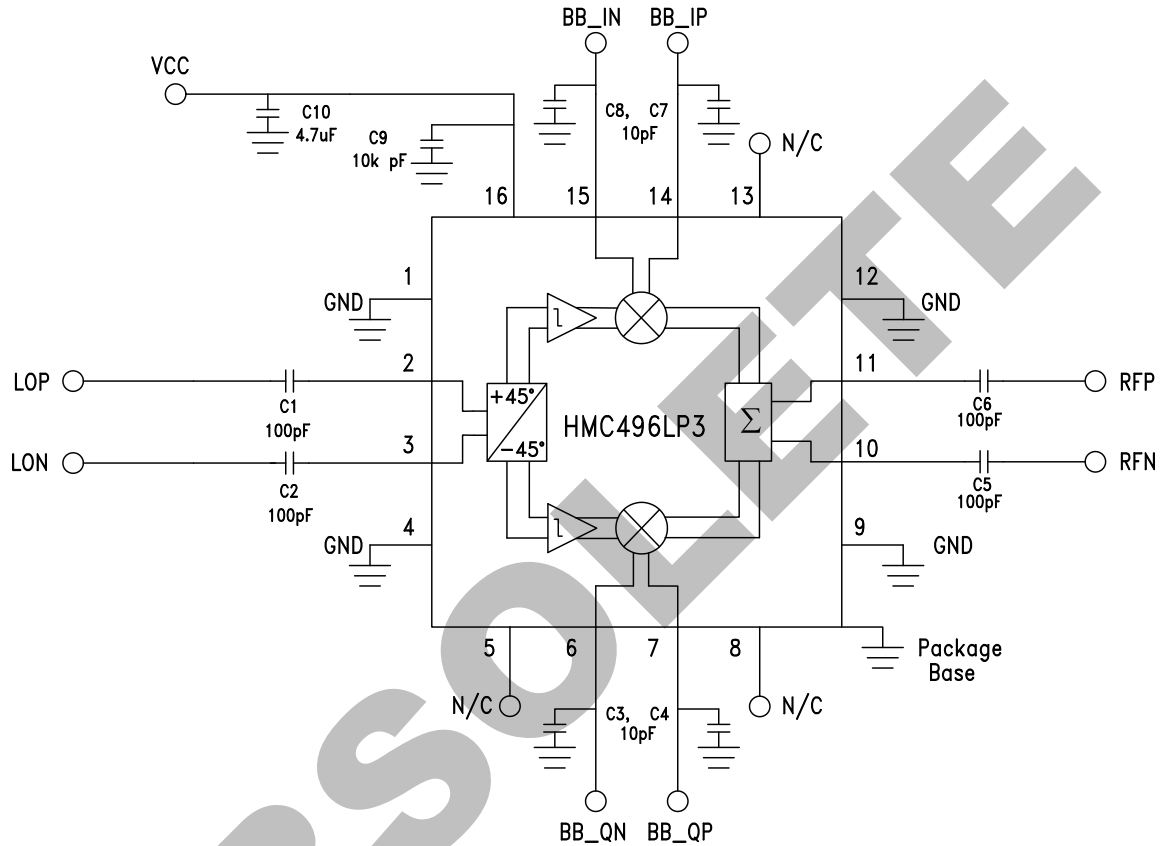

**Note:**

Baseband input frequency range is dependent on value of C3, C4, C7 and C8. The value of 10 pF was chosen to give a typical response of DC - 250 MHz. Input frequency range can be extended up to 3 GHz with possible degradation of LO leakage and broadband noise floor response by decreasing the value of C3, C4, C7 & C8.

**Characterization Set-up**

