



# DESIGN NOTES

## The LT1304: Micropower DC/DC Converter with Independent Low-Battery Detector – Design Note 120

Steve Pietkiewicz

In the expanding world of low power portable electronics, a 2- or 3-cell battery remains a popular power source. Designers have many options for converting the 2V to 4V battery voltage to 5V, 3.3V and other required system voltages using low voltage DC/DC converter ICs. The LT<sup>®</sup>1304 offers users a micropower step-up DC/DC converter featuring Burst Mode<sup>®</sup> operation and a low-battery detector that stays alive when the converter is shut down. The device consumes only 125 $\mu$ A when active, yet can deliver 5V at up to 200mA from a 2V input. High frequency operation up to 300kHz allows the use of tiny surface mount inductors and capacitors. When the device is shut down the low-battery detector draws only 10 $\mu$ A. An efficient internal power NPN switch handles 1A with a drop of 500mV. Up to 85% efficiency is obtainable in 2-cell to 5V converter applications. The fixed output LT1304-5 and LT1304-3.3 versions have internal resistor dividers that set the output voltage to 5V or 3.3V, respectively.

### A 2-Cell to 5V Converter

A compact 2-cell to 5V converter can be constructed using the circuit of Figure 1. The LT1304-5 fixed output device eliminates the need for external voltage setting resistors, lowering component count. As the battery voltage drops, the circuit continues to function until the LT1304's undervoltage lockout disables the part at approximately  $V_{IN} = 1.5V$ . Up to 200mA output current

is available at a battery voltage of 2V. As the battery voltage decreases below 2V, cell impedance starts to quickly increase. End-of-life is usually assumed to be around 1.8V, or 0.9V per cell. Burst Mode micropower operation keeps efficiency above 70% even for load current below 1mA. Efficiency, detailed in Figure 2, reaches 85% for a 3.3V input. Load transient response is illustrated in Figure 3. Since the LT1304 uses a hysteretic comparator in place of the traditional linear feedback loop, the circuit responds immediately to changes in load current. Figure 4 details start-up behavior. After the device is enabled, output voltage reaches 5V in approximately 2ms while delivering 200mA.

LT, LT, LTC, LTM, Linear Technology, the Linear logo and Burst Mode are registered trademarks and Super Burst is a trademark of Linear Technology Corporation. All other trademarks are the property of their respective owners.

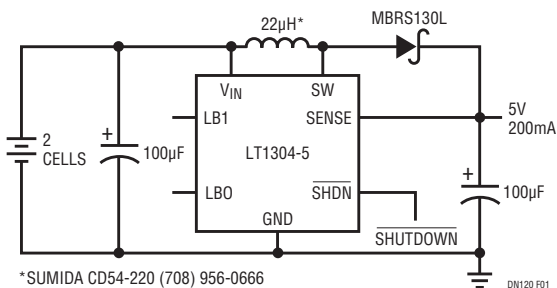

Figure 1. 2-Cell to 5V/200mA Boost Converter Requires Only Four External Parts

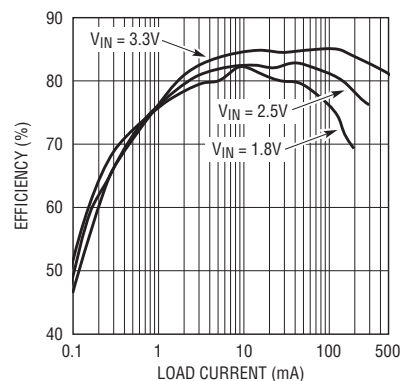

Figure 2. 2-Cell to 5V Converter Efficiency

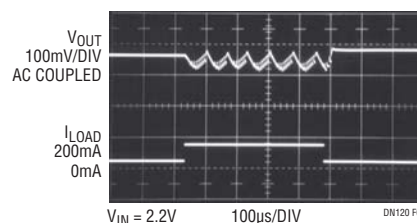
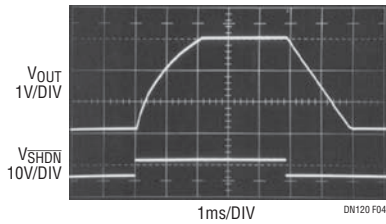

Figure 3. Boost Converter Load Transient Response



**Figure 4. Start-Up Response into 200mA Load.  $V_{OUT}$  Reaches 5V in Just Over 2ms**

### Super Burst™ Mode Operation: 5V/80mA DC/DC with 15µA Quiescent Current

The LT1304's low-battery detector can be used to control the DC/DC converter. The result is a reduction in quiescent current by almost an order of magnitude. Figure 5 details this Super Burst mode operation circuit.  $V_{OUT}$  is monitored by the LT1304's LBI pin via resistor divider R1/R2. When LBI is above 1.2V, LBO is high, forcing the LT1304 into shutdown mode and reducing current drain from the battery to 15µA. When  $V_{OUT}$  decreases enough to overcome the low-battery detector's hysteresis (about 35mV) LBO goes low. Q1 turns on, pulling SHDN high and turning on the rest of the IC. R3 limits peak current to 500mA; it can be removed for higher output power. Efficiency is shown in Figure 6. The converter is approximately 70% efficient at a 100µA load, 20 points higher than the circuit of Figure 1. Even at a 10µA load, efficiency is in the 40% to 50% range, equivalent to 100µW to 120µW total power drain from the battery. In contrast, Figure 1's circuit consumes approximately 300µW to 400µW unloaded.

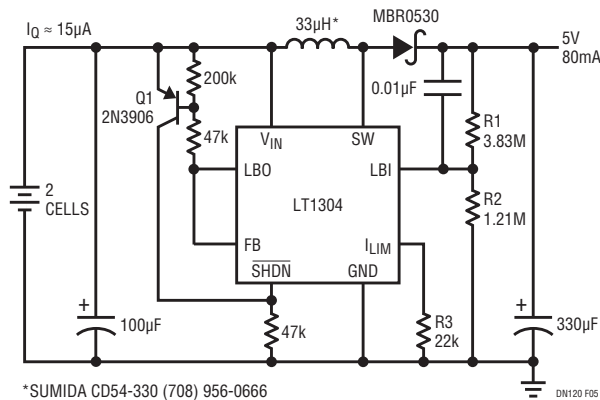

**Figure 5. Super Burst Mode Operation 2-Cell to 5V DC/DC Converter Draws Only 15µA Unloaded. Two AA Alkaline Cells Will Last for Years**

An output capacitor charging cycle or "burst" is shown in Figure 7 with the circuit driving a 50mA load. The slow response of the low-battery detector results in the high number of individual switch cycles or "hits" within the burst.

Figure 8 depicts output voltage at the modest load of 100µA. The burst repetition rate is around 4Hz. With the load removed, the repetition rate drops to approximately 0.2Hz, or one burst every 5 seconds. Systems that spend a high percentage of operating time in sleep mode can benefit from the greatly reduced quiescent power drain of Figure 5's circuit.

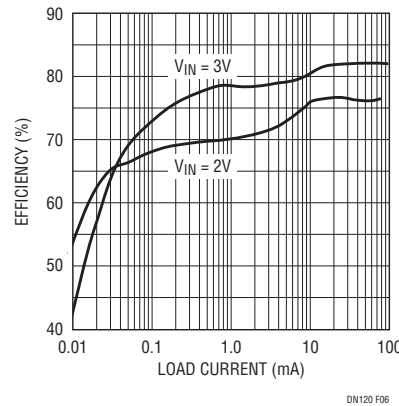

**Figure 6. Super Burst Mode Operation DC/DC Converter Efficiency**

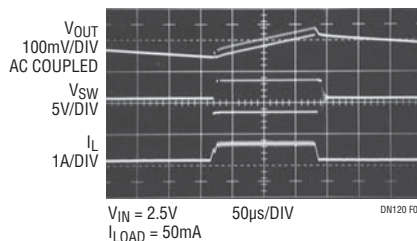

**Figure 7. Super Burst Mode Operation in Action**

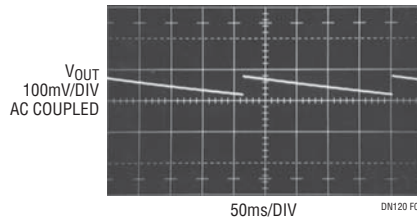

**Figure 8. Figure 5's Circuit, 100µA Load. Burst Occurs Approximately Once Every 240ms**

Data Sheet Download

www.linear.com

For applications help,  
call (408) 432-1900

Linear Technology Corporation  
1630 McCarthy Blvd., Milpitas, CA 95035-7417  
(408) 432-1900 • FAX: (408) 434-0507 • www.linear.com

dn120f\_conv LT/GP 0196 185K • PRINTED IN THE USA

**LINEAR**  
TECHNOLOGY  
© LINEAR TECHNOLOGY CORPORATION 1996