

LT1959 Monolithic 4A Switcher

5V to 15V Input

1.8V Output

DESCRIPTION

Demonstration circuits DC355 and DC356 are complete DC/DC step-down regulators using the LT[®]1959 constant frequency, high efficiency converter in 7-pin DD (DC356) and SO-8 (DC355) packages. These circuits are primarily used in personal computers, disk drives, portable

handheld devices and, in larger systems, as local onboard regulators. High frequency switching allows the use of small inductors, making this all surface mount solution ideal for space conscious systems.

LT, LTC and LT are registered trademarks of Linear Technology Corporation.

PERFORMANCE SUMMARY

$T_A = 25^\circ\text{C}$, $V_{IN} = 5\text{V}$, $I_{LOAD} = 2\text{A}$, $V_{OUT} = 1.8\text{V}$, $\overline{\text{SHDN}}$ and SYNC pins open, unless otherwise specified.

PARAMETER	CONDITIONS	MIN	TYP	MAX	UNITS
Output Voltage	(Note 1)	1.75	1.8	1.85	V
Maximum I_{LOAD}	(Note 2)	4.3			A
Input Voltage Range		4.5		15	V
Switching Frequency		460	500	540	kHz
Output Ripple Voltage			25		mV _{p-p}
Line Regulation	5V to 15V		4		mV
Load Regulation	$I_{LOAD} = 10\text{mA}$ to 4A		10		mV
$\overline{\text{SHDN}}$ Lockout Threshold		2.3	2.38	2.46	V
$\overline{\text{SHDN}}$ Shutdown Threshold		0.15	0.37	0.6	V
Synchronization Range	DC355 Only	580		1000	kHz
Supply Current	$\overline{\text{SHDN}} = 0\text{V}$		20		μA

Note 1: Output voltage variations include $\pm 1\%$ tolerance of feedback divider network.

Note 2: For DC355, additional thermal restrictions apply.

BOARD PHOTOS

DC355 Component Side



DC356 Component Side



TYPICAL PERFORMANCE CHARACTERISTICS

1.8V Output Efficiency

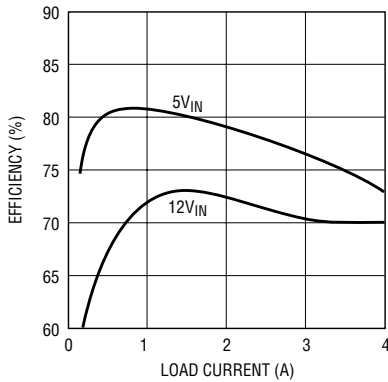

DC355/356 TA01

Temperature Rise vs Load Current

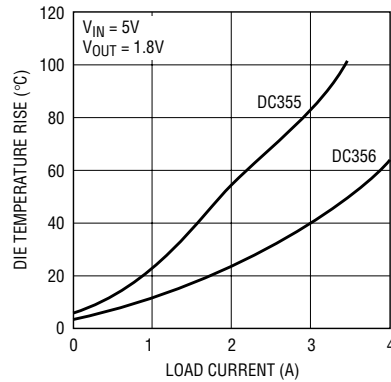

DC355/356 TA02

PACKAGE AND SCHEMATIC DIAGRAMS

DC355

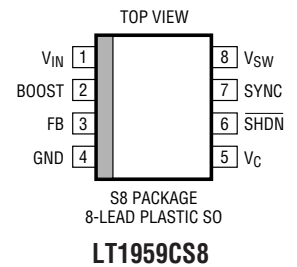
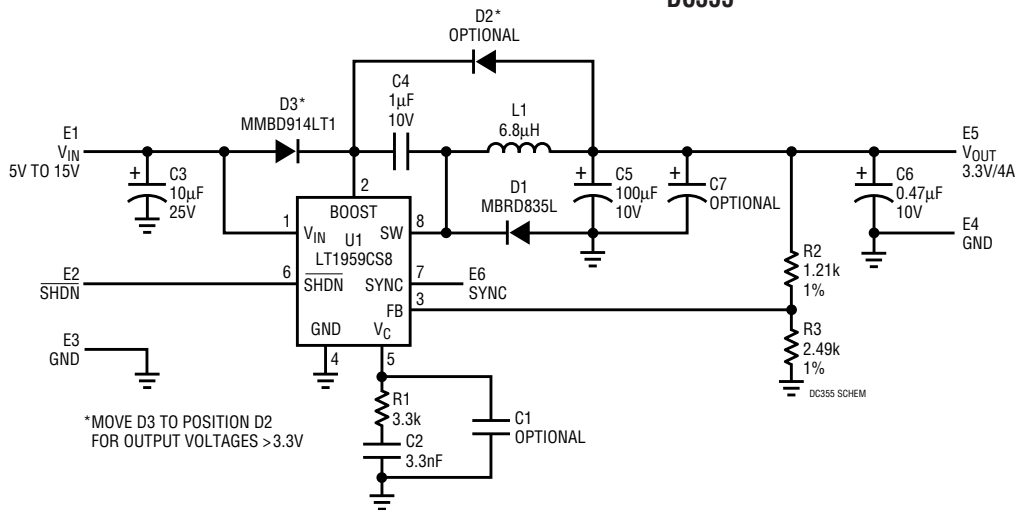

DC356

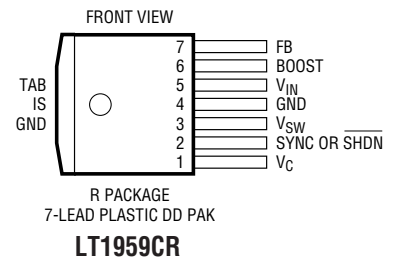
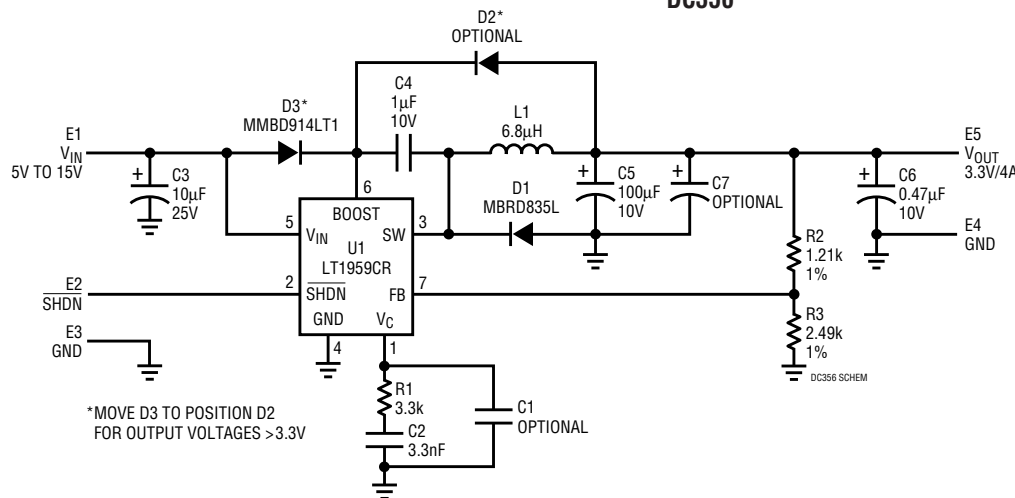

PARTS LISTS

DC355

REFERENCE DESIGNATOR	QUANTITY	PART NUMBER	DESCRIPTION	VENDOR	TELEPHONE
C1	0		Optional Capacitor		
C2	1	08055C332MAT2S	3300pF 50V X7R Chip Capacitor	AVX	(843) 946-0362
C3	1	GRM235Y5V106Z	10µF 25V Y5V Chip Capacitor	Murata	(770) 436-1300
C4	1	0805ZC105MAT2S	1µF 10V X7R Chip Capacitor	AVX	(843) 946-0362
C5	1	TPSD107M010R0080	100µF 10V TPS Tantalum Capacitor	AVX	(207) 282-5111
C6	1	0603ZG474MAT3S	0.47µF 10V Y5V Chip Capacitor	AVX	(843) 946-0362
C7	1		Optional Capacitor		
D1	1	MBRD835L	SMT Diode	ON Semiconductor	(602) 244-6600
D2	1	MMBD914LT1	1N914 Diode	ON Semiconductor	(602) 244-6600
D3	1		Optional Diode		
E1 to E6	6	2501-2	Pad Turret	Mill-Max	(516) 922-6000
R1	1	CR10-332JM	3.3k 1/8W 5% Chip Resistor	AAC	(714) 255-9186
R2	1	CR10-1821F-T	1.82k 1/8W 1% Chip Resistor	AAC	(714) 255-9186
R3	1	CR10-4991F-T	4.99k 1/8W 1% Chip Resistor	AAC	(800) 508-1521
L1	1	DO3316P-682	6.8µH 20% Inductor	Coilcraft	(847) 639-6400
U1	1	LT1959CS8	SO-8 Linear IC	LTC	(408) 432-1900

DC356

REFERENCE DESIGNATOR	QUANTITY	PART NUMBER	DESCRIPTION	VENDOR	TELEPHONE
C1	0		Optional Capacitor		
C2	1	08055C332MAT2S	3300pF 50V X7R Chip Capacitor	AVX	(843) 946-0362
C3	1	GRM235Y5V106Z	10µF 25V Y5V Chip Capacitor	Murata	(770) 436-1300
C4	1	0805ZC105MAT2S	1µF 10V X7R Chip Capacitor	AVX	(843) 946-0362
C5	1	TPSD107M010R0080	100µF 10V TPS Tantalum Capacitor	AVX	(207) 282-5111
C6	1	0603ZG474MAT3S	0.47µF 10V Y5V Chip Capacitor	AVX	(843) 946-0362
C7	1		Optional Capacitor		
D1	1	MBRD835L	SMT Diode	ON Semiconductor	(602) 244-6600
D2	1	MMBD914LT1	1N914 Diode	ON Semiconductor	(602) 244-6600
D3	1		Optional Diode		
E1 to E6	6	2501-2	Pad Turret	Mill-Max	(516) 922-6000
R1	1	CR10-332JM	3.3k 1/8W 5% Chip Resistor	AAC	(714) 255-9186
R2	1	CR10-1821F-T	1.82k 1/8W 1% Chip Resistor	AAC	(714) 255-9186
R3	1	CR10-4991F-T	4.99k 1/8W 1% Chip Resistor	AAC	(800) 508-1521
L1	1	DO3316P-682	6.8µH 20% Inductor	Coilcraft	(847) 639-6400
U1	1	LT1959CR	7-Pin DD Pak Linear IC	LTC	(408) 432-1900

OPERATION

DC355 vs DC356 (Temperature vs Package Size)

The DC355 and DC356 demonstration boards are intended for evaluation of the LT1959 switching regulator in the SO-8 and 7-pin DD packages, respectively. The 7-pin DD package used on DC356 has no SYNC pin. The primary reason for choosing the SO-8 over the DD package is board space. The DC356 (DD package) occupies an active board area of approximately 0.75 square inches. By optimizing the DC355 board, using a Sumida coil and removing the layout options, a total active area of 0.4 square inches can be achieved. The DD package is more suitable for higher power or higher ambient temperature applications. Although both boards will supply 4A of output current, DC355 must be thermally derated to 3A continuous current at 22°C ambient to prevent excessive die temperatures. DC356 can run at 60°C ambient at 4A output current. However, the SO-8 package can be used for dynamic loads up to the full rated switch current.

LT1959 Operation

The LT1959 data sheet gives a complete description of the part, operation and applications information. The data sheet should be read in conjunction with this demo manual.

Hook-Up

Solid turret terminals are provided for easy connection to supplies and test equipment. Connect a 0V to 15V, 4.5A power supply across the V_{IN} and GND terminals and the load across the V_{OUT} and GND terminals. When measuring load/line regulation, remember to Kelvin connect to the turrets. Also, when measuring output ripple voltage with an oscilloscope probe, the wire from the probe to the ground clip will act as an antenna, picking up excessive noise. For improved results, the test hook should be removed from the tip of the probe. The tip should be touched against the output turret, with the bare ground shield pressed against the ground turret. This reduces the noise seen on the waveform.

Shutdown

For normal operation, the $\overline{\text{SHDN}}$ pin can be left floating. $\overline{\text{SHDN}}$ has two output-disable modes: lockout and shutdown. When the pin is taken below the lockout

threshold, switching is disabled. This is typically used for input undervoltage lockout. Grounding the SHDN pin places the LT1959 in shutdown mode. This reduces total board supply current to 20 μ A.

Synchronization

Synchronization is available on DC355 only. For normal demo board operation, the SYNC pin can be left floating. If it is not used in the application, it is advisable to tie this pin to ground. To synchronize switching to an external clock, apply a logic-level signal to the SYNC pin. The amplitude must be from a logic low to greater than 2.2V, with a duty cycle between 10% and 90%. The synchronization frequency must be greater than the free-running oscillator frequency and less than 1MHz. Additional circuitry may be required to prevent subharmonic oscillation. Refer to the LT1959 data sheet for more details.

COMPONENTS

Inductor L1

The inductor is a Coilcraft D03316P-682, a 6.8 μ H unshielded ferrite unit. It was selected for its low cost, small size and 4.6A I_{SAT} rating. The equivalent Coiltronics UP2-6R8 unit can be substituted. If board space is at a premium and higher ripple current is acceptable, solder pads are available for the Sumida CD43-1R8 inductor. This 1.8 μ H unit has a 2.9A I_{SAT} rating. Ripple at 5V $_{IN}$ is ± 0.6 A. This gives a maximum output current of (4.5A – 0.6A) = 3.9A.

Input/Output Capacitors C3, C5, C6 and C7

The input capacitor C3 is a Tokin ceramic capacitor. It was selected for its small size, high voltage rating and low ESR (effective series resistance). The input ripple current for a buck converter is high, typically $I_{OUT}/2$. Tantalum capacitors become resistive at higher frequencies, requiring careful ripple-rating selection to prevent excessive heating. Ceramic capacitors' ESL (effective series inductance) tends to dominate their ESR, making them less susceptible to ripple-induced heating.

OPERATION

The output capacitor C5 is an AVX tantalum capacitor. A ceramic is not recommended as the main output capacitor, since loop stability relies on a resistive characteristic at higher frequencies to form a zero. The AVX TPS series was specifically designed to have the low ESR required in switch-mode power supplies. At switching frequencies, ripple voltage is more a function of ESR than of absolute capacitance value. If lower output ripple voltage is required, use the optional capacitor C7 to reduce ESR rather than increasing the capacitance of C5. For very low ripple, an additional LC filter in the output may be a less expensive solution. The output contains very narrow voltage spikes because of the parasitic inductance of C5. A small ceramic capacitor, C6, removes these spikes on the demo board. In application, trace inductance and local bypass capacitors will perform this function, negating the need for C6.

Catch Diode D1

Use diodes designed for switching applications, with adequate current rating and fast turn-on times, such as Schottky or ultrafast diodes. In selecting a diode, the basic parameters of interest are forward voltage, maximum reverse voltage, average operating current and peak current. Lower forward voltage yields higher circuit efficiency and lowers power dissipation in the diode. The MBRD835L has a maximum forward drop of 0.4V at 3A. The reverse voltage rating must be greater than the input voltage. Average diode current is always less than output current, but under a shorted output condition, diode current can equal the switch current limit. If the application must withstand this condition, the diode must be rated for maximum switch current.

Compensation: C1, C2 and R1

A detailed discussion of frequency compensation can be found in the LT1959 data sheet. R1 + C2 from V_C to ground give a stable loop response over a wide range of input and output conditions. Optional capacitor C1 is included for optimization of the dynamic response for a specific application.

Boost Voltage: D2, D3 and C4

A boost voltage of at least 2.8V is required throughout the on-time of the switch to guarantee that it remains saturated. For output voltages above 3.3V, diode D2 can replace D3 and provide sufficient boost voltage to C4.

PCB LAYOUT

In many cases, the layout of the demonstration board may be dropped directly into the application with minimal changes. If not, there are several precautions that must be taken when laying out high frequency converter circuits. The high frequency switching path runs from ground, through C3, to the V_{IN} pin of the LT1959, out of the SW pin, through D1 and back to ground. This loop acts as an antenna and will radiate noise if not kept as short as possible. Also, at higher switching currents, the associated trace inductance can cause excessive voltage spikes across the switch. The use of a ground plane will reduce many noise problems. The ground pin of the LT1959 contains some high frequency signal currents, but more importantly, it is the 0V reference for the output voltage. Connect the ground pin directly to the ground plane. The FB and V_C components should be kept away from the power components as much as possible. The ground for these components should be separated from power grounds. Run a Kelvin sense line to V_{OUT} as required but keep the divider network close to the LT1959 to prevent noise pickup on the FB node. Noise pickup on the V_C pin appears as various problems, including poor load regulation, subharmonic oscillation and instability. Thermal management must also be considered. The SO-8 package has a fused ground pin. Soldering this pin to a large copper area will significantly reduce its thermal resistance. Solder-filled feedthroughs close to the ground pin provide a good thermal path to the ground plane. For the DD package, the grounded tab should be treated in the same manner. For more information or advice, contact the LTC Applications department.

PCB LAYOUT AND FILM (DC355)

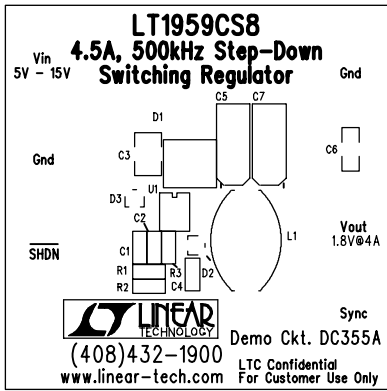

Component Side Silkscreen

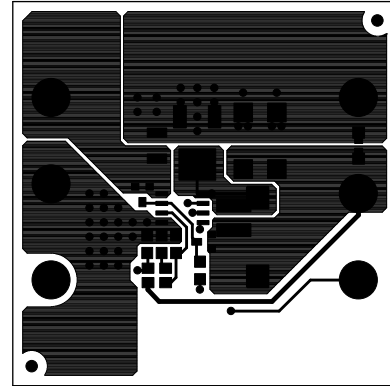

Component Side

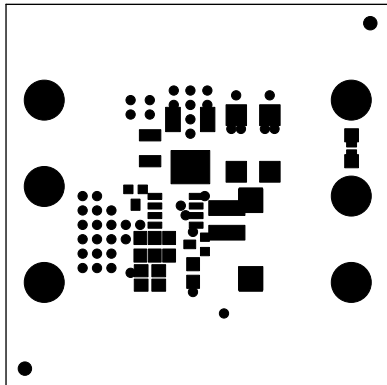

Component Side Solder Mask

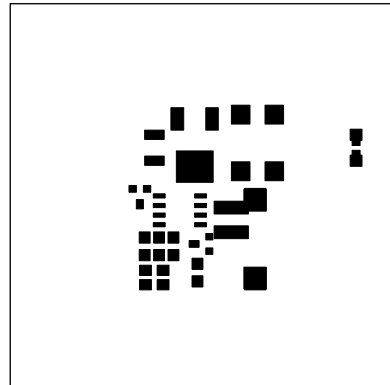

Component Side Paste Mask

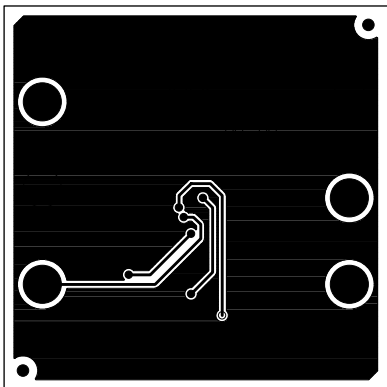

Solder Side

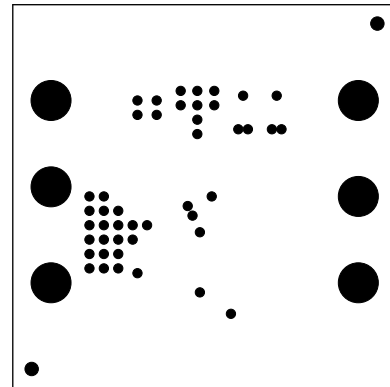

Solder Side Solder Mask

PCB LAYOUT AND FILM (DC356)

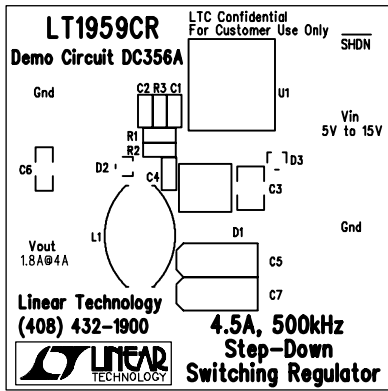

Component Side Silkscreen

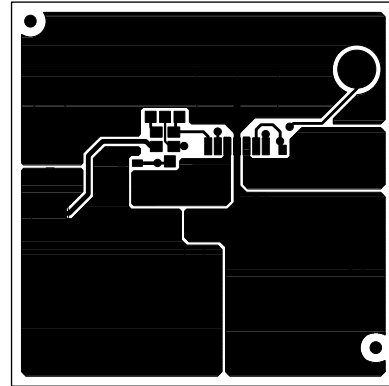

Component Side

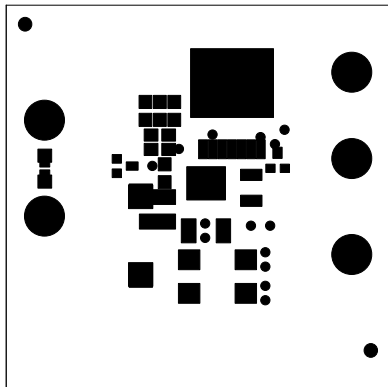

Component Side Solder Mask

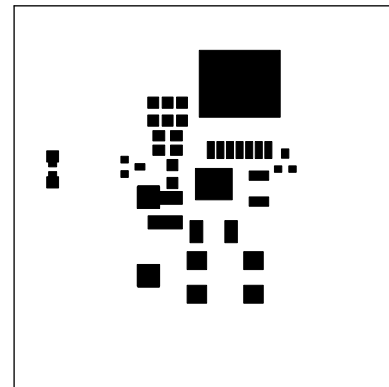

Component Side Paste Mask

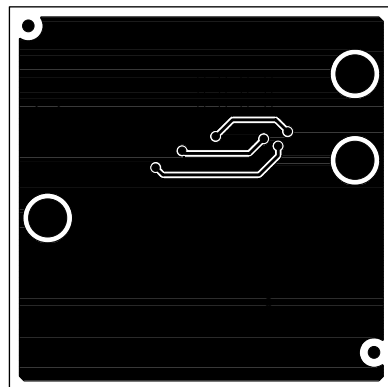

Solder Side

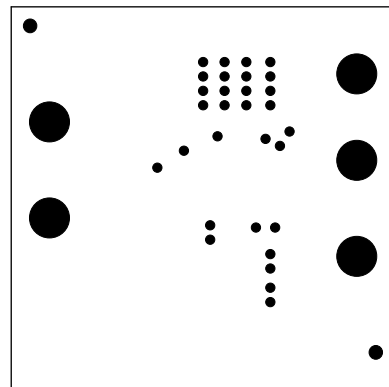

Solder Side Solder Mask

DEMO MANUAL DC355/DC356

NO-DESIGN SWITCHER

PC FAB DRAWINGS

DC355

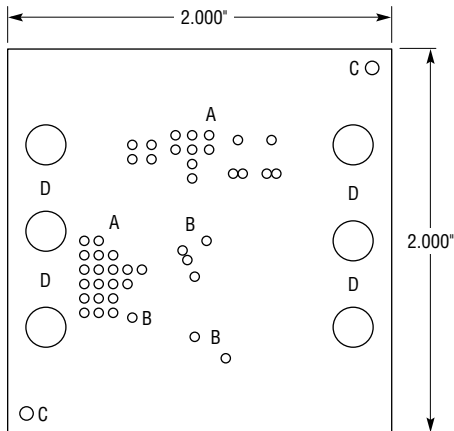

NOTES: UNLESS OTHERWISE SPECIFIED

1. MATERIAL: FR4 OR EQUIVALENT EPOXY, 2 OZ COPPER CLAD, THICKNESS 0.062 ±0.006 TOTAL OF 2 LAYERS
2. FINISH: ALL PLATED HOLES 0.001 MIN/0.0015 MAX COPPER PLATE, ELECTRODEPOSITED TIN-LEAD COMPOSITION BEFORE REFLOW, SOLDER MASK OVER BARE COPPER (SMOBC)
3. SOLDER MASK: BOTH SIDES USING SR1020 OR EQUIVALENT
4. SILKSCREEN: USING WHITE NONCONDUCTIVE EPOXY INK
5. ALL DIMENSIONS IN INCHES
6. SCORING

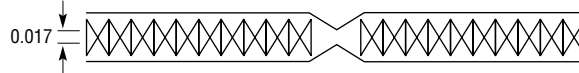

SYMBOL	DIAMETER	NUMBER OF HOLES
A	0.020	38
B	0.025	7
C	0.072	2
D	0.095	6
TOTAL HOLES		53

DC355 FD

DC356

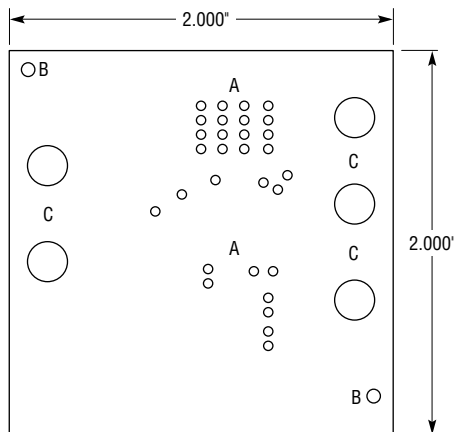

NOTES: UNLESS OTHERWISE SPECIFIED

1. MATERIAL: FR4 OR EQUIVALENT EPOXY, 2 OZ COPPER CLAD, THICKNESS 0.062 ±0.006 TOTAL OF 2 LAYERS
2. FINISH: ALL PLATED HOLES 0.001 MIN/0.0015 MAX COPPER PLATE, ELECTRODEPOSITED TIN-LEAD COMPOSITION BEFORE REFLOW, SOLDER MASK OVER BARE COPPER (SMOBC)
3. SOLDER MASK: BOTH SIDES USING GREEN SR1020 OR EQUIVALENT
4. SILKSCREEN: USING WHITE NONCONDUCTIVE EPOXY INK
5. ALL DIMENSIONS IN INCHES
6. SCORING

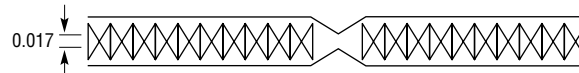

SYMBOL	DIAMETER	NUMBER OF HOLES
A	0.020	30
B	0.072	2
C	0.095	5
TOTAL HOLES		37

DC356 FD

5V to 15V
Input Range

1.8V at 4A
Output

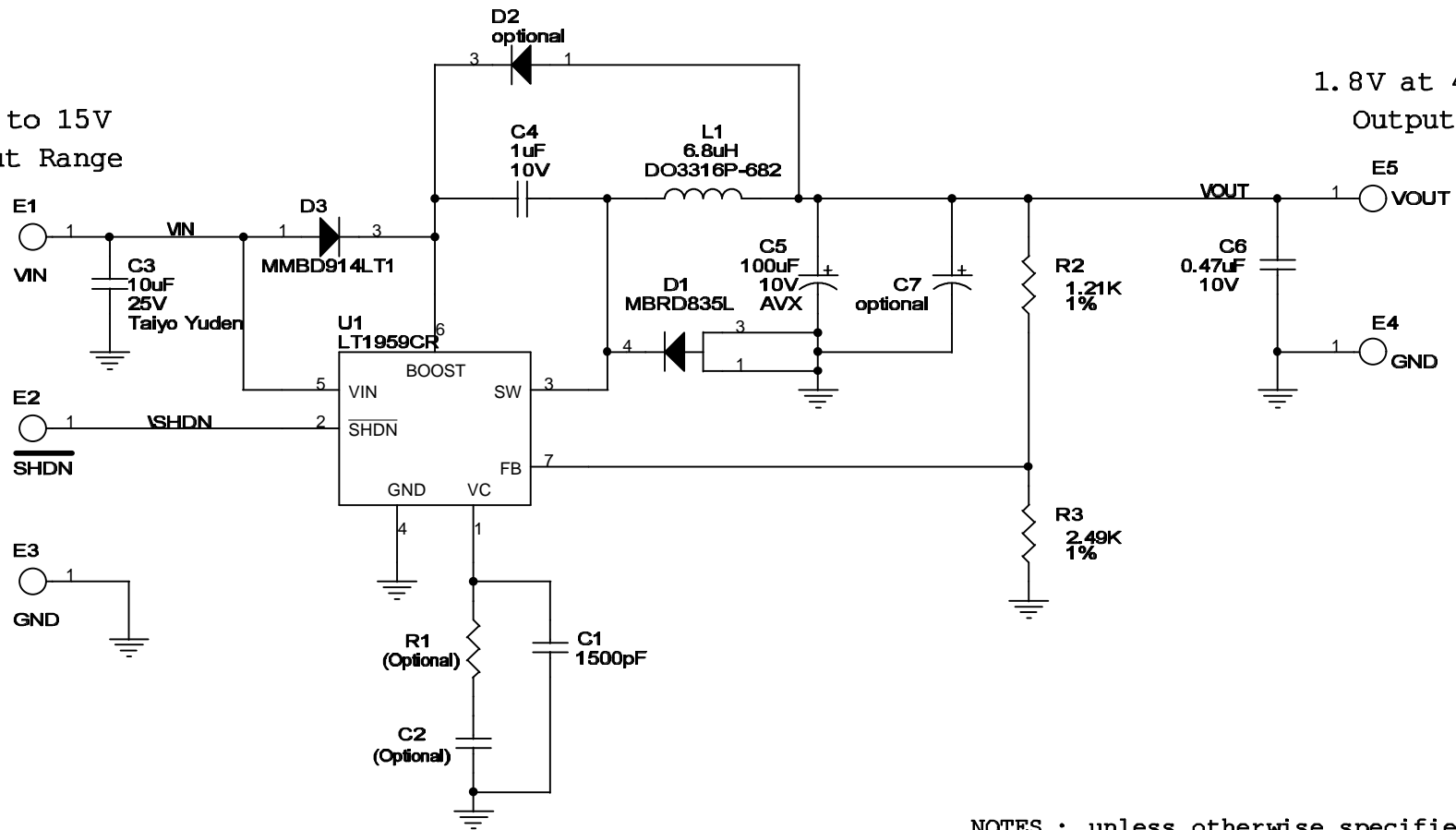

NOTES : unless otherwise specified

1. all resistors values in ohms , 1/8W , 5%
2. max. components 1.8mm high

LINEAR TECHNOLOGY CORPORATION

1630 McCARTHY BLVD.
MILPITAS, CA 95035
PHONE (408) 432-1900 FAX (408) 434 - 0507

Title

4.5A Switch, 500kHz Step-Down Regulator

Size
A

Document Number

DC356 (LT1959CR)

Rev
A

Date:

Sheet

1

1 of

6/16/2005

1:10 PM

Item	Qty	Reference	Part Description	Manufacture / Part #
1	0	C1	CAP., OPTIONAL	
2	1	C2	CAP., CHIP X7R .033uF 50V	AVX 08055C333MAT2S 0805
3	1	C3	CAP., CHIP Y5V 10uF 25V	TAIYOUDEN TMK325F106ZH 1210
4	1	C4	CAP., CHIP X7R 1uf 10V	AVX 0805ZC105MAT2S 0805
5	1	C5	CAP., TANT TPS 100uF 10V	AVX TPSD107M010R0065 CASE-D
6	1	C6	CAP., CHIP Y5V 0.47uF 10V	AVX 0603ZG474ZAT3S 0603
7	0	C7	CAP., OPTIONAL	
8	1	D1	DIODE, SMT MBRD835L	MOTOROLA MBRD835L DPAK
9	0	D2	DIODE, OPTIONAL	
10	1	D3	DIODE, 1N914	MOTOROLA MMBD914LT1 SOT23
11	6	E1-E6	TURRET, PAD	MILL-MAX 2501-2 PAD.092
12	1	R1	RES., CHIP 3.3K 1/8W 5%	AAC CR10-332JM 0805
13	1	R2	RES., CHIP 1.21K 1/8W 1%	AAC CR10-1211FM 0805
14	1	R3	RES., CHIP 2.49K 1/8W 1%	AAC CR10-2491FM 0805
15	1	L1	INDUCTOR, 6.8uH 20%	COILCRAFT DO3316P-682
16	1	U1	IC., LINEAR LT1959CR	LINEAR LT1959CR 7LEAD-DD
17	1		PRINTED CIRCUIT BOARD	DEMO BOARD DC356A
18	1		STENCIL	STENCIL DC356A