

LT3380

Multi-Output Power Management Solution with 4 Buck Switching and 3 LDO Linear Regulators with I²C

DESCRIPTION

DC2985A is a multi-output power management solution demonstration circuit, featuring the **LT[®]3380**. It contains two 2.5A, two 1.5A synchronous step-down DC/DC regulators and three 300mA LDO regulators.

All regulators can be enabled with external enable pins. After the first regulator is enabled, the remaining enable pins use a precision threshold to allow hardware-programmed Power-Up Sequence.

A micro-USB communication interface is integrated on board to allow software GUI to write or read the registers in LT3380 via its I²C serial port. This GUI can control regulator enables, power-down sequencing, output voltage levels, dynamic voltage scaling, operation modes, status reporting and other special functions.

Refer to LT3380 data sheet for more details on the electrical specifications and the setting of its command registers.

[Design files for this circuit board are available.](#)

All registered trademarks and trademarks are the property of their respective owners.

PERFORMANCE SUMMARY

Specifications are at T_A = 25°C

SYMBOL	PARAMETER	CONDITIONS	MIN	TYP	MAX	UNITS
V _{IN}	Input Voltage Range		2.7		5.5	V
V _{BUCK1}	BUCK1 Output Voltage	BUCK1 Enabled, I(BUCK1) = 0A ~ 2.5A		1.20		V
V _{BUCK2}	BUCK2 Output Voltage	BUCK2 Enabled, I(BUCK2) = 0A ~ 2.5A		1.50		V
V _{BUCK3}	BUCK3 Output Voltage	BUCK3 Enabled, I(BUCK3) = 0A ~ 1.5A		2.48		V
V _{BUCK4}	BUCK4 Output Voltage	BUCK4 Enabled, I(BUCK4) = 0A ~ 1.5A		1.81		V
V _{LDO1}	LDO1 Output Voltage	LDO1 Enabled, I(LDO1) = 0A ~ 300mA		1.20		V
V _{LDO2}	LDO2 Output Voltage	LDO2 Enabled, I(LDO2) = 0A ~ 300mA		0.80		V
V _{LDO3}	LDO3 Output Voltage	LDO3 Enabled, I(LDO3) = 0A ~ 300mA		1.80		V

BOARD PHOTO

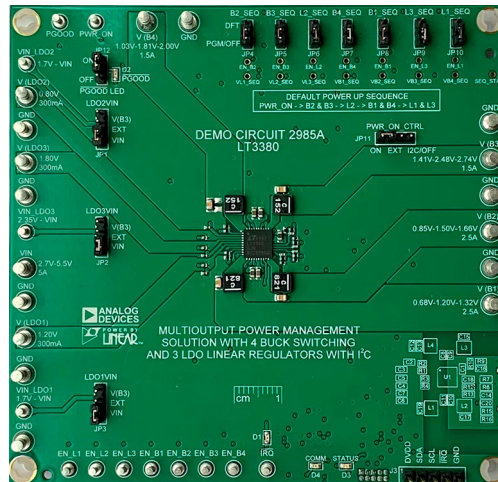
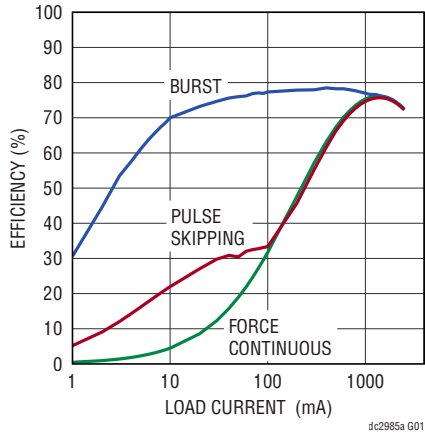

Figure 1. DC2985A Board Photo

EFFICIENCY CURVES

Specifications are at $T_A = 25^\circ\text{C}$, $f_{\text{SW}} = 2.25\text{MHz}$, $V_{\text{IN}} = 5\text{V}$, without D1

BUCK1 1.2V_{OUT} Efficiency



BUCK2 1.5V_{OUT} Efficiency

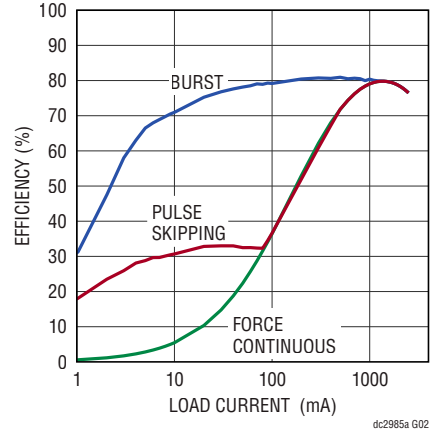

BUCK3 2.48V_{OUT} Efficiency

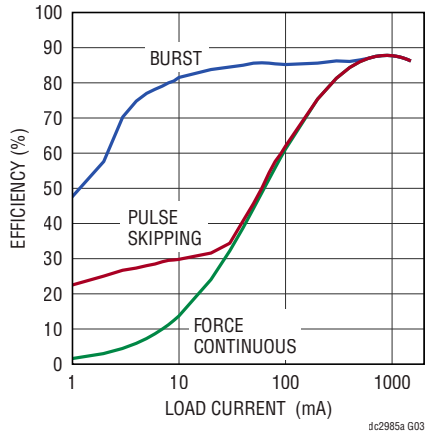

BUCK4 1.81V_{OUT} Efficiency

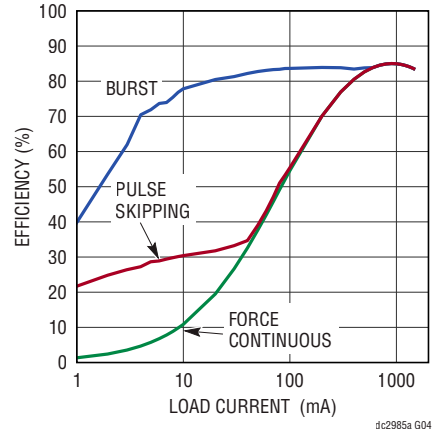

TRANSIENT RESPONSE Specifications are at $T_A = 25^\circ\text{C}$, $f_{\text{SW}} = 2.25\text{ MHz}$, $V_{\text{IN}} = 5\text{ V}$

BUCK1 1.2V_{OUT} Transient Response

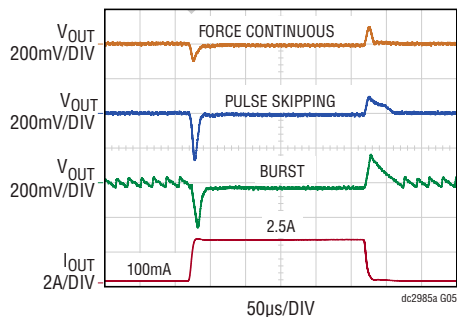

BUCK2 1.5V_{OUT} Transient Response

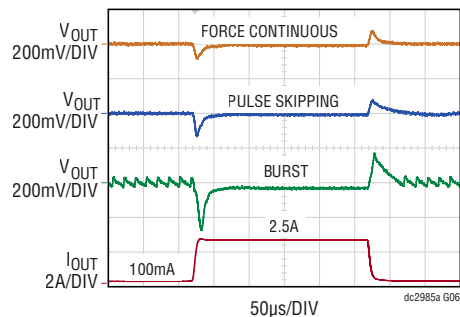

BUCK3 2.48V_{OUT} Transient Response

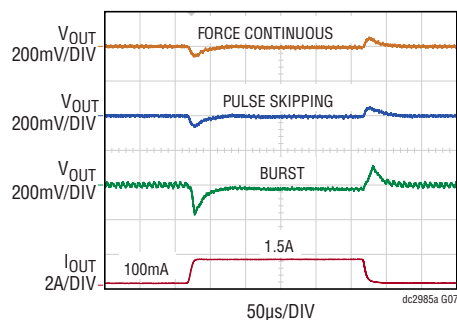

BUCK3 1.81V_{OUT} Transient Response

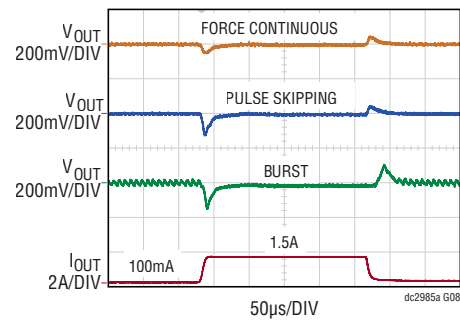

LD01-LD03 Transient Response

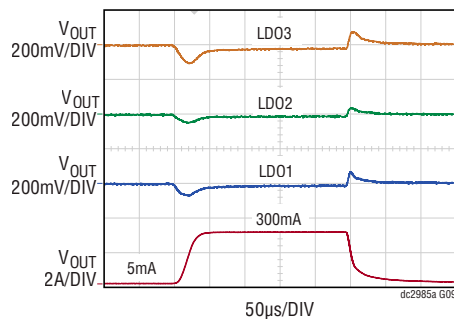

POWER UP SEQUENCE Specifications are at $T_A = 25^\circ\text{C}$, $f_{\text{SW}} = 2.25\text{MHz}$, $V_{\text{IN}} = 5\text{V}$, $I_{\text{OUT}} = 100\text{mA}$ for all regulators

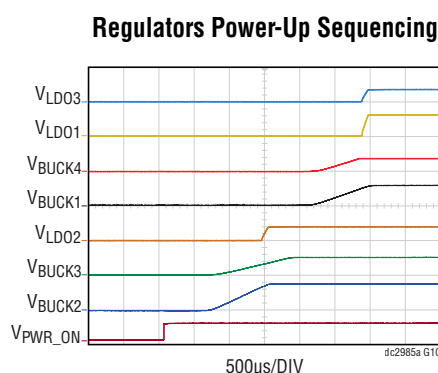

QUICK START PROCEDURE

Follow the procedure below to familiarize yourself with the DC2985A.

1. Refer to Figure 2, configure the jumpers on the demo board as follows:

JP1 = VIN

JP2 = VIN

JP3 = VIN

JP4-JP10 = DFT

JP11 = ON

JP13 = ON

2. Set PS1 to 5V, with 5A current limit. Turn on PS1. All the regulators should come up in a default sequence:

B2 & B3 -> L2 -> B1 & B4 -> L1 & L3

3. The PGOOD LED D2 should stay off, indicating all outputs are in regulation. Check the output voltage of all the regulators, they should read close to the following values:

$V_{VM1} = 1.2\text{V}$

$V_{VM2} = 1.5\text{V}$

$V_{VM3} = 2.48\text{V}$

$V_{VM4} = 1.81\text{V}$

$V_{VM5} = 1.2\text{V}$

$V_{VM6} = 0.8\text{V}$

$V_{VM7} = 1.8\text{V}$

4. Set each electronic load to its corresponding current level indicated in Figure 2. Turn on each load. The PGOOD LED D2 should stay off, indicating all the outputs are still in regulation under loads. Note that if there are not enough electronic loads for all the regulators, this test can be done sequentially.
5. Optional: The default input of the three LDOs are from VIN. To increase the efficiency, the LDOs can be powered from BUCK3 by configuring JP1 to JP3 to V(B3). They can also be powered from external source by configuring these jumpers to EXT.
6. Optional: The power up sequence can also be programmed by configuring JP4 to JP10 to PGM/OFF. Connect the SEQ_START to the EN_SEQ of the first regulators to power up. Then connect the subsequent regulators EN_SEQ to the corresponding VX_SEQ according to the desired startup sequence. If EN_SEQ of a regulator is not connected and the jumper is on PGM/OFF position, this regulator is turned off.

JUMPER DESCRIPTION

JUMPER	NAME	FUNCTION	POSITION	DESCRIPTION
JP1-JP3	LDO _x VIN	Input for the LDOs	V(B3)	Input from BUCK3
			EXT	Input from External Source Connected to VIN_LDO _x Turret
			VIN	Input from VIN Turret
JP4-JP10	B _x _SEQ or L _x _SEQ	Power Up Sequence for the Regulators	DFT	Default Power Up Sequence
			PGM/OFF	Programmed Sequence/Regulator Off
JP12	PGOOD_LED	Power On Master Enable and Disable Status Selection	ON	PWR_ON Allows Enable Pin Operation
			OFF	PWR_ON Inhibits Enable Pin Operation
JP13	PWR_ON_CTRL	Enable/Disable Power Good LED Indicator (Indicating Output not in Regulation)	ON	Power Good LED Indicator Enabled
			EXT	PWR_ON Status Controlled by External Source Connected to PWR_ON Turret
			OFF	Power Good LED Indicator Disabled

TEST SETUP

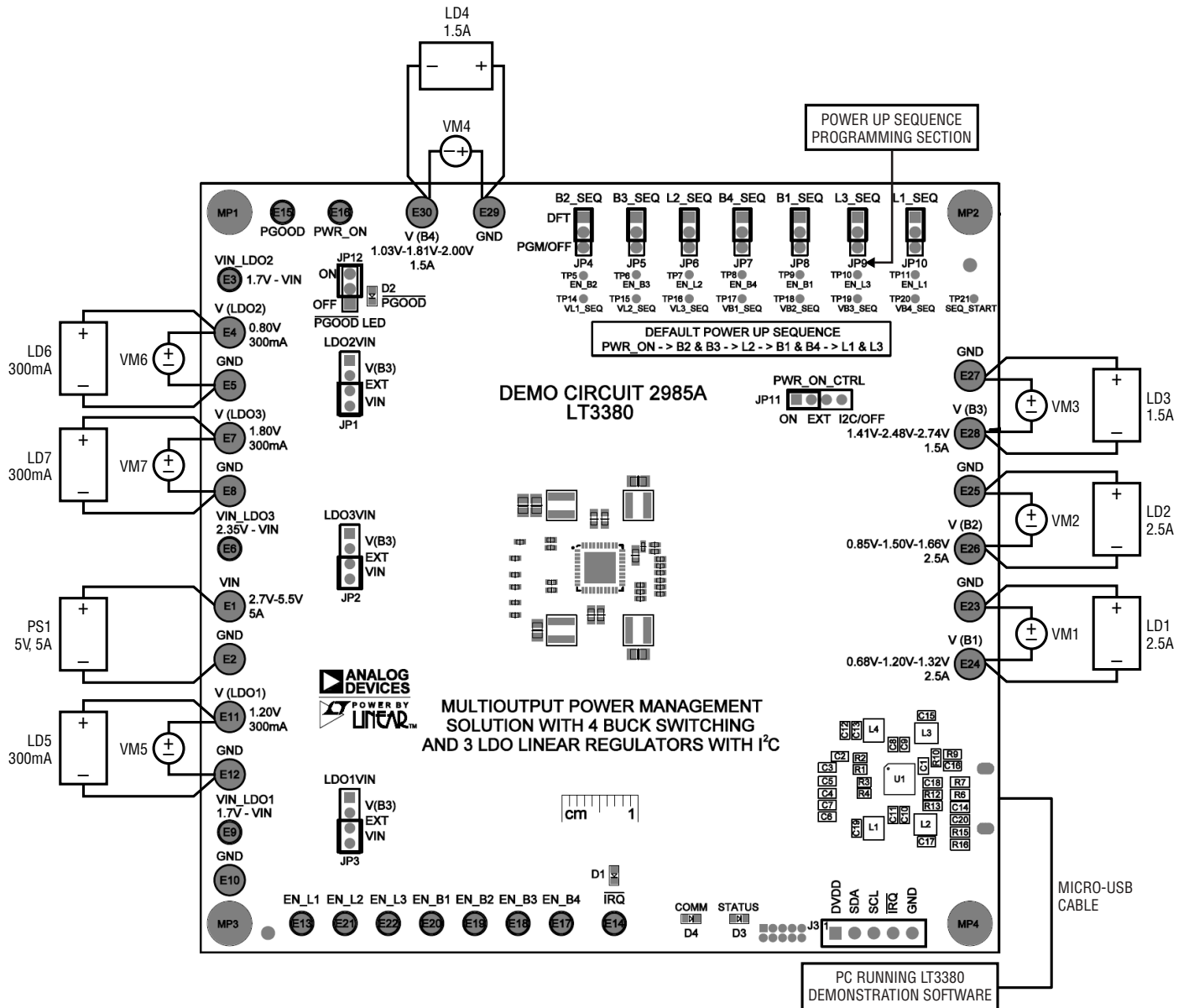

Figure 2. Test Setup for DC2985A Demo Board

DEMO CIRCUIT OPERATION

Introduction to the DC2984A

The DC2985A a multi-output power management solution with I²C interface featuring the LT3380. It contains four synchronous buck regulators and three LDO regulators. Among the four buck regulators, BUCK1 and BUCK2 deliver up to 2.5A output current, while BUCK3 and BUCK4 deliver up to 1.5A output current. All three LDOs deliver up to 300mA output current. BUCK1-BUCK4 have default output voltages of 1.2V, 1.5V, 2.48V and 1.81V, respectively. LDO1 and LDO2 have default output voltages of 1.2V and 0.8V respectively. These voltages are configured by voltage dividers on the corresponding FB pins and can be changed by the user. LDO3 has a fixed voltage of 1.8V.

The DC2985A also contains an isolated USB transceiver and a micro-controller, allowing computer-based software GUI to read/write the registers defined in the LT3380 via its I²C serial port. User can control regulator enables, power-down sequencing, output voltage levels, dynamic voltage scaling, operating modes and status reporting.

Power Up Sequencing

The LT3380 regulators can be powered up in any desired order by pin-strapping output rails to enable pins. The enable pins have a 0.75V (typical) input voltage threshold. If any enable is driven high, the remaining enable input thresholds switch to an 400mV threshold. There is a built-in 450µs delay from the enable pin threshold crossing to the internal enable of the regulator.

The DC2985A has a default power up sequence. User can also program the power up sequence by selecting JP4-JP10 to PGM/OFF position and connecting the output rails to the enable pins at the Power Up Sequence Programming Section shown in Figure 2. The start of the sequence is the rising edge of the PWR_ON pin. PWR_ON pin can be pulled up to VIN, pulled down to ground, or connected to an external command source by selection JP13, PWR_ON_CTRL jumper.

Figure 3 illustrates BUCKX voltage when BUCK1-BUCK4 is programmed to start in an ascending order. The demo board connection is shown as follows:

```

SEQ_START -> EN_B1_SEQ
VB1_SEQ -> EN_B2_SEQ
VB2_SEQ -> EN_B3_SEQ
VB3_SEQ -> EN_B4_SEQ
    
```

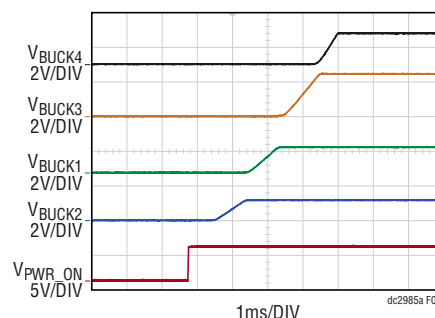

Figure 3. Program BUCK1-BUCK4 Power Up Sequence in Ascending Order

Regulator Enables

When JP4-JP10 is at PGM/OFF position, and no connection is made at the Power Up Sequence Programming Section, all the regulators are disabled. Each regulator can be individually enabled by its corresponding enable turret at the edge of the demo board.

LDO Input Selection

The default input of each LDO is the general input of the demo circuit, VIN. To reduce power loss of the LDOs, the input source of each LDO can be changed to the output of BUCK3 by connection corresponding LDOXVIN jumper to V(B3). Each LDO can also be powered externally by selecting the corresponding LDOXVIN jumper to EXT and connecting a separate source to VIN_LDOX turret. Note that the voltage of this external LDO source must not exceed voltage.

Power Good Indicator

Power Good LED D2 is turned on when PGOOD pin on LT3383 is pulled low. It indicates the one or more output voltages of the enabled regulators are low. It will also be on when no regulator is enabled.

USING LT3380 GUI

Install the LT3380 GUI

The LT3380 GUI can be downloaded from Analog.com or using QuickEval software. Double click the LT3380 GUI installer **ins3380.exe**. A window as shown in Figure 4 will pop up. Select **I accept the agreement** and then click **Next** to start the installation. The GUI application will be installed at the following location:

C:\Program Files (x86)\LTC\LT3380 GUI

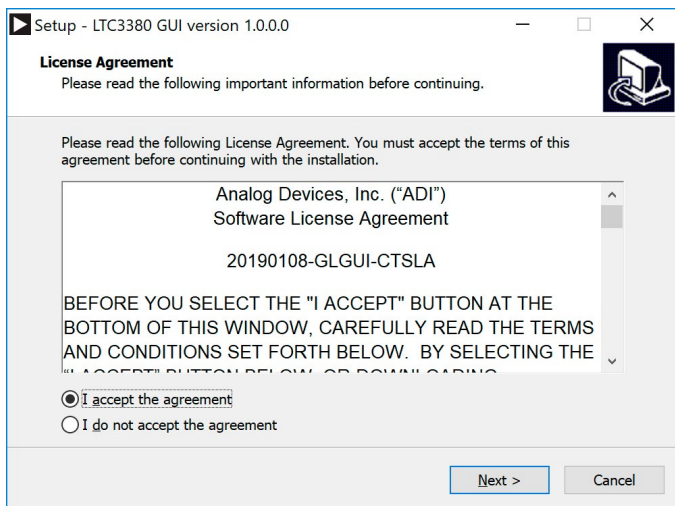

Figure 4. License Agreement Window in GUI Installation Process

When the software is successfully installed, a window as shown in Figure 5 will pop up. Click **Finish** to complete the installation.

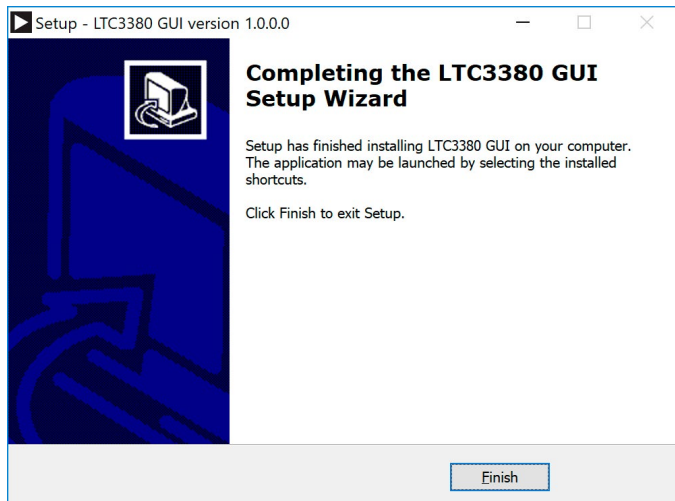

Figure 5. Completing Installation Window

Start the LT3380 GUI

The LT3380 GUI application should show up in the **Recently added** section when clicking the **Windows** button. Before starting the GUI, please make sure that DC2985A is connected to the PC with micro-USB cable. Click **LT3380 GUI** to start the GUI application. If **LT3380 GUI** cannot be found in the **Recently added** section, go to the **LTC3380 GUI** folder and double click **em.3380.exe** to start the GUI.

If DC2985A is powered up and successfully connected to the PC with a micro-USB cable, the **Dashboard** of the GUI will pop up, as shown in Figure 6

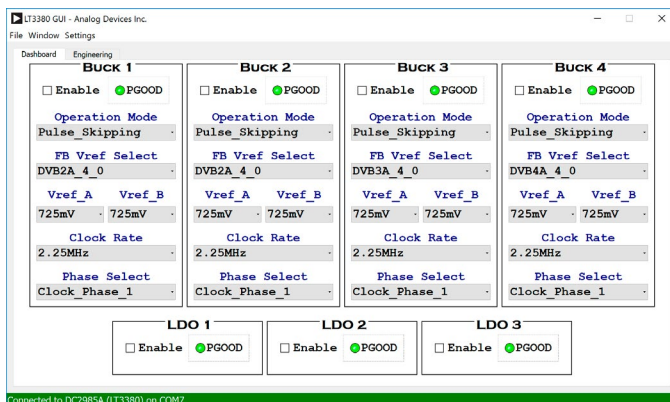

Figure 6. LT3380 GUI Dashboard Tab

In this **Dashboard** tab, user can control the basic setups of the regulators.

To get access to all the registers and change some advanced setups of the regulators, click the **Engineering** tab next to the **Dashboard** tab. Figure 7 shows the LT3380 **Engineering** tab.

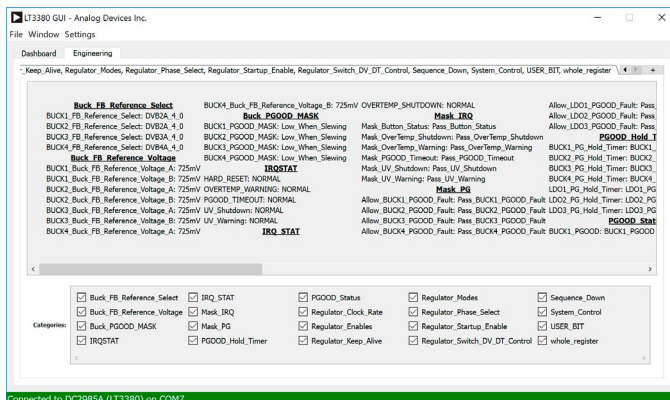

Figure 7. LT3380 GUI Engineering Tab

USING LT3380 GUI

To change the register setup, right click on the register, and click **Write Preset**, then select the desired register status. Figure 8 shows an example of setting the register to mask overtemperature warning.

The default setting of the **Engineering** tab is reading the registers continuously. User can change this setting by right click in the main window. User can also hide the registers that are not used by clicking the checkbox in the **Categories** section. Detailed description for all the features in the GUI is in **Window -> Show Help Guide** on the top left corner of the GUI.

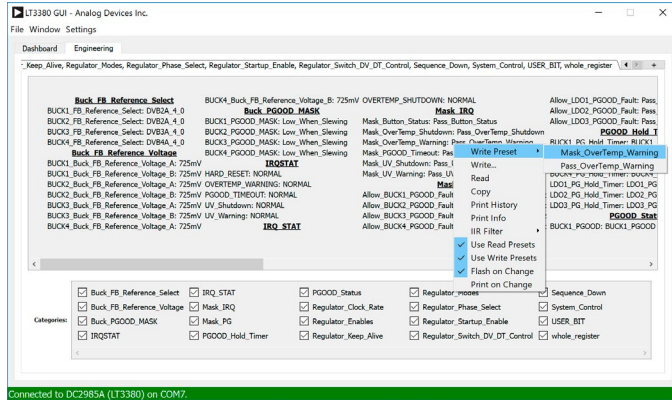

Figure 8. Changing Register Setup in Engineering Tab

PARTS LIST

ITEM	QTY	REFERENCE	PART DESCRIPTION	MANUFACTURER/PART NUMBER
Required Circuit Components				
1	5	C1, C8-C11	CAP., 10 μ F, X5R, 10V, 20%, 0603, AEC-Q200	TAIYO YUDEN, LMK107BBJ106MAHT
2	6	C2-C7	CAP., 1 μ F, X5R, 25V, 10%, 0402, AEC-Q200	MURATA, GRT155R61E105KE01D
3	4	C12, C15, C17, C19	CAP., 47 μ F, X5R, 6.3V, 20%, 0805, AEC-Q200	MURATA, GRT21BR60J476ME13L
4	4	C14, C16, C18, C20	CAP., 10 μ F, C0G, 50V, 5%, 0402, AEC-Q200	MURATA, GCM1555C1H100JA16D
5	1	C21	CAP., 0.1 μ F, X7R, 16V, 10%, 0402, AEC-Q200	MURATA, GCM155R71C104KA55D
6	2	L1, L2	IND., 0.82 μ H, PWR, 20%, AEC-Q200	COILCRAFT, XGL4020-821MEC
7	2	L3, L4	IND., 1.5 μ H, PWR, 20%, AEC-Q200	COILCRAFT, XGL4020-152MEC
8	2	Q1, Q2	XSTR., NPN, 40V, 200MA, SOT23-3	ON SEMICONDUCTOR, MMBT3904LT1G
9	1	R1	RES., 102k, 1%, 1/16W, 0402, AEC-Q200	STACKPOLE ELECTRONICS, INC., RMCF0402FT102K
10	6	R2, R4, R6, R9, R13, R16		
11	2	R3, R15	RES., 649k, 1%, 1/16W, 0402	NIC, NRC04F6493TRF
12	4	R5, R8, R11, R14	RES., 20 Ω , 1%, 1/16W, 0402, AEC-Q200	NIC, NRC04F20R0TRF
13	1	R7	RES., 665k, 1%, 1/16W, 0402, AEC-Q200	NIC, NRC04F6653TRF
14	1	R10	RES., 412k, 1%, 1/16W, 0402	NIC, NRC04F4123TRF
15	1	R12	RES., 1.07M, 1%, 1/16W, 0402, AEC-Q200	VISHAY, CRCW04021M07FKED
16	10	R17, R18, R20-R26, R76	RES., 10k, 5%, 1/16W, 0402, AEC-Q200	NIC, NRC04J103TRF
17	2	R27, R28	RES., 4.7k, 5%, 1/16W, 0402, AEC-Q200	NIC, NRC04J472TRF
18	2	R30, R31	RES., 1k, 5%, 1/16W, 0402, AEC-Q200	NIC, NRC04J102TRF
19	8	R33-R39, R61	RES., 10k, 1%, 1/16W, 0402, AEC-Q200	VISHAY, CRCW040210K0FKED
20	7	R40-R46	RES., 10k, 1%, 1/10W, 0603, AEC-Q200	PANASONIC, ERJ3EKF1002V
21	7	R54-R60	RES., 5.11M, 1%, 1/10W, 0603, AEC-Q200	VISHAY, CRCW06035M11FKED
22	2	R62, R75	RES., 100k, 5%, 1/16W, 0402, AEC-Q200	NIC, NRC04J104TRF
23	1	U1	IC, MULTI-OUTPUT POWER, 40-PIN	ANALOG DEVICES, LT3380EUJM
Additional Demo Board Circuit Components				
1	2	C22, C23	CAP., 22 μ F, NP0, 50V, 5%, 0402	WURTH ELEKTRONIK, 885012005057
2	2	C24, C31	CAP., 1 μ F, JB, 10V, 20%, 0402	TDK, CGB2A1JB1A105M033BC
3	1	C25	CAP., 2.2 μ F, X5R, 10V, 20%, 0402	WURTH ELEKTRONIK, 885012105013
4	1	C26	CAP., 10 μ F, X5R, 6.3V, 20%, 0603	MURATA, GRM188R60J106ME47D
5	4	C27-C30	CAP., 0.1 μ F, X5R, 10V, 20%, 0402	WURTH ELEKTRONIK, 885012105010
6	1	C32	CAP., 0.01 μ F, X7R, 25V, 10%, 0402	WURTH ELEKTRONIK, 885012205050
7	2	D1, D2	LED, RED, WATER CLEAR, 0603	WURTH ELEKTRONIK, 150060RS75000
8	1	D3	LED, BRIGHT GREEN, WATERCLEAR, 0603	WURTH ELEKTRONIK, 150060VS75000
9	1	D4	LED, YELLOW, WATERCLEAR, 0603	WURTH ELEKTRONIK, 150060YS75000
10	1	L5	IND., CHIP BEAD, 6A, 0.01 Ω , L-MPZ2012	TDK, MPZ2012S300AT000
11	3	M1-M3	XSTR., MOSFET, DUAL N-CH, 0.28A, SOT-563	DIODES INC., 2N7002VAC-7

PARTS LIST

ITEM	QTY	REFERENCE	PART DESCRIPTION	MANUFACTURER/PART NUMBER
12	3	R71, R72, R74	RES., 4.7k, 5%, 1/16W, 0402, AEC-Q200	NIC, NRC04J472TRF
13	1	R63	RES., 115k, 1%, 1/10W, 0603	NIC, NRC06F1153TRF
14	1	R64	RES., 1 Ω , 5%, 1/16W, 0402, AEC-Q200	KOA SPEER, RK73B1ETTP1R0J
15	3	R65-R67	RES., 301 Ω , 1%, 1/10W, 0603, AEC-Q200	PANASONIC, ERJ3EKF3010V
16	2	R68, R69	RES., 2.2k, 5%, 1/16W, 0402, AEC-Q200	VISHAY, CRCW04022K20JNED
17	1	R70	RES., 1M, 5%, 1/16W, 0402, AEC-Q200	VISHAY, CRCW04021M00JNED
18	1	R73	RES., 10k, 5%, 1/16W, 0402	SAMSUNG, RC1005J103CS
19	1	U2	IC, USB 2.0 μ Module TRANSCEIVER, BGA-44	ANALOG DEVICES, LTM2884CY
20	1	U3	IC, MEMORY, MCU, 32BIT, 256KB FLASH, TQFP48	MICROCHIP, ATSAM21G18A-AUT
21	1	U4	IC, REG LDO ADJ, 100mA, TSOT23-5	ANALOG DEVICES, LT1761ES5-BYP
22	1	Y1	CRYSTAL, 32.768kHz, 12.5pF, 3.2x1.5mm SMD	ABRACON, ABS07-32.768KHZ-4-T

Hardware: For Demo Board Only

1	17	E1, E2, E4, E5, E7, E8, E10-E12, E23-E30	TEST POINT, TURRET, 0.094" MTG. HOLE, PCB 0.062" THICK	MILL-MAX, 2501-2-00-80-00-00-07-0
2	13	E3, E6, E9, E13-E22	TEST POINT, TURRET, 0.064" MTG. HOLE, PCB 0.062" THICK	MILL-MAX, 2308-2-00-80-00-00-07-0
3	1	J1	CONN., μ USB 2.0, RCPT., 5-PIN, 1PORT, REVERSE MOUNT, R/A HORZ., TYPE B, FLANGELESS	TE CONNECTIVITY, 1932788-1
4	1	J2	CONN., HDR, MALE, 2x5, 1.27mm, VERT, ST, THT	WURTH ELEKTRONIK, 62201021121
5	1	J3	CONN., HDR, MALE, 1x5, 2.54mm, VERT, ST, THT	SAMTEC, TSW-105-07-L-S
6	4	JP1-JP3, JP11	CONN., HDR., MALE, 1x4, 2mm, THT, STR	SULLINS CONNECTOR SOLUTIONS,
7	8	JP4-JP10, JP12	CONN., HDR, MALE, 1x3, 2mm, VERT, STR, THT	WURTH ELEKTRONIK, 62000311121
8	4	MP1-MP4	STANDOFF, NYLON, SNAP-ON, 0.25" (6.4mm)	KEYSTONE, 8831
9	12	XJP1-XJP12	CONN., SHUNT, FEMALE, 2 POS, 2mm	WURTH ELEKTRONIK, 60800213421

SCHEMATIC DIAGRAM

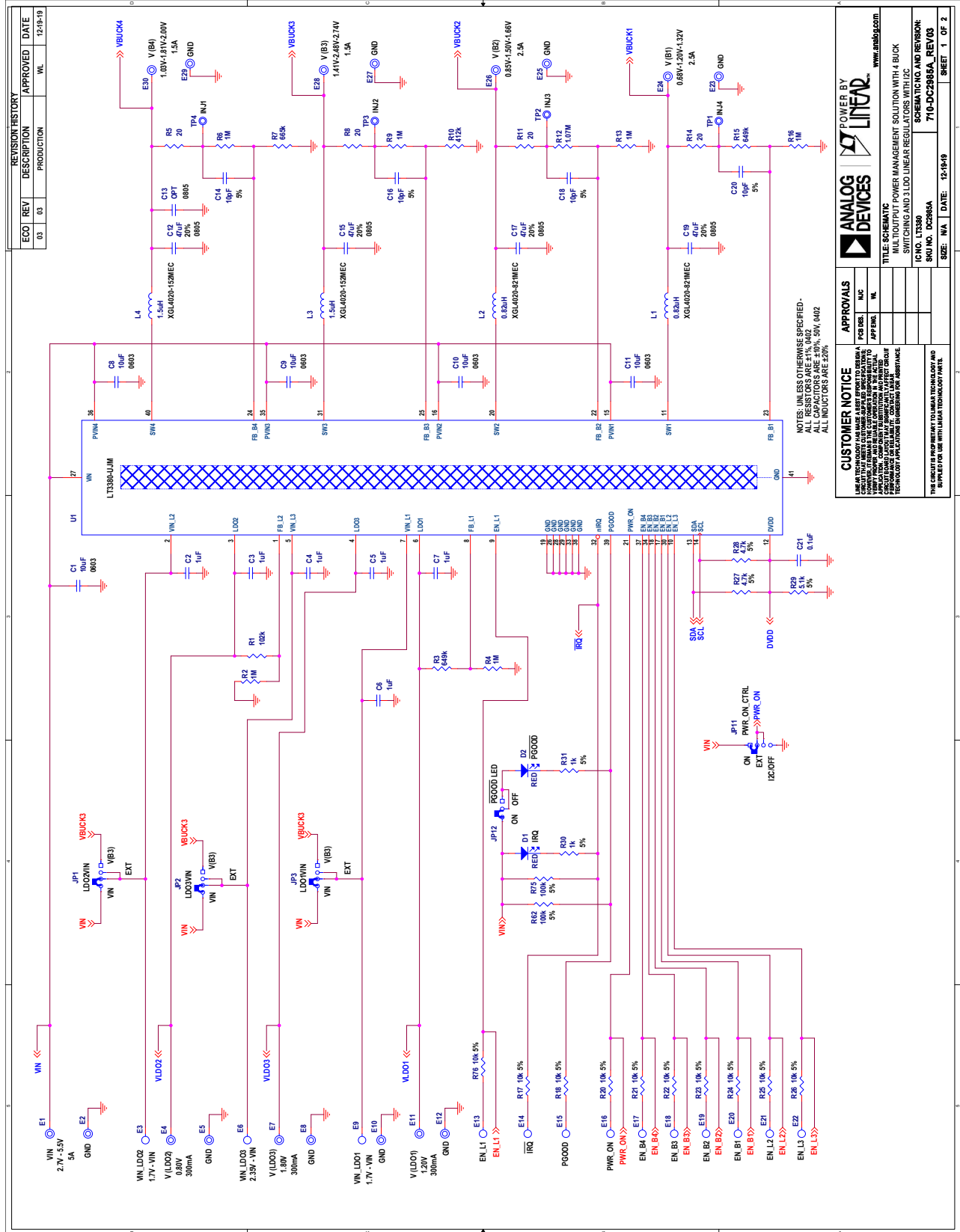

SCHEMATIC DIAGRAM

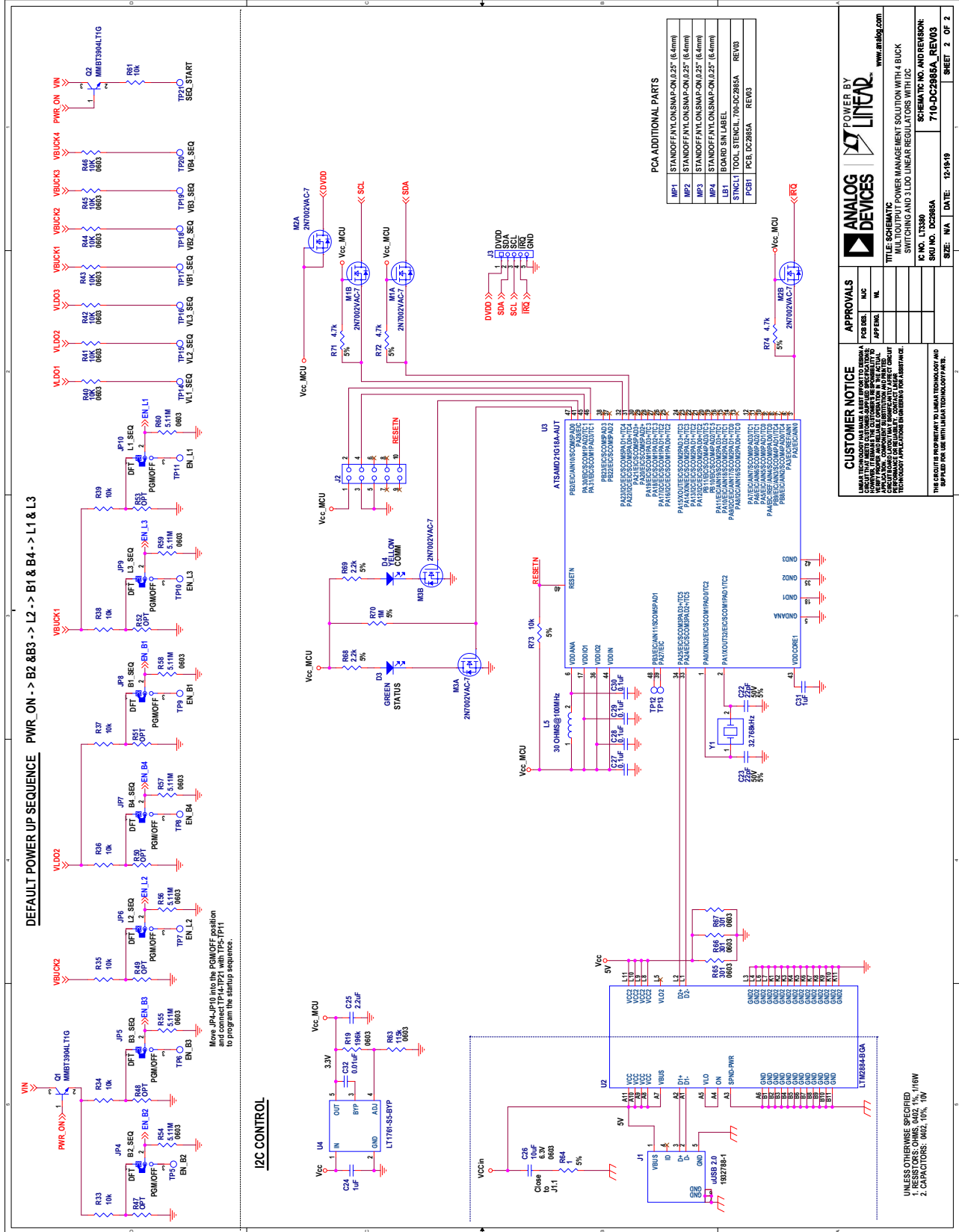

CUSTOMER NOTICE

LINEAR TECHNOLOGY HAS MADE A GREAT EFFORT TO DESIGN A COMPLETE, TURNKEY SOLUTION TO MEET YOUR REQUIREMENTS. IT IS THE CUSTOMER'S RESPONSIBILITY TO VERIFY THE APPLICATION, COMPONENT SELECTION AND THE PERFORMANCE OF THE SOLUTION IN THEIR SPECIFIC APPLICATION. CUSTOMER SUPPORT IS AVAILABLE THROUGH THE ONLINE SUPPORT CENTER.

APPROVALS

DESIGN	DATE
APP'G	DATE
CHK	DATE
APP'V	DATE

ANALOG DEVICES POWER BY **LINEAR**

TITLE: SCHEMATIC
 MULTITRACK POWER MANAGEMENT SOLUTION WITH 4-BUCK SWITCHING AND 3 LDO LINEAR REGULATORS WITH I2C

IC NO. LT13380
 SCHEMATIC NO. AND REV'NO: 710-DC2985A_REV03

SKU NO. DC2985A
 DATE: 12-18-19
 SHEET 2 OF 2

THIS CIRCUIT IS PROPRIETARY TO LINEAR TECHNOLOGY AND SUPPLIED FOR USE WITH LINEAR TECHNOLOGY PARTS.



ESD Caution

ESD (electrostatic discharge) sensitive device. Charged devices and circuit boards can discharge without detection. Although this product features patented or proprietary protection circuitry, damage may occur on devices subjected to high energy ESD. Therefore, proper ESD precautions should be taken to avoid performance degradation or loss of functionality.

Legal Terms and Conditions

By using the evaluation board discussed herein (together with any tools, components documentation or support materials, the "Evaluation Board"), you are agreeing to be bound by the terms and conditions set forth below ("Agreement") unless you have purchased the Evaluation Board, in which case the Analog Devices Standard Terms and Conditions of Sale shall govern. Do not use the Evaluation Board until you have read and agreed to the Agreement. Your use of the Evaluation Board shall signify your acceptance of the Agreement. This Agreement is made by and between you ("Customer") and Analog Devices, Inc. ("ADI"), with its principal place of business at One Technology Way, Norwood, MA 02062, USA. Subject to the terms and conditions of the Agreement, ADI hereby grants to Customer a free, limited, personal, temporary, non-exclusive, non-sublicensable, non-transferable license to use the Evaluation Board FOR EVALUATION PURPOSES ONLY. Customer understands and agrees that the Evaluation Board is provided for the sole and exclusive purpose referenced above, and agrees not to use the Evaluation Board for any other purpose. Furthermore, the license granted is expressly made subject to the following additional limitations: Customer shall not (i) rent, lease, display, sell, transfer, assign, sublicense, or distribute the Evaluation Board; and (ii) permit any Third Party to access the Evaluation Board. As used herein, the term "Third Party" includes any entity other than ADI, Customer, their employees, affiliates and in-house consultants. The Evaluation Board is NOT sold to Customer; all rights not expressly granted herein, including ownership of the Evaluation Board, are reserved by ADI. CONFIDENTIALITY. This Agreement and the Evaluation Board shall all be considered the confidential and proprietary information of ADI. Customer may not disclose or transfer any portion of the Evaluation Board to any other party for any reason. Upon discontinuation of use of the Evaluation Board or termination of this Agreement, Customer agrees to promptly return the Evaluation Board to ADI. ADDITIONAL RESTRICTIONS. Customer may not disassemble, decompile or reverse engineer chips on the Evaluation Board. Customer shall inform ADI of any occurred damages or any modifications or alterations it makes to the Evaluation Board, including but not limited to soldering or any other activity that affects the material content of the Evaluation Board. Modifications to the Evaluation Board must comply with applicable law, including but not limited to the RoHS Directive. TERMINATION. ADI may terminate this Agreement at any time upon giving written notice to Customer. Customer agrees to return to ADI the Evaluation Board at that time. LIMITATION OF LIABILITY. THE EVALUATION BOARD PROVIDED HEREUNDER IS PROVIDED "AS IS" AND ADI MAKES NO WARRANTIES OR REPRESENTATIONS OF ANY KIND WITH RESPECT TO IT. ADI SPECIFICALLY DISCLAIMS ANY REPRESENTATIONS, ENDORSEMENTS, GUARANTEES, OR WARRANTIES, EXPRESS OR IMPLIED, RELATED TO THE EVALUATION BOARD INCLUDING, BUT NOT LIMITED TO, THE IMPLIED WARRANTY OF MERCHANTABILITY, TITLE, FITNESS FOR A PARTICULAR PURPOSE OR NON-INFRINGEMENT OF INTELLECTUAL PROPERTY RIGHTS. IN NO EVENT WILL ADI AND ITS LICENSORS BE LIABLE FOR ANY INCIDENTAL, SPECIAL, INDIRECT, OR CONSEQUENTIAL DAMAGES RESULTING FROM CUSTOMER'S POSSESSION OR USE OF THE EVALUATION BOARD, INCLUDING BUT NOT LIMITED TO LOST PROFITS, DELAY COSTS, LABOR COSTS OR LOSS OF GOODWILL. ADI'S TOTAL LIABILITY FROM ANY AND ALL CAUSES SHALL BE LIMITED TO THE AMOUNT OF ONE HUNDRED US DOLLARS (\$100.00). EXPORT. Customer agrees that it will not directly or indirectly export the Evaluation Board to another country, and that it will comply with all applicable United States federal laws and regulations relating to exports. GOVERNING LAW. This Agreement shall be governed by and construed in accordance with the substantive laws of the Commonwealth of Massachusetts (excluding conflict of law rules). Any legal action regarding this Agreement will be heard in the state or federal courts having jurisdiction in Suffolk County, Massachusetts, and Customer hereby submits to the personal jurisdiction and venue of such courts. The United Nations Convention on Contracts for the International Sale of Goods shall not apply to this Agreement and is expressly disclaimed.