

DESCRIPTION

Demonstration circuit 533 is an 800kHz adjustable output boost regulator featuring the LT3436.

This current-mode control monolithic (switch included) converter has a wide operating supply voltage of 3V to 25V, a minimum peak switch current rating of 3A, and a low resistance 0.1Ω power switch. The switch current limit is constant at all duty cycles. The small TSSOP 16-pin exposed leadframe package is optimal for high power in a tiny space with excellent heat dissipation capabilities.

The small size and wide input voltage of the LT3436 are demonstrated by the 3.2V–12V input to 12V output boost converter. The maximum output current varies with respect to the input voltage as shown in Figure 2. The circuit is optimized for 5V input to 12V output. Compensation components are designed for stable operation over the entire input voltage range 3.2V–12V input for this 12V output application. Adjustable feedback resis-

tors allow simple customization of the output voltage. Stability and transient response can be further optimized by choosing different compensation components for small input voltage ranges such as $5V_{IN} \pm 10\%$ or $3.6V_{IN}$ to $5.4V_{IN}$. The high 800kHz switching frequency allows the use of tiny ceramic input and output capacitors as well as a very small inductor, making tiny and low cost boost converter solutions possible. High switching frequency results in lower output voltage ripple than lower frequency converters. Shutdown and synchronization terminals provide more options for battery-powered devices and systems with higher frequency requirements.

Additional pads on the demonstration circuit are available for SEPIC applications. Please see the *BUILDING A SEPIC* section below for details.

Design files for this circuit board are available. Call the LTC factory.

Table 1. Typical Performance Summary (T_A = 25°C)

PARAMETER	CONDITION	VALUE
Input Voltage Range (V _{IN})	V _{OUT} = 12V	3.2V to 12V
Output Voltage (V _{OUT})	3.2V ≤ V _{IN} ≤ 12V	12V ± 3%
Maximum Output Current	V _{IN} = 3.3V, V _{OUT} = 12V, I _{SW(PK)} = 3A	550mA
	V _{IN} = 5V, V _{OUT} = 12V, I _{SW(PK)} = 3A	900mA
	V _{IN} = 8V, V _{OUT} = 12V, I _{SW(PK)} = 3A	1550mA
	V _{IN} = 10V, V _{OUT} = 12V, I _{SW(PK)} = 3A	2050mA
Switching Frequency		800kHz
Efficiency	V _{IN} = 5V, V _{OUT} = 12V, I _{OUT} = 900mA	83.4%
Output Voltage Ripple (measured at C _{OUT})	V _{IN} = 5V, V _{OUT} = 12V, I _{OUT} = 900mA	160mV _{P-P}
Circuit Shutdown Supply Current	V _{IN} = 3.3V, $\overline{\text{SHDN}} = 0\text{V}$	42μA
	V _{IN} = 5V, $\overline{\text{SHDN}} = 0\text{V}$	60μA
	V _{IN} = 8V, $\overline{\text{SHDN}} = 0\text{V}$	90μA

QUICK START PROCEDURE

Demonstration circuit 533 is easy to set up to evaluate the performance of the LT3436. Refer to Figure 1 for proper measurement equipment setup and follow the procedure below:

NOTE: Make sure that the input voltage does not exceed 12V.

NOTE: The synchronization and shutdown functions are optional and their pins can be left floating (disconnected) if their functions are not being used.

NOTE: Connect the power supply (with power off), load, and meters as shown in Figure 1.

1. After all connections are made, turn on input power and verify that the output voltage is 12V.

NOTE: If the output voltage is too low, temporarily disconnect the load to make sure that the load is not set too high.

2. Once the proper output voltage is established, adjust the load within the operating range and observe the output voltage regulation, ripple voltage, efficiency and other parameters.

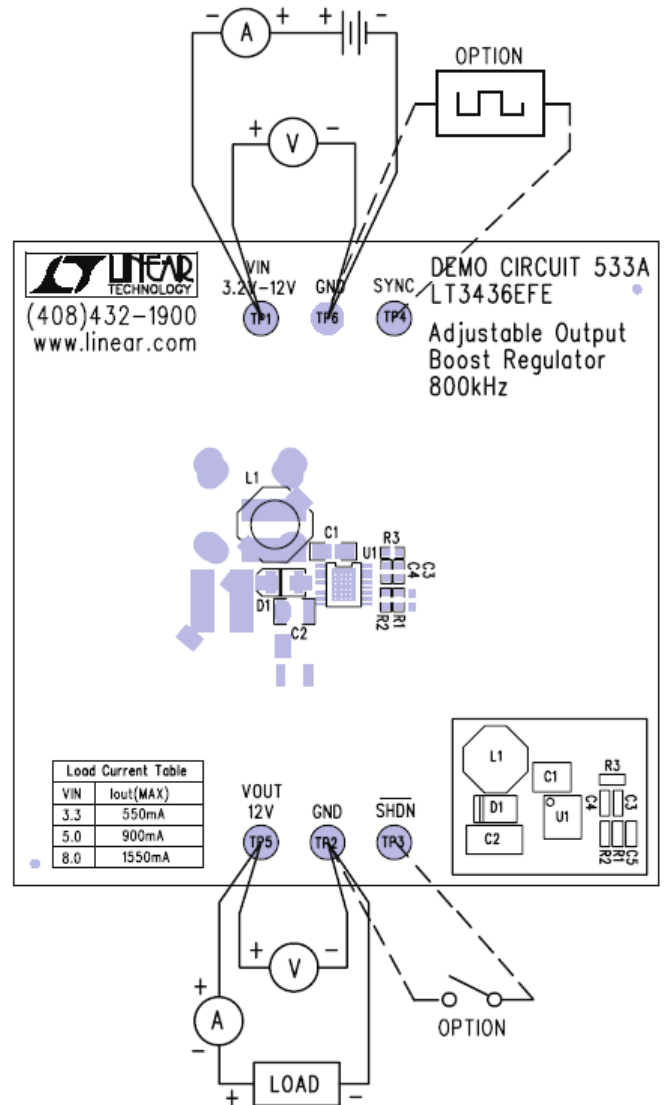

Figure 1. Proper Measurement Equipment Setup

FUNCTIONS & OPTIONS

OUTPUT VOLTAGE

The components assembled on the board are optimized for a wide input voltage range and a 12V output. The feedback resistors (R1, R2) can be

changed to adjust the output voltage according to the following equation:

$$V_{OUT} = 1.2 \times (1 + R1/R2)$$

SHUTDOWN AND UNDERVOLTAGE LOCKOUT

The $\overline{\text{SHDN}}$ pin is directly connected to its terminal and left floating for normal operation. However, connecting the terminal to GND will place the IC in shutdown. In shutdown, the IC will typically only consume $6\mu\text{A}$, but the output voltage will not drop to zero volts. Its voltage will remain approximately equal to the input voltage and will continue to provide power to whatever load is present through the direct path of the inductor and catch diode from V_{IN} .

For undervoltage lockout, the two-resistor divider network must be placed between V_{IN} and $\overline{\text{SHDN}}$ and between $\overline{\text{SHDN}}$ and GND. Please see the data sheet section '*Shutdown Functions and Undervoltage Lockout*' for more details on resistor values and application examples.

SYNCHRONIZATION

The synchronization frequency range for the LT3436 is 960kHz to 1.4MHz. Use a logic level

sync signal with a duty cycle between 10% and 90% connected directly to the SYNC terminal. Keep in mind that synchronization at high frequencies may reduce the effect of slope compensation. High sync frequencies combined with high duty cycles (above 50%) may result in unexpected loop instability. An increase in inductance or new compensation values may help overcome this instability at high frequencies.

COMPENSATION

DC533 has a frequency compensation network that is optimized for the ceramic output capacitor C2, the wide input voltage range of 3.2V to 12V, and 12V output. Improved loop bandwidth can be achieved for various output voltages, output capacitors, and input voltage ranges by adjusting R3, C3 and C4. A feedforward capacitor (C5) can be placed in parallel with R1 in the location shown in Figure 15 for an extra zero in the control loop. The use of alternate output capacitors may require changes to the compensation components for optimized loop stability. For more information, see the '*Frequency Compensation*' section in the datasheet, Application Note 19, or Application Note 76.

QUICK START GUIDE FOR DEMONSTRATION CIRCUIT 533

ADJUSTABLE OUTPUT BOOST REGULATOR 800KHZ

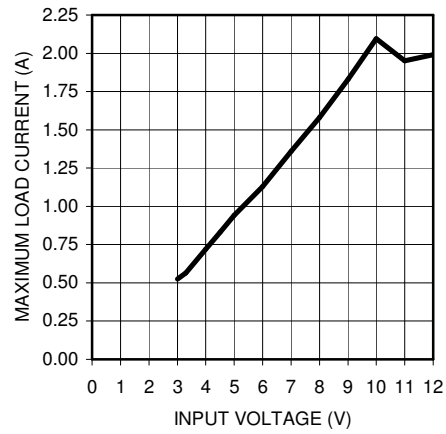

Figure 2. Maximum load current increases with input voltage

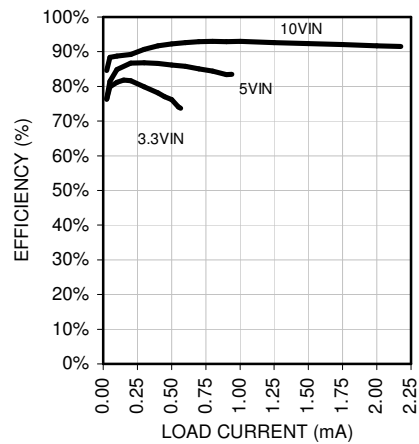

Figure 3. Efficiency versus load current

QUICK START GUIDE FOR DEMONSTRATION CIRCUIT 533

ADJUSTABLE OUTPUT BOOST REGULATOR 800KHZ

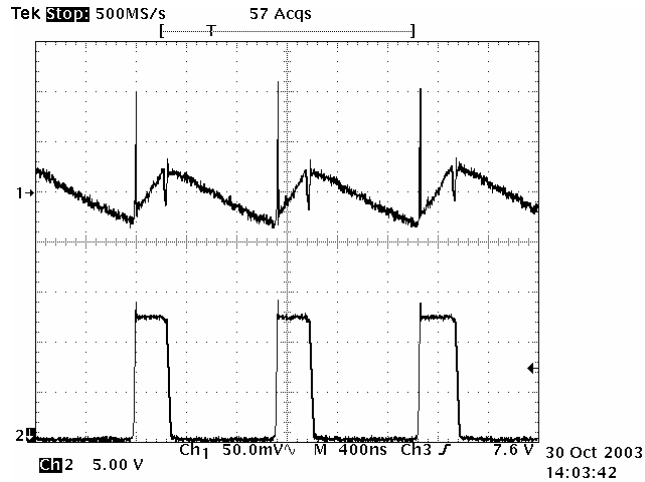

Figure 4. Output Voltage Ripple ($I_{OUT} = 550\text{mA}$, $V_{IN} = 3.3\text{V}$, $V_{OUT} = 12\text{V}$, $T_A = 25^\circ\text{C}$) CH1 is V_{OUT} ripple (AC), CH2 is V_{SW}

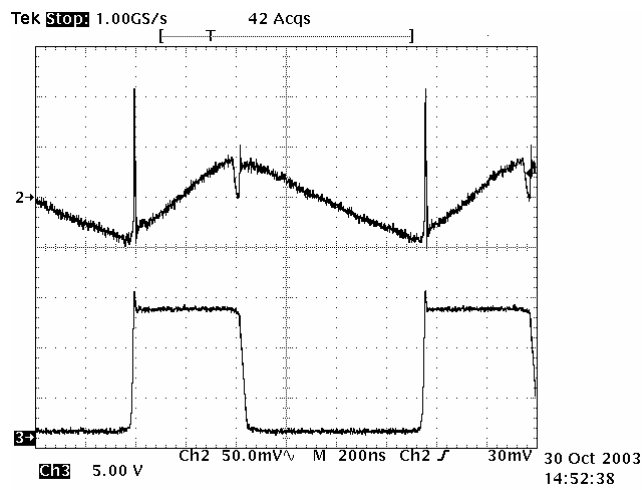

Figure 5. Output Voltage Ripple ($I_{OUT} = 900\text{mA}$, $V_{IN} = 5\text{V}$, $V_{OUT} = 12\text{V}$, $T_A = 25^\circ\text{C}$) CH2 is V_{OUT} ripple (AC), CH3 is V_{SW}

QUICK START GUIDE FOR DEMONSTRATION CIRCUIT 533

ADJUSTABLE OUTPUT BOOST REGULATOR 800KHZ

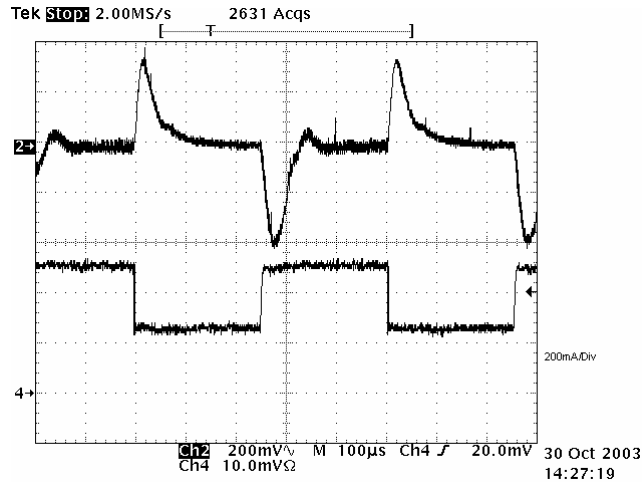

Figure 6. DC533 Step Load Response ($I_{OUT} = 250\text{mA}$ to 500mA , $V_{IN} = 3.5\text{V}$, $T_A = 25^\circ\text{C}$, $V_{OUT} = 12\text{V}$) CH2 is V_{OUT} ripple (AC), CH4 is I_{OUT} (200mA/10mV Ω)

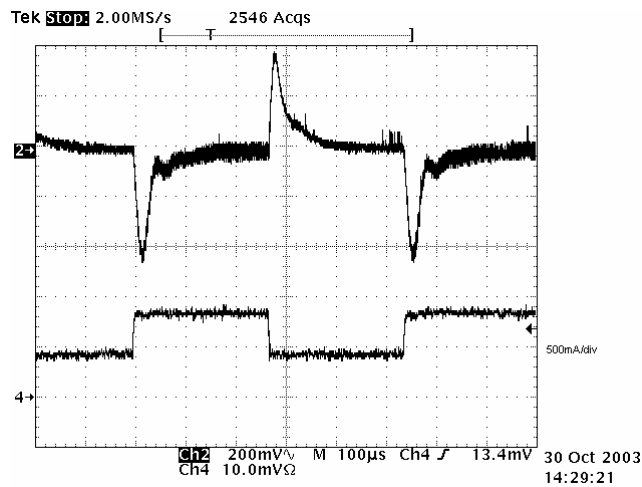

Figure 7. DC533 Step Load Response ($I_{OUT} = 400\text{mA}$ to 800mA , $V_{IN} = 5\text{V}$, $T_A = 25^\circ\text{C}$, $V_{OUT} = 12\text{V}$) CH2 is V_{OUT} ripple (AC), CH4 is I_{OUT} (500mA/10mV Ω)

QUICK START GUIDE FOR DEMONSTRATION CIRCUIT 533

ADJUSTABLE OUTPUT BOOST REGULATOR 800KHZ

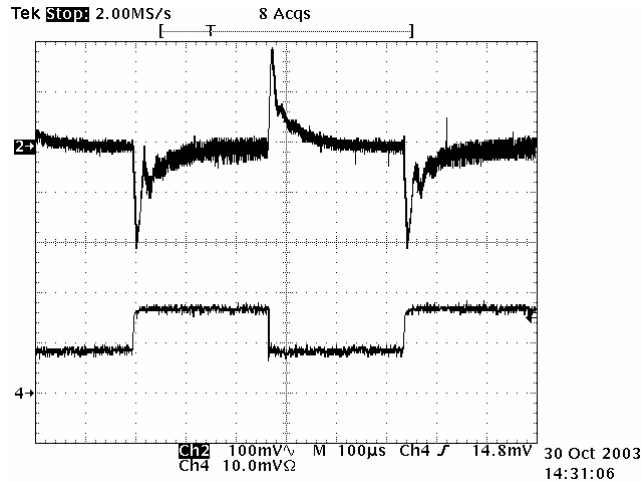

Figure 8. DC533 Step Load Response ($I_{OUT} = 400\text{mA}$ to 800mA , $V_{IN} = 8\text{V}$, $T_A = 25^\circ\text{C}$, $V_{OUT} = 12\text{V}$) CH1 is V_{OUT} ripple (AC), CH2 is I_{OUT} ($500\text{mA}/10\text{mV}\Omega$)

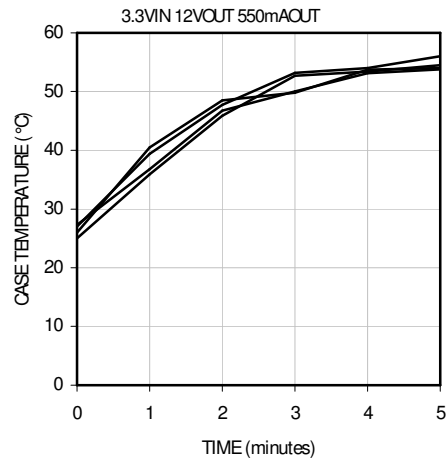

Figure 9. Five Minute Thermal Profile of DC533x4 ($I_{OUT} = 550\text{mA}$, $V_{IN} = 3.3\text{V}$, $T_A = 25^\circ\text{C}$, $V_{OUT} = 12\text{V}$)

QUICK START GUIDE FOR DEMONSTRATION CIRCUIT 533

ADJUSTABLE OUTPUT BOOST REGULATOR 800KHZ

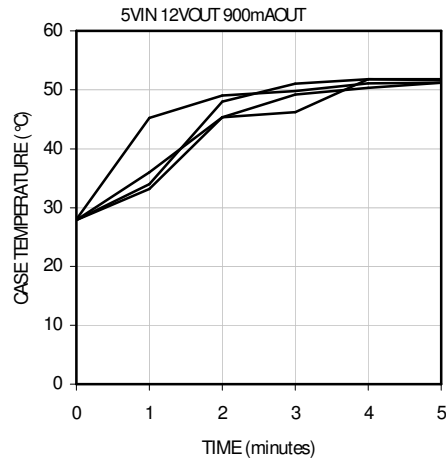

Figure 10. Five Minute Thermal Profile of DC533x4 ($I_{OUT} = 900\text{mA}$, $V_{IN} = 5\text{V}$, $T_A = 25^\circ\text{C}$, $V_{OUT} = 12\text{V}$)

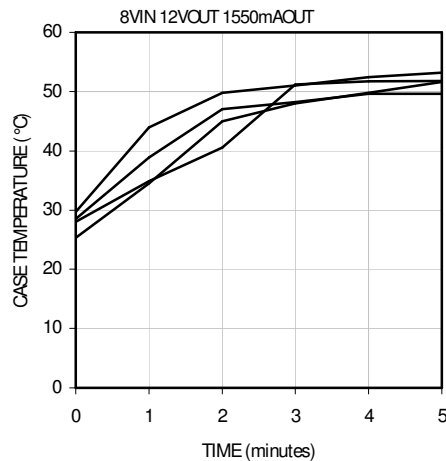

Figure 11. Five Minute Thermal Profile of DC533x4 ($I_{OUT} = 1550\text{mA}$, $V_{IN} = 8\text{V}$, $T_A = 25^\circ\text{C}$, $V_{OUT} = 12\text{V}$)

QUICK START GUIDE FOR DEMONSTRATION CIRCUIT 533

ADJUSTABLE OUTPUT BOOST REGULATOR 800KHZ

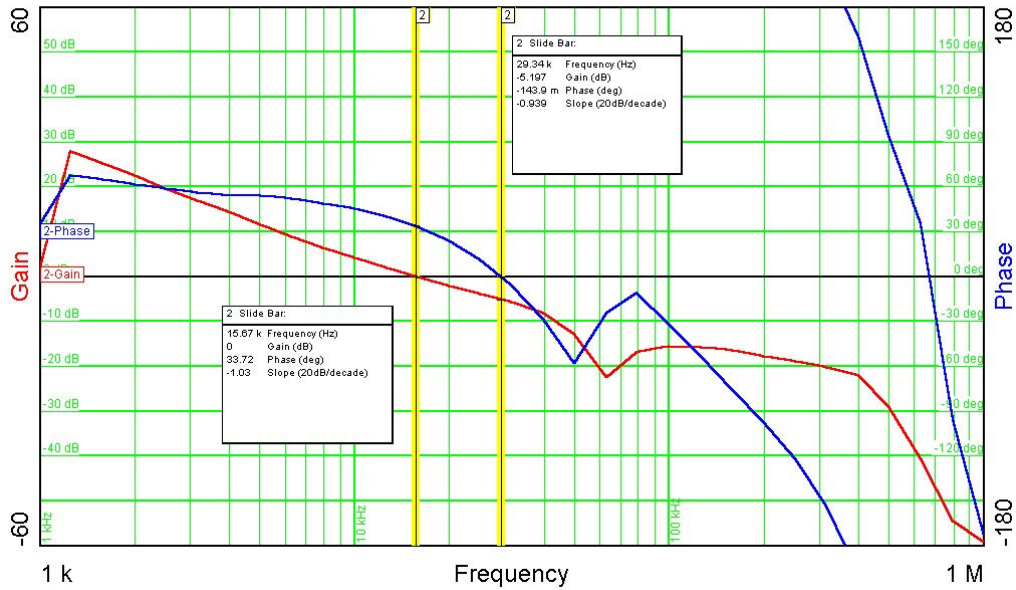

Figure 12. DC533 Bode Plot ($I_{OUT} = 900\text{mA}$, $V_{IN} = 5\text{V}$, $T_A = 25^\circ\text{C}$, $V_{OUT} = 12\text{V}$)

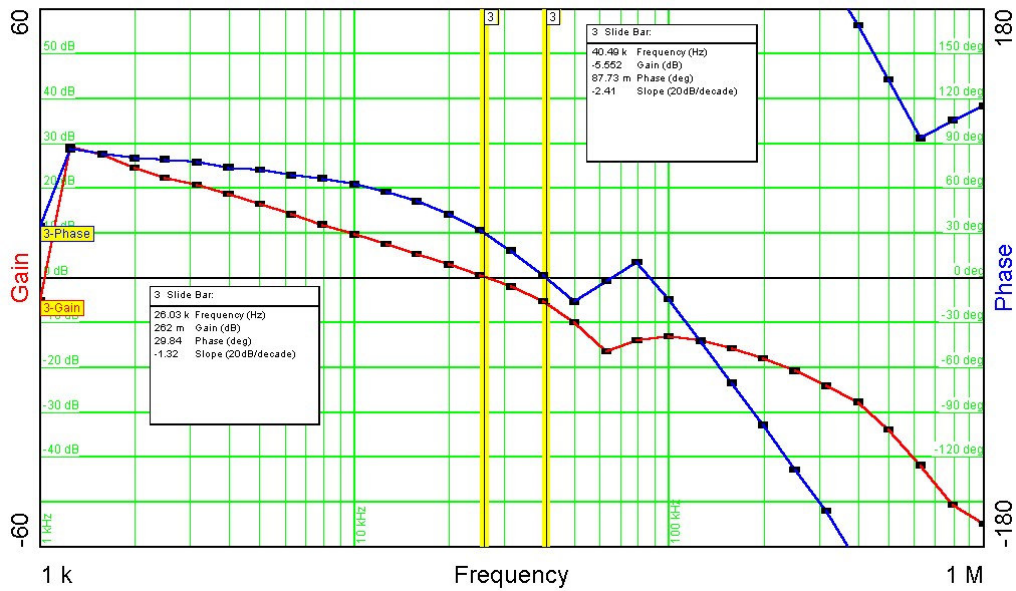

Figure 13. DC533 Bode Plot ($I_{OUT} = 1550\text{mA}$, $V_{IN} = 8\text{V}$, $T_A = 25^\circ\text{C}$, $V_{OUT} = 12\text{V}$)

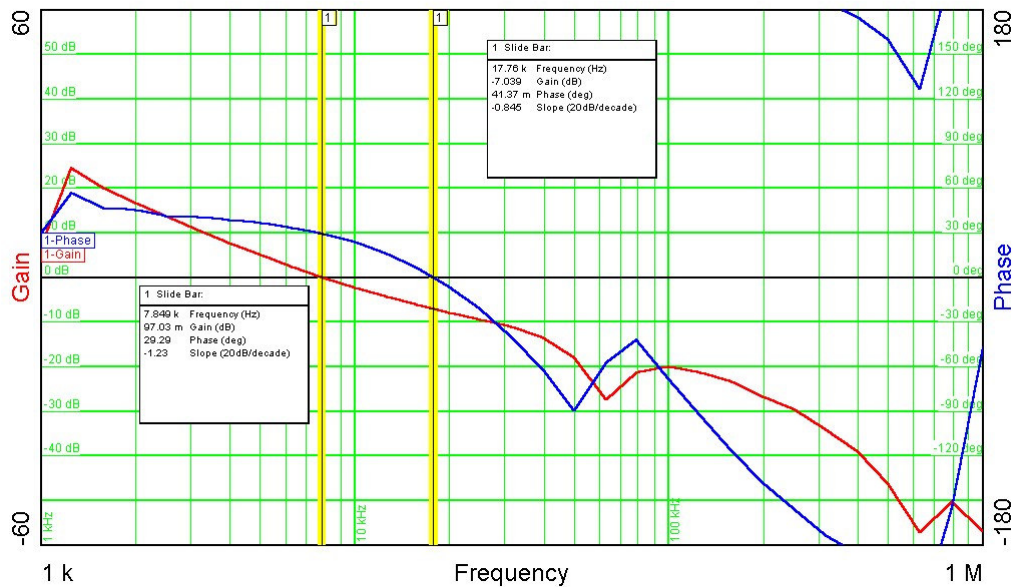

Figure 14. DC533 Bode Plot ($I_{OUT} = 550\text{mA}$, $V_{IN} = 3.3\text{V}$, $T_A = 25^\circ\text{C}$, $V_{OUT} = 12\text{V}$)

BUILDING A SEPIC

The DC533 can be easily modified to create a SEPIC (Single-Ended Primary Inductance Converter). Figure 15 shows a 3V to 20V input 5V output SEPIC converter. The maximum load current increases with input voltage and is shown in Figure 16. The SEPIC converter can be built with either a transformer or two separate inductors since the energy passed between the primary and secondary follows the path through the coupling capacitor (C7) instead of the core of the transformer.

Figure 18 and Figure 19 show the component placement for the SEPIC on the DC533. The feedback resistors and the compensation resistor and capacitor are different in the 5V_{OUT} SEPIC than in the 12V_{OUT} boost. The component location changes from the typical boost circuit are the following:

- L2 (or T1) is added to the circuit
- C7 is placed where D1 used to be
- C2 is moved to the new location

- A cut is made to separate the pads of D1
- D1 is placed in a new location
- Feedback path on back is altered (Figure 20)

The new location of D1 places both pads of D1 on the same electrical node (V_{OUT} in the boost circuit). An Exacto knife cut must be made to separate the two pads electrically before it is placed in the circuit for the SEPIC. There is already a cut two thirds of the way across the V_{OUT} node. This cut reduces output voltage ripple that is seen at the terminals in the boost configuration. Extend this cut all the way across the node through D1 and then place D1 in its new location as shown in Figure 18.

The path from V_{OUT} to the feedback resistors is on the backside of the board. In the boost application, the feedback via is located at the top of C2. When C2 is moved to a new location for the SEPIC, the feedback path must also move. The backside of the board must be slightly altered to source the output voltage measurement from its new location and still monitor feedback from V_{OUT} . Figure 20 shows how the old feedback via must be cut from

QUICK START GUIDE FOR DEMONSTRATION CIRCUIT 533

ADJUSTABLE OUTPUT BOOST REGULATOR 800KHZ

the feedback path and the new feedback via must be added to the feedback path. Make sure that there is no longer a short between V_{OUT} and the

anode of D1 (the location of the feedback via for the boost that should have been removed from the path.)

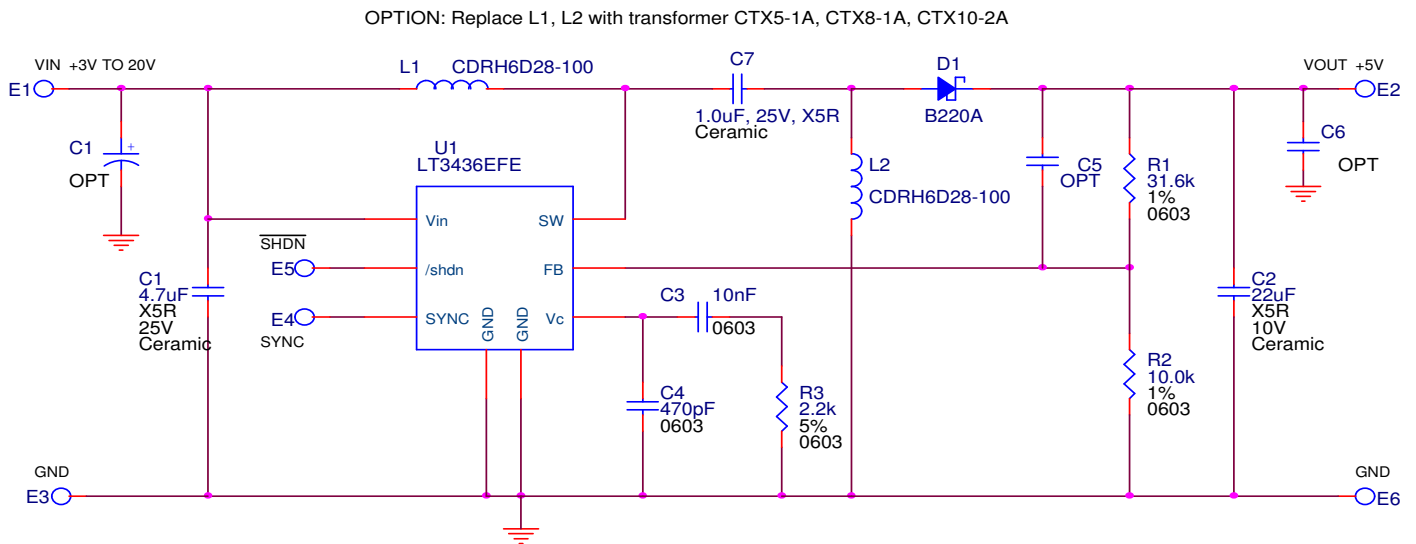

Figure 15. LT3436 3V to 20V_{IN} 5V_{OUT} SEPIC with either two inductors or a transformer

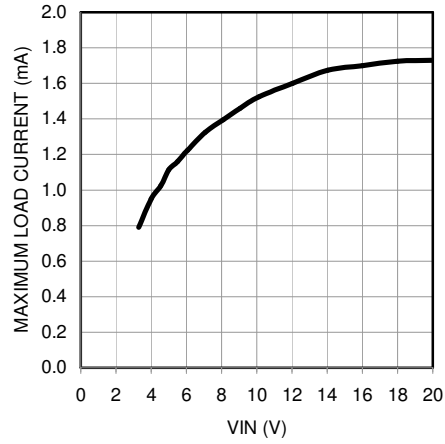

Figure 16. Maximum load current of the SEPIC in Figure 15 increases with input voltage

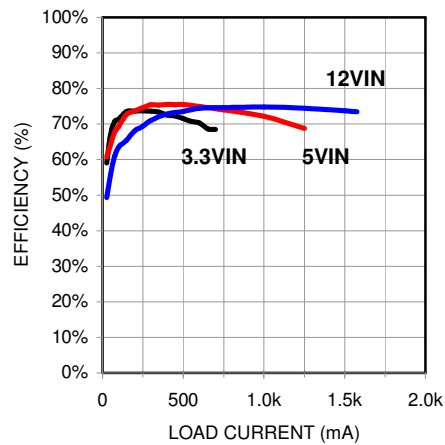

Figure 17. Efficiency of SEPIC in Figure 15

QUICK START GUIDE FOR DEMONSTRATION CIRCUIT 533
ADJUSTABLE OUTPUT BOOST REGULATOR 800KHZ

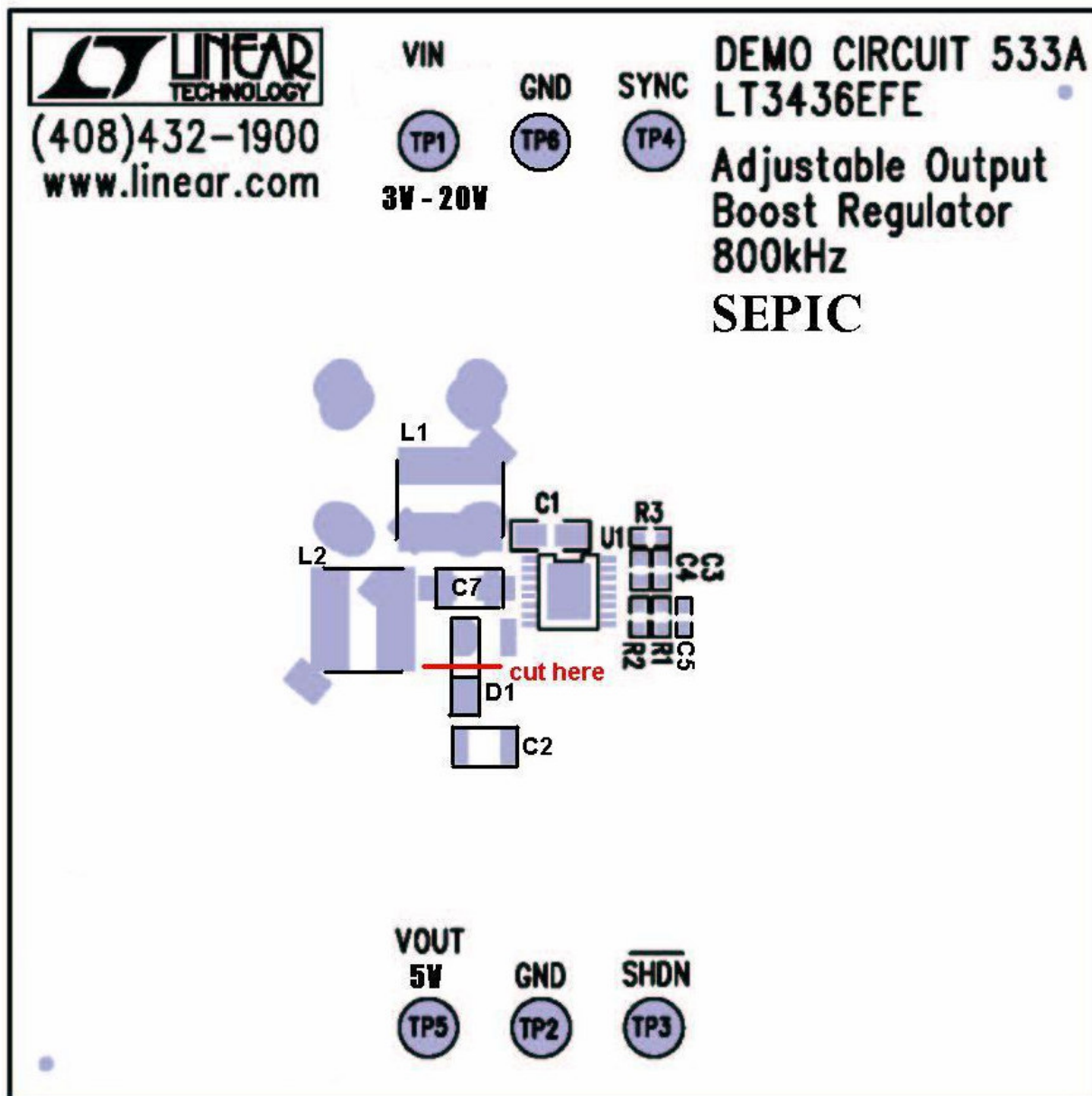

Figure 18. DC533A SEPIC customization topside component placement with two inductors

QUICK START GUIDE FOR DEMONSTRATION CIRCUIT 533
ADJUSTABLE OUTPUT BOOST REGULATOR 800KHZ

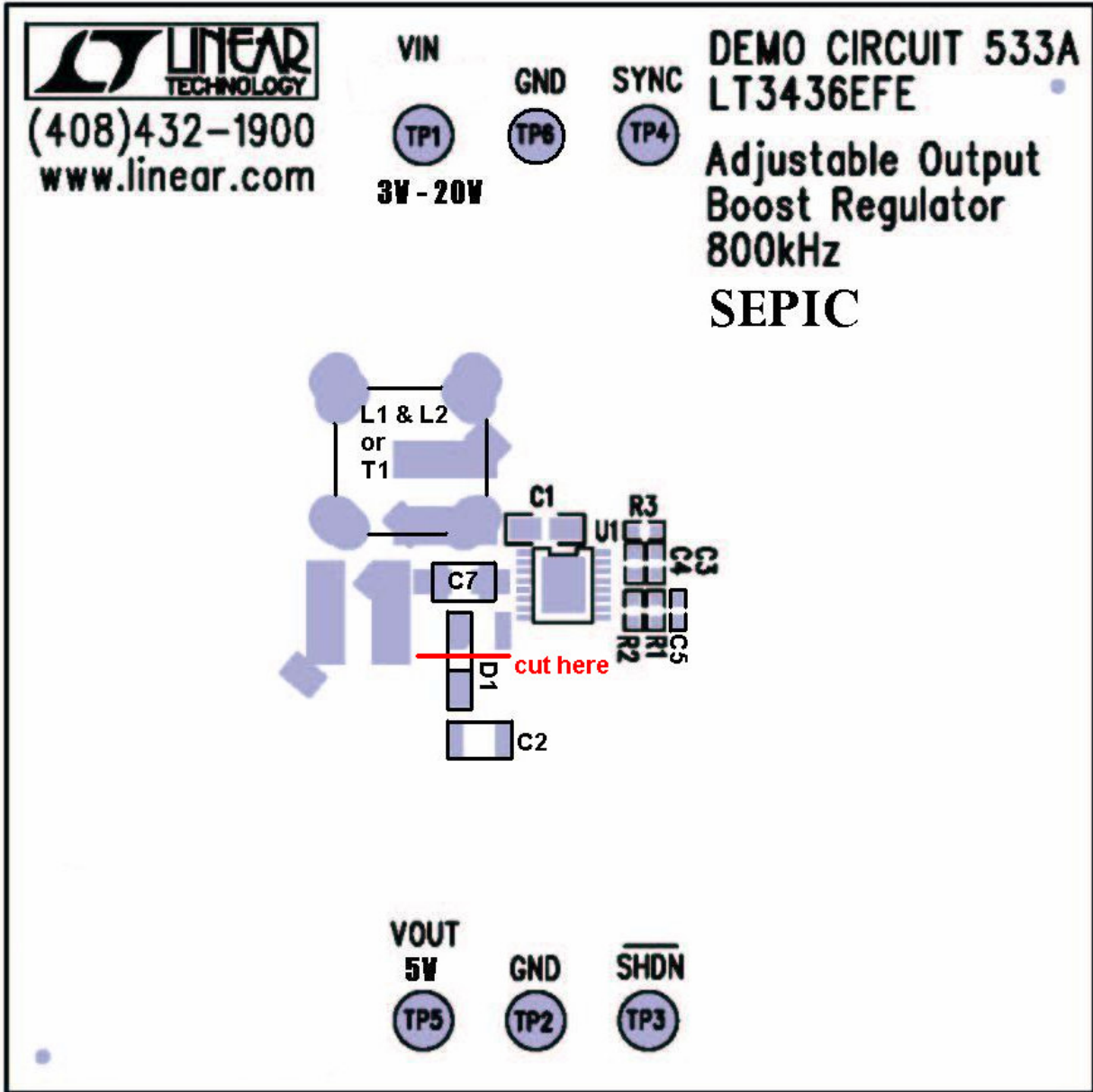

Figure 19. DC533A SEPIC customization topside component placement with transformer

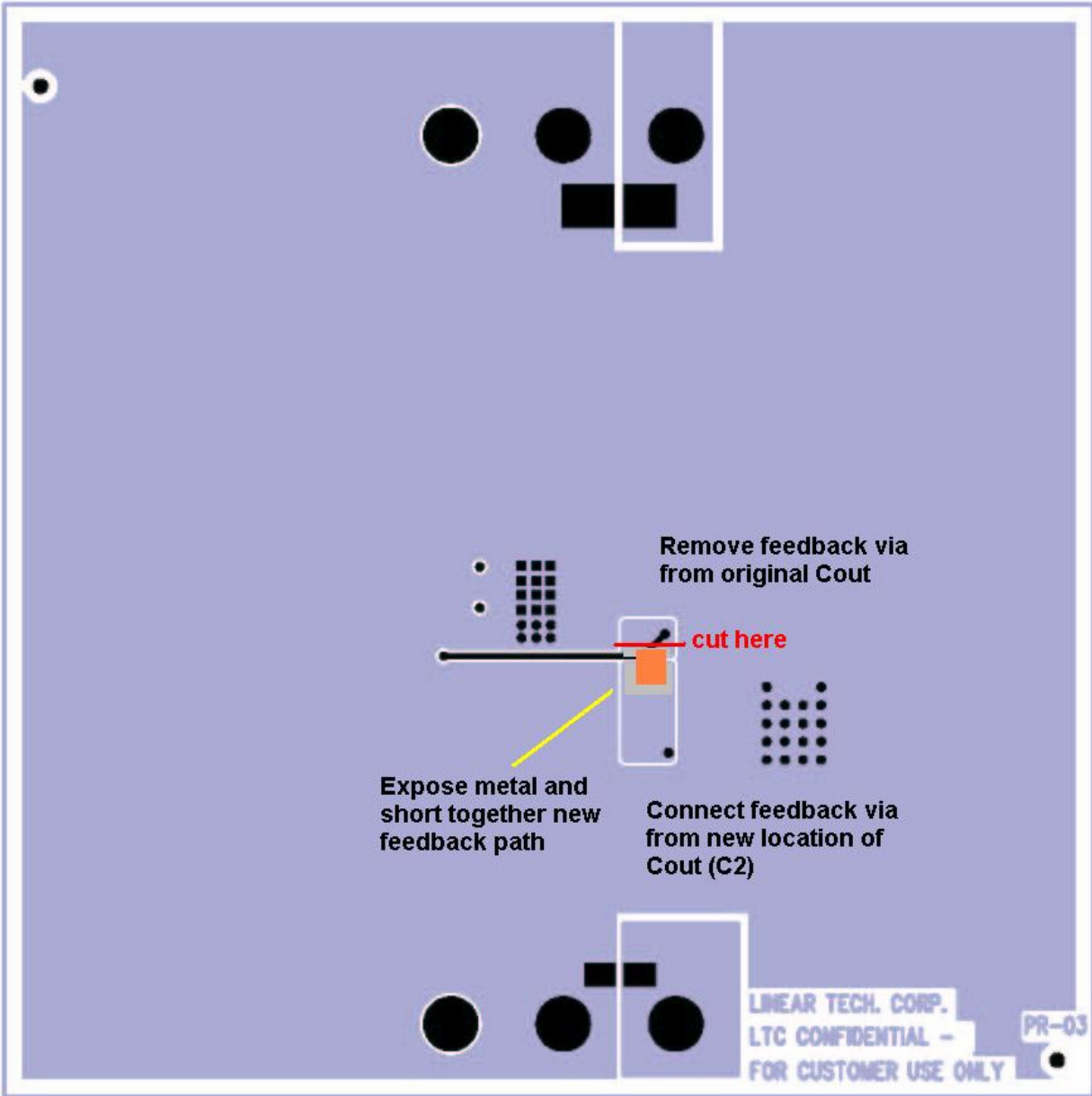
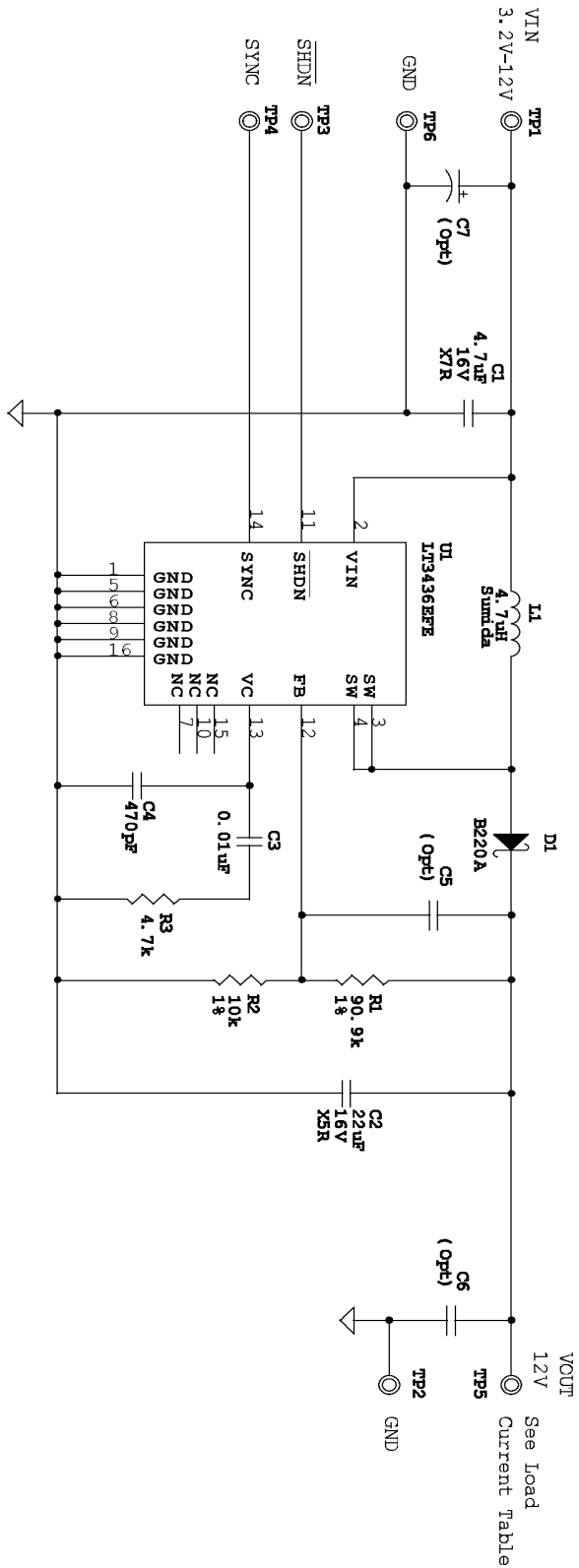

Figure 20. DC533A SEPIC customization backside feedback path alteration

QUICK START GUIDE FOR DEMONSTRATION CIRCUIT 533

ADJUSTABLE OUTPUT BOOST REGULATOR 800KHZ



LOAD CURRENT TABLE

VIN	I _{out} (MAX)
3.3	550mA
5.0	900mA
8.0	1550mA

LT3436EFE

Linear Technology Corp.
 1630 McCarthy Blvd., Milpitas, CA
 95035-7417
 Phone: (408)432-1900 Fax: (408)434-0507

Title: Adjustable Output Boost Regulator 800KHz

Size: Document Number
Demo Circuit 533

Date: Friday, October 10, 2003

Sheet 1 of 1

Rev A

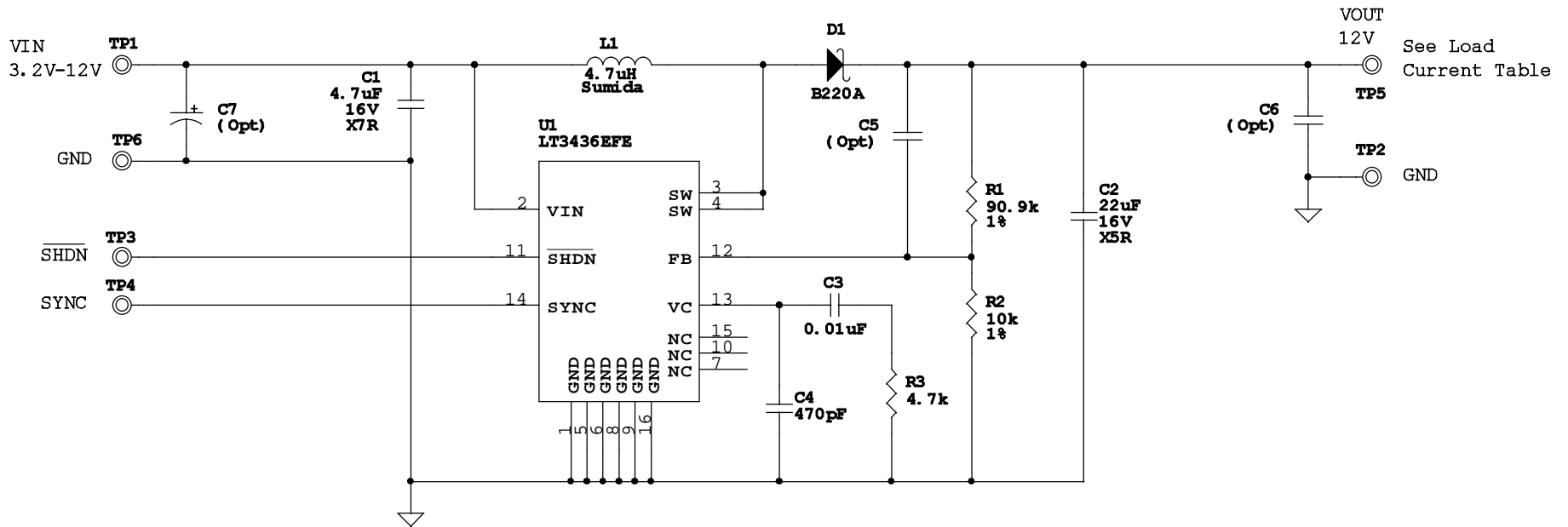

LOAD CURRENT TABLE

VIN	Iout(MAX)
3.3	550mA
5.0	900mA
8.0	1550mA

This circuit is proprietary to Linear Technology and supplied for use with Linear Technology parts.

Customer Notice: Linear Technology has made a best effort to design a circuit that meets customer-supplied specifications; however, it remains the customers responsibility to verify proper and reliable operation in the actual application. Component substitution and printed circuit board layout may significantly affect circuit performance or reliability. Contact Linear Applications Engineering for assistance.

LT3436EFE

Linear Technology Corp.		1630 McCarthy Blvd., Milpitas, CA 95035-7417 Phone: (408)432-1900 Fax: (408)434-0507
Title Adjustable Output Boost Regulator 800kHz		
Size	Document Number Demo Circuit 533	Rev A
Date: Friday, November 14, 2003		Sheet 1 of 1

Item	Qty	Reference	Part Description	Manufacture / Part #
1	1	C1	Cap., X7R 4.7uF 16V 20%	TDK C3216X7R1C475M
2	1	C2	Cap., X5R 22uF 16V 20%	TDK C3225X5R1C226M
3	1	C3	Cap., X7R 0.01uF 25V 5%	AVX 06033C103KAT2A
4	1	C4	Cap., NPO 470pF 25V 5%	AVX 06033A471JAT1A
5	0	C5 (OPT)	OPTIONAL	
6	0	C6 (OPT)	OPTIONAL	
7	0	C7 (OPT)	OPTIONAL	
8	1	D1	Schottky Barrier 20V/2A	Diodes Inc. B220A-13
9	1	L1	Inductor, 4.7uH	Sumida CDRH8D28-4R7NC
10	1	R1	Res., Chip 90.9K 0.06W 1%	AAC CR16-9092FM
11	1	R2	Res., Chip 10K 0.06W 1%	AAC CR16-1002FM
12	1	R3	Res., Chip 4.7K 0.06W 5%	AAC CR16-472JM
13	6	TP1-TP6	Turret, Testpoint	Mill Max 2501-2
14	1	U1	I.C., Boost Volt. Reg.	Linear Tech. Corp. LT3436EFE
15	1		PRINTED CIRCUIT BOARD	DEMO CIRCUIT #533A
16	1		STENCIL	STENCIL