

LT8316 Non-Opto Isolated Flyback Converter

DESCRIPTION

Demonstration circuit 2718A is a non-opto flyback converter featuring the LT8316. The demo board outputs 12V and maintains tight regulation with a load current from 30mA to 3A. It is optimized to operate over a wide 100V to 600V DC input voltage range. Output voltage accuracy stays within $\pm 5\%$ over the entire input voltage and load range.

The **LT[®]8316** is a high voltage flyback controller. No opto-isolator is needed for regulation. The part samples the output voltage from the isolated flyback waveform appearing

across a third winding on the transformer. Quasi-resonant boundary mode operation improves load regulation. The LT8316 is available in a thermally enhanced 20-pin TSSOP package with four pins removed for high-voltage spacing.

The LT8316 data sheet gives a complete description of the part, operation and application information. The data sheet must be read in conjunction with this quick start guide for demo circuit 2718A.

[Design files for this circuit board are available.](#)

All registered trademarks and trademarks are the property of their respective owners.

PERFORMANCE SUMMARY Specifications are at $T_A = 25^\circ\text{C}$

PARAMETER	CONDITIONS	MIN	TYP	MAX	UNITS
Input Voltage		100		600	V
Output Voltage	$I_{OUT} = 30\text{mA to } 3\text{A}$	11.4	12	12.6	V
Maximum Output Current		3			A
Output Voltage Ripple	$V_{IN} = 100\text{V}, I_{OUT} = 3\text{A}$		250		mV _{p-p}
Typical Switching Frequency	$V_{IN} = 100\text{V}, I_{OUT} = 3\text{A}$		43		kHz
	$V_{IN} = 600\text{V}, I_{OUT} = 3\text{A}$		85		kHz
Efficiency	$V_{IN} = 100\text{V}, I_{OUT} = 3\text{A}$		89		%
	$V_{IN} = 600\text{V}, I_{OUT} = 3\text{A}$		88		%

QUICK START PROCEDURE

IMPORTANT NOTE TO CUSTOMERS:

HIGH VOLTAGES ARE PRESENTED ON THE DEMO CIRCUIT, AND CAN LEAD TO LETHAL INJURIES TO THE HUMAN BODY. ONLY QUALIFIED PERSONNEL SHOULD OPERATE IT. IT IS STRONGLY RECOMMENDED TO USE SAFETY GLASSES AND AN ISOLATION TRANSFORMER.

NOTE: IMPROPER COMPONENTS REPLACEMENT ON THE DEMO CIRCUIT CAN CAUSE PERFORMANCE DETERIORATIONS, CIRCUIT MALFUNCTION, PROPERTY DAMAGE, AND EVEN LIFE-THREATENING INJURIES. CONTACT ANALOG DEVICES APPLICATIONS ENGINEERS FOR PROPER COMPONENT REPLACEMENT.

Demonstration circuit 2718A is easy to set up to evaluate the performance of the LT8316. Refer to Figure 1 for proper measurement equipment setup and follow this procedure:

1. Set an input power supply that is capable of 100V to 600V to 100V adjustments. Then turn off the supply.
2. With power off, connect the DC input power supply to the board through the +VIN and GND terminals. Connect the load to the terminals +VOUT and GND on the board.

3. Turn on the power at the input.

NOTE: Make sure that the input voltage does not exceed 600V

4. Check for the proper output voltages. The output should be regulated at 12V ($\pm 5\%$).

NOTE: The LT8316 requires very small minimum load to maintain good output voltage regulation. A Zener diode is placed on the output to clamp the voltage to 13V. This Zener can be replaced with a 400 Ω resistor at the trade-off of lower efficiency.

5. Once the proper output voltage is established, adjust the input voltage and load current within the operating range and observe the output voltage regulation, ripple voltage, efficiency and other parameters.

NOTE: When measuring the input or output voltage ripples, care must be taken to avoid a long ground lead on the oscilloscope probe. Measure the output voltage ripple by touching the probe tip directly across the +VOUT and GND terminals. See Figure 2 for proper scope probe technique.

Figure 3 through Figure 12 provide additional information about the demo board's performance.

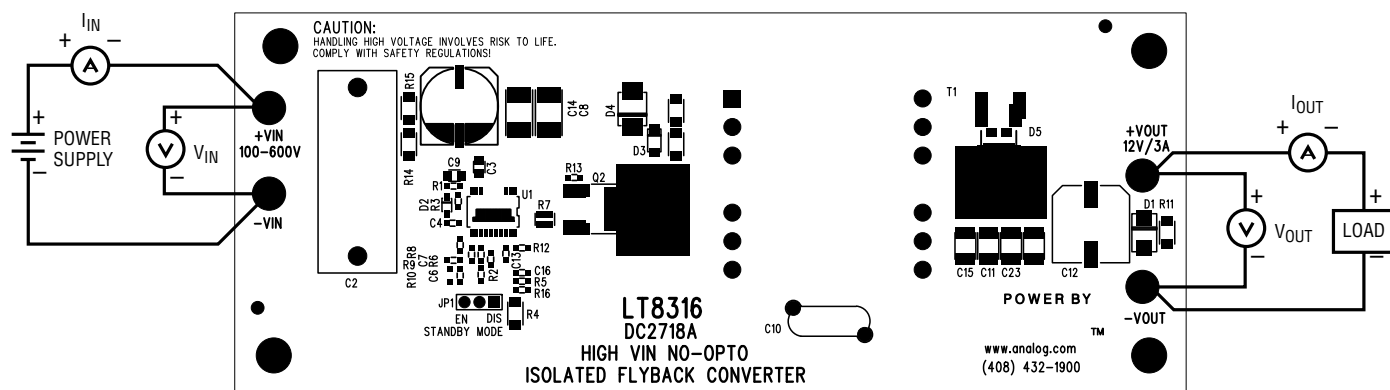

Figure 1. Proper Measurement Equipment Setup

QUICK START PROCEDURE

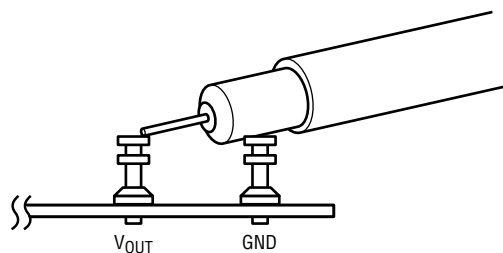

Figure 2. Proper Scope Probe Placement for Measuring Input or Output Ripple

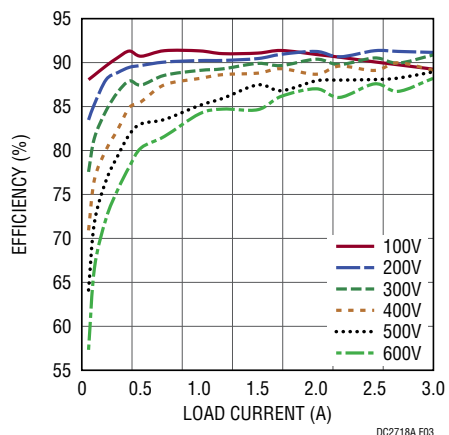

Figure 3. Efficiency vs Load Current

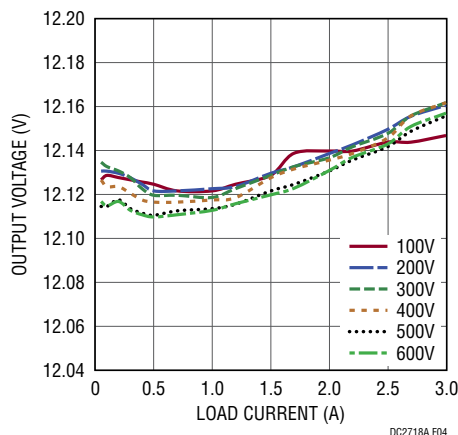

Figure 4. Load and Line Regulation

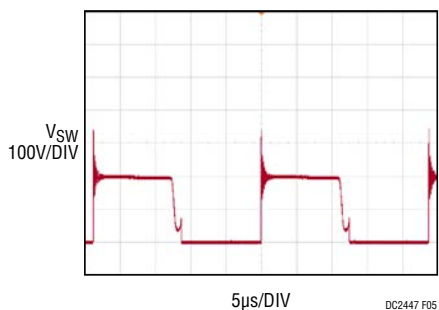

Figure 5. Steady State Switch Node Voltage at 100V Full Load Condition

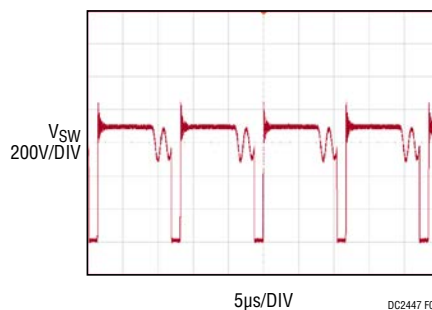

Figure 6. Steady State Switch Node Voltage at 600V Full Load Condition

QUICK START PROCEDURE

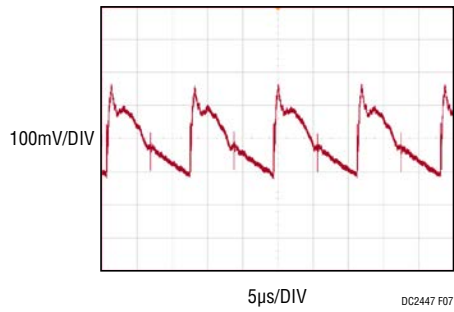

Figure 7. Output Ripple Voltage at 100V Full Load Condition

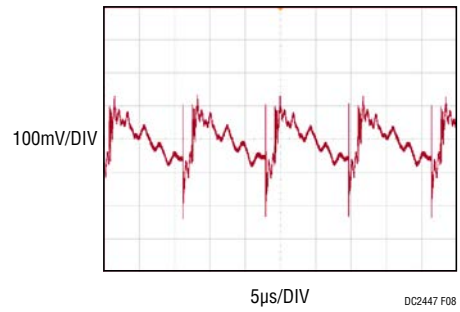

Figure 8. Output Ripple Voltage at 600V Full Load Condition

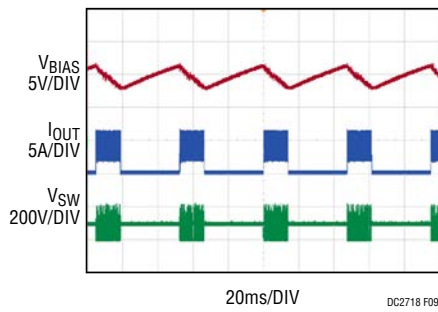

Figure 9. Short Circuit Waveforms at 100V

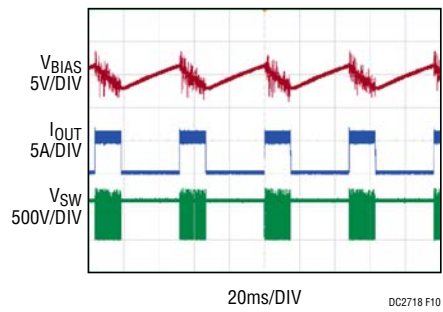

Figure 10. Short Circuit Waveforms at 600V

QUICK START PROCEDURE

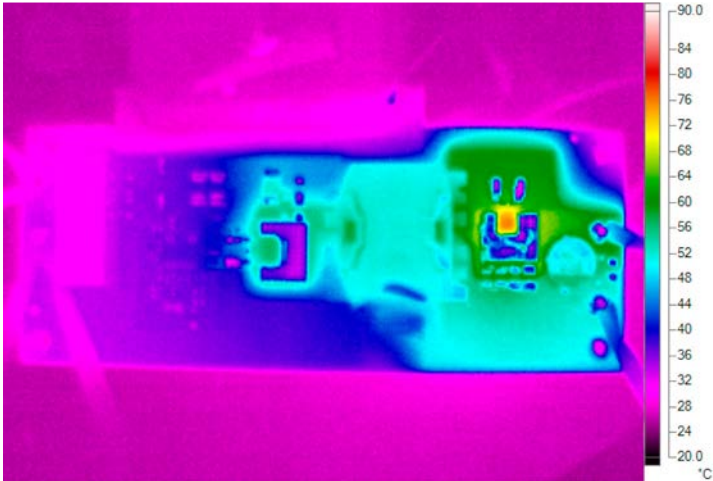

Figure 11. Thermal Map, Front Side at 100V Full Load Condition ($T_A = 25^\circ\text{C}$)

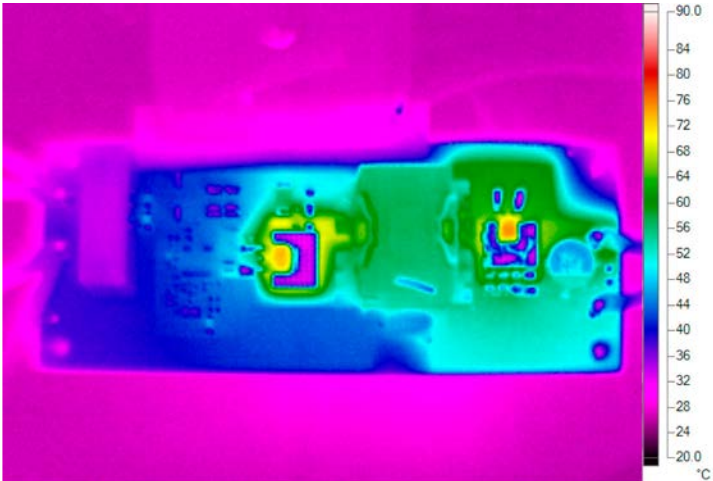

Figure 12. Thermal Map, Front Side at 600V Full Load Condition ($T_A = 25^\circ\text{C}$)

DEMO MANUAL DC2718A

PARTS LIST

ITEM	QTY	REFERENCE	PART DESCRIPTION	MANUFACTURER/PART NUMBER
Required Circuit Components				
1	1	C2	CAP, FILM 1.0 μ F, 5%, , 630V, RADIAL	PANASONIC, ECWFG2J105P1
2	1	C3	CAP, X5R, 4.7 μ F, 25V, 10%, 0805	MURATA, GRM219R61E475KA73D
3	1	C4	CAP, NPO, 47pF, 100V, 5%, 0603	MURATA, GRM1885C2A470JA01J
4	1	C6	CAP, X5R, 100nF, 25V, 10%, 0603	MURATA, GRM188R61E104KA01D
5	1	C7	CAP, X7R, 47pF, 25V, 10%, 0603	AVX, 06033C470KAT2A
6	2	C8, C14	CAP, X7R, 100nF, 630V, 10%, 1812	MURATA, GRM43DR72J104KW01L
7	1	C9	CAP, X7S, 4.7 μ F, 50V, 10%, 0805	MURATA, GRM21BC71H475KE11L
8	1	C10	CAP, Y5U 2200pF, 400VAC 20%,	VISHAY, 440LD22-R
9	3	C11, C15, C23	CAP, X5R, 47 μ F, 16V, 10%, 1210	MURATA, GRM32ER61C476KE15K
10	1	C12	CAP, ALUM POLY, 470 μ F, 25V, 20%	PANASONIC, EEHZK1E471P
11	1	C13	CAP, COG, 1nF, 25V, 5%, 0603	MURATA, GRM1885C1E102JA01D
12	1	D1	DIODE, ZENER, 13V, 1.5W SMA	CENTRAL SEMI., CMZ5928B TR13
13	1	D2	DIODE, 150V, SOD323	DIODES INC., BAV20WS-7-F
14	1	D3	DIODE, 1kV, 1A, SOD123FA	ON SEMI., US1MFA
15	1	D4	DIODE, TVS, 188V, SMB	VISHAY., SMBJ188A-E3/52
16	1	D5	DIODE, SCHOTTKY, 20A, 120V, TO-277	FAIRCHILD, FSV20120V
17	1	Q2	N-CH MOSFET, 900V, 6A, DPAK	ST, STD6N90K5
18	1	R1	RES., CHIP, 10 Ω , 1/10W, 1%, 0603	VISHAY, CRCW060310R0FKEA
19	1	R2	RES., CHIP, 56.2k, 1/10W, 1%, 0603	VISHAY, CRCW060356K2FKEA
20	2	R3, R6	RES., CHIP, 10k, 1/10W, 1%, 0603	VISHAY, CRCW060310K0FKEA
21	3	R4, R14, R15	RES., CHIP, 499k, 1/4W, 1%, 1206	VISHAY, CRCW1206499KFKEA
22	1	R5	RES., CHIP, 20k, 1/10W, 1%, 0603	VISHAY, CRCW060320K0FKEA
23	1	R7	RES., SENSE, 0.05 Ω , 1W, 1%, 0805	SUSUMU, KRL2012D-M-R050-F-T5
24	1	R8	RES., CHIP, 121k, 1/10W, 1%, 0603	VISHAY, CRCW0603121KFKEA
25	1	R9	RES., CHIP, 44.2k, 1/10W, 1%, 0603	VISHAY, CRCW060344K2FKEA
26	1	R10	RES., CHIP, 4.99k, 1/10W, 1%, 0603	VISHAY, CRCW06034K99FKEA
27	1	R12	RES., 100 Ω , 1/10W, 1%, 0603	VISHAY, CRCW0603100RFKEA
28	1	R13	RES., 20 Ω , 1/10W, 1%, 0603	VISHAY, CRCW060320R0FKEA
29	1	T1	TRANSFORMER	SUMIDA, 11328-T078
30	1	U1	I.C., LT8316EFE, TSSOP20FE(16)	ANALOG DEVICES, LT8316EFE#PBF
Additional Demo Board Circuit Components				
1	0	C16 (OPT)	CAP, 0603	
2	0	R11(OPT)	RES., 1206	
3	0	R16 (OPT)	RES., 0603	
Hardware: For Demo Board Only				
1	4	E1-E4	TESTPOINT, TURRET, 0.094" pbf	MILL-MAX, 2501-2-00-80-00-00-07-0
2	4	MH1-MH4	STAND-OFF, NYLON, 0.25"	WURTH ELEKTRONIK, 702931000
3	1	JP1	HEADER 3 PIN 0.079 SINGLE ROW	WURTH ELEKTRONIK, 62000311121
4	1	XJP1	SHUNT, 0.079" CENTER	WURTH ELEKTRONIK, 60800213421
5	1		FAB, PRINTED CIRCUIT BOARD	DEMO CIRCUIT 2718A
6	1		STENCIL FOR TOP	STENCIL DC2718A

SCHEMATIC DIAGRAM

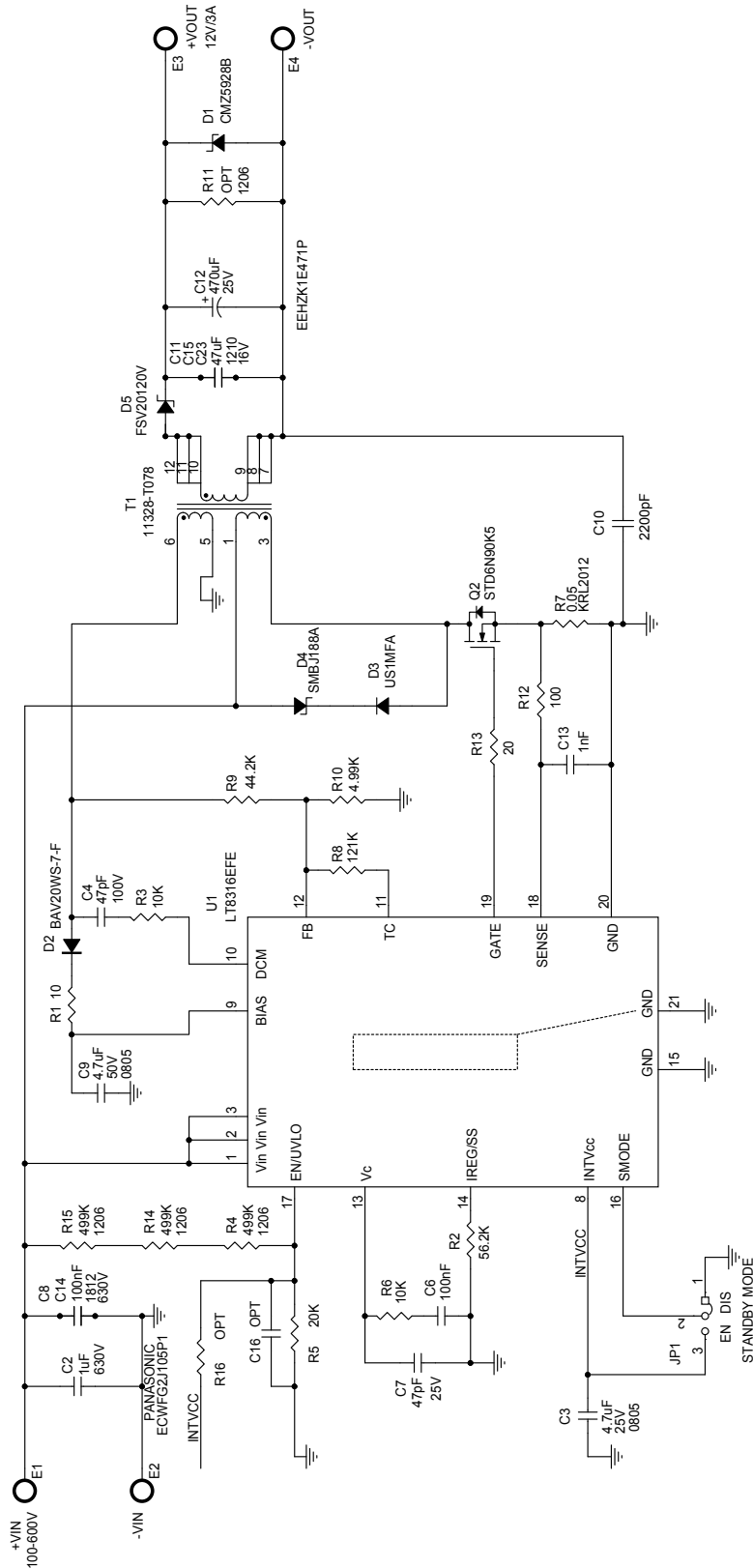

NOTE: UNLESS OTHERWISE SPECIFIED,
ALL RESISTORS ARE 0603
ALL CAPACITORS ARE 0805



ESD Caution

ESD (electrostatic discharge) sensitive device. Charged devices and circuit boards can discharge without detection. Although this product features patented or proprietary protection circuitry, damage may occur on devices subjected to high energy ESD. Therefore, proper ESD precautions should be taken to avoid performance degradation or loss of functionality.

Legal Terms and Conditions

By using the evaluation board discussed herein (together with any tools, components documentation or support materials, the "Evaluation Board"), you are agreeing to be bound by the terms and conditions set forth below ("Agreement") unless you have purchased the Evaluation Board, in which case the Analog Devices Standard Terms and Conditions of Sale shall govern. Do not use the Evaluation Board until you have read and agreed to the Agreement. Your use of the Evaluation Board shall signify your acceptance of the Agreement. This Agreement is made by and between you ("Customer") and Analog Devices, Inc. ("ADI"), with its principal place of business at One Technology Way, Norwood, MA 02062, USA. Subject to the terms and conditions of the Agreement, ADI hereby grants to Customer a free, limited, personal, temporary, non-exclusive, non-sublicensable, non-transferable license to use the Evaluation Board FOR EVALUATION PURPOSES ONLY. Customer understands and agrees that the Evaluation Board is provided for the sole and exclusive purpose referenced above, and agrees not to use the Evaluation Board for any other purpose. Furthermore, the license granted is expressly made subject to the following additional limitations: Customer shall not (i) rent, lease, display, sell, transfer, assign, sublicense, or distribute the Evaluation Board; and (ii) permit any Third Party to access the Evaluation Board. As used herein, the term "Third Party" includes any entity other than ADI, Customer, their employees, affiliates and in-house consultants. The Evaluation Board is NOT sold to Customer; all rights not expressly granted herein, including ownership of the Evaluation Board, are reserved by ADI. CONFIDENTIALITY. This Agreement and the Evaluation Board shall all be considered the confidential and proprietary information of ADI. Customer may not disclose or transfer any portion of the Evaluation Board to any other party for any reason. Upon discontinuation of use of the Evaluation Board or termination of this Agreement, Customer agrees to promptly return the Evaluation Board to ADI. ADDITIONAL RESTRICTIONS. Customer may not disassemble, decompile or reverse engineer chips on the Evaluation Board. Customer shall inform ADI of any occurred damages or any modifications or alterations it makes to the Evaluation Board, including but not limited to soldering or any other activity that affects the material content of the Evaluation Board. Modifications to the Evaluation Board must comply with applicable law, including but not limited to the RoHS Directive. TERMINATION. ADI may terminate this Agreement at any time upon giving written notice to Customer. Customer agrees to return to ADI the Evaluation Board at that time. LIMITATION OF LIABILITY. THE EVALUATION BOARD PROVIDED HEREUNDER IS PROVIDED "AS IS" AND ADI MAKES NO WARRANTIES OR REPRESENTATIONS OF ANY KIND WITH RESPECT TO IT. ADI SPECIFICALLY DISCLAIMS ANY REPRESENTATIONS, ENDORSEMENTS, GUARANTEES, OR WARRANTIES, EXPRESS OR IMPLIED, RELATED TO THE EVALUATION BOARD INCLUDING, BUT NOT LIMITED TO, THE IMPLIED WARRANTY OF MERCHANTABILITY, TITLE, FITNESS FOR A PARTICULAR PURPOSE OR NON-INFRINGEMENT OF INTELLECTUAL PROPERTY RIGHTS. IN NO EVENT WILL ADI AND ITS LICENSORS BE LIABLE FOR ANY INCIDENTAL, SPECIAL, INDIRECT, OR CONSEQUENTIAL DAMAGES RESULTING FROM CUSTOMER'S POSSESSION OR USE OF THE EVALUATION BOARD, INCLUDING BUT NOT LIMITED TO LOST PROFITS, DELAY COSTS, LABOR COSTS OR LOSS OF GOODWILL. ADI'S TOTAL LIABILITY FROM ANY AND ALL CAUSES SHALL BE LIMITED TO THE AMOUNT OF ONE HUNDRED US DOLLARS (\$100.00). EXPORT. Customer agrees that it will not directly or indirectly export the Evaluation Board to another country, and that it will comply with all applicable United States federal laws and regulations relating to exports. GOVERNING LAW. This Agreement shall be governed by and construed in accordance with the substantive laws of the Commonwealth of Massachusetts (excluding conflict of law rules). Any legal action regarding this Agreement will be heard in the state or federal courts having jurisdiction in Suffolk County, Massachusetts, and Customer hereby submits to the personal jurisdiction and venue of such courts. The United Nations Convention on Contracts for the International Sale of Goods shall not apply to this Agreement and is expressly disclaimed.