

# LT8357 Low I<sub>Q</sub> High Power Boost Converter

## DESCRIPTION

Demonstration circuit 2937A features the **LT<sup>®</sup>8357** as a 360kHz low I<sub>Q</sub>, high power boost converter with a 48V output from 10V to 40V input. This demonstration circuit features spread spectrum frequency modulation (SSFM) and split gate driver pins for the high power, high voltage switch. The converter can output 2A and higher (see Figure 3). When placed in shutdown, the converter has very low quiescent current, ideal in automotive and other battery-powered applications. Low quiescent current can be achieved with both pulse-skipping and Burst Mode<sup>®</sup> operation as jumper selections on this demonstration circuit.

The LT8357 boost controller IC operates over an input range of 3V to 60V, suitable for automotive, telecom and industrial applications. It also exhibits a low quiescent current of 8μA, making it ideal for battery-operated

systems. It drives a low side N-channel power MOSFET with a 5V split gate drive. The controller provides adjustable and synchronizable operation from 100kHz to 2MHz. At light load, either pulse-skipping or low-ripple Burst Mode operation can be selected to improve the efficiency. It also packs many popular features such as soft-start, input undervoltage lockout, adjustable frequency and clock synchronization. PGOOD indicates when the output voltage is in regulation.

The LT8357 comes in a thermally enhanced 12-lead plastic MSE package. The LT8357 data sheet gives a complete description of the part, pins, features, operation and application information. The data sheet must be read in conjunction with this demo manual for DC2937A.

**[Design files for this circuit board are available.](#)**

All registered trademarks and trademarks are the property of their respective owners.

## BOARD PHOTO

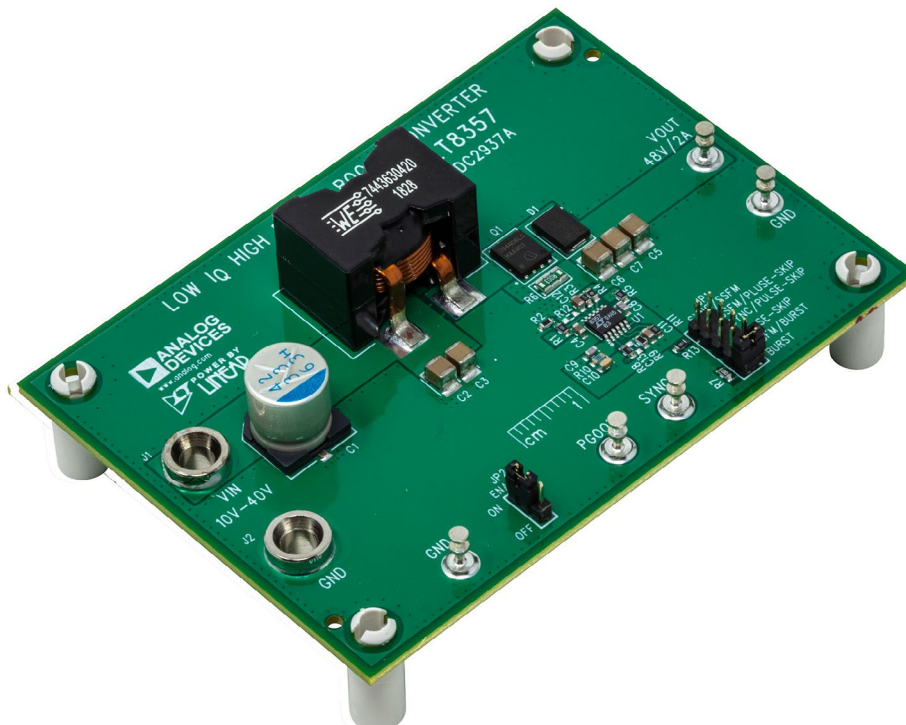

# DEMO MANUAL DC2937A

## PERFORMANCE SUMMARY Specifications are at $T_A = 25^\circ\text{C}$

PARAMETER	CONDITIONS	MIN	TYP	MAX
Input Voltage ( $V_{IN}$ )	$48V_{OUT}$	10V	12V, 24V	40V
Output Voltage ( $V_{OUT}$ )	$R8 = 1M\Omega$ , $R9 = 21.5k\Omega$ , JP2 = On	46.5V	48.0V	49.5V
Maximum Output Current	$48V_{OUT}$ , $24V_{IN}$ , $R6 = 0.003\Omega$		4A	
	$48V_{OUT}$ , $12V_{IN}$ , $R6 = 0.003\Omega$		2.5A	
Switching Frequency	$R11 = 90.9k\Omega$ , SSFM Off		362kHz	
	$R11 = 90.9k\Omega$ , SSFM On	360kHz		430kHz
Input EN Voltage (Rising)	$R1 = 1M\Omega$ , $R2 = 143k\Omega$ , JP2 = On		9.4V	
Input UVLO Voltage (Falling)	$R1 = 1M\Omega$ , $R2 = 143k\Omega$ , JP2 = On		9.75V	
Typical Efficiency	$12V_{IN}$ , 48V 2.0A Output, SSFM Off		95%	
PGOOD Voltage	No FAULT		5.0V	
	FAULT		0V	
Zero Load Quiescent Current	$48V_{OUT}$ , $12V_{IN}$ , JP1 = Pulse-Skipping		12mA	
	$REN = 1M\Omega$ and 143k	$48V_{OUT}$ , $12V_{IN}$ , JP1 = SSFM/Pulse-Skipping		11mA
	$RFB = 1M\Omega$ and 21.5k	$48V_{OUT}$ , $12V_{IN}$ , JP1 = Burst Mode Operation		320 $\mu$ A
	JP2 = ON	$48V_{OUT}$ , $12V_{IN}$ , JP1 = SSFM/Burst Mode Operation		320 $\mu$ A

## QUICK START PROCEDURE

DC2937A is easy to set up to evaluate the performance of the LT8357. Refer to Figure 1 for proper measurement equipment setup and follow the procedure below.

1. Place JP2 in the OFF position to disable the switcher.
2. With power off, connect the input power supply to the board through  $V_{IN}$  and GND terminals. Connect the load to the terminals  $V_{OUT}$  and GND.
3. Turn on the power at the input. Increase  $V_{IN}$  slowly to 12V.

**Note:** Make sure that the input voltage is always within spec. To operate the board with higher input/output voltage, input capacitor, output capacitor and output diode with higher voltage ratings might be needed.

4. Set the JP2 jumper to ON to enable the switcher.

5. Check for the proper output voltage. The output should be regulated at 48V and the PGOOD flag should be high (5V).
6. Once the proper output voltage is established, adjust the input voltage and load current within the operating range and observe the output voltage regulation, ripple voltage, efficiency and other parameters.
7. Set JP1 to examine the low  $I_Q$ , light load operation of the LT8357. SSFM can be turned on and off with this jumper position as well.

**Note:** When measuring the input or output voltage ripple, care must be taken to avoid a long ground lead on the oscilloscope probe. Measure the input or output voltage ripple by touching the probe tip directly across the input and output capacitors.

## QUICK START PROCEDURE

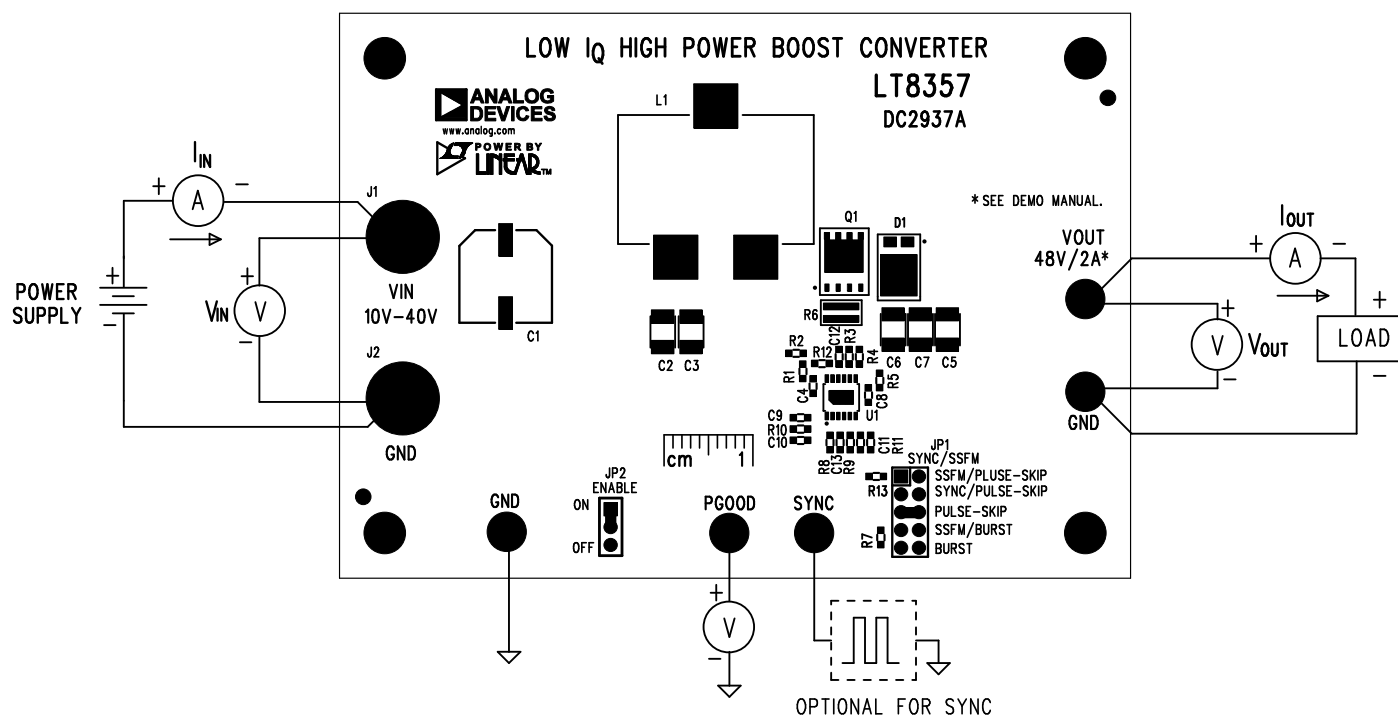

Figure 1. Test Procedure Setup Drawing for DC2937A

### OUTPUT VOLTAGE AND POWER

The LT8357 is a high voltage boost controller. It can boost voltages up to 100V with 5V gate drive MOSFETs. The 5.0V  $INTV_{CC}$  provides the gate drive for the external N-channel power MOSFET. The MOSFET, catch diode, feedback resistors, and output capacitor must be sized appropriately for the output voltage. Although DC2937A is set for 48V output, the feedback resistors R1 and R2 can be easily adjusted for higher or lower output voltage. The catch diode, D1, must also be able to handle the output voltage. Q1 and D1 are assembled with 60V components for the 48V output application.

More output power is possible. Figure 3 shows the maximum output current vs  $V_{IN}$ . At 10V input, the peak switch current limit set by the sense resistor, R6, limits the amount of output power in this boost converter to just above 2A. However, at 12V $_{IN}$ , 2.5A is possible and at 24V $_{IN}$  over 4A is possible. Eventually, high output current at high  $V_{IN}$  causes high temperature to rise on the switch and the inductor, so there is a thermal limit of 7A above 34V $_{IN}$  indicated in the maximum output current figure.

Within thermal limitations, the inductor and sense resistor R6 can be changed by the board user for higher or lower peak switch current limit.

### PULSE-SKIPPING, Burst Mode OPERATION, SSFM, SYNC

The LT8357 can achieve low power consumption at light loads. The different SYNC/MODE pin states can be evaluated by the position of jumper JP1. It is easy to change from Burst Mode operation to pulse-skipping and to explore SSFM on, SSFM off, and external SYNC with this jumper.

Pulse-skipping allows low quiescent current at light load consumption without changing switching frequency until a very light load. Burst Mode operation allows the lowest light load power consumption and also has a unique low ripple feature on the LT8357. These two features can be explored further in the data sheet of the LT8357. For extremely light load power consumption on DC2937A, the feedback resistor R8 should be changed to a 10M resistor.

## QUICK START PROCEDURE

Also, the EN/UVLO pin should be shorted to  $V_{IN}$  and the R2 143k resistor should be removed. A super-low leakage Schottky diode can be used and the sense resistor can be adjusted. Then the quiescent current of the converter can drop very low. Please see the data sheet for details. Lower  $V_{OUT}$  conditions might have lower leakage as well.

Spread spectrum frequency modulation (SSFM) can be enabled to reduce the emissions of the converter. SSFM spreads the frequency between the  $R_T$  frequency and +19% higher.

If an external SYNC signal is provided, the SYNC option of J1 can be used to synchronize with an external clock. The clock frequency should be slightly higher than the  $R_T$  frequency for best performance.

### SPLIT GATE RESISTORS

The LT8357 features split gate drive pins. GATEP pulls the NMOS gate high and GATEN pulls the gate low. These rates can be set differently with two different gate

resistors. DC2937A features a  $5\Omega$  GATEP resistor R3 and a  $0\Omega$  GATEN resistor. The board user can evaluate different gate speeds for a balance of emissions, efficiency and thermal.

### EN/UVLO

R1 and R2 set the undervoltage lockout falling and rising thresholds. The LT8357 data sheet gives a formula for calculating these values. DC2937A has a falling UVLO threshold of 9.0V and a rising threshold of 10.0V. This threshold can easily be adjusted by changing resistors R1 and R2 according to the data sheet equations.

### PGOOD

The Power Good, PGOOD, flag indicates when the output voltage is valid on the LT8357. The PGOOD flag can be monitored with a simple multimeter at the PGOOD turret. A high signal indicates that the output voltage is within range and a low signal indicates that the output voltage is not within its valid range. See data sheet for details. The turret can be left floating when not in use.

## TEST RESULTS

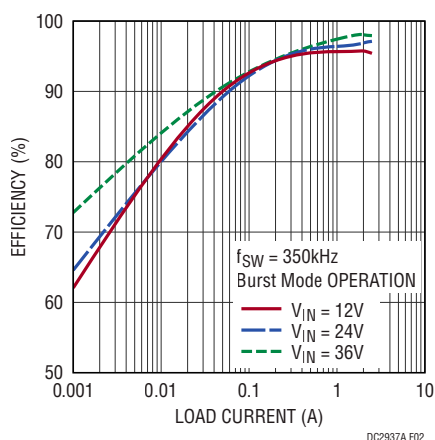

Figure 2. DC2937A Efficiency with Burst Mode Operation Enabled

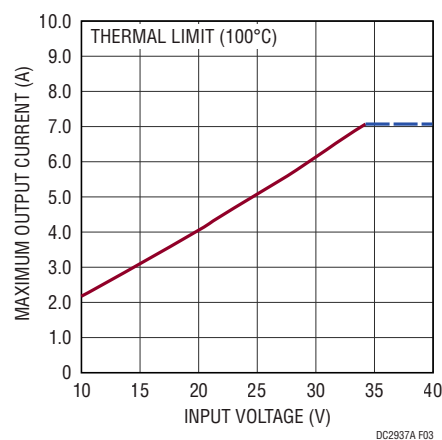
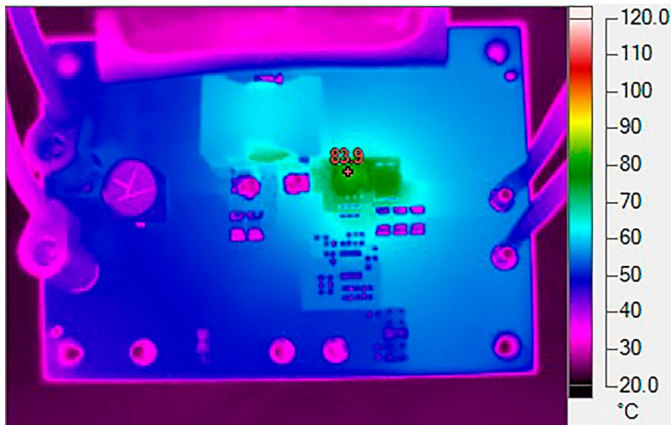
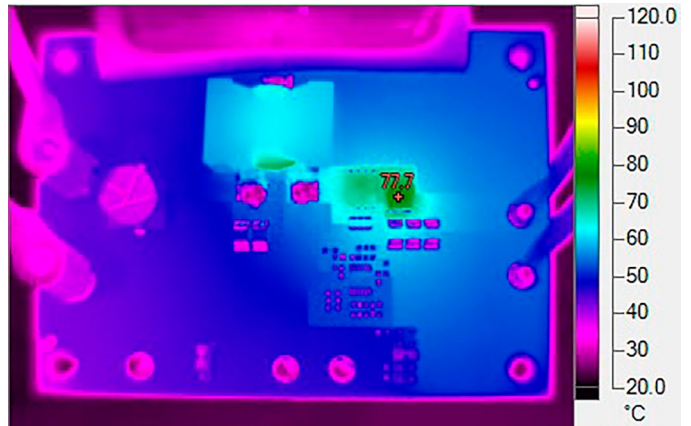

Figure 3. DC2937A Maximum Output Current vs Input Voltage

TEST RESULTS



(a) 12V<sub>IN</sub> 48V 2.5A Out



(b) 24V<sub>IN</sub> 48V 4A Out

Figure 4. DC2937A Thermals

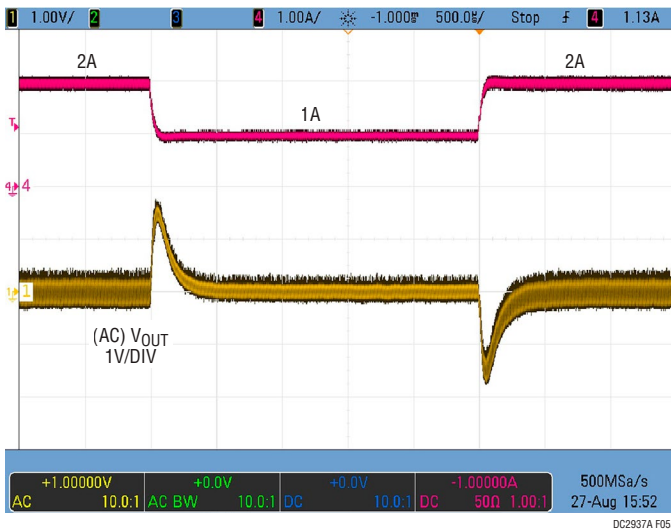

(a) 12V<sub>IN</sub> 48V 2A to 1A Transient

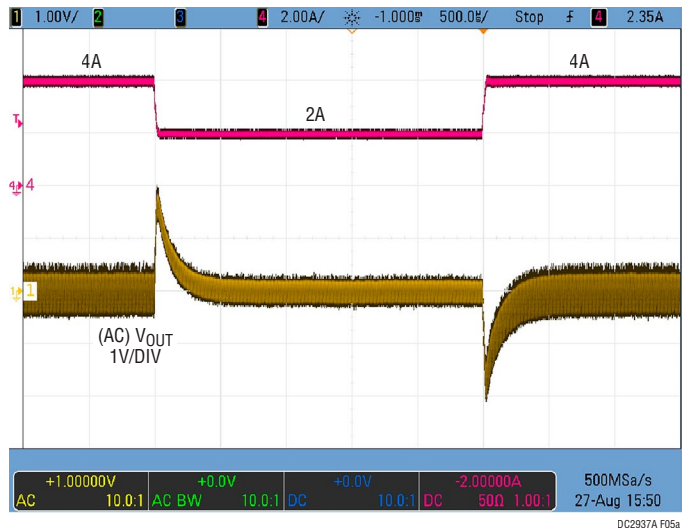

(b) 24V<sub>IN</sub> 48V<sub>OUT</sub> 4A to 2A Transient

Figure 5. DC2937A V<sub>OUT</sub> Transient Response

# DEMO MANUAL DC2937A

## PARTS LIST

ITEM	QTY	REFERENCE	PART DESCRIPTION	MANUFACTURER/PART NUMBER
<b>Required Circuit Components</b>				
1	5	C2, C3, C5–C7	CAP, 10 $\mu$ F, X7S, 100V, 10%, 1210	MURATA, GRM32EC72A106KE05L
2	1	C4	CAP, 1 $\mu$ F, X7R, 50V, 10%, 0603	AVX, 06035C105KAT2A
3	1	C10	CAP, 0.01 $\mu$ F, X7R, 50V, 10%, 0603, AEC-Q200	AVX, 06035C103K4T2A
4	1	C11	CAP, 0.1 $\mu$ F, X7R, 50V, 10%, 0603, AEC-Q200	TDK, CGA3E2X7R1H104K
5	1	C12	CAP, 2.2 $\mu$ F, X5R, 50V, 10%, 0603	TAIYO YUDEN, UMK107BBJ225KA-T
6	1	D1	DIODE, SCHOTTKY, 60V, 10A, T0277-3	ON SEMICONDUCTOR, FSV1060V
7	1	L1	IND., 4.2 $\mu$ H, POWER CHOKE SHIELDED, 15%, 24A, 3.04m $\Omega$ , 2013	WURTH ELEKTRONIK, 7443630420
8	1	Q1	XSTR., MOSFET, N-CHAN, 60V, 47A, 8-PIN TDSON	INFINEON, BSC094N06LS5ATMA1
9	2	R1, R8	RES., 1M $\Omega$ , 1%, 1/10W, 0603, AEC-Q200	VISHAY, CRCW06031M00FKEA
10	1	R2	RES., 143k, 1%, 1/10W, 0603, AEC-Q200	PANASONIC, ERJ3EKF1433V
11	1	R6	RES., 0.003 $\Omega$ , 1%, 1W, 1508 LONG-SIDE TERM	SUSUMU, RL3720WT-R003-F
12	1	R9	RES., 21.5k, 1%, 1/10W, 0603	VISHAY, CRCW060321K5FKEA
13	1	R10	RES., 10k, 1%, 1/10W, 0603, AEC-Q200	VISHAY, CRCW060310K0FKEA
14	1	R11	RES., 90.9k, 1%, 1/10W, 0603, AEC-Q200	VISHAY, CRCW060390K9FKEA
15	1	U1	IC, CURRENT MODE, DC/DC CONTROLLER, WIDE INPUT RANGE, MSOP-12	ANALOG DEVICES, LT8357JMSE#PBF
<b>Additional Demo Circuit Components</b>				
1	1	C1	CAP, 33 $\mu$ F, ALUM. ELECT, 63V, 20%, 10mm x10.5mm SMD	SUN ELECTRONIC INDUSTRIES CORP, 63HVH33M
2	1	C8	CAP, 1000pF, COG, 50V, 5%, 0603, AEC-Q200	TDK, CGA3E2C0G1H102J
3	1	C9	CAP, 100pF, COG, 50V, 5%, 0603, AEC-Q200	TDK, CGA3E2C0G1H101J080AA
4	0	C13	CAP, OPTION, 0603	
5	1	R3	RES., 4.99 $\Omega$ , 1%, 1/10W, 0603, AEC-Q200	VISHAY, CRCW06034R99FKEA
6	1	R4	RES., 0 $\Omega$ , 1/10W, 0603, AEC-Q200	VISHAY, CRCW06030000Z0EA
7	1	R5	RES., 1 $\Omega$ , 1%, 1/10W, 0603, AEC-Q200	NIC, NRC06F1R00TRF
8	1	R7	RES., 100k, 1%, 1/10W, 0603	STACKPOLE ELECTRONICS, INC., RMCF0603FG100K
9	1	R13	RES., 100k, 1%, 1/10W, 0603, AEC-Q200	VISHAY, CRCW0603100KFEA
10	0	R12	RES., OPTION, 0603	
<b>Hardware</b>				
1	5	E1–E5	TEST POINT, TURRET, 0.094" MTG. HOLE, PCB 0.062" THK	MILL-MAX, 2501-2-00-80-00-00-07-0
2	2	J1, J2	CONN., BANANA JACK, FEMALE, THT, NON-INSULATED, SWAGE, 0.218"	KEYSTONE, 575-4
3	1	JP1	CONN., HDR, MALE, 2x5, 2mm, VERT, ST, THT	WURTH ELEKTRONIK, 62001021121
4	1	JP2	CONN., HDR, MALE, 1x3, 2mm, VERT, ST, THT, NO SUBS. ALLOWED	WURTH ELEKTRONIK, 62000311121
5	4	MP1–MP4	STANDOFF, NYLON, SNAP-ON, 0.50"	KEYSTONE, 8833
6	2	XJP1, XJP2	CONN., SHUNT, FEMALE, 2 POS, 2mm	WURTH ELEKTRONIK, 60800213421

**SCHEMATIC DIAGRAM**

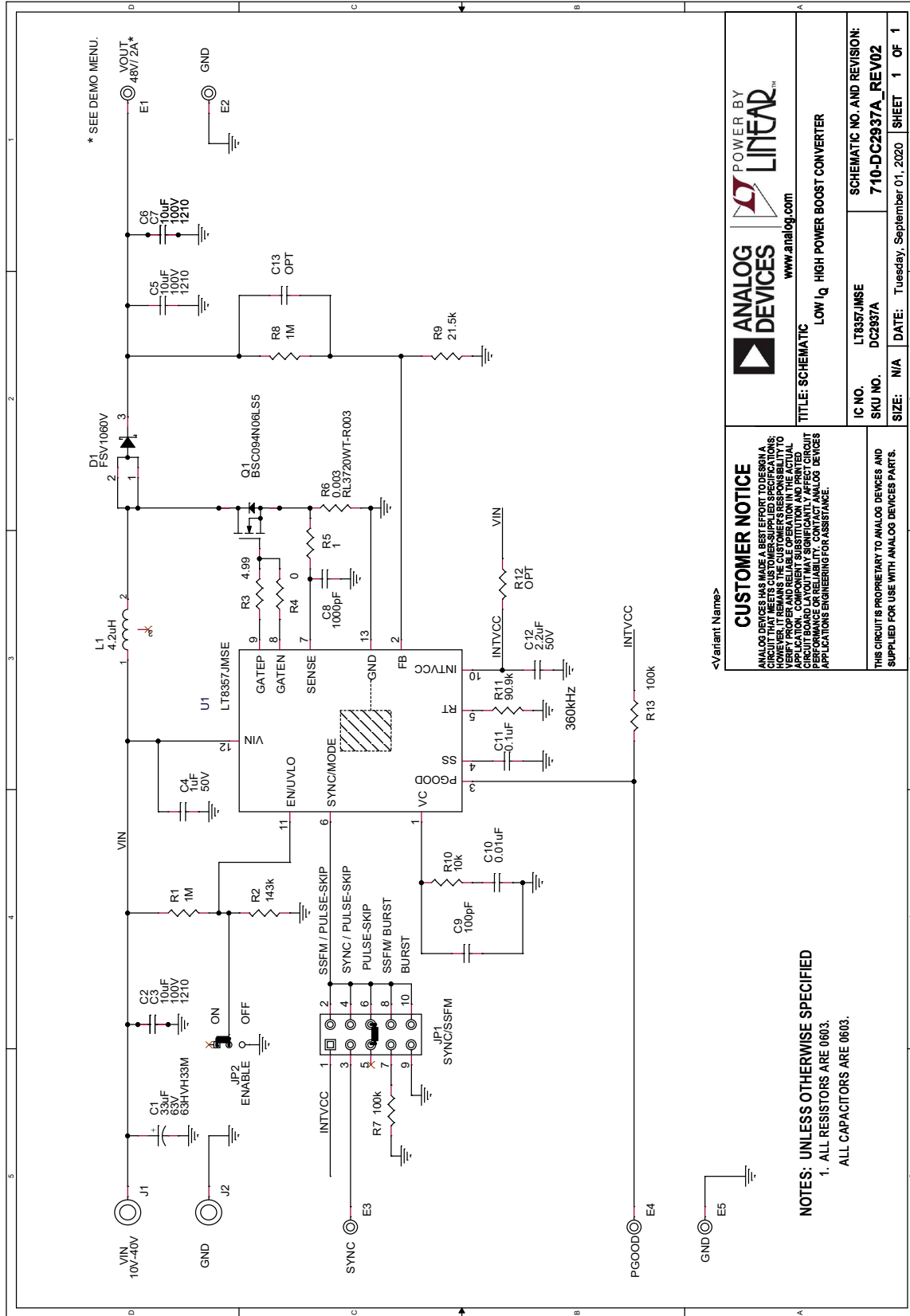



## ESD Caution

**ESD (electrostatic discharge) sensitive device.** Charged devices and circuit boards can discharge without detection. Although this product features patented or proprietary protection circuitry, damage may occur on devices subjected to high energy ESD. Therefore, proper ESD precautions should be taken to avoid performance degradation or loss of functionality.

## Legal Terms and Conditions

By using the evaluation board discussed herein (together with any tools, components documentation or support materials, the "Evaluation Board"), you are agreeing to be bound by the terms and conditions set forth below ("Agreement") unless you have purchased the Evaluation Board, in which case the Analog Devices Standard Terms and Conditions of Sale shall govern. Do not use the Evaluation Board until you have read and agreed to the Agreement. Your use of the Evaluation Board shall signify your acceptance of the Agreement. This Agreement is made by and between you ("Customer") and Analog Devices, Inc. ("ADI"), with its principal place of business at One Technology Way, Norwood, MA 02062, USA. Subject to the terms and conditions of the Agreement, ADI hereby grants to Customer a free, limited, personal, temporary, non-exclusive, non-sublicensable, non-transferable license to use the Evaluation Board FOR EVALUATION PURPOSES ONLY. Customer understands and agrees that the Evaluation Board is provided for the sole and exclusive purpose referenced above, and agrees not to use the Evaluation Board for any other purpose. Furthermore, the license granted is expressly made subject to the following additional limitations: Customer shall not (i) rent, lease, display, sell, transfer, assign, sublicense, or distribute the Evaluation Board; and (ii) permit any Third Party to access the Evaluation Board. As used herein, the term "Third Party" includes any entity other than ADI, Customer, their employees, affiliates and in-house consultants. The Evaluation Board is NOT sold to Customer; all rights not expressly granted herein, including ownership of the Evaluation Board, are reserved by ADI. CONFIDENTIALITY. This Agreement and the Evaluation Board shall all be considered the confidential and proprietary information of ADI. Customer may not disclose or transfer any portion of the Evaluation Board to any other party for any reason. Upon discontinuation of use of the Evaluation Board or termination of this Agreement, Customer agrees to promptly return the Evaluation Board to ADI. ADDITIONAL RESTRICTIONS. Customer may not disassemble, decompile or reverse engineer chips on the Evaluation Board. Customer shall inform ADI of any occurred damages or any modifications or alterations it makes to the Evaluation Board, including but not limited to soldering or any other activity that affects the material content of the Evaluation Board. Modifications to the Evaluation Board must comply with applicable law, including but not limited to the RoHS Directive. TERMINATION. ADI may terminate this Agreement at any time upon giving written notice to Customer. Customer agrees to return to ADI the Evaluation Board at that time. LIMITATION OF LIABILITY. THE EVALUATION BOARD PROVIDED HEREUNDER IS PROVIDED "AS IS" AND ADI MAKES NO WARRANTIES OR REPRESENTATIONS OF ANY KIND WITH RESPECT TO IT. ADI SPECIFICALLY DISCLAIMS ANY REPRESENTATIONS, ENDORSEMENTS, GUARANTEES, OR WARRANTIES, EXPRESS OR IMPLIED, RELATED TO THE EVALUATION BOARD INCLUDING, BUT NOT LIMITED TO, THE IMPLIED WARRANTY OF MERCHANTABILITY, TITLE, FITNESS FOR A PARTICULAR PURPOSE OR NON-INFRINGEMENT OF INTELLECTUAL PROPERTY RIGHTS. IN NO EVENT WILL ADI AND ITS LICENSORS BE LIABLE FOR ANY INCIDENTAL, SPECIAL, INDIRECT, OR CONSEQUENTIAL DAMAGES RESULTING FROM CUSTOMER'S POSSESSION OR USE OF THE EVALUATION BOARD, INCLUDING BUT NOT LIMITED TO LOST PROFITS, DELAY COSTS, LABOR COSTS OR LOSS OF GOODWILL. ADI'S TOTAL LIABILITY FROM ANY AND ALL CAUSES SHALL BE LIMITED TO THE AMOUNT OF ONE HUNDRED US DOLLARS (\$100.00). EXPORT. Customer agrees that it will not directly or indirectly export the Evaluation Board to another country, and that it will comply with all applicable United States federal laws and regulations relating to exports. GOVERNING LAW. This Agreement shall be governed by and construed in accordance with the substantive laws of the Commonwealth of Massachusetts (excluding conflict of law rules). Any legal action regarding this Agreement will be heard in the state or federal courts having jurisdiction in Suffolk County, Massachusetts, and Customer hereby submits to the personal jurisdiction and venue of such courts. The United Nations Convention on Contracts for the International Sale of Goods shall not apply to this Agreement and is expressly disclaimed.