

REVISIONS			
REV	DESCRIPTION	DATE	APPROVED

LT8410

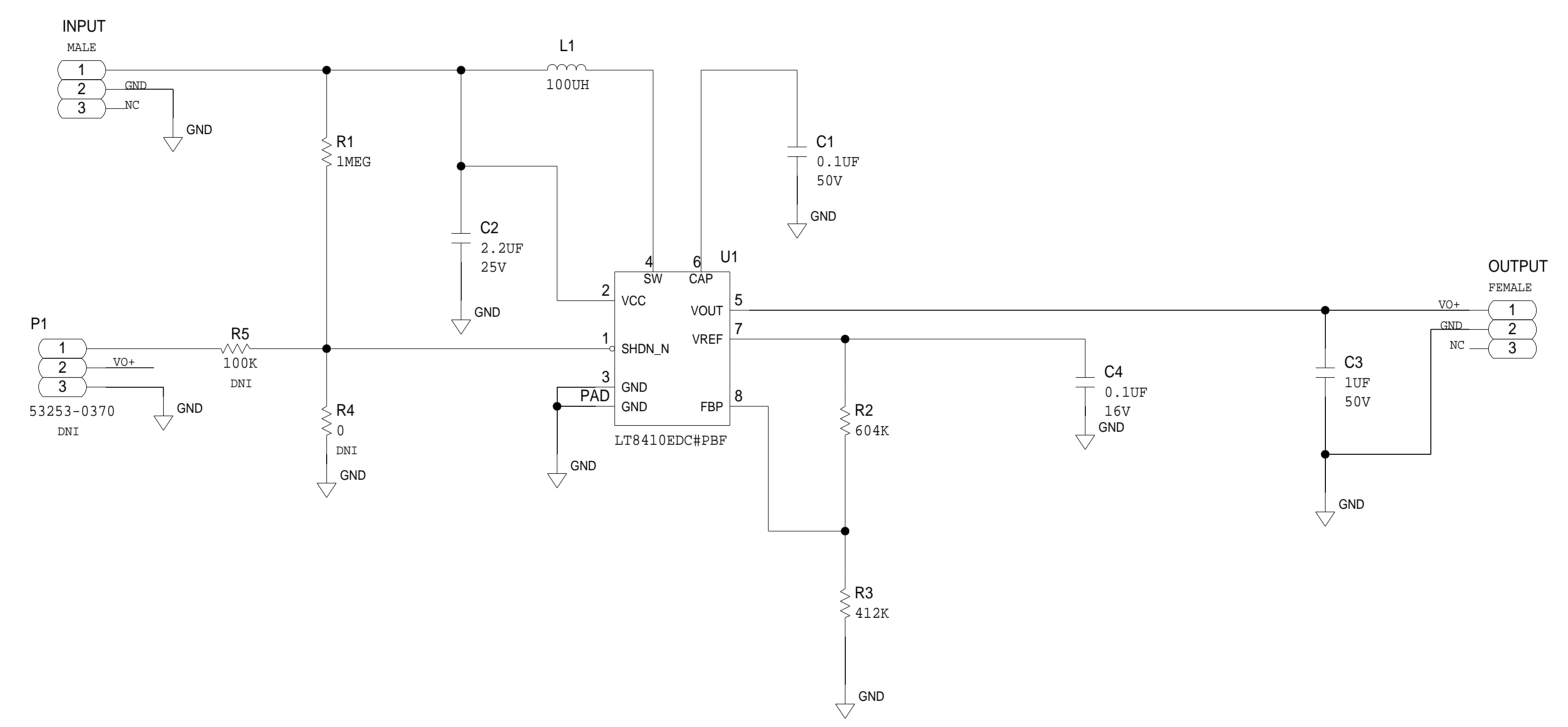

	SCHEMATIC		
	HW TYPE : SCP EVAL-Z Product(s) : LT8410 : LT8410		
	DESIGN VIEW <DESIGN_VIEW>	DRAWING NO. 02_051362	REV B
PTD ENGINEER J VIERNES	SIZE D	SCALE 1:1	SHEET 2 OF 2

