

DESIGN NOTES

Optimizing a DC/DC Converter's Output Capacitors with the LTC1435A – Design Note 198

Ajmal Godil and Craig Varga

All DC/DC power supplies comprise closed-loop systems. In any closed-loop system, control theory dictates the need for adequate gain and phase margin for overall system stability. Trade-offs have to be made between phase and gain margin and transient response by adjusting the feedback gain for a given power stage.

Some power IC controller manufacturers have designed their products with internal loop compensation. Hence, the user is forced to select power stage components (mainly C_{OUT}) to meet stability criteria. The LTC[®]1435A

step-down DC/DC controller, on the other hand, allows the power stage component values to be chosen based simply on power requirements and allows feedback gain to be set independently, thus allowing minimization of expensive bulk output capacitors. This important design freedom results from the OPTI-LOOP[®] architecture that makes the I_{TH} compensation point available in all Linear Technology DC/DC controllers.

LT, LT, LTC, LTM, OPTI-LOOP Linear Technology and the Linear logo are registered trademarks of Linear Technology Corporation. All other trademarks are the property of their respective owners.

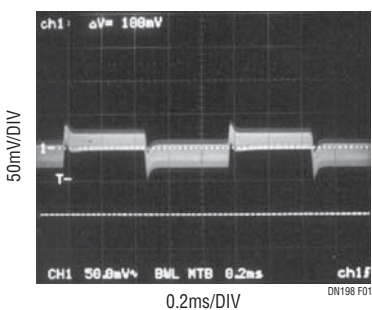

Figure 1. Transient Response of LTC1435A. $C_{OUT} = 2 \times 1500\mu\text{F}$ Sanyo VGX, $C_{C1} = 100\text{pF}$, $C_{C2} = 100\text{pF}$, $R_C = 33\text{k}$, $I_L = 0.5\text{A TO } 3\text{A}$, $V_{IN} = 12\text{V}$, $V_{OUT} = 3.3\text{V}$

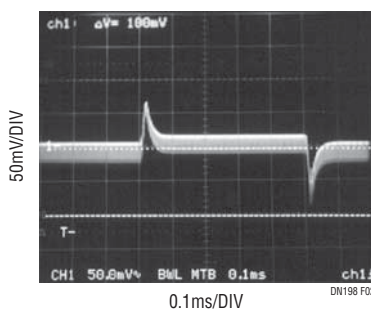

Figure 2. Transient Response of LTC1435A. $C_{OUT} = 2 \times 47\mu\text{F}$ OS-CON, $C_{C1} = 470\text{pF}$, $C_{C2} = 100\text{pF}$, $R_C = 22\text{k}$, $I_L = 0.5\text{A TO } 1.2\text{A}$, $V_{IN} = 12\text{V}$, $V_{OUT} = 3.3\text{V}$

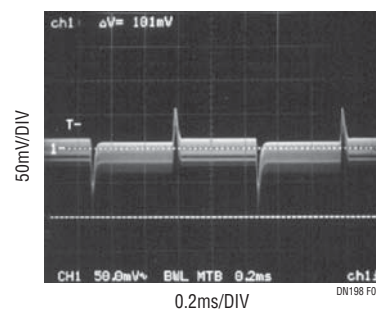

Figure 3. Transient Response of LTC1435A. $C_{OUT} = 1 \times 47\mu\text{F}$ OS-CON, $C_{C1} = 1000\text{pF}$, $C_{C2} = 100\text{pF}$, $R_C = 15\text{k}$, $I_L = 0.5\text{A TO } 1.2\text{A}$, $V_{IN} = 12\text{V}$, $V_{OUT} = 3.3\text{V}$

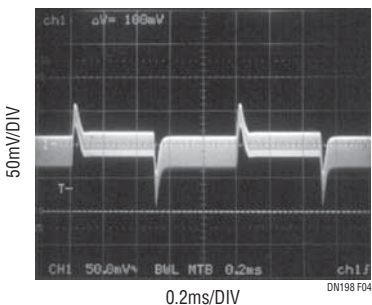

Figure 4. Transient Response of LTC1435A. $C_{OUT} = 2 \times 47\mu\text{F}$ POSCAP, $C_{C1} = 1000\text{pF}$, $C_{C2} = 100\text{pF}$, $R_C = 22\text{k}$, $I_L = 0.5\text{A TO } 1.8\text{A}$, $V_{IN} = 12\text{V}$, $V_{OUT} = 3.3\text{V}$

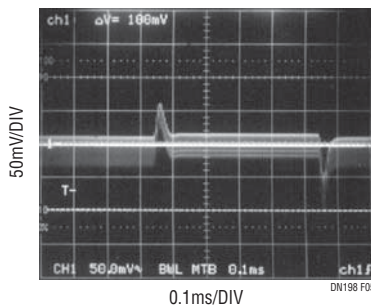

Figure 5. Transient Response of LTC1435A. $C_{OUT} = 1 \times 47\mu\text{F}$ Panasonic, SP, $C_{C1} = 1000\text{pF}$, $C_{C2} = 100\text{pF}$, $R_C = 15\text{k}$, $I_L = 0.5\text{A TO } 1.2\text{A}$, $V_{IN} = 12\text{V}$, $V_{OUT} = 3.3\text{V}$

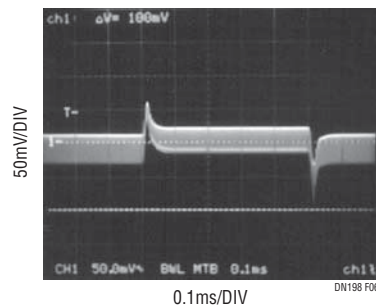

Figure 6. Transient Response of LTC1435A. $C_{OUT} = 2 \times 100\mu\text{F}$ NEOCAP, $C_{C1} = 180\text{pF}$, $C_{C2} = 100\text{pF}$, $R_C = 47\text{k}$, $I_L = 0.5\text{A TO } 2\text{A}$, $V_{IN} = 12\text{V}$, $V_{OUT} = 3.3\text{V}$

Figures 1 through 6 show the output transient response of an LTC1435A circuit (application schematic in Figure 7) using various kinds of output bulk capacitors. The amplitude of the transient response is less than $\pm 100\text{mV}$. In each case, the number of output bulk capacitors used was chosen to produce 50mV or less of output voltage ripple at $I_{\text{LOAD}} = 3.0\text{A}$. Figure 8 shows the phase and gain margin for the application circuit in Figure 7 for $C_{\text{OUT}} = 47\mu\text{F} \times 2$, 6.3V OS-CON capacitors. It can be observed from Figure 8 that the loop crosses 0dB at 21.8kHz and has a phase margin of 47.3° , which is more than enough for the loop to be unconditionally stable.

For each output capacitor type, the feedback loop compensation was adjusted for similar phase margin and dynamic performance. Note that the compensating resistor and capacitor values are not the same for each output capacitor configuration. Clearly, a fixed internal loop-compensation scheme does not allow optimization

for all applications. For any general purpose power supply controller, the ability to tailor the feedback loop to the power path offers a significant advantage to the designer.

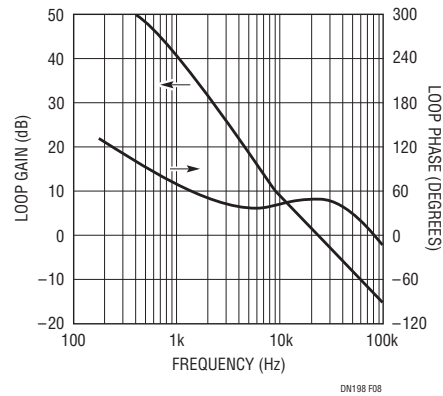

Figure 8. Loop Gain and Phase vs Frequency

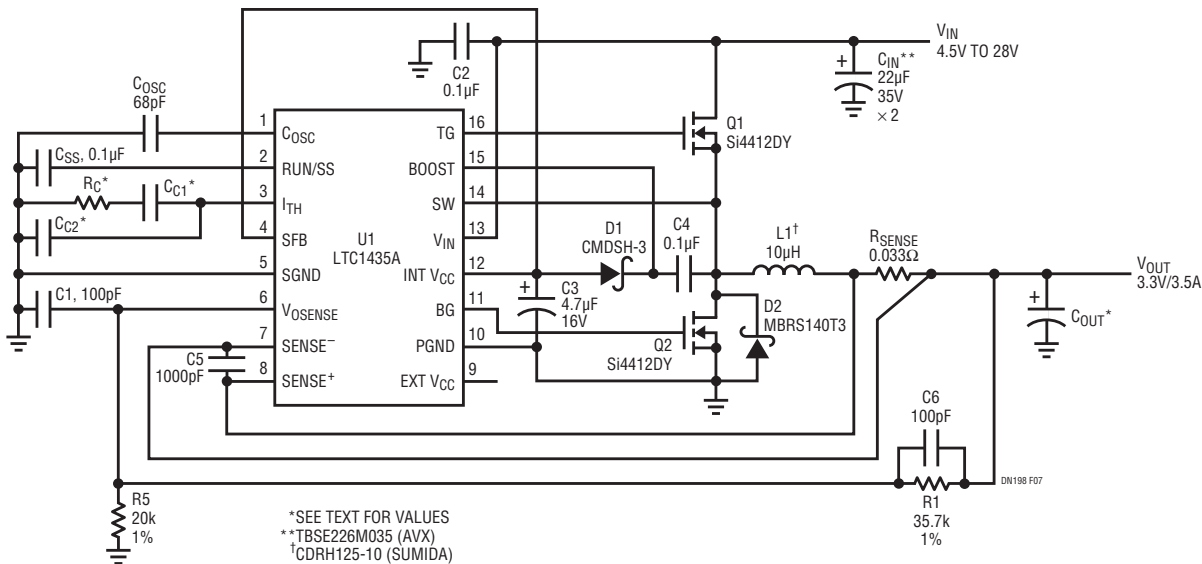

Figure 7. LTC1435A Constant Frequency, High Efficiency Converter

Data Sheet Download

www.linear.com

For applications help,
 call (408) 432-1900

Linear Technology Corporation
 1630 McCarthy Blvd., Milpitas, CA 95035-7417
 (408) 432-1900 • FAX: (408) 434-0507 • www.linear.com

dn198f_conv LT/TP 0199 340K • PRINTED IN THE USA

LINEAR
 TECHNOLOGY
 © LINEAR TECHNOLOGY CORPORATION 1999