

DESCRIPTION

Demonstration circuit 968A-D is isolated input to high current output 1/8th Brick footprint converter featuring the LT[®]1952 switching controller. The DC968-D converts isolated 36V to 75V input to 28V output and provides over 4A of output current. The converter operates at 300kHz with efficiency up to 95%. With proper amount of airflow, the DC968-D converter can generate up to 5A of output current. The DC968 can be easily modified to generate output voltages in the range from 0.6V to 48V. The output currents are limited by total output power of up to 200W. The other available versions of DC968A are:

DC968A-A 36-75Vin to 3.3V@30A

DC968A-B 18-36Vin to 5V@20A

DC968A-C 36-75Vin to 12V@12A

Also, the DC968 can be modified for other input voltages like 8V-36V, 18V-75V, 44V-52V, and so on. The wider input voltage range will decrease the converter

efficiency. Therefore, narrow input voltage range will be more desirable.

The DC968 circuit features soft-start which prevents output voltage overshoot on startup or when recovering from overload condition.

The DC968 has precise over-current protection circuit that allows for continuous operation under short circuit conditions. The low power dissipation under short circuit conditions insures high reliability even during short circuits.

The LT1952 can be synchronized to an external clock of up to 400kHz. Please refer to LT1952 data sheet for design details and applications information.

Design files for this circuit board are available. Call the LTC factory.

LT is a trademark of Linear Technology Corporation

Table 1. Performance Summary

PARAMETER	CONDITION	VALUE
Minimum Input Voltage	I _{OUT} = 0A to 4A	36V
Maximum Input Voltage	I _{OUT} = 0A to 4A	72V
V _{OUT}	V _{IN} = 36V to 72V, I _{OUT} = 0A to 4A	28V ±3%
Typical Output Ripple V _{OUT}	V _{IN} = 36V to 72V, I _{OUT} = 0A to 4A	100mV _{p-p}
Nominal Switching Frequency		300kHz

QUICK START PROCEDURE

Demonstration circuit 968 is easy to set up to evaluate the performance of LT1952 circuit. **Refer to Figure 1 for proper measurement equipment setup** and follow the procedure below:

NOTE: When measuring the input or output voltage ripple, care must be taken to avoid a long ground lead

on the oscilloscope probe. Measure the input or output voltage ripple by touching the probe tip directly across the V_{in} or V_{out} and GND terminals. See Figure 2. for proper scope probe technique.

1. With power off, connect the input power supply to V_{in} and GND. Make sure that the input power sup-

QUICK START GUIDE FOR DEMONSTRATION CIRCUIT 968A-D

ISOLATED DC/DC POWER CONVERTER

ply has sufficient current rating at minimum input voltage for the required output load.

2. Turn on the power at the input.

NOTE: Make sure that the input voltage does not exceed 75V.

3. Check for the proper output voltage.
 $V_{out} = 28V, \pm 3\%$.

If there is no output, temporarily disconnect the load to make sure that the load is not set too high.

4. Once the proper output voltage is established, adjust the load within the operating range and observe the output voltage regulation, ripple voltage, efficiency and other parameters.

5. The DC968 is equipped with an output capacitor CSYS (330uF) that approximates typical system rail capacitance. If system board already has capacitance of similar value CSYS can be removed.

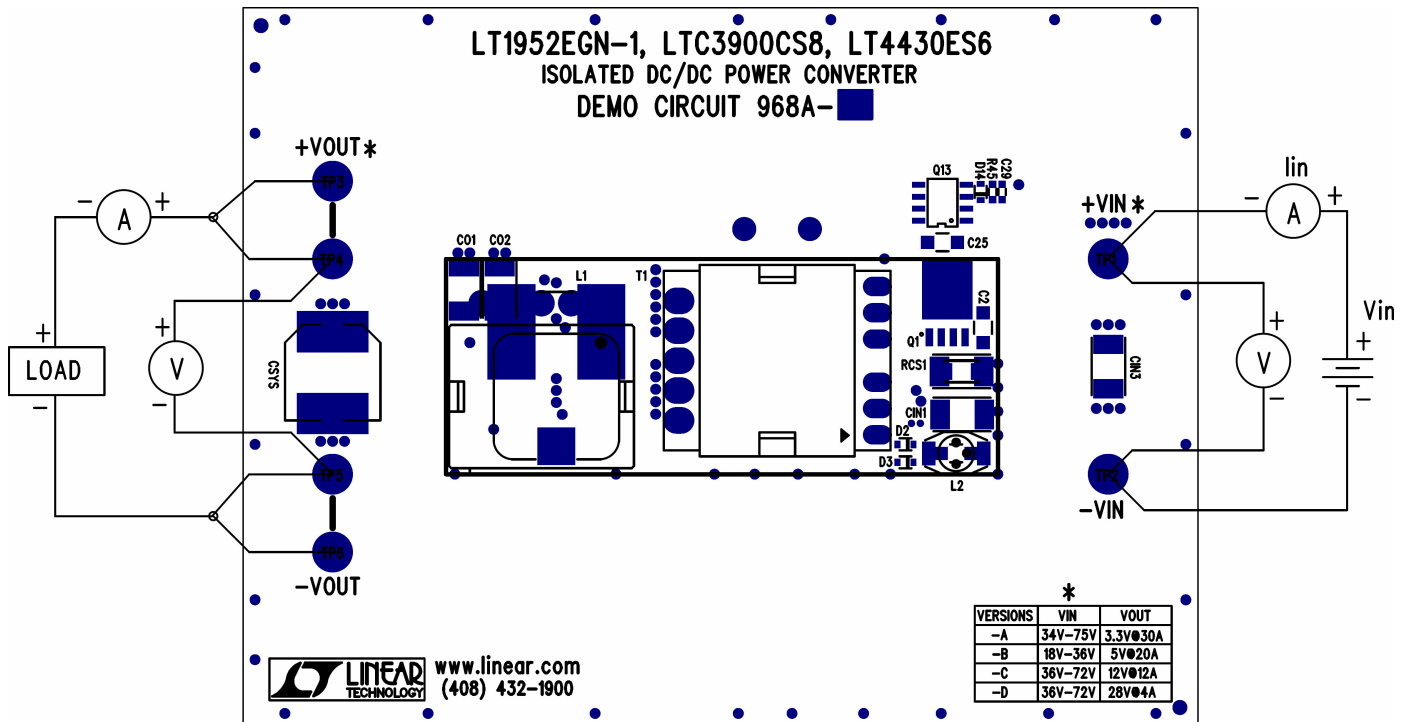

Figure 1. Proper Measurement Equipment Setup

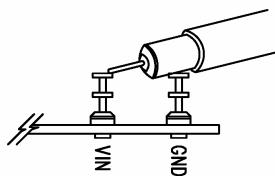

Figure 2. Scope Probe Placement for Measuring Input or Output Ripple

CHANGING THE OUTPUT VOLTAGE

To set the output voltage lower than 28V, change the bottom voltage divider resistor connected to LT4430 FB pin (see the **simplified schematic** on page 5). For example, to get 24V output, change R38 resistor value to 7.15k. However, keep in mind that changing the transformer as well may increase the efficiency. The schematic on page 6 shows all of the components on the PCB. The schematic on page 6 can be used as a reference if optional circuits need to be implemented.

To get higher than 28V output voltages transformer with higher turns ratio may be required. Also, output MOSFETs with higher voltage ratings may be required. Please contact LTC factory for details.

PRIMARY MOSFET DRIVER LTC4440

The DC968 has an LTC4440 MOSFET driver U2. The LTC4440 can be disabled if the efficiency is not important. If U2 is disabled, the DELAY pin of LT1952 should be readjusted to optimize the efficiency. Please contact LT factory for assistance.

RESET CIRCUIT

The DC968 is equipped with an active reset circuit. The active reset circuit is used in order to improve the efficiency by 1% to 2%.

If the efficiency is not important, active reset circuit can be disabled. In that case, MOSFET Q2 will need to be replaced with a MOSFET with higher voltage rating. Please contact LTC factory for help in selecting appropriate MOSFET. The active reset circuit

does not always help with the efficiency and is disabled on DC968-A, -B and -C demo boards.

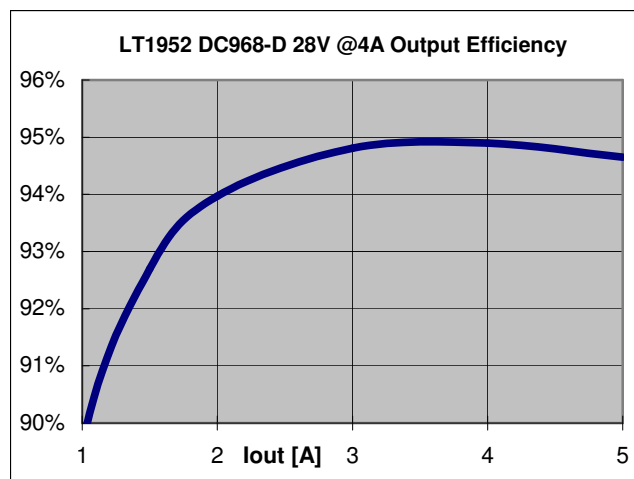

Figure 3. High efficiency of DC968A-D allows the board to be used in thermally critical applications with outputs up to 5A.

OUTPUT LOAD STEP RESPONSE

The load step response of DC968A-D is very fast even though relatively small amount of output capacitance is present (6.8uF ceramic and 330uF electrolytic). This is thanks to fast error amplifier of LT4430, optimal amount of current slope compensation of LT1952, fast opto coupler and fast error amplifier of LT1952. If higher load steps need to be handled more output capacitance can be added in order to keep the voltage transients at the desired level. The load step transients are shown in Figure 4.

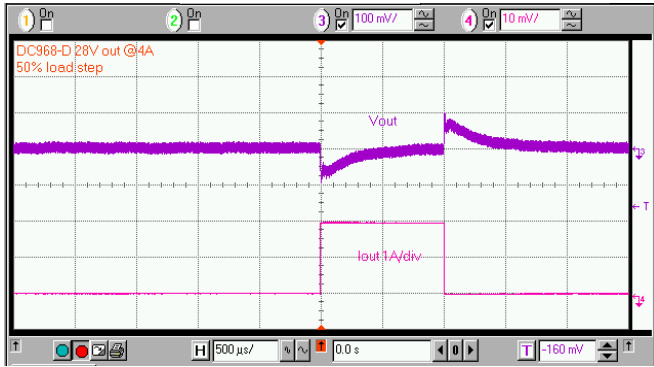

Figure 4. Fast transient response of DC968 is superior to many competing power modules without the additional output capacitors.

SOFT START FUNCTION

The DC968 features LT4430 opto coupler driver that has soft start function which produces monotonic startup ramp shown in Figure 5. The rise time of output voltage is controlled by capacitor C19 that is connected to OC (overshoot control) pin of LT4430.

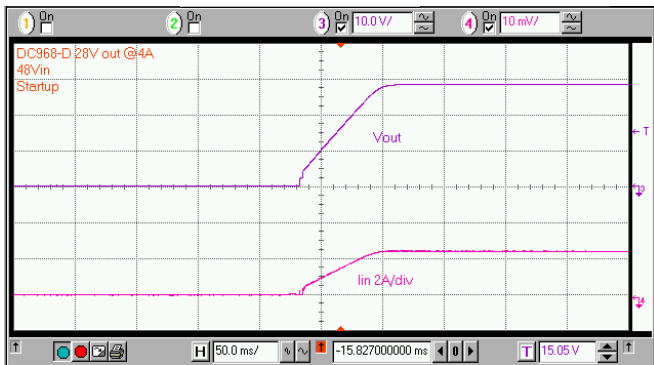

Figure 5. The LT4430 opto coupler driver produces monotonic output voltage rise at startup without output voltage overshoot.

DEBUGGING AND TESTING

The DC968 can easily be tested and debugged by powering the bias circuit with a separate power source. To place DC968 into debug mode remove the resistor R1 and connect 48V, 100mA power source to +Vb node (right side of R1). By doing this, the primary PWM controller LT1952 can be activated without the main primary power being applied to +Vin.

To activate the secondary side MOSFET driver (LTC3900) connect a 10V, 100mA power source to collector of Q9 via 1A, 40V diode. That way the current coming from DC968 bias supply will not be able to flow back to 10V supply once the converter is running.

Once the primary and secondary controllers are running the MOSFET gate timing can be checked.

If the MOSFET gate timing is correct the main power input can be applied to +Vin. The correct delay from turn on of FG and gate of Q1 is usually in the range from -100ns to +100ns. By slowly increasing the +Vin from 0V to 48V the output voltage and input current can be monitored. The input current should not exceed 100mA without the output load. If one of the MOSFETs is damaged, the input current will exceed 100mA.

QUICK START GUIDE FOR DEMONSTRATION CIRCUIT 968A-D

ISOLATED DC/DC POWER CONVERTER

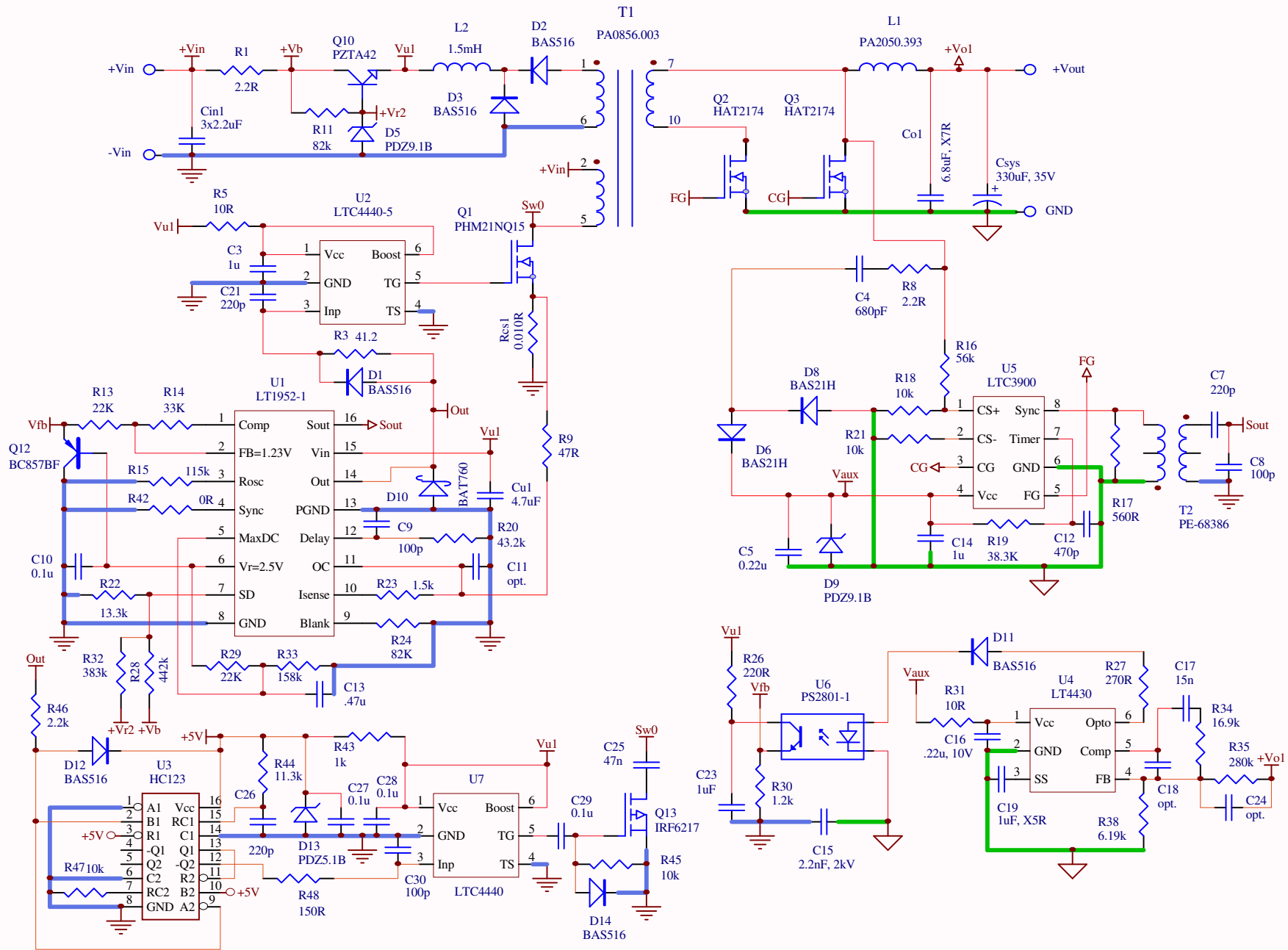

QUICK START GUIDE FOR DEMONSTRATION CIRCUIT 968A-D

ISOLATED DC/DC POWER CONVERTER

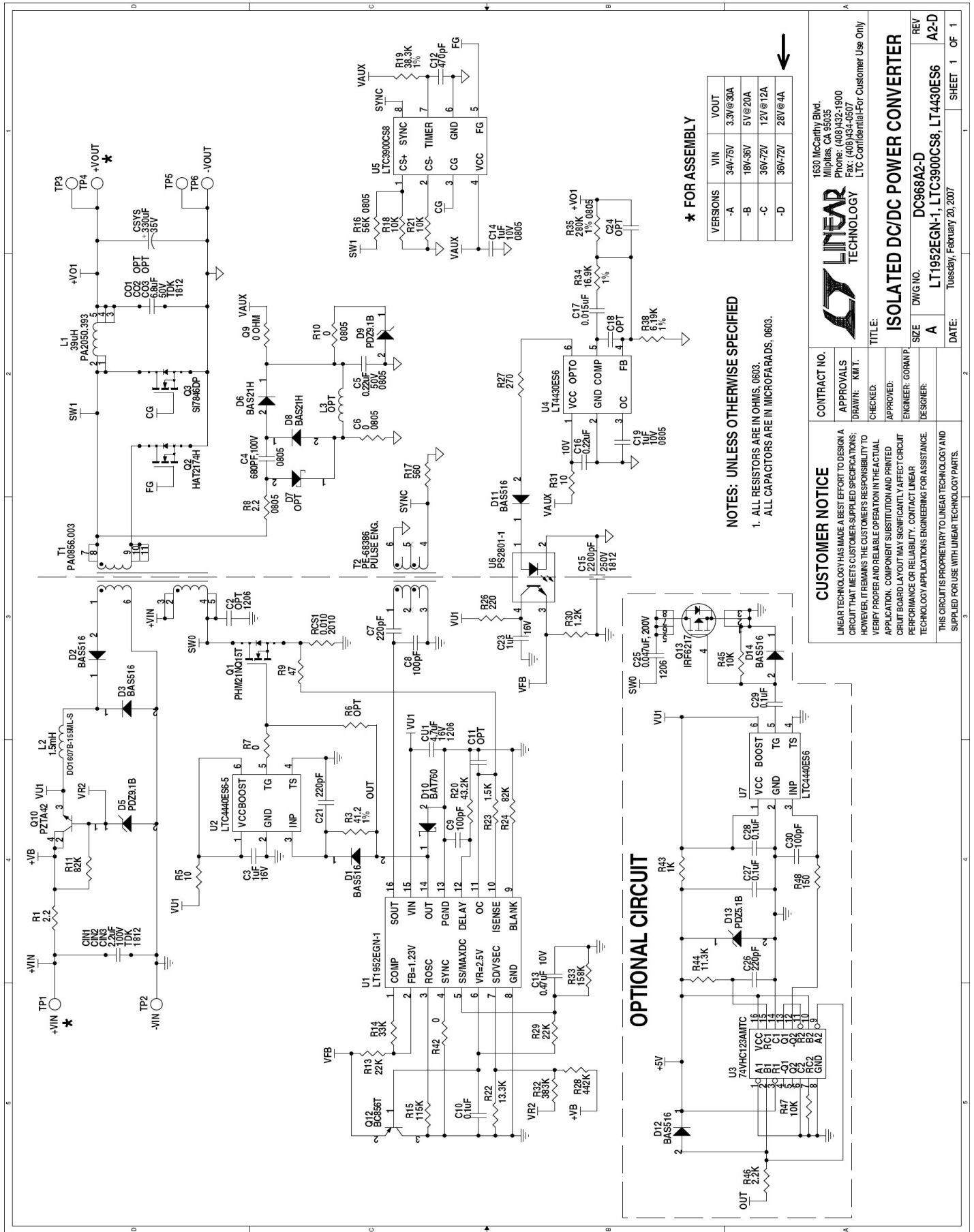

★ FOR ASSEMBLY

VERSIONS	VIN	VOUIT
-A	34V75V	3.3V@30A
-B	18V36V	5V@20A
-C	36V72V	12V@12A
-D	36V72V	28V@4A

NOTES: UNLESS OTHERWISE SPECIFIED

- ALL RESISTORS ARE IN OHMS, 0603.
- ALL CAPACITORS ARE IN MICROFARADS, 0603.

OPTIONAL CIRCUIT

CUSTOMER NOTICE
 LINEAR TECHNOLOGY HAS MADE A BEST EFFORT TO DESIGN A CIRCUIT THAT MEETS CUSTOMER-SUPPLIED SPECIFICATIONS; HOWEVER, IT REMAINS THE CUSTOMER'S RESPONSIBILITY TO VERIFY PROPER AND RELIABLE OPERATION IN THE ACTUAL APPLICATION. COMPONENT SUBSTITUTION AND PRINTED CIRCUIT BOARD LAYOUT MAY SIGNIFICANTLY AFFECT CIRCUIT PERFORMANCE OR RELIABILITY. CONTACT LINEAR TECHNOLOGY APPLICATIONS ENGINEERING FOR ASSISTANCE. THIS CIRCUIT IS PROPRIETARY TO LINEAR TECHNOLOGY AND IS SUPPLIED FOR USE WITH LINEAR TECHNOLOGY PARTS.

CONTRACT NO.	APPROVALS	DATE	REV
	DRAWN: KIM.T.	Tuesday, February 20, 2007	A2-D
TITLE:		SIZE	DWG NO.
ISOLATED DC/DC POWER CONVERTER		A	DC968A2-D
DRAWN: KIM.T.		DESIGNER:	LT1952EGN-1, LTC3900CS8, LT4430ES6
CHECKED:		ENGINEER: GORAN.P.	
APPROVED:		DESIGNER:	



1830 McCarthy Blvd.
 Milpitas, CA 95035
 Phone: (408)432-1900
 Fax: (408)434-0607
 LTC Confidential-For Customer Use Only