



October 15, 2002

## **DC420A-A DEMO BOARD QUICK START GUIDE**

### **DESCRIPTION**

The DC420A-A contains the LTC4400-1 RF power controller chip and can be used to test the RF detector and controller characteristics. The LTC4400-1 is a power controller for fast turn-on RF power amplifiers. This demo board has been designed to demonstrate the power control capability of the LTC4400-1 at input frequencies and powers ranges between 800MHz to 2700 MHz and  $-28$  to  $+18$  dBm, correspondingly.

### **OPEN-LOOP TEST PROCEDURES**

Refer to Figure 1 for test set-up. This set-up operates the device as an RF comparator. Connect 3.6V to the VBATT pin and connect the ground wire to GND on the DC420A-A board. Connect an RF signal generator to the RF SMA connector. Set the desired frequency and amplitude. Note: It is common practice to include a 3dB pad to minimize reflections back into the signal Generator. The RF signal generator must be off during the autozero mode. Connect 0V to the RAMP pin and connect the ground wire to GND. Connect an oscilloscope probe to VPC and connect the ground clip to GND.

After power up, apply a single step pulse to SHDNB equal to the VBATT voltage. When this pulse is low, the part is in shutdown mode. The RF input signal must be off, and the RAMP voltage must be at 0V.

When the SHDNB pulse switches high, the part is in autozero mode for 10 $\mu$ s then goes into enable mode. The VPC voltage will step up to the start voltage after autozero is completed. The output should look noisy since the LTC4400-1 is operating open-loop as a comparator and the autozero has perfectly balanced the amplifier. It will typically swing between 1 to 3V in an erratic fashion. If this does not occur, the part should be recycled through shutdown to make sure that the autozero correctly cancels the amplifier offsets. The autozero cancellation voltage will droop over time. Therefore, it is important to complete the measurement within 10 seconds.

The SHDNB pulse must remain high during the RAMP switch point measurement. To perform a measurement, set the RF signal generator to any frequency from 800MHz to 2700 MHz and RF output at  $-28$  to  $+18$  dBm. VPC will then switch low. Increase the RAMP voltage until VPC switches to a mid-point. This switch point voltage is the RF detected voltage referenced to RAMP. Increasing the RAMP voltage more will force VPC output going to upper rail, about 2.7 v.

MODE	SHDNB	OPERATION
Shutdown	Low	Disabled
Enable	High	Power Control

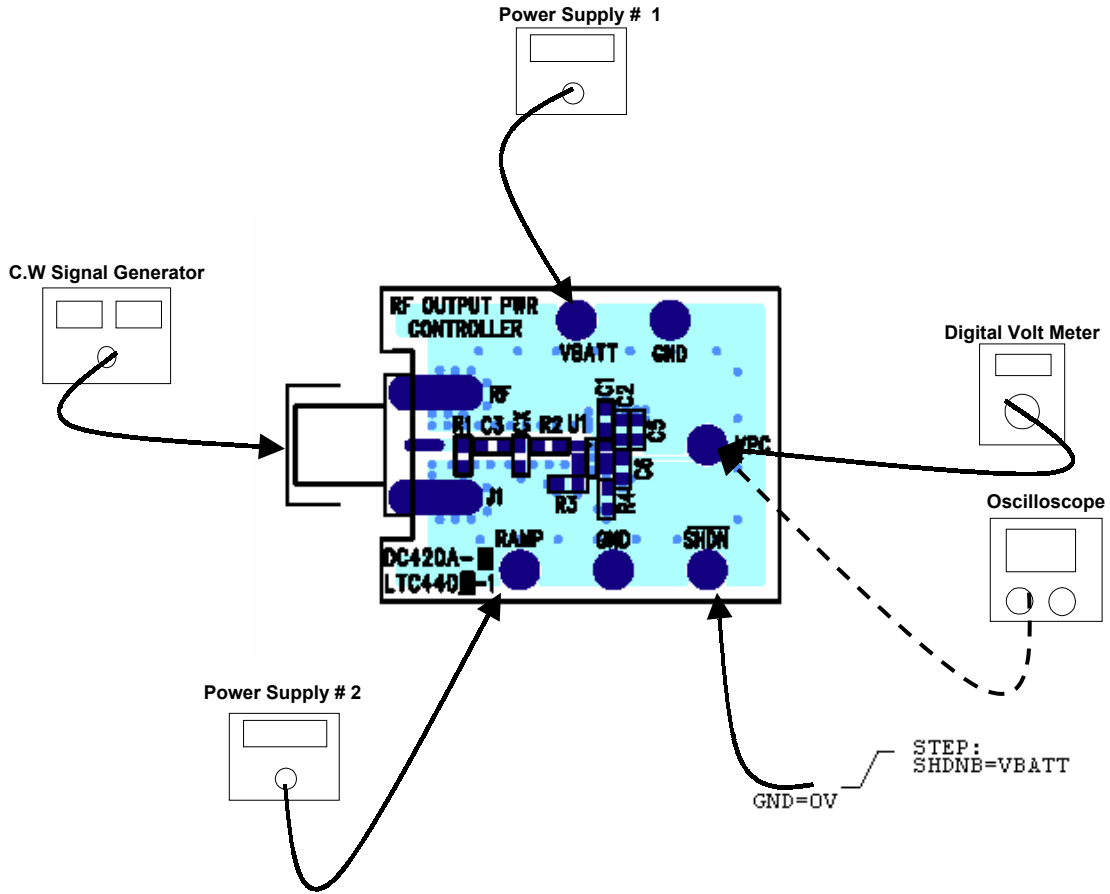
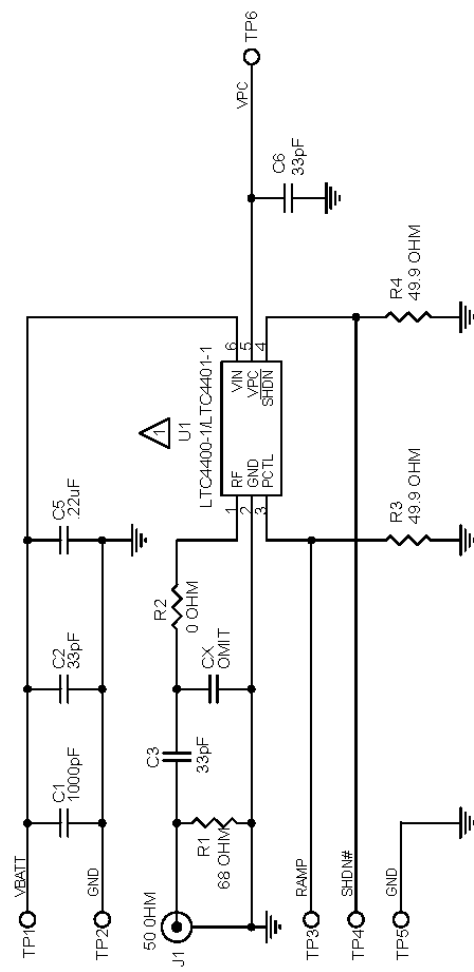

Figure 1. Test and measurement Set up diagram for DC420A-A

LTC CONFIDENTIAL - For Customer Use Only

REVISION HISTORY				
ECO	REV	DESCRIPTION	DATE	APPROVED
	1	INITIATED	3/29/01	
	2	CHG CAPS AND RES; C5, C6, R3; RMV R5.	06/01/01	



DASH	U1	DESCRIPTION
A		LTC4400-1ESX
B		LTC4401-1ESX

UNLESS OTHERWISE SPECIFIED  
DIMENSIONS ARE IN INCHES  
TOLERANCE ON ANGLE . . .  
2 PLACES . . . 3 PLACES . . .  
INTERPRET DIM AND TOL  
PER ASME Y14.5M-1994

THIRD ANGLE PROJECTION

DO NOT SCALE DRAWING

CONTRACT NO. \_\_\_\_\_

APPROVALS \_\_\_\_\_ DATE \_\_\_\_\_

DRAWN L.SANTOS 03/29/01

CHECKED \_\_\_\_\_

APPROVED \_\_\_\_\_

ENGINEER \_\_\_\_\_

DESIGNER \_\_\_\_\_

Tuesday, October 15, 2002

**LINEAR TECHNOLOGY**

SCH, LTC440X-1, RF OUTPUT POWER CONTROLLER PCB

SIZE	CAGE CODE	DWG NO	DC420A
REV			2

SCALE	NONE	FILENAME	DC420A_r2.DSN	SHEET	1	OF	1
-------	------	----------	---------------	-------	---	----	---

ITEM	QTY	REF	DESCRIPTION	MFR PART NUMBER
<b>ASSY VERSION "-A"</b>				
1	1	C1	CAP., NPO 1000pF 25V 5%	AVX 06033A102JAT1A
2	1	C5	CAP, X7R, .22uF, 25V, 5%	AVX 06033C223JAT1A
3	3	C2,C3,C6	CAP., NPO 33pF 50V 5%	AVX 06035A330JAT1A
4	0	CX	CAP, OMIT	OMIT
5	1	R2	RES., CHIP 0-OHM JUMPER	AAC CJ06-000JM
6	1	R1	RES., CHIP 68-OHM 1/16W 5%	AAC CR16-680JM
7	2	R3,R4	RES., CHIP 49.9 OHM 1/16W 1%	AAC CR16-49R9FM
8	1	U1	I.C., SOT23, RF PWR CNTRLR	LINEAR LTC4400-1ES6
9	1	J1	CONN., SMA .062" EDGE-LAUNCH	E.F. JOHNSON 142-0701-851-LN1
10	6	TP1-6	TESTPOINT, TURRET, .061	MILL-MAX 2308-2-00-44
<b>ASSY VERSION "-B"</b>				
8	1	U1	I.C., SOT23, RF PWR CNTRLR	LINEAR LTC4401-1ES6

## APPROVED VENDOR LIST

VENDOR	PHONE NUMBER	PART TYPE	WEBSITE ADDRESS
AAC (was TAD)	(800) 508-1521	CHIP RESISTORS	
AAC (was TAD)	(714) 255-9186		
AAVID	(714) 556-2665	HEAT SINKS	
ALLEN BRADLEY	(800) 592-4888	CARBON RESISTORS	
AMP	(717) 564-0100	PC MOUNT BNC	
APEM	(718) 246-1007	SMD TOGGLE/PB SWITCH	
API DELEVAN	(716) 652-3600	INDUCTORS	
AVX	(843) 946-0362	CHIP CAPS	
AVX	(843) 946-0524	CHIP RESISTORS	
AVX	(207) 282-5111	TANTALUM CAPS	
AVX	(843) 946-0323	HIGH VOLTAGE CAPS	
BERG	(800) 237-2374	CONNECTORS	
BH ELECTRONICS	(952) 894-9590	INDUCTORS	
BI TECHNOLOGIES	(714) 447-2656	TRANSFORMERS	
BI TECHNOLOGIES	(714) 447-2345	RES./RES. NETWORKS	
BOURNS	(801) 750-7253	POTENTIOMETERS, SIPS	
CADDOCK ELECTRONICS	(541) 496-0700	HIPO. RES., SIPS, DIPS	
CENTRAL SEMI	(631) 435-1110	SMALL SIGNAL DISCRETES	
CHICAGO MINIAT. LAMP	(201) 489-8989	LEDS	
COILCRAFT	(847) 639-6400	INDUCTORS	
COMM CON	(626) 301-4200	HEADERS, SHUNTS	
CONNEX	(805) 378-6464	BNC CONNECTORS	
COOPER ELECT. TECH.	(561) 752-5000	INDUCTORS	
CORNELL DUBILIER	(508) 996-8561	CAPACITORS	
CTS	(219) 293-7511	RESISTOR ARRAYS	
CUI-STACK	(503) 643-4899	POWER CONNECTORS	
DALE (see Vishay)	(605) 665-1627	INDUCTORS	
DALE (see Vishay)	(605) 665-9301	SENSE RESISTORS	
DATA DISPLAY PRODUCT	(800) 421-6815	LEDS	
DIODES INC.	(805) 446-4800	DIODES	
ELECTRONIC CONCEPTS	(908) 542-7880	400V FILM CAPACITORS	
EPSON	(310) 787-6300	CRYSTALS	
FAIRCHILD	(207) 775-4502	LOGIC	
FAIRCHILD	(408) 822-2126	MOSFETS	
FAIRCHILD	(888) 522-5372	CRG (CUST. RESPONSE)	
FCI	(717) 767-8005	HOT PLUG CONNECTORS	
FUKUSHIMA	(818) 765-8300	MPC RESISTORS	
FUJI	(201) 712-0555	SCHOTTKY DIODES	
GENERAL SEMICONDUCTOR	(516) 847-3000	DIODES	
GOWANDA	(716) 532-2234	INDUCTORS	
GRAYHILL	(708) 354-1040	DIP SWITCHES	
HARRIS	(800) 442-7747	LOGIC	
HEWLETT PACKARD	(800) 235-0312	IR LED	
HITACHI	(408) 433-1990	RF POWER AMPS	

IDT	(408) 727-6116	LOGIC IC
IR	(310) 322-3331	MOSFETS
IRC	(361) 992-7900	SENSE RESISTORS
ITW PAKTRON	(708) 667-3444	CAPACITORS
JOHNSON COMPONENTS	(650) 948-6533	RF CONNECTORS
JOHNSON COMPONENTS	(760) 434-5961	RF CONNECTORS
KEMET	(408) 986-0424	TANTALUM CAPS
KEMET	(864) 963-6300	CRG (CUST. RESPONSE)
KETEMA	(714) 630-0081	SURGE SUPPRESSORS
KEYSTONE	(718) 956-8900	JACKS, TURRETS
LITEON	(408) 241-4588	LEDS, DIODES
LTC	(408) 432-1900	HIGH PERF. I.C.S
MAGNETICS	(800) 245-3984	TOROID CORES ETC.
MARCON	(847) 696-2000	HIGH C/V CAPACITORS
METHODE	(800) 323-6864	ZIF SOCKETS
MF ELECTRONICS	(914) 576-6570	CRYSTAL OSCILLATORS
MICROCHIP	(602) 786-7200	MICROCONTROLLER IC
MICRO PLASTICS	(870) 453-8861	NYLON STANDOFFS
MICRO-SEMI	(617) 926-0404	DIODES
MIDCOM	(605) 886-4385	INDUCTORS
MIDCOM	(800) 643-2661	INDUCTORS
MILL-MAX	(516) 922-6000	TURRETS
MINICIRCUITS	(718) 934-4500	RF TRANSFORMERS
MOTOROLA	(800) 441-2447	LOGIC, REGS
MURATA ELECTRONICS	(770) 436-1300	CAPS., INDUCTORS,
MURATA ELECTRONICS	(800) 831-9172	CRG (CUST. RESPONSE)
MURATA ELECTRONICS	(770) 433-5789	RF DEVICES
NEC/TOKIN	(510) 324-4110	INDUCTORS/HI C/V CAPS
NICHIA	(408) 573-0933	WHITE LEDS
NICHICON	(847) 843-7500	ELECTROLYTIC CAPACITOR
ON SEMICONDUCTOR	(602) 244-6600	DISCRETE DIODES ETC.
ON SHORE	(602) 921-3000	TERMINATORS
PANASONIC	(714) 373-7334	INDUCTORS, POLY CAPS
PANASONIC	(201) 348-5217	LEDS
PANASONIC	(201) 373-7334	SWITCHES
PERICOM	(408) 435-0800	LOGIC IC
PHILIPS	(914) 246-2811	INDUCTORS
PHILIPS	(914) 247-2036	PLANAR INDUCTORS
PHILIPS	(508) 851-2200	DISCRETES, I.C.s
PULSE	(619) 674-8100	INDUCTORS
QT OPTOELECTRONICS	(408) 720-1440	RF SWITCH
RAYCHEM	(800) 227-4856	FUSES
RG ALLEN	(818) 765-8300	METAL OXIDE RESISTORS
RF MICRO DEVICES	(336) 664-1233	RF2138 / RF2140
SAMTEC	(800) 726-8329	WIRE JUMPERS
SANYO	(619) 661-6835	OSCON CAPS
SCHOTT	(507) 532-3201	INDUCTORS, XFORMERS
SCHURTER	(707) 778-6311	FUSES AND HOLDERS

SIGNATRON	(909) 464-1883	DB9 CONNECTORS
SIEMENS	(108) 257-7910	OPTO
SILICONIX	(800) 554-5565	MOSFETS
SILICONIX	(408) 988-8000	MOSFETS
SPRAGUE	(207) 324-4140	CAPACITORS
SULLINS	(760) 744-0125	HEADERS, SHUNTS
SUMIDA	(847) 956-0667	INDUCTORS
SUMIDA	(408) 982-9660	INDUCTORS
TAIYO YUDEN	(408) 573-4150	CHIP CAPS / RES.
TAIYO YUDEN	(800) 348-2496	CRG (CUST. RESPONSE)
TEKTRONIX	(800) 835-9433	SCOPE PROBE SOCKETS
TEMIC	(408) 970-5700	IR PHOTO DIODE
THERMALLOY	(972) 243-4321	HEAT SINKS
THIN FILM TECHNOLOGY	(507) 625-8445	THIN FILM CHIP RESISTORS
TOCOS	(847) 884-6664	SMD POTENTIOMETERS
TOKIN (NEC)	(510) 324-4110	CAPS, INDUCTORS,
TOKO	(847) 699-3430	RF PRODUCTS
TOSHIBA	(714) 455-2000	SINGLE GATE LOGIC
TOSHIBA	(949) 455-2000	LOGIC
UNITED CHEMICON	(847) 696-2000	ELECTROLYTIC CAPACITOR
VISHAY	(605) 665-9301	ZENER/SM. SIGNAL DIODES
VISHAY	(605) 665-9301	INDUCTORS, SENSE Rs
VITRAMON	(203) 268-6261	CERAMIC CHIP CAPACITOR
WIMA	(914) 347-2474	PAPER/FILM CAPACITORS
ZETEX	(631) 366-5068	SMALL SIGNAL DISCRETES
ZIERICK	(800) 882-8020	STAKED PINS





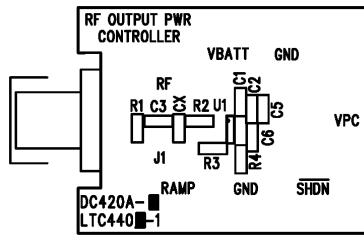

DC420A SILKSCREEN TOP  
LTC4400-1/LTC4401-1  
RF OUTPUT POWER CONTROLLER

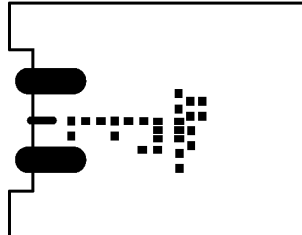

DC420A PASTE MASK TOP  
LTC4400-1/LTC4401-1  
RF OUTPUT POWER CONTROLLER

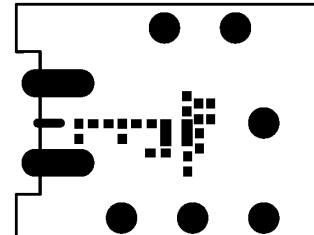

DC420A SOLDER MASK TOP  
LTC4400-1/LTC4401-1  
RF OUTPUT POWER CONTROLLER

DO NOT MODIFY INNER LAYER COPPER BACKOFF OUTLINE.

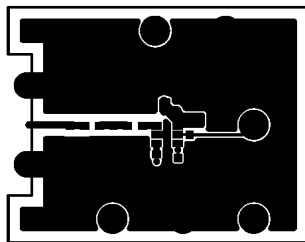

DC420A L1-COMPONENT SIDE  
LTC4400-1/LTC4401-1  
RF OUTPUT POWER CONTROLLER

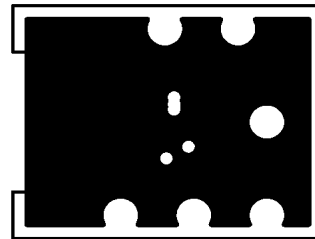

DC420A L2-GND PLANE 1  
LTC4400-1/LTC4401-1  
RF OUTPUT POWER CONTROLLER

DO NOT MODIFY INNER LAYER COPPER BACKOFF OUTLINE.

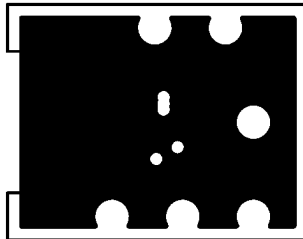

DC420A L3-GND PLANE 2  
LTC4400-1/LTC4401-1  
RF OUTPUT POWER CONTROLLER

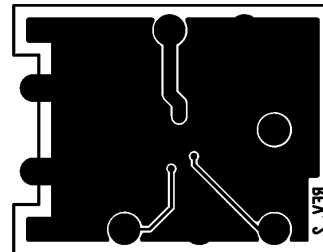

DC420A L4-SOLDER SIDE  
LTC4400-1/LTC4401-1  
RF OUTPUT POWER CONTROLLER

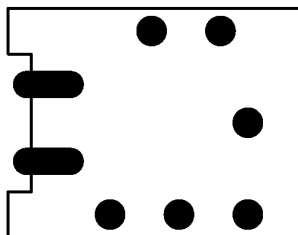

DC420A SOLDER MASK BTM  
LTC4400-1/LTC4401-1  
RF OUTPUT POWER CONTROLLER

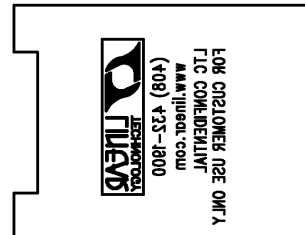

DC420A SILKSCREEN BOTTOM  
LTC4400-1/LTC4401-1  
RF OUTPUT POWER CONTROLLER