

LTM4677EY and LTM4650 Step-Down μ Module Regulator with PMBus Power System Management LTM4677 + 3x LTM4650, 186A

DESCRIPTION

Demonstration circuit 2481A-B is a high efficiency, high density, μ Module[®] regulator with 4.5V to 16V input range. The output voltage is adjustable from 0.5V to 1.8V, and it can supply 186A maximum load current. The demo board has 1x LTM[®]4677 and 3x LTM4650 μ Module regulators. The LTM4677 is a dual 18A or single 36A step-down regulator with PMBus power system management, and the LTM4650 is a dual 25A or single 50A step-down regulator. Please see LTM4677 and LTM4650 data sheets for more detailed information.

DC2481A-B powers up to default settings and produce power based on configuration resistors without the need for any serial bus communication. This allows easy evaluation of the DC/DC converter. To fully explore the extensive power system management features of the part, download the GUI software LTpowerPlay[®] onto your PC and use

LT's I²C/SMBus/PMBus dongle DC1613A to connect to the board. LTpowerPlay allows the user to reconfigure the part on the fly and store the configuration in EEPROM, view telemetry of voltage, current, temperature and fault status

GUI Download

The software can be downloaded from:

<http://www.linear.com/ltpowerplay>

For more details and instructions of LTpowerPlay, please refer to LTpowerPlay Software GUI.

Design files for this circuit board are available at
<http://www.linear.com/demo/DC2481A-B>

LT, LT, LTC, LTM, μ Module, LTpowerPlay, Linear Technology and the Linear logo are registered trademarks of Linear Technology Corporation. All other trademarks are the property of their respective owners.

BOARD PHOTO

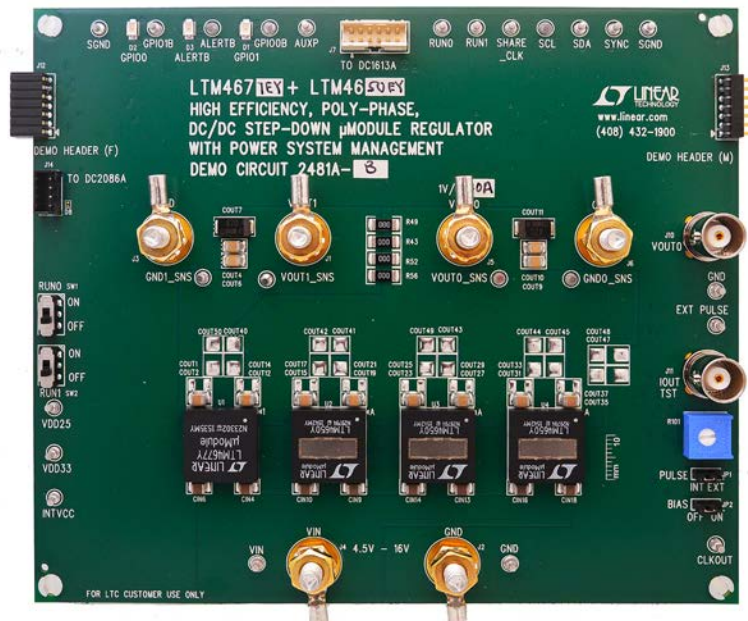

Figure 1. LTM4677 + 3x LTM4650; 186A DC2481A-B Demo Circuit

DEMO MANUAL DC2481A-B

PERFORMANCE SUMMARY Specifications are at $T_A = 25^\circ\text{C}$

PARAMETER	CONDITIONS	VALUE
Input Voltage Range		4.5V to 16V
Output Voltage, V_{OUT0}	$V_{IN} = 4.5\text{V to }16\text{V}$, $I_{OUT0} = 0\text{A to }186\text{A}$	0.5 to 1.8V, Default: 1V
Maximum Output Current, I_{OUT0}	$V_{IN} = 4.5\text{V to }16\text{V}$, $V_{OUT} = 0.5\text{V to }1.8\text{V}$	186A
Typical Efficiency	$V_{IN} = 12\text{V}$, $V_{OUT} = 1.0\text{V}$, $I_{OUT} = 186\text{A}$	85.8%
Default Switching Frequency		425kHz

QUICK START PROCEDURE

MAXIMUM OUTPUT CURRENT	NUMBER OF OUTPUT VOLTAGES	NUMBER OF LTM4677 μ MODULE REGULATORS ON THE BOARD	DEMO BOARD NUMBER
Dual 18A	2	1 \times LTM4677	DC2066A
72A	1	2 \times LTM4677	DC2143A-A
108A	1	3 \times LTM4677	DC2143A-B
144A	1	4 \times LTM4677	DC2143A-C
86A	1	1 \times LTM4677 (+1 \times LTM4650)	DC2481A-A
186A	1	1 \times LTM4677 (+3 \times LTM4650)	DC2481A-B

Demonstration circuit 2481A-B is easy to set up to evaluate the performance of the LTM4677EY. Refer to Figure 2 for the proper measurement equipment setup and follow the procedure below.

1. With power off, connect the input power supply to V_{IN} (4.5V to 16V) and GND (input return).
2. Connect the 1.0V output load between V_{OUT0} and GND (Initial load: no load).
3. Connect the DVMs to the input and outputs. Set default switch position: SW1: ON; SW2: ON.
4. Turn on the input power supply and check for the proper output voltages. V_{OUT0} should be $1.0\text{V} \pm 1\%$.
5. Once the proper output voltages are established, adjust the loads within the operating range and observe the output voltage regulation, ripple voltage and other parameters.
6. Connect the dongle and control the output voltages from the GUI. See "LTpowerPlay Software GUI" for details.

Note: When measuring the output or input voltage ripple, do not use the long ground lead on the oscilloscope probe. See Figure 3 for the proper scope probe technique. Short, stiff leads need to be soldered to the (+) and (-) terminals of an output capacitor. The probe's ground ring needs to touch the (-) lead and the probe tip needs to touch the (+) lead.

Connecting a PC to DC2481A-B

You can use a PC to reconfigure the power management features of the LTM4677 such as: nominal V_{OUT} , margin set points, OV/UV limits, temperature fault limits, sequencing parameters, the fault log, fault responses, GPIOs and other functionality. The DC1613A dongle may be plugged when V_{IN} is present.

QUICK START PROCEDURE

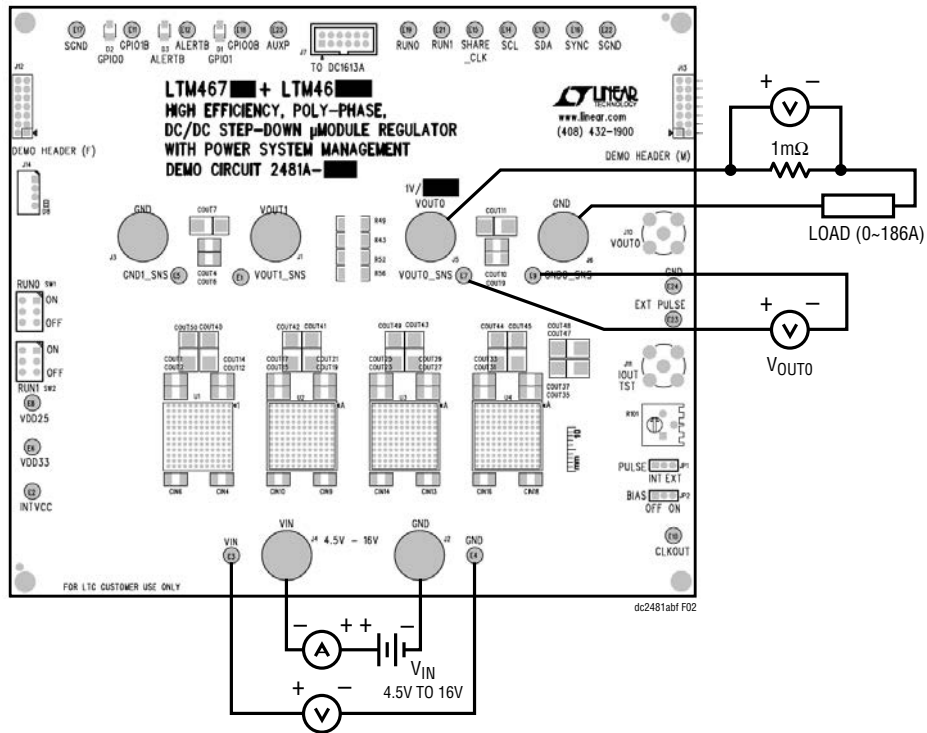

Figure 2. Proper Measurement Equipment Setup

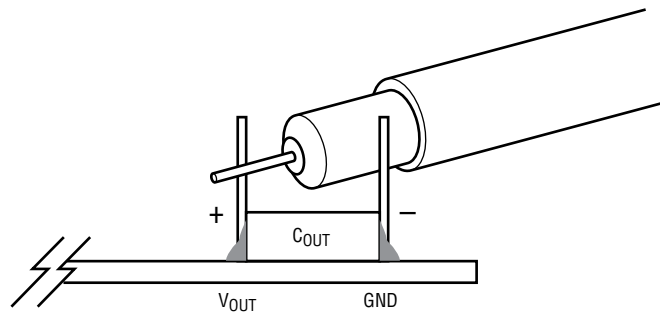

Figure 3. Measuring Output Voltage Ripple

QUICK START PROCEDURE

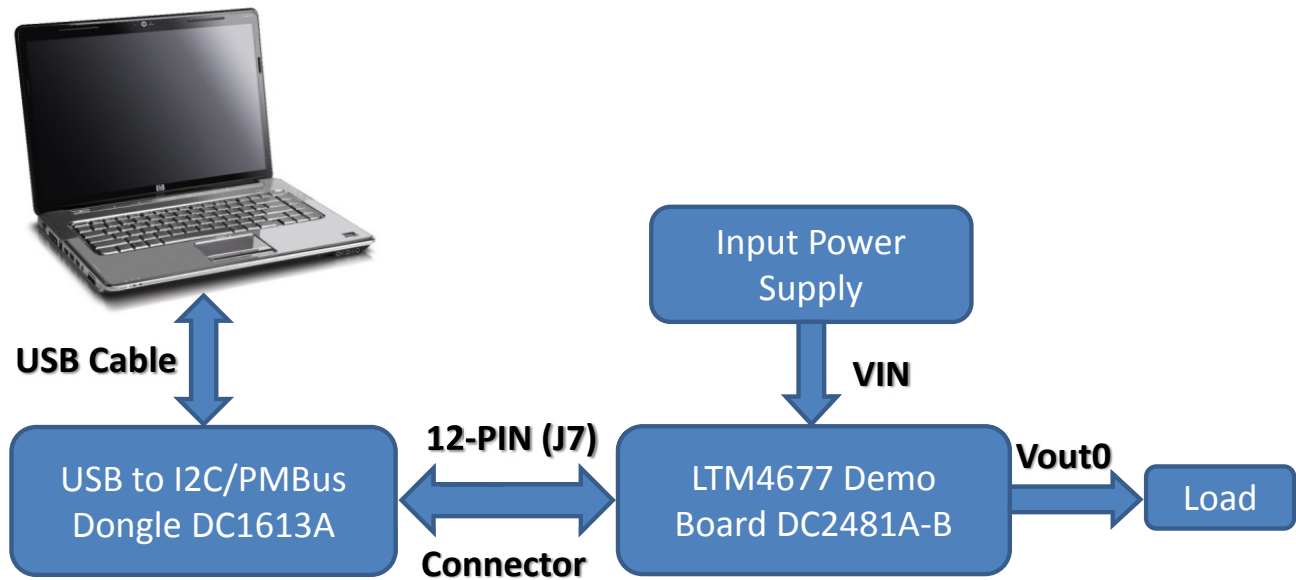

Figure 4. Demo Setup with PC

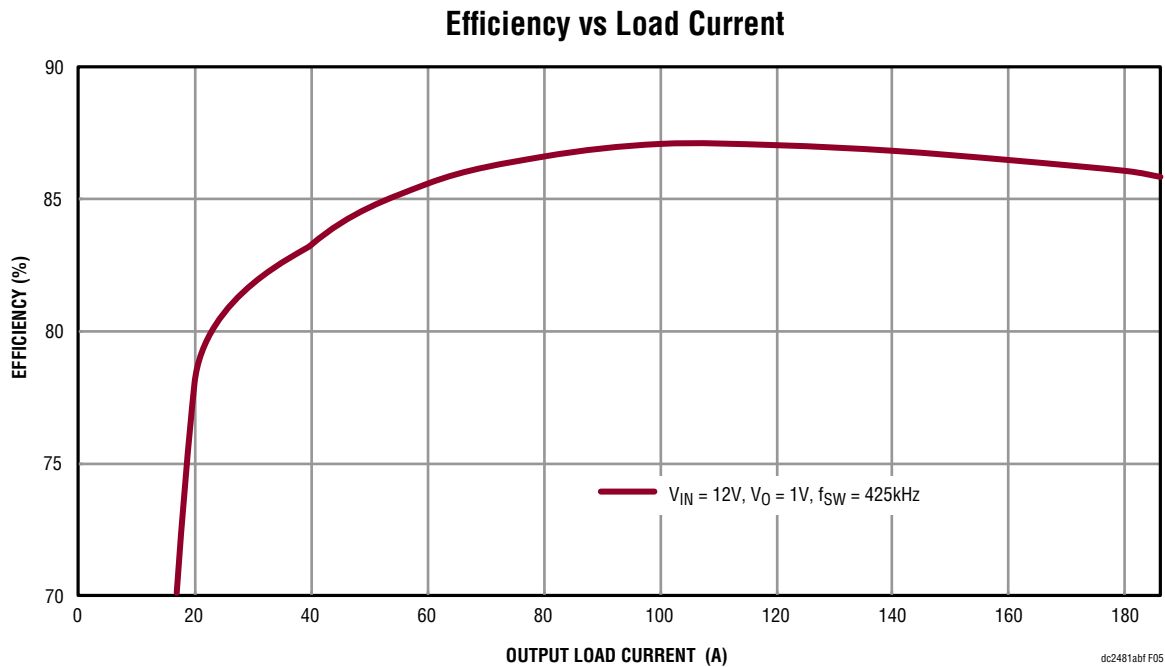

Figure 5. Efficiency vs Load Current at $V_{IN} = 12V$, $V_O = 1V$ and $f_{SW} = 425kHz$

QUICK START PROCEDURE

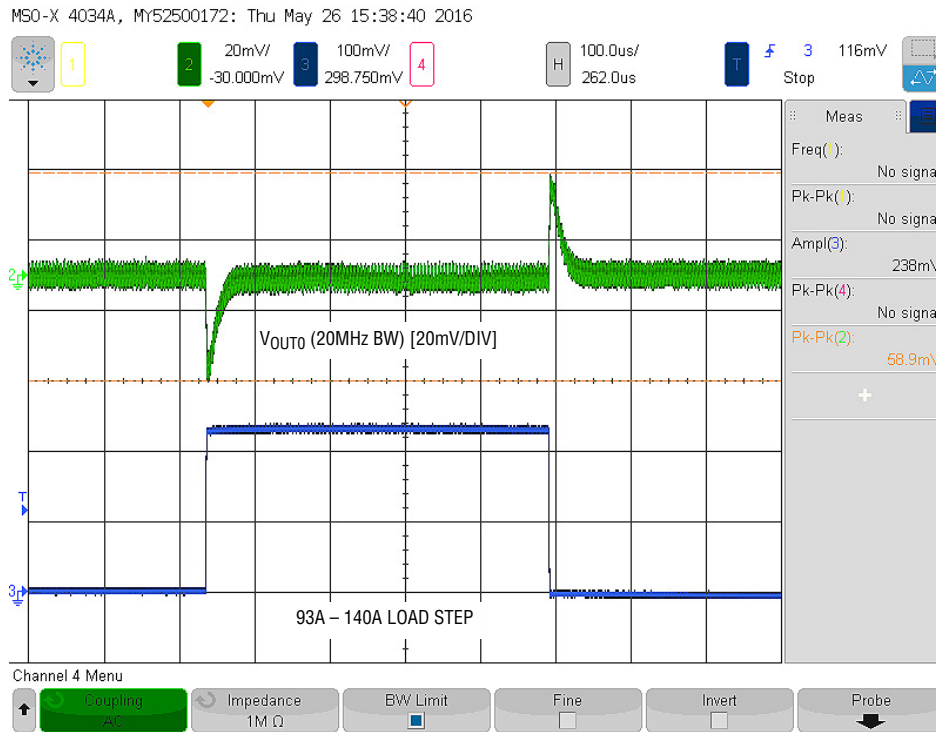

Figure 6. Output Voltage V_{OUT0} vs Load Current at $V_{IN} = 12V$, $V_{OUT0} = 1V$ (V_{OUT0} Range = 0)

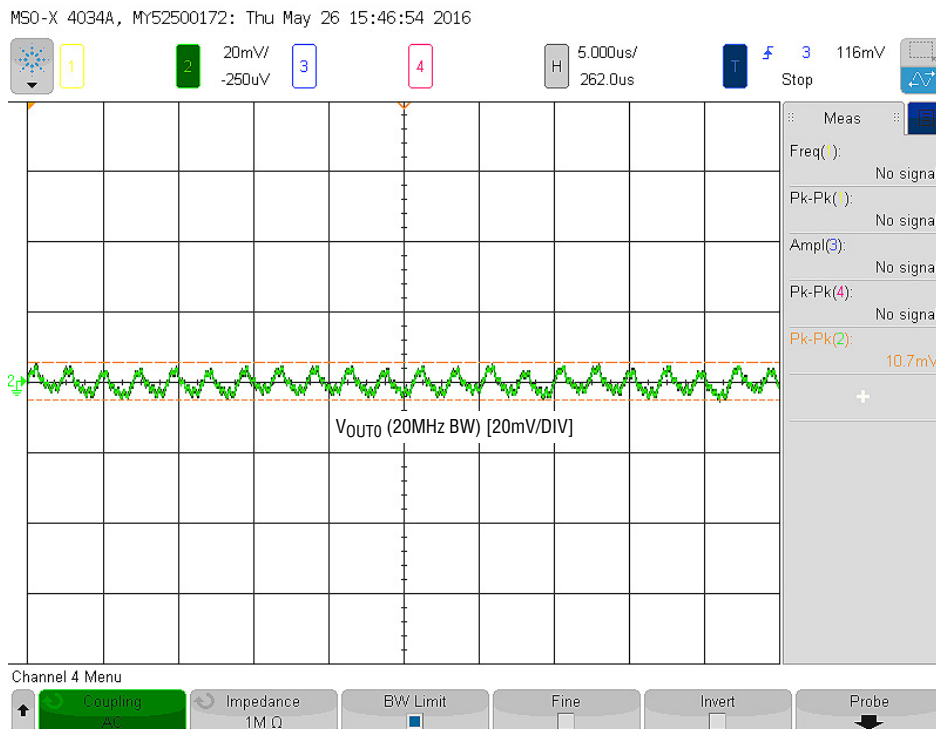

Figure 7. Output Voltage Ripple at $V_{IN} = 12V$, $V_{OUT0} = 1V$, $I_{OUT0} = 186A$

QUICK START PROCEDURE

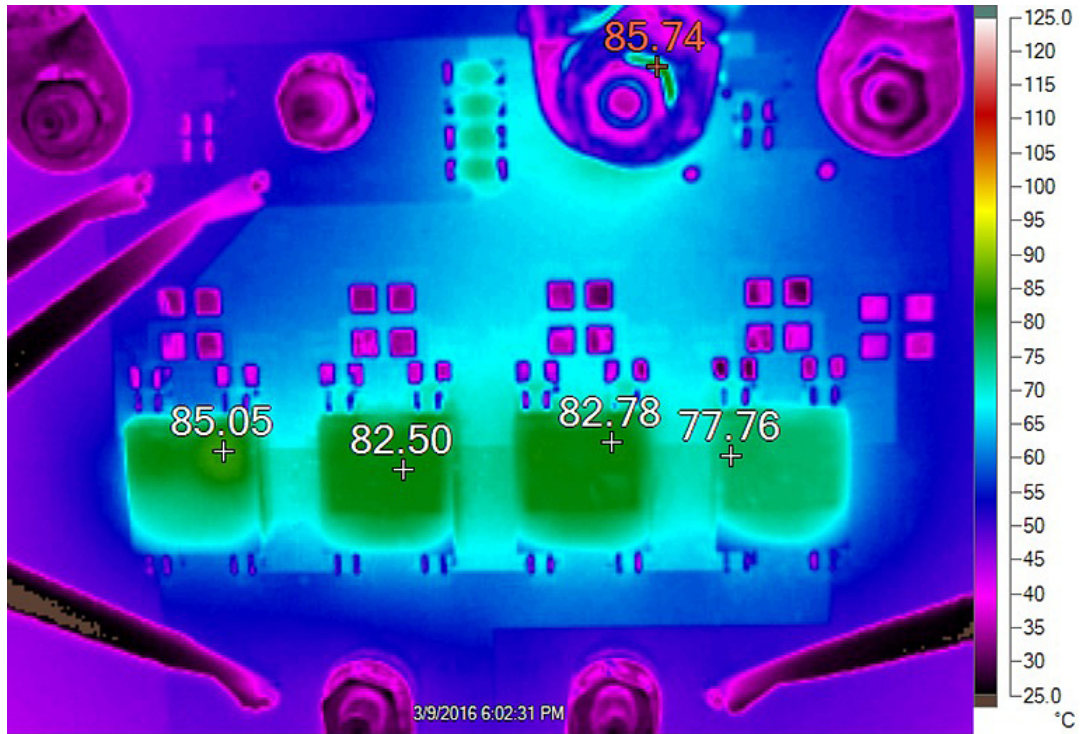

Figure 8. Thermal Performance at $V_{IN} = 12V$, $V_{OUT0} = 1V$, $I_{OUT0} = 186A$, $T_A = 23.8^\circ C$, Air Flow 400LFM

DC Load Current Sharing

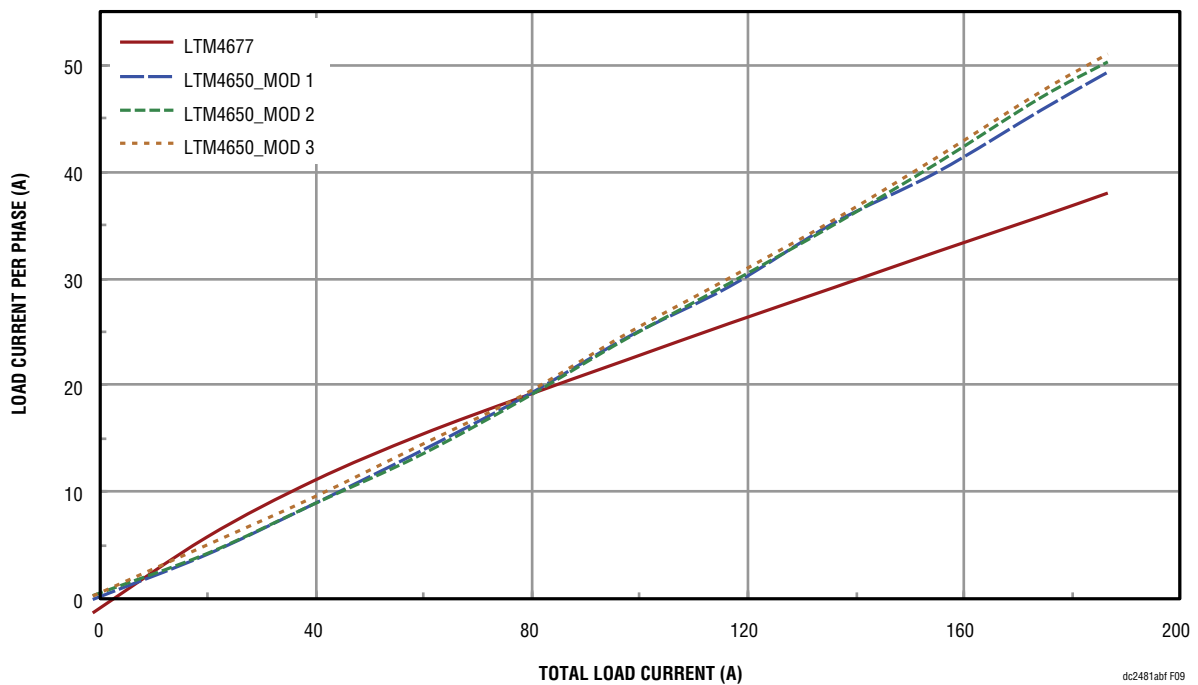

Figure 9. Current Sharing Performance at $V_{IN} = 12V$, $V_{OUT0} = 1V$

dc2481abf

LTPOWERPLAY SOFTWARE GUI

LTpowerPlay is a powerful Windows based development environment that supports Linear Technology power system management ICs, including the LTM4677, LTC®3880, LTC3883, LTC2974 and LTC2978. The software supports a variety of different tasks. You can use LTpowerPlay to evaluate Linear Technology ICs by connecting to a demo board system. LTpowerPlay can also be used in an offline mode (with no hardware present) in order to build a multichip configuration file that can be saved and reloaded at a later time. LTpowerPlay provides unprecedented diagnostic and debug features. It becomes a valuable diagnostic tool during board bring-up to program or tweak the power management scheme in a system, or to diagnose power

issues when bringing up rails. LTpowerPlay utilizes the DC1613A USB-to-SMBus controller to communicate with one of many potential targets, including the LTM4677, the LTC3880 and the LTC3883's demo system, or a customer board. The software also provides an automatic update feature to keep the software current with the latest set of device drivers and documentation. The LTpowerPlay software can be downloaded from:

<http://linear.com/ltpowerplay>

To access technical support documents for LTC Digital Power Products visit Help. View online help on the LTpowerPlay menu.

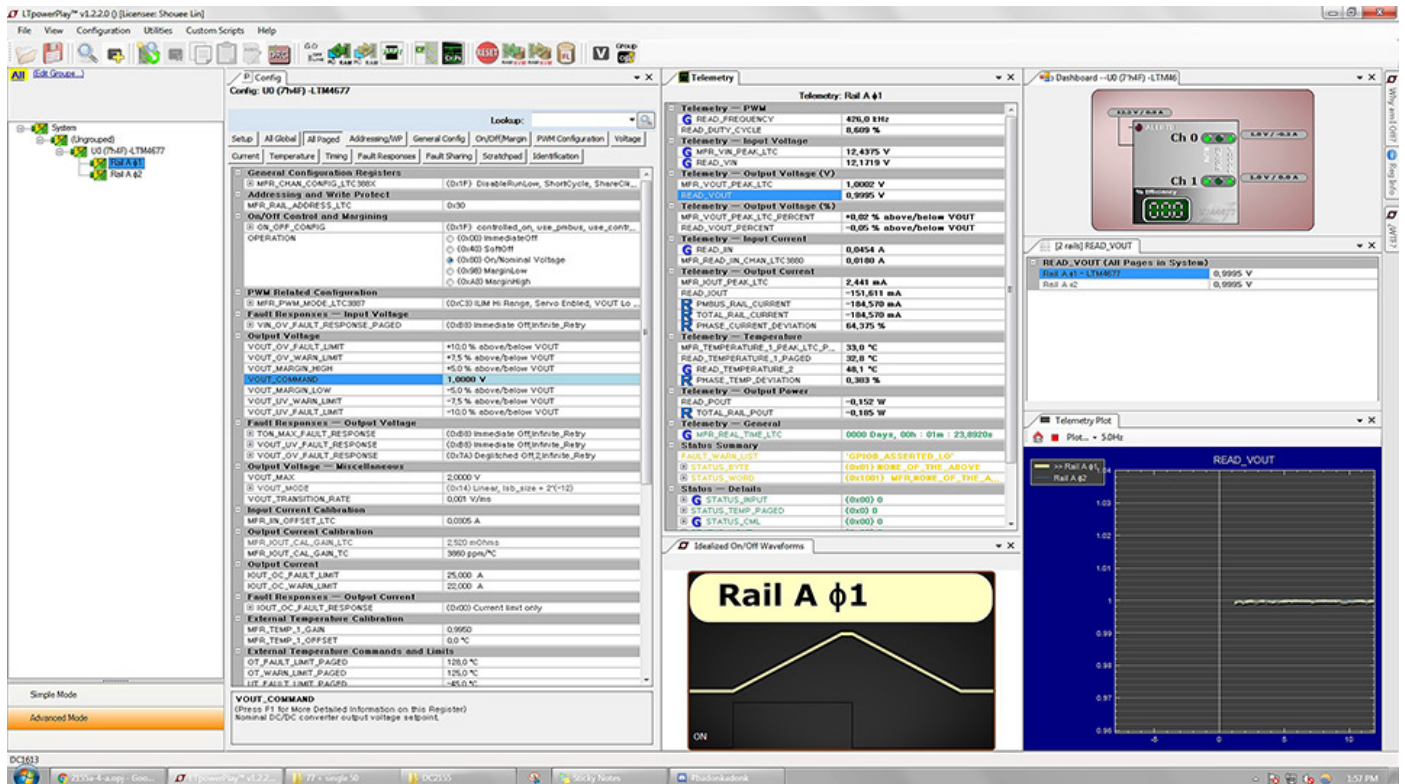

Figure 10. LTpowerPlay Main Interface

DEMO MANUAL DC2481A-B

LTPowerPLAY QUICK START PROCEDURE

The following procedure describes how to use LTpowerPlay to monitor and change the settings of LTM4677.

1. Download and install the LTPowerPlay GUI:

<http://linear.com/ltpowerplay>

2. Launch the LTPowerPlay GUI.

a. The GUI should automatically identify the DC2481A-B. The system tree on the left hand side should look like this:

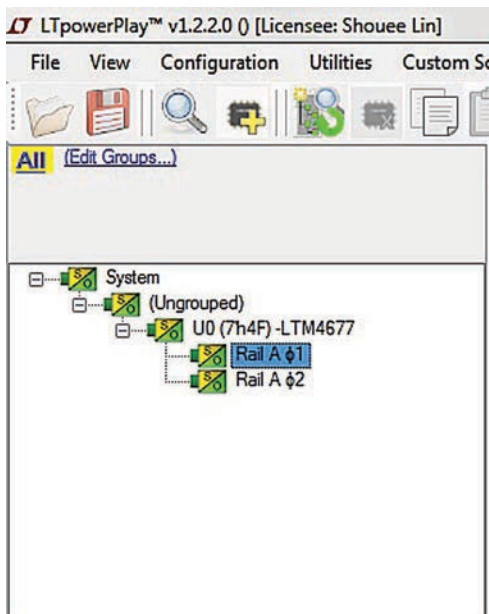

b. A green message box shows for a few seconds in the lower left hand corner, confirming that LTM4677 is communicating:

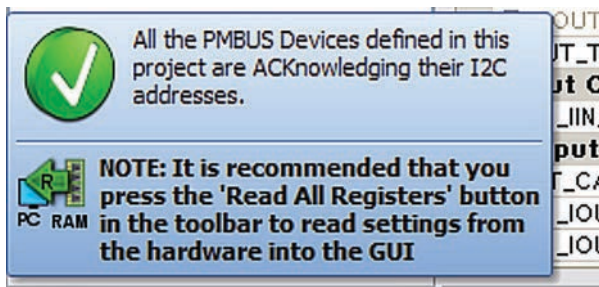

c. In the Toolbar, click the “R” (RAM to PC) icon to read the RAM from the TM4677. This reads the configuration from the RAM of LTM4677 and loads it into the GUI.



d. If you want to change the output voltage to a different value, like 1.5V. In the Config tab, type in 1.5 in the VOUT_COMMAND box, like this:

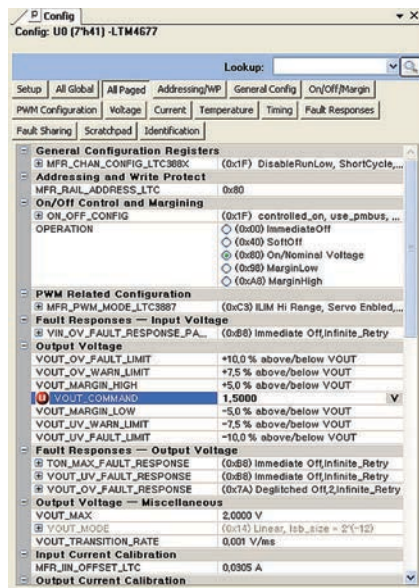

Then, click the “W” (PC to RAM) icon to write these register values to the LTM4677. After finishing this step, you will see the output voltage will change to 1.5V.



If the write is successful, you will see the following message:



e. You can save the changes into the NVM. In the tool bar, click “RAM to NVM” button, as following



f. Save the demo board configuration to a (*.proj) file. Click the Save icon and save the file. Name it whatever you want.

PARTS LIST

ITEM	QTY	REFERENCE	PART DESCRIPTION	MANUFACTURER/PART NUMBER
Required Circuit Components				
1	18	CIN1, CIN2, CIN4-CIN19	CAP, X5R, 10µF, 35V, 10%,1210	MURATA, GRM32ER6YA106KA12L
2	1	CIN3	CAP, 150µF, 35V, Aluminum Electr.,	SUN ELECT., 35CE150AX
3	21	COUT1-COUT4, COUT6, COUT9, COUT10, COUT12, COUT13, COUT15, COUT16, COUT19, COUT20, COUT23, COUT24, COUT27, COUT28, COUT31, COUT32, COUT35, COUT36		
4	10	COUT5, COUT7, COUT8, COUT11 COUT18, COUT22, COUT26, COUT30, COUT34, COUT38		
5	1	C5	CAP, CER 4700PF, 16V, X7R, 0603	MURATA, GRM188R71C472KA01D
6	4	C7, C8, C33, C34	CAP, X7R, 0.01µF, 16V, 10%,0603	MURATA, GRM188R71C103KA01D
7	3	C11, C18, C22	CAP, X5R, 2.2µF, 16V, 10%, 0603	MURATA, GRM188R61C225KE15D
8	3	C12, C19, C23	CAP, X7R, 1µF, 16V, 10%, 0603	MURATA, GRM188R71C105KA12D
9	2	C31, C28	CAP, X7R, 1µF, 25V,10%, 1206	MURATA, GRM31MR71E105KA01L
10	1	C25	CAP, X7R, 0.22µF, 25V,10%, 0805	MURATA, GRM21BR71E224KA01L
11	1	C26	CAP, X7R, 0.1µF, 25V,10%, 1206	MURATA, GRM319R71E104KA01J
12	1	C29	CAP, X5R, 1µF, 25V, 10%, 0805	MURATA, GRM216R61E105KA12D
13	1	C27	CAP, X7R, 150pF, 25V, 10%, 0603	Wurth Elektronik, 885012206054
14	1	C30	CAP, X5R, 4.7µF, 10V, 10%, 0603	MURATA, GRM188R61A475KE15D
15	2	D1, D2	LED, GREEN CLEAR 1208 SMD	ROHM, SML-010FTT86
16	1	D3	LED, RED CLEAR 1208 SMD	ROHM, SML-010VTT86
17	3	Q1, Q3, Q4	MOSFET N-CH 60V, 115MA, SOT-23	FAIRCHILD, 2N7002K
18	1	Q2	MOSFET P-CH 20V, 0.58A, SOT-23	VISHAY, Si2365EDS-T1-GE3 (ALTERNATE TP0101K-T1-E3)
19	2	Q5, Q6	MOSFET SPEED SRS 30V, 30A, LPAK	RENESAS, RJK0305DPB-02#J0
20	1	Q19	P-Channel 30-V Mosfet	DIODES INC., DMP3130L-7
21	1	R25	RES., CHIP, 22.6K, 1%, 0603	VISHAY, CRCW060322K6FKEA
22	22	R4, R8, R23, R31, R32, R34, R37, R41, R42, R44, R46, R47, R50, R51, R55, R61, R64, R66, R75, R80, R114, R116	RES., CHIP, 0, 1%, 0603	VISHAY, CRCW06030000Z0EA
23	4	R43, R49, R52, R56	RES., CHIP, 0, 1%, 2010	VISHAY, CRCW20100000Z0EA
24	11	R10, R11, R12, R13, R16, R17, R21, R58, R77, R94, R118,	RES., CHIP, 10k, 1%, 0603	VISHAY, CRCW060310K0FKEA
25	1	R9	RES., CHIP, 7.15k, 1%, 0603	VISHAY, CRCW06037K15FKEA
26	4	R22, R26, R70, R73	RES., CHIP, 10, 1%, 0603	VISHAY, CRCW060310R0FKEA
27	1	R102	RES., CHIP, 732, 1%, 0603	VISHAY, CRCW0603732RFKEA
28	1	R98	RES., CHIP, 511, 1%, 0603	VISHAY, CRCW0603511RFKEA
29	3	R33, R60, R65	RES., CHIP, 121k, 1%, 0603	VISHAY, CRCW0603121KFKEA
30	3	R40, R63, R68,	RES., CHIP, 80.6k, 1%, 0603	VISHAY, CRCW060380K6FKEA
31	1	R35	RES., CHIP, 60.4k, 1%, 0603	VISHAY, CRCW060360K4FKEA
32	1	R36	RES., CHIP, 8.25k, 1%, 0603	VISHAY, CRCW06038K25FKEA

DEMO MANUAL DC2481A-B

PARTS LIST

ITEM	QTY	REFERENCE	PART DESCRIPTION	MANUFACTURER/PART NUMBER
33	1	R19	RES., CHIP, 2.94k, 1%, 0603	VISHAY, CRCW06032K94FKEA
34	3	R45, R84, R85	RES., CHIP, 200, 1%, 0603	VISHAY, CRCW0603200RFKEA
	1	R54,	RES., CHIP, 2k, 1%, 0603	VISHAY, CRCW06032K00FKEA
35	3	R89, R92, R117	RES., CHIP, 20k, 1%, 0603	VISHAY, CRCW060320K0FKEA
36	2	R76, R115	RES., CHIP, 4.99k, 1%, 0603	VISHAY, CRCW06034K99FKEA
37	1	R86	RES., CHIP, 127, 1%, 0603	VISHAY, CRCW0603127RFKEA
38	1	R87	RES., CHIP, 2, 1%, 0603	VISHAY, CRCW06032R00FKEA
39	1	R88	RES., CHIP, 1M, 1%, 0603	VISHAY, CRCW06031M00FKEA
40	1	R90	RES., CHIP, 154k, 1%, 0603	VISHAY, CRCW0603154KFKEA
41	1	R91	RES., CHIP, 3.3, 1%, 0603	VISHAY, CRCW06033R30FKEA
42	1	R93	RES., CHIP, 681k, 1%, 0603	VISHAY, CRCW0603681KFKEA
43	1	R95	RES., CHIP, 82.5, 1%, 0603	VISHAY, CRCW060382R5FKEA
44	1	R112	RES., CHIP, 15.8k, 1%, 0603	VISHAY, CRCW060315K8FKEA
45	2	R99, R100	RES., CHIP 0.01, 1%, 2010	VISHAY, WSL2010R0100FEA
46	1	R101	TRIMMING POTENTIOMETER, 5K	BOURNS, 3386P-1-502LF
47	1	R103	RES., CHIP, 100k, 1%, 0603	VISHAY CRCW0603100KFKEA
48	1	U1	IC., LTM4677EY	LINEAR TECH., LTM4677EY#PBF
49	3	U2, U3, U4	IC., LTM4650EY	LINEAR TECH., LTM4650EY#PBF
50	1	U5	IC., LT1801CMS8, MSOP	LINEAR TECH., LT1801CMS8#PBF
51	1	U6	IC., EEPROM 2KBIT 400KHZ 8TSSOP	MICROCHIP, 24LC025-I/ST
52	1	U7	IC., LTC6992-1, S6-TSOT23	LINEAR TECH., LTC6992CS6-1#PBF
53	1	U8	IC., LT1803IS5, S5-TSOT23	LINEAR TECH., LT1803IS5#PBF
54	1	U9	IC., LT1129CS8-5, S8	LINEAR TECH., LT1129CS8-5#PBF

Additional Demo Board Circuit Components

1	0	C1, C2, C3, C4, C6, C13, COUT14, COUT17, COUT21, COUT25, COUT29, COUT33, COUT37, COUT39-COUT50	CAP, OPTIONAL	
2	0	C9, C10, C16, C17, C20, C21	CAP, OPTIONAL	
3	0	D10	DIODE, OPT	
4	0	R1-R3, R5-R7, R14, R15, R18, R20, R24, R27-R30, R38, R39, R41, R48, R59, R62, R67, R69, R71, R72, R78, R79, R96, R97, R104-R109	RES., OPTIONAL	
5	0	R39, R62, R67, R69	RES., OPTIONAL	

PARTS LIST

ITEM	QTY	REFERENCE	PART DESCRIPTION	MANUFACTURER/PART NUMBER
Hardware for Demo-Board Only				
1	24	E1-E24	TESTPOINT, TURRET, .062"	MILL-MAX, 2308-2-00-80-00-00-07-0
2	2	JP1, JP2	HEADER, 3 PIN 0.079 SINGLE ROW	Wurth Elektronik, 62000311121
3	2	XJP1, XJP2	SHUNT, .079" CENTER	Wurth Elektronik, 60800213421
4	2	J1, J3	JACK, BANANA	KEYSTONE, 575-4
5	4	J2, J4, J5, J6	STUD, TESTPIN	PEM, KFH-032-10
6	8	J1, J2, J3, J4, J5, J6 (x2)	NUT, BRASS 10-32	ANY, 10-32M/S BR PL
7	4	J1, J2, J3, J4, J5, J6	RING, LUG #10	KEYSTONE, 8205
8	4	J1, J2, J3, J4, J5, J6	WASHER, TIN PLATED BRASS	ANY #10, #10EXT BZ TN
9	2	SW1, SW2	CONN, SUB MINIATURE SLIDE SWITCHES	C&K., JS202011CQN
10	1	J7	CONN HEADER 12POS 2MM STR DL PCB	FCI, 98414-G06-12ULF
11	2	J10, J11	CONN, BNC, 5PINS	CONNEX, 112404
12	1	J14	HEADER, 4 PINS, SHROUDED	HIROSE, DF3A-4P-2DSA
13	1	J12	CONN RECEPT 2MM DUAL R/A 14POS (F)	SULLINS, NPPN072FJFN-RC
14	1	J13	HEADER 14POS 2MM R/A GOLD (M)	MOLEX, 87760-1416
15	4	(STAND-OFF)	STAND-OFF, NYLON 0.50" tall	WURTH ELEKTRONIK, 702935000
16	1		FAB, PRINTED CIRCUIT BOARD	DEMO CIRCUIT 2481A Rev 1
17	2		STENCIL (TOP & BOTTOM)	STENCIL DC2481A

DEMO MANUAL DC2481A-B

SCHEMATIC DIAGRAM

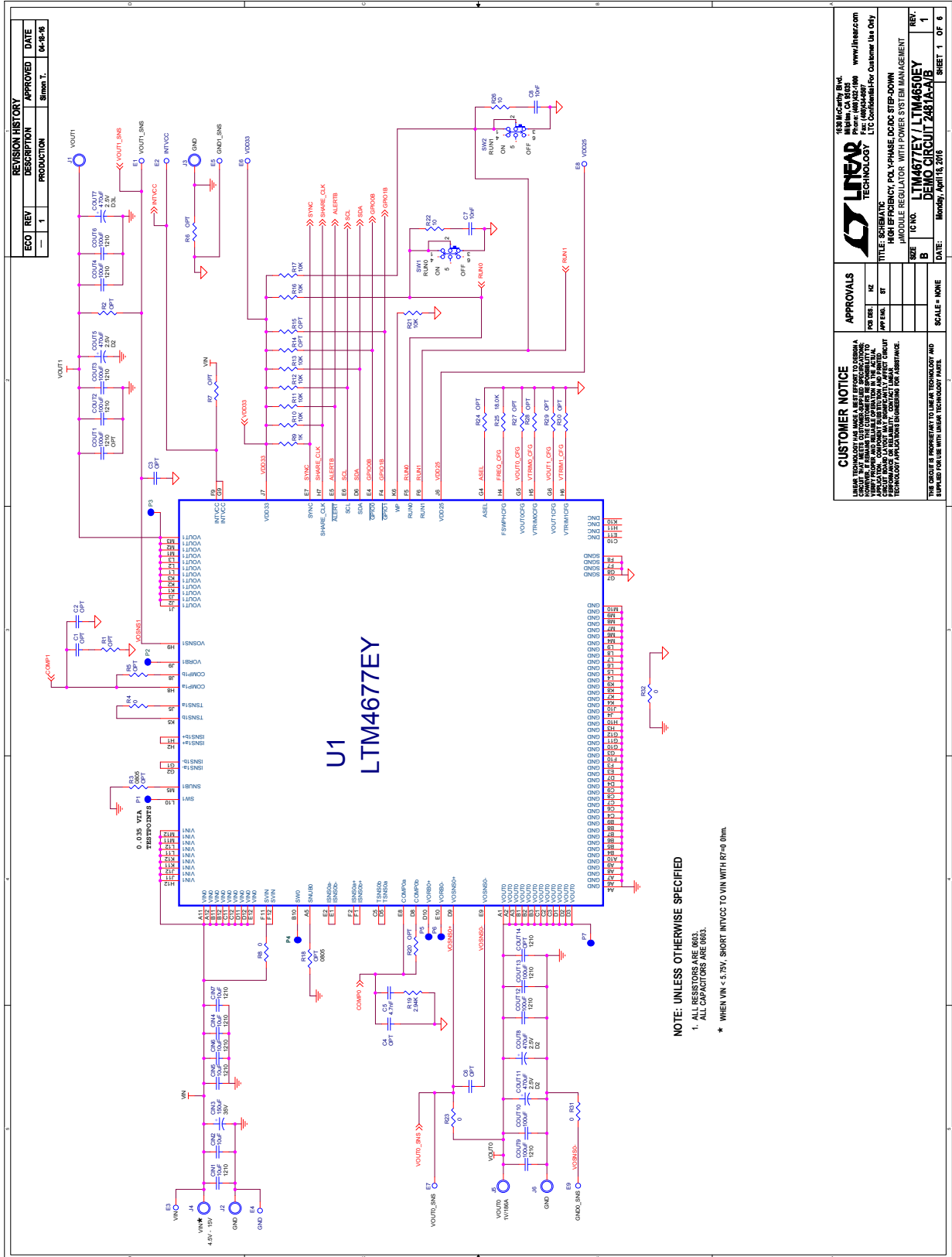

NOTE: UNLESS OTHERWISE SPECIFIED

- ALL RESISTORS ARE 0603.
- ALL CAPACITORS ARE 0805.

* WHEN VIN < 5.75V, SHORT INTVCC TO VIN WITH R7=0 Ohm.

SCHEMATIC DIAGRAM

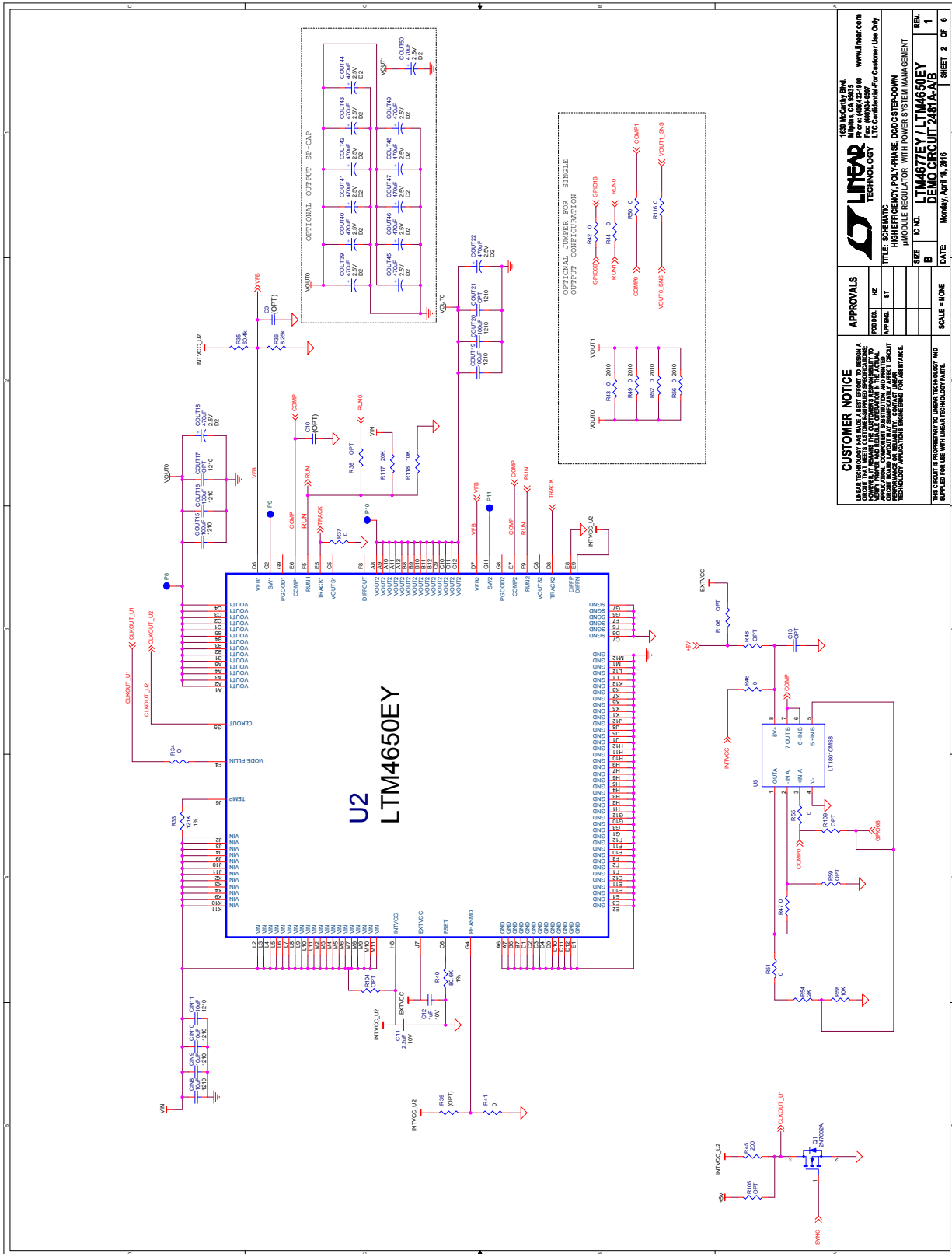

CUSTOMER NOTICE
 THIS CIRCUIT IS PROPRIETARY TO LINEAR TECHNOLOGY AND SHOULD NOT BE REPRODUCED OR TRANSMITTED IN ANY FORM OR BY ANY MEANS, ELECTRONIC OR MECHANICAL, INCLUDING PHOTOCOPYING, RECORDING, OR BY ANY INFORMATION STORAGE AND RETRIEVAL SYSTEM. ANY REUSE OF THIS CIRCUIT WITHOUT THE WRITTEN PERMISSION OF LINEAR TECHNOLOGY IS STRICTLY PROHIBITED. FOR ASSISTANCE, CONTACT YOUR LINEAR ACCOUNT MANAGER OR VISIT US AT WWW.LINEAR.COM.

APPROVALS

DESIGNER	BT
APP. MGR.	BT
SCALE	1
DATE	Monday, April 16, 2010

LINEAR TECHNOLOGY
 100 Webster Street
 Milpitas, CA 95035
 Phone: (408) 255-3700
 Fax: (408) 255-3701
 www.linear.com

DC2481A-B
 TITLE: SCHEMATIC FOR VOLTAGE MODE STEP-DOWN ADJUSTABLE REGULATOR WITH POWER SYSTEM MANAGEMENT
 REV: 1

DEMO MANUAL DC2481A-B

SCHEMATIC DIAGRAM

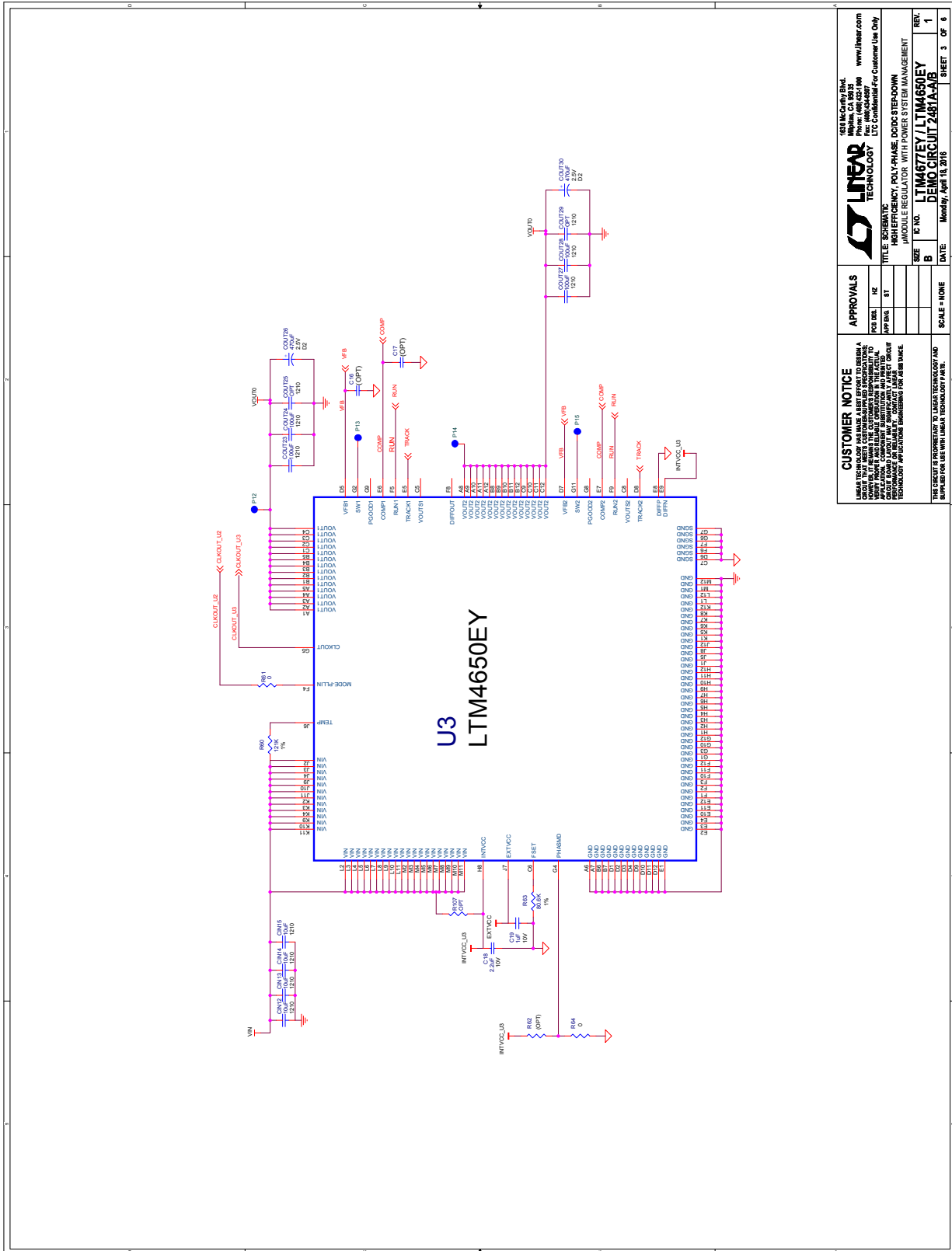

CUSTOMER NOTICE		APPROVALS	
THIS CIRCUIT IS PROPRIETARY TO LINEAR TECHNOLOGY AND NOT BE LOANED, REPRODUCED, COPIED, OR OTHERWISE DISSEMINATED WITHOUT THE WRITTEN PERMISSION OF LINEAR TECHNOLOGY.		PER: BT	DATE: _____
THIS CIRCUIT IS PROPRIETARY TO LINEAR TECHNOLOGY AND NOT BE LOANED, REPRODUCED, COPIED, OR OTHERWISE DISSEMINATED WITHOUT THE WRITTEN PERMISSION OF LINEAR TECHNOLOGY.		REV: 1	DATE: _____
THIS CIRCUIT IS PROPRIETARY TO LINEAR TECHNOLOGY AND NOT BE LOANED, REPRODUCED, COPIED, OR OTHERWISE DISSEMINATED WITHOUT THE WRITTEN PERMISSION OF LINEAR TECHNOLOGY.		SCALE: 1:1000	SHEET 3 OF 8

1001 McCarty Blvd
Folsom, CA 95630
www.linear.com

LINEAR TECHNOLOGY
POLY-PHASE, BUCK-BOOST, INVERTING, AND ADJUSTABLE CURRENT MODE DC-DC CONVERTERS

REV: 1
DATE: _____

U3: LTM4650EY / LTM4650EY
TITLE: SCHEMATIC
PART: DEMO CIRCUIT 2481A-B

SCHEMATIC DIAGRAM

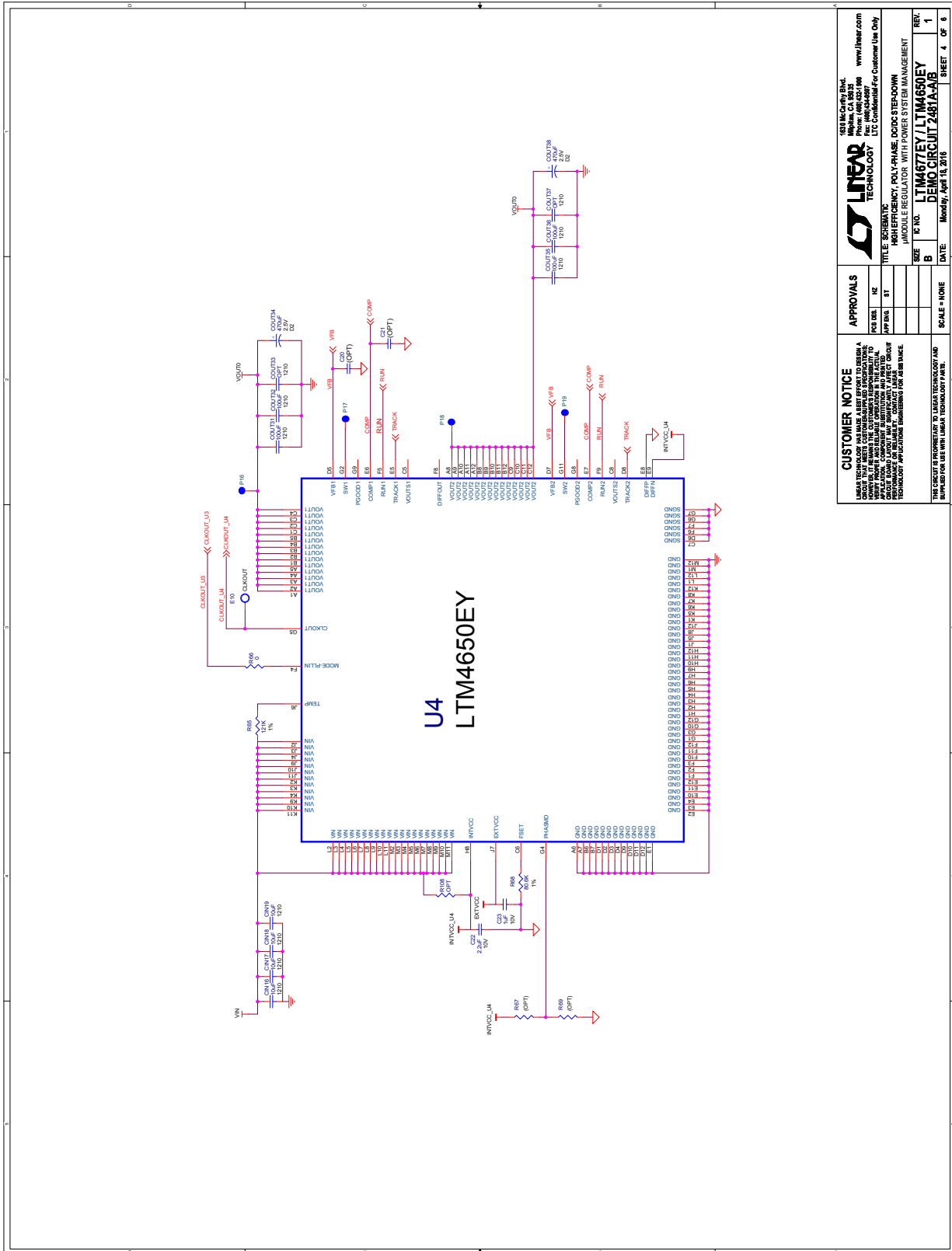

CUSTOMER NOTICE		APPROVALS	
<p>THIS CIRCUIT IS PROPRIETARY TO LINEAR TECHNOLOGY AND INTENDED FOR USE WITH LINEAR TECHNOLOGY PARTS.</p> <p>DO NOT REPRODUCE OR TRANSMIT THIS INFORMATION IN ANY FORM OR BY ANY MEANS, ELECTRONIC OR MECHANICAL, INCLUDING PHOTOCOPYING, RECORDING, OR BY ANY INFORMATION STORAGE AND RETRIEVAL SYSTEM, WITHOUT THE WRITTEN PERMISSION OF LINEAR TECHNOLOGY. APPLICATION NUMBERING FOR THIS DEVICE.</p>		<p>PER: []</p> <p>BY: []</p>	<p>DATE: []</p> <p>SCALE: NONE</p>
<p>101 Lincoln Center Blvd Mills, CA 94543 Phone: 916.434.1000 www.linear.com</p> <p>LINEAR TECHNOLOGY POLY-PHASE BUCK CONVERTER WITH POWER SYSTEM MANAGEMENT</p>		<p>TITLE: SCHEMATIC LTM4650EY / LTM4650EY REV: 1</p>	
<p>DATE: Monday, April 13, 2010</p>		<p>SHEET 4 OF 8</p>	

SCHEMATIC DIAGRAM

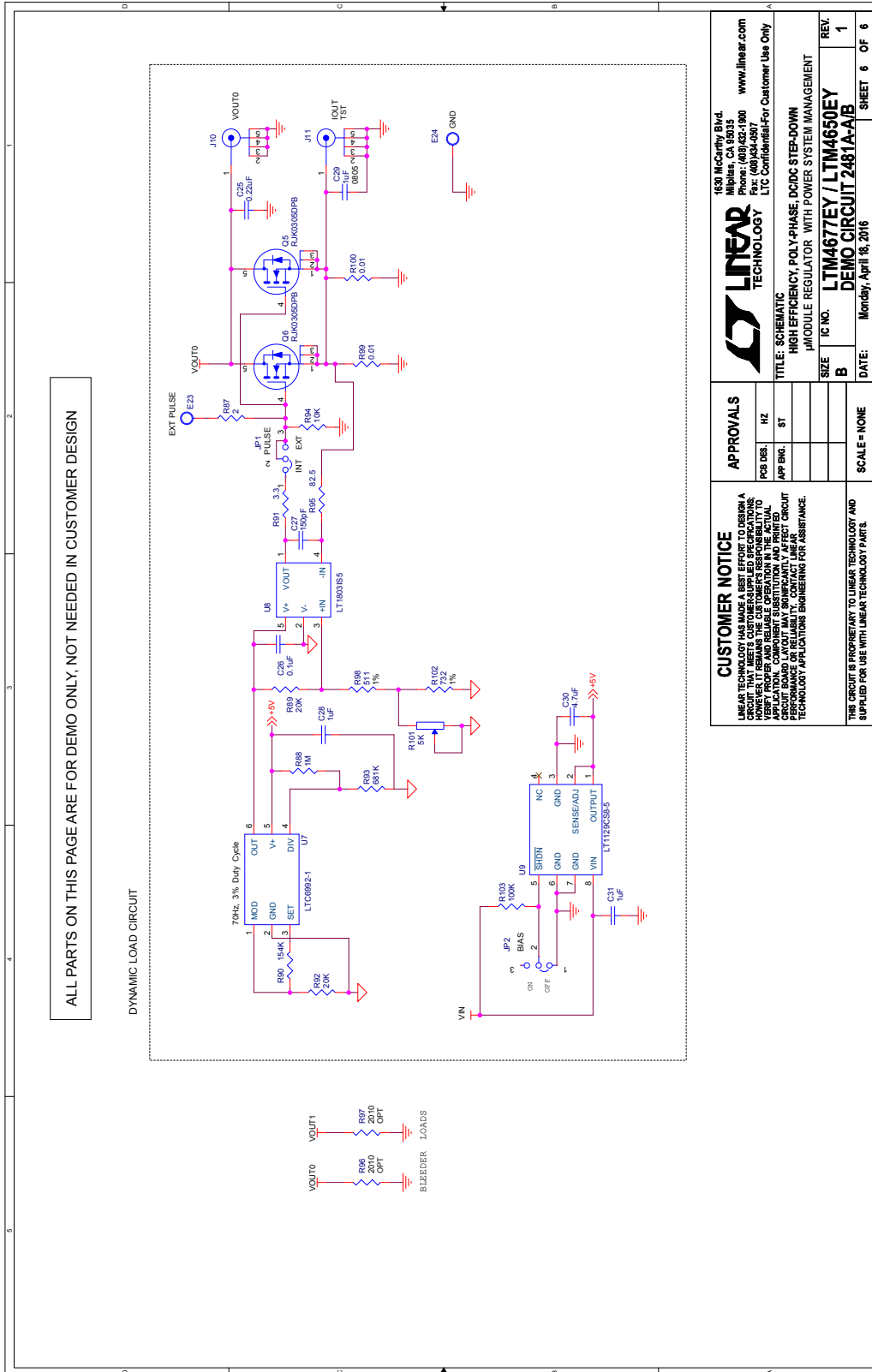

DEMO MANUAL DC2481A-B

DEMONSTRATION BOARD IMPORTANT NOTICE

Linear Technology Corporation (LTC) provides the enclosed product(s) under the following **AS IS** conditions:

This demonstration board (DEMO BOARD) kit being sold or provided by Linear Technology is intended for use for **ENGINEERING DEVELOPMENT OR EVALUATION PURPOSES ONLY** and is not provided by LTC for commercial use. As such, the DEMO BOARD herein may not be complete in terms of required design-, marketing-, and/or manufacturing-related protective considerations, including but not limited to product safety measures typically found in finished commercial goods. As a prototype, this product does not fall within the scope of the European Union directive on electromagnetic compatibility and therefore may or may not meet the technical requirements of the directive, or other regulations.

If this evaluation kit does not meet the specifications recited in the DEMO BOARD manual the kit may be returned within 30 days from the date of delivery for a full refund. **THE FOREGOING WARRANTY IS THE EXCLUSIVE WARRANTY MADE BY THE SELLER TO BUYER AND IS IN LIEU OF ALL OTHER WARRANTIES, EXPRESSED, IMPLIED, OR STATUTORY, INCLUDING ANY WARRANTY OF MERCHANTABILITY OR FITNESS FOR ANY PARTICULAR PURPOSE. EXCEPT TO THE EXTENT OF THIS INDEMNITY, NEITHER PARTY SHALL BE LIABLE TO THE OTHER FOR ANY INDIRECT, SPECIAL, INCIDENTAL, OR CONSEQUENTIAL DAMAGES.**

The user assumes all responsibility and liability for proper and safe handling of the goods. Further, the user releases LTC from all claims arising from the handling or use of the goods. Due to the open construction of the product, it is the user's responsibility to take any and all appropriate precautions with regard to electrostatic discharge. Also be aware that the products herein may not be regulatory compliant or agency certified (FCC, UL, CE, etc.).

No License is granted under any patent right or other intellectual property whatsoever. **LTC assumes no liability for applications assistance, customer product design, software performance, or infringement of patents or any other intellectual property rights of any kind.**

LTC currently services a variety of customers for products around the world, and therefore this transaction **is not exclusive**.

Please read the DEMO BOARD manual prior to handling the product. Persons handling this product must have electronics training and observe good laboratory practice standards. **Common sense is encouraged.**

This notice contains important safety information about temperatures and voltages. For further safety concerns, please contact a LTC application engineer.

Mailing Address:

Linear Technology
1630 McCarthy Blvd.
Milpitas, CA 95035

Copyright © 2004, Linear Technology Corporation