

LTM4700EY Dual 50A or Single 100A μ Module Regulator With Digital Power System Management

DESCRIPTION

Demonstration circuit 2702A-A is a dual-output, high efficiency, high density, μ Module® regulator with 4.5V to 16V input range. Each output can supply 50A maximum load current. The demo board has a [LTM4700](#) μ Module regulator, which is a dual 50A or single 100A step-down regulator with digital power system management. Please see LTM4700 data sheet for more detailed information.

DC2702A-A powers up to default settings and produce power based on configuration resistors without the need for any serial bus communication. This allows easy evaluation of the DC/DC converter. To fully explore the extensive power system management features of the part, download the GUI software LTpowerPlay® onto your PC and use ADI's

I²C/SMBus/PMBus dongle DC1613A to connect to the board. LTpowerPlay allows the user to reconfigure the part on-the-fly and store the configuration in EEPROM, view telemetry of voltage, current, temperature and fault status.

GUI Download

The software can be downloaded from: [LTpowerPlay](#)

For more details and instructions of LTpowerPlay, please refer to LTpowerPlay GUI for LTM4700 Quick Start Guide.

Design files for this circuit board are available.

All registered trademarks and trademarks are the property of their respective owners.

BOARD PHOTO

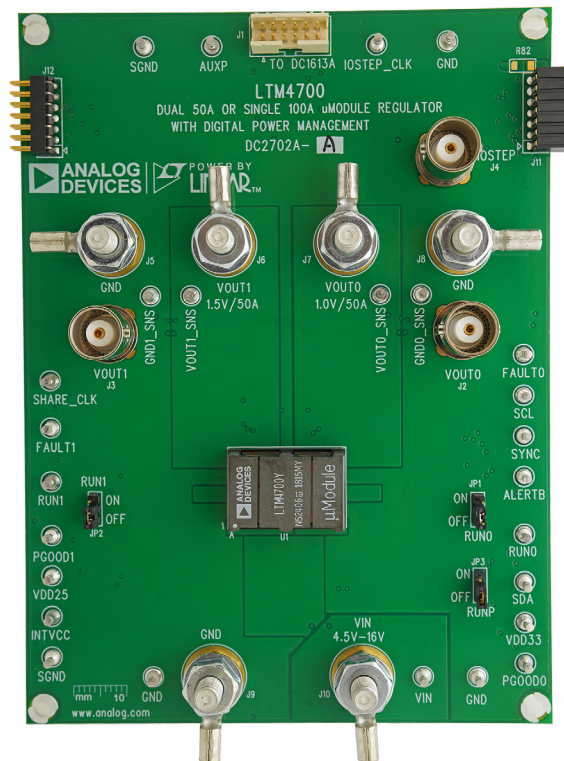

Figure 1. Dual-Output LTM4700/DC2702A-A Demo Circuit

DEMO MANUAL DC2702A-A

PERFORMANCE SUMMARY Specifications are at $T_A = 25^\circ\text{C}$

PARAMETER	CONDITIONS	VALUE
Input Voltage Range		4.5V to 16V
Output Voltage, V_{OUT0}	$V_{IN} = 4.5\text{V to }16\text{V}$, $I_{OUT0} = 0\text{A to }50\text{A}$	0.5V to 1.8V, Default: 1.0V
Maximum Output Current, I_{OUT0}	$V_{IN} = 4.5\text{V to }16\text{V}$, $V_{OUT0} = 0.5\text{V to }1.8\text{V}$	50A
Output Voltage, V_{OUT1}	$V_{IN} = 4.5\text{V to }16\text{V}$, $I_{OUT1} = 0\text{A to }50\text{A}$	0.5V to 1.8V, Default: 1.5V
Maximum Output Current, I_{OUT1}	$V_{IN} = 4.5\text{V to }16\text{V}$, $V_{OUT1} = 0.5\text{V to }1.8\text{V}$	50A
Typical Efficiency	$V_{IN} = 12\text{V}$, $V_{OUT0} = 1.0\text{V}$, $I_{OUT0} = 50\text{A}$ $V_{IN} = 12\text{V}$, $V_{OUT1} = 1.5\text{V}$, $I_{OUT1} = 50\text{A}$	88.7% (See Figure 5) 91.3% (See Figure 6)
Default Switching Frequency		500kHz

QUICK START PROCEDURE

MAXIMUM OUTPUT CURRENT	NUMBER OF OUPUTS	NUMBER OF LTM4700 μ MODULE REGULATORS ON THE BOARD	DEMO BOARD NUMBER
50A	2	1	DC2702A-A
100A	1	1	DC2702A-B
200A	1	2	DC2784A-A
300A	1	3	DC2784A-B
400A	1	4	DC2784A-C

Demonstration circuit 2702A-A is easy to set up to evaluate the performance of the LTM4700EY. Refer to Figure 2 for the proper measurement equipment setup and follow the procedure below.

1. With power off, connect the input power supply to V_{IN} (4.5V-16V) and GND (input return).
2. Connect the 1.0V output load between V_{OUT0} and GND (Initial load: no load).
3. Connect the 1.5V output load between V_{OUT1} and GND (Initial load: no load).
4. Connect the DVMs to the input and outputs. Set default jumper position: JP1: ON; JP2: ON; JP3: ON.
5. Turn on the input power supply and check for the proper output voltages. V_{OUT0} should be $1.0\text{V} \pm 0.5\%$, and V_{OUT1} should be $1.5\text{V} \pm 0.5\%$.

6. Once the proper output voltages are established, adjust the loads within the operating range and observe the output voltage regulation, ripple voltage and other parameters.
7. Connect the dongle and control the output voltages from the GUI. See "LTpowerPlay GUI for the LTM4700 Quick Start Guide" for details.

Note: Internal bias circuit is enabled when $V_{IN} > 7\text{V}$ and JP3 is ON.

Note: When measuring the output or input voltage ripple, do not use the long ground lead on the oscilloscope probe. See Figure 3 for the proper scope probe technique. Short, stiff leads need to be soldered to the (+) and (-) terminals of an output capacitor. The probe's ground ring needs to touch the (-) lead and the probe tip needs to touch the (+) lead.

QUICK START PROCEDURE

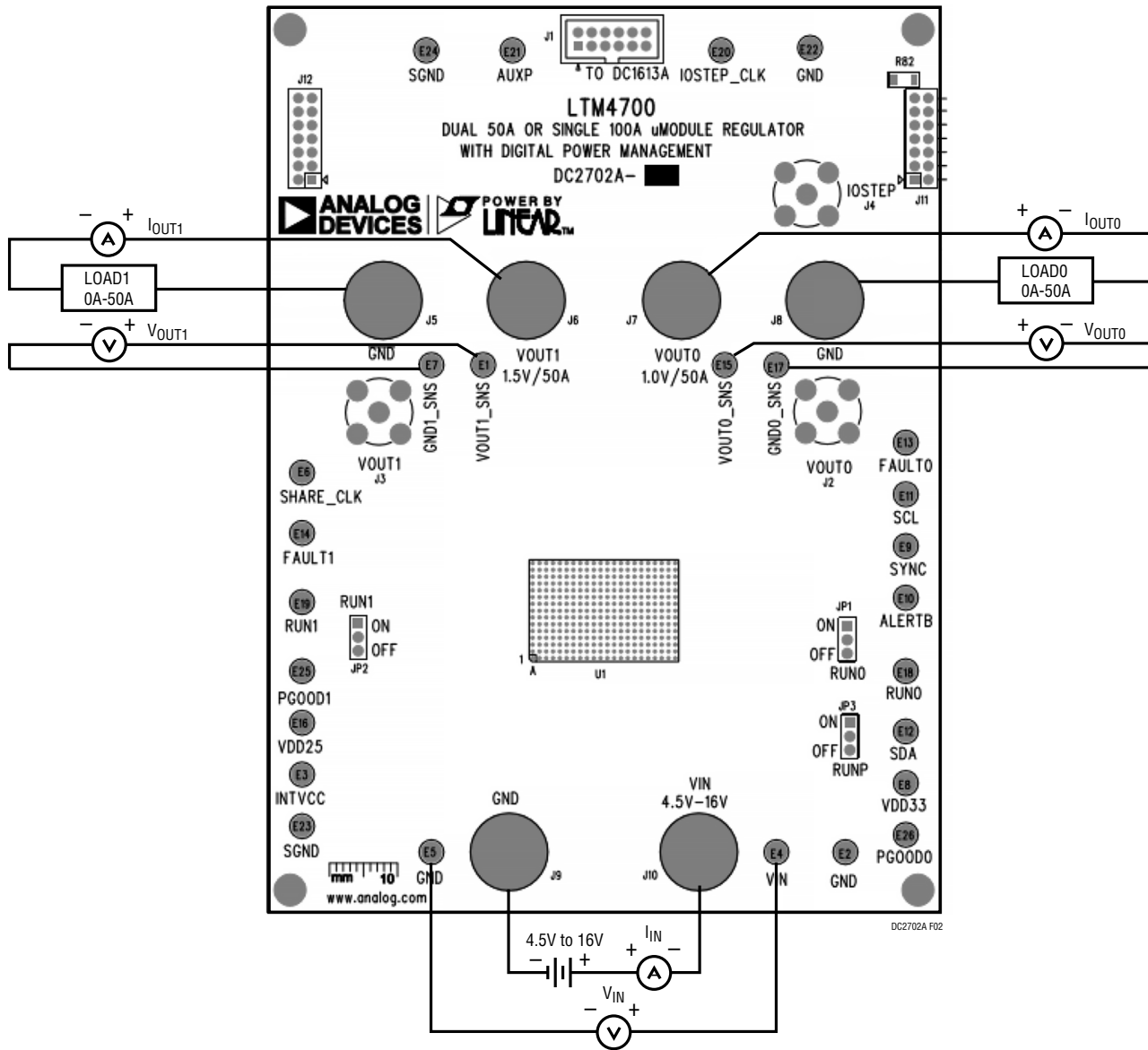

Figure 2. Proper Measurement Equipment Setup

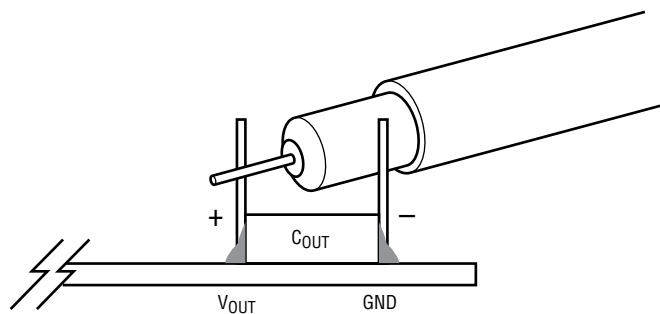

Figure 3. Measuring Output Voltage Ripple

DEMO MANUAL DC2702A-A

QUICK START PROCEDURE

Connecting a PC to DC2702A

You can use a PC to reconfigure the power management features of the LTM4700 such as: nominal V_{OUT} , mar-

gin set points, OV/UV limits, temperature fault limits, sequencing parameters, the fault log, fault responses, GPIOs and other functionalities. The DC1613A dongle may be plugged when V_{IN} is present.

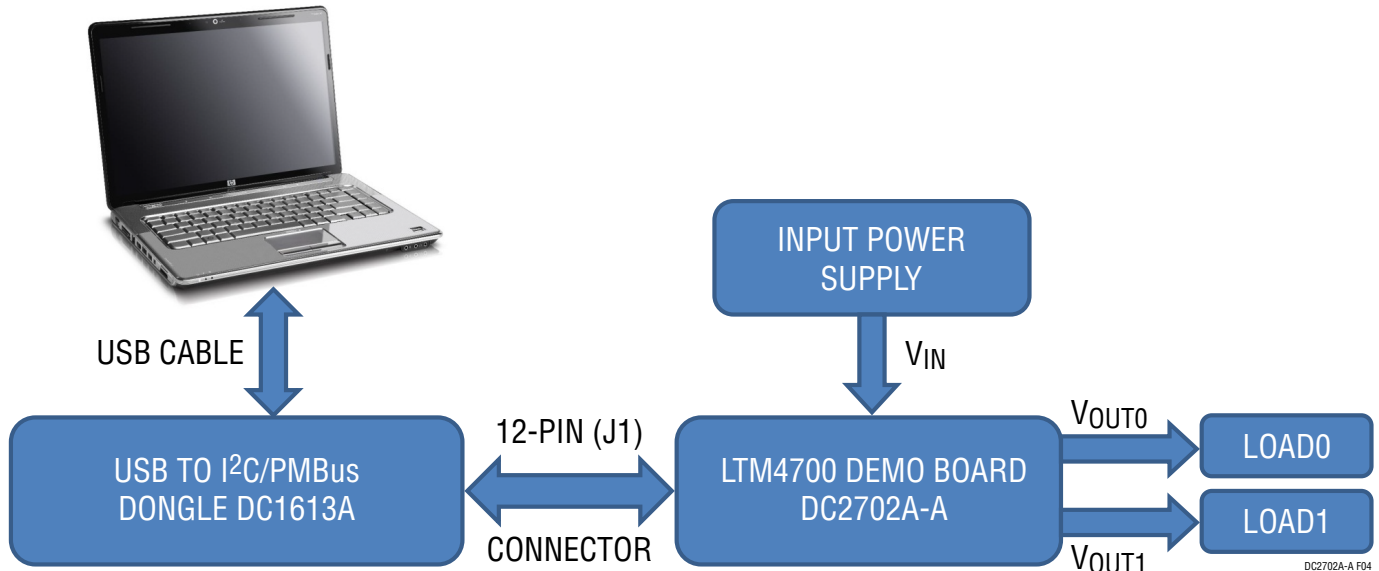

Figure 4. Demo Setup with PC

Efficiency vs Load Current at $V_O = 1.0V$, $f_{SW} = 500kHz$

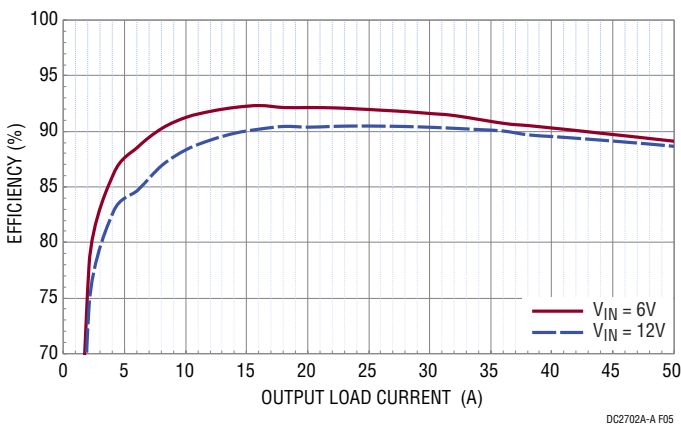

Figure 5. Efficiency vs Load Current on CH0 (CH1 is Disabled, RUNP is ON)

Efficiency vs Load Current at $V_O = 1.5V$, $f_{SW} = 500kHz$

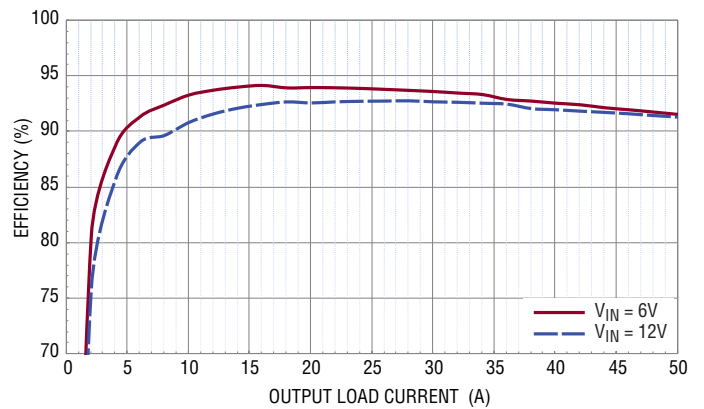

Figure 6. Efficiency vs Load Current on CH1 (CH0 is Disabled, RUNP is ON)

QUICK START PROCEDURE

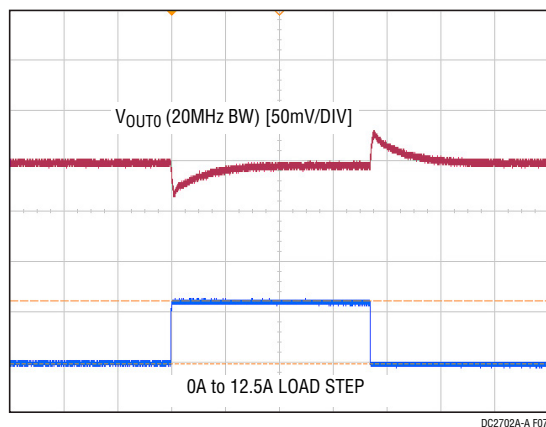

Figure 7. Output Voltage V_{OUT0} vs Load Current (V_{OUT0} = 1.0V)

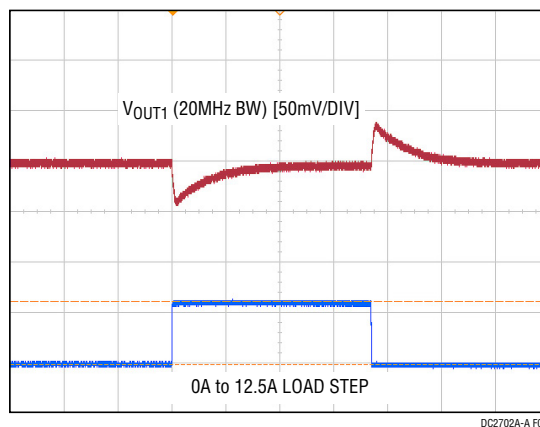

Figure 8. Output voltage V_{OUT1} vs Load Current (V_{OUT1} = 1.5V)

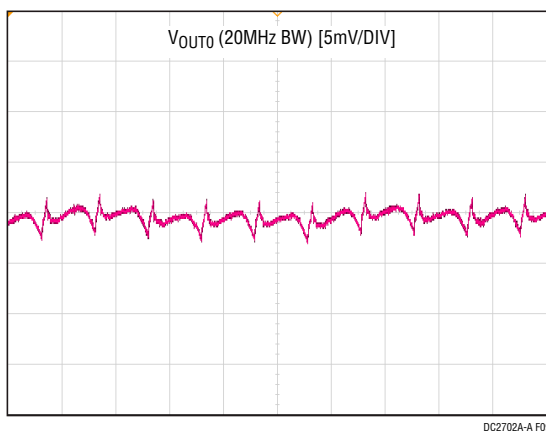

Figure 9. Output Voltage Ripple at V_{IN} = 12V, V_{OUT0} = 1.0V, I_{OUT0} = 50A

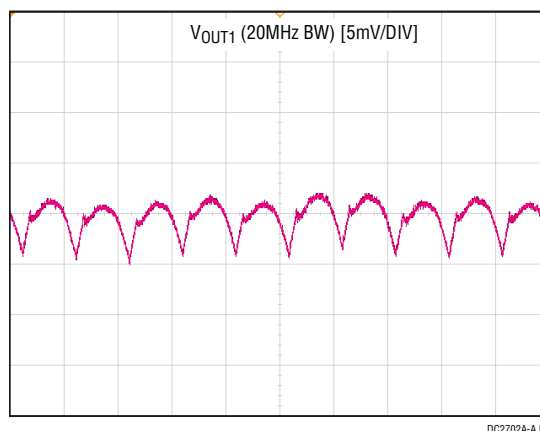

Figure 10. Output Voltage Ripple at V_{IN} = 12V, V_{OUT1} = 1.5V, I_{OUT1} = 50A

QUICK START PROCEDURE

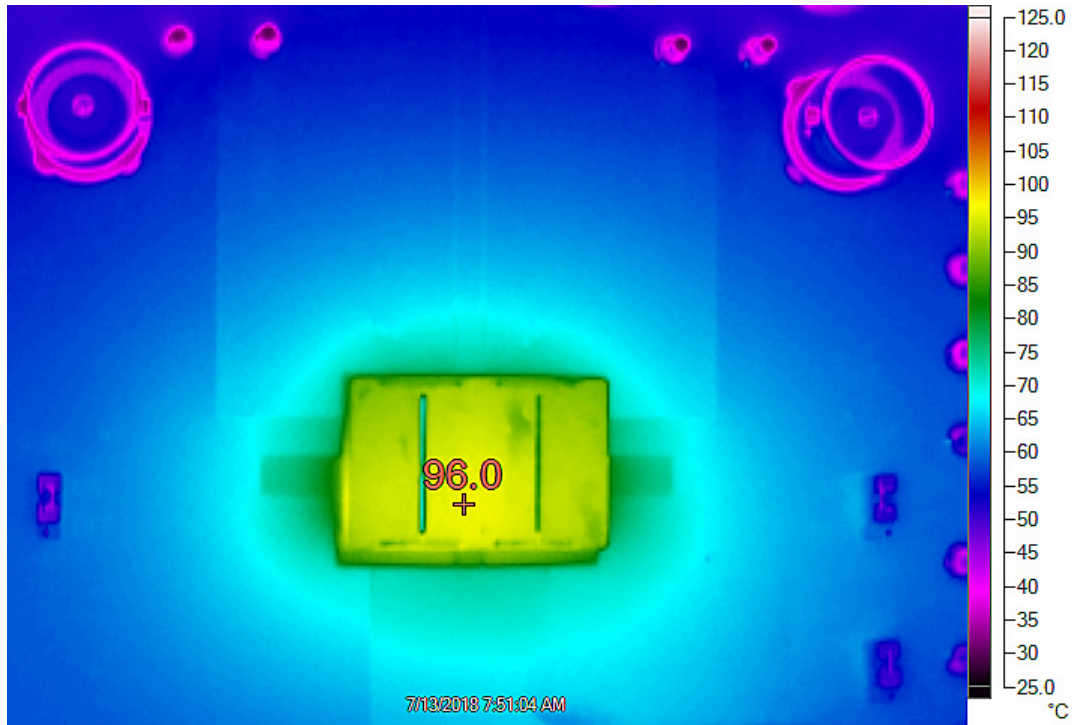

Figure 11. Thermal at $V_{IN} = 12V$, $V_{OUT0} = 1.0V$, $I_{OUT0} = 50A$, $V_{OUT1} = 1.5V$, $I_{OUT1} = 50A$, $T_A = 25^\circ C$, No Airflow

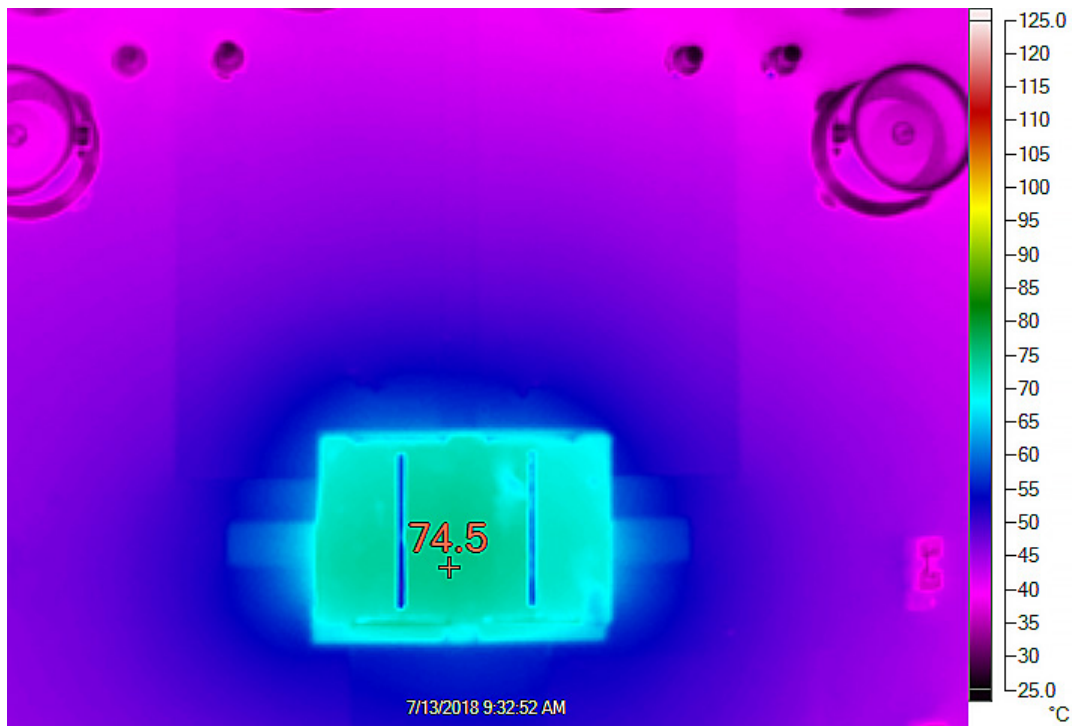

Figure 12. Thermal at $V_{IN} = 12V$, $V_{OUT0} = 1.0V$, $I_{OUT0} = 50A$, $V_{OUT1} = 1.5V$, $I_{OUT1} = 50A$, $T_A = 25^\circ C$, 200LFM Airflow

LTPOWERPLAY SOFTWARE GUI

LTpowerPlay is a powerful Windows based development environment that supports Analog Devices power system management ICs and μ Modules, including the LTM4675, LTM4676, LTM4677, LTM4678, LTC3880, LTC3882 and LTC3883. The software supports a variety of different tasks. You can use LTpowerPlay to evaluate Analog Devices ICs by connecting to a demo board system. LTpowerPlay can also be used in an offline mode (with no hardware present) in order to build a multichip configuration file that can be saved and reloaded at a later time. LTpowerPlay provides unprecedented diagnostic and debug features. It becomes a valuable diagnostic tool during board bring-up to program or tweak the power management scheme in a system, or to diagnose power issues when bringing up rails. LTpowerPlay utilizes the

DC1613A USB-to-SMBus controller to communicate with one of many potential targets, including the LTM4675, LTM4676, LTM4677, LTM4678, LTC3880, LTC3882, LTC3883's demo system, or a customer board. The software also provides an automatic update feature to keep the software current with the latest set of device drivers and documentation. The LTpowerPlay software can be downloaded from: [LTpowerPlay](#)

To access technical support documents for Analog Devices Digital Power Products visit the LTpowerPlay Help menu. Online help also available through the LTpowerPlay.

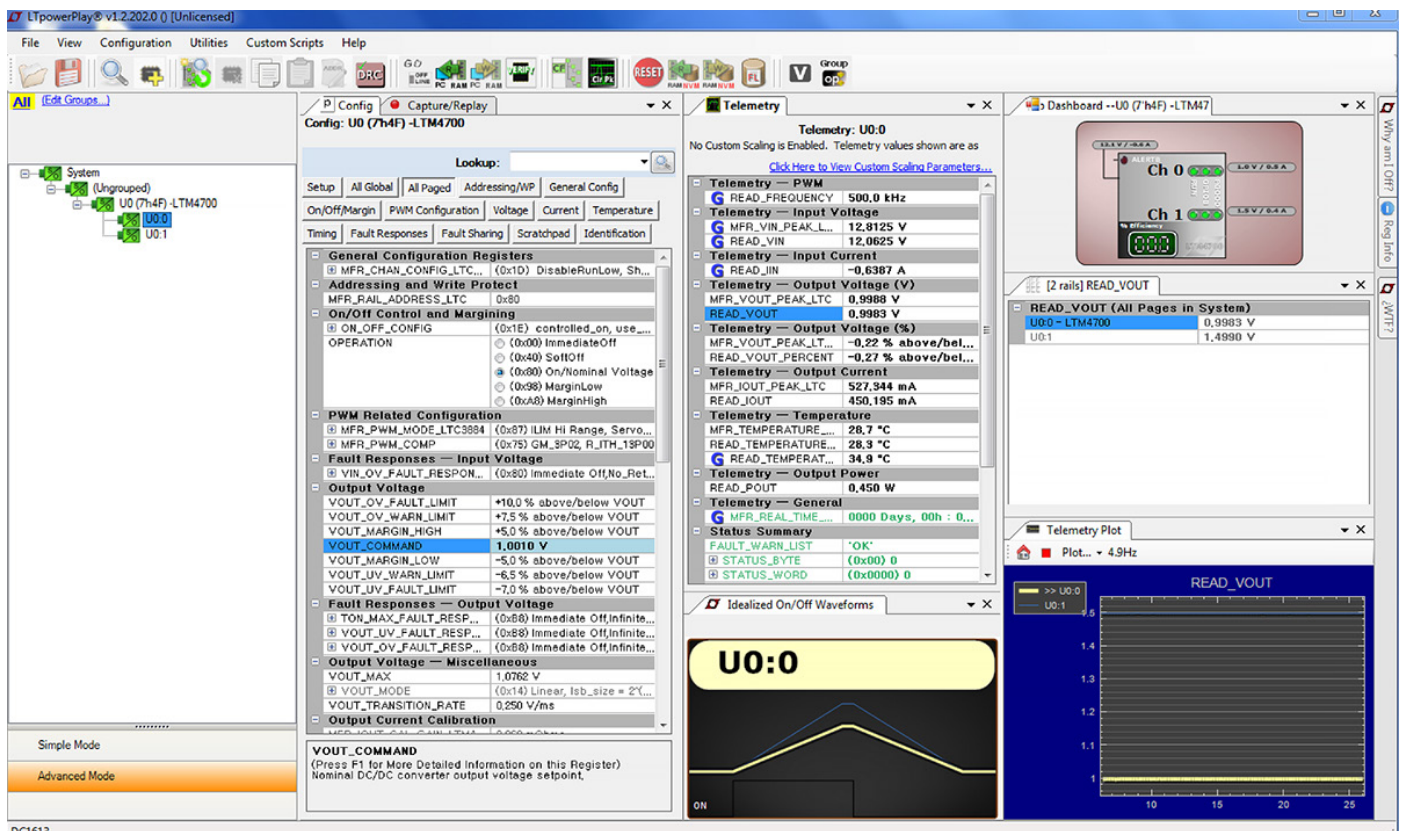

Figure 13. LTpowerPlay Main Interface

DEMO MANUAL DC2702A-A

LTPOWERPLAY QUICK START PROCEDURE

The following procedure describes how to use LTpowerPlay to monitor and change the settings of LTM4700.

1. Download and install the [LTpowerPlay GUI](#).
2. Launch the LTpowerPlay GUI.
- a. The GUI should automatically identify the DC2702A. The system tree on the left hand side should look like this:

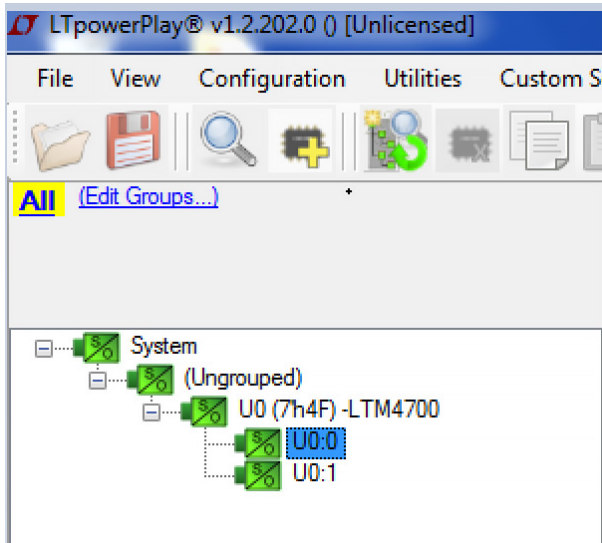

- b. A green message box shows for a few seconds in the lower left hand corner, confirming that LTM4700 is communicating:

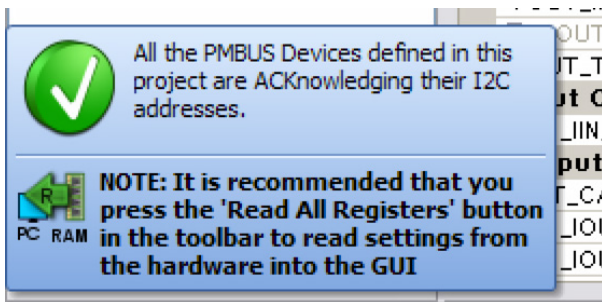

- c. In the tool bar, click the “R” (RAM to PC) icon to read the RAM from the LTM4700. This reads the configuration from the RAM of LTM4700 and loads it into the GUI.

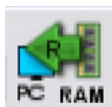

- d. If you want to change the output voltage to a different value, like 0.8V. In the Config tab, type in 0.8 in the VOUT_COMMAND box, like this:

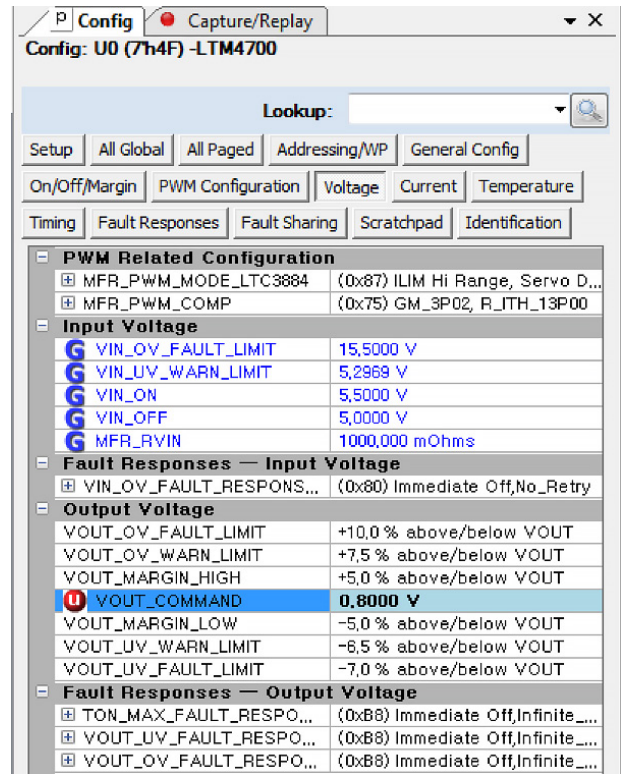

Then, click the “W” (PC to RAM) icon to write these register values to the LTM4700. After finishing this step, you will see the output voltage will change to 0.8V.



If the write is successful, you will see the following message:

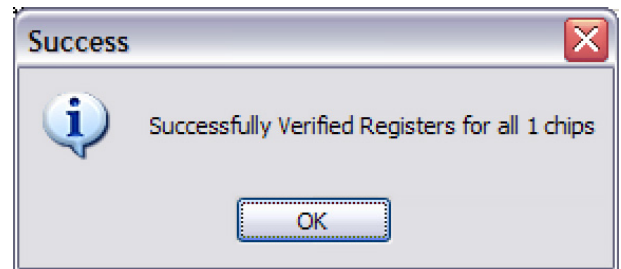

- e. You can save the changes into the NVM. In the tool bar, click “RAM to NVM” button, as following:



- f. Save the demo board configuration to a (*.proj) file. Click the Save icon and save the file. Name it whatever you want.

PARTS LIST

ITEM	QTY	REFERENCE	PART DESCRIPTION	MANUFACTURER/PART NUMBER
Required Circuit Components				
1	16	COUT1, COUT2, COUT3, COUT6, COUT7, COUT8, COUT14, COUT15, COUT16, COUT18, COUT19, COUT20, COUT21, COUT22, COUT9, COUT10	CAP., 330µF, X6S, 4V, 20%, 1210	TAIYO YUDEN, AMK325AC6337MM-P
2	1	CIN1	CAP., 180µF, ALUM. POLY., 25V, 20%, 8 × 12mm SMD, E12	PANASONIC, 25SVPF180M
3	2	C2, C15	CAP., 6800pF, X7R, 50V, 5%, 0603	AVX, 06035C682JAT2A
4	8	CIN2, CIN3, CIN4, CIN5, CIN6, CIN7, CIN8, CIN9	CAP., 22µF, X5R, 25V, 10%, 1210	AVX, 12103D226KAT2A MURATA, GRM32ER61E226KE15L TAIYO YUDEN, TMK325BJ226KM-P TAIYO YUDEN, TMK325BJ226KM-T
5	3	C21, C22, C24	CAP., 1µF, X5R, 25V, 10%, 0603	AVX, 06033D105KAT2A NIC, NMC0603X5R105K25TRPF
6	1	C23	CAP., 1µF, X7R, 25V, 10%, 0805	AVX, 08053C105KAT2A
7	1	C26	CAP., 0.1µF, X5R, 16V, 10%, 0603	AVX, 0603YD104KAT2A NIC, NMC0603X5R104K16TRPF
8	2	C27, C28	CAP., 0.01µF, X7R, 25V, 5%, 0603	AVX, 06033C103JAT2A
9	1	C33	CAP., 22µF, X5R, 6.3V, 20%, 0603	MURATA, GRM188R60J226MEA0D
10	26	E1, E2, E3, E4, E5, E6, E8, E9, E10, E11, E12, E13, E14, E15, E16, E17, E18, E19, E20, E21, E22, E23, E24, E25, E26	TEST POINT, TURRET, 0.064", MTG. HOLE	MILL-MAX, 2308-2-00-80-00-00-07-0
11	1	J1	CONN., SHROUDED HDR, MALE, 2 × 6, 2mm, VERT, STR, THT	FCI, 98414-G06-12ULF
12	3	JP1, JP2	CONN., HDR, MALE, 1 × 3, 2mm, VERT, STR, THT	WURTH ELEKTRONIK, 62000311121
13	3	J2, J3, J4	CONN., RF, BNC, RCPT JACK, 5-PIN, STR, THT, 50Ω	AMPHENOL RF, 112404
14	6	J5, J6, J7, J8, J9, J10	RING, LUG, CRIMP #10, NON-INSULATED, SOLDERLESS TERMINALS	KEYSTONE, 8205
15	12	J5, J6, J7, J8, J9, J10	NUT, HEX, STEEL, ZINC PLATE, 10-32	KEYSTONE, 4705
16	6	J5, J6, J7, J8, J9, J10	STUD, FASTENER, #10-32	PENNINGENGINEERING, KFH-032-10ET
17	6	J5, J6, J7, J8, J9, J10	WASHER, FLAT, STEEL, ZINC PLATE, OD: 0.436 [11.1]	KEYSTONE, 4703
18	1	J12	CONN., HDR, FEMALE, 2 × 7, 2mm, R/A THT	SULLINS CONNECTOR SOLUTIONS, NPPN072FJFN-RC
19	1	J11	CONN., HDR, MALE, 2 × 7, 2mm, R/A THT	MOLEX, 0877601416 MOLEX, 87760-1416
20	4	MH1, MH2, MH3, MH4	STANDOFF, NYLON, SNAP-ON, 0.50"	WURTH ELEKTRONIK, 702935000
21	2	Q1, Q2	XSTR., MOSFET, N-CH, 40V, TO-252 (DPAK)	VISHAY, SUD50N04-8M8P-4GE3
22	1	Q3	XSTR., MOSFET, P-CH, 20V, 5.9A, TO-236 (SOT23-3)	VISHAY, SI2365EDS-T1-GE3
23	6	R3, R25, R32, R69, R70, R93	RES., 10 OHMS, 1%, 1/10W, 0603	"NIC, NRC06F10R0TRF PANASONIC, ERJ3EKF10R0V ROHM, MCR03EZPFX10R0 VISHAY, CRCW060310R0FKEA YAGEO, RC0603FR-0710RL"
24	8	R9, R29, R33, R63, R65, R66, R91, R92	RES., 0 OHM, 1/10W, 0603, AEC-Q200	"NIC, NRC06Z0TRF VISHAY, CRCW06030000Z0EA"

DEMO MANUAL DC2702A-A

PARTS LIST

ITEM	QTY	REFERENCE	PART DESCRIPTION	MANUFACTURER/PART NUMBER
25	15	R10, R11, R12, R13, R14, R15, R16, R18, R19, R24, R52, R77, R94, R95, R106	RES., 10k Ω , 5%, 1/10W, 0603, AEC-Q200	PANASONIC, ERJ3GEYJ103V VISHAY, CRCW060310K0JNEA
26	1	R30	RES., 2.43k Ω , 1%, 1/10W, 0603, AEC-Q200	NIC, NRC06F2431TRF PANASONIC, ERJ3EKF2431V VISHAY, CRCW06032K43FKEA
27	1	R31	RES., 4.22k Ω , 1%, 1/10W, 0603, AEC-Q200	NIC, NRC06F4221TRF PANASONIC, ERJ3EKF4221V VISHAY, CRCW06034K22FKEA
28	1	R48	RES., 0 Ω , 3/4W, 2010, AEC-Q200	NIC, NRC50ZOTRF PANASONIC, ERJ12ZY0R00U VISHAY, CRCW20100000Z0EF
29	2	R50, R51	RES., 30 Ω , 1%, 1W, 2512, AEC-Q200	VISHAY, CRCW251230R0FKEG
30	1	R53	RES., 0.01 Ω , 1%, 1/2W, 2010, SENSE, AEC-Q200	VISHAY, WSL2010R0100FEA
31	2	R72, R73	RES., 4.99k Ω , 1%, 1/10W, 0603, AEC-Q200	NIC, NRC06F4991TRF PANASONIC, ERJ3EKF4991V VISHAY, CRCW06034K99FKEA
32	1	R78	RES., 15.8k Ω , 1%, 1/10W, 0603, AEC-Q200	NIC, NRC06F1582TRF PANASONIC, ERJ3EKF1582V VISHAY, CRCW060315K8FKEA
33	1	R90	RES 0.001 Ω , 1%, 1W, 2010	VISHAY, WSL20101L000FEA18
34	1	U1	IC, DUAL 50A POP PSM MODULE, BGA 15 \times 22 \times 7.82mm	ANALOG DEVICES, LTM4700EY#PBF
35	1	U2	IC, MEMORY, EEPROM, 2Kb (256 \times 8), TSSOP-8, 400kHz	MICROCHIP, 24LC025-I/ST MICROCHIP, 24LC025T-I/ST
36	3	XJP1, XJP2	CONN., SHUNT, FEMALE, 2 POS, 2mm	WURTH ELEKTRONIK, 60800213421
37	1		LABEL SPEC, DEMO BOARD SERIAL NUMBER	BRADY, THT-96-717-10
38	0		PCA ASSY DWG, DC2702A	
39	1		TOOL, STENCIL, 700-DC2702A	ANALOG DEVICES, 830-DC2702A
40	0		RES., OPTION, 1206	
41	0		CAP., OPTION, 0603	
42	1		PCB, DC2702A	PHASE 3 TECHNOLOGIES INC., 600-DC2702A
43	0		RES., OPTION, 0805	
44	0		CAP., OPTION, D-CASE	
45	0		RES., OPTION, 0603	
46	0		RES., OPTION, 2010	
47	0		DIODE, OPTION, SOD-323	

SCHEMATIC DIAGRAM

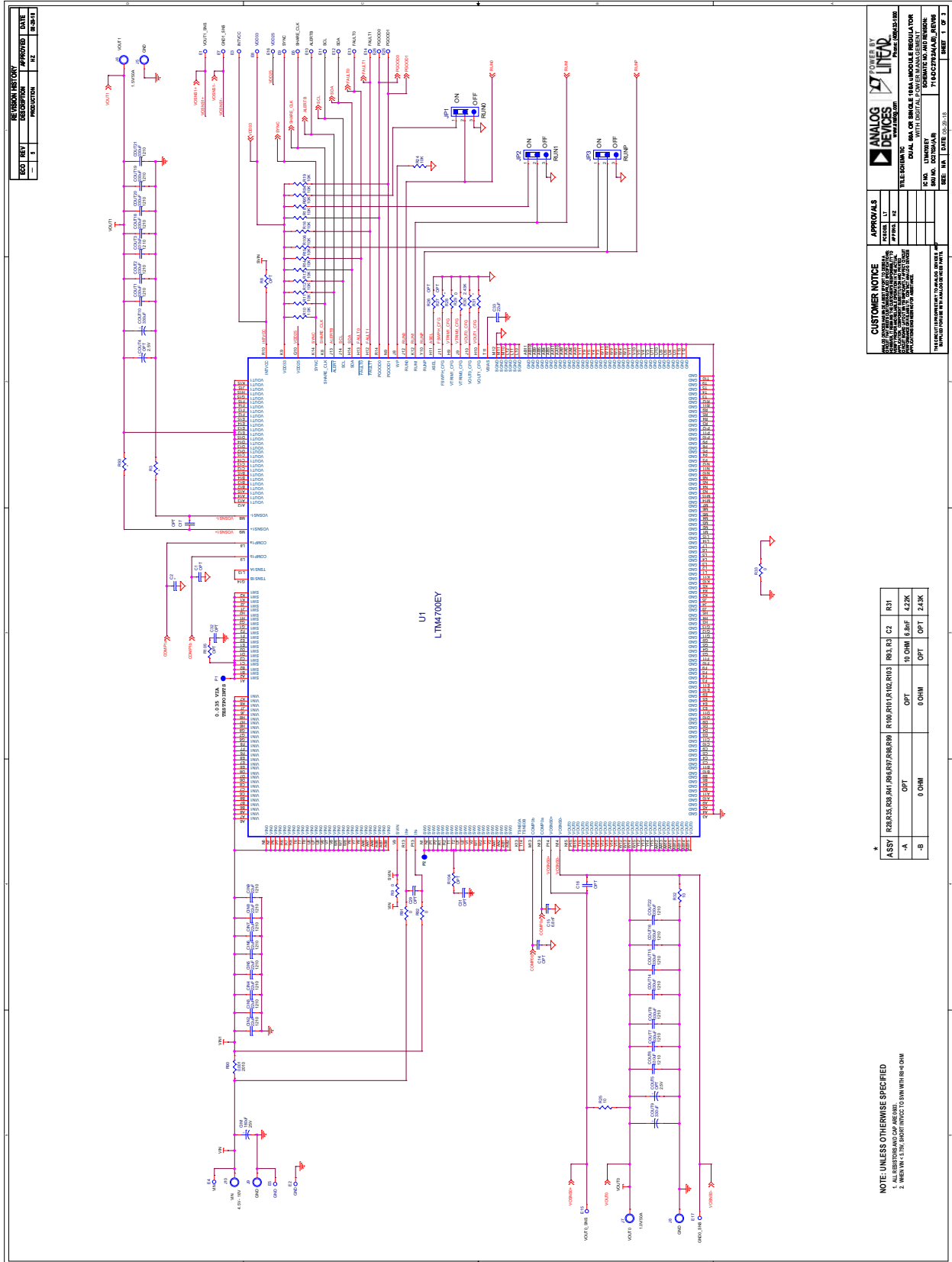

SCHEMATIC DIAGRAM

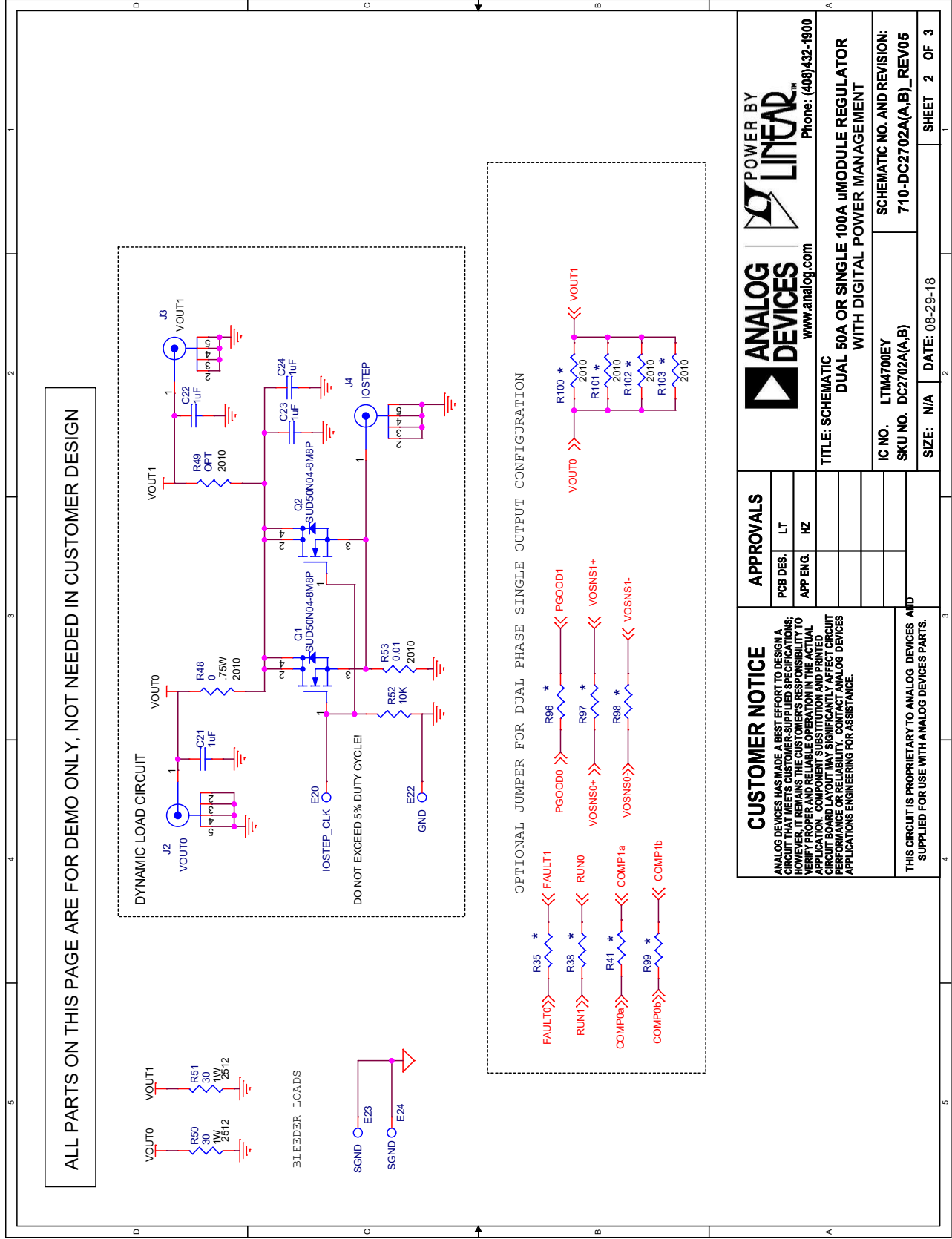

POWER BY
LINEAR™
 Phone: (408)432-1900

ANALOG DEVICES
 www.analog.com

TITLE: SCHEMATIC
DUAL 50A OR SINGLE 100A uMODULE REGULATOR
 WITH DIGITAL POWER MANAGEMENT

IC NO. LTM4700EY	SCHEMATIC NO. AND REVISION:
SKU NO. DC2702A(A,B)	710-DC2702A(A,B)_REV05
SIZE: N/A	DATE: 08-29-18
SHEET 2 OF 3	

SCHEMATIC DIAGRAM

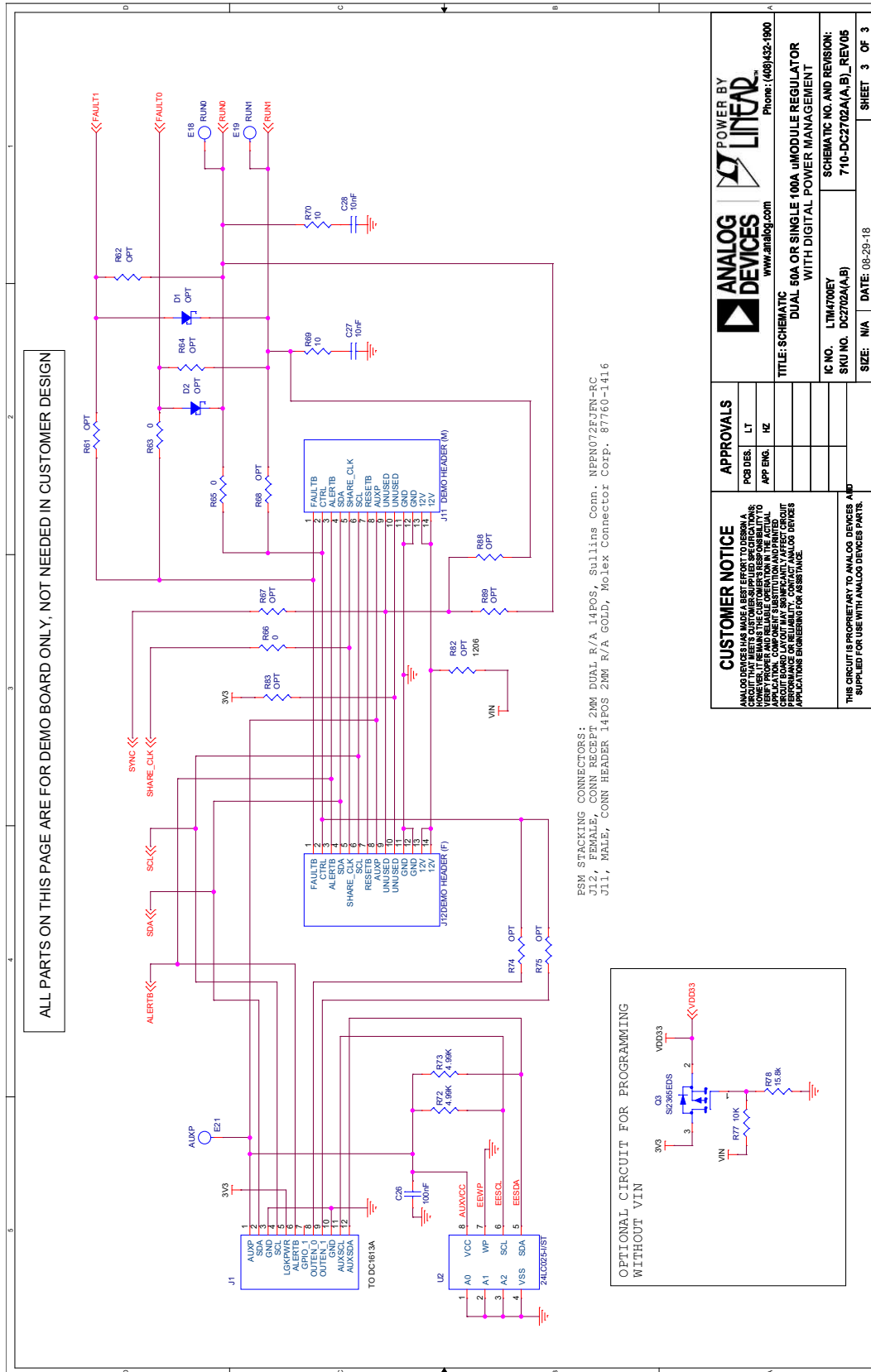



ESD Caution

ESD (electrostatic discharge) sensitive device. Charged devices and circuit boards can discharge without detection. Although this product features patented or proprietary protection circuitry, damage may occur on devices subjected to high energy ESD. Therefore, proper ESD precautions should be taken to avoid performance degradation or loss of functionality.

Legal Terms and Conditions

By using the evaluation board discussed herein (together with any tools, components documentation or support materials, the "Evaluation Board"), you are agreeing to be bound by the terms and conditions set forth below ("Agreement") unless you have purchased the Evaluation Board, in which case the Analog Devices Standard Terms and Conditions of Sale shall govern. Do not use the Evaluation Board until you have read and agreed to the Agreement. Your use of the Evaluation Board shall signify your acceptance of the Agreement. This Agreement is made by and between you ("Customer") and Analog Devices, Inc. ("ADI"), with its principal place of business at One Technology Way, Norwood, MA 02062, USA. Subject to the terms and conditions of the Agreement, ADI hereby grants to Customer a free, limited, personal, temporary, non-exclusive, non-sublicensable, non-transferable license to use the Evaluation Board FOR EVALUATION PURPOSES ONLY. Customer understands and agrees that the Evaluation Board is provided for the sole and exclusive purpose referenced above, and agrees not to use the Evaluation Board for any other purpose. Furthermore, the license granted is expressly made subject to the following additional limitations: Customer shall not (i) rent, lease, display, sell, transfer, assign, sublicense, or distribute the Evaluation Board; and (ii) permit any Third Party to access the Evaluation Board. As used herein, the term "Third Party" includes any entity other than ADI, Customer, their employees, affiliates and in-house consultants. The Evaluation Board is NOT sold to Customer; all rights not expressly granted herein, including ownership of the Evaluation Board, are reserved by ADI. CONFIDENTIALITY. This Agreement and the Evaluation Board shall all be considered the confidential and proprietary information of ADI. Customer may not disclose or transfer any portion of the Evaluation Board to any other party for any reason. Upon discontinuation of use of the Evaluation Board or termination of this Agreement, Customer agrees to promptly return the Evaluation Board to ADI. ADDITIONAL RESTRICTIONS. Customer may not disassemble, decompile or reverse engineer chips on the Evaluation Board. Customer shall inform ADI of any occurred damages or any modifications or alterations it makes to the Evaluation Board, including but not limited to soldering or any other activity that affects the material content of the Evaluation Board. Modifications to the Evaluation Board must comply with applicable law, including but not limited to the RoHS Directive. TERMINATION. ADI may terminate this Agreement at any time upon giving written notice to Customer. Customer agrees to return to ADI the Evaluation Board at that time. LIMITATION OF LIABILITY. THE EVALUATION BOARD PROVIDED HEREUNDER IS PROVIDED "AS IS" AND ADI MAKES NO WARRANTIES OR REPRESENTATIONS OF ANY KIND WITH RESPECT TO IT. ADI SPECIFICALLY DISCLAIMS ANY REPRESENTATIONS, ENDORSEMENTS, GUARANTEES, OR WARRANTIES, EXPRESS OR IMPLIED, RELATED TO THE EVALUATION BOARD INCLUDING, BUT NOT LIMITED TO, THE IMPLIED WARRANTY OF MERCHANTABILITY, TITLE, FITNESS FOR A PARTICULAR PURPOSE OR NON-INFRINGEMENT OF INTELLECTUAL PROPERTY RIGHTS. IN NO EVENT WILL ADI AND ITS LICENSORS BE LIABLE FOR ANY INCIDENTAL, SPECIAL, INDIRECT, OR CONSEQUENTIAL DAMAGES RESULTING FROM CUSTOMER'S POSSESSION OR USE OF THE EVALUATION BOARD, INCLUDING BUT NOT LIMITED TO LOST PROFITS, DELAY COSTS, LABOR COSTS OR LOSS OF GOODWILL. ADI'S TOTAL LIABILITY FROM ANY AND ALL CAUSES SHALL BE LIMITED TO THE AMOUNT OF ONE HUNDRED US DOLLARS (\$100.00). EXPORT. Customer agrees that it will not directly or indirectly export the Evaluation Board to another country, and that it will comply with all applicable United States federal laws and regulations relating to exports. GOVERNING LAW. This Agreement shall be governed by and construed in accordance with the substantive laws of the Commonwealth of Massachusetts (excluding conflict of law rules). Any legal action regarding this Agreement will be heard in the state or federal courts having jurisdiction in Suffolk County, Massachusetts, and Customer hereby submits to the personal jurisdiction and venue of such courts. The United Nations Convention on Contracts for the International Sale of Goods shall not apply to this Agreement and is expressly disclaimed.