



MET Laboratories, Inc. *Safety Certification - EMI - Telecom Environmental Simulation*

914 WEST PATAPSCO AVENUE • BALTIMORE, MARYLAND 21230-3432 • PHONE (410) 354-3300 • FAX (410) 354-3313
33439 WESTERN AVENUE • UNION CITY, CALIFORNIA 94587 • PHONE (510) 489-6300 • FAX (510) 489-6372
3162 BELICK STREET • SANTA CLARA, CA 95054 • PHONE (408) 748-3585 • FAX (510) 489-6372

September 23, 2008

Linear Technology Corporation
1630 McCarthy Blvd.
Milpitas, CA 95035

Dear David Ng,

Enclosed is the EMC test report for compliance testing of the Linear Technology Corporation, LTM8032, tested to the requirements of EN 55022: 2006 for a Class B Device.

Thank you for using the services of MET Laboratories, Inc. If you have any questions regarding these results or if MET can be of further service to you, please feel free to contact me.

Sincerely yours,
MET LABORATORIES, INC.

Mae Ramirez
Documentation Department

Reference: (\Linear Technology Corporation\EMCS81043-EURO)

Certificates and reports shall not be reproduced except in full, without the written permission of MET Laboratories, Inc. While use of the National Voluntary Laboratory Accreditation Program (NVLAP) letters, the NVLAP Logo, or the A2LA logo in this report reflects MET accreditation under these programs, the report must not be used by the client to claim product certification, approval, or endorsement by NVLAP, NIST, or A2LA, or any agency of the Federal Government. This letter of transmittal is not a part of the attached report.



The Nation's First Licensed Nationally Recognized Testing Laboratory



MET Laboratories, Inc. *Safety Certification - EMI - Telecom Environmental Simulation*

914 WEST PATAPSCO AVENUE • BALTIMORE, MARYLAND 21230-3432 • PHONE (410) 354-3300 • FAX (410) 354-3313
33439 WESTERN AVENUE • UNION CITY, CALIFORNIA 94587 • PHONE (510) 489-6300 • FAX (510) 489-6372
3162 BELICK STREET • SANTA CLARA, CA 95054 • PHONE (408) 748-3585 • FAX (510) 489-6372

**Electromagnetic Compatibility
Test Report**

for the

**Linear Technology Corporation
LTM8032**

Tested under

**EN 55022: 2006
For a Class B Device**

MET Report: EMCS81043-EURO

September 23, 2008

Prepared for:

**Linear Technology Corporation
1630 McCarthy Blvd.
Milpitas, CA 95035**

**Prepared by:
MET Laboratories, Inc.
33439 Western Avenue
Union City, CA 94587**



Electromagnetic Compatibility Test Report

For the

**Linear Technology Corporation
LTM8032**

Tested under

**EN 55022: 2006
For a Class B Device**

MET Report: EMCS81043-EURO

Charles Huang
Test Engineer, Electromagnetic Compatibility Lab

Mae Ramirez
Documentation Department

Engineering Statement: The measurements shown in this report were made in accordance with the procedures indicated, and the emissions from this equipment were found to be within the applicable limits. I assume full responsibility for the accuracy and completeness of these measurements, and for the qualifications of all persons taking them. It is further stated that upon the basis of the measurements made, the equipment tested is capable of operation in accordance with the requirements of EN 55022 2006 under normal use and maintenance.

Asad Bajwa
Manager, Electromagnetic Compatibility Lab



Report Status Sheet

Revision	Report Date	Reason for Revision
Ø	September 23, 2008	Initial Issue.



Table of Contents

1.0 Testing Summary	1
2.0 Equipment Configuration	2
2.1 Overview	2
2.2 Test Site	2
2.3 Description of Test Sample	2
2.4 Equipment Configuration	4
2.5 Support Equipment	4
2.6 Ports and Cabling Information	4
2.7 Mode of Operation	5
2.8 Method of Monitoring EUT Operation	5
2.9 Modifications	5
2.10 Disposition of EUT	5
3.0 Electromagnetic Compatibility Emission Criteria	6
3.1 Radiated Emission: Limits of Electromagnetic Radiation Disturbance	6
4.0 Test Equipment	15



List of Tables

Table 1. Summary of EMC EN 55022: 2006 Compliance Testing	1
Table 2. Equipment Configuration	4
Table 3. Support Equipment	4
Table 4. Ports and Cabling Information	4
Table 5. Electromagnetic Radiated Disturbance limits from Clause 6 of EN 55022	6
Table 6. Radiated Emission Test Results (3.6in – 2.5out)	8
Table 7. Radiated Emission Test Results (7Vin – 5Vout).....	9
Table 8. Radiated Emission Test Results (13Vin – 10Vout).....	10
Table 9. Radiated Emission Test Results (36Vin – 2.5Vout).....	11
Table 10. Radiated Emission Test Results (36Vin – 5Vout).....	12
Table 11. Radiated Emission Test Results (36Vin – 10Vout).....	13

List of Figures

Figure 1. Block Diagram of Test Configuration	3
---	---

List of Photographs

Photograph 1. Radiated Emission: Limits of Electromagnetic Radiation Disturbance, Test Setup	14
--	----



List of Terms and Abbreviations

AC	Alternating Current
ACF	Antenna Correction Factor
Cal	Calibration
<i>d</i>	Measurement Distance
dB	Decibels
dB μ A	Decibels above one microamp
dB μ V	Decibels above one microvolt
dB μ A/m	Decibels above one microamp per meter
dB μ V/m	Decibels above one microvolt per meter
DC	Direct Current
E	Electric Field
ESD	Electrostatic Discharge
EUT	Equipment Under Test
<i>f</i>	Frequency
CISPR	Comite International Special des Perturbations Radioelectriques (International Special Committee on Radio Interference)
GRP	Ground Reference Plane
H	Magnetic Field
HCP	Horizontal Coupling Plane
Hz	Hertz
IEC	International Electrotechnical Commission
kHz	kilohertz
kPa	kilopascal
kV	kilovolt
LISN	Line Impedance Stabilization Network
MHz	Megahertz
μ H	microhenry
μ F	microfarad
μ s	microseconds
PRF	Pulse Repetition Frequency
RF	Radio Frequency
RMS	Root-Mean-Square
V/m	Volts per meter
VCP	Vertical Coupling Plane



1.0 Testing Summary

The following tests specified by EN 55022 were performed with the following results.

Specification	Test Description	Compliance
EN 55022: 2006	Radiated Emissions - Class B	Compliant

Table 1. Summary of EMC EN 55022: 2006 Compliance Testing



2.0 Equipment Configuration

2.1 Overview

MET Laboratories, Inc. was contracted by Linear Technology Corporation to perform testing on the LTM8032, under Linear Technology Corporation purchase order number X5485Y.

This document describes the test setups, test methods, required test equipment, and the test limit criteria used to perform compliance testing of the Linear Technology Corporation, LTM8032 with the requirements of EN 55022 limits and Methods of Radio Disturbance characteristic of Information Technology Equipment.

The results obtained relate only to the item(s) tested.

Model(s) Tested:	LTM8032
Model(s) Covered:	LTM8032
EUT Specifications:	Primary Power: DC
	Equipment Emissions Class: B
Evaluated by:	Charles Huang
Date(s):	September 23, 2008

2.2 Test Site

All testing was performed at MET Laboratories, Inc., 3162 Belick St., Santa Clara, CA 95054. All equipment used in making physical determinations is accurate and bears recent traceability to the National Institute of Standards and Technology.

2.3 Description of Test Sample

The LTM8032, Equipment Under Test (EUT) is a 2A switching dc/dc converter equipped with an EMI input filter. It is intended for use in systems that have loads as large as 2A and require low radiated electromagnetic emissions.

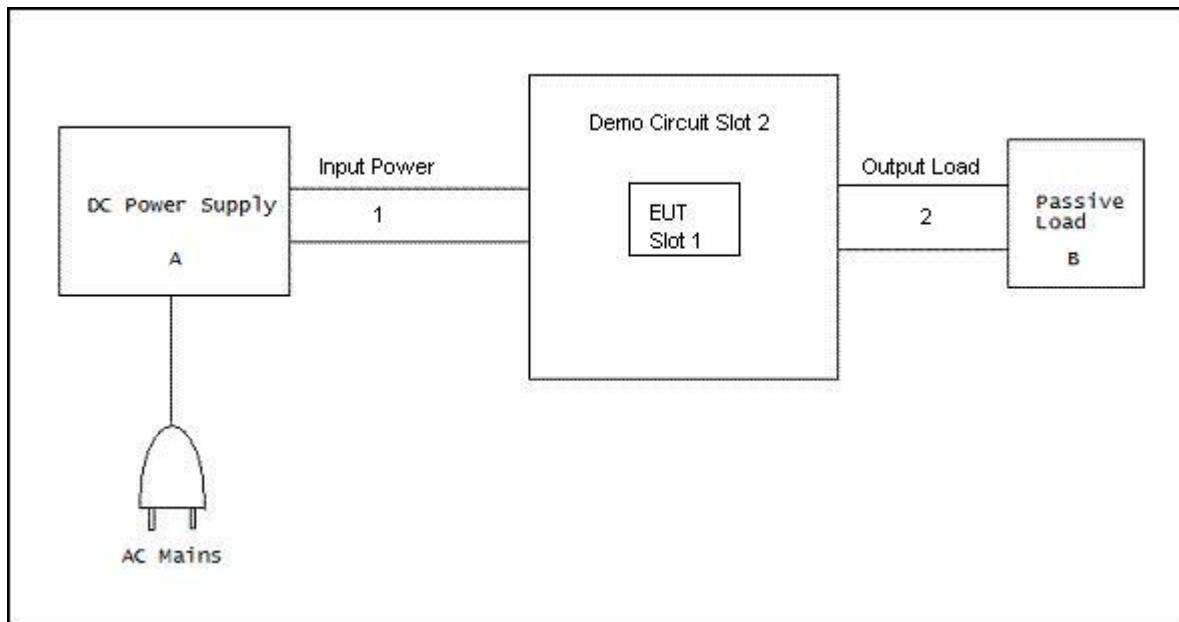

Figure 1. Block Diagram of Test Configuration



2.4 Equipment Configuration

The EUT was set up as outlined in Figure 1. All equipment incorporated as part of the EUT is included in the following list.

Ref. ID	Slot #	Name / Description	Model Number	Part Number	Serial Number	Rev. #
0831	1	EMC Compliant 36V, 2A Buck Converter	LTM 8032EV	LTM8032EV	N/A	N/A
-	2	LTM8032 EMC Compliant 36V, 2A DC/DC Step-Down Power uModule Demo Circuit	-	DC1386A	N/A	Initial Release

Table 2. Equipment Configuration

2.5 Support Equipment

Support equipment necessary for the operation and testing of the EUT is included in the following list.

Ref. ID	Name / Description	Manufacturer	Model Number	Customer Supplied Calibration Data
A	DC Power Supply	Power Designs	TP343B	None – output is verified by measurement for each configuration.
B	Passive Load	Customer supplied	-	-

Table 3. Support Equipment

2.6 Ports and Cabling Information

Ref. ID	Port name on EUT	Cable Description or reason for no cable	Qty	Length as tested (m)	Max Length (m)	Shielded? (Y/N)	Termination Box ID & Port Name
1	Input power	22 AWG wire	2	2		No	None
2	Output load	18 AWG wire	2	0.1		No	None

Table 4. Ports and Cabling Information



2.7 Mode of Operation

The LTM8032 was powered from a DC power source up to 36V, and can support loads as high as 2A. It regulates its output to a predetermined DC voltage. No controls were exercised during test.

2.8 Method of Monitoring EUT Operation

The EUT was performing its intended function when the output was in regulation. The test was performed on three LTM8032 samples – one set to regulate at 2.5V, another to 5V, and another to 10V.

The EUT was not performing its intended function if the output of any sample is significantly above or below its regulation point.

2.9 Modifications To EUT

No modifications were made to the EUT.

2.10 Disposition of EUT

The test sample including all support equipment (if any), submitted to the Electro-Magnetic Compatibility Lab for testing was returned to Linear Technology Corporation upon completion of testing.



3.0 Electromagnetic Compatibility Emission Criteria

3.1 Radiated Emission: Limits of Electromagnetic Radiation Disturbance

Test Method: EN 55022: 2006
Limits and Methods of Measurement of Radio Disturbance Characteristics of Information Technology Equipment.

Test Requirement(s): EN 55022, Section 6, Limits for Radiated Disturbances:

For radiated emission in the frequency range 30 MHz - 1 000 MHz, the EUT shall meet the Class B radiated emission limits shown in Table 5.

Frequency Band (MHz)	Class A Quasi-Peak limits 10 m measurement distance (dBµV/m)	Class B Quasi-Peak limits 10 m measurement distance (dBµV/m)
30 to 230	40	30
230 to 1000	47	37

Table 5. Electromagnetic Radiated Disturbance limits from Clause 6 of EN 55022

Test Procedure: The EUT was placed on a 0.8m-high wooden table located inside a semi-anechoic chamber. The method of testing, test conditions, and test procedures of EN 55022 were used. An antenna was located 3 m from the EUT on an adjustable mast. A pre-scan was first performed in order to find prominent radiated emissions. For final emissions measurements at each frequency of interest, the EUT was rotated and the antenna height was varied between 1 m and 4 m in order to maximize the emission. Measurements in both horizontal and vertical polarities were made and the data was recorded. Unless otherwise specified, measurements were made using a quasi-peak detector with a 120 kHz bandwidth.

Emissions measured at 3m were normalized using an inverse proportionality factor of 20dB per decade for comparison to the 10 m limit. The physical size of the EUT was taken into account as to avoid near-field effects, which could occur near 30 MHz. See Photograph 1 for a picture of the test setup.

Environmental Conditions for Radiated Emission	
Ambient Temperature:	24 °C
Relative Humidity:	42 %

Test Results: The EUT was **compliant** with the requirement(s) of this section. Measured emissions were below applicable limits.



Linear Technology Corporation
LTM8032

Electromagnetic Compatibility
Emission Criteria
EN 55022: 2006

Test Engineer(s): Charles Huang

Test Date(s): 7/30/2008



Radiated Emission: Limits of Electromagnetic Radiation Disturbance, Test Results

Frequency (MHz)	Antenna Polarity	EUT Azimuth (Degrees)	Antenna Height (cm)	Uncorrected Amplitude (dBuV)	ACF (dB/m)	Pre Amp Gain (dB)	CBL (dB)	Corrected Amplitude (dBuV)	Limit (dBuV)	Margin (dB)
55.3	V	110	100	1.36	6.87	0	1.175	9.405	30	-20.595
180	H	0	100	-4.35	9.3	0	2.223	7.173	30	-22.827
524	V	0	100	-4.66	17.56	0	3.839	16.739	37	-20.261
586	H	0	100	-4.66	18.9	0	4.072	18.312	37	-18.688
932	V	0	100	-4.05	21.34	0	5.156	22.446	37	-14.554
981	H	0	100	-4.2	21.08	0	5.314	22.194	37	-14.806

Table 6. Radiated Emission Test Results (3.6in – 2.5out)

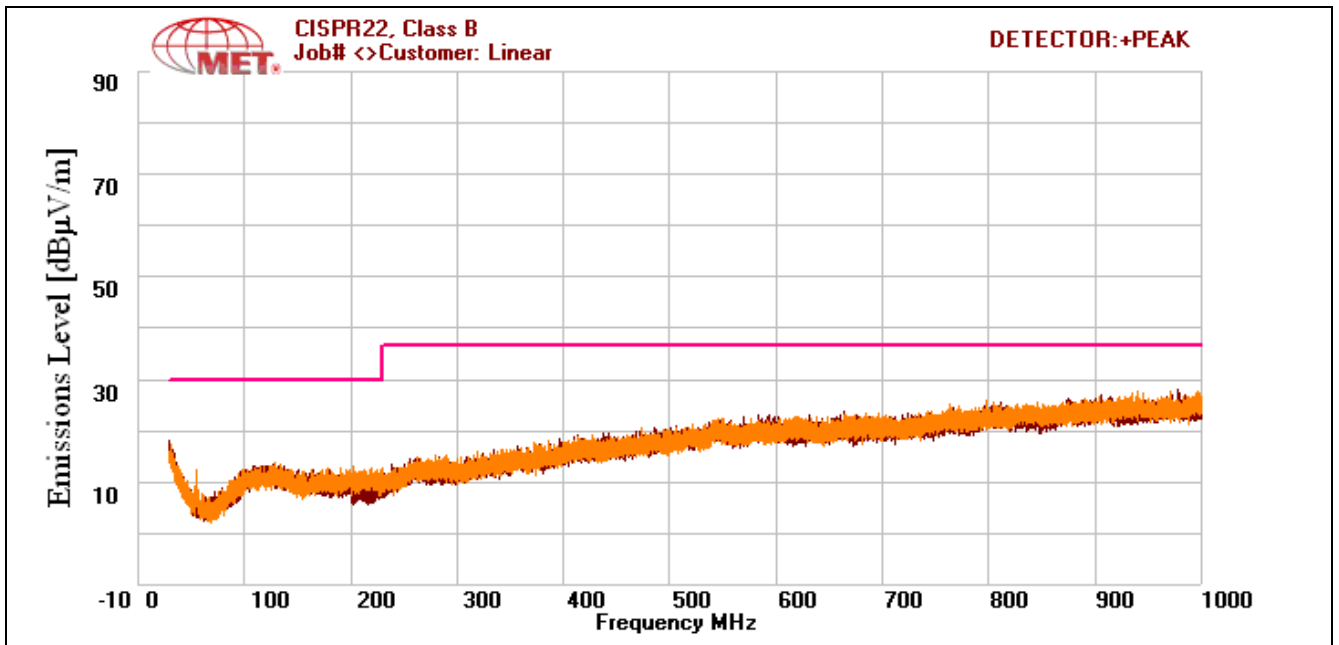



Radiated Emission: Limits of Electromagnetic Radiation Disturbance, Test Results

Frequency (MHz)	Antenna Polarity	EUT Azimuth (Degrees)	Antenna Height (cm)	Uncorrected Amplitude (dBuV)	ACF (dB/m)	Pre Amp Gain (dB)	CBL (dB)	Corrected Amplitude (dBuV)	Limit (dBuV)	Margin (dB)
40.76	H	0	100	-5.39	12.42	0	0.982	8.012	30	-21.988
55.4	V	102	100	1.3	6.86	0	1.175	9.335	30	-20.665
203.68	V	0	100	-4.92	10.321	0	2.34	7.741	30	-22.259
318.9	H	0	100	-5.82	13.578	0	2.943	10.701	37	-26.299
767	H	0	100	-4.66	19.42	0	4.67	19.43	37	-17.57
871.7	V	0	100	-4.52	20.734	0	4.979	21.193	37	-15.807

Table 7. Radiated Emission Test Results (7Vin – 5Vout)

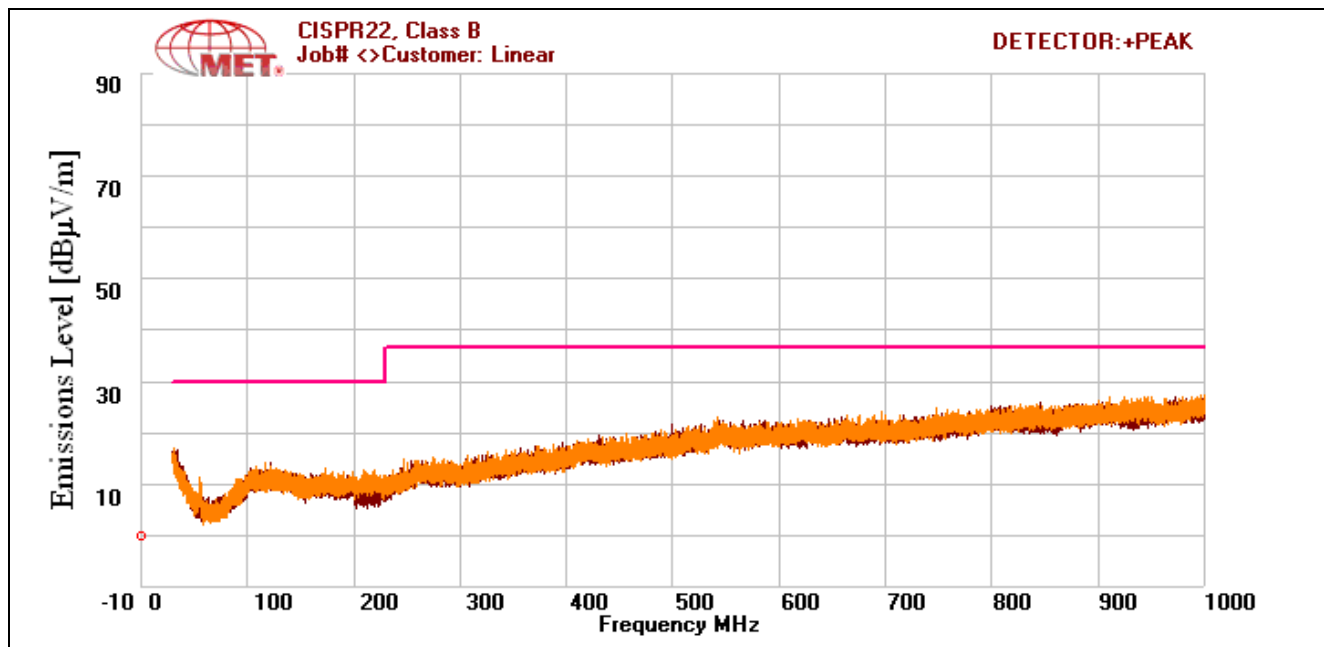



Radiated Emission: Limits of Electromagnetic Radiation Disturbance, Test Results

Frequency (MHz)	Antenna Polarity	EUT Azimuth (Degrees)	Antenna Height (cm)	Uncorrected Amplitude (dBuV)	ACF (dB/m)	Pre Amp Gain (dB)	CBL (dB)	Corrected Amplitude (dBuV)	Limit (dBuV)	Margin (dB)
54.76	V	54	100	0.82	6.924	0	1.169	8.913	30	-21.087
198.8	H	0	100	-4.2	9.2	0	2.341	7.341	30	-22.659
513.8	V	0	100	-4.74	17.508	0	3.758	16.526	37	-20.474
577.9	H	0	100	-4.82	18.39	0	4	17.57	37	-19.43
906	V	0	100	-4.28	20.88	0	5.061	21.661	37	-15.339
907	H	0	100	-4.28	20.92	0	5.062	21.702	37	-15.298

Table 8. Radiated Emission Test Results (13Vin – 10Vout)

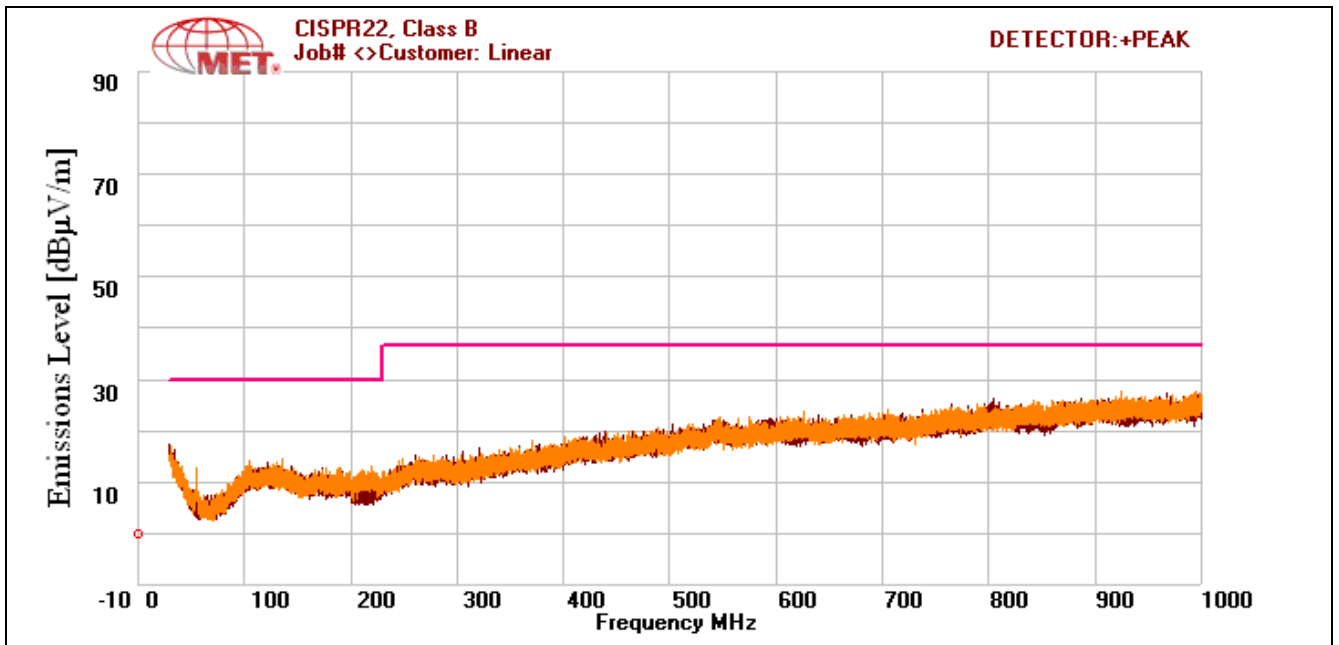



Radiated Emission: Limits of Electromagnetic Radiation Disturbance, Test Results

Frequency (MHz)	Antenna Polarity	EUT Azimuth (Degrees)	Antenna Height (cm)	Uncorrected Amplitude (dBuV)	ACF (dB/m)	Pre Amp Gain (dB)	CBL (dB)	Corrected Amplitude (dBuV)	Limit (dBuV)	Margin (dB)
41.3	V	220	100	2.07	11.35	0	0.987	14.407	30	-15.593
55.36	V	230	100	1.21	6.864	0	1.175	9.249	30	-20.751
166.2	H	0	100	-4.5	9.876	0	2.148	7.524	30	-22.476
197.9	V	172	100	6.69	9.974	0	2.344	19.008	30	-10.992
546	H	0	100	-4.66	18.94	0	3.931	18.211	37	-18.789
861	H	0	100	-4.28	19.62	0	4.956	20.296	37	-16.704

Table 9. Radiated Emission Test Results (36Vin – 2.5Vout)

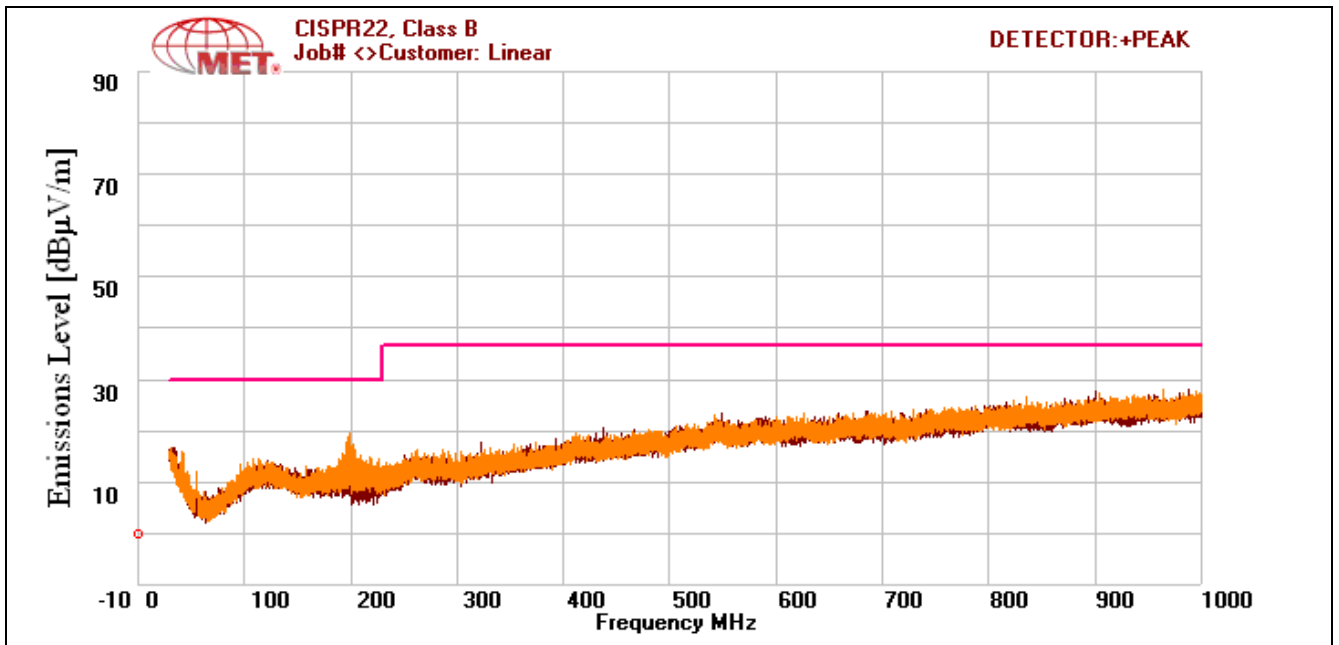



Radiated Emission: Limits of Electromagnetic Radiation Disturbance, Test Results

Frequency (MHz)	Antenna Polarity	EUT Azimuth (Degrees)	Antenna Height (cm)	Uncorrected Amplitude (dBuV)	ACF (dB/m)	Pre Amp Gain (dB)	CBL (dB)	Corrected Amplitude (dBuV)	Limit (dBuV)	Margin (dB)
41.72	V	200	100	1.56	11.14	0	0.991	13.691	30	-16.309
55.44	V	0	100	0.54	6.856	0	1.175	8.571	30	-21.429
199.6	V	170	100	6.74	10.076	0	2.339	19.155	30	-10.845
515.6	H	0	100	-4.82	17.488	0	3.768	16.436	37	-20.564
787.2	V	161	100	-4.43	19.688	0	4.701	19.959	37	-17.041
959	H	0	100	-4.28	20.62	0	5.258	21.598	37	-15.402

Table 10. Radiated Emission Test Results (36Vin – 5Vout)

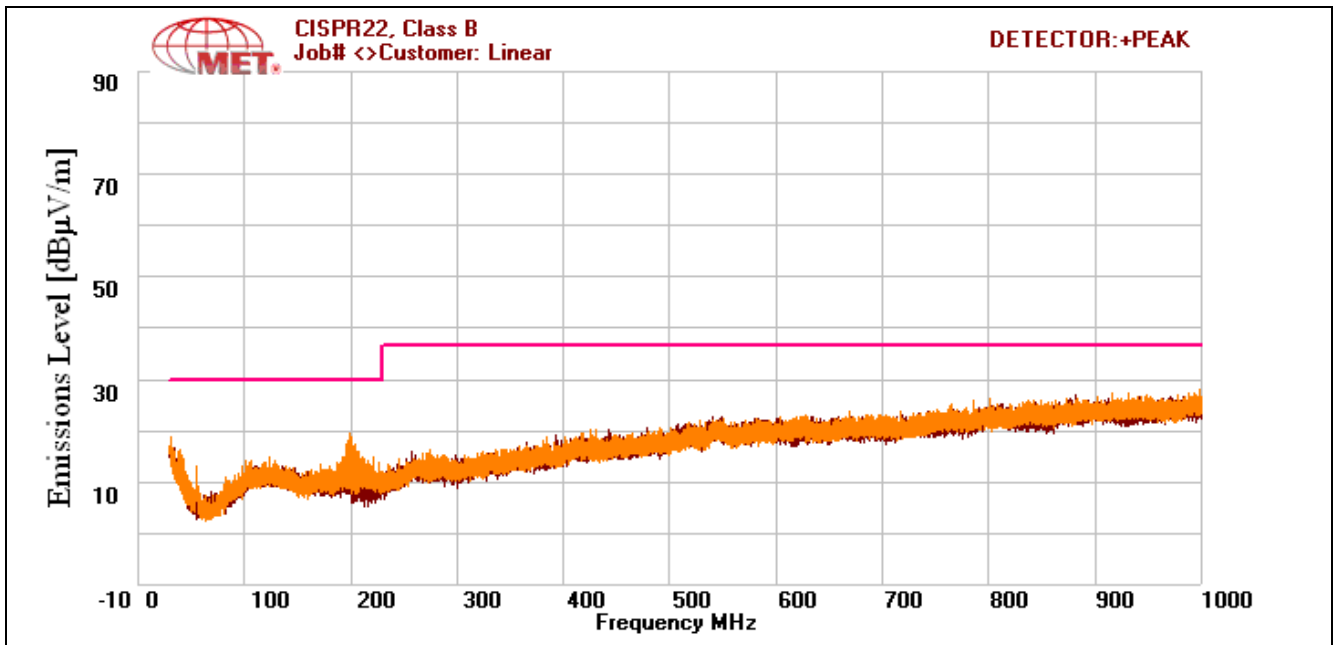



Radiated Emission: Limits of Electromagnetic Radiation Disturbance, Test Results

Frequency (MHz)	Antenna Polarity	EUT Azimuth (Degrees)	Antenna Height (cm)	Uncorrected Amplitude (dBuV)	ACF (dB/m)	Pre Amp Gain (dB)	CBL (dB)	Corrected Amplitude (dBuV)	Limit (dBuV)	Margin (dB)
55.06	V	64	100	1.3	6.894	0	1.172	9.366	30	-20.634
188.8	H	0	100	-3.98	9.176	0	2.297	7.493	30	-22.507
198.2	V	162	100	4.21	9.992	0	2.343	16.545	30	-13.455
515	H	0	100	-4.74	17.5	0	3.765	16.525	37	-20.475
832.9	V	0	100	-4.35	20.716	0	4.867	21.233	37	-15.767
920	H	0	100	-4.2	20.3	0	5.118	21.218	37	-15.782

Table 11. Radiated Emission Test Results (36Vin – 10Vout)

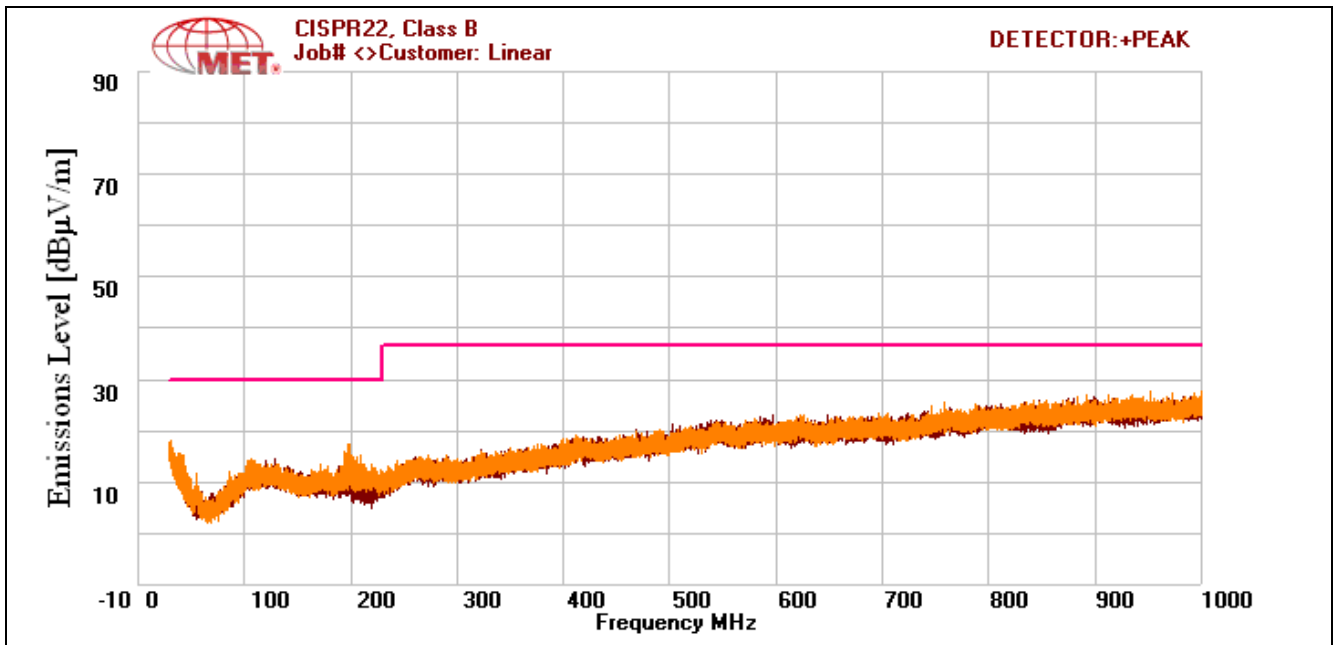

Radiated Emission: Limits of Electromagnetic Radiation Disturbance, Test Setup



Photograph 1. Radiated Emission: Limits of Electromagnetic Radiation Disturbance, Test Setup



4.0 Test Equipment

Calibrated test equipment utilized during testing was maintained in a current state of calibration per the requirements of ANSI/NCSL Z540-1-1994 and ANSI/ISO/IEC 17025:2000.

Test Name: EN 55022 (CISPR 22):2006 Radiated Emissions Electric Field			Test Date(s): 7/30/2008		
MET Asset #	Nomenclature	Manufacturer	Model	Last Cal Date	Cal Due Date
1S2421	EMI Test Receiver	Rohde & Schwarz	ESIB 7	4/18/2008	4/18/2009
1S2481	10 Meter Chamber	ETS-Lingren	DKE- 8X8 DBL	12/26/2007	12/26/2008
1S2483	10 Meter Chamber Control Room	ETS-Lingren	DKE-4X7 RH	See Note	
1S2185	Bilog Antenna	CHASE	CBL 6111	7/17/2008	7/17/2009

Note: Functionally tested equipment is verified using calibrated instrumentation at the time of testing.