

FEATURES

- Low Supply Current: 200 μ A Max @ $V_S = 5$ V
- Single-Supply Operation: 5 V to 30 V
- Dual-Supply Operation: 2.5 V to 15 V
- Low Input Offset Voltage: 500 μ V Typ
- Low Input Offset Voltage Drift: 5 μ V/ $^{\circ}$ C Typ
- High Common-Mode Input Range: V_- to $(V_+ - 1.5$ V)
- High CMRR: 100 dB Typ
- High Open-Loop Gain: 1100 V/mV Typ
- LM 148 Pinout

PIN CONNECTIONS

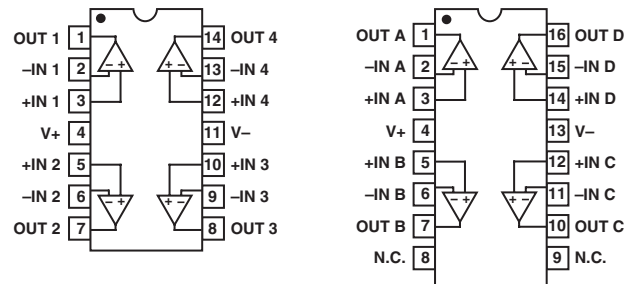

14-Pin Hermetic DIP
(Y-Suffix)

14-Pin Epoxy DIP
(P-Suffix)

16-Pin SOL
(S-Suffix)

GENERAL DESCRIPTION

The OP420 quad micropower operational amplifier is a single-chip quad patterned after the OP20 precision micropower single operational amplifier. A Darlington PNP input stage allows the input common-mode voltage to include V_- . The wide input range combined with low power supply drain (~ 40 μ A/section at 5 V) provides a unique solution for designs requiring high functional density and portable operation. Applications include 2-wire transmitters for process control loops, battery-operated remote-line filters, signal preconditioning amplifiers, and a variety of multiple-gain block arrays.

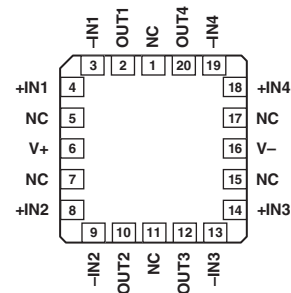

OP420CRC/883
20-Lead LCC
(RC-Suffix)

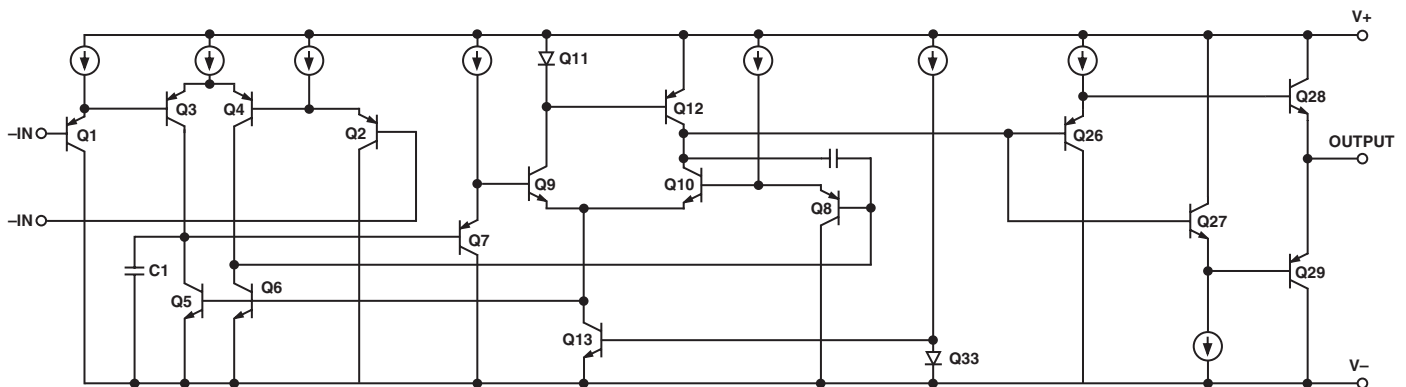

Figure 1. Simplified Schematic (1/4 Shown)

REV. A

Information furnished by Analog Devices is believed to be accurate and reliable. However, no responsibility is assumed by Analog Devices for its use, nor for any infringements of patents or other rights of third parties that may result from its use. No license is granted by implication or otherwise under any patent or patent rights of Analog Devices.

OP420—SPECIFICATIONS

ELECTRICAL CHARACTERISTICS ($V_S = \pm 15\text{ V}$, $T_A = 25^\circ\text{C}$, unless otherwise noted.)

Parameter	Symbol	Conditions	OP420C OP420G			Unit
			Min	Typ	Max	
INPUT OFFSET VOLTAGE	V_{OS}	$V_S = \pm 2.5\text{ V to } \pm 15\text{ V}$		1	4	mV
INPUT OFFSET CURRENT*	I_{OS}	$V_S = \pm 2.5\text{ V to } \pm 15\text{ V}$		0.8	2.5	nA
INPUT BIAS CURRENT*	I_B	$V_S = \pm 2.5\text{ V to } \pm 15\text{ V}$		12	30	nA
INPUT NOISE VOLTAGE DENSITY	e_n	$f_O = 10\text{ Hz}$ $f_O = 100\text{ Hz}$		50		$\text{nV}/\sqrt{\text{Hz}}$
				50		$\text{nV}/\sqrt{\text{Hz}}$
INPUT NOISE CURRENT DENSITY	i_n	$f_O = 10\text{ Hz}$ $f_O = 100\text{ Hz}$		0.12		$\text{pA}/\sqrt{\text{Hz}}$
				0.12		$\text{pA}/\sqrt{\text{Hz}}$
INPUT VOLTAGE RANGE	IVR	$V_+ = 5\text{ V}$, $V_- = 0\text{ V}$ $V_S = \pm 15\text{ V}$	0/3.5			V
			-15/13.5			V
COMMON-MODE REJECTION RATIO	CMRR	$V_+ = 5\text{ V}$, $V_- = 0\text{ V}$ $0\text{ V} \leq V_{CM} \leq 3.5\text{ V}$ $V_S = \pm 15\text{ V}$ $-15\text{ V} \leq V_{CM} \leq 13.5\text{ V}$	80	96		dB
			80	96		dB
POWER SUPPLY REJECTION RATIO	PSRR	$V_S = \pm 2.5\text{ V to } \pm 15\text{ V}$, $V_- = 0\text{ V}$, $V_+ = 5\text{ V to } 30\text{ V}$		20	50	$\mu\text{V}/\text{V}$
LARGE SIGNAL VOLTAGE GAIN	A_{VO}	$R_L = 25\text{ k}\Omega$, $V_O = \pm 10\text{ V}$	400	900		V/mV
SLEW RATE	SR			0.05		V/ μs
CLOSED-LOOP BANDWIDTH	BW	$A_{VCL} = 1.0$ $R_L = 10\text{ k}\Omega$		150		kHz
				150		kHz
OUTPUT VOLTAGE SWING	V_O	$V_+ = 5\text{ V}$, $V_- = 0\text{ V}$, $R_L = 10\text{ k}\Omega$ $V_S = \pm 15\text{ V}$ $R_L = 25\text{ k}\Omega$	0.8/4.0			V
			± 14.0			V
SUPPLY CURRENT (Four Amplifiers)	I_{SY}	$V_S = \pm 2.5\text{ V}$, No Load $V_S = \pm 15\text{ V}$, No Load	—	170	300	μA
				360	460	μA

NOTE

* I_{OS} and I_B are measured at $V_{CM} = 0^\circ$.

Specifications subject to change without notice.

ELECTRICAL CHARACTERISTICS ($V_S = \pm 15\text{ V}$, $-55^\circ\text{C} \leq +125^\circ\text{C}$ for OP420C, $-40^\circ\text{C} \leq T_A \leq +85^\circ\text{C}$ for OP420G, unless otherwise noted.)

Parameter	Symbol	Conditions	OP420C/OP420G			Unit
			Min	Typ	Max	
AVERAGE INPUT OFFSET Voltage Drift ¹	TCV _{OS}	Unnullled		8	15	μV/°C
INPUT OFFSET VOLTAGE	V _{OS}	V _S = ±2.5 V to ±15 V			5.5	mV
INPUT OFFSET CURRENT ²	I _{OS}	V _S = ±2.5 V to ±15 V			4	nA
INPUT BIAS CURRENT ²	I _B	V _S = ±2.5 V to ±15 V			40	nA
INPUT VOLTAGE RANGE	IVR	V ₊ = 5 V, V ₋ = 0 V V _S = ±15 V	0/3.2 -15/13.2			V V
COMMON-MODE Rejection Ratio	CMRR	V ₊ = 5 V, V ₋ = 0 V, 0 V ≤ V _{CM} ≤ 3.2 V V _S = ±15 V -15 V ≤ V _{CM} ≤ 13.2 V	73	92		dB
			73	92		dB
POWER SUPPLY Rejection Ratio	PSRR	V _S = ±2.5 V to ±15 V, V ₋ = 0 V, V ₊ = 5 V to 30 V		25	80	μV/V
LARGE-SIGNAL VOLTAGE GAIN	A _{VO}	V _S = ±15 V, R _L = 50 kΩ, V _O = 10 V	200	650		V/mV
OUTPUT VOLTAGE SWING	V _O	V ₊ = 5 V, V ₋ = 0 V, R _L = 20 kΩ V _S = ±15 V, R _L = 50 kΩ	1.0/3.8			V
			±13.8			V
SUPPLY CURRENT (Four Amplifiers)	I _{SY}	V _S = ±2.5 V, No Load V _S = ±15 V, No Load		210	400	μA
				420	640	μA

NOTES

¹Sample tested.

²I_{OS} and I_B are measured at V_{CM} = 0°.

OP420

ABSOLUTE MAXIMUM RATINGS¹

Supply Voltage	±18 V
Differential Input Voltage	±30 V
Input Voltage	Supply Voltage
Output Short-Circuit Duration	Continuous
	(One Amplifier Only)
Storage Temperature Range	-65°C to +150°C
Lead Temperature Range (Soldering, 60 sec)	300°C
Operating Temperature Range	
OP420CY, OP420CRC	-55°C to +125°C
OP420G	-40°C to +85°C
Junction Temperature (T _J)	-65°C to +150°C

Package Type	θ_{JA} ²	θ_{JC}	Unit
14-Pin Hermetic DIP (Y)	99	12	°C/W
14-Pin Plastic DIP (P)	76	33	°C/W
16-Pin SOL (S)	92	27	°C/W

NOTES

¹Absolute Maximum Ratings apply to packaged parts, unless otherwise noted.

² θ_{JA} is specified for worst-case mounting conditions, i.e., θ_{JA} is specified for device in socket for CerDIP and P-DIP packages; θ_{JA} is specified for device soldered to printed circuit board for SOL package.

ORDERING GUIDE

T _A = 25°C V _{OS} Max (mV)	Package Options			Operating Temperature Range
	Cer DIP 14-Pin	LCC 20-Contact	Plastic	
4.0	OP420CY*	OP420CRC/883		MIL
4.0			OP420GP*	XIND
4.0			OP420GS*	XIND

*Not for new design; obsolete April 2002.

CAUTION

ESD (electrostatic discharge) sensitive device. Electrostatic charges as high as 4000 V readily accumulate on the human body and test equipment and can discharge without detection. Although the OP420 features proprietary ESD protection circuitry, permanent damage may occur on devices subjected to high-energy electrostatic discharges. Therefore, proper ESD precautions are recommended to avoid performance degradation or loss of functionality.



Typical Performance Characteristics—OP420

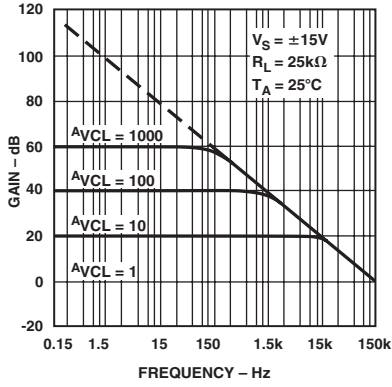

TPC 1. Closed-Loop Gain vs. Frequency

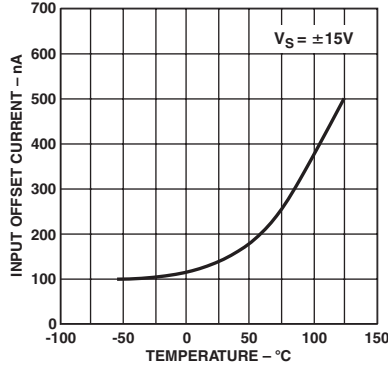

TPC 2. Input Offset Current vs. Temperature

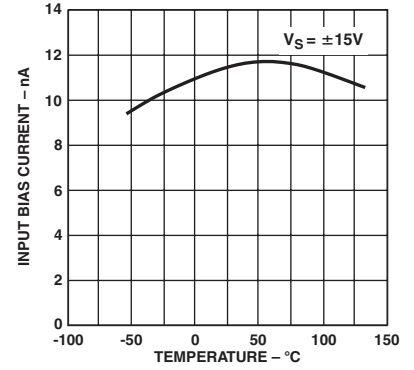

TPC 3. Input Bias Current vs. Temperature

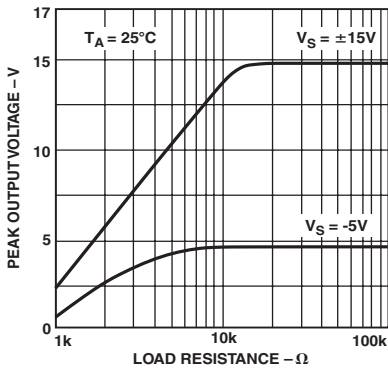

TPC 4. Maximum Output Voltage vs. Load Resistance

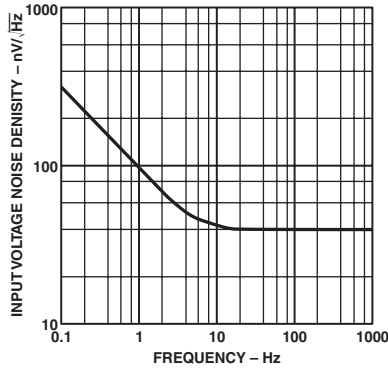

TPC 5. Input Voltage Noise Density (e_n) vs. Frequency

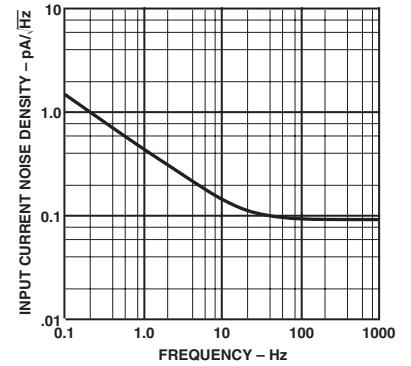

TPC 6. Input Current Noise Density (i_n) vs. Frequency

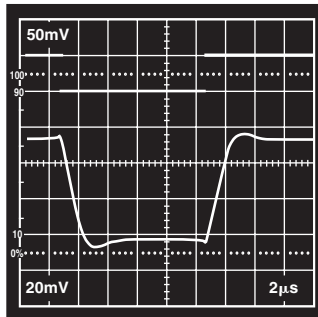

TPC 7. Small-Signal Transient Response

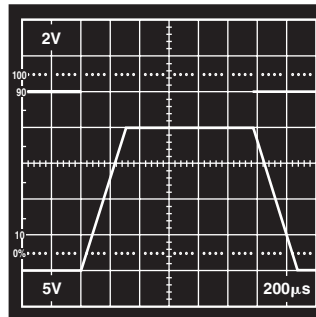

TPC 8. Large-Signal Transient Response

OP420

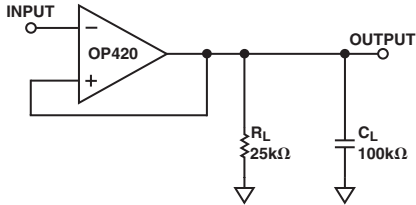

Figure 2. Small-Signal Transient Response

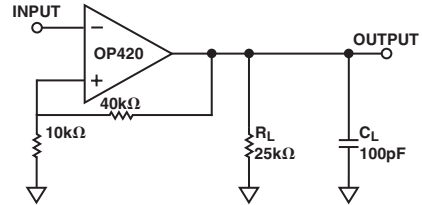
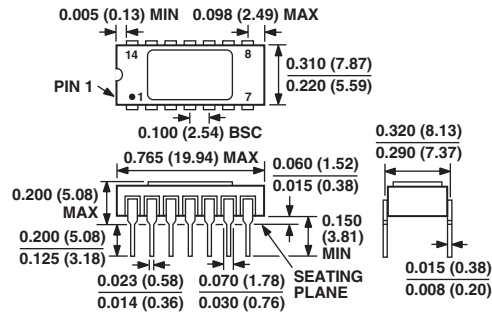

Figure 3. Large-Signal Transient Response

OUTLINE DIMENSIONS

Dimensions shown in inches and (mm).

14-PIN HERMETIC DIP 14-PIN EPOXY DIP



16-PIN SOL

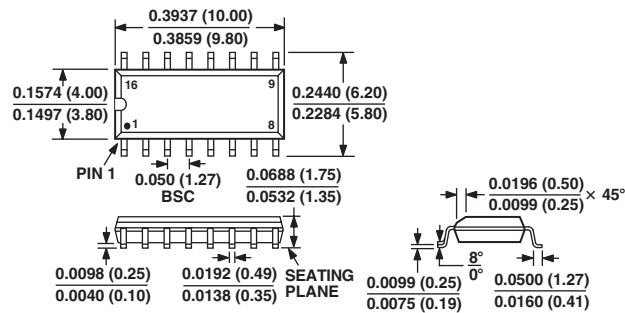

OP420CRC/883 20-LEAD LCC

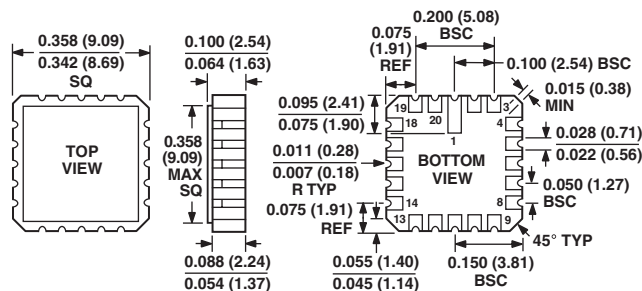

Revision History

Location	Page
11/01—Data Sheet changed from REV. 0 to REV. A.	
Edits to GENERAL DESCRIPTION	1
Edits to ELECTRICAL CHARACTERISTICS	2, 3
Edits to ORDERING INFORMATION	4
Edits to ABSOLUTE MAXIMUM RATINGS	4
Deleted DICE CHARACTERISTICS	4
Deleted WAFER TEST LIMITS	4

