

Precision Monolithics Inc.

FEATURES

- Two Independent Comparators
- Operates from a Single 5V Supply
- Response Time 80ns Typ at $\pm 15V$
- High Output Drive Current 25mA
- Pin for Pin Replacement for LM119 with Improved Electrical Specifications
 - Input Offset Voltage 2.5mV Max
 - Input Offset Current 50nA Max
 - Voltage Gain 100V/mV Min
 - Positive Supply Current 10mA Max
 - Negative Supply Current 4mA Max
- Minimum Fan Out of 2 Each Side
- Inputs and Outputs Isolated from System Ground
- Available in Die Form

ORDERING INFORMATION†

V _{OS} MAX (mV)	PACKAGE		OPERATING TEMPERATURE RANGE
	CERDIP 14-PIN	SO 14-PIN	
2.5	PM119Y*	—	MIL
2.5	PM219Y	—	IND
2.5	—	PM219P	XIND

* For devices processed in total compliance to MIL-STD-883, add /883 after part number. Consult factory for 883 data sheet.

† Burn-in is available on commercial and industrial temperature range parts in CerDIP, plastic DIP, and TO-can packages. For ordering information, see 1990/91 Data Book, Section 2.

PIN CONNECTIONS

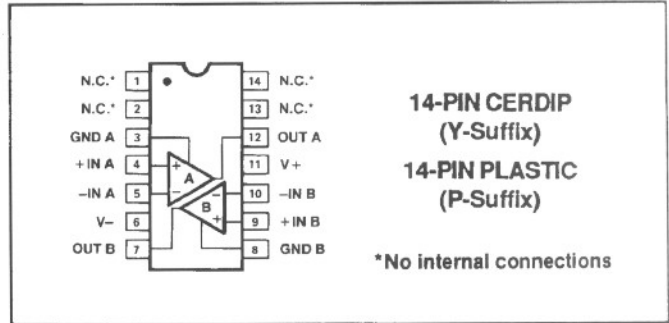

GENERAL DESCRIPTION

The PM-119/PM-219 is PMI's improved version of the industry-standard LM119 series dual high-speed voltage comparator (see Features section). It is designed to operate from a single +5V supply up to $\pm 15V$ dual supplies. Open-collector outputs are provided for logic interface flexibility allowing output swings of up to +35V. High output drive capability facilitates RTL, DTL, and TTL interfacing, as well as relay and lamp driving at currents up to 25mA. Typical response time of 80ns with $\pm 15V$ power supplies makes the PM-119/PM-219 ideal for application in fast A/D converters, level shifters, oscillators, and multivibrators.

SIMPLIFIED SCHEMATIC

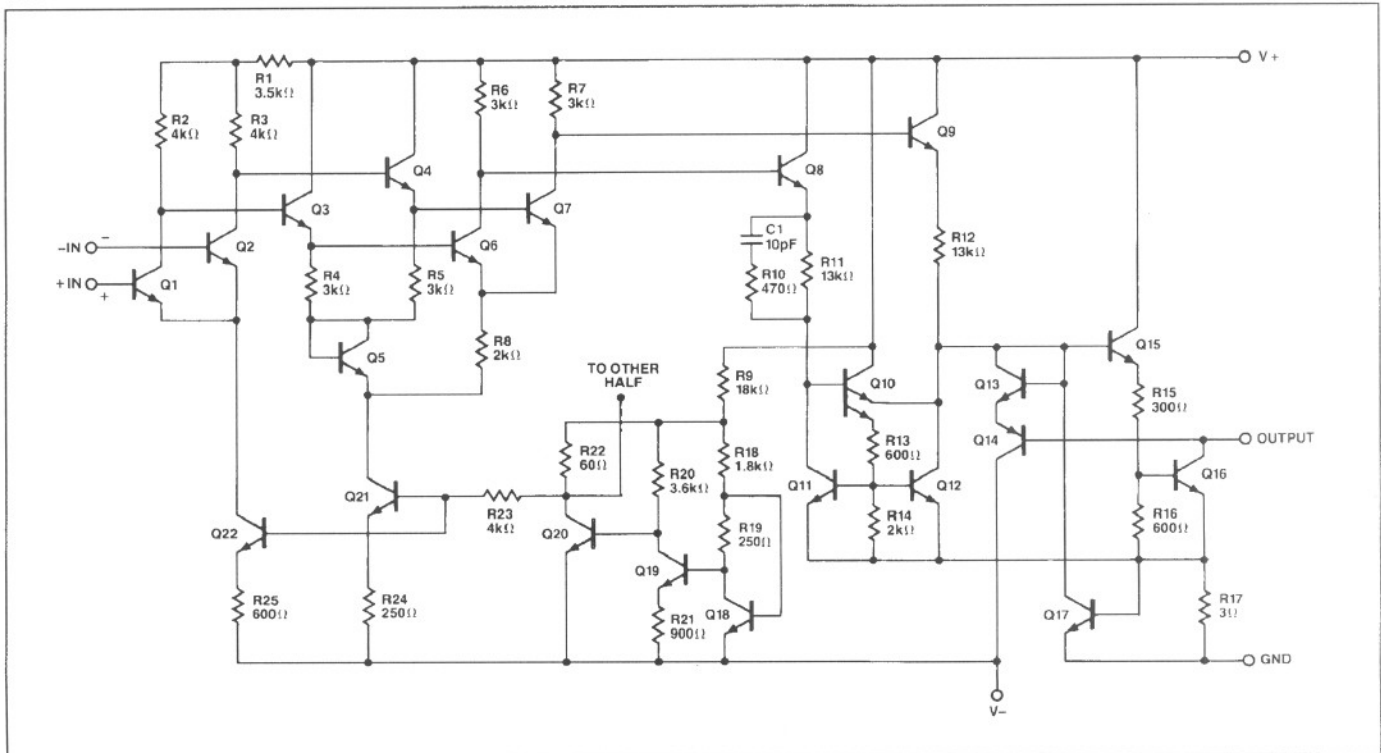

ABSOLUTE MAXIMUM RATINGS

Total Supply Voltage	36V
Out to Negative Supply Voltage	36V
Ground to Negative Supply Voltage	25V
Ground to Positive Supply Voltage	18V
Differential Input Voltage	±5V
Input Voltage (Note 1)	±15V
Output Short Circuit Duration	10 sec
Operating Temperature Range	
PM-119	-55°C to +125°C
PM-219Y	-25°C to +85°C
PM-219P	-40°C to +85°C

Junction Temperature	+150°C
Storage Temperature Range	-65°C to +150°C
Lead Temperature (Soldering, 60 sec)	300°C

PACKAGE TYPE	θ_{JA} (Note 2)	θ_{JC}	UNITS
14-Pin Hermetic DIP (Z)	108	16	°C/W
14-Pin Plastic DIP (P)	83	39	°C/W

NOTES:

- For supply voltages less than ±15V, the absolute maximum input voltage is equal to the supply voltage.
- θ_{JA} is specified for worst case mounting conditions, i.e., θ_{JA} is specified for device in socket for CerDIP and P-DIP packages.

ELECTRICAL CHARACTERISTICS at $V_S = \pm 15V$, ground pins at ground and $T_A = 25^\circ C$, unless otherwise noted.

PARAMETER	SYMBOL	CONDITIONS	PM-119/PM-219			UNITS
			MIN	TYP	MAX	
Input Offset Voltage	V_{OS}	$R_S \leq 5k\Omega$	—	0.2	2.5	mV
Input Offset Current	I_{OS}	(Note 1)	—	10	50	nA
Input Bias Current	I_B	(Note 1)	—	280	500	nA
Voltage Gain	A_{VO}		100	1000	—	V/mV
Response Time	t_r	(Note 2)	—	80	—	ns
Saturation Voltage	V_{SAT}	$V_{IN} \leq -5mV, I_{OUT} = 25mA$	—	0.6	1.2	V
Saturation Voltage	V_{SAT}	$V+ \geq 4.5V, V- = 0$ $V_{IN} \leq -6mV, I_{SINK} \leq 3.2mA$	—	0.23	0.4	V
Output Leakage Current	I_{CEX}	$V_{IN} \geq 5mV, V_{OUT} = 35V$	—	0.1	2.0	μA
Positive Supply Current	I_S^+		—	7.0	10.0	mA
Negative Supply Current	I_S^-		—	3.0	4.0	mA
Positive Supply Current	I_S^+	$V+ = 5V, V- = 0$	—	3.5	—	mA
Input Voltage Range	IVR		-12	±13	+12	V

NOTES:

- The offset voltages and offset currents given are the maximum values required to drive the output within a volt of either supply with a 1mA load. Thus, these parameters define an error band and take into account the worst case effects of voltage gain and input impedance.
- The response time specified is for a 100mV input step with 5mV overdrive.

ELECTRICAL CHARACTERISTICS at $V_S = \pm 15V$, ground pins at ground and $-55^\circ C \leq T_A \leq +125^\circ C$, unless otherwise noted.

PARAMETER	SYMBOL	CONDITIONS	PM-119			UNITS
			MIN	TYP	MAX	
Input Offset Voltage	V_{OS}	$R_S \leq 5k\Omega$	—	2.0	5.0	mV
Input Offset Current	I_{OS}	(Note 1)	—	20	100	nA
Input Bias Current	I_B	(Note 1)	—	400	1000	nA
Positive Supply Current	I_S^+		—	8.0	11.5	mA
Negative Supply Current	I_S^-		—	3.0	4.5	mA
Positive Supply Current	I_S^+	$V+ = 5V, V- = 0$	—	3.5	—	mA
Saturation Voltage	V_{SAT}	$V+ \geq 4.5V, V- = 0$ $V_{IN} \leq -6mV, I_{SINK} \leq 3.2mA$	—	0.3	0.6	V
Differential Input Voltage			—	—	± 5	V
Output Leakage Current	I_{CEX}	$V_{IN} \geq 5mV, V_{OUT} = 35V$	—	1.5	10.0	μA

NOTE:

The offset voltages and offset currents given are the maximum values required to drive the output within a volt of either supply with a 1mA load. Thus, these parameters define an error band and take into account the worst case effects of voltage gain and input impedance.

ELECTRICAL CHARACTERISTICS at $V_S = \pm 15V$, ground pins at ground and $-25^\circ C \leq T_A \leq +85^\circ C$ for PM-219Y; $-40^\circ C \leq T_A \leq +85^\circ C$ for PM-219P, unless otherwise noted.

PARAMETER	SYMBOL	CONDITIONS	PM-219			UNITS
			MIN	TYP	MAX	
Input Offset Voltage	V_{OS}	$R_S \leq 5k\Omega$	—	0.5	5.0	mV
Input Offset Current	I_{OS}	(Note 1)	—	15	100	nA
Input Bias Current	I_B	(Note 1)	—	350	1000	nA
Positive Supply Current	I_S^+		—	8.0	11.5	mA
Negative Supply Current	I_S^-		—	3.0	4.5	mA
Positive Supply Current	I_S^+	$V+ = 5V, V- = 0$	—	3.5	—	mA
Saturation Voltage	V_{SAT}	$V+ \geq 4.5V, V- = 0$ $V_{IN} \leq -6mV, I_{SINK} \leq 3.2mA$	—	0.3	0.6	V
Differential Input Voltage			—	—	± 5	V
Output Leakage Current	I_{CEX}	$V_{IN} \geq 5mV, V_{OUT} = 35V$	—	0.2	10.0	μA

NOTE:

1. The offset voltages and offset currents given are the maximum values required to drive the output within a volt of either supply with a 1mA load. Thus, these parameters define an error band and take into account the worst case effects of voltage gain and input impedance.

DICE CHARACTERISTICS

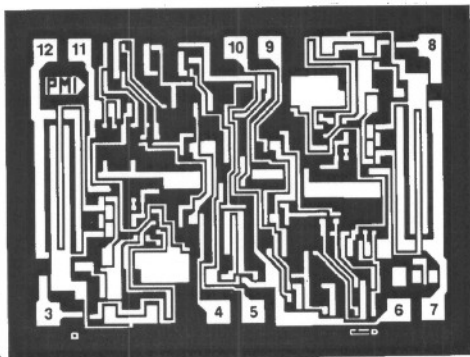

DIE SIZE 0.079 × 0.059 inch, 4661 sq. mils
(1.98 × 1.48 mm, 2.93 sq. mm)

- | | |
|-------------------|--------------------|
| 1. N.C.* | 8. GND B |
| 2. N.C.* | 9. + INPUT B |
| 3. GND A | 10. - INPUT B |
| 4. + INPUT A | 11. V ⁺ |
| 5. - INPUT A | 12. OUTPUT A |
| 6. V ⁻ | 13. N.C.* |
| 7. OUTPUT B | 14. N.C.* |

*No internal connection

For additional DICE ordering information,
refer to 1990/91 Data Book, Section 2.

WAFER TEST LIMITS at $V_S = \pm 15V$, ground pins at ground and $T_A = 25^\circ C$, unless otherwise noted.

PARAMETER	SYMBOL	CONDITIONS	PM-119GBC LIMIT	PM-119GTBC LIMIT	UNITS
Input Offset Voltage	V_{OS}	$R_S \leq 6k\Omega$	5.0	5.0	mV MAX
Input Offset Current	I_{OS}	(Note 1)	100	100	nA MAX
Input Bias Current	I_B	(Note 1)	1000	1000	nA MAX
Saturation Voltage	V_{SAT}	$V_{IN} \leq -5mV, I_{OUT} = 25mA$	1.2		V MAX
Saturation Voltage		$V^+ \geq 4.5V, V^- = 0$ $V_{IN} \leq -6mV, I_{SINK} \leq 3.2mA$	0.4	0.6	V MAX
Output Leakage Current	I_{CEX}	$V_{IN} \geq 5mV, V_{OUT} = 35V$	2.0	10.0	μA MAX
Positive Supply Current	I_S^+		11.5	11.5	mA MAX
Negative Supply Current	I_S^-		4.5	4.5	mA MAX

NOTES:

- The offset voltages and offset currents given are the maximum values required to drive the output within a volt of either supply with a 1mA load. Thus, these parameters define an error band and take into account the worst case effects of voltage gain and input impedance. Electrical tests are performed at wafer probe to the limits shown. Due to variations in assembly methods and normal yield loss, yield after packaging is not guaranteed for standard product dice. Consult factory to negotiate specifications based on dice lot qualification through sample lot assembly and testing.

TYPICAL PERFORMANCE CHARACTERISTICS

INPUT CHARACTERISTICS

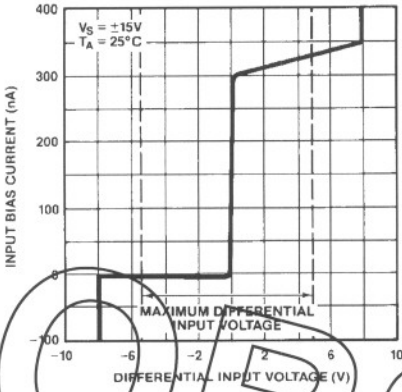

COMMON-MODE LIMITS vs TEMPERATURE

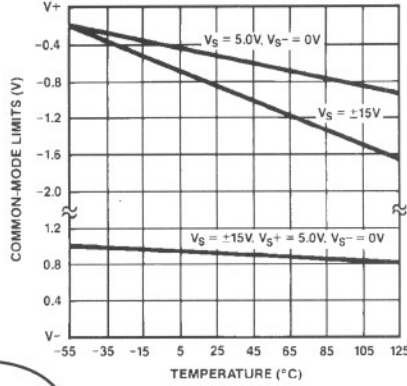

TRANSFER FUNCTION

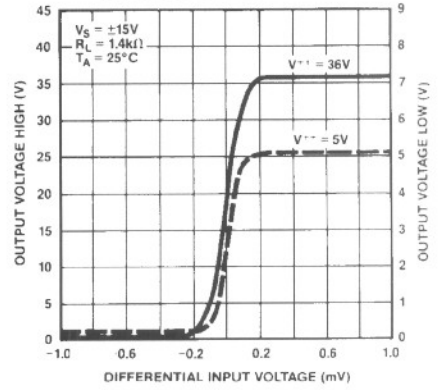

INPUT CURRENTS vs TEMPERATURE

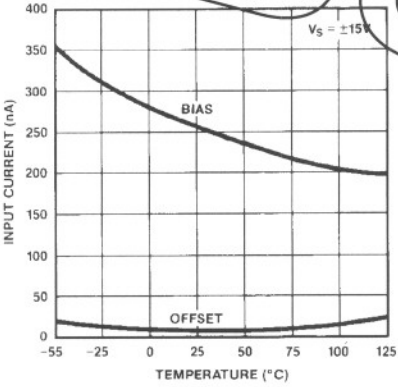

SUPPLY CURRENTS vs TEMPERATURE

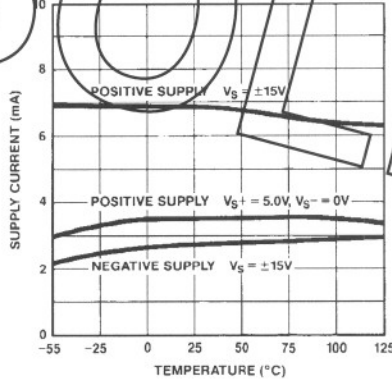

SUPPLY CURRENTS vs SUPPLY VOLTAGE

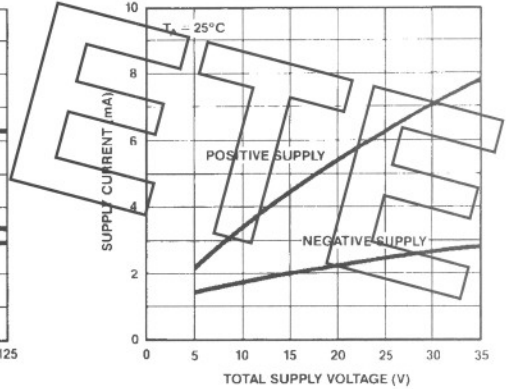

INPUT OFFSET VOLTAGE vs TEMPERATURE

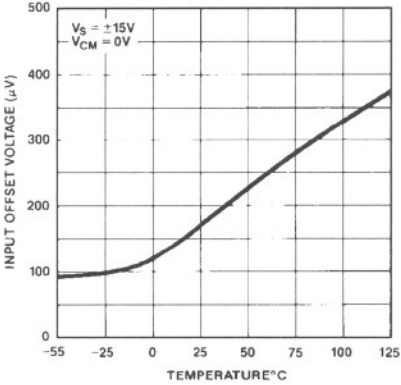

OUTPUT SATURATION VOLTAGE vs OUTPUT CURRENT

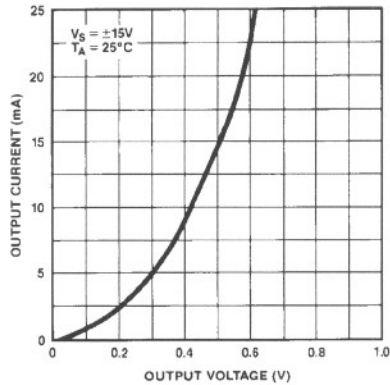

RESPONSE TIMES FOR VARIOUS INPUT OVERDRIVES

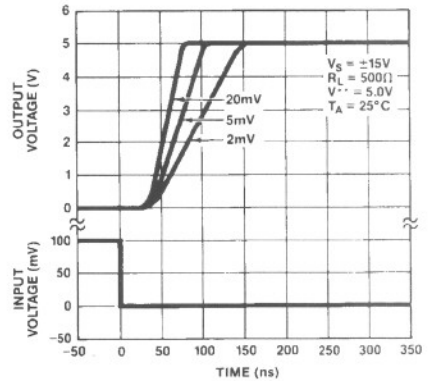

TYPICAL PERFORMANCE CHARACTERISTICS

RESPONSE TIMES FOR VARIOUS INPUT OVERDRIVES

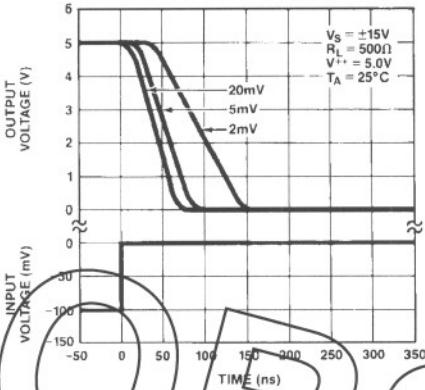

RESPONSE TIMES FOR VARIOUS INPUT OVERDRIVES

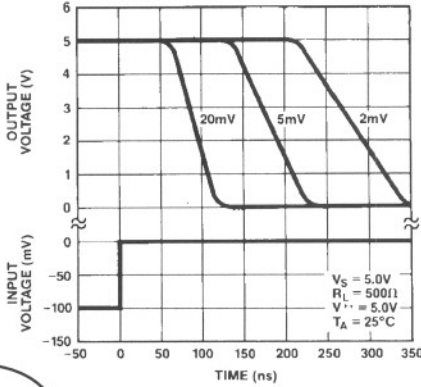

RESPONSE TIMES FOR VARIOUS INPUT OVERDRIVES

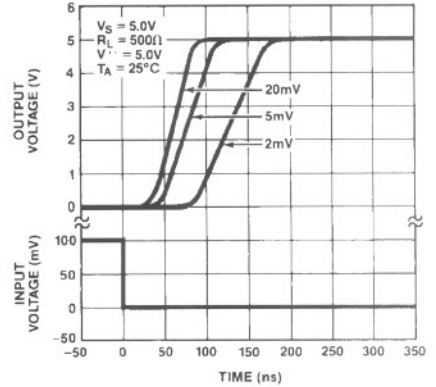

BURN-IN CIRCUIT

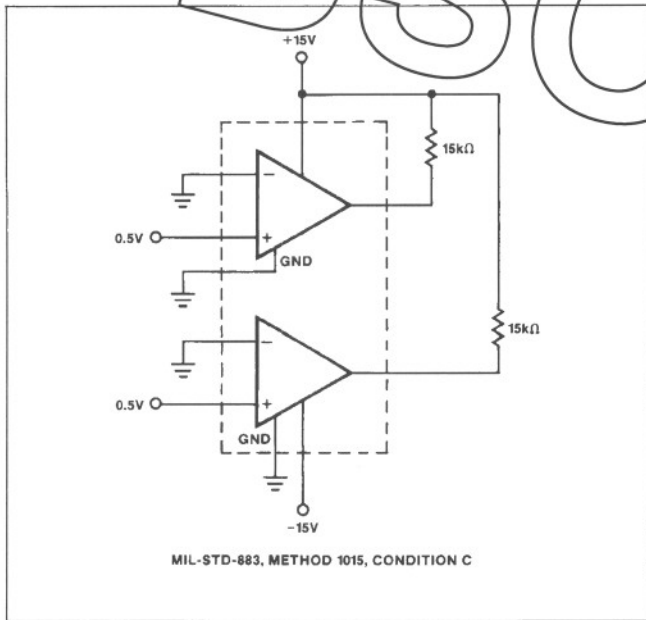

SOLETE

DICE CHARACTERISTICS

