



Total Ionizing Dose (TID) Radiation Testing of the RH1085MK Low Dropout Positive Adjustable Regulator for Linear Technology

Customer: Linear Technology, PO# 55339L

RAD Job Number: 10-118

Part Type Tested: Linear Technology RH1085MK Low Dropout Positive Adjustable Regulator

Commercial Part Number: RH1085MK

Traceability Information: Fab lot# W0942038.1, Wafer# 4, Assembly lot# 550635.1. Information obtained from Linear Technology PO#55339L. Date code marking on the package is 0945A, see Appendix A for a photograph of the device and part markings.

Quantity of Units: 12 units total, 5 units for biased irradiation, 5 units for unbiased irradiation and 2 control units. Serial numbers 35 to 39 were biased during irradiation. Serial numbers 75 to 79 were unbiased during irradiation (all pins tied to ground). Serial numbers 142 and 143 were used as the controls. See Appendix B for the radiation bias connection table.

Pre-Irradiation Burn-In: Burn-In performed by Linear Technology prior to receipt by RAD.

TID Dose Rate and Test Increments: 50-300rad(Si)/s with readings at pre-irradiation, 10, 20, 30, and 50 krad(Si).

TID Overtest and Post-Irradiation Anneal: No overtest. 24-hour room temperature anneal followed by a 168-hour 100°C anneal. Both anneals shall be performed in the same electrical bias condition as the irradiations. Electrical measurements shall be made following each anneal increment.

TID Test Standard: MIL-STD-883H, Method 1019.8, Condition A

TID Electrical Test Conditions: Pre-irradiation, and within one hour following each radiation exposure.

Test Hardware: LTS2020 Tester, 2101 Family Board, 0606 Fixture and RH1085 BGSS-000829 DUT Board

Facility and Radiation Source: Radiation Assured Devices Longmire Laboratories, Colorado Springs, CO using the JLSA 81-24 high dose rate Co60 source. Dosimetry performed by CaF₂ TLDs traceable to NIST. RAD's dosimetry has been audited by DSCC and RAD has been awarded Laboratory Suitability for MIL-STD-750 TM 1019.5.

Irradiation and Test Temperature: Ambient room temperature for irradiation and test controlled to 24°C±6°C per MIL-STD-883.

High Dose Rate Test Result: Units exhibited only minor degradation to the V_{OUT} parameters and no significant degradation to any other measured parameter. Further, the units do not exhibit ELDRS as defined in the current test method.



1.0. Overview and Background

It is well known that total dose ionizing radiation can cause parametric degradation and ultimately functional failure in electronic devices. The damage occurs via electron-hole pair production, transport and trapping in the dielectric and interface regions. In discrete devices the bulk of the damage is frequently manifested as a reduction in the gain and/or breakdown voltage of the device. The damage will usually anneal with time following the end of the radiation exposure. Due to this annealing, and to ensure a worst-case test condition MIL-STD-883 TM1019.8 calls out a dose rate of 50 to 300rad(Si)/s as Condition A and further specifies that the time from the end of an incremental radiation exposure and electrical testing shall be 1-hour or less and the total time from the end of one incremental irradiation to the beginning of the next incremental radiation step should be 2-hours or less. The work described in this report was performed to meet MIL-STD-883 TM1019.8 Condition A.

2.0. Radiation Test Apparatus

The total ionizing dose testing described in this final report was performed using the facilities at Radiation Assured Devices' Longmire Laboratories in Colorado Springs, CO. The high dose rate total ionizing dose (TID) source is a JLSA 84-21 irradiator modified to provide a panoramic exposure. The Co-60 rods are held in the base of the irradiator heavily shielded by lead, during the radiation exposures the rod is raised by an electronic timer/controller and the exposure is performed in air. The dose rate for this irradiator in this configuration ranges from <1rad(Si)/s to a maximum of approximately 120rad(Si)/s, determined by the distance from the source. For high-dose rate experiments the bias boards are placed in a radial fashion equidistant from the raised Co-60 rods with the distance adjusted to provide the required dose rate. The irradiator calibration is maintained by Radiation Assured Devices Longmire Laboratories using thermoluminescent dosimeters (TLDs) traceable to the National Institute of Standards and Technology (NIST). Figure 2.1 shows a photograph of the JLSA 81-24 Co-60 irradiator at RAD's Longmire Laboratory facility.

RAD is currently certified by the Defense Supply Center Columbus (DSCC) for Laboratory Suitability to Test Method 1019 under MIL-STD-750 and MIL-STD-883. Additional details regarding Radiation Assured Devices dosimetry for TM1019 Condition A testing are available in RAD's report to DSCC entitled: "Dose Rate Mapping of the J.L. Shepherd and Associates Model 81 Irradiator Installed by Radiation Assured Devices"



Figure 2.1. Radiation Assured Devices' high dose rate Co-60 irradiator. The dose rate is obtained by positioning the device-under-test at a fixed distance from the gamma cell. The dose rate for this irradiator varies from approximately 120rad(Si)/s close to the rods down to 1rad(Si)/s at a distance of approximately 2-feet.



3.0. Radiation Test Conditions

The RH1085MK Low Dropout Positive Adjustable Regulator described in this final report was irradiated under 2 different conditions, one when biased with a single sided 30V supply, and one when unbiased with all pins tied to ground. See Appendix B for details on the biasing conditions during radiation exposure. In our opinion, these bias circuits satisfy the requirements of MIL-STD-883H TM1019.8 Section 3.9.3 Bias and Loading Conditions which states “The bias applied to the test devices shall be selected to produce the greatest radiation induced damage or the worst-case damage for the intended application, if known. While maximum voltage is often worst case some bipolar linear device parameters (e.g. input bias current or maximum output load current) exhibit more degradation with 0 V bias.”

The devices were irradiated to a maximum total ionizing dose level of 50krad(Si) with incremental readings at 10, 20, 30 and 50krad(Si). Electrical testing occurred within one hour following the end of each irradiation segment. For intermediate irradiations, the units were tested and returned to total dose exposure within two hours from the end of the previous radiation increment. The TID bias board was positioned in the Co-60 cell to provide the required minimum of 50rad(Si)/s and was located inside a lead-aluminum enclosure. The lead-aluminum enclosure is required under MIL-STD-883H TM1019.8 Section 3.4 that reads as follows: “Lead/Aluminum (Pb/Al) container. Test specimens shall be enclosed in a Pb/Al container to minimize dose enhancement effects caused by low-energy, scattered radiation. A minimum of 1.5 mm Pb, surrounding an inner shield of at least 0.7 mm Al, is required. This Pb/Al container produces an approximate charged particle equilibrium for Si and for TLDs such as CaF₂. The radiation field intensity shall be measured inside the Pb/Al container (1) initially, (2) when the source is changed, or (3) when the orientation or configuration of the source, container, or test-fixture is changed. This measurement shall be performed by placing a dosimeter (e.g., a TLD) in the device-irradiation container at the approximate test-device position. If it can be demonstrated that low energy scattered radiation is small enough that it will not cause dosimetry errors due to dose enhancement, the Pb/Al container may be omitted”.

The final dose rate within the lead-aluminum box was determined based on TLD dosimetry measurements just prior to the beginning of the total dose irradiations. The final dose rate for this work was 66.5rad(Si)/s with a precision of $\pm 5\%$.

4.0. Tested Parameters

The following parameters were tested during the course of this work:

1. Reference Voltage 1 (V)
2. Reference Voltage 2 (V)
3. Reference Voltage 3 (V)
4. Reference Voltage 4 (V)
5. Reference Voltage 5 (V)



6. Reference Voltage 6 (V)
7. Line Regulation 1 (%)
8. Line Regulation 2 (%)
9. Load Regulation (%)
10. Adj. Pin Current 1 (A)
11. Adj. Pin Current 2 (A)
12. Adj. Pin Current 3 (A)
13. Adj. Pin Current 4 (A)
14. Adj. Pin Current Change vs. Load 1 (A)
15. Adj. Pin Current Change vs. Load 2 (A)
16. Adj. Pin Current Change vs. Line (A)
17. Minimum Load Current (A)
18. Current Limit 1 (A)
19. Current Limit 2 (A)
20. Dropout Voltage (V)

Appendix C details the measured parameters, test conditions, pre-irradiation specification and measurement resolution for each of the measurements.

The parametric data was obtained as “read and record” and all the raw data plus an attributes summary are contained in this report as well as in a separate Excel file. The attributes data contains the average, standard deviation and the average with the KTL values applied. The KTL values used is 2.742 per MIL HDBK 814 using one sided tolerance limits of 90/90 and a 5-piece sample size. This survival probability/level of confidence is consistent with a 22-piece sample size and zero failures analyzed using a lot tolerance percent defective (LTPD) approach. Note that the following criteria must be met for a device to pass the low dose rate test: following the radiation exposure each of the 5 pieces irradiated under electrical bias shall pass the specification value. The units irradiated without electrical bias and the KTL statistics are included in this report for reference only. If any of the 5 pieces irradiated under electrical bias exceed the datasheet specifications, then the lot could be logged as a failure.

Further, MIL-STD-883H, TM 1019.8 Section 3.13.1.1 Characterization test to determine if a part exhibits ELDRS” states the following: Select a minimum random sample of 21 devices from a population representative of recent production runs. Smaller sample sizes may be used if agreed upon between the parties to the test. All of the selected devices shall have undergone appropriate elevated temperature reliability screens, e.g. burn-in and high temperature storage life. Divide the samples into four groups of 5 each and use the remaining part for a control. Perform pre-irradiation electrical characterization on all parts assuring that they meet the Group A electrical tests. Irradiate 5 samples under a 0 volt bias and another 5 under the irradiation bias given in the acquisition specification at 50-300 rad(Si)/s and room temperature. Irradiate 5 samples under a 0 volt bias and another 5 under irradiation bias given in the acquisition specification at < 10mrad(Si)/s and room temperature. Irradiate all samples to the same dose levels, including 0.5 and 1.0 times the anticipated specification dose, and



repeat the electrical characterization on each part at each dose level. Post irradiation electrical measurements shall be performed per paragraph 3.10 where the low dose rate test is considered Condition D. Calculate the radiation induced change in each electrical parameter (Δ para) for each sample at each radiation level. Calculate the ratio of the median Δ para at low dose rate to the median Δ para at high dose rate for each irradiation bias group at each total dose level. If this ratio exceeds 1.5 for any of the most sensitive parameters then the part is considered to be ELDRS susceptible. This test does not apply to parameters which exhibit changes that are within experimental error or whose values are below the pre-irradiation electrical specification limits at low dose rate at the specification dose.

Therefore, the data in this report can be analyzed along with the low dose rate report titled “Enhanced Low Dose Rate Sensitivity (ELDRS) Testing of the RH1085MK Low Dropout Positive Adjustable Regulator for Linear Technology” to demonstrate that these parts do not exhibit ELDRS as defined in the current test method.

5.0. Total Ionizing Dose Test Results

Using the conditions stated above, the RH1085MK Low Dropout Positive Adjustable Regulator (from the lot date code identified on the first page of this test report) technically failed the total dose test at the 50krad(Si) dose level with only minor degradation to the V_{OUT} parameters. Note that the post-irradiation specification limits as defined by Linear Technology for both the maximum and minimum V_{OUT1} levels are reduced with increasing dose, keeping a somewhat constant maximum to minimum spread. For example, the maximum V_{OUT1} specification pre-irradiation is 1.262V and incrementally decreases to 1.253V at 50krad(Si). Therefore, if a particular lot of RH1085MK voltage regulators show little or no degradation to V_{OUT1} with total dose, it is likely to “fail” by exceeding the maximum post-irradiation specification. The remaining V_{OUT} parameters (V_{OUT2} - V_{OUT5}) use a slightly increased post-irradiation limit for the maximum voltage level, thus avoiding the “fail” observed on V_{OUT1} if little or no degradation is observed. Note that the data for the units-under-test irradiated in the unbiased condition and the KTL statistics presented in this report are for reference only and are not used for the determination of “PASS/FAIL” for the lot.

Figures 5.1 through 5.20 show plots of all the measured parameters versus total ionizing dose while Tables 5.1 – 5.20 show the corresponding raw data for each of these parameters. In these data plots the solid diamonds are the average of the measured data points for the sample irradiated under electrical bias while the shaded diamonds are the average of the measured data points for the units irradiated with all pins tied to ground. The black lines (solid or dashed) are the average of the data points after application of the KTL statistics on the sample irradiated in the biased condition while the shaded lines (solid or dashed) are the average of the data points after application of the KTL statistics on the sample irradiated in the unbiased condition. The red dotted line(s) are the pre- and/or post-irradiation minimum and/or maximum specification value as defined in the datasheet and/or test plan.



**TID Test Report
10-118 100824 R1.1**

**Radiation Assured Devices
5017 N. 30th Street
Colorado Springs, CO 80919
(719) 531-0800**

In addition to the radiation test results, the data plots and tables described above contain anneal data. The anneals are performed to better understand the underlying physical mechanisms responsible for radiation-induced parametric shifts and are not part of the criteria used to establish whether or not the lot passes or fails the low dose rate test. In all cases the parts either improved or exhibited no change during the anneal.

As seen clearly in these figures, the pre- and post-irradiation data are well within the specification even after application of the KTL statistics and the control units, as expected, show no significant changes to any of the parameters throughout the course of the measurements. Therefore we can conclude that the observed degradation was due to the radiation exposure and not drift in the test equipment.

Appendix D lists all of the charts and tables used in this section to facilitate the location of a specific parameter.

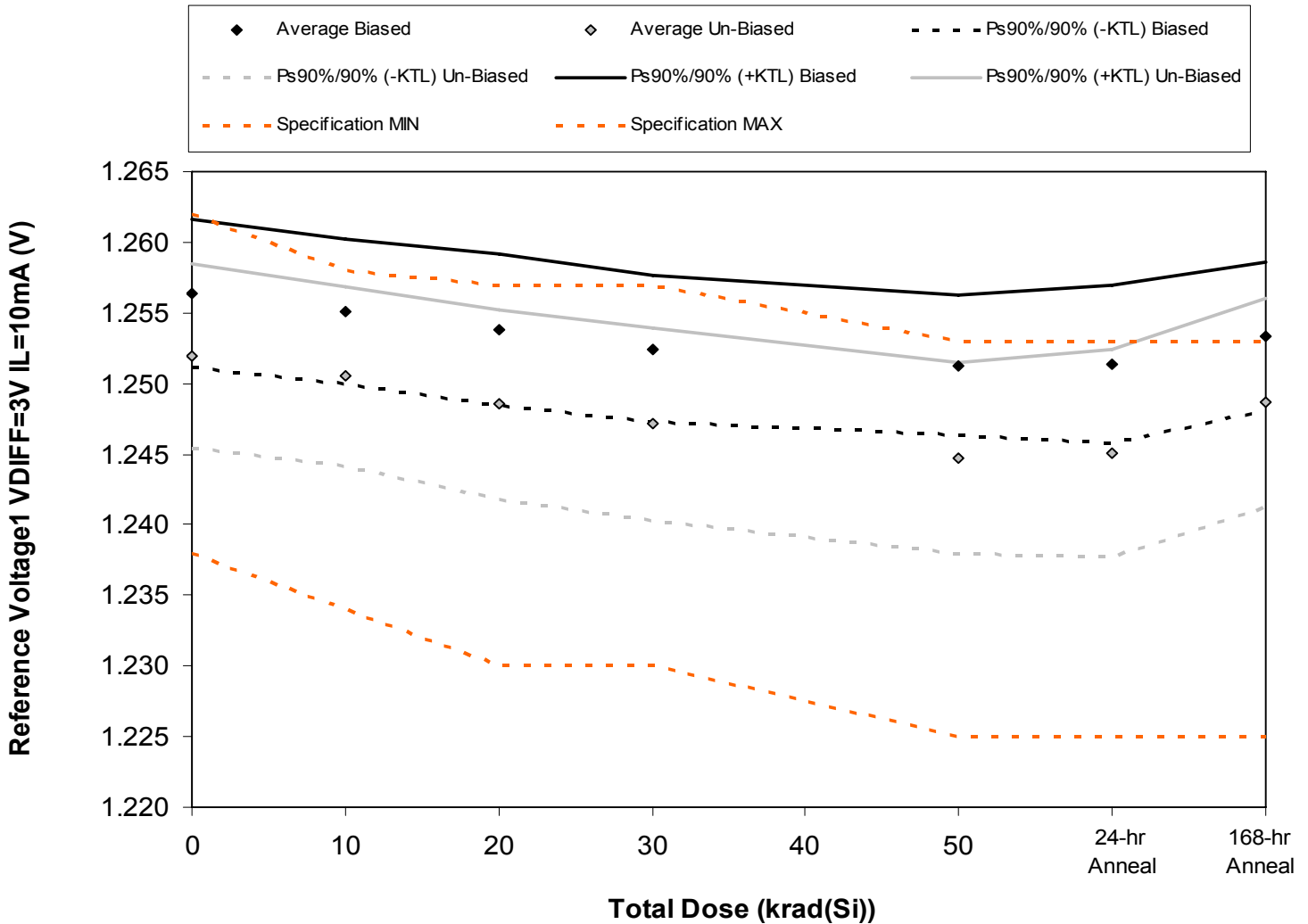

Figure 5.1. Plot of Reference Voltage1 VDIFF=3V IL=10mA (V) versus total dose. The solid diamonds are the average of the measured data points for the samples irradiated under electrical bias while the shaded diamonds are the average of the measured data points for the samples irradiated with all pins tied to ground. The black lines (solid and/or dashed) are the average of the data points after application of the KTL statistics on the samples irradiated under electrical bias while the gray lines (solid and/or dashed) are the average of the data points after application of the KTL statistics on the samples irradiated in the unbiased condition. The red dotted line(s) are the pre- and/or post-irradiation minimum and/or maximum specification value as defined in the datasheet and/or test plan.



**TID Test Report
10-118 100824 R1.1**

**Radiation Assured Devices
5017 N. 30th Street
Colorado Springs, CO 80919
(719) 531-0800**

Table 5.1. Raw data for Reference Voltage1 VDIFF=3V IL=10mA (V) versus total dose, including the statistical analysis, specification and the status of the testing (pass/fail).

Reference Voltage1 VDIFF=3V IL=10mA (V)	Total Dose (krad(Si))					24-hr Anneal	168-hr Anneal
	0	10	20	30	50		
Device	0	10	20	30	50		
35	1.2565	1.2550	1.2537	1.2524	1.2508	1.2506	1.2528
36	1.2580	1.2569	1.2557	1.2545	1.2533	1.2536	1.2554
37	1.2556	1.2541	1.2527	1.2514	1.2505	1.2507	1.2524
38	1.2582	1.2569	1.2557	1.2540	1.2529	1.2531	1.2551
39	1.2535	1.2525	1.2512	1.2499	1.2489	1.2486	1.2509
75	1.2523	1.2507	1.2488	1.2473	1.2450	1.2453	1.2490
76	1.2551	1.2534	1.2517	1.2503	1.2476	1.2483	1.2518
77	1.2513	1.2500	1.2481	1.2467	1.2443	1.2445	1.2478
78	1.2485	1.2470	1.2449	1.2434	1.2409	1.2410	1.2446
79	1.2526	1.2514	1.2492	1.2479	1.2459	1.2463	1.2501
142	1.2529	1.2535	1.2533	1.2534	1.2532	1.2533	1.2534
143	1.2520	1.2525	1.2522	1.2521	1.2521	1.2520	1.2522
Biased Statistics							
Average Biased	1.256	1.255	1.254	1.252	1.251	1.251	1.253
Std Dev Biased	1.93E-03	1.89E-03	1.95E-03	1.88E-03	1.82E-03	2.04E-03	1.90E-03
Ps90%/90% (+KTL) Biased	1.262	1.260	1.259	1.258	1.256	1.257	1.259
Ps90%/90% (-KTL) Biased	1.251	1.250	1.248	1.247	1.246	1.246	1.248
Un-Biased Statistics							
Average Un-Biased	1.252	1.251	1.249	1.247	1.245	1.245	1.249
Std Dev Un-Biased	2.39E-03	2.33E-03	2.45E-03	2.49E-03	2.48E-03	2.69E-03	2.71E-03
Ps90%/90% (+KTL) Un-Biased	1.259	1.257	1.255	1.254	1.252	1.252	1.256
Ps90%/90% (-KTL) Un-Biased	1.245	1.244	1.242	1.240	1.238	1.238	1.241
Specification MIN	1.2380	1.2340	1.2300	1.2300	1.2250	1.2250	1.2250
Status	PASS	PASS	PASS	PASS	PASS	N/A	N/A
Specification MAX	1.2620	1.2580	1.2570	1.2570	1.2530	1.2530	1.2530
Status	PASS	PASS	PASS	PASS	FAIL	N/A	N/A

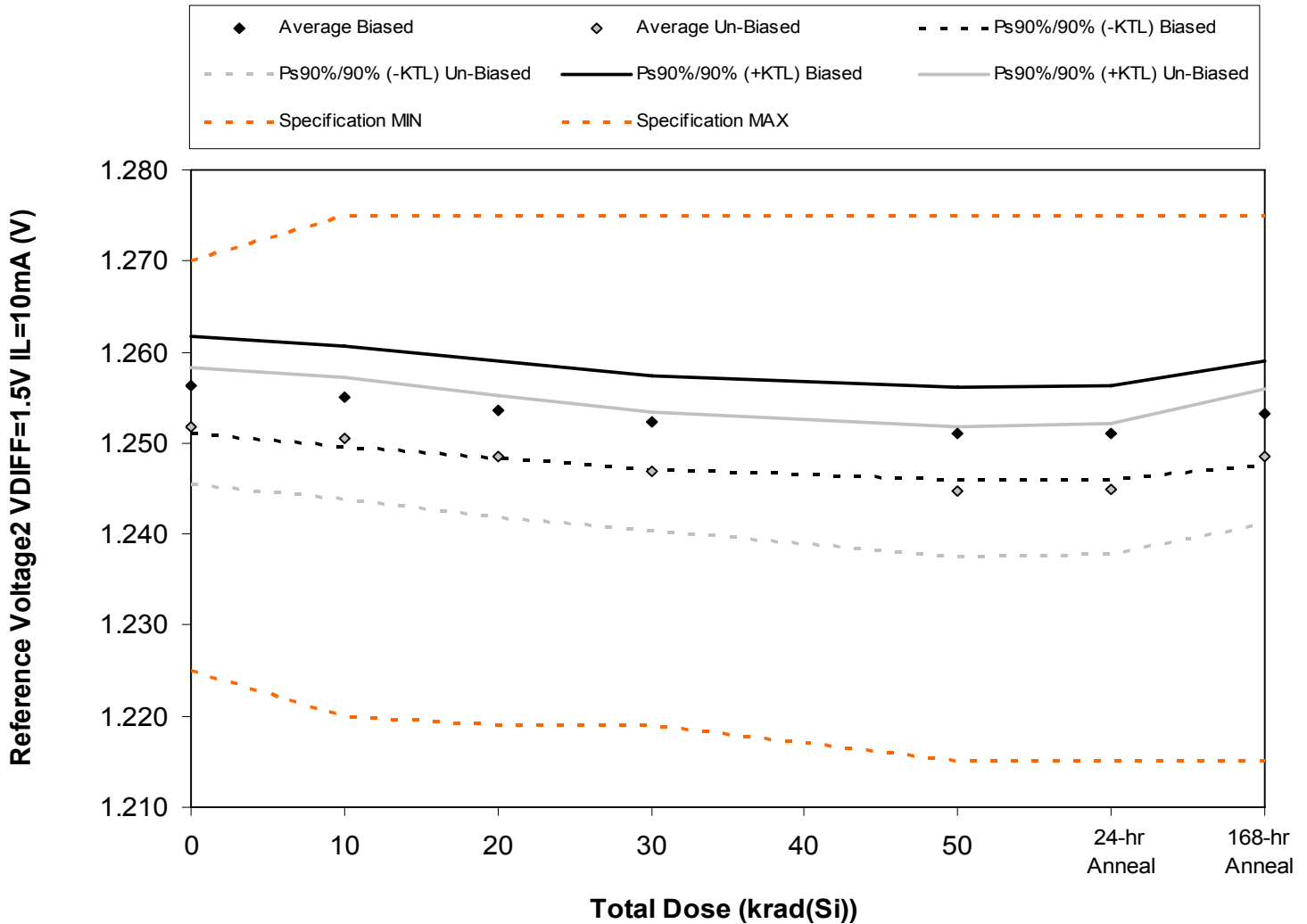

Figure 5.2. Plot of Reference Voltage2 VDIFF=1.5V IL=10mA (V) versus total dose. The solid diamonds are the average of the measured data points for the samples irradiated under electrical bias while the shaded diamonds are the average of the measured data points for the samples irradiated with all pins tied to ground. The black lines (solid and/or dashed) are the average of the data points after application of the KTL statistics on the samples irradiated under electrical bias while the gray lines (solid and/or dashed) are the average of the data points after application of the KTL statistics on the samples irradiated in the unbiased condition. The red dotted line(s) are the pre- and/or post-irradiation minimum and/or maximum specification value as defined in the datasheet and/or test plan.



**TID Test Report
10-118 100824 R1.1**

**Radiation Assured Devices
5017 N. 30th Street
Colorado Springs, CO 80919
(719) 531-0800**

Table 5.2. Raw data for Reference Voltage2 VDIFF=1.5V IL=10mA (V) versus total dose, including the statistical analysis, specification and the status of the testing (pass/fail).

Reference Voltage2 VDIFF=1.5V IL=10mA (V)	Total Dose (krad(Si))					24-hr Anneal	168-hr Anneal
	0	10	20	30	50		
Device							
35	1.256	1.255	1.254	1.252	1.251	1.251	1.253
36	1.258	1.257	1.256	1.254	1.253	1.253	1.256
37	1.255	1.254	1.253	1.251	1.250	1.250	1.252
38	1.258	1.257	1.255	1.254	1.253	1.253	1.255
39	1.254	1.252	1.251	1.250	1.249	1.249	1.251
75	1.252	1.251	1.249	1.247	1.245	1.245	1.249
76	1.255	1.254	1.252	1.250	1.248	1.248	1.252
77	1.251	1.250	1.248	1.246	1.244	1.244	1.248
78	1.249	1.247	1.245	1.244	1.241	1.241	1.244
79	1.253	1.251	1.249	1.248	1.246	1.246	1.250
142	1.253	1.253	1.253	1.253	1.253	1.253	1.253
143	1.252	1.252	1.252	1.252	1.252	1.252	1.252
Biased Statistics							
Average Biased	1.256	1.255	1.254	1.252	1.251	1.251	1.253
Std Dev Biased	1.96E-03	1.99E-03	1.92E-03	1.88E-03	1.85E-03	1.87E-03	2.08E-03
Ps90%/90% (+KTL) Biased	1.262	1.261	1.259	1.257	1.256	1.256	1.259
Ps90%/90% (-KTL) Biased	1.251	1.250	1.248	1.247	1.246	1.246	1.248
Un-Biased Statistics							
Average Un-Biased	1.252	1.250	1.248	1.247	1.245	1.245	1.249
Std Dev Un-Biased	2.32E-03	2.44E-03	2.44E-03	2.36E-03	2.59E-03	2.61E-03	2.71E-03
Ps90%/90% (+KTL) Un-Biased	1.258	1.257	1.255	1.253	1.252	1.252	1.256
Ps90%/90% (-KTL) Un-Biased	1.245	1.244	1.242	1.240	1.238	1.238	1.241
Specification MIN	1.225	1.220	1.219	1.219	1.215	1.215	1.215
Status	PASS	PASS	PASS	PASS	PASS	N/A	N/A
Specification MAX	1.270	1.275	1.275	1.275	1.275	1.275	1.275
Status	PASS	PASS	PASS	PASS	PASS	N/A	N/A

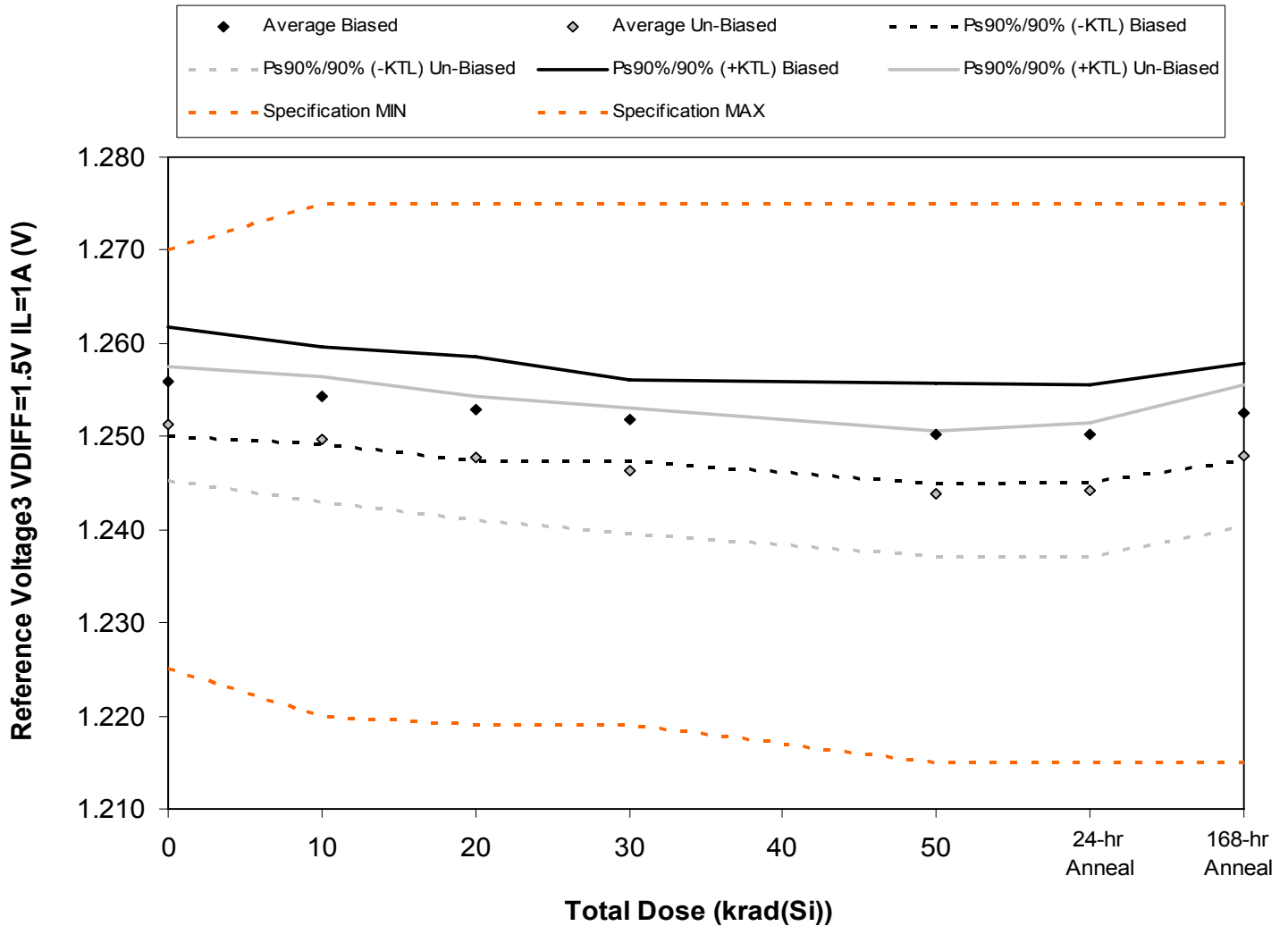

Figure 5.3. Plot of Reference Voltage3 VDIFF=1.5V IL=1A (V) versus total dose. The solid diamonds are the average of the measured data points for the samples irradiated under electrical bias while the shaded diamonds are the average of the measured data points for the samples irradiated with all pins tied to ground. The black lines (solid and/or dashed) are the average of the data points after application of the KTL statistics on the samples irradiated under electrical bias while the gray lines (solid and/or dashed) are the average of the data points after application of the KTL statistics on the samples irradiated in the unbiased condition. The red dotted line(s) are the pre- and/or post-irradiation minimum and/or maximum specification value as defined in the datasheet and/or test plan.



**TID Test Report
10-118 100824 R1.1**

**Radiation Assured Devices
5017 N. 30th Street
Colorado Springs, CO 80919
(719) 531-0800**

Table 5.3. Raw data for Reference Voltage3 VDIFF=1.5V IL=1A (V) versus total dose, including the statistical analysis, specification and the status of the testing (pass/fail).

Reference Voltage3 VDIFF=1.5V IL=1A (V)	Total Dose (krad(Si))					24-hr Anneal	168-hr Anneal
	0	10	20	30	50		
Device							
35	1.256	1.255	1.253	1.251	1.250	1.250	1.252
36	1.258	1.256	1.255	1.254	1.252	1.252	1.255
37	1.255	1.253	1.252	1.251	1.249	1.249	1.252
38	1.258	1.256	1.255	1.253	1.252	1.252	1.254
39	1.253	1.252	1.250	1.250	1.248	1.248	1.250
75	1.252	1.250	1.248	1.247	1.244	1.245	1.248
76	1.254	1.253	1.251	1.249	1.247	1.247	1.251
77	1.251	1.249	1.247	1.246	1.243	1.244	1.247
78	1.248	1.246	1.244	1.243	1.240	1.240	1.244
79	1.252	1.250	1.249	1.247	1.245	1.245	1.249
142	1.252	1.253	1.252	1.253	1.252	1.252	1.253
143	1.251	1.252	1.251	1.252	1.252	1.251	1.251
Biased Statistics							
Average Biased	1.256	1.254	1.253	1.252	1.250	1.250	1.253
Std Dev Biased	2.16E-03	1.90E-03	2.04E-03	1.61E-03	1.97E-03	1.91E-03	1.92E-03
Ps90%/90% (+KTL) Biased	1.262	1.260	1.259	1.256	1.256	1.256	1.258
Ps90%/90% (-KTL) Biased	1.250	1.249	1.247	1.247	1.245	1.245	1.247
Un-Biased Statistics							
Average Un-Biased	1.251	1.250	1.248	1.246	1.244	1.244	1.248
Std Dev Un-Biased	2.22E-03	2.45E-03	2.42E-03	2.44E-03	2.47E-03	2.62E-03	2.79E-03
Ps90%/90% (+KTL) Un-Biased	1.257	1.256	1.254	1.253	1.251	1.251	1.256
Ps90%/90% (-KTL) Un-Biased	1.245	1.243	1.241	1.240	1.237	1.237	1.240
Specification MIN	1.225	1.220	1.219	1.219	1.215	1.215	1.215
Status	PASS	PASS	PASS	PASS	PASS	N/A	N/A
Specification MAX	1.270	1.275	1.275	1.275	1.275	1.275	1.275
Status	PASS	PASS	PASS	PASS	PASS	N/A	N/A

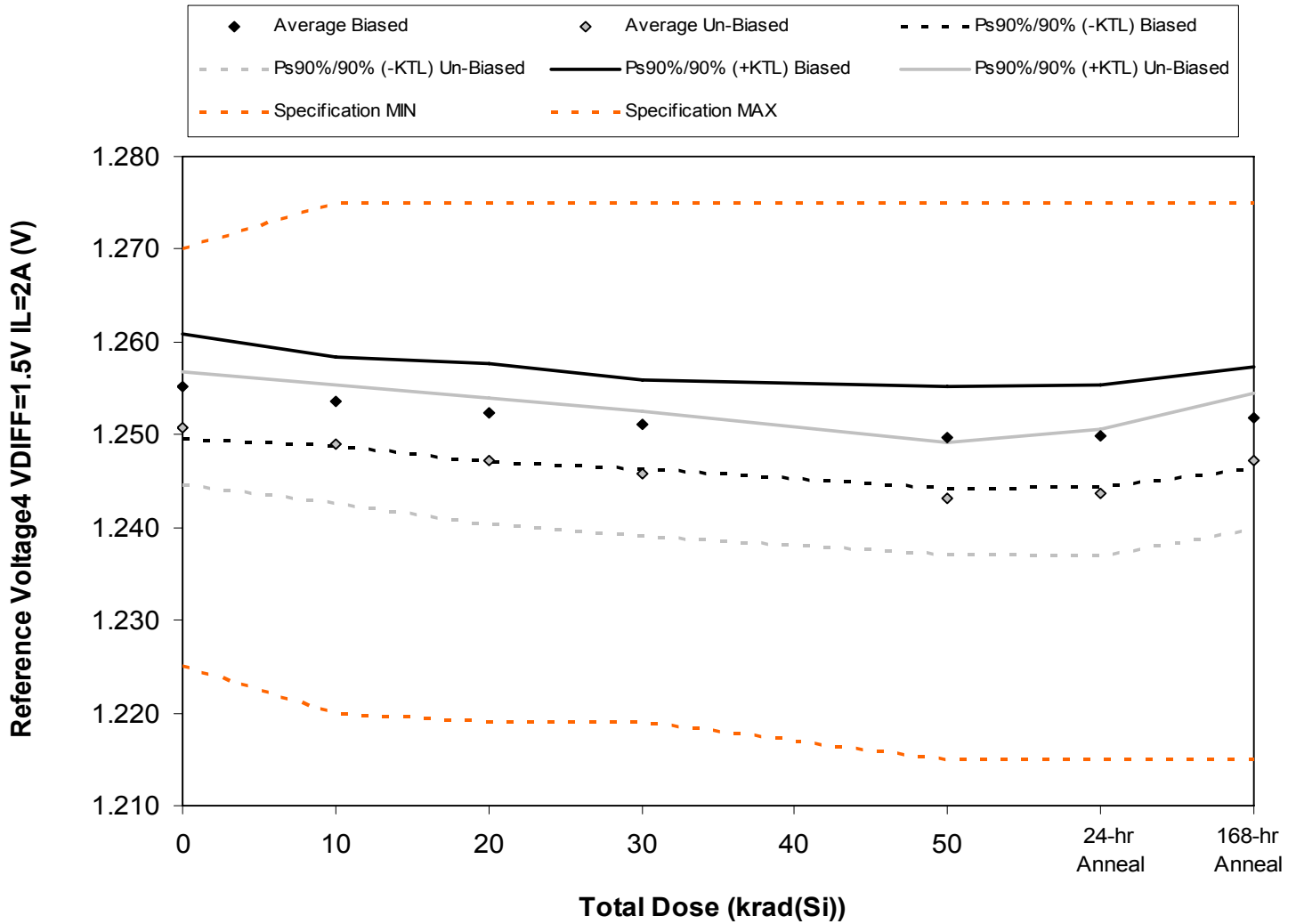

Figure 5.4. Plot of Reference Voltage4 VDIFF=1.5V IL=2A (V) versus total dose. The solid diamonds are the average of the measured data points for the samples irradiated under electrical bias while the shaded diamonds are the average of the measured data points for the samples irradiated with all pins tied to ground. The black lines (solid and/or dashed) are the average of the data points after application of the KTL statistics on the samples irradiated under electrical bias while the gray lines (solid and/or dashed) are the average of the data points after application of the KTL statistics on the samples irradiated in the unbiased condition. The red dotted line(s) are the pre- and/or post-irradiation minimum and/or maximum specification value as defined in the datasheet and/or test plan.



**TID Test Report
10-118 100824 R1.1**

**Radiation Assured Devices
5017 N. 30th Street
Colorado Springs, CO 80919
(719) 531-0800**

Table 5.4. Raw data for Reference Voltage4 VDIFF=1.5V IL=2A (V) versus total dose, including the statistical analysis, specification and the status of the testing (pass/fail).

Reference Voltage4 VDIFF=1.5V IL=2A (V)	Total Dose (krad(Si))					24-hr Anneal	168-hr Anneal
	0	10	20	30	50		
Device							
35	1.255	1.254	1.252	1.251	1.249	1.249	1.251
36	1.257	1.255	1.254	1.253	1.252	1.252	1.254
37	1.254	1.253	1.251	1.250	1.249	1.249	1.251
38	1.257	1.255	1.254	1.253	1.251	1.252	1.254
39	1.252	1.251	1.250	1.249	1.247	1.247	1.250
75	1.251	1.250	1.248	1.246	1.244	1.244	1.248
76	1.254	1.252	1.250	1.249	1.246	1.247	1.250
77	1.250	1.249	1.246	1.245	1.243	1.243	1.246
78	1.248	1.245	1.244	1.242	1.240	1.240	1.243
79	1.252	1.250	1.248	1.247	1.244	1.245	1.248
142	1.252	1.252	1.252	1.252	1.252	1.252	1.252
143	1.251	1.251	1.251	1.251	1.251	1.251	1.251
Biased Statistics							
Average Biased	1.255	1.254	1.252	1.251	1.250	1.250	1.252
Std Dev Biased	2.07E-03	1.74E-03	1.94E-03	1.75E-03	2.00E-03	2.01E-03	2.00E-03
Ps90%/90% (+KTL) Biased	1.261	1.258	1.258	1.256	1.255	1.255	1.257
Ps90%/90% (-KTL) Biased	1.249	1.249	1.247	1.246	1.244	1.244	1.246
Un-Biased Statistics							
Average Un-Biased	1.251	1.249	1.247	1.246	1.243	1.244	1.247
Std Dev Un-Biased	2.23E-03	2.32E-03	2.47E-03	2.46E-03	2.22E-03	2.51E-03	2.68E-03
Ps90%/90% (+KTL) Un-Biased	1.257	1.255	1.254	1.252	1.249	1.251	1.254
Ps90%/90% (-KTL) Un-Biased	1.245	1.243	1.240	1.239	1.237	1.237	1.240
Specification MIN	1.225	1.220	1.219	1.219	1.215	1.215	1.215
Status	PASS	PASS	PASS	PASS	PASS	N/A	N/A
Specification MAX	1.270	1.275	1.275	1.275	1.275	1.275	1.275
Status	PASS	PASS	PASS	PASS	PASS	N/A	N/A

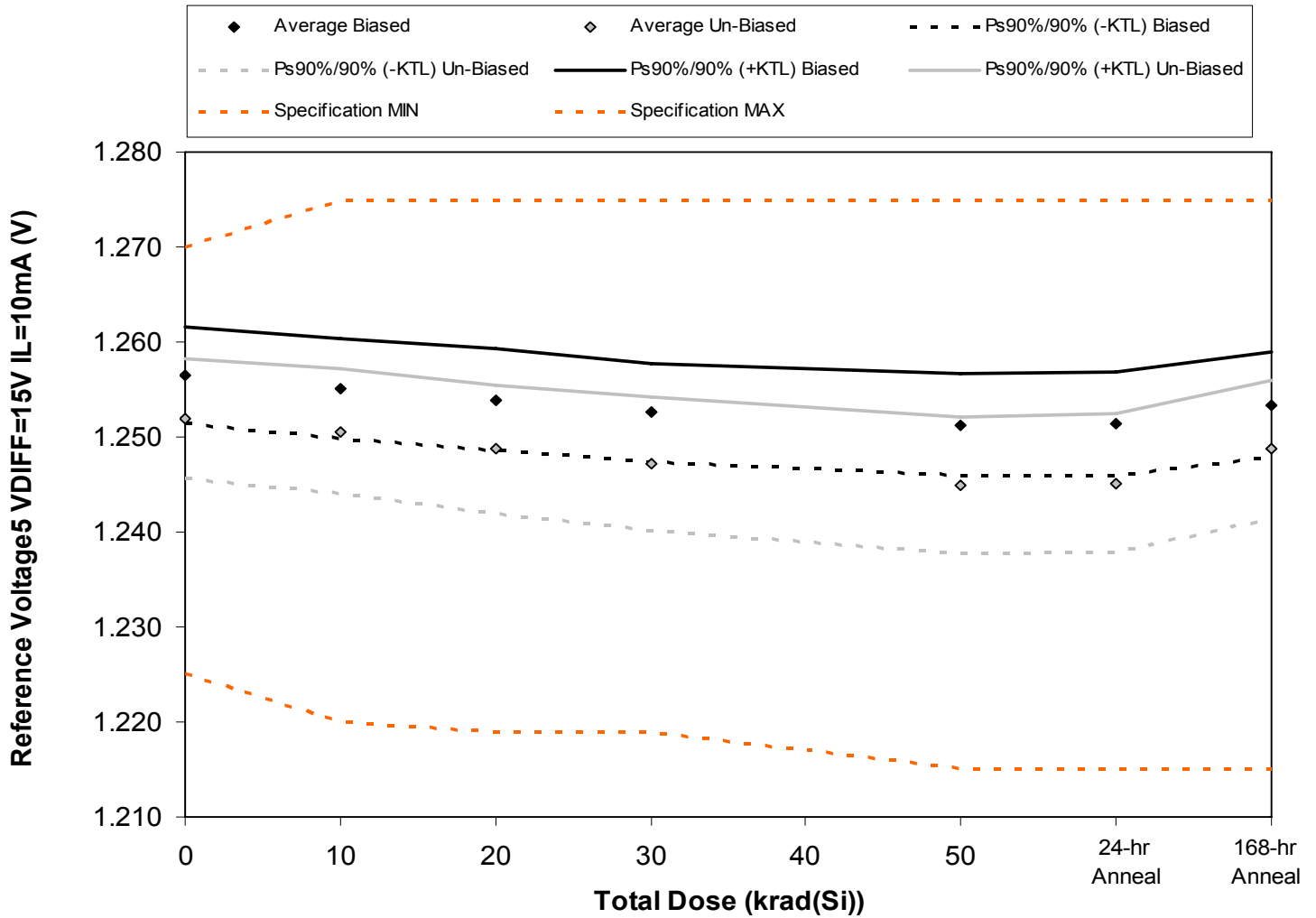

Figure 5.5. Plot of Reference Voltage5 VDIFF=15V IL=10mA (V) versus total dose. The solid diamonds are the average of the measured data points for the samples irradiated under electrical bias while the shaded diamonds are the average of the measured data points for the samples irradiated with all pins tied to ground. The black lines (solid and/or dashed) are the average of the data points after application of the KTL statistics on the samples irradiated under electrical bias while the gray lines (solid and/or dashed) are the average of the data points after application of the KTL statistics on the samples irradiated in the unbiased condition. The red dotted line(s) are the pre- and/or post-irradiation minimum and/or maximum specification value as defined in the datasheet and/or test plan.



**TID Test Report
10-118 100824 R1.1**

**Radiation Assured Devices
5017 N. 30th Street
Colorado Springs, CO 80919
(719) 531-0800**

Table 5.5. Raw data for Reference Voltage5 VDIFF=15V IL=10mA (V) versus total dose, including the statistical analysis, specification and the status of the testing (pass/fail).

Reference Voltage5 VDIFF=15V IL=10mA (V)	Total Dose (krad(Si))					24-hr Anneal	168-hr Anneal
	0	10	20	30	50		
Device							
35	1.257	1.255	1.254	1.252	1.251	1.251	1.253
36	1.258	1.257	1.256	1.255	1.253	1.254	1.256
37	1.256	1.254	1.253	1.252	1.250	1.250	1.252
38	1.258	1.257	1.256	1.254	1.253	1.253	1.255
39	1.254	1.253	1.251	1.250	1.249	1.249	1.251
75	1.252	1.251	1.249	1.247	1.245	1.245	1.249
76	1.255	1.254	1.252	1.251	1.248	1.248	1.252
77	1.251	1.250	1.248	1.247	1.244	1.245	1.248
78	1.249	1.247	1.245	1.243	1.241	1.241	1.245
79	1.253	1.251	1.250	1.248	1.246	1.246	1.250
142	1.253	1.254	1.253	1.253	1.253	1.253	1.253
143	1.252	1.253	1.252	1.252	1.252	1.252	1.252
Biased Statistics							
Average Biased	1.257	1.255	1.254	1.253	1.251	1.251	1.253
Std Dev Biased	1.88E-03	1.90E-03	1.96E-03	1.87E-03	1.98E-03	1.99E-03	2.01E-03
Ps90%/90% (+KTL) Biased	1.262	1.260	1.259	1.258	1.257	1.257	1.259
Ps90%/90% (-KTL) Biased	1.251	1.250	1.249	1.247	1.246	1.246	1.248
Un-Biased Statistics							
Average Un-Biased	1.252	1.251	1.249	1.247	1.245	1.245	1.249
Std Dev Un-Biased	2.31E-03	2.42E-03	2.45E-03	2.58E-03	2.63E-03	2.66E-03	2.64E-03
Ps90%/90% (+KTL) Un-Biased	1.258	1.257	1.255	1.254	1.252	1.252	1.256
Ps90%/90% (-KTL) Un-Biased	1.246	1.244	1.242	1.240	1.238	1.238	1.241
Specification MIN	1.225	1.220	1.219	1.219	1.215	1.215	1.215
Status	PASS	PASS	PASS	PASS	PASS	N/A	N/A
Specification MAX	1.270	1.275	1.275	1.275	1.275	1.275	1.275
Status	PASS	PASS	PASS	PASS	PASS	N/A	N/A

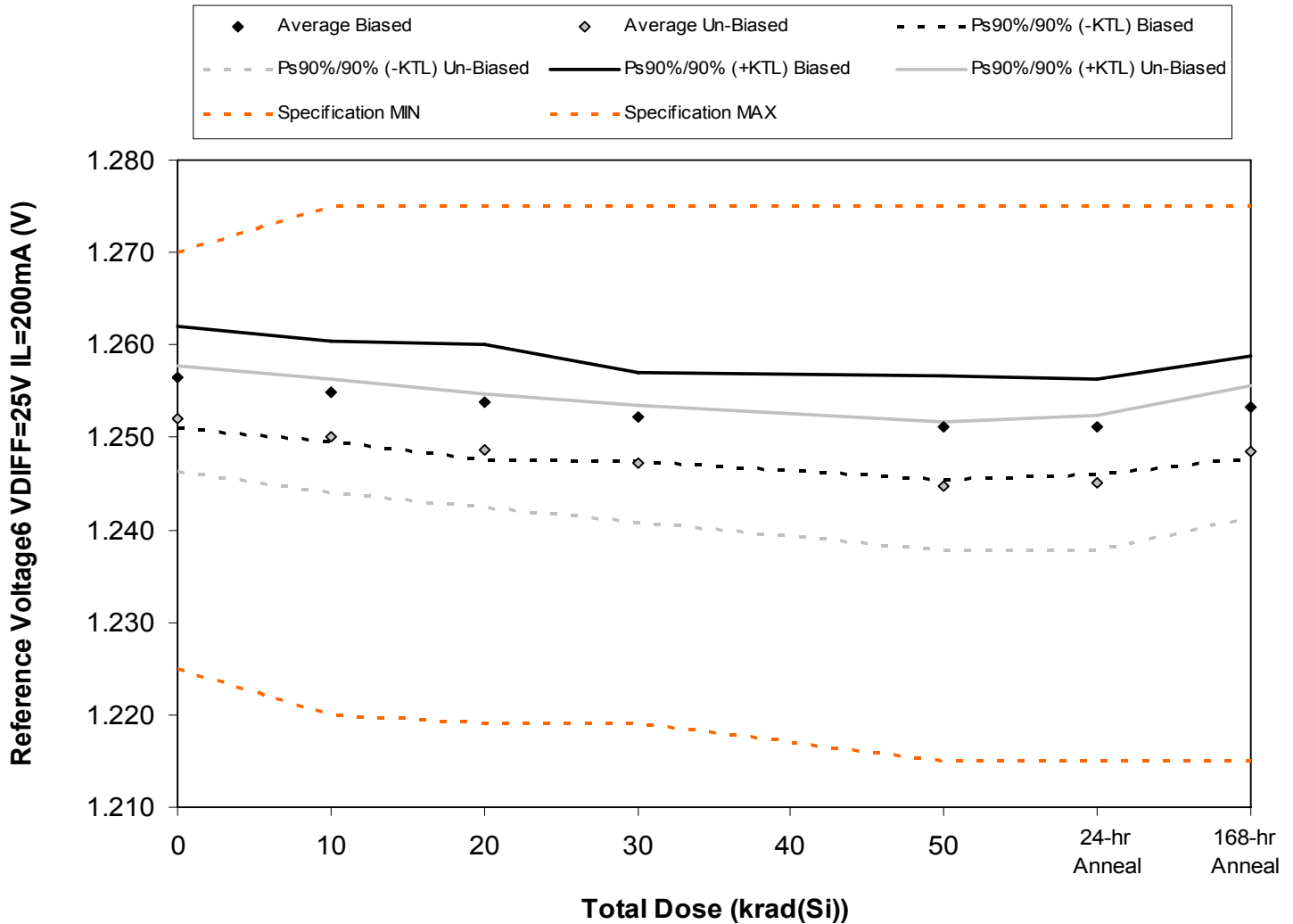

Figure 5.6. Plot of Reference Voltage6 VDIFF=25V IL=200mA (V) versus total dose. The solid diamonds are the average of the measured data points for the samples irradiated under electrical bias while the shaded diamonds are the average of the measured data points for the samples irradiated with all pins tied to ground. The black lines (solid and/or dashed) are the average of the data points after application of the KTL statistics on the samples irradiated under electrical bias while the gray lines (solid and/or dashed) are the average of the data points after application of the KTL statistics on the samples irradiated in the unbiased condition. The red dotted line(s) are the pre- and/or post-irradiation minimum and/or maximum specification value as defined in the datasheet and/or test plan.



**TID Test Report
10-118 100824 R1.1**

**Radiation Assured Devices
5017 N. 30th Street
Colorado Springs, CO 80919
(719) 531-0800**

Table 5.6. Raw data for Reference Voltage6 VDIFF=25V IL=200mA (V) versus total dose, including the statistical analysis, specification and the status of the testing (pass/fail).

Reference Voltage6 VDIFF=25V IL=200mA (V)	Total Dose (krad(Si))					24-hr Anneal	168-hr Anneal
	0	10	20	30	50		
Device							
35	1.257	1.255	1.253	1.252	1.251	1.251	1.253
36	1.258	1.257	1.256	1.254	1.253	1.253	1.256
37	1.256	1.254	1.253	1.251	1.250	1.250	1.252
38	1.258	1.257	1.256	1.254	1.253	1.253	1.255
39	1.253	1.252	1.251	1.250	1.249	1.249	1.251
75	1.252	1.251	1.249	1.248	1.245	1.245	1.249
76	1.255	1.253	1.251	1.250	1.248	1.248	1.251
77	1.251	1.250	1.249	1.247	1.244	1.245	1.248
78	1.249	1.247	1.245	1.244	1.241	1.241	1.244
79	1.253	1.251	1.249	1.248	1.246	1.246	1.250
142	1.253	1.253	1.253	1.253	1.253	1.254	1.253
143	1.252	1.252	1.252	1.252	1.252	1.252	1.252
Biased Statistics							
Average Biased	1.257	1.255	1.254	1.252	1.251	1.251	1.253
Std Dev Biased	2.00E-03	1.98E-03	2.29E-03	1.77E-03	2.06E-03	1.90E-03	2.00E-03
Ps90%/90% (+KTL) Biased	1.262	1.260	1.260	1.257	1.257	1.256	1.259
Ps90%/90% (-KTL) Biased	1.251	1.249	1.248	1.247	1.245	1.246	1.248
Un-Biased Statistics							
Average Un-Biased	1.252	1.250	1.249	1.247	1.245	1.245	1.248
Std Dev Un-Biased	2.06E-03	2.24E-03	2.25E-03	2.33E-03	2.56E-03	2.66E-03	2.61E-03
Ps90%/90% (+KTL) Un-Biased	1.258	1.256	1.255	1.254	1.252	1.252	1.256
Ps90%/90% (-KTL) Un-Biased	1.246	1.244	1.242	1.241	1.238	1.238	1.241
Specification MIN	1.225	1.220	1.219	1.219	1.215	1.215	1.215
Status	PASS	PASS	PASS	PASS	PASS	N/A	N/A
Specification MAX	1.270	1.275	1.275	1.275	1.275	1.275	1.275
Status	PASS	PASS	PASS	PASS	PASS	N/A	N/A

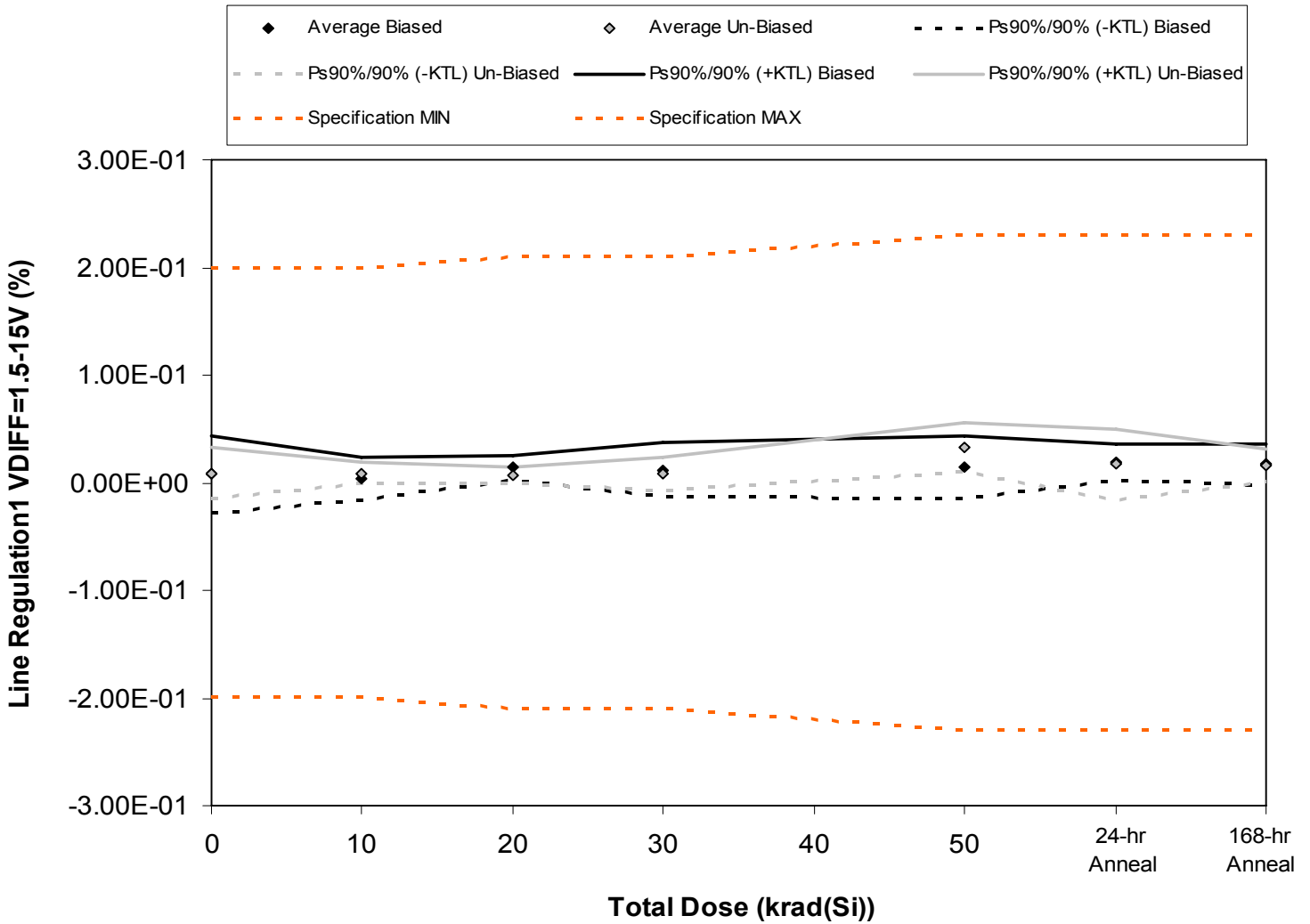

Figure 5.7. Plot of Line Regulation1 VDIFF=1.5-15V (%) versus total dose. The solid diamonds are the average of the measured data points for the samples irradiated under electrical bias while the shaded diamonds are the average of the measured data points for the samples irradiated with all pins tied to ground. The black lines (solid and/or dashed) are the average of the data points after application of the KTL statistics on the samples irradiated under electrical bias while the gray lines (solid and/or dashed) are the average of the data points after application of the KTL statistics on the samples irradiated in the unbiased condition. The red dotted line(s) are the pre- and/or post-irradiation minimum and/or maximum specification value as defined in the datasheet and/or test plan.



**TID Test Report
10-118 100824 R1.1**

**Radiation Assured Devices
5017 N. 30th Street
Colorado Springs, CO 80919
(719) 531-0800**

Table 5.7. Raw data for Line Regulation1 VDIFF=1.5-15V (%) versus total dose, including the statistical analysis, specification and the status of the testing (pass/fail).

Line Regulation1 VDIFF=1.5-15V (%)	Total Dose (krad(Si))					24-hr Anneal	168-hr Anneal
	0	10	20	30	50		
Device							
35	1.07E-02	2.70E-03	1.75E-02	2.42E-02	1.62E-02	1.62E-02	2.28E-02
36	1.87E-02	1.21E-02	1.88E-02	-1.30E-03	1.75E-02	2.82E-02	1.21E-02
37	1.48E-02	9.40E-03	8.10E-03	1.48E-02	-1.30E-03	1.21E-02	2.55E-02
38	9.40E-03	-2.70E-03	1.21E-02	1.21E-02	2.82E-02	1.61E-02	9.40E-03
39	-1.48E-02	-4.00E-03	1.35E-02	1.08E-02	1.21E-02	2.16E-02	1.48E-02
75	8.10E-03	9.40E-03	5.40E-03	1.62E-02	3.52E-02	2.57E-02	1.35E-02
76	2.41E-02	5.40E-03	5.40E-03	1.08E-02	4.05E-02	8.10E-03	2.02E-02
77	6.70E-03	9.40E-03	1.08E-02	4.10E-03	4.06E-02	1.40E-03	2.02E-02
78	1.30E-03	1.49E-02	9.50E-03	1.08E-02	2.71E-02	2.04E-02	8.10E-03
79	5.40E-03	6.70E-03	4.00E-03	2.70E-03	2.16E-02	2.97E-02	2.02E-02
142	9.40E-03	1.07E-02	1.30E-03	1.88E-02	2.55E-02	1.34E-02	5.40E-03
143	2.02E-02	1.21E-02	1.08E-02	5.40E-03	1.61E-02	2.42E-02	1.30E-03
Biased Statistics							
Average Biased	7.76E-03	3.50E-03	1.40E-02	1.21E-02	1.45E-02	1.88E-02	1.69E-02
Std Dev Biased	1.31E-02	7.14E-03	4.30E-03	9.15E-03	1.07E-02	6.23E-03	6.94E-03
Ps90%/90% (+KTL) Biased	4.38E-02	2.31E-02	2.58E-02	3.72E-02	4.38E-02	3.59E-02	3.59E-02
Ps90%/90% (-KTL) Biased	-2.82E-02	-1.61E-02	2.21E-03	-1.30E-02	-1.47E-02	1.76E-03	-2.10E-03
Un-Biased Statistics							
Average Un-Biased	9.12E-03	9.16E-03	7.02E-03	8.92E-03	3.30E-02	1.71E-02	1.64E-02
Std Dev Un-Biased	8.75E-03	3.65E-03	2.95E-03	5.52E-03	8.42E-03	1.19E-02	5.49E-03
Ps90%/90% (+KTL) Un-Biased	3.31E-02	1.92E-02	1.51E-02	2.41E-02	5.61E-02	4.98E-02	3.15E-02
Ps90%/90% (-KTL) Un-Biased	-1.49E-02	-8.45E-04	-1.07E-03	-6.22E-03	9.91E-03	-1.57E-02	1.38E-03
Specification MIN	-2.00E-01	-2.00E-01	-2.10E-01	-2.10E-01	-2.30E-01	-2.30E-01	-2.30E-01
Status	PASS	PASS	PASS	PASS	PASS	N/A	N/A
Specification MAX	2.00E-01	2.00E-01	2.10E-01	2.10E-01	2.30E-01	2.30E-01	2.30E-01
Status	PASS	PASS	PASS	PASS	PASS	N/A	N/A

An ISO 9001:2008 and DSCC Certified Company

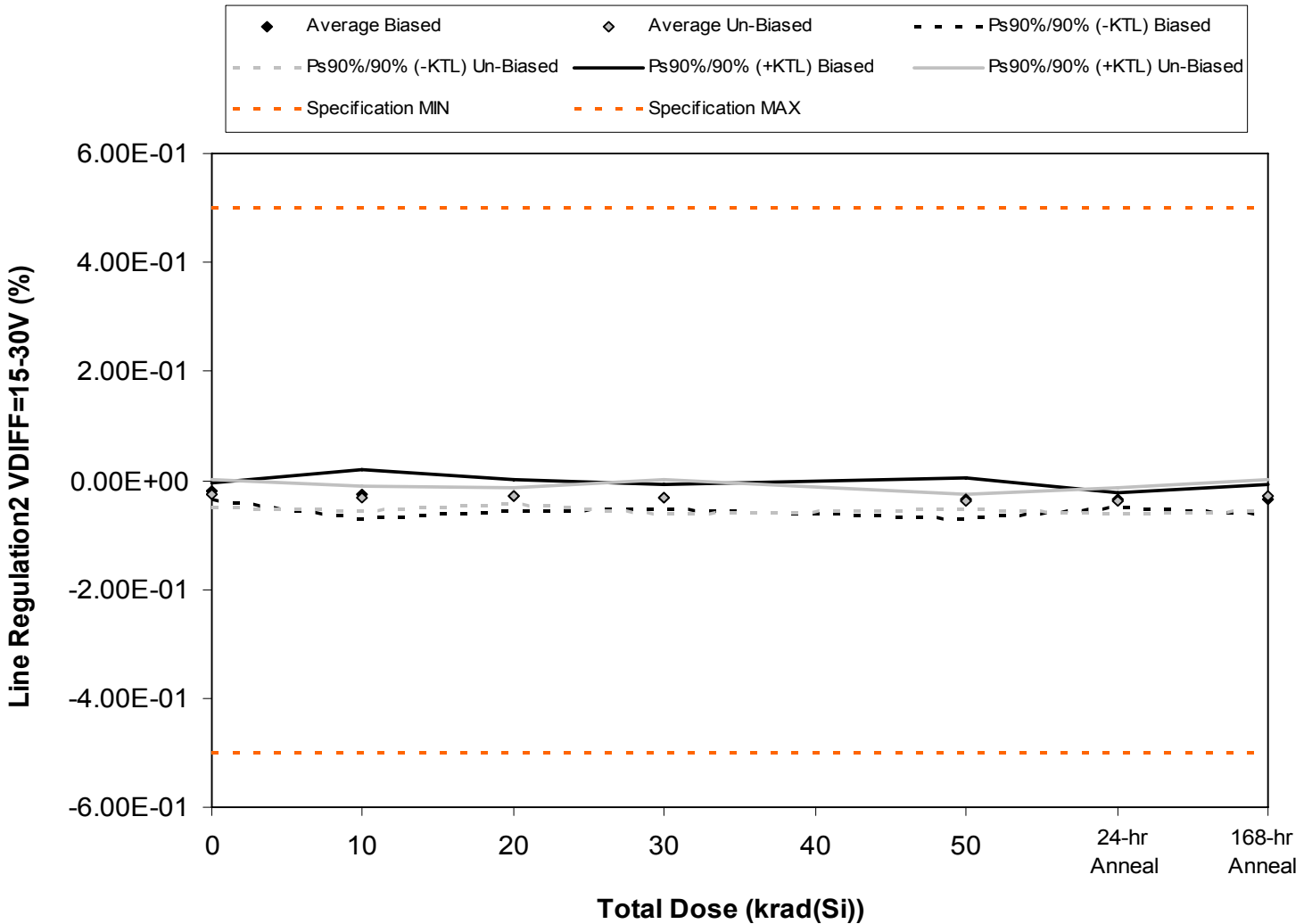

Figure 5.8. Plot of Line Regulation2 VDIFF=15-30V (%) versus total dose. The solid diamonds are the average of the measured data points for the samples irradiated under electrical bias while the shaded diamonds are the average of the measured data points for the samples irradiated with all pins tied to ground. The black lines (solid and/or dashed) are the average of the data points after application of the KTL statistics on the samples irradiated under electrical bias while the gray lines (solid and/or dashed) are the average of the data points after application of the KTL statistics on the samples irradiated in the unbiased condition. The red dotted line(s) are the pre- and/or post-irradiation minimum and/or maximum specification value as defined in the datasheet and/or test plan.



**TID Test Report
10-118 100824 R1.1**

**Radiation Assured Devices
5017 N. 30th Street
Colorado Springs, CO 80919
(719) 531-0800**

Table 5.8. Raw data for Line Regulation2 VDIFF=15-30V (%) versus total dose, including the statistical analysis, specification and the status of the testing (pass/fail).

Line Regulation2 VDIFF=15-30V (%)	Total Dose (krad(Si))					24-hr Anneal	168-hr Anneal
	0	10	20	30	50		
Device							
35	-1.88E-02	-4.96E-02	-3.22E-02	-3.50E-02	-5.38E-02	-4.17E-02	-3.49E-02
36	-1.74E-02	-1.88E-02	-2.01E-02	-2.15E-02	-3.76E-02	-3.09E-02	-4.69E-02
37	-2.41E-02	-9.40E-03	-1.34E-02	-3.77E-02	-2.02E-02	-3.23E-02	-2.02E-02
38	-2.54E-02	-1.47E-02	-4.02E-02	-2.28E-02	-2.02E-02	-3.90E-02	-3.22E-02
39	-1.21E-02	-3.36E-02	-3.23E-02	-3.91E-02	-3.64E-02	-3.10E-02	-4.04E-02
75	-3.23E-02	-2.96E-02	-2.56E-02	-2.02E-02	-3.11E-02	-3.92E-02	-3.64E-02
76	-3.62E-02	-2.15E-02	-2.96E-02	-2.29E-02	-3.91E-02	-3.24E-02	-3.63E-02
77	-1.48E-02	-3.50E-02	-3.51E-02	-3.92E-02	-4.46E-02	-2.71E-02	-1.21E-02
78	-2.43E-02	-4.45E-02	-3.52E-02	-2.71E-02	-4.21E-02	-5.02E-02	-2.44E-02
79	-1.75E-02	-3.09E-02	-2.29E-02	-4.72E-02	-3.92E-02	-4.19E-02	-3.37E-02
142	-3.22E-02	-2.42E-02	-3.09E-02	-1.61E-02	-2.69E-02	-2.15E-02	-1.75E-02
143	-1.61E-02	-3.09E-02	-2.96E-02	-2.55E-02	-2.42E-02	-2.15E-02	-1.61E-02
Biased Statistics							
Average Biased	-1.96E-02	-2.52E-02	-2.76E-02	-3.12E-02	-3.36E-02	-3.50E-02	-3.49E-02
Std Dev Biased	5.38E-03	1.63E-02	1.07E-02	8.42E-03	1.41E-02	5.02E-03	9.97E-03
Ps90%/90% (+KTL) Biased	-4.82E-03	1.96E-02	1.76E-03	-8.13E-03	4.92E-03	-2.12E-02	-7.58E-03
Ps90%/90% (-KTL) Biased	-3.43E-02	-7.00E-02	-5.70E-02	-5.43E-02	-7.22E-02	-4.88E-02	-6.23E-02
Un-Biased Statistics							
Average Un-Biased	-2.50E-02	-3.23E-02	-2.97E-02	-3.13E-02	-3.92E-02	-3.82E-02	-2.86E-02
Std Dev Un-Biased	9.21E-03	8.40E-03	5.53E-03	1.15E-02	5.08E-03	8.88E-03	1.04E-02
Ps90%/90% (+KTL) Un-Biased	2.42E-04	-9.28E-03	-1.45E-02	1.42E-04	-2.53E-02	-1.38E-02	4.82E-05
Ps90%/90% (-KTL) Un-Biased	-5.03E-02	-5.53E-02	-4.49E-02	-6.28E-02	-5.31E-02	-6.25E-02	-5.72E-02
Specification MIN	-5.00E-01	-5.00E-01	-5.00E-01	-5.00E-01	-5.00E-01	-5.00E-01	-5.00E-01
Status	PASS	PASS	PASS	PASS	PASS	N/A	N/A
Specification MAX	5.00E-01	5.00E-01	5.00E-01	5.00E-01	5.00E-01	5.00E-01	5.00E-01
Status	PASS	PASS	PASS	PASS	PASS	N/A	N/A

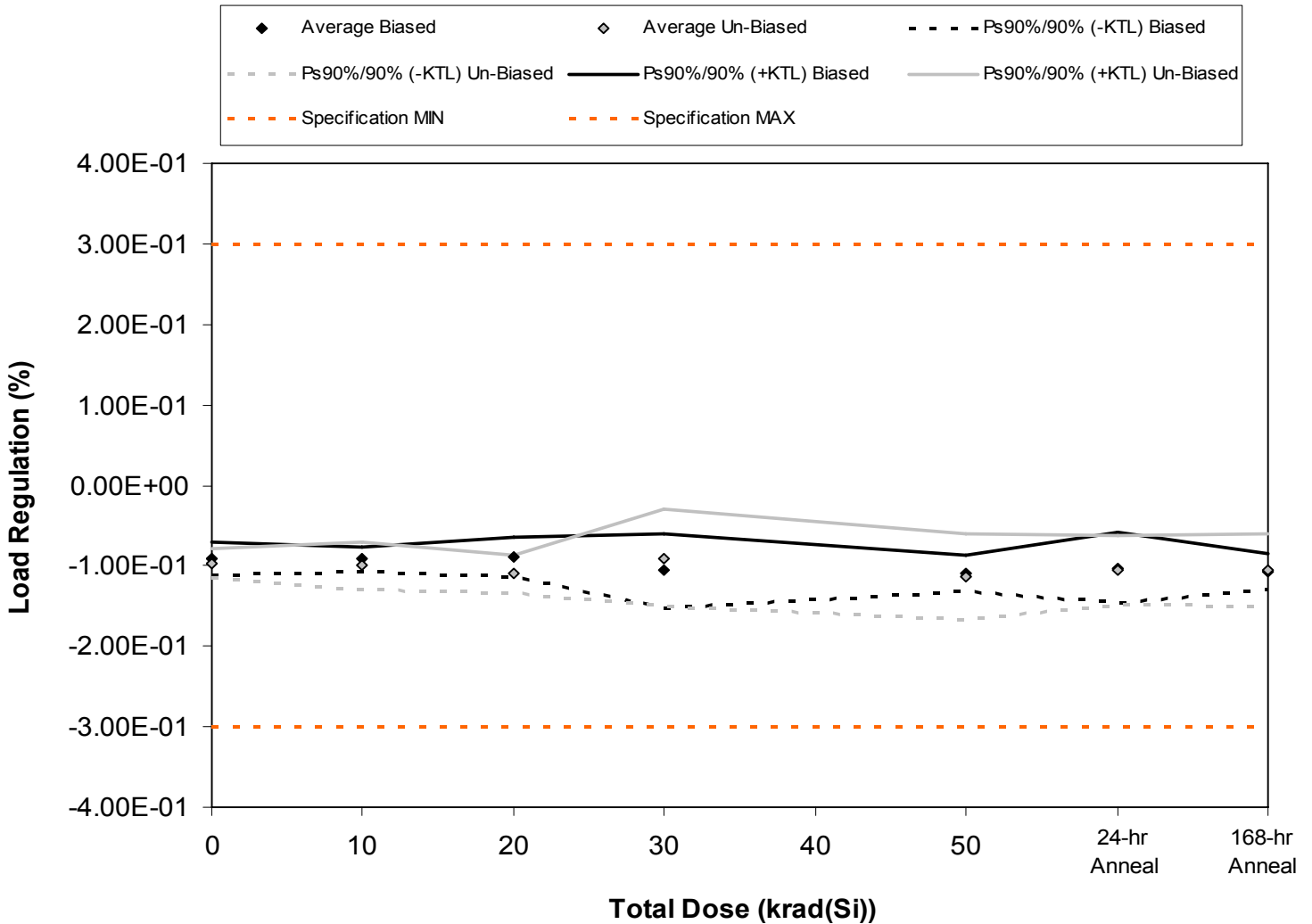

Figure 5.9. Plot of Load Regulation (%) versus total dose. The solid diamonds are the average of the measured data points for the samples irradiated under electrical bias while the shaded diamonds are the average of the measured data points for the samples irradiated with all pins tied to ground. The black lines (solid and/or dashed) are the average of the data points after application of the KTL statistics on the samples irradiated under electrical bias while the gray lines (solid and/or dashed) are the average of the data points after application of the KTL statistics on the samples irradiated in the unbiased condition. The red dotted line(s) are the pre- and/or post-irradiation minimum and/or maximum specification value as defined in the datasheet and/or test plan.



Table 5.9. Raw data for Load Regulation (%) versus total dose, including the statistical analysis, specification and the status of the testing (pass/fail).

Load Regulation (%)	Total Dose (krad(Si))					24-hr Anneal	168-hr Anneal
	0	10	20	30	50		
Device							
35	-9.65E-02	-9.12E-02	-9.13E-02	-1.33E-01	-1.19E-01	-8.88E-02	-1.05E-01
36	-8.03E-02	-1.01E-01	-8.04E-02	-1.07E-01	-9.94E-02	-9.27E-02	-1.01E-01
37	-8.45E-02	-8.99E-02	-7.93E-02	-9.28E-02	-1.08E-01	-1.25E-01	-1.01E-01
38	-9.63E-02	-9.24E-02	-9.25E-02	-9.26E-02	-1.06E-01	-9.27E-02	-1.21E-01
39	-9.53E-02	-8.47E-02	-1.01E-01	-1.05E-01	-1.17E-01	-1.15E-01	-1.06E-01
75	-1.06E-01	-8.88E-02	-1.20E-01	-1.01E-01	-1.24E-01	-1.07E-01	-1.05E-01
76	-9.12E-02	-1.08E-01	-1.01E-01	-9.56E-02	-1.39E-01	-9.85E-02	-1.31E-01
77	-9.01E-02	-9.29E-02	-1.05E-01	-9.59E-02	-9.88E-02	-1.12E-01	-8.77E-02
78	-9.57E-02	-9.45E-02	-1.06E-01	-1.07E-01	-9.09E-02	-8.28E-02	-9.33E-02
79	-1.02E-01	-1.14E-01	-1.19E-01	-5.13E-02	-1.16E-01	-1.24E-01	-1.06E-01
142	-1.08E-01	-1.02E-01	-1.32E-01	-8.87E-02	-9.00E-02	-1.04E-01	-9.54E-02
143	-1.10E-01	-8.74E-02	-8.88E-02	-1.09E-01	-1.02E-01	-1.09E-01	-9.01E-02
Biased Statistics							
Average Biased	-9.06E-02	-9.17E-02	-8.89E-02	-1.06E-01	-1.10E-01	-1.03E-01	-1.07E-01
Std Dev Biased	7.63E-03	5.71E-03	9.04E-03	1.65E-02	8.02E-03	1.61E-02	8.24E-03
Ps90%/90% (+KTL) Biased	-6.97E-02	-7.61E-02	-6.41E-02	-6.09E-02	-8.78E-02	-5.86E-02	-8.40E-02
Ps90%/90% (-KTL) Biased	-1.11E-01	-1.07E-01	-1.14E-01	-1.51E-01	-1.32E-01	-1.47E-01	-1.29E-01
Un-Biased Statistics							
Average Un-Biased	-9.71E-02	-9.96E-02	-1.10E-01	-9.02E-02	-1.14E-01	-1.05E-01	-1.05E-01
Std Dev Un-Biased	6.96E-03	1.08E-02	8.66E-03	2.22E-02	1.94E-02	1.55E-02	1.65E-02
Ps90%/90% (+KTL) Un-Biased	-7.80E-02	-6.99E-02	-8.63E-02	-2.92E-02	-6.07E-02	-6.24E-02	-5.94E-02
Ps90%/90% (-KTL) Un-Biased	-1.16E-01	-1.29E-01	-1.34E-01	-1.51E-01	-1.67E-01	-1.48E-01	-1.50E-01
Specification MIN	-3.00E-01	-3.00E-01	-3.00E-01	-3.00E-01	-3.00E-01	-3.00E-01	-3.00E-01
Status	PASS	PASS	PASS	PASS	PASS	N/A	N/A
Specification MAX	3.00E-01	3.00E-01	3.00E-01	3.00E-01	3.00E-01	3.00E-01	3.00E-01
Status	PASS	PASS	PASS	PASS	PASS	N/A	N/A

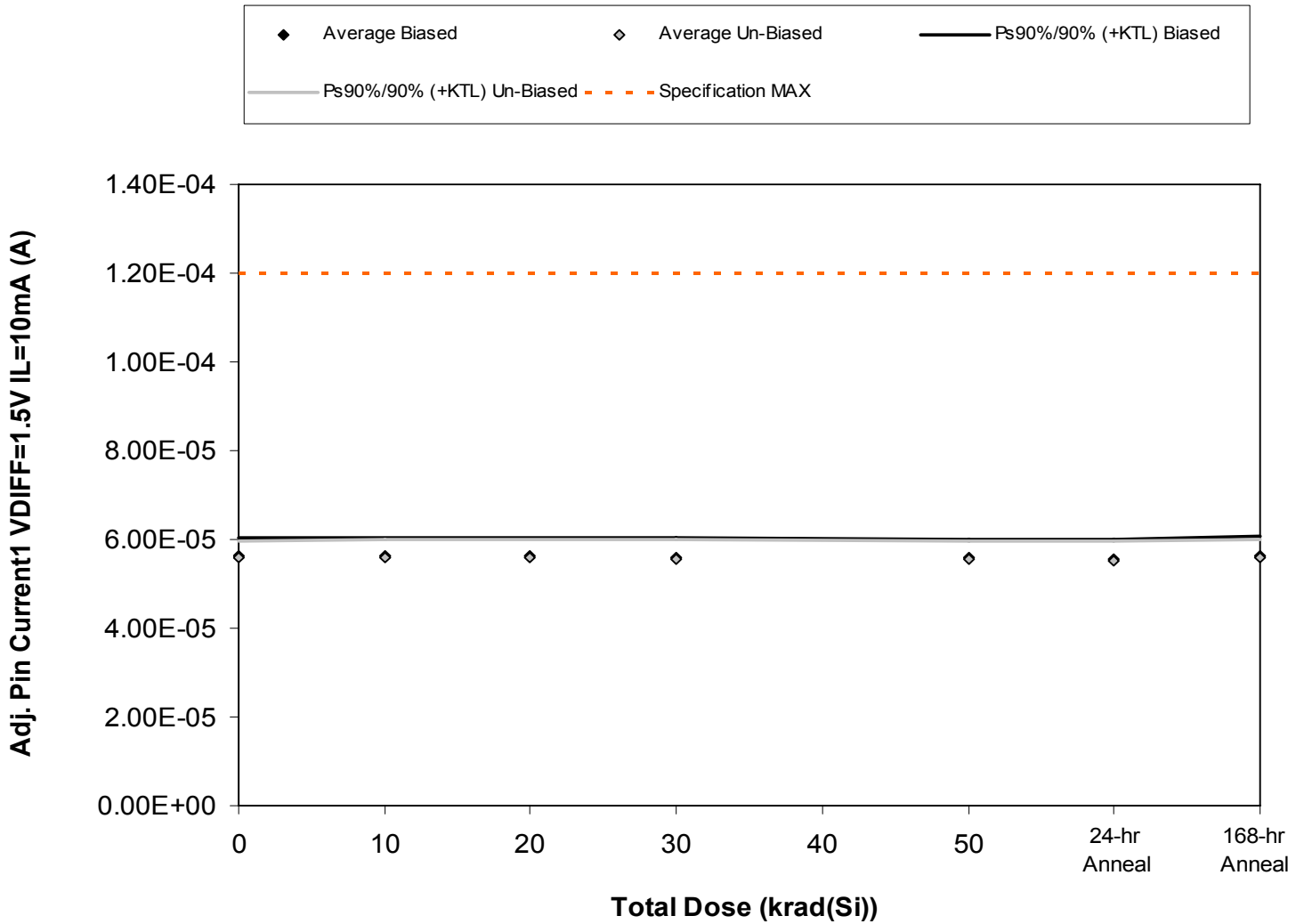

Figure 5.10. Plot of Adj. Pin Current1 VDIFF=1.5V IL=10mA (A) versus total dose. The solid diamonds are the average of the measured data points for the samples irradiated under electrical bias while the shaded diamonds are the average of the measured data points for the samples irradiated with all pins tied to ground. The black lines (solid and/or dashed) are the average of the data points after application of the KTL statistics on the samples irradiated under electrical bias while the gray lines (solid and/or dashed) are the average of the data points after application of the KTL statistics on the samples irradiated in the unbiased condition. The red dotted line(s) are the pre- and/or post-irradiation minimum and/or maximum specification value as defined in the datasheet and/or test plan.



**TID Test Report
10-118 100824 R1.1**

**Radiation Assured Devices
5017 N. 30th Street
Colorado Springs, CO 80919
(719) 531-0800**

Table 5.10. Raw data for Adj. Pin Current1 VDIFF=1.5V IL=10mA (A) versus total dose, including the statistical analysis, specification and the status of the testing (pass/fail).

Adj. Pin Current1 VDIFF=1.5V IL=10mA (A)	Total Dose (krad(Si))					24-hr Anneal	168-hr Anneal
	0	10	20	30	50		
Device							
35	5.78E-05	5.77E-05	5.77E-05	5.78E-05	5.76E-05	5.70E-05	5.80E-05
36	5.52E-05	5.52E-05	5.49E-05	5.49E-05	5.48E-05	5.45E-05	5.51E-05
37	5.60E-05	5.61E-05	5.57E-05	5.55E-05	5.57E-05	5.52E-05	5.56E-05
38	5.51E-05	5.46E-05	5.46E-05	5.45E-05	5.44E-05	5.39E-05	5.46E-05
39	5.81E-05	5.79E-05	5.77E-05	5.77E-05	5.76E-05	5.75E-05	5.81E-05
75	5.51E-05	5.49E-05	5.49E-05	5.47E-05	5.44E-05	5.43E-05	5.52E-05
76	5.51E-05	5.49E-05	5.47E-05	5.47E-05	5.44E-05	5.42E-05	5.50E-05
77	5.75E-05	5.75E-05	5.74E-05	5.74E-05	5.72E-05	5.70E-05	5.74E-05
78	5.76E-05	5.76E-05	5.74E-05	5.74E-05	5.70E-05	5.70E-05	5.79E-05
79	5.50E-05	5.46E-05	5.45E-05	5.43E-05	5.42E-05	5.42E-05	5.48E-05
142	5.80E-05	5.74E-05	5.76E-05	5.74E-05	5.76E-05	5.75E-05	5.80E-05
143	5.80E-05	5.78E-05	5.78E-05	5.77E-05	5.77E-05	5.79E-05	5.80E-05
Biased Statistics							
Average Biased	5.64E-05	5.63E-05	5.61E-05	5.61E-05	5.60E-05	5.56E-05	5.63E-05
Std Dev Biased	1.43E-06	1.47E-06	1.50E-06	1.57E-06	1.52E-06	1.57E-06	1.65E-06
Ps90%/90% (+KTL) Biased	6.03E-05	6.03E-05	6.02E-05	6.04E-05	6.02E-05	5.99E-05	6.08E-05
Ps90%/90% (-KTL) Biased	5.25E-05	5.23E-05	5.20E-05	5.18E-05	5.19E-05	5.13E-05	5.17E-05
Un-Biased Statistics							
Average Un-Biased	5.61E-05	5.59E-05	5.58E-05	5.57E-05	5.54E-05	5.53E-05	5.61E-05
Std Dev Un-Biased	1.36E-06	1.51E-06	1.49E-06	1.56E-06	1.52E-06	1.52E-06	1.47E-06
Ps90%/90% (+KTL) Un-Biased	5.98E-05	6.00E-05	5.99E-05	6.00E-05	5.96E-05	5.95E-05	6.01E-05
Ps90%/90% (-KTL) Un-Biased	5.23E-05	5.18E-05	5.17E-05	5.14E-05	5.13E-05	5.12E-05	5.20E-05
Specification MAX	1.20E-04	1.20E-04	1.20E-04	1.20E-04	1.20E-04	1.20E-04	1.20E-04
Status	PASS	PASS	PASS	PASS	PASS	N/A	N/A

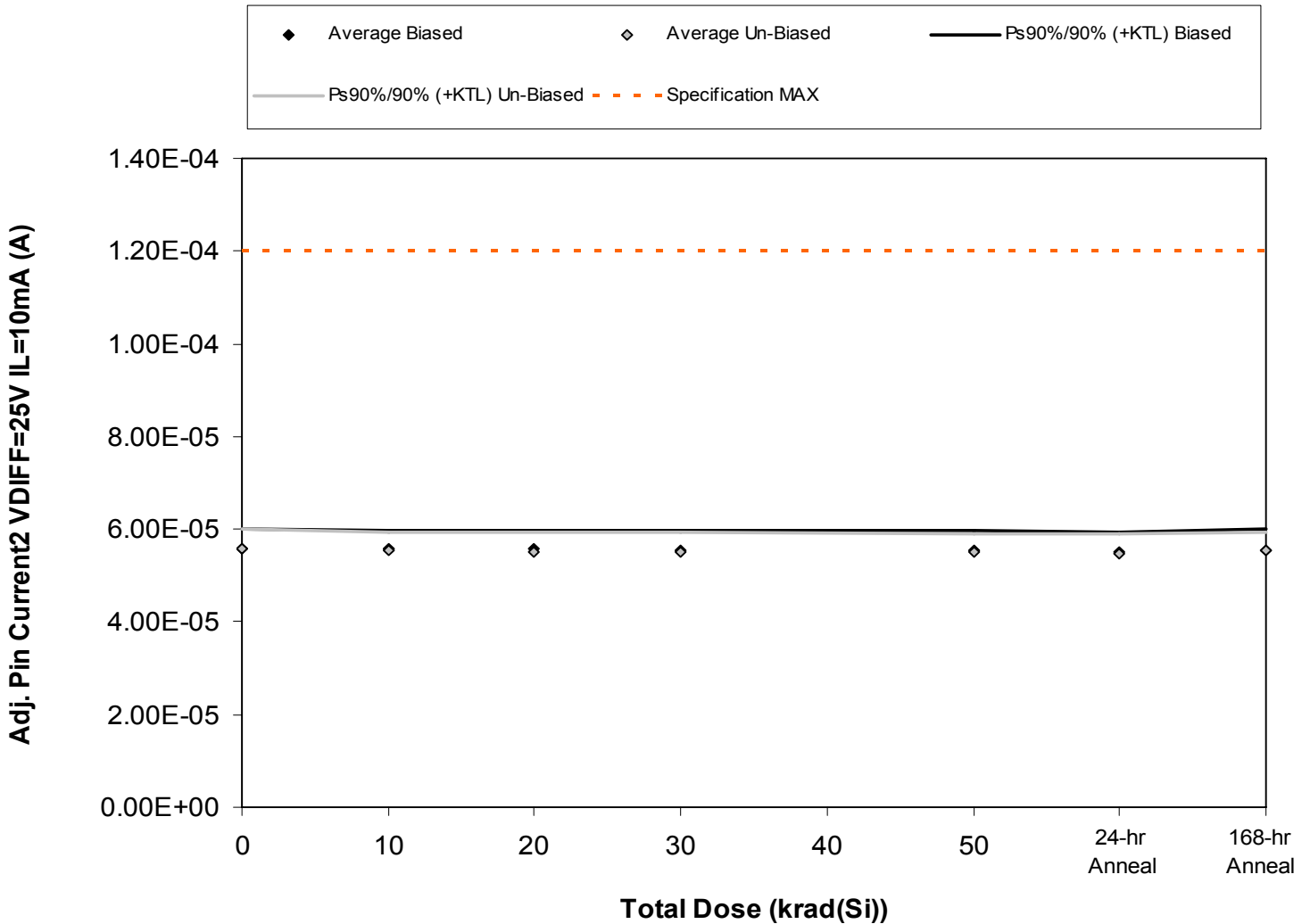

Figure 5.11. Plot of Adj. Pin Current2 VDIFF=25V IL=10mA (A) versus total dose. The solid diamonds are the average of the measured data points for the samples irradiated under electrical bias while the shaded diamonds are the average of the measured data points for the samples irradiated with all pins tied to ground. The black lines (solid and/or dashed) are the average of the data points after application of the KTL statistics on the samples irradiated under electrical bias while the gray lines (solid and/or dashed) are the average of the data points after application of the KTL statistics on the samples irradiated in the unbiased condition. The red dotted line(s) are the pre- and/or post-irradiation minimum and/or maximum specification value as defined in the datasheet and/or test plan.



**TID Test Report
10-118 100824 R1.1**

**Radiation Assured Devices
5017 N. 30th Street
Colorado Springs, CO 80919
(719) 531-0800**

Table 5.11. Raw data for Adj. Pin Current2 VDIFF=25V IL=10mA (A) versus total dose, including the statistical analysis, specification and the status of the testing (pass/fail).

Adj. Pin Current2 VDIFF=25V IL=10mA (A)	Total Dose (krad(Si))					24-hr Anneal	168-hr Anneal
	0	10	20	30	50		
Device							
35	5.68E-05	5.71E-05	5.71E-05	5.71E-05	5.70E-05	5.65E-05	5.71E-05
36	5.45E-05	5.47E-05	5.46E-05	5.44E-05	5.42E-05	5.39E-05	5.41E-05
37	5.52E-05	5.52E-05	5.52E-05	5.50E-05	5.51E-05	5.48E-05	5.52E-05
38	5.40E-05	5.40E-05	5.39E-05	5.40E-05	5.38E-05	5.33E-05	5.39E-05
39	5.79E-05	5.72E-05	5.74E-05	5.72E-05	5.72E-05	5.69E-05	5.73E-05
75	5.49E-05	5.43E-05	5.43E-05	5.42E-05	5.40E-05	5.38E-05	5.44E-05
76	5.47E-05	5.42E-05	5.41E-05	5.40E-05	5.38E-05	5.36E-05	5.42E-05
77	5.74E-05	5.69E-05	5.68E-05	5.67E-05	5.66E-05	5.64E-05	5.67E-05
78	5.76E-05	5.69E-05	5.67E-05	5.69E-05	5.64E-05	5.64E-05	5.71E-05
79	5.47E-05	5.40E-05	5.38E-05	5.37E-05	5.37E-05	5.36E-05	5.42E-05
142	5.71E-05	5.69E-05	5.69E-05	5.69E-05	5.70E-05	5.70E-05	5.72E-05
143	5.77E-05	5.73E-05	5.74E-05	5.73E-05	5.73E-05	5.74E-05	5.79E-05
Biased Statistics							
Average Biased	5.57E-05	5.56E-05	5.56E-05	5.55E-05	5.55E-05	5.51E-05	5.55E-05
Std Dev Biased	1.63E-06	1.44E-06	1.54E-06	1.51E-06	1.57E-06	1.58E-06	1.61E-06
Ps90%/90% (+KTL) Biased	6.01E-05	5.96E-05	5.99E-05	5.97E-05	5.98E-05	5.94E-05	5.99E-05
Ps90%/90% (-KTL) Biased	5.12E-05	5.17E-05	5.14E-05	5.14E-05	5.12E-05	5.08E-05	5.11E-05
Un-Biased Statistics							
Average Un-Biased	5.59E-05	5.53E-05	5.51E-05	5.51E-05	5.49E-05	5.48E-05	5.53E-05
Std Dev Un-Biased	1.50E-06	1.50E-06	1.48E-06	1.56E-06	1.47E-06	1.50E-06	1.45E-06
Ps90%/90% (+KTL) Un-Biased	6.00E-05	5.94E-05	5.92E-05	5.94E-05	5.89E-05	5.89E-05	5.93E-05
Ps90%/90% (-KTL) Un-Biased	5.17E-05	5.11E-05	5.11E-05	5.08E-05	5.09E-05	5.06E-05	5.13E-05
Specification MAX	1.20E-04	1.20E-04	1.20E-04	1.20E-04	1.20E-04	1.20E-04	1.20E-04
Status	PASS	PASS	PASS	PASS	PASS	N/A	N/A

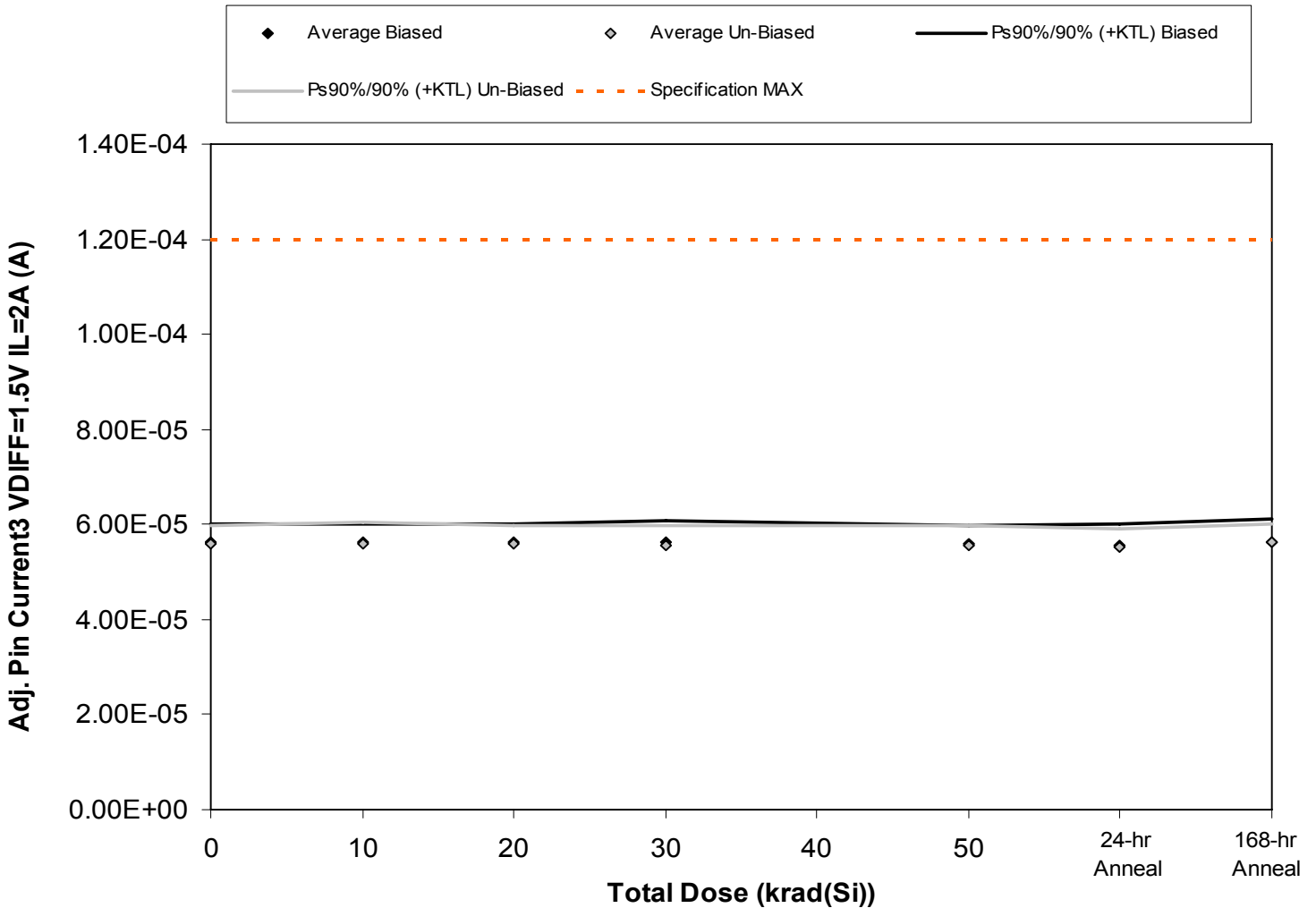

Figure 5.12. Plot of Adj. Pin Current3 VDIFF=1.5V IL=2A (A) versus total dose. The solid diamonds are the average of the measured data points for the samples irradiated under electrical bias while the shaded diamonds are the average of the measured data points for the samples irradiated with all pins tied to ground. The black lines (solid and/or dashed) are the average of the data points after application of the KTL statistics on the samples irradiated under electrical bias while the gray lines (solid and/or dashed) are the average of the data points after application of the KTL statistics on the samples irradiated in the unbiased condition. The red dotted line(s) are the pre- and/or post-irradiation minimum and/or maximum specification value as defined in the datasheet and/or test plan.



**TID Test Report
10-118 100824 R1.1**

**Radiation Assured Devices
5017 N. 30th Street
Colorado Springs, CO 80919
(719) 531-0800**

Table 5.12. Raw data for Adj. Pin Current3 VDIFF=1.5V IL=2A (A) versus total dose, including the statistical analysis, specification and the status of the testing (pass/fail).

Adj. Pin Current3 VDIFF=1.5V IL=2A (A)	Total Dose (krad(Si))					24-hr Anneal	168-hr Anneal
	0	10	20	30	50		
Device							
35	5.73E-05	5.78E-05	5.76E-05	5.78E-05	5.73E-05	5.68E-05	5.82E-05
36	5.52E-05	5.50E-05	5.51E-05	5.50E-05	5.49E-05	5.41E-05	5.45E-05
37	5.59E-05	5.63E-05	5.57E-05	5.57E-05	5.58E-05	5.49E-05	5.55E-05
38	5.46E-05	5.48E-05	5.46E-05	5.44E-05	5.44E-05	5.39E-05	5.44E-05
39	5.81E-05	5.77E-05	5.77E-05	5.80E-05	5.76E-05	5.77E-05	5.81E-05
75	5.52E-05	5.48E-05	5.50E-05	5.46E-05	5.43E-05	5.43E-05	5.51E-05
76	5.49E-05	5.49E-05	5.47E-05	5.49E-05	5.46E-05	5.43E-05	5.52E-05
77	5.74E-05	5.78E-05	5.72E-05	5.72E-05	5.72E-05	5.68E-05	5.79E-05
78	5.76E-05	5.75E-05	5.75E-05	5.73E-05	5.70E-05	5.69E-05	5.77E-05
79	5.49E-05	5.44E-05	5.45E-05	5.44E-05	5.41E-05	5.41E-05	5.51E-05
142	5.80E-05	5.74E-05	5.75E-05	5.74E-05	5.73E-05	5.77E-05	5.80E-05
143	5.77E-05	5.81E-05	5.75E-05	5.77E-05	5.77E-05	5.78E-05	5.79E-05
Biased Statistics							
Average Biased	5.62E-05	5.63E-05	5.61E-05	5.62E-05	5.60E-05	5.55E-05	5.61E-05
Std Dev Biased	1.45E-06	1.43E-06	1.43E-06	1.64E-06	1.42E-06	1.69E-06	1.88E-06
Ps90%/90% (+KTL) Biased	6.02E-05	6.02E-05	6.01E-05	6.07E-05	5.99E-05	6.01E-05	6.13E-05
Ps90%/90% (-KTL) Biased	5.22E-05	5.24E-05	5.22E-05	5.17E-05	5.21E-05	5.08E-05	5.10E-05
Un-Biased Statistics							
Average Un-Biased	5.60E-05	5.59E-05	5.58E-05	5.57E-05	5.54E-05	5.53E-05	5.62E-05
Std Dev Un-Biased	1.38E-06	1.63E-06	1.45E-06	1.44E-06	1.53E-06	1.44E-06	1.46E-06
Ps90%/90% (+KTL) Un-Biased	5.98E-05	6.03E-05	5.98E-05	5.96E-05	5.96E-05	5.92E-05	6.02E-05
Ps90%/90% (-KTL) Un-Biased	5.22E-05	5.14E-05	5.18E-05	5.17E-05	5.13E-05	5.13E-05	5.22E-05
Specification MAX	1.20E-04	1.20E-04	1.20E-04	1.20E-04	1.20E-04	1.20E-04	1.20E-04
Status	PASS	PASS	PASS	PASS	PASS	N/A	N/A

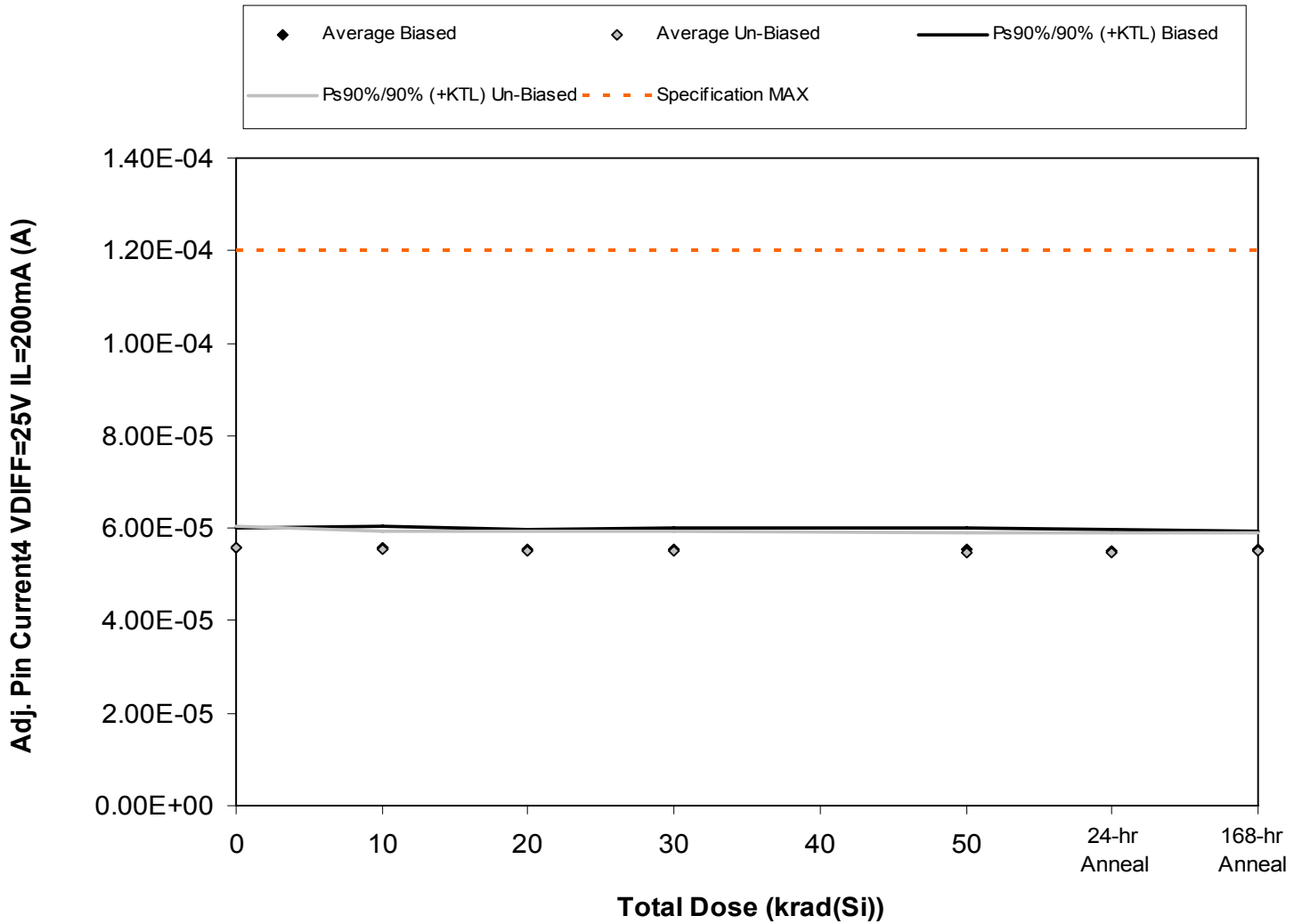

Figure 5.13. Plot of Adj. Pin Current₄ VDIFF=25V IL=200mA (A) versus total dose. The solid diamonds are the average of the measured data points for the samples irradiated under electrical bias while the shaded diamonds are the average of the measured data points for the samples irradiated with all pins tied to ground. The black lines (solid and/or dashed) are the average of the data points after application of the KTL statistics on the samples irradiated under electrical bias while the gray lines (solid and/or dashed) are the average of the data points after application of the KTL statistics on the samples irradiated in the unbiased condition. The red dotted line(s) are the pre- and/or post-irradiation minimum and/or maximum specification value as defined in the datasheet and/or test plan.



**TID Test Report
10-118 100824 R1.1**

**Radiation Assured Devices
5017 N. 30th Street
Colorado Springs, CO 80919
(719) 531-0800**

Table 5.13. Raw data for Adj. Pin Current₄ VDIFF=25V IL=200mA (A) versus total dose, including the statistical analysis, specification and the status of the testing (pass/fail).

Adj. Pin Current ₄ VDIFF=25V IL=200mA (A)	Total Dose (krad(Si))					24-hr Anneal	168-hr Anneal
	0	10	20	30	50		
Device							
35	5.66E-05	5.73E-05	5.68E-05	5.72E-05	5.71E-05	5.66E-05	5.67E-05
36	5.44E-05	5.46E-05	5.43E-05	5.43E-05	5.42E-05	5.34E-05	5.42E-05
37	5.53E-05	5.55E-05	5.47E-05	5.50E-05	5.51E-05	5.47E-05	5.52E-05
38	5.42E-05	5.40E-05	5.37E-05	5.37E-05	5.36E-05	5.32E-05	5.37E-05
39	5.81E-05	5.77E-05	5.73E-05	5.72E-05	5.72E-05	5.67E-05	5.71E-05
75	5.43E-05	5.43E-05	5.42E-05	5.44E-05	5.36E-05	5.39E-05	5.40E-05
76	5.49E-05	5.42E-05	5.41E-05	5.40E-05	5.37E-05	5.33E-05	5.44E-05
77	5.74E-05	5.67E-05	5.69E-05	5.67E-05	5.67E-05	5.63E-05	5.65E-05
78	5.76E-05	5.71E-05	5.68E-05	5.69E-05	5.63E-05	5.64E-05	5.70E-05
79	5.42E-05	5.40E-05	5.40E-05	5.35E-05	5.36E-05	5.38E-05	5.42E-05
142	5.72E-05	5.66E-05	5.68E-05	5.69E-05	5.69E-05	5.71E-05	5.73E-05
143	5.77E-05	5.73E-05	5.71E-05	5.76E-05	5.73E-05	5.78E-05	5.72E-05
Biased Statistics							
Average Biased	5.57E-05	5.58E-05	5.54E-05	5.55E-05	5.54E-05	5.49E-05	5.54E-05
Std Dev Biased	1.63E-06	1.63E-06	1.59E-06	1.64E-06	1.65E-06	1.68E-06	1.50E-06
Ps90%/90% (+KTL) Biased	6.02E-05	6.03E-05	5.97E-05	6.00E-05	6.00E-05	5.95E-05	5.95E-05
Ps90%/90% (-KTL) Biased	5.12E-05	5.14E-05	5.10E-05	5.10E-05	5.09E-05	5.03E-05	5.13E-05
Un-Biased Statistics							
Average Un-Biased	5.57E-05	5.53E-05	5.52E-05	5.51E-05	5.48E-05	5.47E-05	5.52E-05
Std Dev Un-Biased	1.68E-06	1.51E-06	1.51E-06	1.59E-06	1.58E-06	1.49E-06	1.41E-06
Ps90%/90% (+KTL) Un-Biased	6.03E-05	5.94E-05	5.93E-05	5.94E-05	5.91E-05	5.88E-05	5.91E-05
Ps90%/90% (-KTL) Un-Biased	5.11E-05	5.11E-05	5.11E-05	5.08E-05	5.05E-05	5.07E-05	5.13E-05
Specification MAX	1.20E-04	1.20E-04	1.20E-04	1.20E-04	1.20E-04	1.20E-04	1.20E-04
Status	PASS	PASS	PASS	PASS	PASS	N/A	N/A

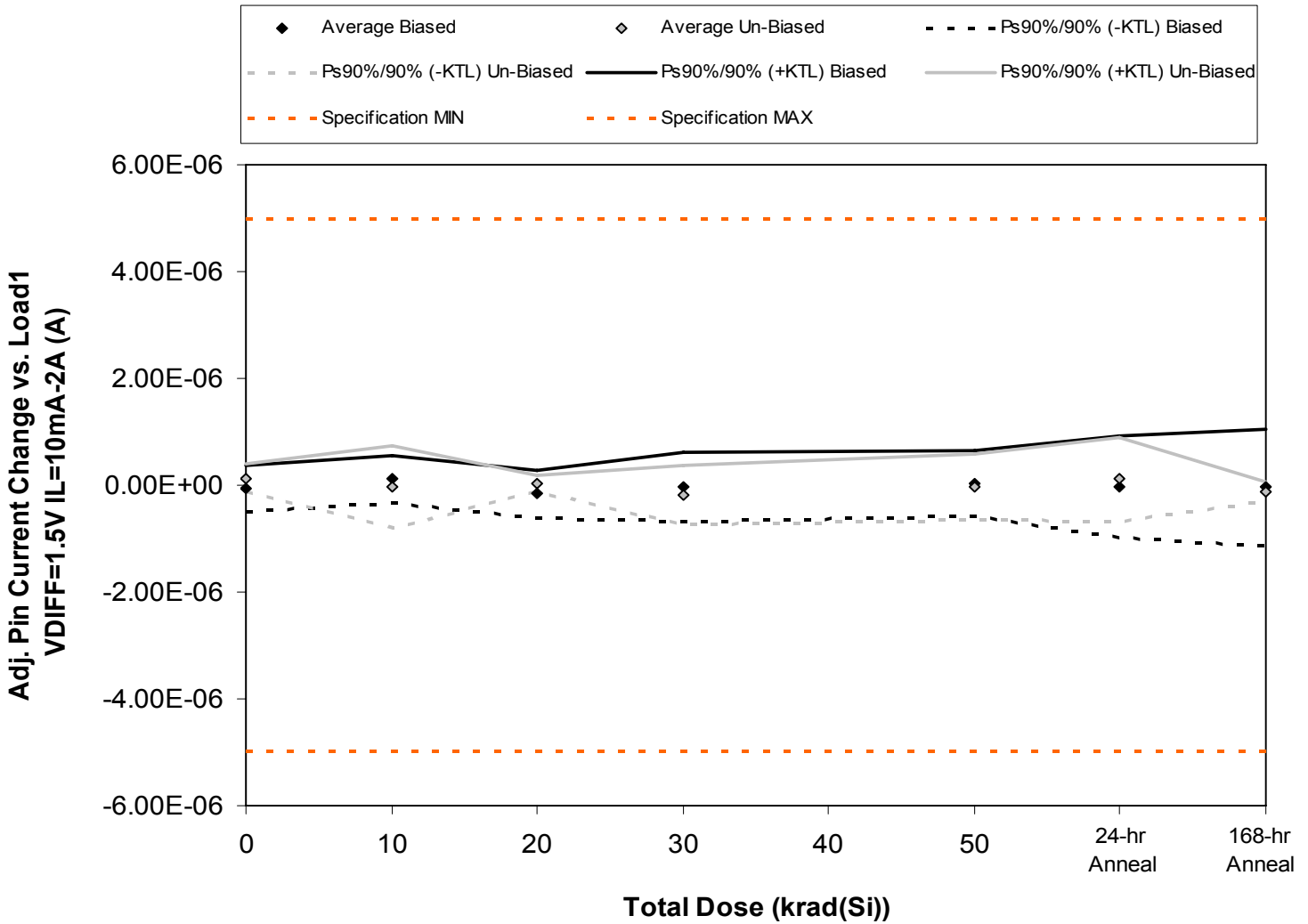

Figure 5.14. Plot of Adj. Pin Current Change vs. Load1 VDIFF=1.5V IL=10mA-2A (A) versus total dose. The solid diamonds are the average of the measured data points for the samples irradiated under electrical bias while the shaded diamonds are the average of the measured data points for the samples irradiated with all pins tied to ground. The black lines (solid and/or dashed) are the average of the data points after application of the KTL statistics on the samples irradiated under electrical bias while the gray lines (solid and/or dashed) are the average of the data points after application of the KTL statistics on the samples irradiated in the unbiased condition. The red dotted line(s) are the pre- and/or post-irradiation minimum and/or maximum specification value as defined in the datasheet and/or test plan.



**TID Test Report
10-118 100824 R1.1**

**Radiation Assured Devices
5017 N. 30th Street
Colorado Springs, CO 80919
(719) 531-0800**

Table 5.14. Raw data for Adj. Pin Current Change vs. Load1 VDIFF=1.5V IL=10mA-2A (A) versus total dose, including the statistical analysis, specification and the status of the testing (pass/fail).

Adj. Pin Current Change vs. Load1 VDIFF=1.5V IL=10mA-2A (A)	Total Dose (krad(Si))					24-hr Anneal	168-hr Anneal
	0	10	20	30	50		
Device							
35	-2.90E-07	-1.50E-07	-7.00E-08	-2.50E-07	-1.50E-07	-3.80E-07	-5.10E-07
36	-1.10E-07	9.00E-08	-2.40E-07	0.00E+00	0.00E+00	4.70E-07	-3.60E-07
37	-7.00E-08	2.70E-07	-4.20E-07	-2.40E-07	1.50E-07	7.00E-08	2.40E-07
38	0.00E+00	2.00E-07	-2.00E-08	0.00E+00	-2.00E-07	0.00E+00	4.40E-07
39	1.50E-07	1.30E-07	-7.00E-08	3.40E-07	3.60E-07	-3.40E-07	0.00E+00
75	1.50E-07	9.00E-08	9.00E-08	-1.30E-07	-3.10E-07	3.10E-07	0.00E+00
76	1.80E-07	-2.20E-07	9.00E-08	-3.60E-07	-2.00E-08	-5.00E-08	-1.50E-07
77	2.50E-07	-1.80E-07	0.00E+00	9.00E-08	-1.60E-07	1.30E-07	-1.50E-07
78	7.00E-08	-2.70E-07	0.00E+00	-1.50E-07	1.50E-07	-2.90E-07	-1.50E-07
79	0.00E+00	4.00E-07	-4.00E-08	-4.20E-07	2.40E-07	4.40E-07	-1.50E-07
142	0.00E+00	-1.30E-07	4.00E-08	0.00E+00	1.10E-07	1.10E-07	0.00E+00
143	2.40E-07	1.30E-07	9.00E-08	1.10E-07	9.00E-08	0.00E+00	0.00E+00
Biased Statistics							
Average Biased	-6.40E-08	1.08E-07	-1.64E-07	-3.00E-08	3.20E-08	-3.60E-08	-3.80E-08
Std Dev Biased	1.61E-07	1.60E-07	1.66E-07	2.40E-07	2.29E-07	3.46E-07	3.98E-07
Ps90%/90% (+KTL) Biased	3.76E-07	5.46E-07	2.90E-07	6.29E-07	6.59E-07	9.13E-07	1.05E-06
Ps90%/90% (-KTL) Biased	-5.04E-07	-3.30E-07	-6.18E-07	-6.89E-07	-5.95E-07	-9.85E-07	-1.13E-06
Un-Biased Statistics							
Average Un-Biased	1.30E-07	-3.60E-08	2.80E-08	-1.94E-07	-2.00E-08	1.08E-07	-1.20E-07
Std Dev Un-Biased	9.72E-08	2.81E-07	5.89E-08	2.03E-07	2.24E-07	2.89E-07	6.71E-08
Ps90%/90% (+KTL) Un-Biased	3.97E-07	7.34E-07	1.90E-07	3.63E-07	5.93E-07	9.01E-07	6.39E-08
Ps90%/90% (-KTL) Un-Biased	-1.37E-07	-8.06E-07	-1.34E-07	-7.51E-07	-6.33E-07	-6.85E-07	-3.04E-07
Specification MIN	-5.00E-06	-5.00E-06	-5.00E-06	-5.00E-06	-5.00E-06	-5.00E-06	-5.00E-06
Status	PASS	PASS	PASS	PASS	PASS	N/A	N/A
Specification MAX	5.00E-06	5.00E-06	5.00E-06	5.00E-06	5.00E-06	5.00E-06	5.00E-06
Status	PASS	PASS	PASS	PASS	PASS	N/A	N/A

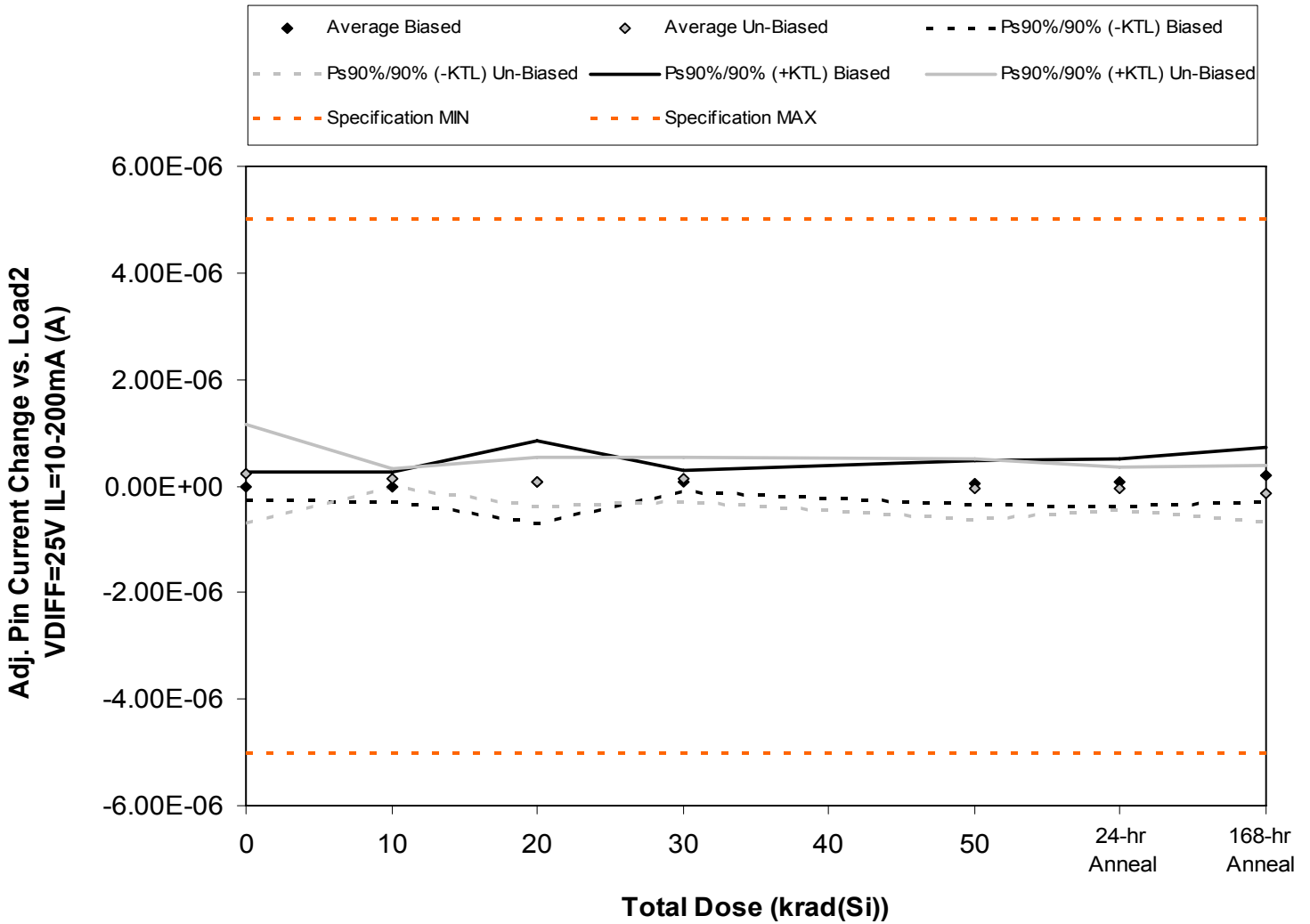

Figure 5.15. Plot of Adj. Pin Current Change vs. Load2 VDIFF=25V IL=10-200mA (A) versus total dose. The solid diamonds are the average of the measured data points for the samples irradiated under electrical bias while the shaded diamonds are the average of the measured data points for the samples irradiated with all pins tied to ground. The black lines (solid and/or dashed) are the average of the data points after application of the KTL statistics on the samples irradiated under electrical bias while the gray lines (solid and/or dashed) are the average of the data points after application of the KTL statistics on the samples irradiated in the unbiased condition. The red dotted line(s) are the pre- and/or post-irradiation minimum and/or maximum specification value as defined in the datasheet and/or test plan.



**TID Test Report
10-118 100824 R1.1**

**Radiation Assured Devices
5017 N. 30th Street
Colorado Springs, CO 80919
(719) 531-0800**

Table 5.15. Raw data for Adj. Pin Current Change vs. Load2 VDIFF=25V IL=10-200mA (A) versus total dose, including the statistical analysis, specification and the status of the testing (pass/fail).

Adj. Pin Current Change vs. Load2 VDIFF=25V IL=10-200mA (A)	Total Dose (krad(Si))					24-hr Anneal	168-hr Anneal
	0	10	20	30	50		
Device							
35	-4.00E-08	9.00E-08	2.20E-07	5.00E-08	-4.00E-08	1.80E-07	1.10E-07
36	-7.00E-08	0.00E+00	-3.30E-07	7.00E-08	3.10E-07	-1.80E-07	4.70E-07
37	1.10E-07	5.00E-08	2.40E-07	0.00E+00	-5.00E-08	2.00E-08	0.00E+00
38	9.00E-08	-1.80E-07	-9.00E-08	1.80E-07	7.00E-08	5.00E-08	1.60E-07
39	-1.10E-07	-4.00E-08	3.60E-07	1.50E-07	-2.00E-08	2.50E-07	3.30E-07
75	0.00E+00	2.20E-07	2.00E-08	-1.10E-07	-3.30E-07	-2.00E-08	7.00E-08
76	0.00E+00	7.00E-08	1.60E-07	2.20E-07	7.00E-08	-5.00E-08	-2.90E-07
77	0.00E+00	2.00E-07	7.00E-08	9.00E-08	-9.00E-08	-1.60E-07	-2.50E-07
78	7.30E-07	1.50E-07	3.10E-07	2.40E-07	2.20E-07	-2.20E-07	9.00E-08
79	4.40E-07	1.10E-07	-1.50E-07	2.40E-07	-1.60E-07	1.60E-07	-2.70E-07
142	0.00E+00	3.80E-07	-1.30E-07	1.80E-07	4.00E-08	9.00E-08	-1.30E-07
143	-1.10E-07	-7.00E-08	1.10E-07	1.50E-07	5.00E-08	-5.40E-07	4.20E-07
Biased Statistics							
Average Biased	-4.00E-09	-1.60E-08	8.00E-08	9.00E-08	5.40E-08	6.40E-08	2.14E-07
Std Dev Biased	9.84E-08	1.04E-07	2.83E-07	7.38E-08	1.51E-07	1.66E-07	1.86E-07
Ps90%/90% (+KTL) Biased	2.66E-07	2.69E-07	8.56E-07	2.92E-07	4.67E-07	5.18E-07	7.24E-07
Ps90%/90% (-KTL) Biased	-2.74E-07	-3.01E-07	-6.96E-07	-1.12E-07	-3.59E-07	-3.90E-07	-2.96E-07
Un-Biased Statistics							
Average Un-Biased	2.34E-07	1.50E-07	8.20E-08	1.36E-07	-5.80E-08	-5.80E-08	-1.30E-07
Std Dev Un-Biased	3.36E-07	6.20E-08	1.70E-07	1.51E-07	2.12E-07	1.46E-07	1.92E-07
Ps90%/90% (+KTL) Un-Biased	1.16E-06	3.20E-07	5.49E-07	5.50E-07	5.22E-07	3.43E-07	3.97E-07
Ps90%/90% (-KTL) Un-Biased	-6.88E-07	-2.01E-08	-3.85E-07	-2.78E-07	-6.38E-07	-4.59E-07	-6.57E-07
Specification MIN	-5.00E-06	-5.00E-06	-5.00E-06	-5.00E-06	-5.00E-06	-5.00E-06	-5.00E-06
Status	PASS	PASS	PASS	PASS	PASS	N/A	N/A
Specification MAX	5.00E-06	5.00E-06	5.00E-06	5.00E-06	5.00E-06	5.00E-06	5.00E-06
Status	PASS	PASS	PASS	PASS	PASS	N/A	N/A

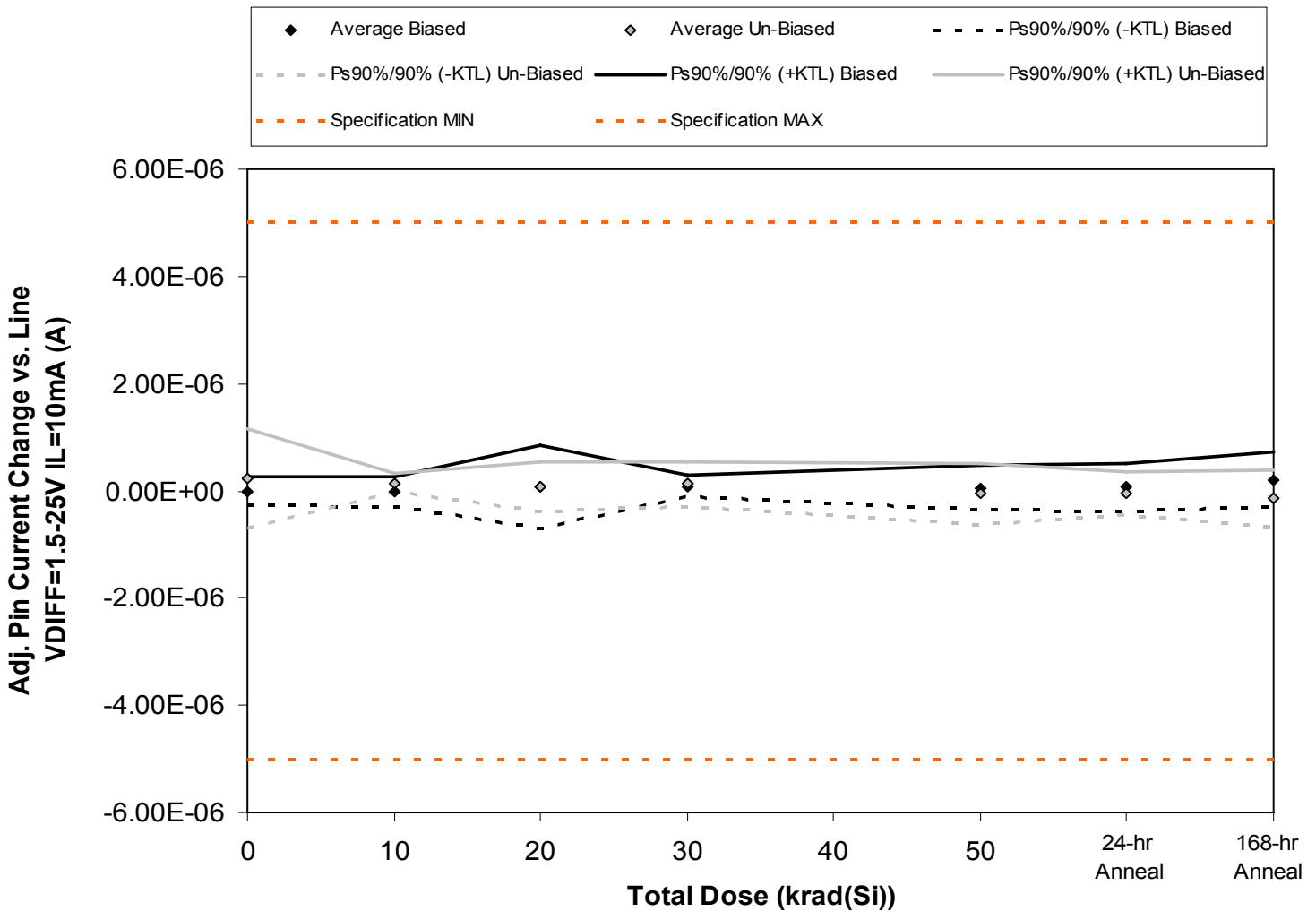

Figure 5.16. Plot of Adj. Pin Current Change vs. Line VDIFF=1.5-25V IL=10mA (A) versus total dose. The solid diamonds are the average of the measured data points for the samples irradiated under electrical bias while the shaded diamonds are the average of the measured data points for the samples irradiated with all pins tied to ground. The black lines (solid and/or dashed) are the average of the data points after application of the KTL statistics on the samples irradiated under electrical bias while the gray lines (solid and/or dashed) are the average of the data points after application of the KTL statistics on the samples irradiated in the unbiased condition. The red dotted line(s) are the pre- and/or post-irradiation minimum and/or maximum specification value as defined in the datasheet and/or test plan.



**TID Test Report
10-118 100824 R1.1**

**Radiation Assured Devices
5017 N. 30th Street
Colorado Springs, CO 80919
(719) 531-0800**

Table 5.16. Raw data for Adj. Pin Current Change vs. Line VDIFF=1.5-25V IL=10mA (A) versus total dose, including the statistical analysis, specification and the status of the testing (pass/fail).

Adj. Pin Current Change vs. Line VDIFF=1.5-25V IL=10mA (A)	Total Dose (krad(Si))					24-hr Anneal	168-hr Anneal
	0	10	20	30	50		
Device							
35	-4.00E-08	9.00E-08	2.20E-07	5.00E-08	-4.00E-08	1.80E-07	1.10E-07
36	-7.00E-08	0.00E+00	-3.30E-07	7.00E-08	3.10E-07	-1.80E-07	4.70E-07
37	1.10E-07	5.00E-08	2.40E-07	0.00E+00	-5.00E-08	2.00E-08	0.00E+00
38	9.00E-08	-1.80E-07	-9.00E-08	1.80E-07	7.00E-08	5.00E-08	1.60E-07
39	-1.10E-07	-4.00E-08	3.60E-07	1.50E-07	-2.00E-08	2.50E-07	3.30E-07
75	0.00E+00	2.20E-07	2.00E-08	-1.10E-07	-3.30E-07	-2.00E-08	7.00E-08
76	0.00E+00	7.00E-08	1.60E-07	2.20E-07	7.00E-08	-5.00E-08	-2.90E-07
77	0.00E+00	2.00E-07	7.00E-08	9.00E-08	-9.00E-08	-1.60E-07	-2.50E-07
78	7.30E-07	1.50E-07	3.10E-07	2.40E-07	2.20E-07	-2.20E-07	9.00E-08
79	4.40E-07	1.10E-07	-1.50E-07	2.40E-07	-1.60E-07	1.60E-07	-2.70E-07
142	0.00E+00	3.80E-07	-1.30E-07	1.80E-07	4.00E-08	9.00E-08	-1.30E-07
143	-1.10E-07	-7.00E-08	1.10E-07	1.50E-07	5.00E-08	-5.40E-07	4.20E-07
Biased Statistics							
Average Biased	-4.00E-09	-1.60E-08	8.00E-08	9.00E-08	5.40E-08	6.40E-08	2.14E-07
Std Dev Biased	9.84E-08	1.04E-07	2.83E-07	7.38E-08	1.51E-07	1.66E-07	1.86E-07
Ps90%/90% (+KTL) Biased	2.66E-07	2.69E-07	8.56E-07	2.92E-07	4.67E-07	5.18E-07	7.24E-07
Ps90%/90% (-KTL) Biased	-2.74E-07	-3.01E-07	-6.96E-07	-1.12E-07	-3.59E-07	-3.90E-07	-2.96E-07
Un-Biased Statistics							
Average Un-Biased	2.34E-07	1.50E-07	8.20E-08	1.36E-07	-5.80E-08	-5.80E-08	-1.30E-07
Std Dev Un-Biased	3.36E-07	6.20E-08	1.70E-07	1.51E-07	2.12E-07	1.46E-07	1.92E-07
Ps90%/90% (+KTL) Un-Biased	1.16E-06	3.20E-07	5.49E-07	5.50E-07	5.22E-07	3.43E-07	3.97E-07
Ps90%/90% (-KTL) Un-Biased	-6.88E-07	-2.01E-08	-3.85E-07	-2.78E-07	-6.38E-07	-4.59E-07	-6.57E-07
Specification MIN	-5.00E-06	-5.00E-06	-5.00E-06	-5.00E-06	-5.00E-06	-5.00E-06	-5.00E-06
Status	PASS	PASS	PASS	PASS	PASS	N/A	N/A
Specification MAX	5.00E-06	5.00E-06	5.00E-06	5.00E-06	5.00E-06	5.00E-06	5.00E-06
Status	PASS	PASS	PASS	PASS	PASS	N/A	N/A

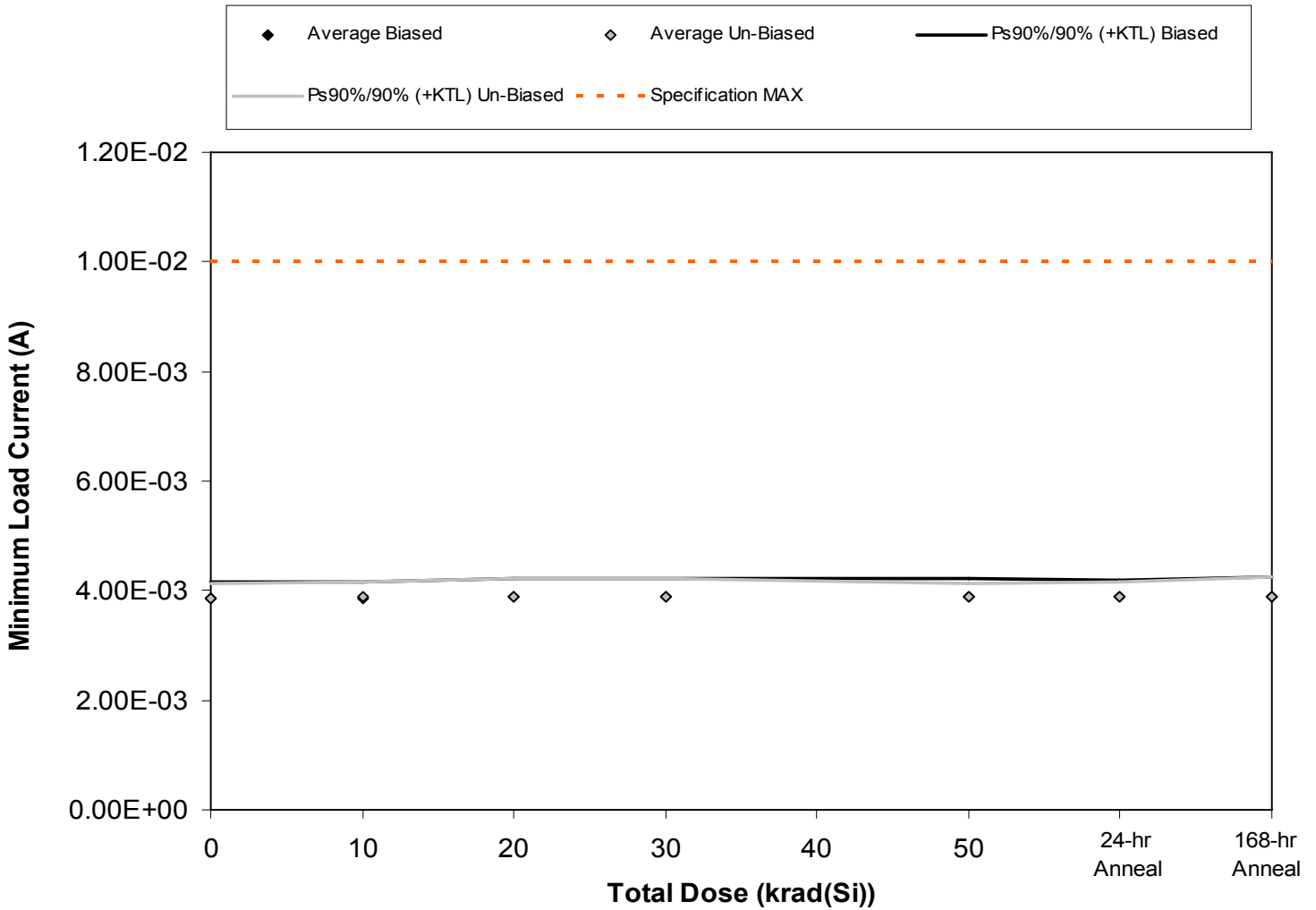

Figure 5.17. Plot of Minimum Load Current (A) versus total dose. The solid diamonds are the average of the measured data points for the samples irradiated under electrical bias while the shaded diamonds are the average of the measured data points for the samples irradiated with all pins tied to ground. The black lines (solid and/or dashed) are the average of the data points after application of the KTL statistics on the samples irradiated under electrical bias while the gray lines (solid and/or dashed) are the average of the data points after application of the KTL statistics on the samples irradiated in the unbiased condition. The red dotted line(s) are the pre- and/or post-irradiation minimum and/or maximum specification value as defined in the datasheet and/or test plan.



**TID Test Report
10-118 100824 R1.1**

**Radiation Assured Devices
5017 N. 30th Street
Colorado Springs, CO 80919
(719) 531-0800**

Table 5.17. Raw data for Minimum Load Current (A) versus total dose, including the statistical analysis, specification and the status of the testing (pass/fail).

Minimum Load Current (A)	Total Dose (krad(Si))					24-hr Anneal	168-hr Anneal
	0	10	20	30	50		
Device							
35	3.99E-03	3.99E-03	4.03E-03	4.03E-03	4.03E-03	4.03E-03	4.04E-03
36	3.77E-03	3.78E-03	3.82E-03	3.80E-03	3.80E-03	3.80E-03	3.81E-03
37	3.82E-03	3.83E-03	3.86E-03	3.86E-03	3.86E-03	3.86E-03	3.86E-03
38	3.78E-03	3.75E-03	3.75E-03	3.74E-03	3.74E-03	3.78E-03	3.74E-03
39	3.96E-03	3.96E-03	4.01E-03	4.00E-03	4.00E-03	4.00E-03	4.01E-03
75	3.78E-03	3.79E-03	3.83E-03	3.82E-03	3.83E-03	3.83E-03	3.79E-03
76	3.81E-03	3.82E-03	3.78E-03	3.78E-03	3.82E-03	3.78E-03	3.78E-03
77	3.96E-03	4.00E-03	4.00E-03	4.00E-03	3.96E-03	3.96E-03	4.00E-03
78	3.99E-03	3.99E-03	4.03E-03	4.03E-03	4.00E-03	4.01E-03	4.04E-03
79	3.81E-03	3.81E-03	3.77E-03	3.77E-03	3.82E-03	3.82E-03	3.77E-03
142	3.95E-03	3.95E-03	3.95E-03	3.95E-03	3.95E-03	3.95E-03	3.95E-03
143	4.01E-03	3.98E-03	4.02E-03	4.02E-03	4.02E-03	4.02E-03	4.01E-03
Biased Statistics							
Average Biased	3.86E-03	3.86E-03	3.89E-03	3.89E-03	3.89E-03	3.89E-03	3.89E-03
Std Dev Biased	1.05E-04	1.10E-04	1.23E-04	1.25E-04	1.24E-04	1.12E-04	1.26E-04
Ps90%/90% (+KTL) Biased	4.15E-03	4.16E-03	4.23E-03	4.23E-03	4.23E-03	4.20E-03	4.24E-03
Ps90%/90% (-KTL) Biased	3.58E-03	3.56E-03	3.56E-03	3.54E-03	3.54E-03	3.59E-03	3.55E-03
Un-Biased Statistics							
Average Un-Biased	3.87E-03	3.88E-03	3.88E-03	3.88E-03	3.88E-03	3.88E-03	3.87E-03
Std Dev Un-Biased	9.72E-05	1.03E-04	1.25E-04	1.26E-04	9.01E-05	9.85E-05	1.32E-04
Ps90%/90% (+KTL) Un-Biased	4.14E-03	4.17E-03	4.22E-03	4.23E-03	4.13E-03	4.15E-03	4.24E-03
Ps90%/90% (-KTL) Un-Biased	3.60E-03	3.60E-03	3.54E-03	3.54E-03	3.64E-03	3.61E-03	3.51E-03
Specification MAX	1.00E-02	1.00E-02	1.00E-02	1.00E-02	1.00E-02	1.00E-02	1.00E-02
Status	PASS	PASS	PASS	PASS	PASS	N/A	N/A

An ISO 9001:2008 and DSCC Certified Company

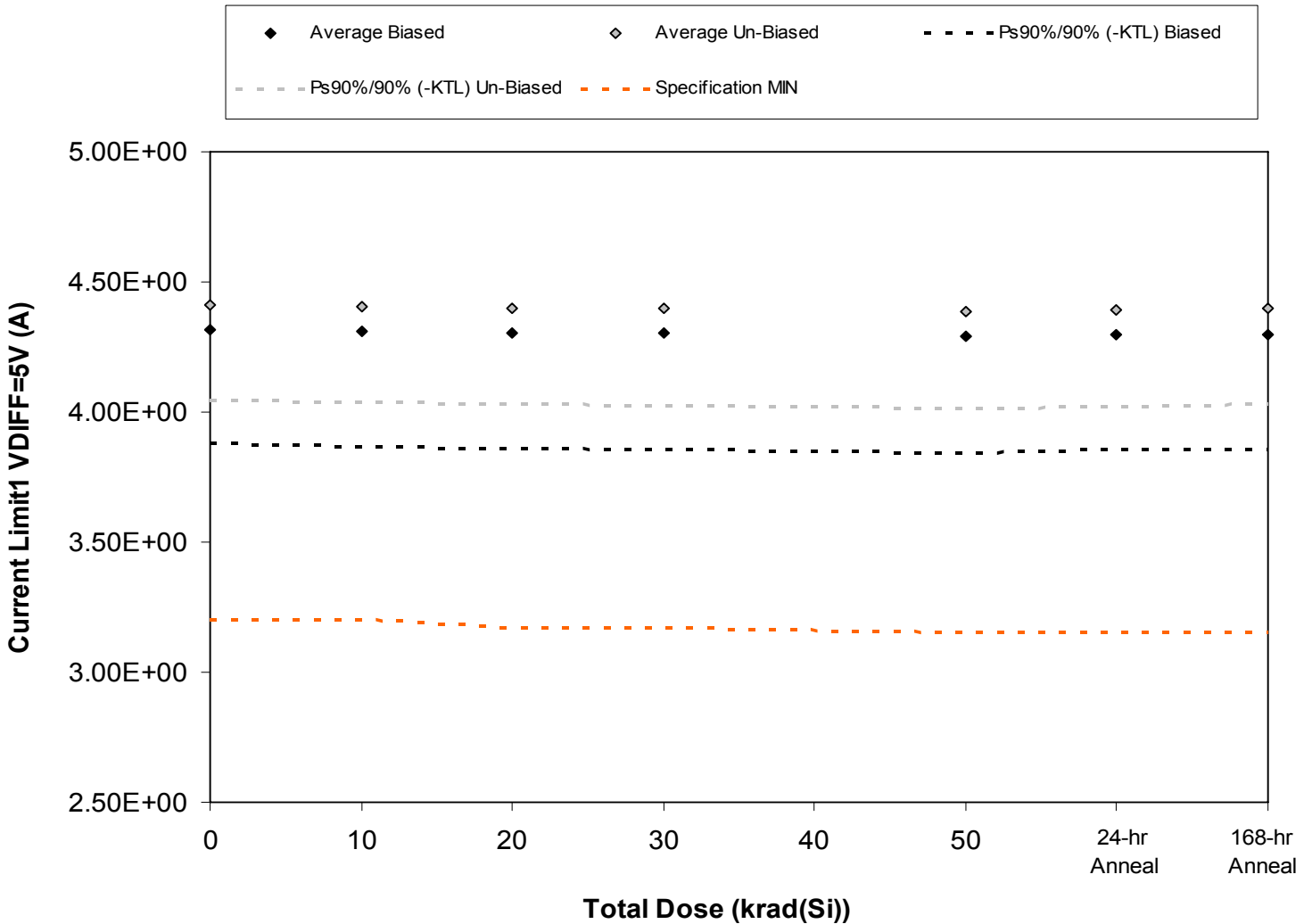

Figure 5.18. Plot of Current Limit1 VDIFF=5V (A) versus total dose. The solid diamonds are the average of the measured data points for the samples irradiated under electrical bias while the shaded diamonds are the average of the measured data points for the samples irradiated with all pins tied to ground. The black lines (solid and/or dashed) are the average of the data points after application of the KTL statistics on the samples irradiated under electrical bias while the gray lines (solid and/or dashed) are the average of the data points after application of the KTL statistics on the samples irradiated in the unbiased condition. The red dotted line(s) are the pre- and/or post-irradiation minimum and/or maximum specification value as defined in the datasheet and/or test plan.



Table 5.18. Raw data for Current Limit1 VDIFF=5V (A) versus total dose, including the statistical analysis, specification and the status of the testing (pass/fail).

Current Limit1 VDIFF=5V (A)	Total Dose (krad(Si))					24-hr Anneal	168-hr Anneal
	0	10	20	30	50		
Device							
35	4.39E+00	4.38E+00	4.38E+00	4.38E+00	4.37E+00	4.38E+00	4.37E+00
36	4.21E+00	4.20E+00	4.20E+00	4.19E+00	4.18E+00	4.19E+00	4.19E+00
37	4.20E+00	4.19E+00	4.19E+00	4.19E+00	4.18E+00	4.19E+00	4.19E+00
38	4.21E+00	4.21E+00	4.20E+00	4.20E+00	4.19E+00	4.19E+00	4.20E+00
39	4.57E+00	4.56E+00	4.56E+00	4.55E+00	4.55E+00	4.55E+00	4.55E+00
75	4.31E+00	4.30E+00	4.30E+00	4.29E+00	4.28E+00	4.29E+00	4.30E+00
76	4.37E+00	4.36E+00	4.36E+00	4.35E+00	4.34E+00	4.35E+00	4.36E+00
77	4.64E+00	4.64E+00	4.64E+00	4.63E+00	4.62E+00	4.63E+00	4.64E+00
78	4.34E+00	4.34E+00	4.34E+00	4.34E+00	4.33E+00	4.33E+00	4.34E+00
79	4.39E+00	4.38E+00	4.38E+00	4.37E+00	4.36E+00	4.36E+00	4.38E+00
142	4.32E+00	4.32E+00	4.32E+00	4.32E+00	4.32E+00	4.32E+00	4.32E+00
143	4.29E+00	4.29E+00	4.29E+00	4.29E+00	4.29E+00	4.29E+00	4.28E+00
Biased Statistics							
Average Biased	4.32E+00	4.31E+00	4.30E+00	4.30E+00	4.29E+00	4.30E+00	4.30E+00
Std Dev Biased	1.59E-01	1.61E-01	1.61E-01	1.62E-01	1.64E-01	1.63E-01	1.62E-01
Ps90%/90% (+KTL) Biased	4.75E+00	4.75E+00	4.75E+00	4.74E+00	4.74E+00	4.75E+00	4.74E+00
Ps90%/90% (-KTL) Biased	3.88E+00	3.87E+00	3.86E+00	3.86E+00	3.84E+00	3.85E+00	3.86E+00
Un-Biased Statistics							
Average Un-Biased	4.41E+00	4.41E+00	4.40E+00	4.40E+00	4.39E+00	4.39E+00	4.40E+00
Std Dev Un-Biased	1.34E-01	1.35E-01	1.35E-01	1.35E-01	1.36E-01	1.36E-01	1.36E-01
Ps90%/90% (+KTL) Un-Biased	4.78E+00	4.78E+00	4.77E+00	4.77E+00	4.76E+00	4.76E+00	4.77E+00
Ps90%/90% (-KTL) Un-Biased	4.04E+00	4.04E+00	4.03E+00	4.03E+00	4.02E+00	4.02E+00	4.03E+00
Specification MIN	3.20E+00	3.20E+00	3.17E+00	3.17E+00	3.15E+00	3.15E+00	3.15E+00
Status	PASS	PASS	PASS	PASS	PASS	N/A	N/A

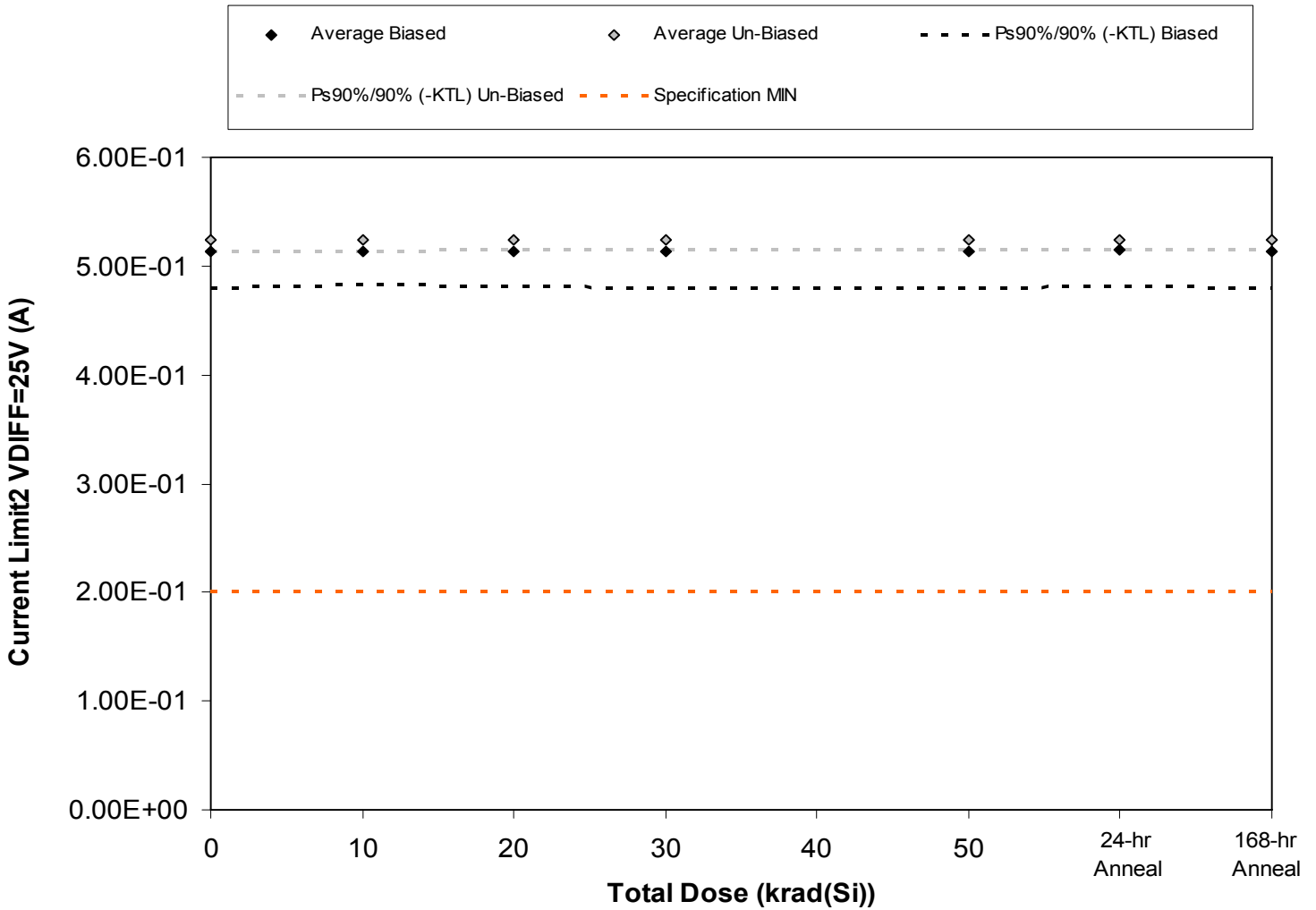

Figure 5.19. Plot of Current Limit2 VDIFF=25V (A) versus total dose. The solid diamonds are the average of the measured data points for the samples irradiated under electrical bias while the shaded diamonds are the average of the measured data points for the samples irradiated with all pins tied to ground. The black lines (solid and/or dashed) are the average of the data points after application of the KTL statistics on the samples irradiated under electrical bias while the gray lines (solid and/or dashed) are the average of the data points after application of the KTL statistics on the samples irradiated in the unbiased condition. The red dotted line(s) are the pre- and/or post-irradiation minimum and/or maximum specification value as defined in the datasheet and/or test plan.



**TID Test Report
10-118 100824 R1.1**

**Radiation Assured Devices
5017 N. 30th Street
Colorado Springs, CO 80919
(719) 531-0800**

Table 5.19. Raw data for Current Limit2 VDIFF=25V (A) versus total dose, including the statistical analysis, specification and the status of the testing (pass/fail).

Current Limit2 VDIFF=25V (A)	Total Dose (krad(Si))					24-hr Anneal	168-hr Anneal
	0	10	20	30	50		
Device							
35	5.32E-01	5.30E-01	5.32E-01	5.32E-01	5.32E-01	5.35E-01	5.32E-01
36	5.00E-01	5.00E-01	5.00E-01	5.00E-01	5.00E-01	5.03E-01	5.00E-01
37	5.10E-01	5.10E-01	5.10E-01	5.10E-01	5.10E-01	5.10E-01	5.10E-01
38	5.08E-01	5.10E-01	5.10E-01	5.08E-01	5.08E-01	5.10E-01	5.08E-01
39	5.18E-01	5.15E-01	5.15E-01	5.15E-01	5.15E-01	5.18E-01	5.15E-01
75	5.22E-01	5.22E-01	5.22E-01	5.22E-01	5.22E-01	5.22E-01	5.22E-01
76	5.30E-01	5.30E-01	5.27E-01	5.27E-01	5.27E-01	5.27E-01	5.27E-01
77	5.25E-01	5.27E-01	5.27E-01	5.27E-01	5.27E-01	5.27E-01	5.27E-01
78	5.20E-01	5.20E-01	5.20E-01	5.20E-01	5.20E-01	5.20E-01	5.20E-01
79	5.25E-01	5.25E-01	5.27E-01	5.25E-01	5.25E-01	5.25E-01	5.25E-01
142	5.25E-01	5.25E-01	5.25E-01	5.25E-01	5.25E-01	5.27E-01	5.22E-01
143	5.27E-01	5.27E-01	5.30E-01	5.27E-01	5.27E-01	5.27E-01	5.27E-01
Biased Statistics							
Average Biased	5.14E-01	5.13E-01	5.13E-01	5.13E-01	5.13E-01	5.15E-01	5.13E-01
Std Dev Biased	1.21E-02	1.10E-02	1.17E-02	1.19E-02	1.19E-02	1.23E-02	1.19E-02
Ps90%/90% (+KTL) Biased	5.47E-01	5.43E-01	5.46E-01	5.46E-01	5.46E-01	5.49E-01	5.46E-01
Ps90%/90% (-KTL) Biased	4.80E-01	4.83E-01	4.81E-01	4.80E-01	4.80E-01	4.82E-01	4.80E-01
Un-Biased Statistics							
Average Un-Biased	5.24E-01	5.25E-01	5.25E-01	5.24E-01	5.24E-01	5.24E-01	5.24E-01
Std Dev Un-Biased	3.78E-03	3.96E-03	3.36E-03	3.11E-03	3.11E-03	3.11E-03	3.11E-03
Ps90%/90% (+KTL) Un-Biased	5.35E-01	5.36E-01	5.34E-01	5.33E-01	5.33E-01	5.33E-01	5.33E-01
Ps90%/90% (-KTL) Un-Biased	5.14E-01	5.14E-01	5.15E-01	5.16E-01	5.16E-01	5.16E-01	5.16E-01
Specification MIN	2.00E-01	2.00E-01	2.00E-01	2.00E-01	2.00E-01	2.00E-01	2.00E-01
Status	PASS	PASS	PASS	PASS	PASS	N/A	N/A

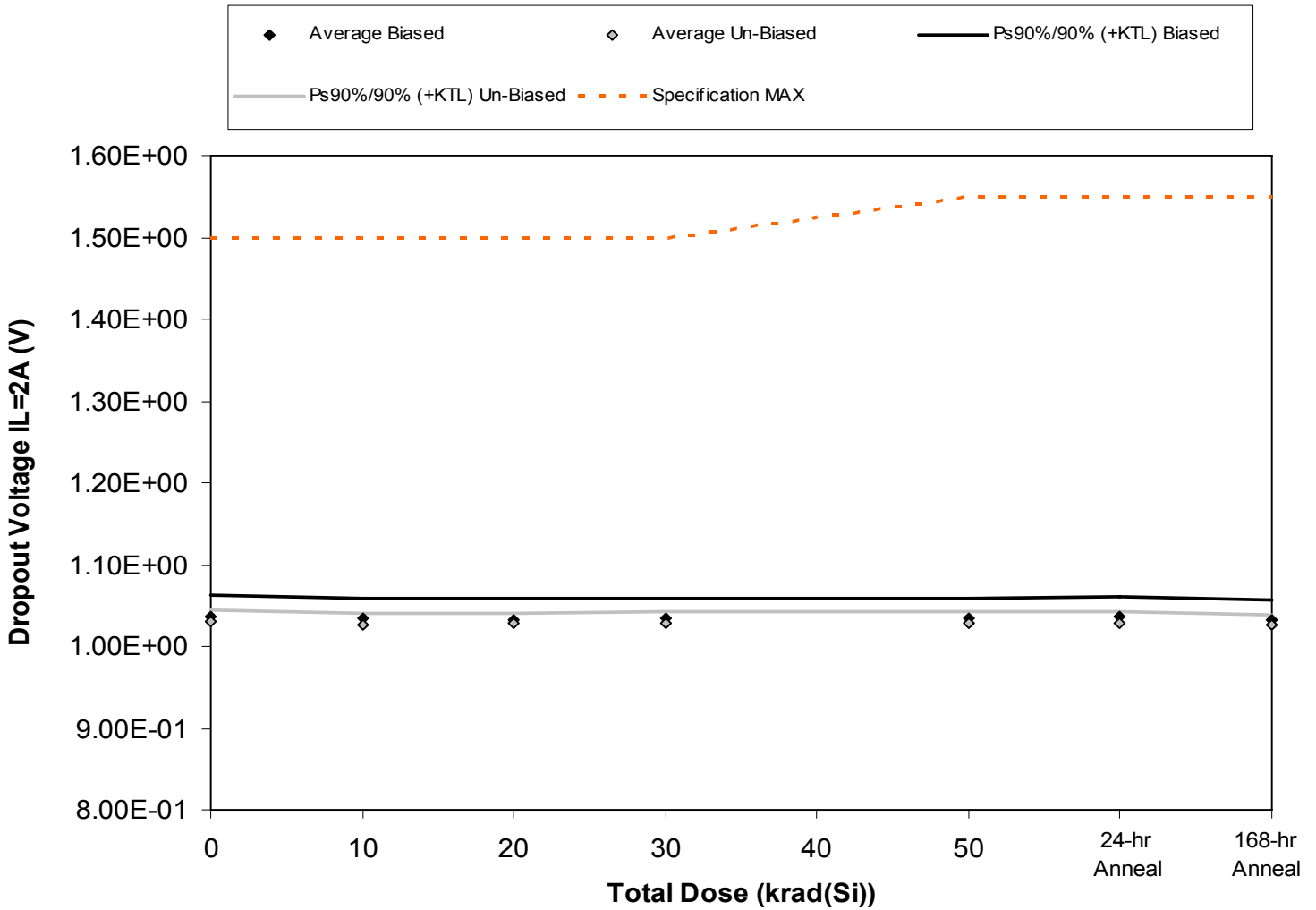

Figure 5.20. Plot of Dropout Voltage $I_L=2A$ (V) versus total dose. The solid diamonds are the average of the measured data points for the samples irradiated under electrical bias while the shaded diamonds are the average of the measured data points for the samples irradiated with all pins tied to ground. The black lines (solid and/or dashed) are the average of the data points after application of the KTL statistics on the samples irradiated under electrical bias while the gray lines (solid and/or dashed) are the average of the data points after application of the KTL statistics on the samples irradiated in the unbiased condition. The red dotted line(s) are the pre- and/or post-irradiation minimum and/or maximum specification value as defined in the datasheet and/or test plan.



Table 5.20. Raw data for Dropout Voltage $I_L=2A$ (V) versus total dose, including the statistical analysis, specification and the status of the testing (pass/fail).

Dropout Voltage $I_L=2A$ (V)	Total Dose (krad(Si))					24-hr Anneal	168-hr Anneal
	0	10	20	30	50		
Device							
35	1.02E+00	1.02E+00	1.02E+00	1.02E+00	1.02E+00	1.02E+00	1.02E+00
36	1.05E+00	1.04E+00	1.04E+00	1.04E+00	1.04E+00	1.05E+00	1.04E+00
37	1.04E+00	1.04E+00	1.03E+00	1.03E+00	1.03E+00	1.04E+00	1.03E+00
38	1.04E+00	1.04E+00	1.04E+00	1.04E+00	1.04E+00	1.04E+00	1.04E+00
39	1.03E+00	1.03E+00	1.03E+00	1.03E+00	1.03E+00	1.03E+00	1.03E+00
75	1.03E+00	1.03E+00	1.03E+00	1.03E+00	1.03E+00	1.03E+00	1.03E+00
76	1.03E+00	1.03E+00	1.03E+00	1.03E+00	1.03E+00	1.03E+00	1.03E+00
77	1.03E+00	1.02E+00	1.03E+00	1.03E+00	1.03E+00	1.03E+00	1.02E+00
78	1.02E+00	1.02E+00	1.02E+00	1.02E+00	1.02E+00	1.02E+00	1.02E+00
79	1.03E+00	1.03E+00	1.03E+00	1.03E+00	1.03E+00	1.03E+00	1.03E+00
142	1.03E+00	1.03E+00	1.03E+00	1.04E+00	1.03E+00	1.03E+00	1.03E+00
143	1.03E+00	1.02E+00	1.03E+00	1.03E+00	1.02E+00	1.03E+00	1.02E+00
Biased Statistics							
Average Biased	1.04E+00	1.03E+00	1.03E+00	1.03E+00	1.03E+00	1.04E+00	1.03E+00
Std Dev Biased	9.31E-03	9.04E-03	9.21E-03	9.05E-03	8.88E-03	8.96E-03	9.35E-03
Ps90%/90% (+KTL) Biased	1.06E+00	1.06E+00	1.06E+00	1.06E+00	1.06E+00	1.06E+00	1.06E+00
Ps90%/90% (-KTL) Biased	1.01E+00	1.01E+00	1.01E+00	1.01E+00	1.01E+00	1.01E+00	1.01E+00
Un-Biased Statistics							
Average Un-Biased	1.03E+00	1.03E+00	1.03E+00	1.03E+00	1.03E+00	1.03E+00	1.03E+00
Std Dev Un-Biased	5.06E-03	4.92E-03	4.61E-03	5.23E-03	5.07E-03	5.23E-03	4.80E-03
Ps90%/90% (+KTL) Un-Biased	1.04E+00	1.04E+00	1.04E+00	1.04E+00	1.04E+00	1.04E+00	1.04E+00
Ps90%/90% (-KTL) Un-Biased	1.02E+00	1.01E+00	1.01E+00	1.01E+00	1.01E+00	1.01E+00	1.01E+00
Specification MAX	1.50E+00	1.50E+00	1.50E+00	1.50E+00	1.55E+00	1.55E+00	1.55E+00
Status	PASS	PASS	PASS	PASS	PASS	N/A	N/A



6.0. Summary / Conclusions

The high dose rate total ionizing dose testing described in this final report was performed using the facilities at Radiation Assured Devices' Longmire Laboratories in Colorado Springs, CO. The high dose rate total ionizing dose (TID) source is a JLSA 84-21 irradiator modified to provide a panoramic exposure. The dose rate for this irradiator in this configuration ranges from <1rad(Si)/s to a maximum of approximately 120rad(Si)/s, determined by the distance from the source.

Samples of the RH1085MK Low Dropout Positive Adjustable Regulator described in this report were irradiated biased with a single sided 30V supply and unbiased (all leads tied to ground). The devices were irradiated to a maximum total ionizing dose level of 50krad(Si) with a pre-rad baseline reading as well as incremental readings at 10, 20, and 30krad(Si). Electrical testing occurred within one hour following the end of each irradiation segment. For intermediate irradiations, the units were tested and returned to total dose exposure within two hours from the end of the previous radiation increment. In addition, all units-under-test received a 24hr room temperature and 168hr 100°C anneal, using the same bias conditions as the radiation exposure.

The parametric data was obtained as read and record and all the raw data plus an attributes summary are contained in a separate Excel file. The attributes data contains the average, standard deviation and the average with the KTL values applied. The KTL value used in this work is 2.742 per MIL-HDBK-814 using one sided tolerance limits of 90/90 and a 5-piece sample size. The 90/90 KTL values were selected to match the statistical levels specified in the MIL-PRF-38535 sampling plan for the qualification of a radiation hardness assured (RHA) component. Note that the following criteria must be met for a device to pass the low dose rate test: following the radiation exposure each of the 5 pieces irradiated under electrical bias shall pass the specification value. The units irradiated without electrical bias and the KTL statistics are included in this report for reference only. If any of the 5 pieces irradiated under electrical bias exceed the datasheet specifications, then the lot could be logged as a failure.

Using the conditions stated above, the RH1085MK Low Dropout Positive Adjustable Regulator (from the lot date code identified on the first page of this test report) technically failed the total dose test at the 50krad(Si) dose level with only minor degradation to the V_{OUT} parameters. Note that the post-irradiation specification limits as defined by Linear Technology for both the maximum and minimum V_{OUT1} levels are reduced with increasing dose, keeping a somewhat constant maximum to minimum spread. For example, the maximum V_{OUT1} specification pre-irradiation is 1.262V and incrementally decreases to 1.241V at 200krad(Si). Therefore, if a particular lot of RH1085MK voltage regulators show little or no degradation to V_{OUT1} with total dose, it is likely to "fail" by exceeding the maximum post-irradiation specification. The remaining V_{OUT} parameters (V_{OUT2} - V_{OUT5}) use a slightly increased post-radiation limit for the maximum voltage level, thus avoiding the "fail" observed on V_{OUT1} if little or no degradation is observed. Note that the data for the units-under-test irradiated in the unbiased condition and the KTL statistics presented in this report are for reference only and are not used for the determination of "PASS/FAIL" for the lot.



Appendix A: Photograph of device-under-test to show part markings





Appendix B: TID Bias Connections

(Extracted and adapted from LINEAR TECHNOLOGY CORPORATION RH1085 Datasheet)

Biased Samples:

Pin	Function	Bias
1	ADJ	GND
2	VIN	+30V decoupled with 10 μ F Tantalum Capacitor
3 (CASE)	VOUT	GND via 150 Ω Resistor in Parallel with a 10 μ F Tantalum Capacitor

Unbiased Samples (All Pins Tied to Ground):

Pin	Function	Bias
1	ADJ	GND
2	VIN	GND
3 (CASE)	VOUT	GND

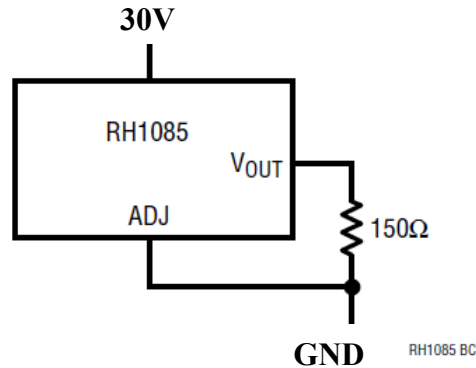

Figure B.1. Irradiation bias circuit for the units to be irradiated under electrical bias. Both the input and output are decoupled with 10 μ F of tantalum capacitance (see bias table above). Note that this figure is intentionally different from the bias circuit defined in the LINEAR TECHNOLOGY CORPORATION RH1085 Datasheet and was approved by the customer.

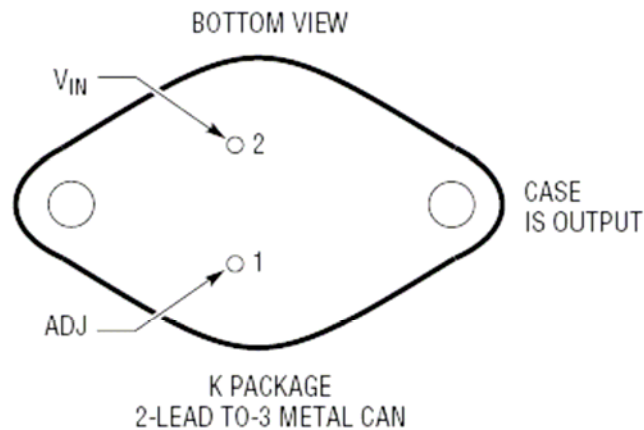

Figure B.2. K package drawing (for reference only). This figure was extracted from the LINEAR TECHNOLOGY CORPORATION RH1085 Datasheet.



Appendix C: Electrical Test Parameters and Conditions

All electrical tests for this device are performed on one of Radiation Assured Device's LTS2020 Test Systems. The LTS2020 Test System is a programmable parametric tester that provides parameter measurements for a variety of digital, analog and mixed signal products including voltage regulators, voltage comparators, D to A and A to D converters. The LTS2020 Test System achieves accuracy and sensitivity through the use of software self-calibration and an internal relay matrix with separate family boards and custom personality adapter boards. The tester uses this relay matrix to connect the required test circuits, select the appropriate voltage / current sources and establish the needed measurement loops for all the tests performed. The tests will be conducted using the LTS-2101 Linear Family Board, LTS-0606 Regulator Fixture and the RH1085 BGSS-000829 DUT board. The measured parameters and test conditions are shown in Table C.1.

A listing of the measurement precision/resolution for each parameter is shown in Table C.2. The precision/resolution values were obtained either from test data or from the DAC resolution of the LTS-2020. To generate the precision/resolution shown in Table C.2, one of the units-under-test was tested repetitively (a total of 10-times with re-insertion between tests) to obtain the average test value and standard deviation. Using this test data MIL-HDBK-814 90/90 KTL statistics were applied to the measured standard deviation to generate the final measurement range. This value encompasses the precision/resolution of all aspects of the test system, including the LTS2020 mainframe, family board, socket assembly and DUT board as well as insertion error. In some cases, the measurement resolution is limited by the internal DACs, which results in a measured standard deviation of zero. In these instances the precision/resolution will be reported back as the LSB of the DAC.

Note that the testing and statistics used in this document are based on an "analysis of variables" technique, which relies on small sample sizes to qualify much larger lot sizes (see MIL-HDBK-814, p. 91 for a discussion of statistical treatments). Unfortunately, not all measured parameters are well suited to this approach due to relatively large variations within the sample population compared to the specification value. If necessary, larger samples sizes could be used to qualify these parameters using an "attributes" approach.



Table C.1. Measured parameters and test conditions for the RH1085. Unless otherwise noted the conditions were selected to match the post-irradiation specifications. See LINEAR TECHNOLOGY CORPORATION RH1085 Datasheet for the post irradiation test conditions and specifications.

Test Description	Test Conditions VDIFF = VIN-VOUT
Reference Voltage 1 (V)	VDIFF=3V IL=10mA
Reference Voltage 2 (V)	VDIFF=1.5V IL=10mA
Reference Voltage 3 (V)	VDIFF=1.5V IL=1A
Reference Voltage 4 (V)	VDIFF=1.5V IL=2A
Reference Voltage 5 (V)	VDIFF=15V IL=10mA
Reference Voltage 6 (V)	VDIFF=25V IL=200mA
Line Regulation 1 (%)	VDIFF=1.5 to 15V IL=10mA
Line Regulation 2 (%)	VDIFF=15 to 30V IL=10mA
Load Regulation (%)	VDIFF=3V IL=10mA to 2A
Adj. Pin Current 1 (A)	VDIFF=1.5V IL=10mA
Adj. Pin Current 2 (A)	VDIFF=25V IL=10mA
Adj. Pin Current 3 (A)	VDIFF=1.5V IL=2A
Adj. Pin Current 4 (A)	VDIFF=25V IL=200mA
Adj. Pin Current Change vs. Load 1 (A)	VDIFF=1.5V IL=10mA to 2A
Adj. Pin Current Change vs. Load 2 (A)	VDIFF=25V IL=10-200mA
Adj. Pin Current Change vs. Line (A)	VDIFF=1.5-25V IL=10mA
Minimum Load Current (A)	VDIFF= 25V
Current Limit 1 (A)	VDIFF=5V
Current Limit 2 (A)	VDIFF=25V
Dropout Voltage (V)	IL=2A



Table C.2. Measured parameters, pre-irradiation specifications and measurement resolution for the RH1085MK.

Measured Parameter	Pre-Irradiation Specification	Measurement Precision/Resolution
Reference Voltage (V)	1.238-1.262V 1.225-1.270V	±5.17E-04V
Line Regulation (%)	±0.2% MAX	±1.69E-02%
Load Regulation (%)	±0.3% MAX	±4.85E-02%
Adj. Pin Current (A)	120µA MAX	±4.47E-07A
Adj. Pin Current Change (A)	±5µA MAX	±5.24E-07A
Minimum Load Current (A)	10mA MAX	±3.67E-06A
Current Limit (A)	3.2A MIN 200mA MIN	±3.90E-03A
Dropout Voltage (V)	1.5V MAX	±1.88E-03V



Appendix D: List of Figures used in Section 5 (Test Results)

- 5.1 Reference Voltage1 VDIFFF=3V IL=10mA (V)
- 5.2 Reference Voltage2 VDIFFF=1.5V IL=10mA (V)
- 5.3 Reference Voltage3 VDIFFF=1.5V IL=1A (V)
- 5.4 Reference Voltage4 VDIFFF=1.5V IL=2A (V)
- 5.5 Reference Voltage5 VDIFFF=15V IL=10mA (V)
- 5.6 Reference Voltage6 VDIFFF=25V IL=200mA (V)
- 5.7 Line Regulation1 VDIFFF=1.5-15V (%)
- 5.8 Line Regulation2 VDIFFF=15-30V (%)
- 5.9 Load Regulation (%)
- 5.10 Adj. Pin Current1 VDIFFF=1.5V IL=10mA (A)
- 5.11 Adj. Pin Current2 VDIFFF=25V IL=10mA (A)
- 5.12 Adj. Pin Current3 VDIFFF=1.5V IL=2A (A)
- 5.13 Adj. Pin Current4 VDIFFF=25V IL=200mA (A)
- 5.14 Adj. Pin Current Change vs. Load1 VDIFFF=1.5V IL=10mA-2A (A)
- 5.15 Adj. Pin Current Change vs. Load2 VDIFFF=25V IL=10-200mA (A)
- 5.16 Adj. Pin Current Change vs. Line VDIFFF=1.5-25V IL=10mA (A)
- 5.17 Minimum Load Current (A)
- 5.18 Current Limit1 VDIFFF=5V (A)
- 5.19 Current Limit2 VDIFFF=25V (A)
- 5.20 Dropout Voltage IL=2A (V)