



***Enhanced Low Dose Rate Sensitivity (ELDRS) Radiation Testing of the  
RH1086MK Low Dropout Positive Adjustable Regulator for Linear  
Technology***

**Customer:** Linear Technology, PO# 54886L

**RAD Job Number:** 10-006

**Part Type Tested:** Linear Technology RH1086MK Low Dropout Positive Adjustable Regulator

**Traceability Information:** Fab lot# W10913024.1, Wafer# 17, Assembly lot: #540912.1. Information obtained from Linear Technology PO#54886L. Date code marking on the package is 0941A, see Appendix A for a photograph of the device and part markings.

**Quantity of Units:** 12 units total, 5 units for biased irradiation, 5 units for unbiased irradiation and 2 control units. Serial numbers 4, 8, 11, 14, and 17 were biased during irradiation, serial numbers 19, 41, 60, 62, and 65 were unbiased during irradiation (all pins tied to ground) and serial numbers 149 and 153 were used as the controls. See Appendix B for the radiation bias connection table.

**Pre-Irradiation Burn-In:** Burn-In performed by Linear Technology prior to receipt by RAD.

**TID Dose Rate and Test Increments:** 10mrad(Si)/s with readings at pre-irradiation, 10, 20, 30 and 50krad(Si).

**TID Overtest and Post-Irradiation Anneal:** No overtest. 24-hour room temperature anneal followed by a 168-hour 100°C anneal. Both anneals shall be performed in the same electrical bias condition as the irradiations. Electrical measurements shall be made following each anneal increment.

**TID Test Standard:** MIL-STD-883G, Method 1019.7, Condition D

**TID Electrical Test Conditions:** Pre-irradiation, and within one hour following each radiation exposure.

**Test Hardware:** LTS2020 Tester, 2101 Family Board, 0606 Fixture and RH1086K BGSS-020602 DUT Board

**Facility and Radiation Source:** Radiation Assured Devices Longmire Laboratories, Colorado Springs, CO using the GB-150 low dose rate Co60 source. Dosimetry performed by CaF<sub>2</sub> TLDs traceable to NIST. RAD's dosimetry has been audited by DSCC and RAD has been awarded Laboratory Suitability for MIL-STD-750 TM 1019.5.

**Irradiation and Test Temperature:** Ambient room temperature for irradiation and test controlled to 24°C±6°C per MIL-STD-883.

**Low Dose Rate Test Result:** Units passed with only minor degradation to the V<sub>OUT</sub> parameters and no significant degradation to any other measured parameter. Further, the units do not exhibit ELDRS as defined in the current test method.



## **1.0. Overview and Background**

It is well known that total dose ionizing radiation can cause parametric degradation and ultimately functional failure in electronic devices. The damage occurs via electron-hole pair production, transport and trapping in the dielectric regions. In advanced CMOS technology nodes (0.6 $\mu$ m and smaller) the bulk of the damage is manifested in the thicker isolation regions, such as shallow trench or local oxidation of silicon (LOCOS) oxides (also known as “birds-beak” oxides). However, many linear and mixed signal devices that utilize bipolar minority carrier elements exhibit an enhanced low dose rate sensitivity (ELDRS). At this time there is no known or accepted *a priori* method for predicting susceptibility to ELDRS or simulating the low dose rate sensitivity with a “conventional” room temperature 50-300rad(Si)/s irradiation (Condition A in MIL-STD-883G TM 1019.7). Over the past 10 years a number of accelerating techniques have been examined, including an elevated temperature anneal, such as that used for MOS devices (see ASTM-F-1892 for more technical details) and irradiating at various temperatures. However, none of these techniques have proven useful across the wide variety of linear and/or mixed signal devices used in spaceborne applications.

The latest requirement incorporated in MIL-STD-883G TM 1019.7 requires that devices that could potentially exhibit ELDRS “shall be tested either at the intended application dose rate, at a prescribed low dose rate to an overtest radiation level, or with an accelerated test such as an elevated temperature irradiation test that includes a parameter delta design margin”. While the recently released MIL-STD-883 TM 1019.7 allows for accelerated testing, the requirements for this are to essentially perform a low dose rate ELDRS test to verify the suitability of the acceleration method on the component of interest before the acceleration technique can be instituted. Based on the limitations of accelerated testing and to meet the requirements of MIL-STD-883G TM 1019.7 Condition D, we have performed an ELDRS test at 10mrad(Si)/s.

## **2.0. Radiation Test Apparatus**

The ELDRS testing described in this final report was performed using the facilities at Radiation Assured Devices’ Longmire Laboratories in Colorado Springs, CO. The ELDRS source is a GB-150 irradiator modified to provide a panoramic exposure. The Co-60 rods are held in the base of the irradiator heavily shielded by lead. During the irradiation exposures the rod is raised by an electronic timer/controller and the exposure is performed in air. The dose rate for this irradiator in this configuration ranges from approximately 1mrad(Si)/s to a maximum of approximately 50rad(Si)/s as determined by the distance from the source. For the low dose rate ELDRS testing described in this report, the devices are placed approximately 2-meters from the Co-60 rods. The irradiator calibration is maintained by Radiation Assured Devices’ Longmire Laboratories using thermoluminescent dosimeters (TLDs) traceable to the National Institute of Standards and Technology (NIST). Figure 2.1 shows a photograph of the Co-60 irradiator at RAD’s Longmire Laboratory facility.



Figure 2.1. Radiation Assured Devices' Co-60 irradiator. The dose rate is obtained by positioning the device-under-test at a fixed distance from the gamma cell. The dose rate for this irradiator varies from approximately 50rad(Si)/s close to the rods down to <1mrad(Si)/s at a distance of approximately 4-meters.



### **3.0. Radiation Test Conditions**

The RH1086MK low dropout positive adjustable regulator described in this final report was irradiated under two different conditions, one when biased with a 30V single sided supply, and one when unbiased with all pins tied to ground. See the TID Bias Table in Appendix A for the full bias circuits. In our opinion these bias circuits satisfy the requirements of MIL-STD-883G TM1019.7 Section 3.9.3 Bias and Loading Conditions which states “The bias applied to the test devices shall be selected to produce the greatest radiation induced damage or the worst-case damage for the intended application, if known. While maximum voltage is often worst case some bipolar linear device parameters (e.g. input bias current or maximum output load current) exhibit more degradation with 0 V bias.”

The devices were irradiated to a maximum total ionizing dose level of 50krad(Si) with incremental readings at 10, 20, 30 and 50krad(Si). Electrical testing occurred within one hour following the end of each irradiation segment. For intermediate irradiations, the units were tested and returned to total dose exposure within two hours from the end of the previous radiation increment. The ELDRS bias board was positioned in the Co-60 cell to provide the required maximum of 10mrads(Si)/s and was located inside a lead-aluminum enclosure. The lead-aluminum enclosure is required under MIL-STD-883G TM1019.7 Section 3.4 that reads as follows: “Lead/Aluminum (Pb/Al) container. Test specimens shall be enclosed in a Pb/Al container to minimize dose enhancement effects caused by low-energy, scattered radiation. A minimum of 1.5 mm Pb, surrounding an inner shield of at least 0.7 mm Al, is required. This Pb/Al container produces an approximate charged particle equilibrium for Si and for TLDs such as CaF<sub>2</sub>. The radiation field intensity shall be measured inside the Pb/Al container (1) initially, (2) when the source is changed, or (3) when the orientation or configuration of the source, container, or test-fixture is changed. This measurement shall be performed by placing a dosimeter (e.g., a TLD) in the device-irradiation container at the approximate test-device position. If it can be demonstrated that low energy scattered radiation is small enough that it will not cause dosimetry errors due to dose enhancement, the Pb/Al container may be omitted”.

The final dose rate within the lead-aluminum box was determined based on TLD dosimetry measurements just prior to the beginning of the total dose irradiations. The final dose rate for this work was 10mrads(Si)/s with a precision of  $\pm 5\%$ .



#### 4.0. Tested Parameters

During the radiation lot acceptance testing the following electrical parameters were measured pre- and post-irradiation:

1. Reference Voltage,  $V_{OUT1}$
2. Reference Voltage,  $V_{OUT2}$
3. Reference Voltage,  $V_{OUT3}$
4. Reference Voltage,  $V_{OUT4}$
5. Reference Voltage,  $V_{OUT5}$
6. Line Regulation, LineReg
7. Load Regulation, LoadReg
8. Adjust Pin Current,  $I_{ADJ1}$
9. Adjust Pin Current,  $I_{ADJ2}$
10. Adjust Pin Current,  $I_{ADJ3}$
11. Adjust Pin Current,  $I_{ADJ4}$
12. Adjust Pin Current,  $I_{ADJ5}$
13. Adjust Pin Current,  $I_{ADJ6}$
14. Adjust Pin Current Change,  $\Delta I_{ADJ1}$
15. Adjust Pin Current Change,  $\Delta I_{ADJ2}$
16. Adjust Pin Current Change,  $\Delta I_{ADJ3}$
17. Adjust Pin Current Change,  $\Delta I_{ADJ4}$
18. Minimum Load Current,  $I_{LOADMIN}$
19. Current Limit,  $I_{LIM1}$
20. Current Limit,  $I_{LIM2}$
21. Dropout Voltage,  $V_{DROPOUT}$

Appendix C details the measured parameters, test conditions, pre-irradiation specification and measurement resolution for each of the measurements.

The parametric data was obtained as “read and record” and all the raw data plus an attributes summary are contained in this report as well as in a separate Excel file. The attributes data contains the average, standard deviation and the average with the KTL values applied. The KTL value used is 2.742 per MIL HDBK 814 using one sided tolerance limits of 90/90 and a 5-piece sample size. This survival probability/level of confidence is consistent with a 22-piece sample size and zero failures analyzed using a lot tolerance percent defective (LTPD) approach. Note that the following criteria must be met for a device to pass the low dose rate test: following the radiation exposure each of the 5 pieces irradiated under electrical bias shall pass the specification value. The units irradiated without electrical bias and the KTL statistics are included in this report for reference only. If any of the 5 pieces irradiated under electrical bias exceed the datasheet specifications, then the lot could be logged as a failure.



Further, MIL-STD-883G, TM 1019.7 Section 3.13.1.1 Characterization test to determine if a part exhibits ELDRS” states the following: Select a minimum random sample of 21 devices from a population representative of recent production runs. Smaller sample sizes may be used if agreed upon between the parties to the test. All of the selected devices shall have undergone appropriate elevated temperature reliability screens, e.g. burn-in and high temperature storage life. Divide the samples into four groups of 5 each and use the remaining part for a control. Perform pre-irradiation electrical characterization on all parts assuring that they meet the Group A electrical tests. Irradiate 5 samples under a 0 volt bias and another 5 under the irradiation bias given in the acquisition specification at 50-300 rad(Si)/s and room temperature. Irradiate 5 samples under a 0 volt bias and another 5 under irradiation bias given in the acquisition specification at < 10mrad(Si)/s and room temperature. Irradiate all samples to the same dose levels, including 0.5 and 1.0 times the anticipated specification dose, and repeat the electrical characterization on each part at each dose level. Post irradiation electrical measurements shall be performed per paragraph 3.10 where the low dose rate test is considered Condition D. Calculate the radiation induced change in each electrical parameter ( $\Delta_{para}$ ) for each sample at each radiation level. Calculate the ratio of the median  $\Delta_{para}$  at low dose rate to the median  $\Delta_{para}$  at high dose rate for each irradiation bias group at each total dose level. If this ratio exceeds 1.5 for any of the most sensitive parameters then the part is considered to be ELDRS susceptible. This test does not apply to parameters which exhibit changes that are within experimental error or whose values are below the pre-irradiation electrical specification limits at low dose rate at the specification dose.

Therefore, the data in this report can be analyzed along with the low dose rate report titled “Total Ionizing Dose (TID) Testing of the RH1086MK Low Dropout Positive Adjustable Regulator for Linear Technology” to demonstrate that these parts do not exhibit ELDRS as defined in the current test method.

### **5.0. ELDRS Test Results**

Using the conditions stated above, the RH1086MK Low Dropout Positive Adjustable Regulator (from the lot date code identified on the first page of this test report) passed the low dose rate test with only minor degradation to the  $V_{OUT}$  parameters. Note that the post-irradiation specification limits as defined by Linear Technology for both the maximum and minimum  $V_{OUT1}$  levels are reduced with increasing dose, keeping a somewhat constant maximum to minimum spread. For example, the maximum  $V_{OUT1}$  specification pre-irradiation is 1.262V and incrementally decreases to 1.241V at 200krad(Si). Therefore, if a particular lot of RH1086 voltage regulators show little or no degradation to  $V_{OUT1}$  with total dose, it is likely to “fail” by exceeding the maximum post-irradiation specification. The remaining  $V_{OUT}$  parameters ( $V_{OUT2}$ - $V_{OUT5}$ ) use a slightly increased post-radiation limit for the maximum voltage level, thus avoiding the “fail” observed on  $V_{OUT1}$  if little or no degradation is observed. Note that the data for the units-under-test irradiated in the unbiased condition and the KTL statistics presented in this report are for reference only and are not used for the determination of “PASS/FAIL” for the lot.

Figures 5.1 through 5.21 show plots of all the measured parameters versus total ionizing dose while Tables 5.1 – 5.21 show the corresponding raw data for each of these parameters. In these data plots the



solid diamonds are the average of the measured data points for the sample irradiated under electrical bias while the shaded diamonds are the average of the measured data points for the units irradiated with all pins tied to ground. The black lines (solid or dashed) are the average of the data points after application of the KTL statistics on the sample irradiated in the biased condition while the shaded lines (solid or dashed) are the average of the data points after application of the KTL statistics on the sample irradiated in the unbiased condition. The red dotted line(s) are the pre- and/or post-irradiation minimum and/or maximum specification value as defined in the datasheet and/or test plan.

In addition to the radiation test results, the data plots and tables described above contain anneal data. The anneals are performed to better understand the underlying physical mechanisms responsible for radiation-induced parametric shifts and are not part of the criteria used to establish whether or not the lot passes or fails the low dose rate test. In all cases the parts either improved or exhibited no change during the anneal.

As seen clearly in these figures, the pre- and post-irradiation data are well within the specification even after application of the KTL statistics and the control units, as expected, show no significant changes to any of the parameters throughout the course of the measurements. Therefore we can conclude that any observed degradation was due to the radiation exposure and not drift in the test equipment.

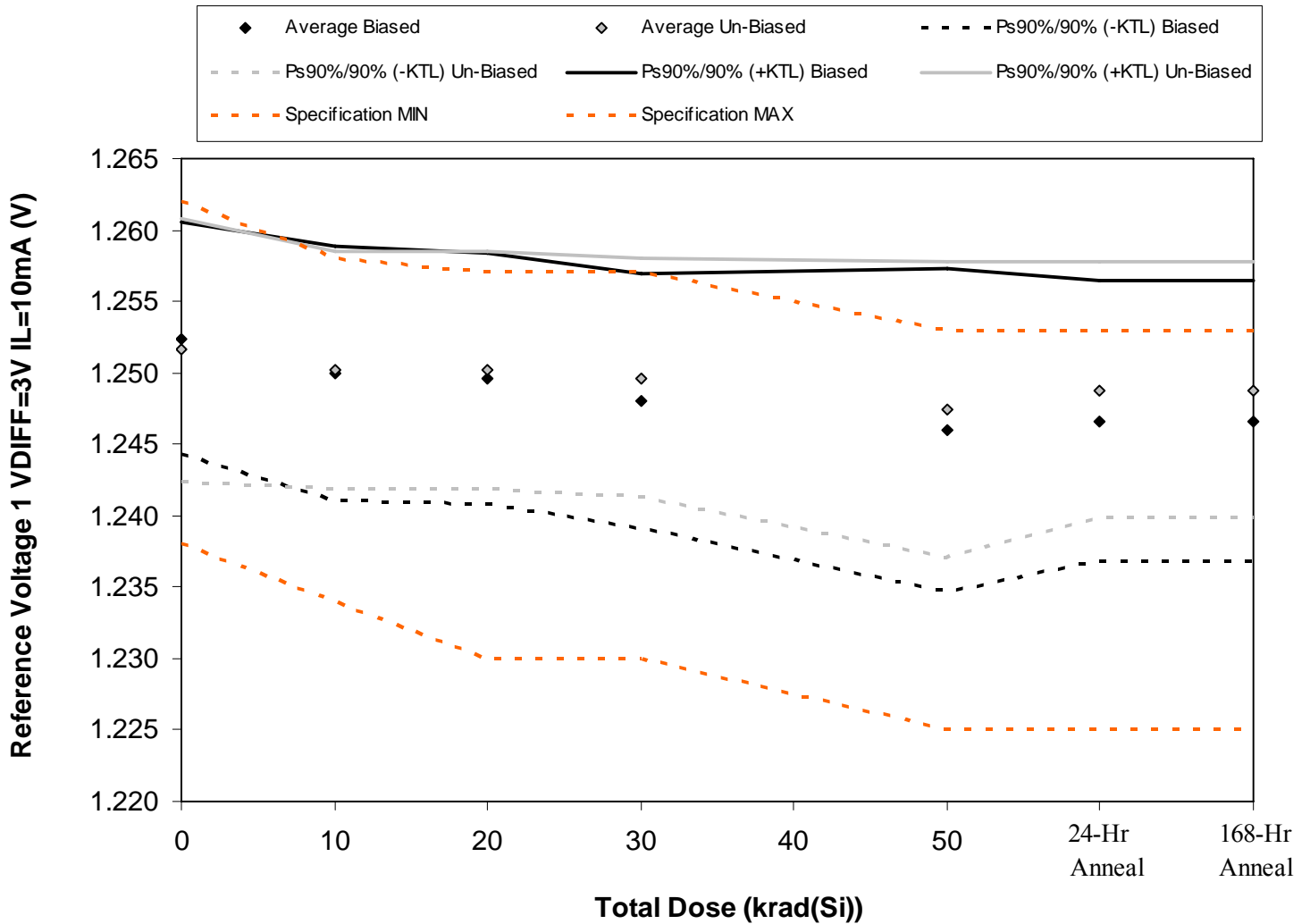

Figure 5.1. Plot of Reference Voltage 1 VDIFF=3V IL=10mA (V) versus total dose. The solid diamonds are the average of the measured data points for the samples irradiated under electrical bias while the shaded diamonds are the average of the measured data points for the samples irradiated with all pins tied to ground. The black lines (solid and/or dashed) are the average of the data points after application of the KTL statistics on the samples irradiated under electrical bias while the gray lines (solid and/or dashed) are the average of the data points after application of the KTL statistics on the samples irradiated in the unbiased condition. The red dotted line(s) are the pre- and/or post-irradiation minimum and/or maximum specification value as defined in the datasheet and/or test plan.





Table 5.1. Raw data for Reference Voltage 1 VDIFF=3V IL=10mA (V) versus total dose, including the statistical analysis, specification and the status of the testing (pass/fail).

Reference Voltage 1 VDIFF=3V IL=10mA (V)	Total Dose (krad(Si))					24-hr Anneal	168-hr Anneal
	0	10	20	30	50		
Device	0	10	20	30	50		
4	1.251	1.248	1.247	1.246	1.243	1.244	1.244
8	1.255	1.253	1.252	1.251	1.250	1.250	1.250
11	1.249	1.247	1.247	1.245	1.243	1.244	1.244
14	1.251	1.248	1.248	1.246	1.243	1.244	1.244
17	1.256	1.254	1.254	1.252	1.251	1.251	1.251
19	1.248	1.247	1.247	1.246	1.243	1.245	1.245
41	1.255	1.253	1.253	1.253	1.251	1.252	1.252
60	1.253	1.251	1.251	1.250	1.248	1.249	1.249
62	1.254	1.253	1.253	1.252	1.251	1.252	1.252
65	1.248	1.247	1.247	1.247	1.244	1.246	1.246
149	1.256	1.256	1.255	1.256	1.255	1.256	1.255
153	1.249	1.248	1.249	1.248	1.247	1.249	1.248
<b>Biased Statistics</b>							
Average Biased	1.252	1.250	1.250	1.248	1.246	1.247	1.247
Std Dev Biased	2.97E-03	3.24E-03	3.21E-03	3.24E-03	4.12E-03	3.58E-03	3.58E-03
Ps90%/90% (+KTL) Biased	1.261	1.259	1.258	1.257	1.257	1.256	1.256
Ps90%/90% (-KTL) Biased	1.244	1.241	1.241	1.239	1.235	1.237	1.237
<b>Un-Biased Statistics</b>							
Average Un-Biased	1.252	1.250	1.250	1.250	1.247	1.249	1.249
Std Dev Un-Biased	3.36E-03	3.03E-03	3.03E-03	3.05E-03	3.78E-03	3.27E-03	3.27E-03
Ps90%/90% (+KTL) Un-Biased	1.261	1.259	1.259	1.258	1.258	1.258	1.258
Ps90%/90% (-KTL) Un-Biased	1.242	1.242	1.242	1.241	1.237	1.240	1.240
<b>Specification MIN</b>	<b>1.238</b>	<b>1.234</b>	<b>1.230</b>	<b>1.230</b>	<b>1.225</b>	<b>1.225</b>	<b>1.225</b>
Status	PASS	PASS	PASS	PASS	PASS	PASS	PASS
<b>Specification MAX</b>	<b>1.262</b>	<b>1.258</b>	<b>1.257</b>	<b>1.257</b>	<b>1.253</b>	<b>1.253</b>	<b>1.253</b>
Status	PASS	PASS	PASS	PASS	PASS	PASS	PASS

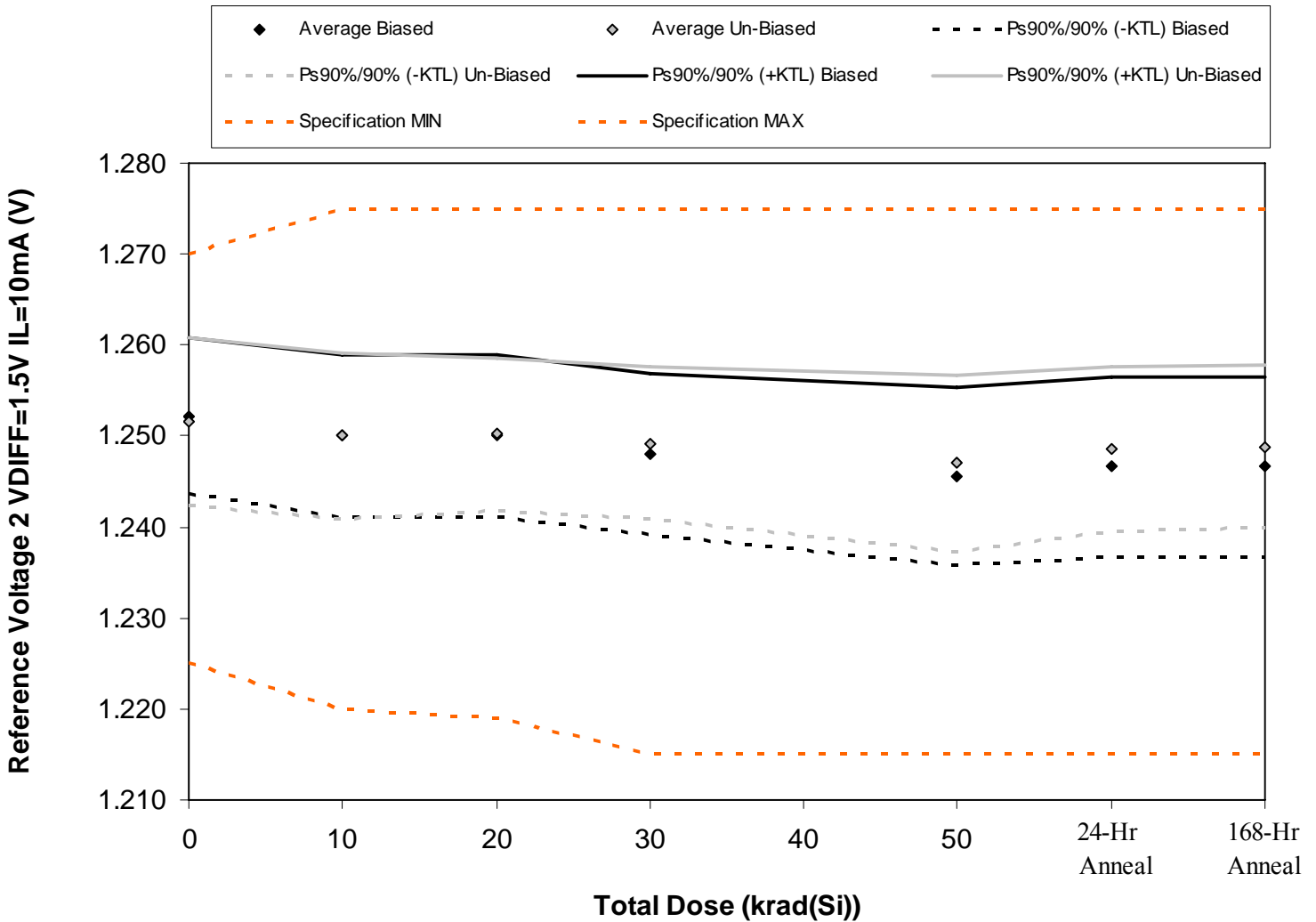

Figure 5.2. Plot of Reference Voltage 2 VDIFF=1.5V IL=10mA (V) versus total dose. The solid diamonds are the average of the measured data points for the samples irradiated under electrical bias while the shaded diamonds are the average of the measured data points for the samples irradiated with all pins tied to ground. The black lines (solid and/or dashed) are the average of the data points after application of the KTL statistics on the samples irradiated under electrical bias while the gray lines (solid and/or dashed) are the average of the data points after application of the KTL statistics on the samples irradiated in the unbiased condition. The red dotted line(s) are the pre- and/or post-irradiation minimum and/or maximum specification value as defined in the datasheet and/or test plan.



Table 5.2. Raw data for Reference Voltage 2 VDIFF=1.5V IL=10mA (V) versus total dose, including the statistical analysis, specification and the status of the testing (pass/fail).

Reference Voltage 2 VDIFF=1.5V IL=10mA (V)	Total Dose (krad(Si))					24-hr Anneal	168-hr Anneal
	0	10	20	30	50		
Device	0	10	20	30	50		
4	1.250	1.248	1.248	1.246	1.243	1.244	1.244
8	1.255	1.253	1.253	1.251	1.249	1.250	1.250
11	1.249	1.247	1.247	1.245	1.243	1.244	1.244
14	1.251	1.248	1.248	1.246	1.243	1.244	1.244
17	1.256	1.254	1.254	1.252	1.250	1.251	1.251
19	1.248	1.246	1.247	1.246	1.243	1.245	1.245
41	1.255	1.253	1.253	1.252	1.250	1.252	1.252
60	1.253	1.251	1.251	1.250	1.247	1.248	1.249
62	1.254	1.253	1.253	1.252	1.251	1.252	1.252
65	1.248	1.247	1.247	1.246	1.244	1.246	1.246
149	1.256	1.255	1.256	1.255	1.255	1.256	1.255
153	1.248	1.248	1.248	1.248	1.247	1.249	1.248
<b>Biased Statistics</b>							
Average Biased	1.252	1.250	1.250	1.248	1.246	1.247	1.247
Std Dev Biased	3.11E-03	3.24E-03	3.24E-03	3.24E-03	3.58E-03	3.58E-03	3.58E-03
Ps90%/90% (+KTL) Biased	1.261	1.259	1.259	1.257	1.255	1.256	1.256
Ps90%/90% (-KTL) Biased	1.244	1.241	1.241	1.239	1.236	1.237	1.237
<b>Un-Biased Statistics</b>							
Average Un-Biased	1.252	1.250	1.250	1.249	1.247	1.249	1.249
Std Dev Un-Biased	3.36E-03	3.32E-03	3.03E-03	3.03E-03	3.54E-03	3.29E-03	3.27E-03
Ps90%/90% (+KTL) Un-Biased	1.261	1.259	1.259	1.258	1.257	1.258	1.258
Ps90%/90% (-KTL) Un-Biased	1.242	1.241	1.242	1.241	1.237	1.240	1.240
<b>Specification MIN</b>	<b>1.225</b>	<b>1.220</b>	<b>1.219</b>	<b>1.215</b>	<b>1.215</b>	<b>1.215</b>	<b>1.215</b>
Status	PASS	PASS	PASS	PASS	PASS	PASS	PASS
<b>Specification MAX</b>	<b>1.270</b>	<b>1.275</b>	<b>1.275</b>	<b>1.275</b>	<b>1.275</b>	<b>1.275</b>	<b>1.275</b>
Status	PASS	PASS	PASS	PASS	PASS	PASS	PASS

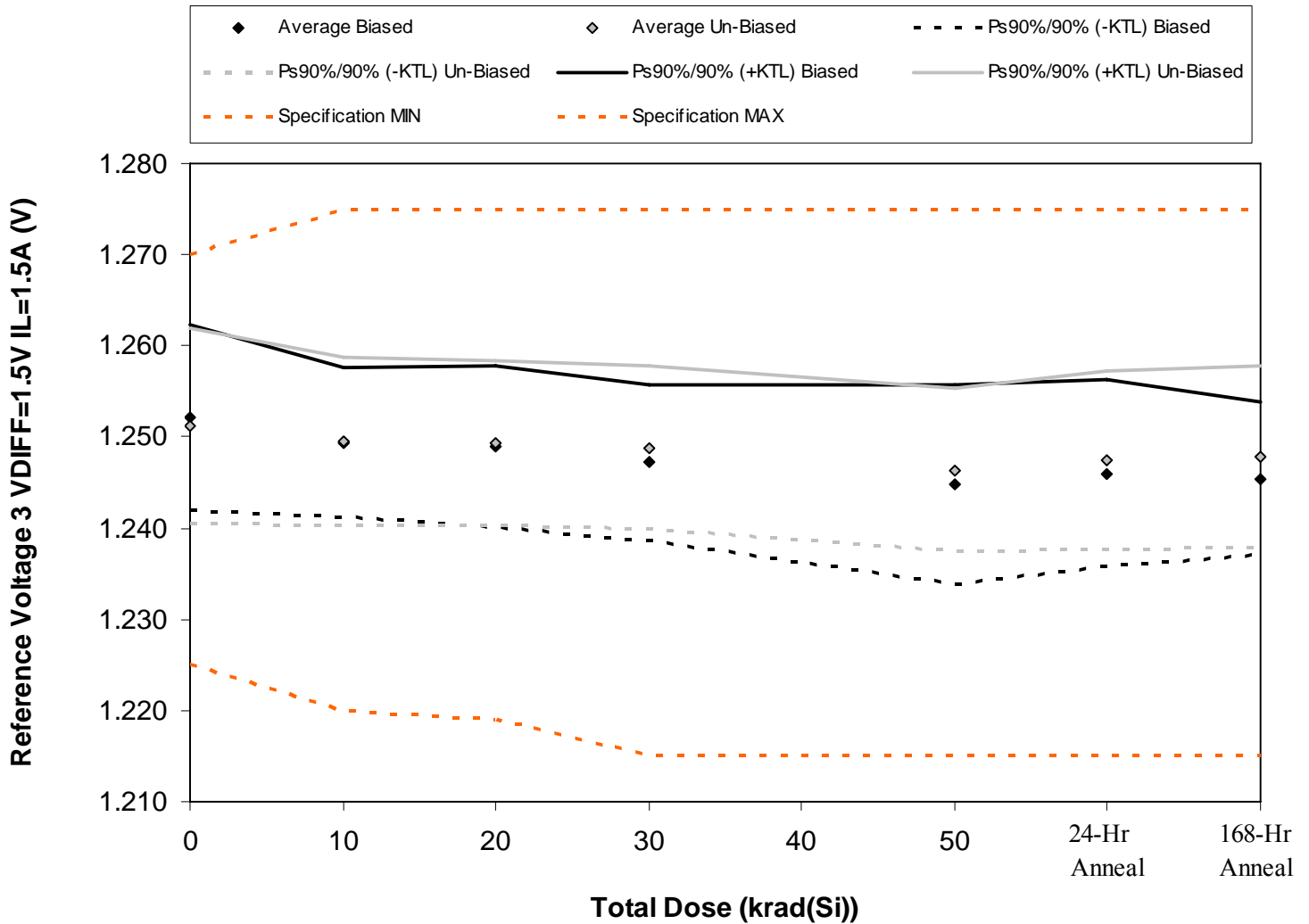

Figure 5.3. Plot of Reference Voltage 3 VDIFF=1.5V IL=1.5A (V) versus total dose. The solid diamonds are the average of the measured data points for the samples irradiated under electrical bias while the shaded diamonds are the average of the measured data points for the samples irradiated with all pins tied to ground. The black lines (solid and/or dashed) are the average of the data points after application of the KTL statistics on the samples irradiated under electrical bias while the gray lines (solid and/or dashed) are the average of the data points after application of the KTL statistics on the samples irradiated in the unbiased condition. The red dotted line(s) are the pre- and/or post-irradiation minimum and/or maximum specification value as defined in the datasheet and/or test plan.



Table 5.3. Raw data for Reference Voltage 3 VDIFF=1.5V IL=1.5A (V) versus total dose, including the statistical analysis, specification and the status of the testing (pass/fail).

Reference Voltage 3 VDIFF=1.5V IL=1.5A (V)	Total Dose (krad(Si))					24-hr Anneal	168-hr Anneal
	0	10	20	30	50		
Device	0	10	20	30	50		
4	1.251	1.248	1.247	1.246	1.243	1.244	1.244
8	1.255	1.252	1.252	1.250	1.248	1.249	1.247
11	1.248	1.246	1.246	1.244	1.241	1.243	1.243
14	1.250	1.248	1.247	1.245	1.242	1.243	1.243
17	1.257	1.253	1.253	1.251	1.250	1.251	1.250
19	1.247	1.246	1.246	1.245	1.243	1.243	1.243
41	1.255	1.253	1.252	1.252	1.250	1.251	1.251
60	1.253	1.251	1.250	1.249	1.247	1.247	1.249
62	1.254	1.252	1.253	1.252	1.249	1.251	1.251
65	1.247	1.246	1.246	1.246	1.243	1.245	1.245
149	1.255	1.255	1.254	1.255	1.254	1.255	1.255
153	1.248	1.248	1.248	1.248	1.246	1.247	1.248
<b>Biased Statistics</b>							
Average Biased	1.252	1.249	1.249	1.247	1.245	1.246	1.245
Std Dev Biased	3.70E-03	2.97E-03	3.24E-03	3.11E-03	3.96E-03	3.74E-03	3.05E-03
Ps90%/90% (+KTL) Biased	1.262	1.258	1.258	1.256	1.256	1.256	1.254
Ps90%/90% (-KTL) Biased	1.242	1.241	1.240	1.239	1.234	1.236	1.237
<b>Un-Biased Statistics</b>							
Average Un-Biased	1.251	1.250	1.249	1.249	1.246	1.247	1.248
Std Dev Un-Biased	3.90E-03	3.36E-03	3.29E-03	3.27E-03	3.29E-03	3.58E-03	3.63E-03
Ps90%/90% (+KTL) Un-Biased	1.262	1.259	1.258	1.258	1.255	1.257	1.258
Ps90%/90% (-KTL) Un-Biased	1.241	1.240	1.240	1.240	1.237	1.238	1.238
<b>Specification MIN</b>	<b>1.225</b>	<b>1.220</b>	<b>1.219</b>	<b>1.215</b>	<b>1.215</b>	<b>1.215</b>	<b>1.215</b>
Status	PASS	PASS	PASS	PASS	PASS	PASS	PASS
<b>Specification MAX</b>	<b>1.270</b>	<b>1.275</b>	<b>1.275</b>	<b>1.275</b>	<b>1.275</b>	<b>1.275</b>	<b>1.275</b>
Status	PASS	PASS	PASS	PASS	PASS	PASS	PASS

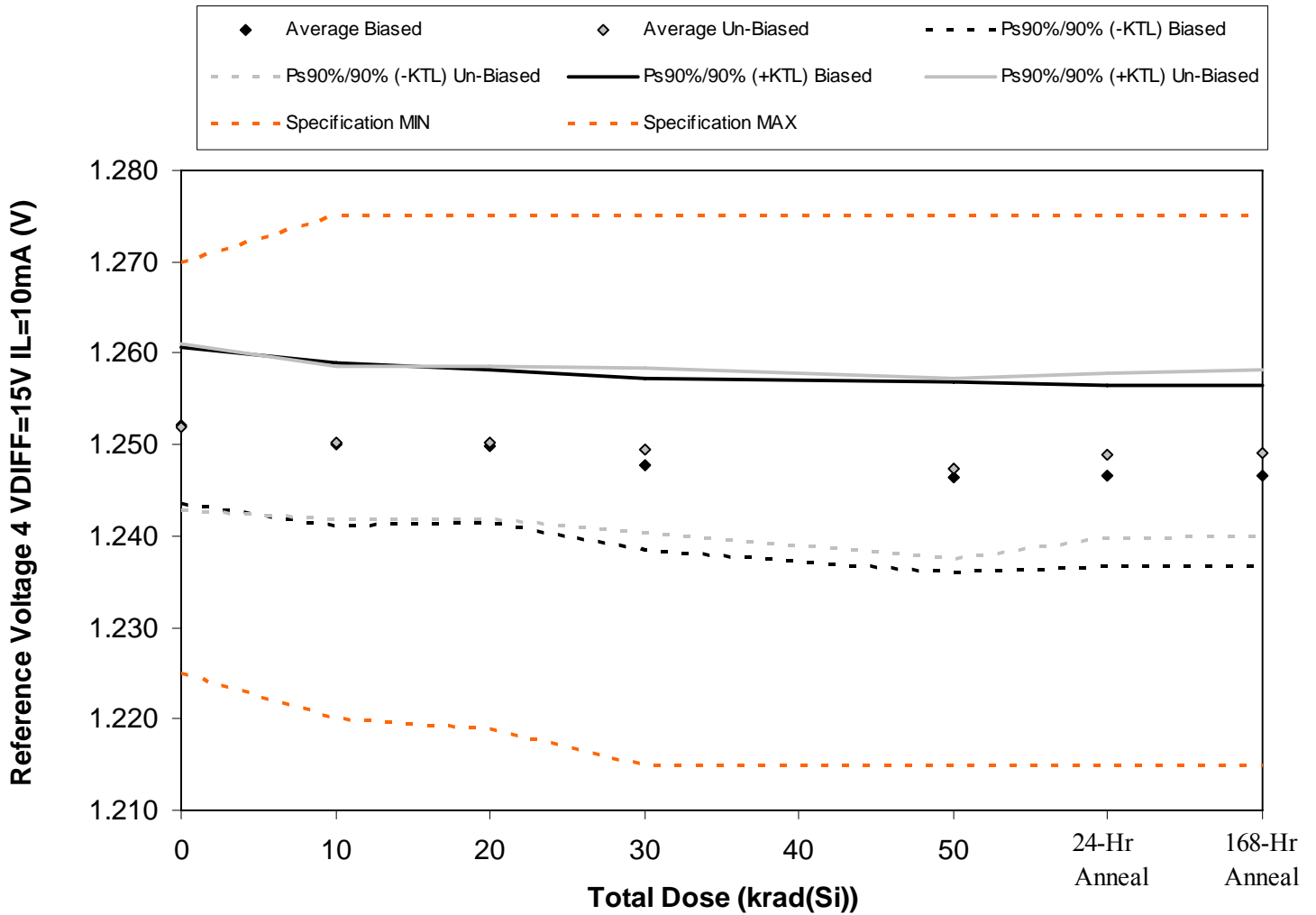

Figure 5.4. Plot of Reference Voltage 4 VDIFF=15V IL=10mA (V) versus total dose. The solid diamonds are the average of the measured data points for the samples irradiated under electrical bias while the shaded diamonds are the average of the measured data points for the samples irradiated with all pins tied to ground. The black lines (solid and/or dashed) are the average of the data points after application of the KTL statistics on the samples irradiated under electrical bias while the gray lines (solid and/or dashed) are the average of the data points after application of the KTL statistics on the samples irradiated in the unbiased condition. The red dotted line(s) are the pre- and/or post-irradiation minimum and/or maximum specification value as defined in the datasheet and/or test plan.



Table 5.4. Raw data for Reference Voltage 4 VDIFF=15V IL=10mA (V) versus total dose, including the statistical analysis, specification and the status of the testing (pass/fail).

Reference Voltage 4 VDIFF=15V IL=10mA (V)	Total Dose (krad(Si))					24-hr Anneal	168-hr Anneal
	0	10	20	30	50		
Device							
4	1.250	1.248	1.248	1.245	1.244	1.244	1.244
8	1.255	1.253	1.252	1.251	1.250	1.250	1.250
11	1.249	1.247	1.247	1.245	1.243	1.244	1.244
14	1.251	1.248	1.248	1.246	1.244	1.244	1.244
17	1.256	1.254	1.254	1.252	1.251	1.251	1.251
19	1.249	1.247	1.247	1.246	1.243	1.245	1.245
41	1.255	1.253	1.253	1.253	1.251	1.252	1.252
60	1.253	1.251	1.251	1.250	1.247	1.249	1.250
62	1.255	1.253	1.253	1.252	1.251	1.252	1.252
65	1.248	1.247	1.247	1.246	1.245	1.246	1.246
149	1.256	1.256	1.255	1.255	1.255	1.256	1.255
153	1.248	1.247	1.248	1.248	1.247	1.249	1.248
<b>Biased Statistics</b>							
Average Biased	1.252	1.250	1.250	1.248	1.246	1.247	1.247
Std Dev Biased	3.11E-03	3.24E-03	3.03E-03	3.42E-03	3.78E-03	3.58E-03	3.58E-03
Ps90%/90% (+KTL) Biased	1.261	1.259	1.258	1.257	1.257	1.256	1.256
Ps90%/90% (-KTL) Biased	1.244	1.241	1.241	1.238	1.236	1.237	1.237
<b>Un-Biased Statistics</b>							
Average Un-Biased	1.252	1.250	1.250	1.249	1.247	1.249	1.249
Std Dev Un-Biased	3.32E-03	3.03E-03	3.03E-03	3.29E-03	3.58E-03	3.27E-03	3.32E-03
Ps90%/90% (+KTL) Un-Biased	1.261	1.259	1.259	1.258	1.257	1.258	1.258
Ps90%/90% (-KTL) Un-Biased	1.243	1.242	1.242	1.240	1.238	1.240	1.240
<b>Specification MIN</b>	<b>1.225</b>	<b>1.220</b>	<b>1.219</b>	<b>1.215</b>	<b>1.215</b>	<b>1.215</b>	<b>1.215</b>
Status	PASS	PASS	PASS	PASS	PASS	PASS	PASS
<b>Specification MAX</b>	<b>1.270</b>	<b>1.275</b>	<b>1.275</b>	<b>1.275</b>	<b>1.275</b>	<b>1.275</b>	<b>1.275</b>
Status	PASS	PASS	PASS	PASS	PASS	PASS	PASS

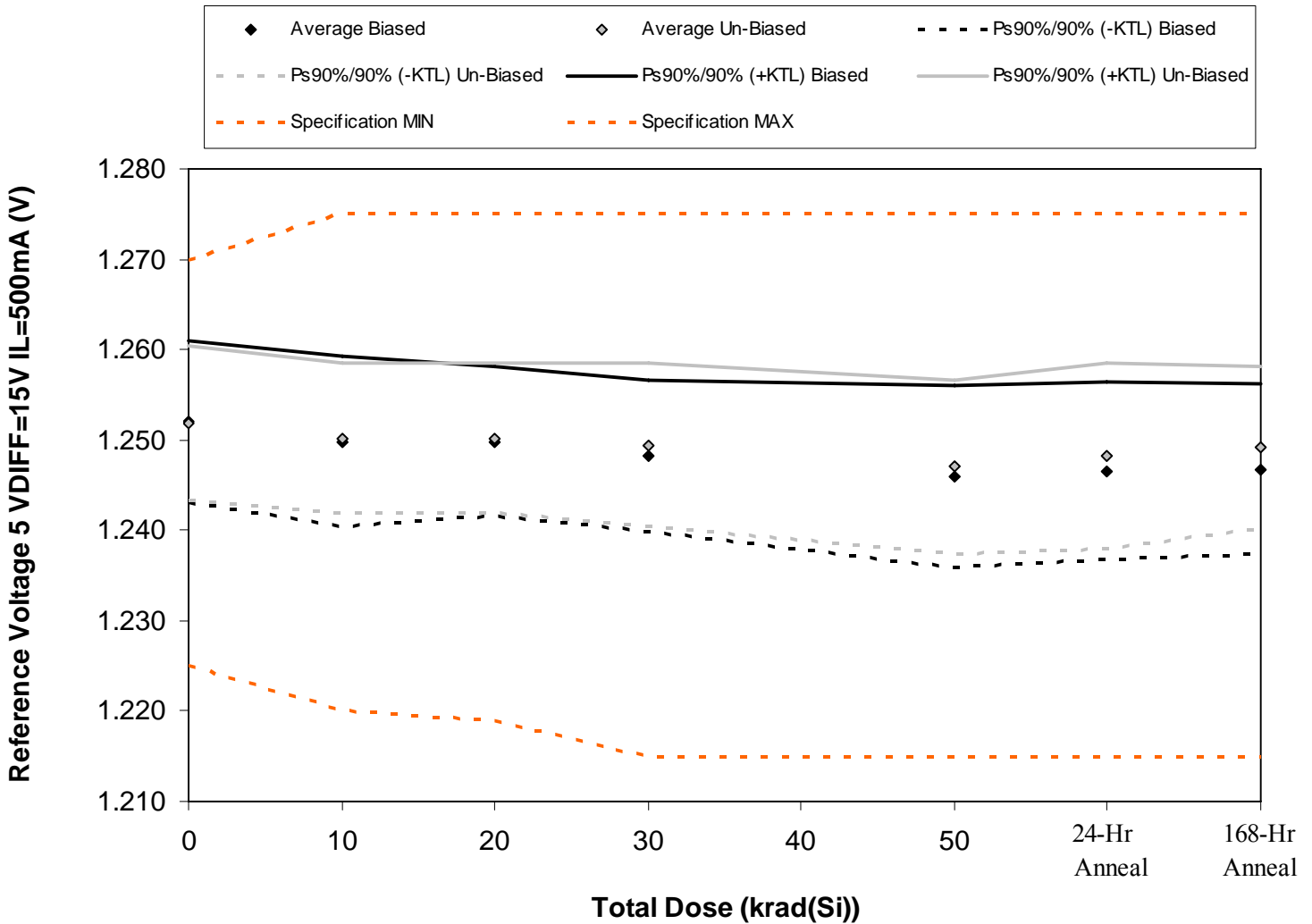

Figure 5.5. Plot of Reference Voltage 5 VDIFF=15V IL=500mA (V) versus total dose. The solid diamonds are the average of the measured data points for the samples irradiated under electrical bias while the shaded diamonds are the average of the measured data points for the samples irradiated with all pins tied to ground. The black lines (solid and/or dashed) are the average of the data points after application of the KTL statistics on the samples irradiated under electrical bias while the gray lines (solid and/or dashed) are the average of the data points after application of the KTL statistics on the samples irradiated in the unbiased condition. The red dotted line(s) are the pre- and/or post-irradiation minimum and/or maximum specification value as defined in the datasheet and/or test plan.





Table 5.5. Raw data for Reference Voltage 5 VDIFF=15V IL=500mA (V) versus total dose, including the statistical analysis, specification and the status of the testing (pass/fail).

Reference Voltage 5 VDIFF=15V IL=500mA (V)	Total Dose (krad(Si))					24-hr Anneal	168-hr Anneal
	0	10	20	30	50		
Device							
4	1.250	1.247	1.248	1.246	1.243	1.244	1.245
8	1.255	1.253	1.252	1.251	1.250	1.250	1.250
11	1.249	1.247	1.247	1.246	1.244	1.244	1.244
14	1.250	1.248	1.248	1.246	1.243	1.244	1.244
17	1.256	1.254	1.254	1.252	1.250	1.251	1.251
19	1.249	1.247	1.247	1.246	1.243	1.244	1.246
41	1.255	1.253	1.253	1.253	1.250	1.252	1.252
60	1.253	1.251	1.251	1.250	1.247	1.248	1.249
62	1.254	1.253	1.253	1.252	1.251	1.252	1.253
65	1.248	1.247	1.247	1.246	1.244	1.245	1.246
149	1.256	1.255	1.256	1.255	1.255	1.256	1.255
153	1.249	1.248	1.247	1.248	1.248	1.249	1.248
<b>Biased Statistics</b>							
Average Biased	1.252	1.250	1.250	1.248	1.246	1.247	1.247
Std Dev Biased	3.24E-03	3.42E-03	3.03E-03	3.03E-03	3.67E-03	3.58E-03	3.42E-03
Ps90%/90% (+KTL) Biased	1.261	1.259	1.258	1.257	1.256	1.256	1.256
Ps90%/90% (-KTL) Biased	1.243	1.240	1.241	1.240	1.236	1.237	1.237
<b>Un-Biased Statistics</b>							
Average Un-Biased	1.252	1.250	1.250	1.249	1.247	1.248	1.249
Std Dev Un-Biased	3.11E-03	3.03E-03	3.03E-03	3.29E-03	3.54E-03	3.77E-03	3.27E-03
Ps90%/90% (+KTL) Un-Biased	1.260	1.259	1.259	1.258	1.257	1.259	1.258
Ps90%/90% (-KTL) Un-Biased	1.243	1.242	1.242	1.240	1.237	1.238	1.240
<b>Specification MIN</b>	<b>1.225</b>	<b>1.220</b>	<b>1.219</b>	<b>1.215</b>	<b>1.215</b>	<b>1.215</b>	<b>1.215</b>
Status	PASS	PASS	PASS	PASS	PASS	PASS	PASS
<b>Specification MAX</b>	<b>1.270</b>	<b>1.275</b>	<b>1.275</b>	<b>1.275</b>	<b>1.275</b>	<b>1.275</b>	<b>1.275</b>
Status	PASS	PASS	PASS	PASS	PASS	PASS	PASS

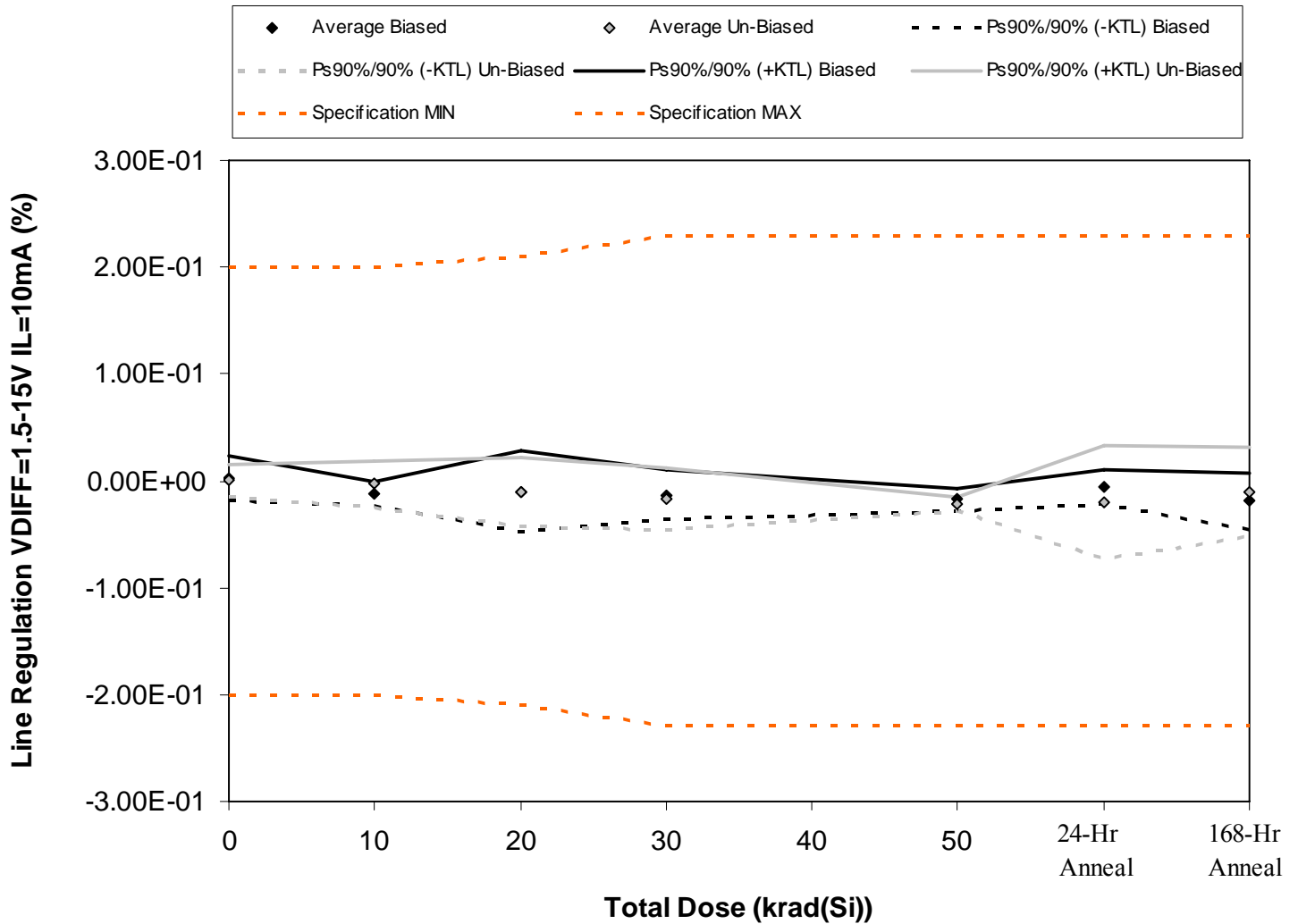

Figure 5.6. Plot of Line Regulation VDIFF=1.5-15V IL=10mA (%) versus total dose. The solid diamonds are the average of the measured data points for the samples irradiated under electrical bias while the shaded diamonds are the average of the measured data points for the samples irradiated with all pins tied to ground. The black lines (solid and/or dashed) are the average of the data points after application of the KTL statistics on the samples irradiated under electrical bias while the gray lines (solid and/or dashed) are the average of the data points after application of the KTL statistics on the samples irradiated in the unbiased condition. The red dotted line(s) are the pre- and/or post-irradiation minimum and/or maximum specification value as defined in the datasheet and/or test plan.



Table 5.6. Raw data for Line Regulation VDIFF=1.5-15V IL=10mA (%) versus total dose, including the statistical analysis, specification and the status of the testing (pass/fail).

Line Regulation VDIFF=1.5-15V IL=10mA (%)	Total Dose (krad(Si))					24-hr Anneal	168-hr Anneal
	0	10	20	30	50		
Device							
4	7.00E-03	-1.80E-02	3.00E-03	-2.00E-02	-1.90E-02	-1.60E-02	-1.20E-02
8	0.00E+00	-7.00E-03	-1.70E-02	-1.50E-02	-2.00E-02	-3.00E-03	-8.00E-03
11	1.20E-02	-1.20E-02	-4.00E-03	1.00E-03	-2.20E-02	-1.00E-03	-2.40E-02
14	3.00E-03	-1.20E-02	-3.10E-02	-2.00E-02	-1.50E-02	-5.00E-03	-3.20E-02
17	-8.00E-03	-1.10E-02	-1.00E-03	-1.10E-02	-1.20E-02	-4.00E-03	-2.00E-02
19	1.00E-03	1.10E-02	-2.30E-02	-2.80E-02	-2.20E-02	-5.00E-02	-2.30E-02
41	-9.00E-03	-8.00E-03	8.00E-03	-2.70E-02	-2.20E-02	-2.80E-02	-2.20E-02
60	5.00E-03	-9.00E-03	-1.10E-02	-3.00E-03	-2.00E-02	-1.30E-02	1.00E-03
62	0.00E+00	-4.00E-03	-1.70E-02	-1.60E-02	-2.40E-02	-7.00E-03	1.10E-02
65	3.00E-03	-5.00E-03	-1.10E-02	-1.20E-02	-1.80E-02	-3.00E-03	-1.90E-02
149	-1.10E-02	1.00E-03	4.00E-03	-3.00E-03	-5.00E-03	0.00E+00	-9.00E-03
153	-1.60E-02	-1.30E-02	4.00E-03	-1.60E-02	-1.60E-02	-9.00E-03	3.00E-03
<b>Biased Statistics</b>							
Average Biased	2.80E-03	-1.20E-02	-1.00E-02	-1.30E-02	-1.76E-02	-5.80E-03	-1.92E-02
Std Dev Biased	7.53E-03	3.94E-03	1.39E-02	8.69E-03	4.04E-03	5.89E-03	9.55E-03
Ps90%/90% (+KTL) Biased	2.34E-02	-1.20E-03	2.82E-02	1.08E-02	-6.53E-03	1.04E-02	6.99E-03
Ps90%/90% (-KTL) Biased	-1.78E-02	-2.28E-02	-4.82E-02	-3.68E-02	-2.87E-02	-2.20E-02	-4.54E-02
<b>Un-Biased Statistics</b>							
Average Un-Biased	0.00E+00	-3.00E-03	-1.08E-02	-1.72E-02	-2.12E-02	-2.02E-02	-1.04E-02
Std Dev Un-Biased	5.39E-03	8.09E-03	1.16E-02	1.05E-02	2.28E-03	1.92E-02	1.55E-02
Ps90%/90% (+KTL) Un-Biased	1.48E-02	1.92E-02	2.11E-02	1.16E-02	-1.49E-02	3.24E-02	3.20E-02
Ps90%/90% (-KTL) Un-Biased	-1.48E-02	-2.52E-02	-4.27E-02	-4.60E-02	-2.75E-02	-7.28E-02	-5.28E-02
<b>Specification MIN</b>	<b>-2.00E-01</b>	<b>-2.00E-01</b>	<b>-2.10E-01</b>	<b>-2.30E-01</b>	<b>-2.30E-01</b>	<b>-2.30E-01</b>	<b>-2.30E-01</b>
Status	PASS	PASS	PASS	PASS	PASS	PASS	PASS
<b>Specification MAX</b>	<b>2.00E-01</b>	<b>2.00E-01</b>	<b>2.10E-01</b>	<b>2.30E-01</b>	<b>2.30E-01</b>	<b>2.30E-01</b>	<b>2.30E-01</b>
Status	PASS	PASS	PASS	PASS	PASS	PASS	PASS

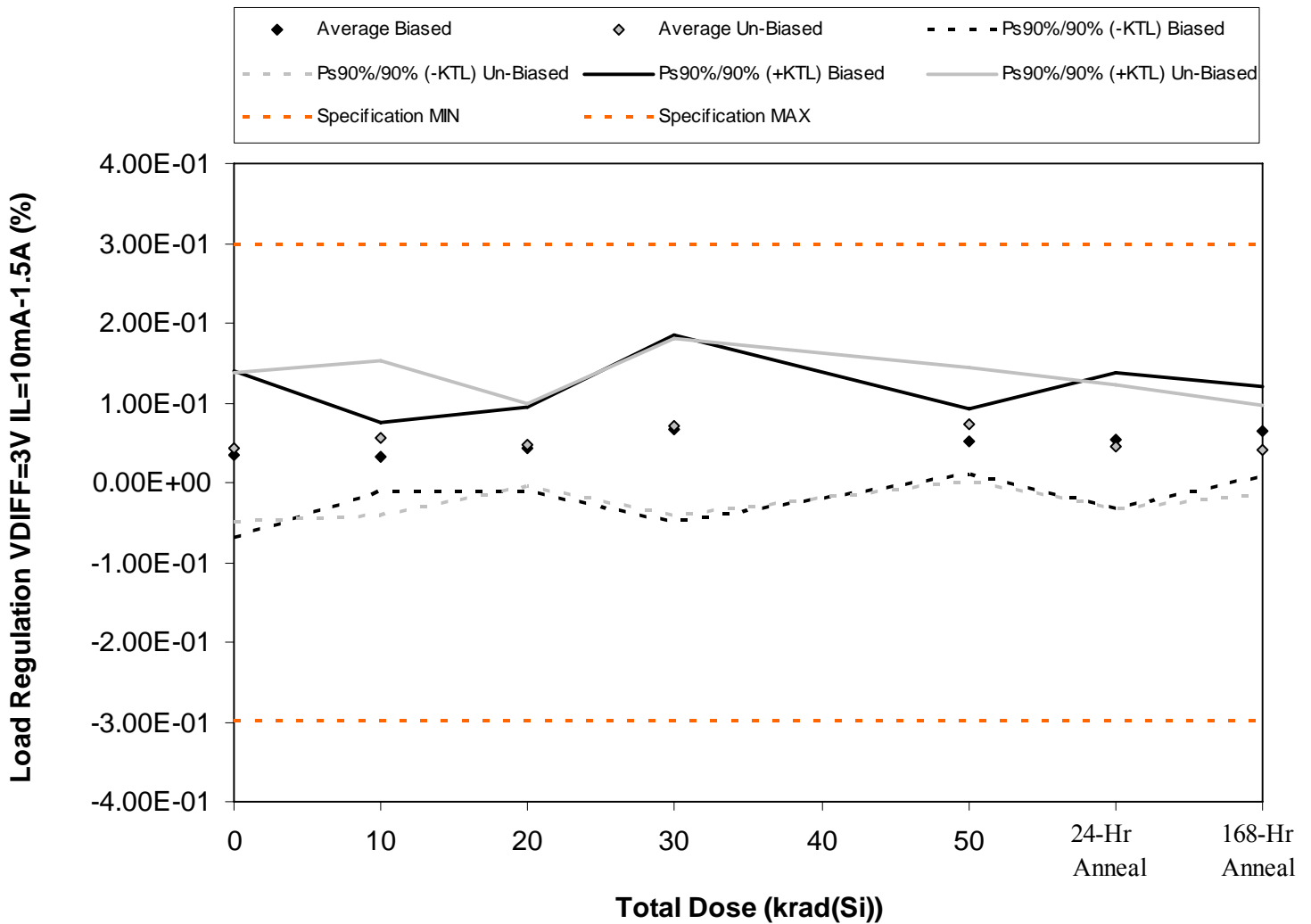

Figure 5.7. Plot of Load Regulation VDIFF=3V IL=10mA-1.5A (%) versus total dose. The solid diamonds are the average of the measured data points for the samples irradiated under electrical bias while the shaded diamonds are the average of the measured data points for the samples irradiated with all pins tied to ground. The black lines (solid and/or dashed) are the average of the data points after application of the KTL statistics on the samples irradiated under electrical bias while the gray lines (solid and/or dashed) are the average of the data points after application of the KTL statistics on the samples irradiated in the unbiased condition. The red dotted line(s) are the pre- and/or post-irradiation minimum and/or maximum specification value as defined in the datasheet and/or test plan.



Table 5.7. Raw data for Load Regulation VDIFF=3V IL=10mA-1.5A (%) versus total dose, including the statistical analysis, specification and the status of the testing (pass/fail).

Load Regulation VDIFF=3V IL=10mA-1.5A (%)	Total Dose (krad(Si))					24-hr Anneal	168-hr Anneal
	0	10	20	30	50		
Device							
4	2.20E-02	3.60E-02	1.20E-02	7.00E-02	5.80E-02	3.90E-02	9.60E-02
8	1.03E-01	5.10E-02	5.50E-02	1.39E-01	5.90E-02	3.50E-02	6.30E-02
11	2.40E-02	4.30E-02	5.30E-02	2.80E-02	5.50E-02	3.70E-02	6.50E-02
14	7.00E-03	2.20E-02	5.80E-02	5.10E-02	6.20E-02	1.08E-01	6.00E-02
17	2.10E-02	1.20E-02	3.60E-02	4.80E-02	2.60E-02	4.70E-02	3.80E-02
19	4.30E-02	5.40E-02	2.80E-02	1.11E-01	5.50E-02	1.80E-02	4.30E-02
41	5.10E-02	4.30E-02	6.40E-02	9.80E-02	6.10E-02	4.70E-02	5.00E-02
60	3.10E-02	4.20E-02	3.00E-02	8.90E-02	6.90E-02	5.90E-02	1.20E-02
62	9.40E-02	2.30E-02	4.70E-02	3.10E-02	6.10E-02	8.50E-02	6.60E-02
65	1.00E-03	1.16E-01	6.90E-02	2.30E-02	1.18E-01	1.90E-02	3.20E-02
149	9.80E-02	5.80E-02	8.30E-02	5.50E-02	5.50E-02	3.60E-02	3.60E-02
153	5.40E-02	9.00E-03	4.70E-02	5.30E-02	1.01E-01	4.70E-02	4.90E-02
<b>Biased Statistics</b>							
Average Biased	3.54E-02	3.28E-02	4.28E-02	6.72E-02	5.20E-02	5.32E-02	6.44E-02
Std Dev Biased	3.84E-02	1.58E-02	1.92E-02	4.28E-02	1.47E-02	3.10E-02	2.07E-02
Ps90%/90% (+KTL) Biased	1.41E-01	7.60E-02	9.55E-02	1.85E-01	9.24E-02	1.38E-01	1.21E-01
Ps90%/90% (-KTL) Biased	-6.98E-02	-1.04E-02	-9.92E-03	-5.02E-02	1.16E-02	-3.17E-02	7.59E-03
<b>Un-Biased Statistics</b>							
Average Un-Biased	4.40E-02	5.56E-02	4.76E-02	7.04E-02	7.28E-02	4.56E-02	4.06E-02
Std Dev Un-Biased	3.38E-02	3.56E-02	1.88E-02	4.05E-02	2.58E-02	2.83E-02	2.02E-02
Ps90%/90% (+KTL) Un-Biased	1.37E-01	1.53E-01	9.93E-02	1.81E-01	1.43E-01	1.23E-01	9.60E-02
Ps90%/90% (-KTL) Un-Biased	-4.87E-02	-4.19E-02	-4.09E-03	-4.06E-02	2.19E-03	-3.20E-02	-1.48E-02
<b>Specification MIN</b>	<b>-3.00E-01</b>	<b>-3.00E-01</b>	<b>-3.00E-01</b>	<b>-3.00E-01</b>	<b>-3.00E-01</b>	<b>-3.00E-01</b>	<b>-3.00E-01</b>
Status	PASS	PASS	PASS	PASS	PASS	PASS	PASS
<b>Specification MAX</b>	<b>3.00E-01</b>	<b>3.00E-01</b>	<b>3.00E-01</b>	<b>3.00E-01</b>	<b>3.00E-01</b>	<b>3.00E-01</b>	<b>3.00E-01</b>
Status	PASS	PASS	PASS	PASS	PASS	PASS	PASS

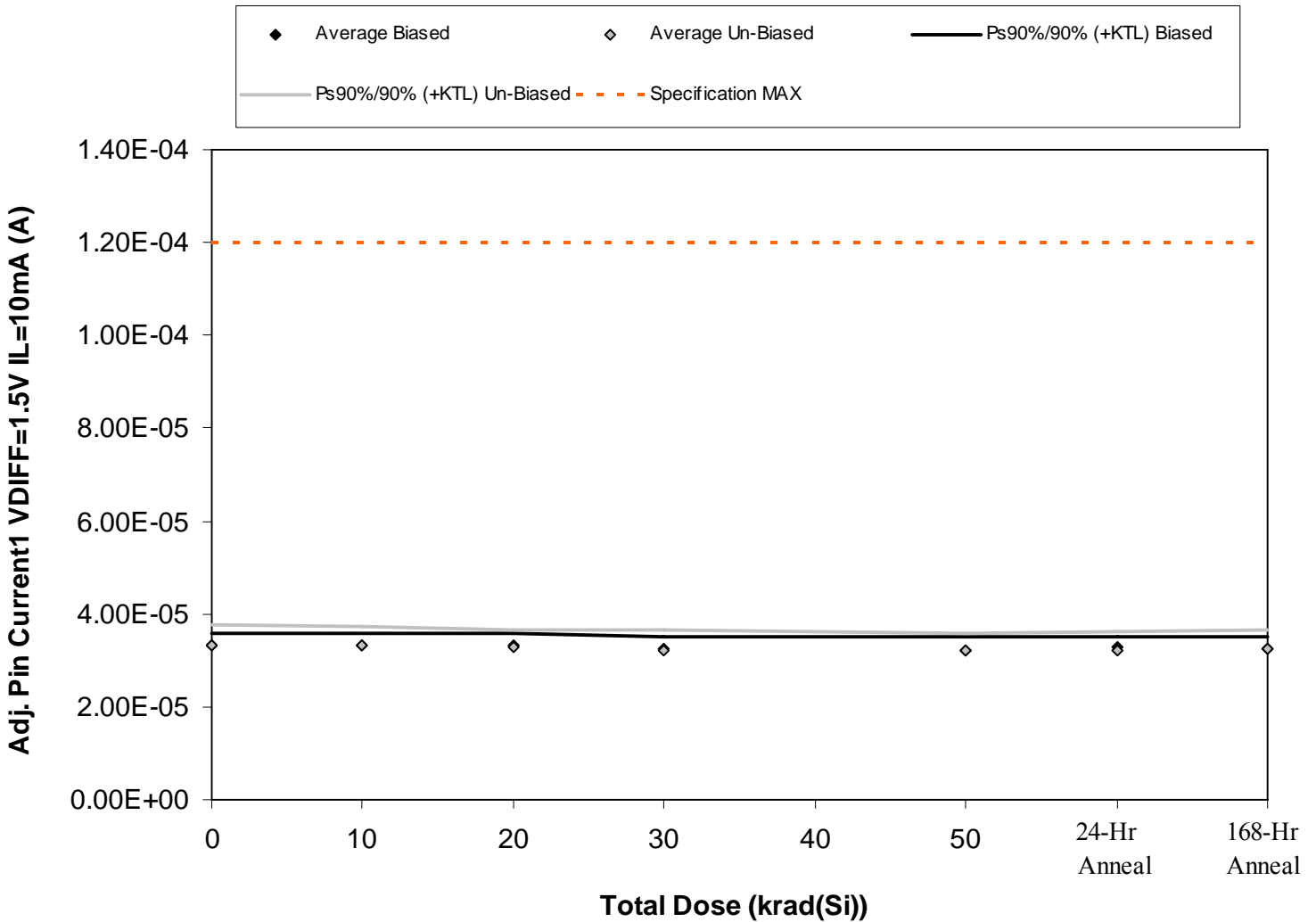

Figure 5.8. Plot of Adj. Pin Current1 VDIFF=1.5V IL=10mA (A) versus total dose. The solid diamonds are the average of the measured data points for the samples irradiated under electrical bias while the shaded diamonds are the average of the measured data points for the samples irradiated with all pins tied to ground. The black lines (solid and/or dashed) are the average of the data points after application of the KTL statistics on the samples irradiated under electrical bias while the gray lines (solid and/or dashed) are the average of the data points after application of the KTL statistics on the samples irradiated in the unbiased condition. The red dotted line(s) are the pre- and/or post-irradiation minimum and/or maximum specification value as defined in the datasheet and/or test plan.



Table 5.8. Raw data for Adj. Pin Current1 VDIFF=1.5V IL=10mA (A) versus total dose, including the statistical analysis, specification and the status of the testing (pass/fail).

Adj. Pin Current1 VDIFF=1.5V IL=10mA (A)	Total Dose (krad(Si))					24-hr Anneal	168-hr Anneal
	0	10	20	30	50		
Device							
4	3.38E-05	3.35E-05	3.34E-05	3.30E-05	3.27E-05	3.33E-05	3.31E-05
8	3.27E-05	3.28E-05	3.28E-05	3.15E-05	3.10E-05	3.24E-05	3.19E-05
11	3.37E-05	3.36E-05	3.36E-05	3.31E-05	3.28E-05	3.32E-05	3.31E-05
14	3.44E-05	3.46E-05	3.41E-05	3.33E-05	3.31E-05	3.34E-05	3.36E-05
17	3.21E-05	3.20E-05	3.17E-05	3.10E-05	3.08E-05	3.15E-05	3.14E-05
19	3.39E-05	3.39E-05	3.35E-05	3.32E-05	3.28E-05	3.31E-05	3.32E-05
41	3.31E-05	3.31E-05	3.24E-05	3.17E-05	3.17E-05	3.22E-05	3.22E-05
60	3.57E-05	3.54E-05	3.48E-05	3.43E-05	3.40E-05	3.43E-05	3.47E-05
62	3.23E-05	3.19E-05	3.15E-05	3.07E-05	3.06E-05	3.09E-05	3.11E-05
65	3.17E-05	3.17E-05	3.15E-05	3.07E-05	3.07E-05	3.11E-05	3.10E-05
149	3.21E-05	3.25E-05	3.23E-05	3.17E-05	3.13E-05	3.17E-05	3.18E-05
153	3.33E-05	3.37E-05	3.32E-05	3.31E-05	3.31E-05	3.31E-05	3.31E-05
<b>Biased Statistics</b>							
Average Biased	3.33E-05	3.33E-05	3.31E-05	3.24E-05	3.21E-05	3.27E-05	3.26E-05
Std Dev Biased	9.24E-07	9.72E-07	9.30E-07	1.04E-06	1.10E-06	8.14E-07	9.27E-07
Ps90%/90% (+KTL) Biased	3.58E-05	3.60E-05	3.57E-05	3.52E-05	3.51E-05	3.50E-05	3.52E-05
Ps90%/90% (-KTL) Biased	3.08E-05	3.06E-05	3.06E-05	2.95E-05	2.91E-05	3.05E-05	3.01E-05
<b>Un-Biased Statistics</b>							
Average Un-Biased	3.33E-05	3.32E-05	3.27E-05	3.21E-05	3.20E-05	3.23E-05	3.24E-05
Std Dev Un-Biased	1.55E-06	1.54E-06	1.42E-06	1.60E-06	1.44E-06	1.41E-06	1.56E-06
Ps90%/90% (+KTL) Un-Biased	3.76E-05	3.74E-05	3.66E-05	3.65E-05	3.59E-05	3.62E-05	3.67E-05
Ps90%/90% (-KTL) Un-Biased	2.91E-05	2.90E-05	2.88E-05	2.77E-05	2.80E-05	2.84E-05	2.82E-05
<b>Specification MAX</b>	<b>1.20E-04</b>	<b>1.20E-04</b>	<b>1.20E-04</b>	<b>1.20E-04</b>	<b>1.20E-04</b>	<b>1.20E-04</b>	<b>1.20E-04</b>
Status	PASS	PASS	PASS	PASS	PASS	PASS	PASS

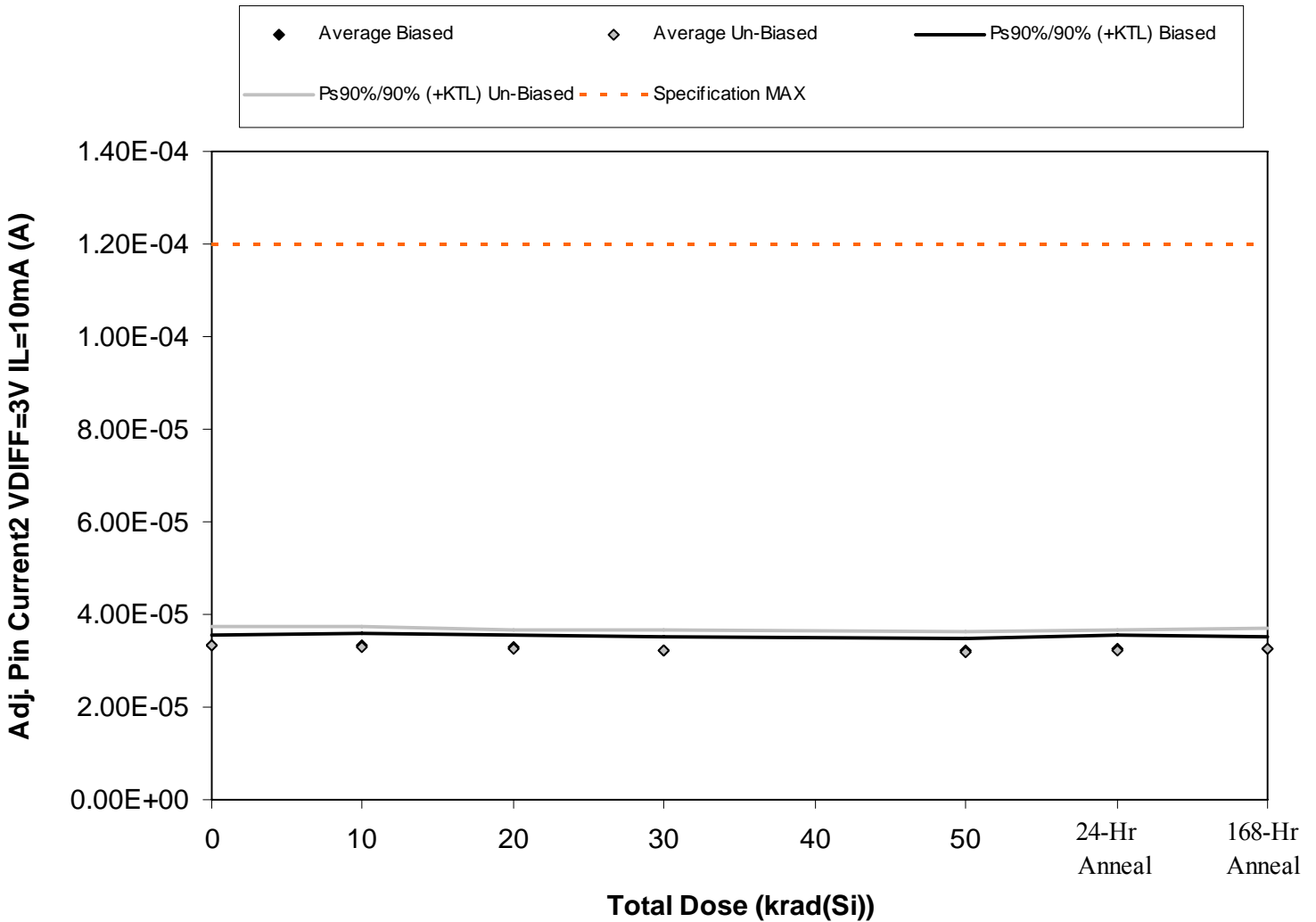

Figure 5.9. Plot of Adj. Pin Current2 VDIFF=3V IL=10mA (A) versus total dose. The solid diamonds are the average of the measured data points for the samples irradiated under electrical bias while the shaded diamonds are the average of the measured data points for the samples irradiated with all pins tied to ground. The black lines (solid and/or dashed) are the average of the data points after application of the KTL statistics on the samples irradiated under electrical bias while the gray lines (solid and/or dashed) are the average of the data points after application of the KTL statistics on the samples irradiated in the unbiased condition. The red dotted line(s) are the pre- and/or post-irradiation minimum and/or maximum specification value as defined in the datasheet and/or test plan.





Table 5.9. Raw data for Adj. Pin Current2 VDIFF=3V IL=10mA (A) versus total dose, including the statistical analysis, specification and the status of the testing (pass/fail).

Adj. Pin Current2 VDIFF=3V IL=10mA (A)	Total Dose (krad(Si))					24-hr Anneal	168-hr Anneal
	0	10	20	30	50		
Device							
4	3.38E-05	3.34E-05	3.34E-05	3.28E-05	3.27E-05	3.33E-05	3.31E-05
8	3.28E-05	3.27E-05	3.26E-05	3.13E-05	3.11E-05	3.22E-05	3.18E-05
11	3.36E-05	3.35E-05	3.36E-05	3.31E-05	3.26E-05	3.35E-05	3.32E-05
14	3.43E-05	3.46E-05	3.40E-05	3.33E-05	3.31E-05	3.36E-05	3.37E-05
17	3.20E-05	3.18E-05	3.18E-05	3.11E-05	3.07E-05	3.13E-05	3.15E-05
19	3.37E-05	3.38E-05	3.35E-05	3.31E-05	3.31E-05	3.31E-05	3.33E-05
41	3.31E-05	3.31E-05	3.24E-05	3.16E-05	3.15E-05	3.21E-05	3.21E-05
60	3.55E-05	3.53E-05	3.48E-05	3.44E-05	3.41E-05	3.45E-05	3.48E-05
62	3.20E-05	3.18E-05	3.12E-05	3.08E-05	3.05E-05	3.09E-05	3.11E-05
65	3.17E-05	3.16E-05	3.15E-05	3.07E-05	3.07E-05	3.09E-05	3.09E-05
149	3.21E-05	3.30E-05	3.19E-05	3.17E-05	3.13E-05	3.18E-05	3.19E-05
153	3.32E-05	3.37E-05	3.32E-05	3.30E-05	3.28E-05	3.31E-05	3.31E-05
<b>Biased Statistics</b>							
Average Biased	3.33E-05	3.32E-05	3.31E-05	3.23E-05	3.20E-05	3.28E-05	3.26E-05
Std Dev Biased	8.85E-07	1.03E-06	8.76E-07	1.04E-06	1.06E-06	9.91E-07	9.71E-07
Ps90%/90% (+KTL) Biased	3.57E-05	3.60E-05	3.55E-05	3.52E-05	3.49E-05	3.55E-05	3.53E-05
Ps90%/90% (-KTL) Biased	3.09E-05	3.04E-05	3.07E-05	2.95E-05	2.91E-05	3.01E-05	3.00E-05
<b>Un-Biased Statistics</b>							
Average Un-Biased	3.32E-05	3.31E-05	3.27E-05	3.21E-05	3.20E-05	3.23E-05	3.24E-05
Std Dev Un-Biased	1.53E-06	1.51E-06	1.48E-06	1.59E-06	1.56E-06	1.53E-06	1.61E-06
Ps90%/90% (+KTL) Un-Biased	3.74E-05	3.73E-05	3.68E-05	3.65E-05	3.62E-05	3.65E-05	3.69E-05
Ps90%/90% (-KTL) Un-Biased	2.90E-05	2.90E-05	2.86E-05	2.77E-05	2.77E-05	2.81E-05	2.80E-05
<b>Specification MAX</b>	<b>1.20E-04</b>	<b>1.20E-04</b>	<b>1.20E-04</b>	<b>1.20E-04</b>	<b>1.20E-04</b>	<b>1.20E-04</b>	<b>1.20E-04</b>
Status	PASS	PASS	PASS	PASS	PASS	PASS	PASS

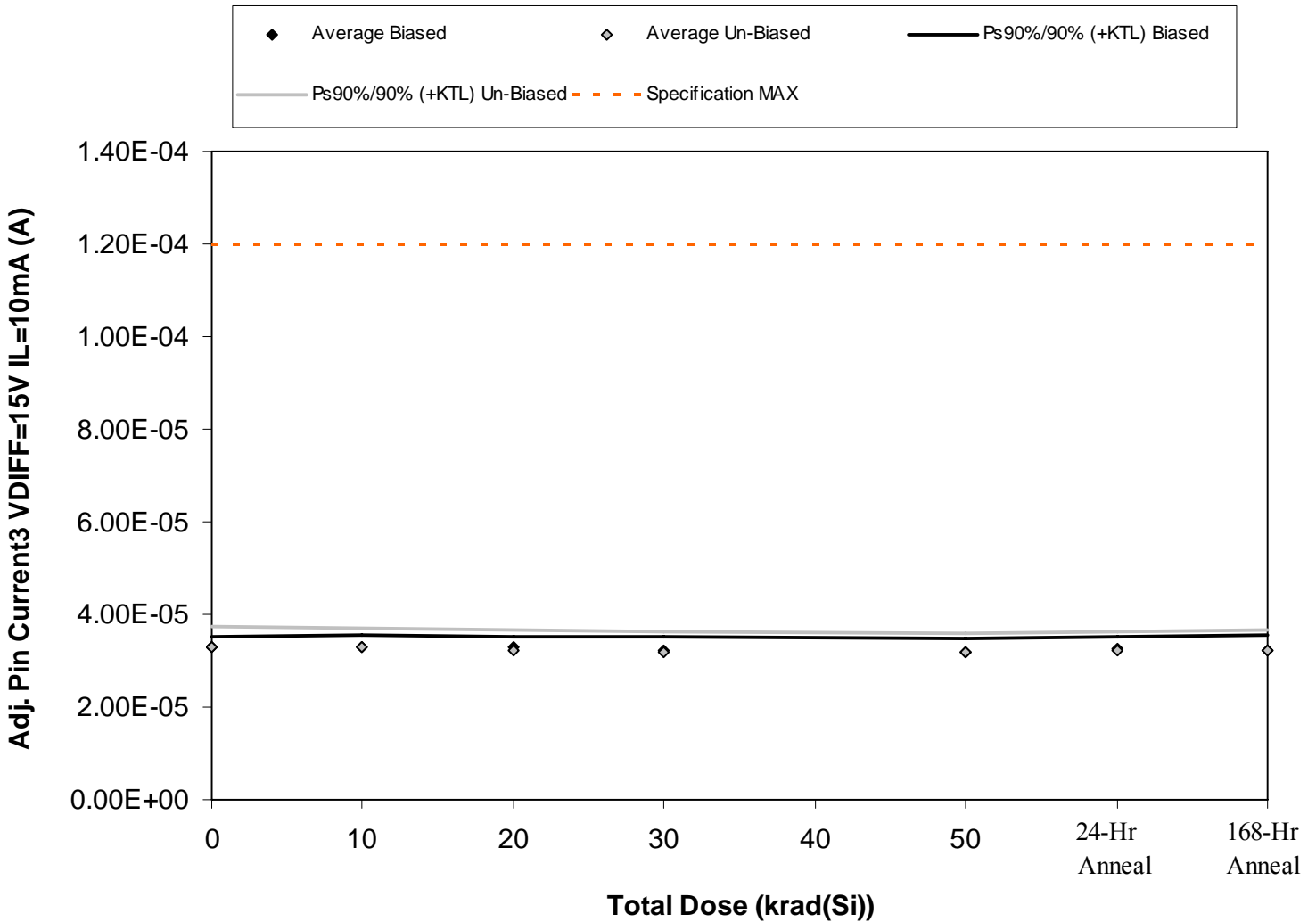

Figure 5.10. Plot of Adj. Pin Current3 VDIFF=15V IL=10mA (A) versus total dose. The solid diamonds are the average of the measured data points for the samples irradiated under electrical bias while the shaded diamonds are the average of the measured data points for the samples irradiated with all pins tied to ground. The black lines (solid and/or dashed) are the average of the data points after application of the KTL statistics on the samples irradiated under electrical bias while the gray lines (solid and/or dashed) are the average of the data points after application of the KTL statistics on the samples irradiated in the unbiased condition. The red dotted line(s) are the pre- and/or post-irradiation minimum and/or maximum specification value as defined in the datasheet and/or test plan.



**ELDRS Report  
10-006 100412 R1.3**

**Radiation Assured Devices  
5017 N. 30th Street  
Colorado Springs, CO 80919  
(719) 531-0800**

Table 5.10. Raw data for Adj. Pin Current3 VDIFF=15V IL=10mA (A) versus total dose, including the statistical analysis, specification and the status of the testing (pass/fail).

Adj. Pin Current3 VDIFF=15V IL=10mA (A)	Total Dose (krad(Si))					24-hr Anneal	168-hr Anneal
	0	10	20	30	50		
Device							
4	3.33E-05	3.32E-05	3.34E-05	3.28E-05	3.22E-05	3.31E-05	3.31E-05
8	3.30E-05	3.21E-05	3.22E-05	3.12E-05	3.09E-05	3.18E-05	3.15E-05
11	3.32E-05	3.32E-05	3.33E-05	3.30E-05	3.24E-05	3.31E-05	3.31E-05
14	3.39E-05	3.40E-05	3.37E-05	3.31E-05	3.31E-05	3.32E-05	3.33E-05
17	3.17E-05	3.17E-05	3.15E-05	3.08E-05	3.05E-05	3.11E-05	3.09E-05
19	3.35E-05	3.36E-05	3.32E-05	3.31E-05	3.24E-05	3.31E-05	3.31E-05
41	3.31E-05	3.30E-05	3.19E-05	3.15E-05	3.14E-05	3.19E-05	3.19E-05
60	3.53E-05	3.51E-05	3.46E-05	3.40E-05	3.39E-05	3.42E-05	3.46E-05
62	3.17E-05	3.17E-05	3.10E-05	3.05E-05	3.04E-05	3.08E-05	3.09E-05
65	3.14E-05	3.14E-05	3.11E-05	3.03E-05	3.04E-05	3.08E-05	3.09E-05
149	3.17E-05	3.22E-05	3.20E-05	3.14E-05	3.10E-05	3.16E-05	3.15E-05
153	3.32E-05	3.33E-05	3.31E-05	3.25E-05	3.23E-05	3.30E-05	3.31E-05
<b>Biased Statistics</b>							
Average Biased	3.30E-05	3.28E-05	3.28E-05	3.22E-05	3.18E-05	3.25E-05	3.24E-05
Std Dev Biased	8.32E-07	9.38E-07	9.17E-07	1.08E-06	1.10E-06	9.61E-07	1.10E-06
Ps90%/90% (+KTL) Biased	3.53E-05	3.54E-05	3.53E-05	3.51E-05	3.48E-05	3.51E-05	3.54E-05
Ps90%/90% (-KTL) Biased	3.07E-05	3.03E-05	3.03E-05	2.92E-05	2.88E-05	2.98E-05	2.94E-05
<b>Un-Biased Statistics</b>							
Average Un-Biased	3.30E-05	3.30E-05	3.24E-05	3.19E-05	3.17E-05	3.22E-05	3.23E-05
Std Dev Un-Biased	1.56E-06	1.49E-06	1.53E-06	1.64E-06	1.49E-06	1.48E-06	1.57E-06
Ps90%/90% (+KTL) Un-Biased	3.73E-05	3.70E-05	3.66E-05	3.64E-05	3.58E-05	3.62E-05	3.66E-05
Ps90%/90% (-KTL) Un-Biased	2.87E-05	2.89E-05	2.82E-05	2.74E-05	2.76E-05	2.81E-05	2.79E-05
<b>Specification MAX</b>	<b>1.20E-04</b>	<b>1.20E-04</b>	<b>1.20E-04</b>	<b>1.20E-04</b>	<b>1.20E-04</b>	<b>1.20E-04</b>	<b>1.20E-04</b>
Status	PASS	PASS	PASS	PASS	PASS	PASS	PASS

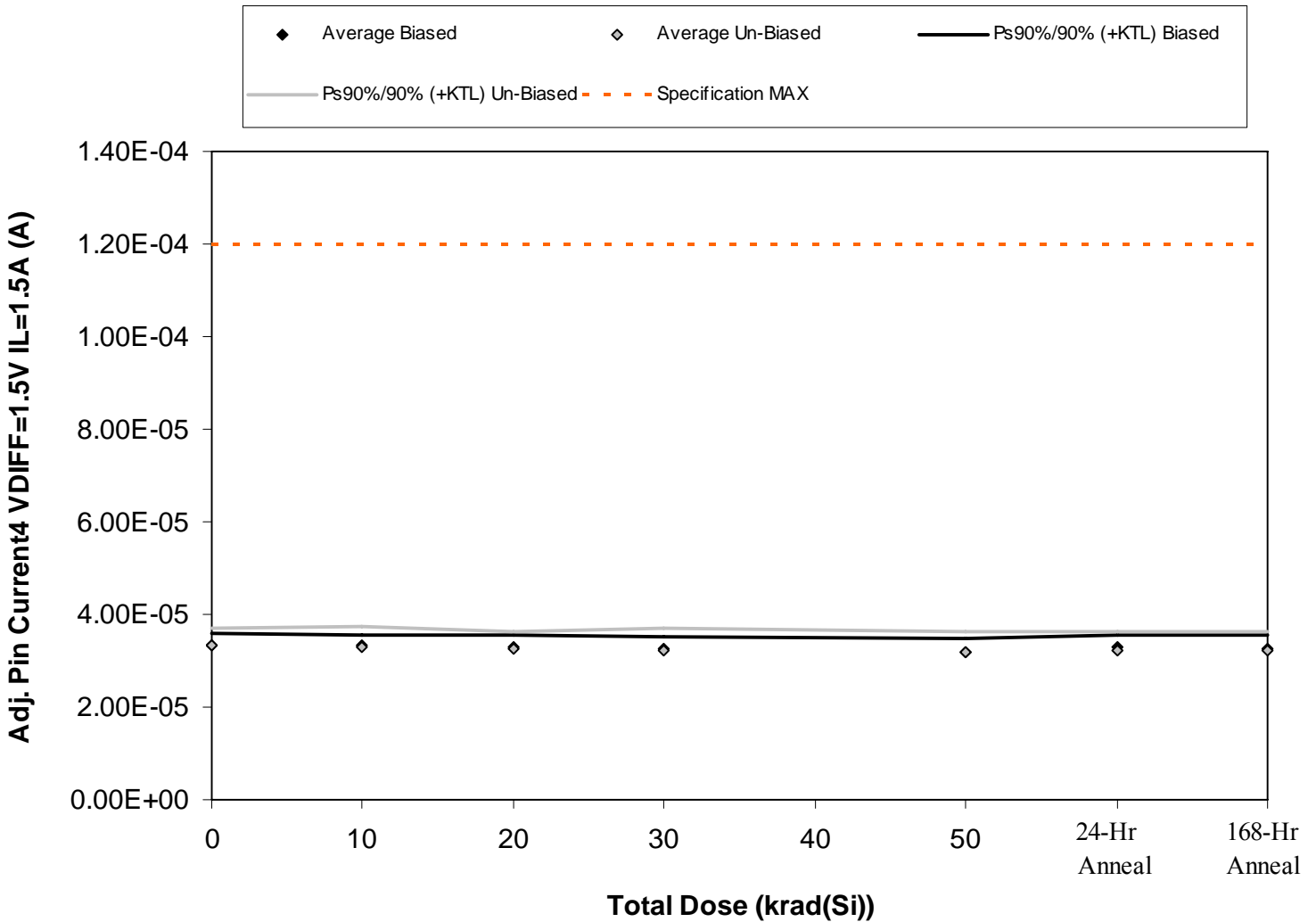

Figure 5.11. Plot of Adj. Pin Current<sub>4</sub> VDIFF=1.5V IL=1.5A (A) versus total dose. The solid diamonds are the average of the measured data points for the samples irradiated under electrical bias while the shaded diamonds are the average of the measured data points for the samples irradiated with all pins tied to ground. The black lines (solid and/or dashed) are the average of the data points after application of the KTL statistics on the samples irradiated under electrical bias while the gray lines (solid and/or dashed) are the average of the data points after application of the KTL statistics on the samples irradiated in the unbiased condition. The red dotted line(s) are the pre- and/or post-irradiation minimum and/or maximum specification value as defined in the datasheet and/or test plan.



Table 5.11. Raw data for Adj. Pin Current4 VDIFF=1.5V IL=1.5A (A) versus total dose, including the statistical analysis, specification and the status of the testing (pass/fail).

Adj. Pin Current4 VDIFF=1.5V IL=1.5A (A)	Total Dose (krad(Si))					24-hr Anneal	168-hr Anneal
	0	10	20	30	50		
Device							
4	3.35E-05	3.38E-05	3.35E-05	3.31E-05	3.24E-05	3.31E-05	3.31E-05
8	3.31E-05	3.31E-05	3.20E-05	3.17E-05	3.12E-05	3.20E-05	3.17E-05
11	3.35E-05	3.38E-05	3.33E-05	3.31E-05	3.22E-05	3.31E-05	3.31E-05
14	3.46E-05	3.39E-05	3.38E-05	3.32E-05	3.31E-05	3.42E-05	3.38E-05
17	3.20E-05	3.18E-05	3.14E-05	3.10E-05	3.06E-05	3.16E-05	3.13E-05
19	3.35E-05	3.38E-05	3.33E-05	3.33E-05	3.31E-05	3.31E-05	3.31E-05
41	3.31E-05	3.31E-05	3.20E-05	3.17E-05	3.14E-05	3.17E-05	3.20E-05
60	3.53E-05	3.53E-05	3.46E-05	3.46E-05	3.38E-05	3.46E-05	3.46E-05
62	3.31E-05	3.16E-05	3.13E-05	3.11E-05	3.02E-05	3.11E-05	3.11E-05
65	3.16E-05	3.18E-05	3.13E-05	3.03E-05	3.06E-05	3.09E-05	3.09E-05
149	3.20E-05	3.31E-05	3.18E-05	3.17E-05	3.11E-05	3.18E-05	3.17E-05
153	3.31E-05	3.35E-05	3.33E-05	3.24E-05	3.24E-05	3.31E-05	3.31E-05
<b>Biased Statistics</b>							
Average Biased	3.33E-05	3.33E-05	3.28E-05	3.24E-05	3.19E-05	3.28E-05	3.26E-05
Std Dev Biased	9.11E-07	8.86E-07	1.05E-06	1.01E-06	1.01E-06	1.01E-06	1.08E-06
Ps90%/90% (+KTL) Biased	3.58E-05	3.57E-05	3.57E-05	3.52E-05	3.46E-05	3.56E-05	3.55E-05
Ps90%/90% (-KTL) Biased	3.08E-05	3.09E-05	2.99E-05	2.96E-05	2.91E-05	3.00E-05	2.96E-05
<b>Un-Biased Statistics</b>							
Average Un-Biased	3.33E-05	3.31E-05	3.25E-05	3.22E-05	3.18E-05	3.23E-05	3.23E-05
Std Dev Un-Biased	1.30E-06	1.50E-06	1.42E-06	1.72E-06	1.59E-06	1.53E-06	1.51E-06
Ps90%/90% (+KTL) Un-Biased	3.69E-05	3.72E-05	3.64E-05	3.69E-05	3.62E-05	3.65E-05	3.65E-05
Ps90%/90% (-KTL) Un-Biased	2.98E-05	2.90E-05	2.86E-05	2.75E-05	2.75E-05	2.81E-05	2.82E-05
<b>Specification MAX</b>	<b>1.20E-04</b>	<b>1.20E-04</b>	<b>1.20E-04</b>	<b>1.20E-04</b>	<b>1.20E-04</b>	<b>1.20E-04</b>	<b>1.20E-04</b>
Status	PASS	PASS	PASS	PASS	PASS	PASS	PASS

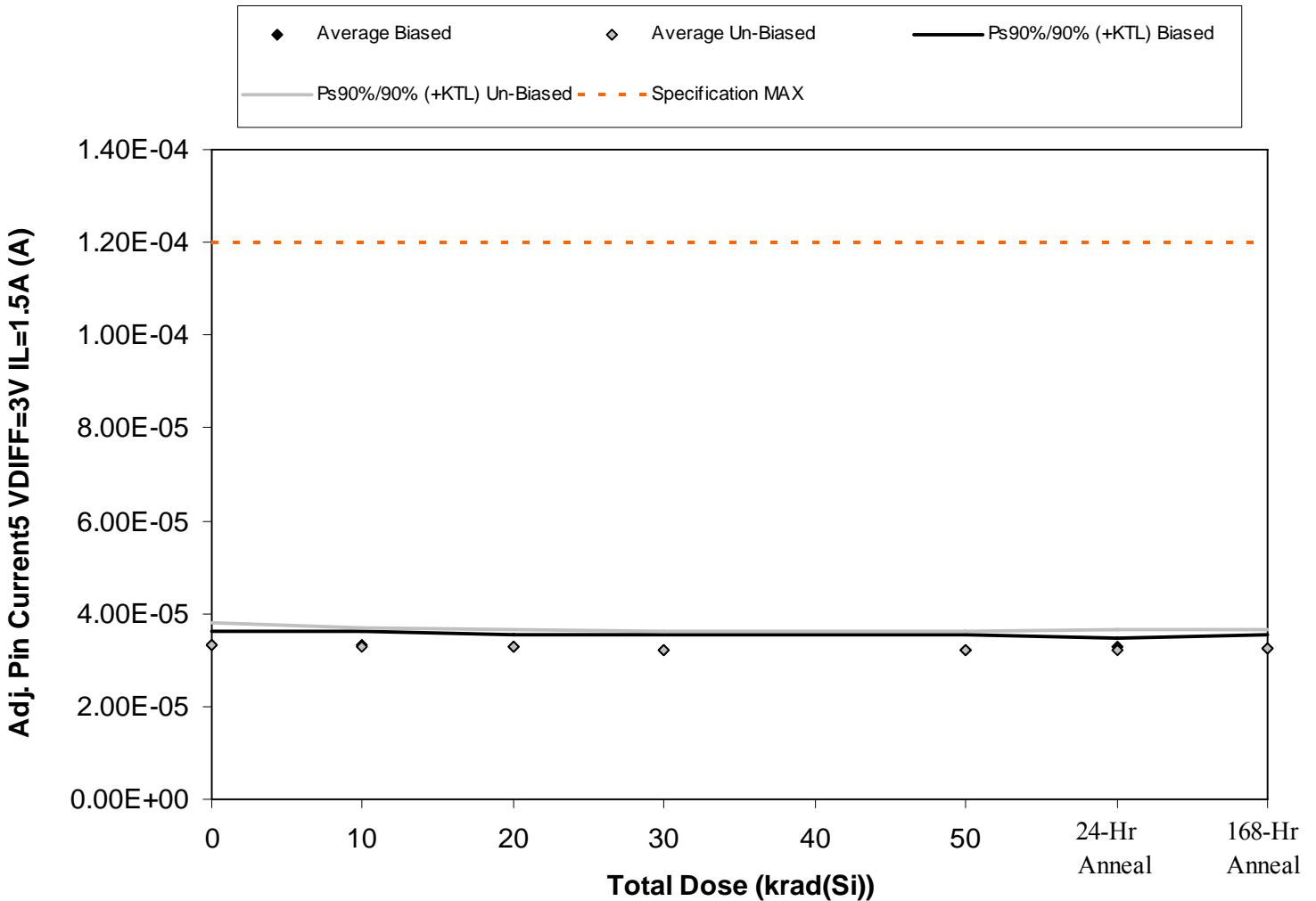

Figure 5.12. Plot of Adj. Pin Current5 VDIFF=3V IL=1.5A (A) versus total dose. The solid diamonds are the average of the measured data points for the samples irradiated under electrical bias while the shaded diamonds are the average of the measured data points for the samples irradiated with all pins tied to ground. The black lines (solid and/or dashed) are the average of the data points after application of the KTL statistics on the samples irradiated under electrical bias while the gray lines (solid and/or dashed) are the average of the data points after application of the KTL statistics on the samples irradiated in the unbiased condition. The red dotted line(s) are the pre- and/or post-irradiation minimum and/or maximum specification value as defined in the datasheet and/or test plan.



Table 5.12. Raw data for Adj. Pin Current5 VDIFF=3V IL=1.5A (A) versus total dose, including the statistical analysis, specification and the status of the testing (pass/fail).

Adj. Pin Current5 VDIFF=3V IL=1.5A (A)	Total Dose (krad(Si))					24-hr Anneal	168-hr Anneal
	0	10	20	30	50		
Device							
4	3.35E-05	3.31E-05	3.31E-05	3.31E-05	3.24E-05	3.33E-05	3.31E-05
8	3.24E-05	3.24E-05	3.31E-05	3.13E-05	3.09E-05	3.31E-05	3.17E-05
11	3.38E-05	3.38E-05	3.36E-05	3.31E-05	3.31E-05	3.31E-05	3.31E-05
14	3.46E-05	3.46E-05	3.38E-05	3.31E-05	3.31E-05	3.33E-05	3.38E-05
17	3.16E-05	3.16E-05	3.17E-05	3.09E-05	3.06E-05	3.16E-05	3.13E-05
19	3.46E-05	3.39E-05	3.31E-05	3.31E-05	3.31E-05	3.31E-05	3.31E-05
41	3.31E-05	3.31E-05	3.31E-05	3.17E-05	3.18E-05	3.18E-05	3.24E-05
60	3.56E-05	3.47E-05	3.47E-05	3.42E-05	3.42E-05	3.46E-05	3.46E-05
62	3.20E-05	3.16E-05	3.17E-05	3.09E-05	3.09E-05	3.06E-05	3.10E-05
65	3.16E-05	3.16E-05	3.13E-05	3.06E-05	3.06E-05	3.09E-05	3.09E-05
149	3.16E-05	3.24E-05	3.24E-05	3.17E-05	3.17E-05	3.16E-05	3.31E-05
153	3.32E-05	3.38E-05	3.32E-05	3.31E-05	3.31E-05	3.31E-05	3.31E-05
<b>Biased Statistics</b>							
Average Biased	3.32E-05	3.31E-05	3.30E-05	3.23E-05	3.20E-05	3.29E-05	3.26E-05
Std Dev Biased	1.16E-06	1.15E-06	8.40E-07	1.10E-06	1.20E-06	6.96E-07	1.06E-06
Ps90%/90% (+KTL) Biased	3.64E-05	3.62E-05	3.54E-05	3.53E-05	3.53E-05	3.48E-05	3.55E-05
Ps90%/90% (-KTL) Biased	3.00E-05	3.00E-05	3.07E-05	2.93E-05	2.87E-05	3.10E-05	2.97E-05
<b>Un-Biased Statistics</b>							
Average Un-Biased	3.34E-05	3.30E-05	3.28E-05	3.21E-05	3.21E-05	3.22E-05	3.24E-05
Std Dev Un-Biased	1.69E-06	1.37E-06	1.37E-06	1.53E-06	1.52E-06	1.64E-06	1.52E-06
Ps90%/90% (+KTL) Un-Biased	3.80E-05	3.68E-05	3.65E-05	3.63E-05	3.63E-05	3.67E-05	3.66E-05
Ps90%/90% (-KTL) Un-Biased	2.88E-05	2.93E-05	2.90E-05	2.79E-05	2.80E-05	2.77E-05	2.82E-05
<b>Specification MAX</b>	<b>1.20E-04</b>	<b>1.20E-04</b>	<b>1.20E-04</b>	<b>1.20E-04</b>	<b>1.20E-04</b>	<b>1.20E-04</b>	<b>1.20E-04</b>
Status	PASS	PASS	PASS	PASS	PASS	PASS	PASS

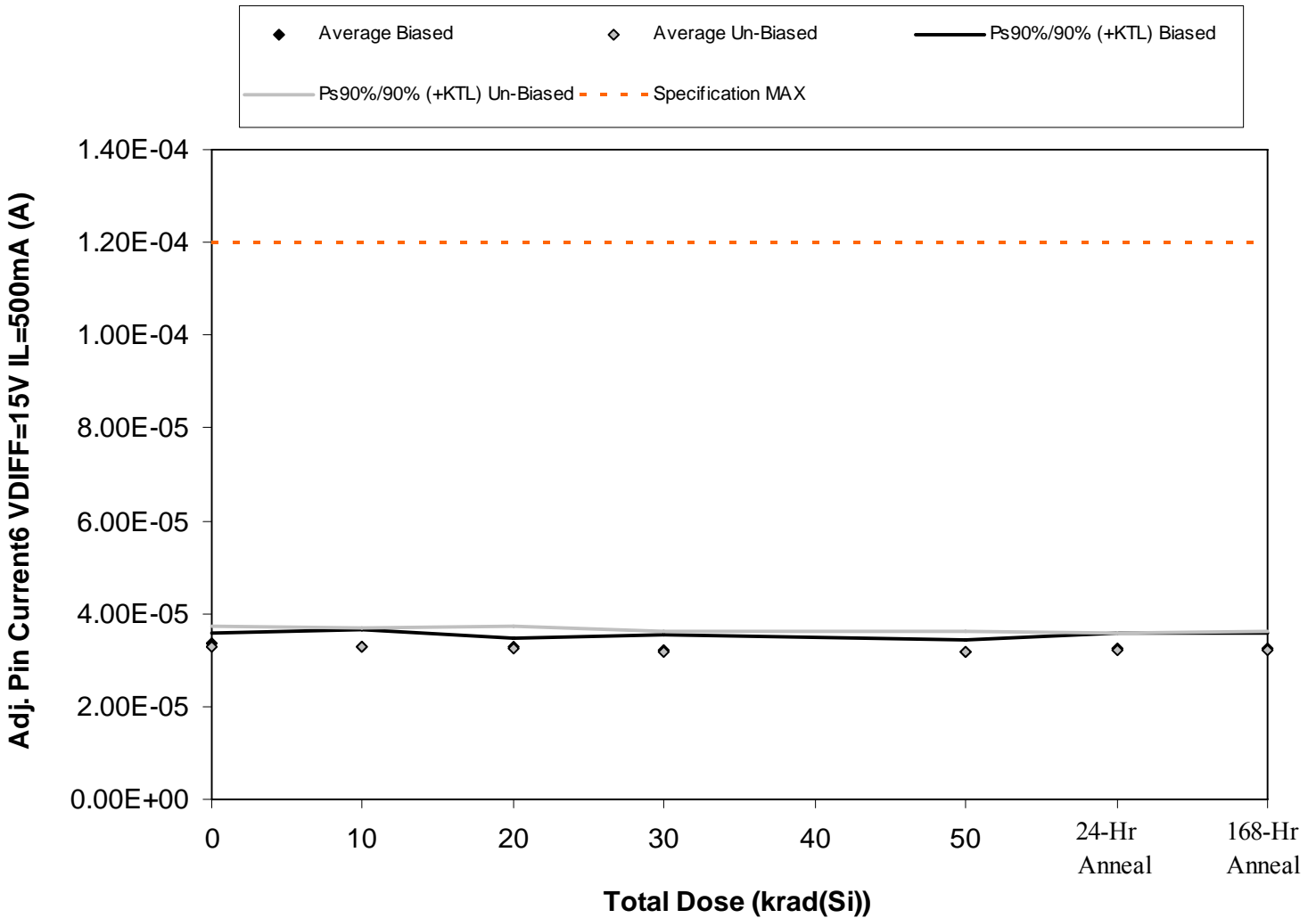

Figure 5.13. Plot of Adj. Pin Current6 VDIFF=15V IL=500mA (A) versus total dose. The solid diamonds are the average of the measured data points for the samples irradiated under electrical bias while the shaded diamonds are the average of the measured data points for the samples irradiated with all pins tied to ground. The black lines (solid and/or dashed) are the average of the data points after application of the KTL statistics on the samples irradiated under electrical bias while the gray lines (solid and/or dashed) are the average of the data points after application of the KTL statistics on the samples irradiated in the unbiased condition. The red dotted line(s) are the pre- and/or post-irradiation minimum and/or maximum specification value as defined in the datasheet and/or test plan.





Table 5.13. Raw data for Adj. Pin Current6 VDIFF=15V IL=500mA (A) versus total dose, including the statistical analysis, specification and the status of the testing (pass/fail).

Adj. Pin Current6 VDIFF=15V IL=500mA (A)	Total Dose (krad(Si))					24-hr Anneal	168-hr Anneal
	0	10	20	30	50		
Device							
4	3.35E-05	3.35E-05	3.32E-05	3.31E-05	3.24E-05	3.35E-05	3.33E-05
8	3.31E-05	3.18E-05	3.31E-05	3.12E-05	3.09E-05	3.16E-05	3.17E-05
11	3.38E-05	3.31E-05	3.31E-05	3.31E-05	3.22E-05	3.33E-05	3.31E-05
14	3.46E-05	3.46E-05	3.38E-05	3.31E-05	3.31E-05	3.35E-05	3.38E-05
17	3.24E-05	3.13E-05	3.20E-05	3.09E-05	3.09E-05	3.09E-05	3.10E-05
19	3.35E-05	3.35E-05	3.31E-05	3.31E-05	3.31E-05	3.31E-05	3.31E-05
41	3.31E-05	3.24E-05	3.20E-05	3.17E-05	3.17E-05	3.16E-05	3.17E-05
60	3.53E-05	3.53E-05	3.53E-05	3.38E-05	3.38E-05	3.40E-05	3.40E-05
62	3.24E-05	3.18E-05	3.11E-05	3.05E-05	3.03E-05	3.09E-05	3.06E-05
65	3.09E-05	3.16E-05	3.09E-05	3.02E-05	3.04E-05	3.09E-05	3.09E-05
149	3.16E-05	3.17E-05	3.18E-05	3.17E-05	3.09E-05	3.16E-05	3.11E-05
153	3.31E-05	3.35E-05	3.31E-05	3.31E-05	3.24E-05	3.31E-05	3.31E-05
<b>Biased Statistics</b>							
Average Biased	3.35E-05	3.29E-05	3.30E-05	3.23E-05	3.19E-05	3.26E-05	3.26E-05
Std Dev Biased	8.12E-07	1.34E-06	6.53E-07	1.12E-06	9.57E-07	1.19E-06	1.19E-06
Ps90%/90% (+KTL) Biased	3.57E-05	3.65E-05	3.48E-05	3.54E-05	3.45E-05	3.58E-05	3.58E-05
Ps90%/90% (-KTL) Biased	3.12E-05	2.92E-05	3.13E-05	2.92E-05	2.93E-05	2.93E-05	2.93E-05
<b>Un-Biased Statistics</b>							
Average Un-Biased	3.30E-05	3.29E-05	3.25E-05	3.19E-05	3.19E-05	3.21E-05	3.20E-05
Std Dev Un-Biased	1.59E-06	1.50E-06	1.79E-06	1.59E-06	1.59E-06	1.38E-06	1.47E-06
Ps90%/90% (+KTL) Un-Biased	3.74E-05	3.70E-05	3.74E-05	3.62E-05	3.62E-05	3.59E-05	3.61E-05
Ps90%/90% (-KTL) Un-Biased	2.87E-05	2.88E-05	2.76E-05	2.75E-05	2.75E-05	2.83E-05	2.80E-05
<b>Specification MAX</b>	<b>1.20E-04</b>	<b>1.20E-04</b>	<b>1.20E-04</b>	<b>1.20E-04</b>	<b>1.20E-04</b>	<b>1.20E-04</b>	<b>1.20E-04</b>
Status	PASS	PASS	PASS	PASS	PASS	PASS	PASS

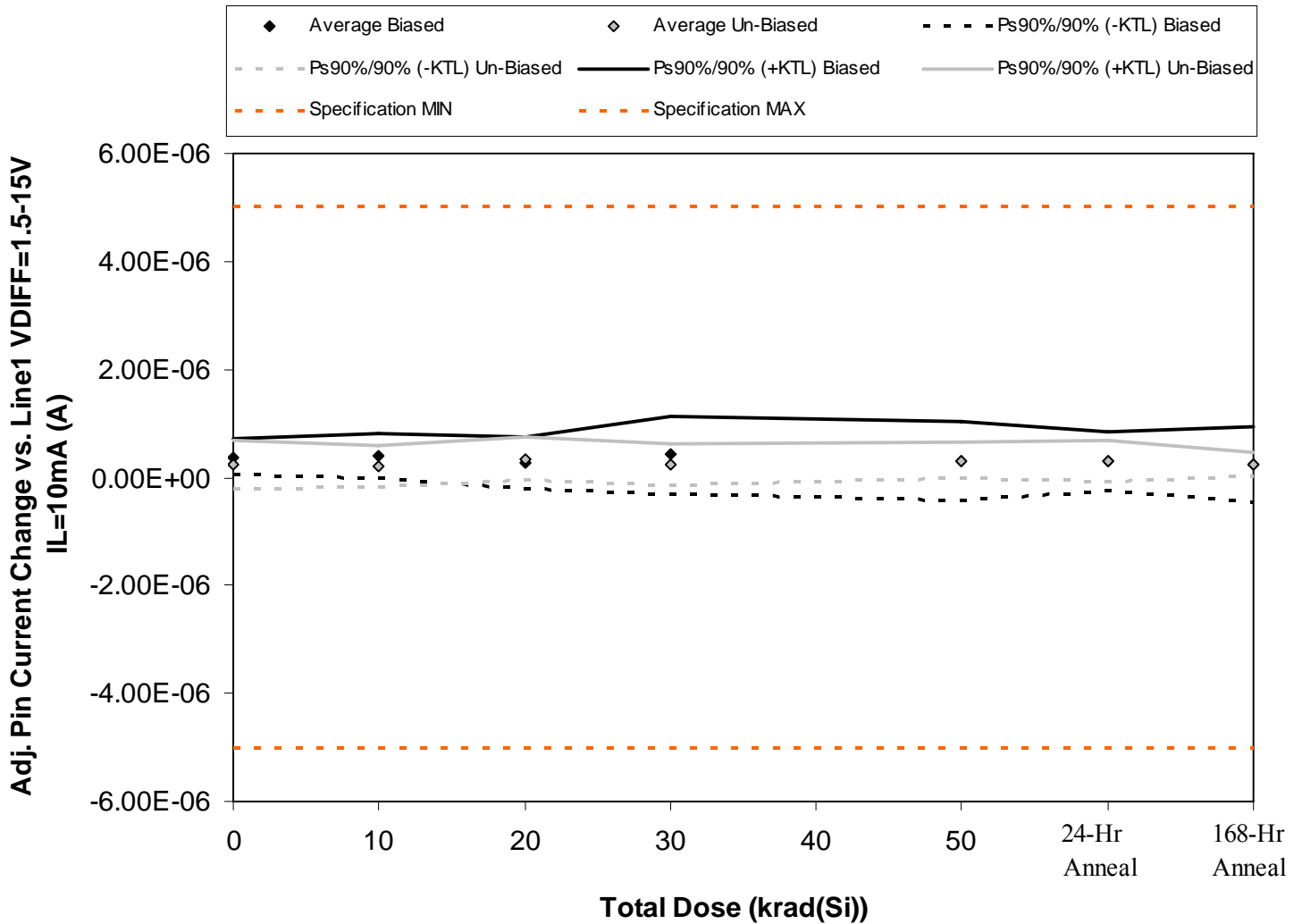

Figure 5.14. Plot of Adj. Pin Current Change vs. Line1 VDIFF=1.5-15V IL=10mA (A) versus total dose. The solid diamonds are the average of the measured data points for the samples irradiated under electrical bias while the shaded diamonds are the average of the measured data points for the samples irradiated with all pins tied to ground. The black lines (solid and/or dashed) are the average of the data points after application of the KTL statistics on the samples irradiated under electrical bias while the gray lines (solid and/or dashed) are the average of the data points after application of the KTL statistics on the samples irradiated in the unbiased condition. The red dotted line(s) are the pre- and/or post-irradiation minimum and/or maximum specification value as defined in the datasheet and/or test plan.



Table 5.14. Raw data for Adj. Pin Current Change vs. Line1 VDIFF=1.5-15V IL=10mA (A) versus total dose, including the statistical analysis, specification and the status of the testing (pass/fail).

Adj. Pin Current Change vs. Line1 VDIFF=1.5-15V IL=10mA (A)	Total Dose (krad(Si))					24-hr Anneal	168-hr Anneal
	0	10	20	30	50		
Device							
4	2.54E-07	3.45E-07	2.00E-07	7.08E-07	6.53E-07	9.10E-08	0.00E+00
8	5.08E-07	5.81E-07	5.45E-07	2.90E-07	1.45E-07	4.54E-07	5.44E-07
11	4.90E-07	3.81E-07	9.10E-08	6.72E-07	5.08E-07	9.10E-08	0.00E+00
14	3.99E-07	5.08E-07	3.27E-07	1.09E-07	1.80E-08	3.63E-07	4.72E-07
17	2.54E-07	2.00E-07	1.82E-07	3.27E-07	1.63E-07	5.08E-07	2.18E-07
19	3.63E-07	2.72E-07	3.99E-07	0.00E+00	5.08E-07	9.10E-08	2.00E-07
41	0.00E+00	0.00E+00	4.72E-07	3.09E-07	2.54E-07	3.45E-07	3.27E-07
60	2.18E-07	2.18E-07	1.82E-07	2.54E-07	2.36E-07	2.90E-07	2.72E-07
62	2.18E-07	1.81E-07	2.00E-07	2.90E-07	2.18E-07	4.90E-07	2.54E-07
65	4.17E-07	3.81E-07	4.90E-07	3.27E-07	3.45E-07	3.09E-07	1.09E-07
149	4.17E-07	5.63E-07	3.99E-07	2.54E-07	4.90E-07	1.09E-07	2.90E-07
153	3.60E-08	2.90E-07	2.00E-07	7.08E-07	4.72E-07	0.00E+00	4.36E-07
<b>Biased Statistics</b>							
Average Biased	3.81E-07	4.03E-07	2.69E-07	4.21E-07	2.97E-07	3.01E-07	2.47E-07
Std Dev Biased	1.23E-07	1.48E-07	1.76E-07	2.59E-07	2.69E-07	1.99E-07	2.56E-07
Ps90%/90% (+KTL) Biased	7.18E-07	8.09E-07	7.51E-07	1.13E-06	1.04E-06	8.47E-07	9.48E-07
Ps90%/90% (-KTL) Biased	4.35E-08	-3.16E-09	-2.13E-07	-2.89E-07	-4.41E-07	-2.44E-07	-4.55E-07
<b>Un-Biased Statistics</b>							
Average Un-Biased	2.43E-07	2.10E-07	3.49E-07	2.36E-07	3.12E-07	3.05E-07	2.32E-07
Std Dev Un-Biased	1.62E-07	1.40E-07	1.48E-07	1.35E-07	1.20E-07	1.43E-07	8.26E-08
Ps90%/90% (+KTL) Un-Biased	6.87E-07	5.94E-07	7.54E-07	6.05E-07	6.41E-07	6.97E-07	4.59E-07
Ps90%/90% (-KTL) Un-Biased	-2.01E-07	-1.73E-07	-5.72E-08	-1.33E-07	-1.65E-08	-8.73E-08	6.03E-09
<b>Specification MIN</b>	<b>-5.00E-06</b>	<b>-5.00E-06</b>	<b>-5.00E-06</b>	<b>-5.00E-06</b>	<b>-5.00E-06</b>	<b>-5.00E-06</b>	<b>-5.00E-06</b>
Status	PASS	PASS	PASS	PASS	PASS	PASS	PASS
<b>Specification MAX</b>	<b>5.00E-06</b>	<b>5.00E-06</b>	<b>5.00E-06</b>	<b>5.00E-06</b>	<b>5.00E-06</b>	<b>5.00E-06</b>	<b>5.00E-06</b>
Status	PASS	PASS	PASS	PASS	PASS	PASS	PASS

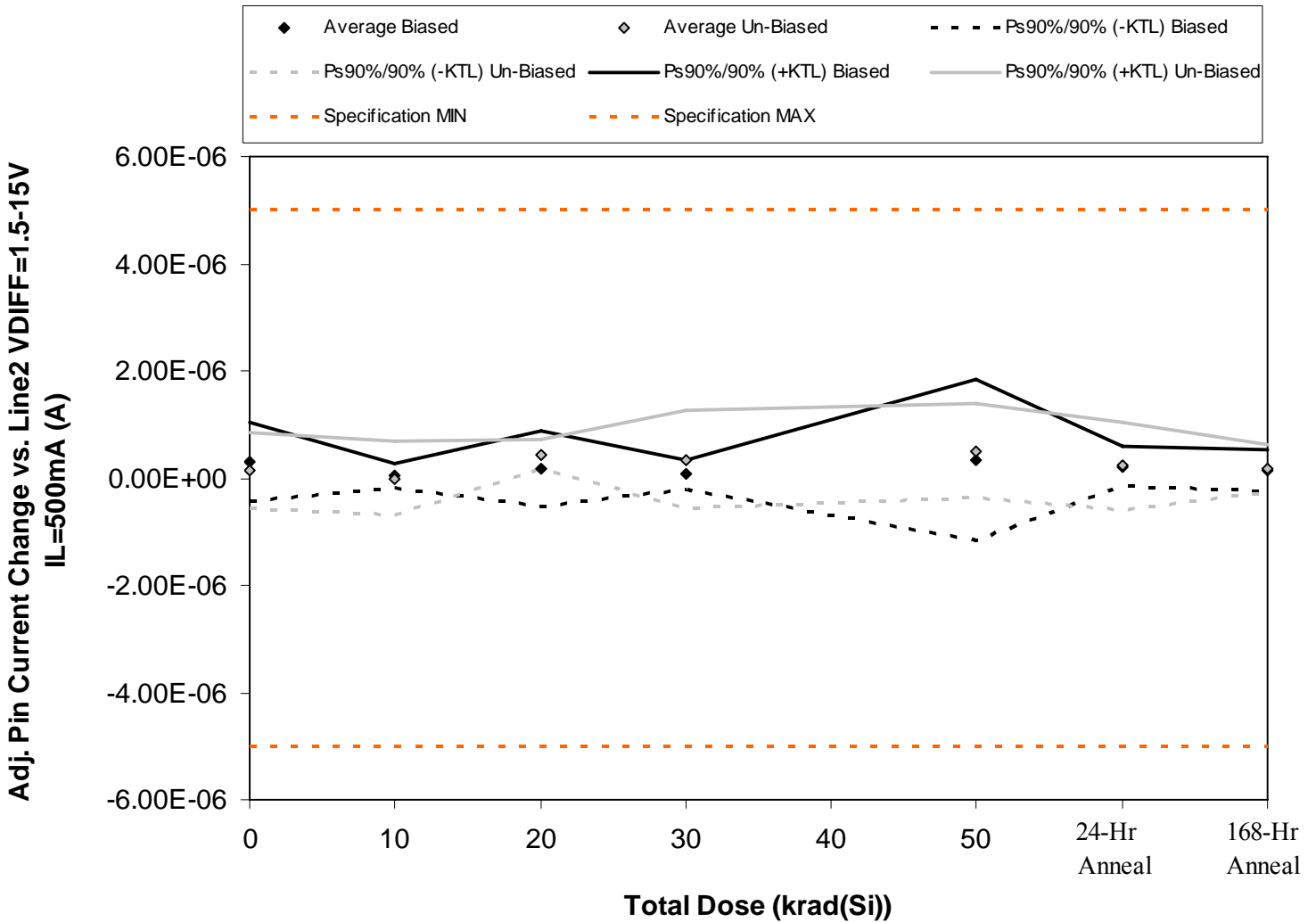

Figure 5.15. Plot of Adj. Pin Current Change vs. Line2 VDIFF=1.5-15V IL=500mA (A) versus total dose. The solid diamonds are the average of the measured data points for the samples irradiated under electrical bias while the shaded diamonds are the average of the measured data points for the samples irradiated with all pins tied to ground. The black lines (solid and/or dashed) are the average of the data points after application of the KTL statistics on the samples irradiated under electrical bias while the gray lines (solid and/or dashed) are the average of the data points after application of the KTL statistics on the samples irradiated in the unbiased condition. The red dotted line(s) are the pre- and/or post-irradiation minimum and/or maximum specification value as defined in the datasheet and/or test plan.



Table 5.15. Raw data for Adj. Pin Current Change vs. Line2 VDIFF=1.5-15V IL=500mA (A) versus total dose, including the statistical analysis, specification and the status of the testing (pass/fail).

Adj. Pin Current Change vs. Line2 VDIFF=1.5-15V IL=500mA (A)	Total Dose (krad(Si))					24-hr Anneal	168-hr Anneal
	0	10	20	30	50		
Device							
4	9.10E-08	1.81E-07	0.00E+00	0.00E+00	7.26E-07	9.10E-08	0.00E+00
8	3.63E-07	9.10E-08	5.45E-07	0.00E+00	0.00E+00	3.63E-07	0.00E+00
11	9.10E-08	0.00E+00	3.63E-07	0.00E+00	1.09E-06	1.81E-07	2.72E-07
14	7.26E-07	0.00E+00	0.00E+00	1.82E-07	0.00E+00	9.10E-08	1.81E-07
17	1.81E-07	0.00E+00	0.00E+00	1.82E-07	-1.82E-07	3.63E-07	2.72E-07
19	0.00E+00	-3.63E-07	5.45E-07	0.00E+00	7.26E-07	0.00E+00	0.00E+00
41	0.00E+00	0.00E+00	3.63E-07	0.00E+00	3.63E-07	2.72E-07	0.00E+00
60	2.72E-07	0.00E+00	3.63E-07	5.45E-07	0.00E+00	0.00E+00	2.72E-07
62	-9.10E-08	0.00E+00	3.63E-07	4.54E-07	7.26E-07	1.81E-07	1.81E-07
65	5.44E-07	3.63E-07	5.45E-07	7.26E-07	7.26E-07	7.26E-07	3.63E-07
149	3.63E-07	1.09E-06	3.63E-07	3.63E-07	0.00E+00	1.81E-07	0.00E+00
153	3.63E-07	9.10E-08	1.82E-07	1.09E-06	7.26E-07	0.00E+00	0.00E+00
<b>Biased Statistics</b>							
Average Biased	2.90E-07	5.44E-08	1.82E-07	7.28E-08	3.27E-07	2.18E-07	1.45E-07
Std Dev Biased	2.68E-07	8.10E-08	2.57E-07	9.97E-08	5.51E-07	1.38E-07	1.37E-07
Ps90%/90% (+KTL) Biased	1.02E-06	2.77E-07	8.86E-07	3.46E-07	1.84E-06	5.95E-07	5.22E-07
Ps90%/90% (-KTL) Biased	-4.43E-07	-1.68E-07	-5.23E-07	-2.01E-07	-1.18E-06	-1.59E-07	-2.32E-07
<b>Un-Biased Statistics</b>							
Average Un-Biased	1.45E-07	0.00E+00	4.36E-07	3.45E-07	5.08E-07	2.36E-07	1.63E-07
Std Dev Un-Biased	2.61E-07	2.57E-07	9.97E-08	3.30E-07	3.25E-07	2.98E-07	1.62E-07
Ps90%/90% (+KTL) Un-Biased	8.61E-07	7.04E-07	7.09E-07	1.25E-06	1.40E-06	1.05E-06	6.08E-07
Ps90%/90% (-KTL) Un-Biased	-5.71E-07	-7.04E-07	1.62E-07	-5.59E-07	-3.82E-07	-5.82E-07	-2.82E-07
<b>Specification MIN</b>	<b>-5.00E-06</b>	<b>-5.00E-06</b>	<b>-5.00E-06</b>	<b>-5.00E-06</b>	<b>-5.00E-06</b>	<b>-5.00E-06</b>	<b>-5.00E-06</b>
Status	PASS	PASS	PASS	PASS	PASS	PASS	PASS
<b>Specification MAX</b>	<b>5.00E-06</b>	<b>5.00E-06</b>	<b>5.00E-06</b>	<b>5.00E-06</b>	<b>5.00E-06</b>	<b>5.00E-06</b>	<b>5.00E-06</b>
Status	PASS	PASS	PASS	PASS	PASS	PASS	PASS

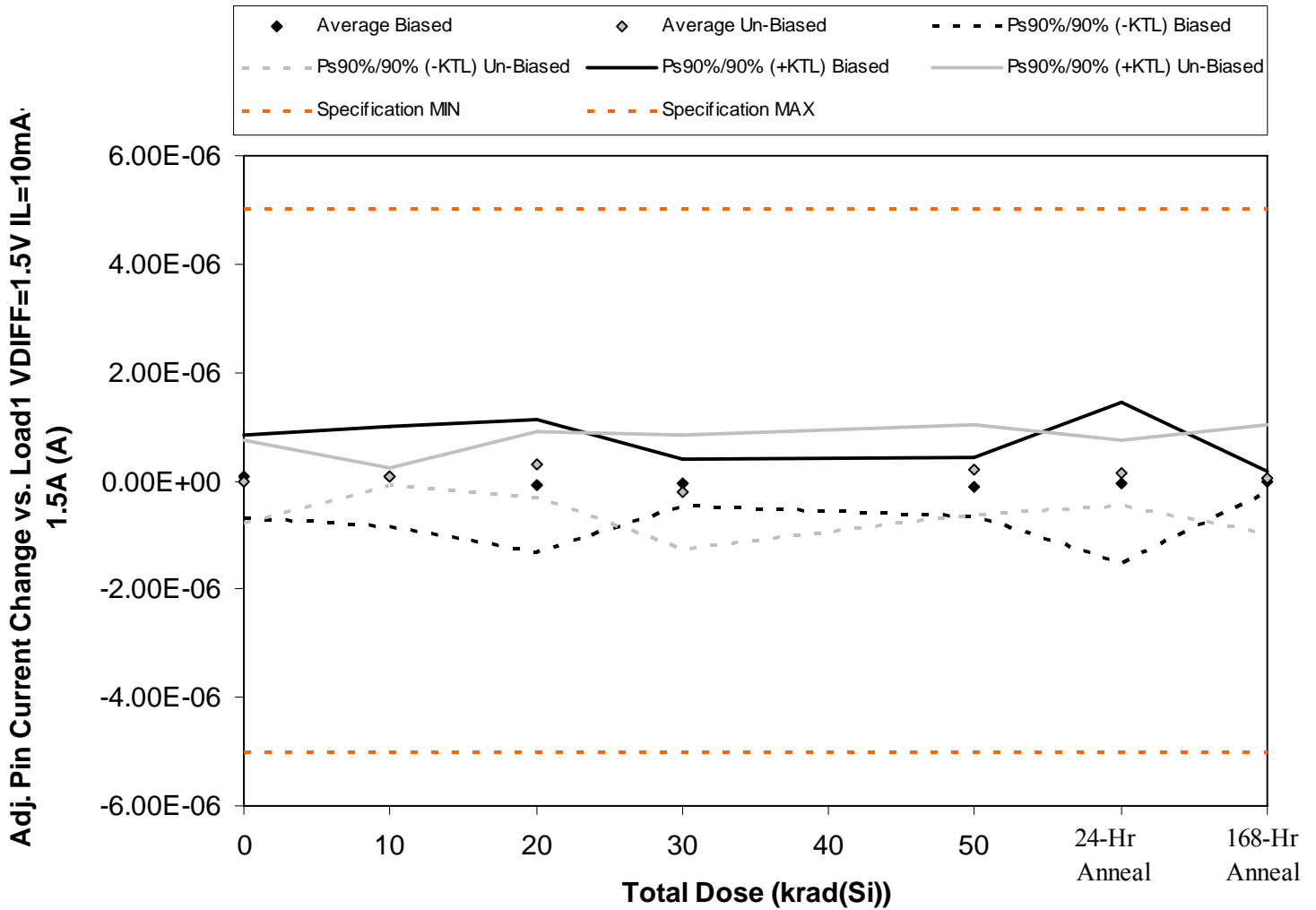

Figure 5.16. Plot of Adj. Pin Current Change vs. Load1 VDIFF=1.5V IL=10mA-1.5A (A) versus total dose. The solid diamonds are the average of the measured data points for the samples irradiated under electrical bias while the shaded diamonds are the average of the measured data points for the samples irradiated with all pins tied to ground. The black lines (solid and/or dashed) are the average of the data points after application of the KTL statistics on the samples irradiated under electrical bias while the gray lines (solid and/or dashed) are the average of the data points after application of the KTL statistics on the samples irradiated in the unbiased condition. The red dotted line(s) are the pre- and/or post-irradiation minimum and/or maximum specification value as defined in the datasheet and/or test plan.



Table 5.16. Raw data for Adj. Pin Current Change vs. Load1 VDIFF=1.5V IL=10mA-1.5A (A) versus total dose, including the statistical analysis, specification and the status of the testing (pass/fail).

Adj. Pin Current Change vs. Load1 VDIFF=1.5V IL=10mA-1.5A (A)	Total Dose (krad(Si))					24-hr Anneal	168-hr Anneal
	0	10	20	30	50		
Device							
4	-9.10E-08	5.08E-07	-7.30E-08	-2.90E-07	-4.36E-07	2.36E-07	0.00E+00
8	0.00E+00	-3.63E-07	-4.36E-07	-7.30E-08	-9.10E-08	-9.80E-07	3.60E-08
11	-5.40E-08	1.81E-07	-6.35E-07	1.80E-08	7.30E-08	1.45E-07	1.80E-08
14	5.81E-07	-1.45E-07	2.54E-07	7.30E-08	0.00E+00	3.27E-07	-1.45E-07
17	1.80E-08	2.18E-07	4.17E-07	9.10E-08	-7.30E-08	1.09E-07	-3.60E-08
19	9.10E-08	7.30E-08	3.45E-07	7.30E-08	7.26E-07	3.60E-08	9.10E-08
41	0.00E+00	3.60E-08	2.18E-07	5.40E-08	0.00E+00	1.80E-08	2.90E-07
60	-4.90E-07	1.80E-08	9.10E-08	-2.00E-07	1.82E-07	1.81E-07	2.18E-07
62	2.36E-07	1.27E-07	1.82E-07	-1.09E-07	1.80E-08	5.26E-07	1.63E-07
65	9.10E-08	1.45E-07	6.53E-07	-8.71E-07	1.09E-07	0.00E+00	-5.99E-07
149	5.44E-07	1.45E-07	4.54E-07	-1.80E-08	5.40E-08	1.45E-07	-3.60E-08
153	1.63E-07	1.45E-07	1.09E-07	-1.45E-07	0.00E+00	-1.81E-07	0.00E+00
<b>Biased Statistics</b>							
Average Biased	9.08E-08	7.98E-08	-9.46E-08	-3.62E-08	-1.05E-07	-3.26E-08	-2.54E-08
Std Dev Biased	2.77E-07	3.39E-07	4.45E-07	1.56E-07	1.96E-07	5.36E-07	7.20E-08
Ps90%/90% (+KTL) Biased	8.51E-07	1.01E-06	1.13E-06	3.90E-07	4.32E-07	1.44E-06	1.72E-07
Ps90%/90% (-KTL) Biased	-6.70E-07	-8.49E-07	-1.31E-06	-4.63E-07	-6.43E-07	-1.50E-06	-2.23E-07
<b>Un-Biased Statistics</b>							
Average Un-Biased	-1.44E-08	7.98E-08	2.98E-07	-2.11E-07	2.07E-07	1.52E-07	3.26E-08
Std Dev Un-Biased	2.79E-07	5.54E-08	2.18E-07	3.86E-07	2.99E-07	2.21E-07	3.61E-07
Ps90%/90% (+KTL) Un-Biased	7.51E-07	2.32E-07	8.97E-07	8.49E-07	1.03E-06	7.58E-07	1.02E-06
Ps90%/90% (-KTL) Un-Biased	-7.79E-07	-7.20E-08	-3.01E-07	-1.27E-06	-6.13E-07	-4.54E-07	-9.56E-07
<b>Specification MIN</b>	<b>-5.00E-06</b>	<b>-5.00E-06</b>	<b>-5.00E-06</b>	<b>-5.00E-06</b>	<b>-5.00E-06</b>	<b>-5.00E-06</b>	<b>-5.00E-06</b>
Status	PASS	PASS	PASS	PASS	PASS	PASS	PASS
<b>Specification MAX</b>	<b>5.00E-06</b>	<b>5.00E-06</b>	<b>5.00E-06</b>	<b>5.00E-06</b>	<b>5.00E-06</b>	<b>5.00E-06</b>	<b>5.00E-06</b>
Status	PASS	PASS	PASS	PASS	PASS	PASS	PASS

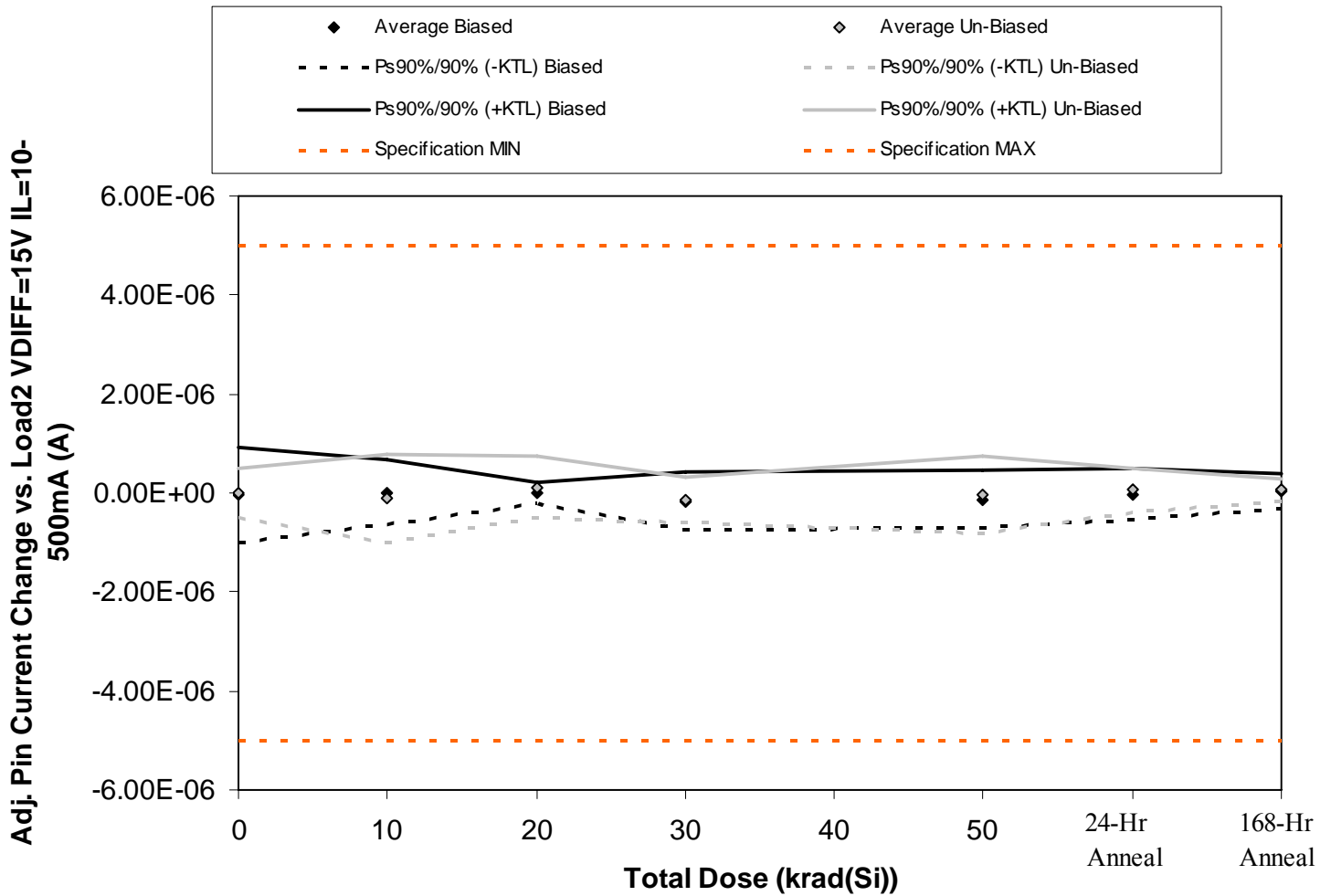

Figure 5.17. Plot of Adj. Pin Current Change vs. Load2 VDIFF=15V IL=10-500mA (A) versus total dose. The solid diamonds are the average of the measured data points for the samples irradiated under electrical bias while the shaded diamonds are the average of the measured data points for the samples irradiated with all pins tied to ground. The black lines (solid and/or dashed) are the average of the data points after application of the KTL statistics on the samples irradiated under electrical bias while the gray lines (solid and/or dashed) are the average of the data points after application of the KTL statistics on the samples irradiated in the unbiased condition. The red dotted line(s) are the pre- and/or post-irradiation minimum and/or maximum specification value as defined in the datasheet and/or test plan.





Table 5.17. Raw data for Adj. Pin Current Change vs. Load2 VDIFF=15V IL=10-500mA (A) versus total dose, including the statistical analysis, specification and the status of the testing (pass/fail).

Adj. Pin Current Change vs. Load2 VDIFF=15V IL=10-500mA (A)	Total Dose (krad(Si))					24-hr Anneal	168-hr Anneal
	0	10	20	30	50		
Device							
4	2.72E-07	-2.54E-07	9.10E-08	7.30E-08	-1.82E-07	-3.45E-07	-1.09E-07
8	9.10E-08	3.45E-07	7.30E-08	-1.45E-07	-7.30E-08	1.45E-07	3.60E-08
11	1.09E-07	1.09E-07	-5.40E-08	-3.27E-07	-4.72E-07	1.80E-08	0.00E+00
14	-6.35E-07	-1.81E-07	-3.60E-08	1.80E-08	0.00E+00	-3.60E-08	1.80E-08
17	-1.80E-08	0.00E+00	-9.10E-08	-4.36E-07	7.30E-08	7.30E-08	2.36E-07
19	1.45E-07	3.63E-07	1.80E-08	0.00E+00	2.90E-07	0.00E+00	0.00E+00
41	7.30E-08	-1.45E-07	2.54E-07	-7.30E-08	-4.72E-07	5.40E-08	1.09E-07
60	7.30E-08	-1.45E-07	4.17E-07	-2.72E-07	0.00E+00	1.80E-08	1.63E-07
62	0.00E+00	-1.80E-08	-1.63E-07	-3.63E-07	1.09E-07	-1.27E-07	-3.60E-08
65	-3.09E-07	-5.44E-07	9.10E-08	1.80E-08	-5.40E-08	3.27E-07	3.60E-08
149	-5.40E-08	-9.10E-08	-3.60E-08	-4.54E-07	1.82E-07	-1.27E-07	-1.09E-07
153	3.60E-08	1.27E-07	0.00E+00	2.18E-07	3.09E-07	0.00E+00	0.00E+00
<b>Biased Statistics</b>							
Average Biased	-3.62E-08	3.80E-09	-3.40E-09	-1.63E-07	-1.31E-07	-2.90E-08	3.62E-08
Std Dev Biased	3.50E-07	2.39E-07	8.07E-08	2.18E-07	2.13E-07	1.89E-07	1.25E-07
Ps90%/90% (+KTL) Biased	9.25E-07	6.59E-07	2.18E-07	4.35E-07	4.53E-07	4.89E-07	3.79E-07
Ps90%/90% (-KTL) Biased	-9.97E-07	-6.51E-07	-2.25E-07	-7.61E-07	-7.14E-07	-5.47E-07	-3.07E-07
<b>Un-Biased Statistics</b>							
Average Un-Biased	-3.60E-09	-9.78E-08	1.23E-07	-1.38E-07	-2.54E-08	5.44E-08	5.44E-08
Std Dev Un-Biased	1.78E-07	3.25E-07	2.22E-07	1.70E-07	2.82E-07	1.67E-07	8.10E-08
Ps90%/90% (+KTL) Un-Biased	4.85E-07	7.93E-07	7.33E-07	3.29E-07	7.48E-07	5.12E-07	2.77E-07
Ps90%/90% (-KTL) Un-Biased	-4.92E-07	-9.89E-07	-4.86E-07	-6.05E-07	-7.99E-07	-4.03E-07	-1.68E-07
<b>Specification MIN</b>	<b>-5.00E-06</b>	<b>-5.00E-06</b>	<b>-5.00E-06</b>	<b>-5.00E-06</b>	<b>-5.00E-06</b>	<b>-5.00E-06</b>	<b>-5.00E-06</b>
Status	PASS	PASS	PASS	PASS	PASS	PASS	PASS
<b>Specification MAX</b>	<b>5.00E-06</b>	<b>5.00E-06</b>	<b>5.00E-06</b>	<b>5.00E-06</b>	<b>5.00E-06</b>	<b>5.00E-06</b>	<b>5.00E-06</b>
Status	PASS	PASS	PASS	PASS	PASS	PASS	PASS

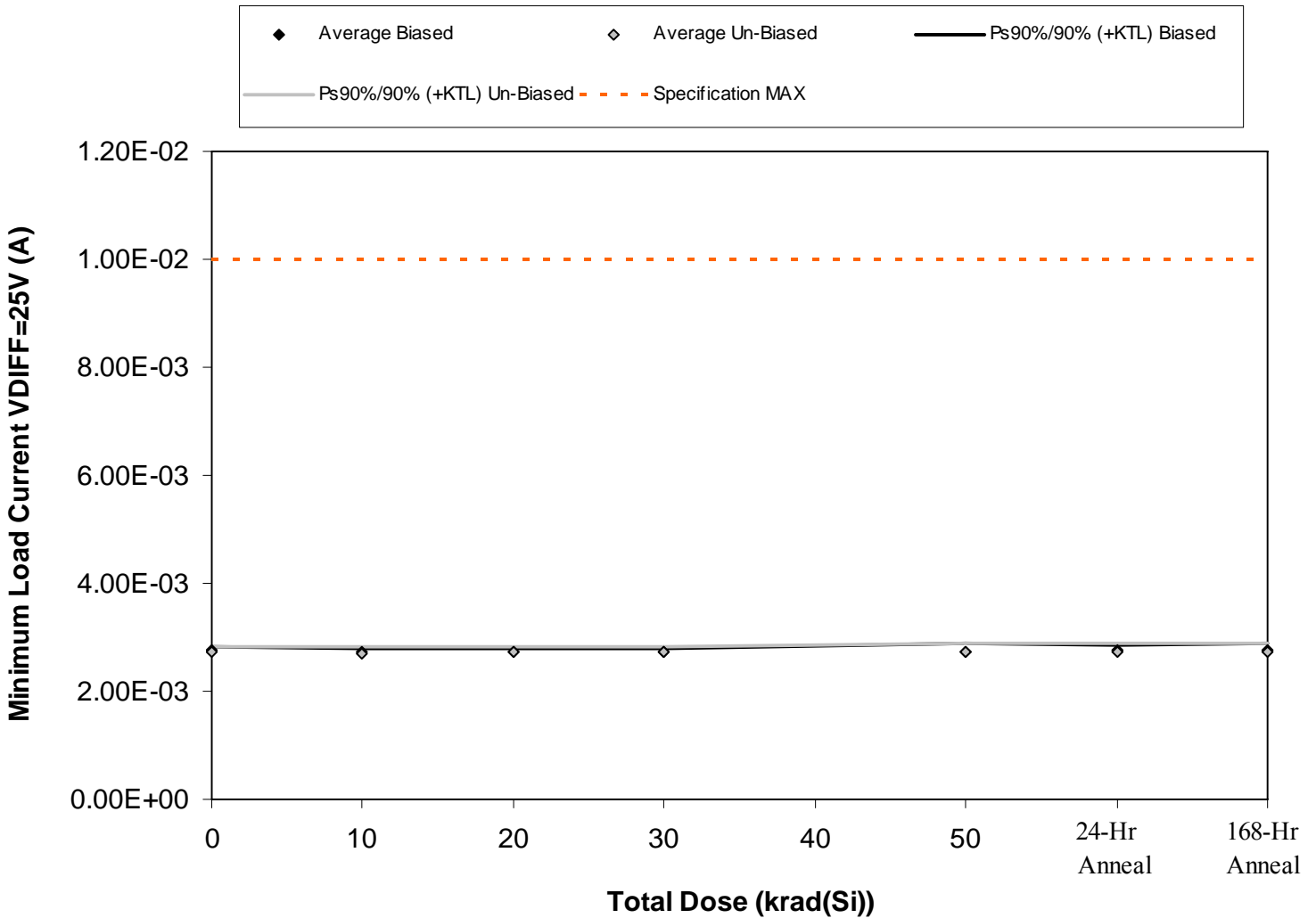

Figure 5.18. Plot of Minimum Load Current VDIFF=25V (A) versus total dose. The solid diamonds are the average of the measured data points for the samples irradiated under electrical bias while the shaded diamonds are the average of the measured data points for the samples irradiated with all pins tied to ground. The black lines (solid and/or dashed) are the average of the data points after application of the KTL statistics on the samples irradiated under electrical bias while the gray lines (solid and/or dashed) are the average of the data points after application of the KTL statistics on the samples irradiated in the unbiased condition. The red dotted line(s) are the pre- and/or post-irradiation minimum and/or maximum specification value as defined in the datasheet and/or test plan.



Table 5.18. Raw data for Minimum Load Current VDIFF=25V (A) versus total dose, including the statistical analysis, specification and the status of the testing (pass/fail).

Minimum Load Current VDIFF=25V (A)	Total Dose (krad(Si))					24-hr Anneal	168-hr Anneal
	0	10	20	30	50		
Device							
4	2.76E-03	2.76E-03	2.73E-03	2.72E-03	2.77E-03	2.78E-03	2.78E-03
8	2.73E-03	2.73E-03	2.70E-03	2.69E-03	2.69E-03	2.75E-03	2.70E-03
11	2.74E-03	2.73E-03	2.74E-03	2.73E-03	2.77E-03	2.79E-03	2.78E-03
14	2.78E-03	2.74E-03	2.75E-03	2.75E-03	2.79E-03	2.80E-03	2.80E-03
17	2.72E-03	2.72E-03	2.73E-03	2.69E-03	2.68E-03	2.70E-03	2.69E-03
19	2.73E-03	2.72E-03	2.73E-03	2.73E-03	2.76E-03	2.78E-03	2.73E-03
41	2.71E-03	2.70E-03	2.71E-03	2.70E-03	2.70E-03	2.71E-03	2.71E-03
60	2.78E-03	2.76E-03	2.77E-03	2.77E-03	2.81E-03	2.82E-03	2.82E-03
62	2.72E-03	2.71E-03	2.72E-03	2.71E-03	2.67E-03	2.68E-03	2.72E-03
65	2.66E-03	2.66E-03	2.66E-03	2.66E-03	2.69E-03	2.71E-03	2.66E-03
149	2.71E-03	2.67E-03	2.71E-03	2.67E-03	2.66E-03	2.72E-03	2.67E-03
153	2.75E-03	2.75E-03	2.75E-03	2.74E-03	2.73E-03	2.75E-03	2.74E-03
<b>Biased Statistics</b>							
Average Biased	2.75E-03	2.73E-03	2.73E-03	2.72E-03	2.74E-03	2.76E-03	2.75E-03
Std Dev Biased	2.43E-05	1.65E-05	1.87E-05	2.51E-05	4.92E-05	3.97E-05	5.02E-05
Ps90%/90% (+KTL) Biased	2.81E-03	2.78E-03	2.78E-03	2.79E-03	2.87E-03	2.87E-03	2.89E-03
Ps90%/90% (-KTL) Biased	2.68E-03	2.69E-03	2.68E-03	2.65E-03	2.60E-03	2.65E-03	2.61E-03
<b>Un-Biased Statistics</b>							
Average Un-Biased	2.72E-03	2.71E-03	2.72E-03	2.71E-03	2.73E-03	2.74E-03	2.73E-03
Std Dev Un-Biased	4.17E-05	3.88E-05	4.02E-05	3.99E-05	5.76E-05	5.55E-05	5.79E-05
Ps90%/90% (+KTL) Un-Biased	2.83E-03	2.82E-03	2.83E-03	2.82E-03	2.89E-03	2.89E-03	2.89E-03
Ps90%/90% (-KTL) Un-Biased	2.61E-03	2.60E-03	2.61E-03	2.61E-03	2.57E-03	2.59E-03	2.57E-03
<b>Specification MAX</b>	<b>1.00E-02</b>	<b>1.00E-02</b>	<b>1.00E-02</b>	<b>1.00E-02</b>	<b>1.00E-02</b>	<b>1.00E-02</b>	<b>1.00E-02</b>
Status	PASS	PASS	PASS	PASS	PASS	PASS	PASS

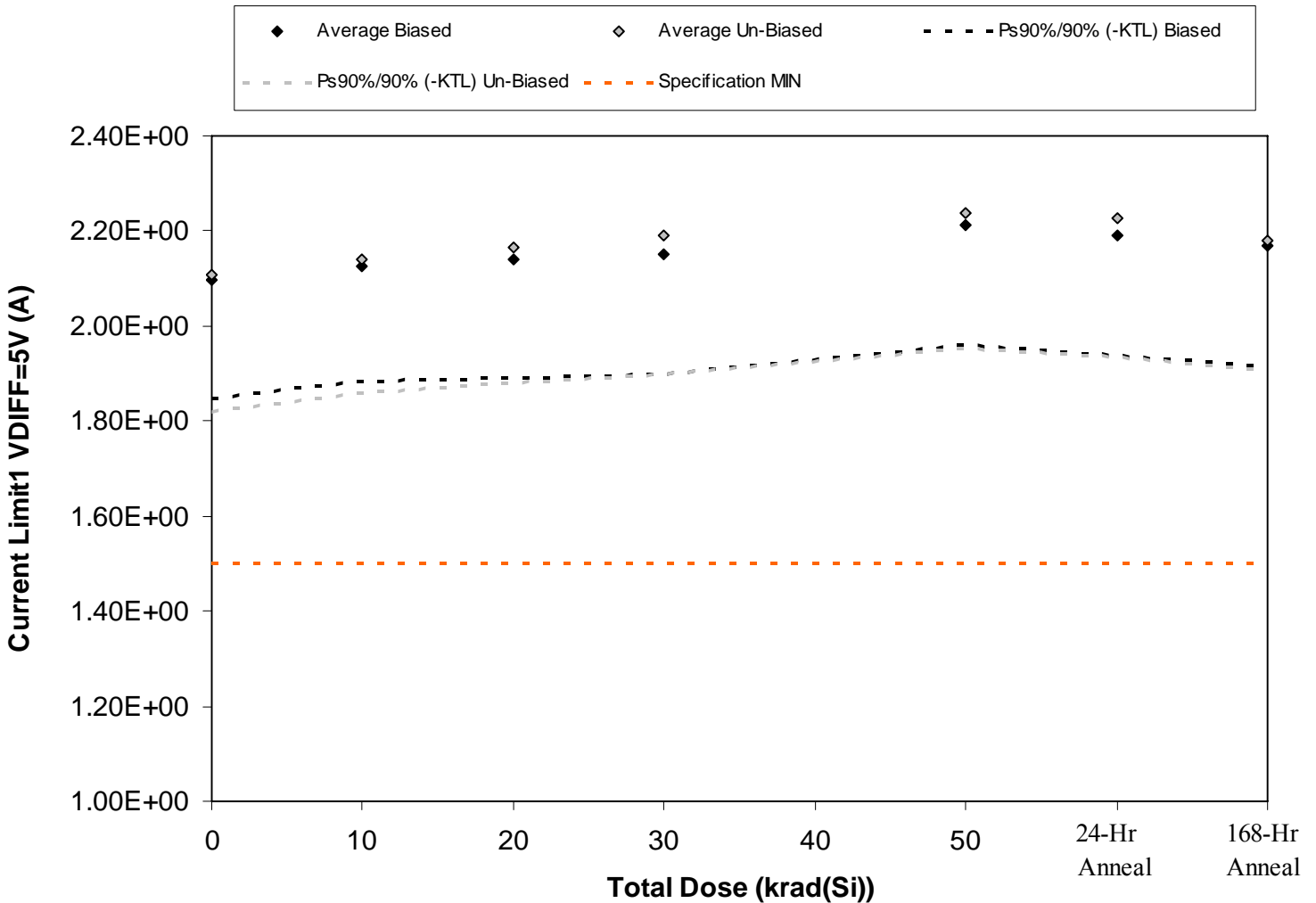

Figure 5.19. Plot of Current Limit1 VDIFF=5V (A) versus total dose. The solid diamonds are the average of the measured data points for the samples irradiated under electrical bias while the shaded diamonds are the average of the measured data points for the samples irradiated with all pins tied to ground. The black lines (solid and/or dashed) are the average of the data points after application of the KTL statistics on the samples irradiated under electrical bias while the gray lines (solid and/or dashed) are the average of the data points after application of the KTL statistics on the samples irradiated in the unbiased condition. The red dotted line(s) are the pre- and/or post-irradiation minimum and/or maximum specification value as defined in the datasheet and/or test plan.



Table 5.19. Raw data for Current Limit1 VDIFF=5V (A) versus total dose, including the statistical analysis, specification and the status of the testing (pass/fail).

Current Limit1 VDIFF=5V (A)	Total Dose (krad(Si))					24-hr Anneal	168-hr Anneal
	0	10	20	30	50		
Device							
4	2.09E+00	2.11E+00	2.13E+00	2.15E+00	2.21E+00	2.19E+00	2.15E+00
8	2.05E+00	2.09E+00	2.09E+00	2.11E+00	2.17E+00	2.15E+00	2.13E+00
11	2.01E+00	2.03E+00	2.05E+00	2.05E+00	2.11E+00	2.09E+00	2.07E+00
14	2.09E+00	2.13E+00	2.15E+00	2.15E+00	2.21E+00	2.19E+00	2.17E+00
17	2.25E+00	2.27E+00	2.29E+00	2.30E+00	2.36E+00	2.34E+00	2.32E+00
19	2.05E+00	2.09E+00	2.11E+00	2.13E+00	2.17E+00	2.17E+00	2.13E+00
41	2.27E+00	2.29E+00	2.30E+00	2.34E+00	2.38E+00	2.36E+00	2.32E+00
60	2.15E+00	2.21E+00	2.25E+00	2.27E+00	2.32E+00	2.32E+00	2.25E+00
62	2.05E+00	2.07E+00	2.09E+00	2.13E+00	2.17E+00	2.15E+00	2.11E+00
65	2.01E+00	2.05E+00	2.07E+00	2.09E+00	2.15E+00	2.13E+00	2.09E+00
149	2.25E+00	2.25E+00	2.25E+00	2.25E+00	2.25E+00	2.25E+00	2.25E+00
153	2.05E+00	2.05E+00	2.05E+00	2.05E+00	2.05E+00	2.05E+00	2.05E+00
<b>Biased Statistics</b>							
Average Biased	2.10E+00	2.13E+00	2.14E+00	2.15E+00	2.21E+00	2.19E+00	2.17E+00
Std Dev Biased	9.12E-02	8.88E-02	9.12E-02	9.23E-02	9.23E-02	9.23E-02	9.28E-02
Ps90%/90% (+KTL) Biased	2.35E+00	2.37E+00	2.39E+00	2.41E+00	2.47E+00	2.45E+00	2.42E+00
Ps90%/90% (-KTL) Biased	1.85E+00	1.88E+00	1.89E+00	1.90E+00	1.96E+00	1.94E+00	1.91E+00
<b>Un-Biased Statistics</b>							
Average Un-Biased	2.11E+00	2.14E+00	2.16E+00	2.19E+00	2.24E+00	2.23E+00	2.18E+00
Std Dev Un-Biased	1.05E-01	1.04E-01	1.04E-01	1.07E-01	1.05E-01	1.06E-01	1.00E-01
Ps90%/90% (+KTL) Un-Biased	2.39E+00	2.43E+00	2.45E+00	2.49E+00	2.53E+00	2.52E+00	2.45E+00
Ps90%/90% (-KTL) Un-Biased	1.82E+00	1.86E+00	1.88E+00	1.90E+00	1.95E+00	1.94E+00	1.91E+00
<b>Specification MIN</b>	<b>1.50E+00</b>	<b>1.50E+00</b>	<b>1.50E+00</b>	<b>1.50E+00</b>	<b>1.50E+00</b>	<b>1.50E+00</b>	<b>1.50E+00</b>
Status	PASS	PASS	PASS	PASS	PASS	PASS	PASS

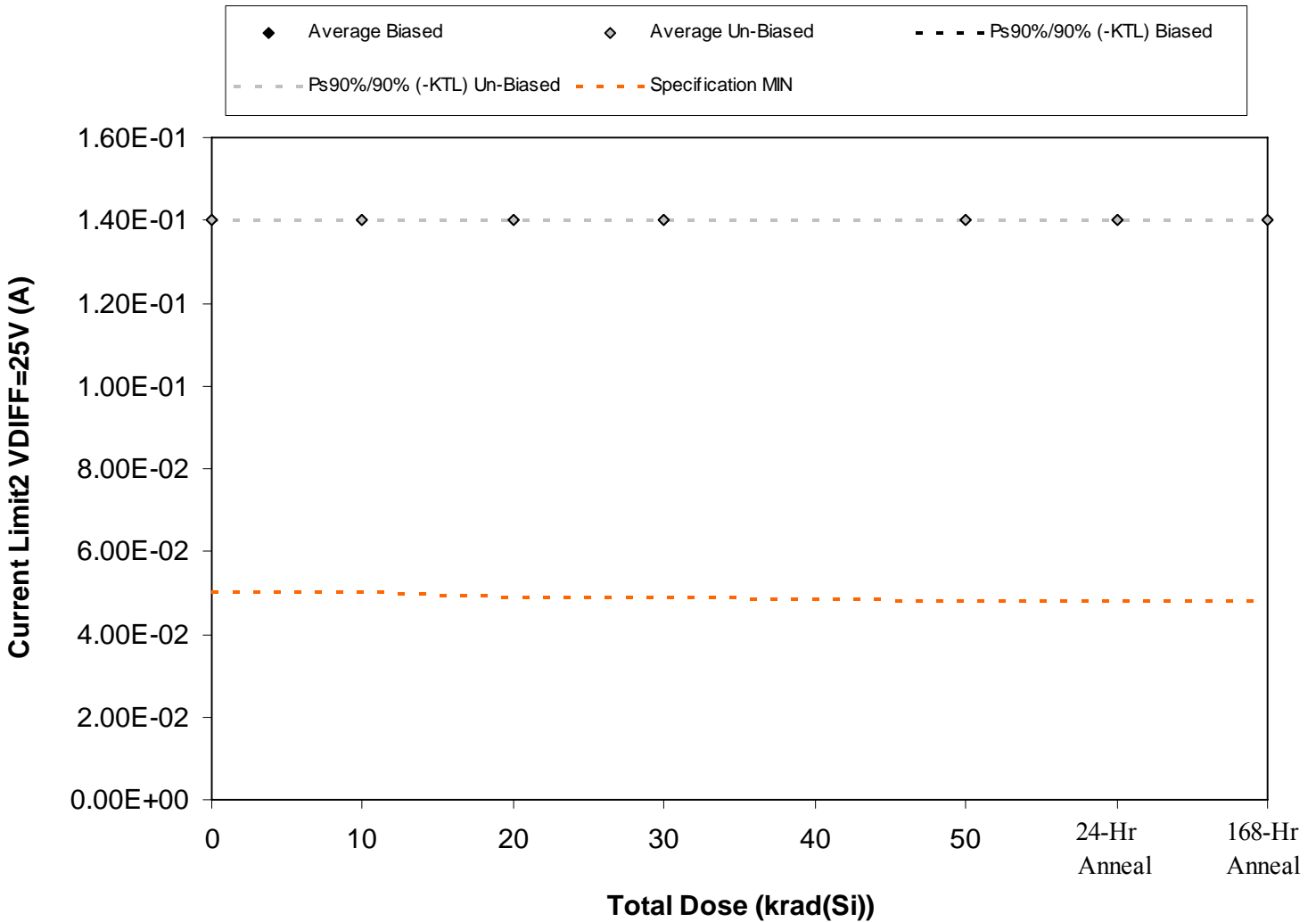

Figure 5.20. Plot of Current Limit2 VDIFF=25V (A) versus total dose. The solid diamonds are the average of the measured data points for the samples irradiated under electrical bias while the shaded diamonds are the average of the measured data points for the samples irradiated with all pins tied to ground. The black lines (solid and/or dashed) are the average of the data points after application of the KTL statistics on the samples irradiated under electrical bias while the gray lines (solid and/or dashed) are the average of the data points after application of the KTL statistics on the samples irradiated in the unbiased condition. The red dotted line(s) are the pre- and/or post-irradiation minimum and/or maximum specification value as defined in the datasheet and/or test plan.



Table 5.20. Raw data for Current Limit2 VDIFF=25V (A) versus total dose, including the statistical analysis, specification and the status of the testing (pass/fail).

Current Limit2 VDIFF=25V (A)	Total Dose (krad(Si))					24-hr Anneal	168-hr Anneal
	0	10	20	30	50		
Device							
4	1.40E-01	1.40E-01	1.40E-01	1.40E-01	1.40E-01	1.40E-01	1.40E-01
8	1.40E-01	1.40E-01	1.40E-01	1.40E-01	1.40E-01	1.40E-01	1.40E-01
11	1.40E-01	1.40E-01	1.40E-01	1.40E-01	1.40E-01	1.40E-01	1.40E-01
14	1.40E-01	1.40E-01	1.40E-01	1.40E-01	1.40E-01	1.40E-01	1.40E-01
17	1.40E-01	1.40E-01	1.40E-01	1.40E-01	1.40E-01	1.40E-01	1.40E-01
19	1.40E-01	1.40E-01	1.40E-01	1.40E-01	1.40E-01	1.40E-01	1.40E-01
41	1.40E-01	1.40E-01	1.40E-01	1.40E-01	1.40E-01	1.40E-01	1.40E-01
60	1.40E-01	1.40E-01	1.40E-01	1.40E-01	1.40E-01	1.40E-01	1.40E-01
62	1.40E-01	1.40E-01	1.40E-01	1.40E-01	1.40E-01	1.40E-01	1.40E-01
65	1.40E-01	1.40E-01	1.40E-01	1.40E-01	1.40E-01	1.40E-01	1.40E-01
149	1.40E-01	1.40E-01	1.40E-01	1.40E-01	1.40E-01	1.40E-01	1.40E-01
153	1.40E-01	1.40E-01	1.40E-01	1.40E-01	1.40E-01	1.40E-01	1.40E-01
<b>Biased Statistics</b>							
Average Biased	1.40E-01	1.40E-01	1.40E-01	1.40E-01	1.40E-01	1.40E-01	1.40E-01
Std Dev Biased	0.00E+00	0.00E+00	0.00E+00	0.00E+00	0.00E+00	0.00E+00	0.00E+00
Ps90%/90% (+KTL) Biased	1.40E-01	1.40E-01	1.40E-01	1.40E-01	1.40E-01	1.40E-01	1.40E-01
Ps90%/90% (-KTL) Biased	1.40E-01	1.40E-01	1.40E-01	1.40E-01	1.40E-01	1.40E-01	1.40E-01
<b>Un-Biased Statistics</b>							
Average Un-Biased	1.40E-01	1.40E-01	1.40E-01	1.40E-01	1.40E-01	1.40E-01	1.40E-01
Std Dev Un-Biased	0.00E+00	0.00E+00	0.00E+00	0.00E+00	0.00E+00	0.00E+00	0.00E+00
Ps90%/90% (+KTL) Un-Biased	1.40E-01	1.40E-01	1.40E-01	1.40E-01	1.40E-01	1.40E-01	1.40E-01
Ps90%/90% (-KTL) Un-Biased	1.40E-01	1.40E-01	1.40E-01	1.40E-01	1.40E-01	1.40E-01	1.40E-01
<b>Specification MIN</b>	<b>5.00E-02</b>	<b>5.00E-02</b>	<b>4.90E-02</b>	<b>4.90E-02</b>	<b>4.80E-02</b>	<b>4.80E-02</b>	<b>4.80E-02</b>
Status	PASS	PASS	PASS	PASS	PASS	PASS	PASS

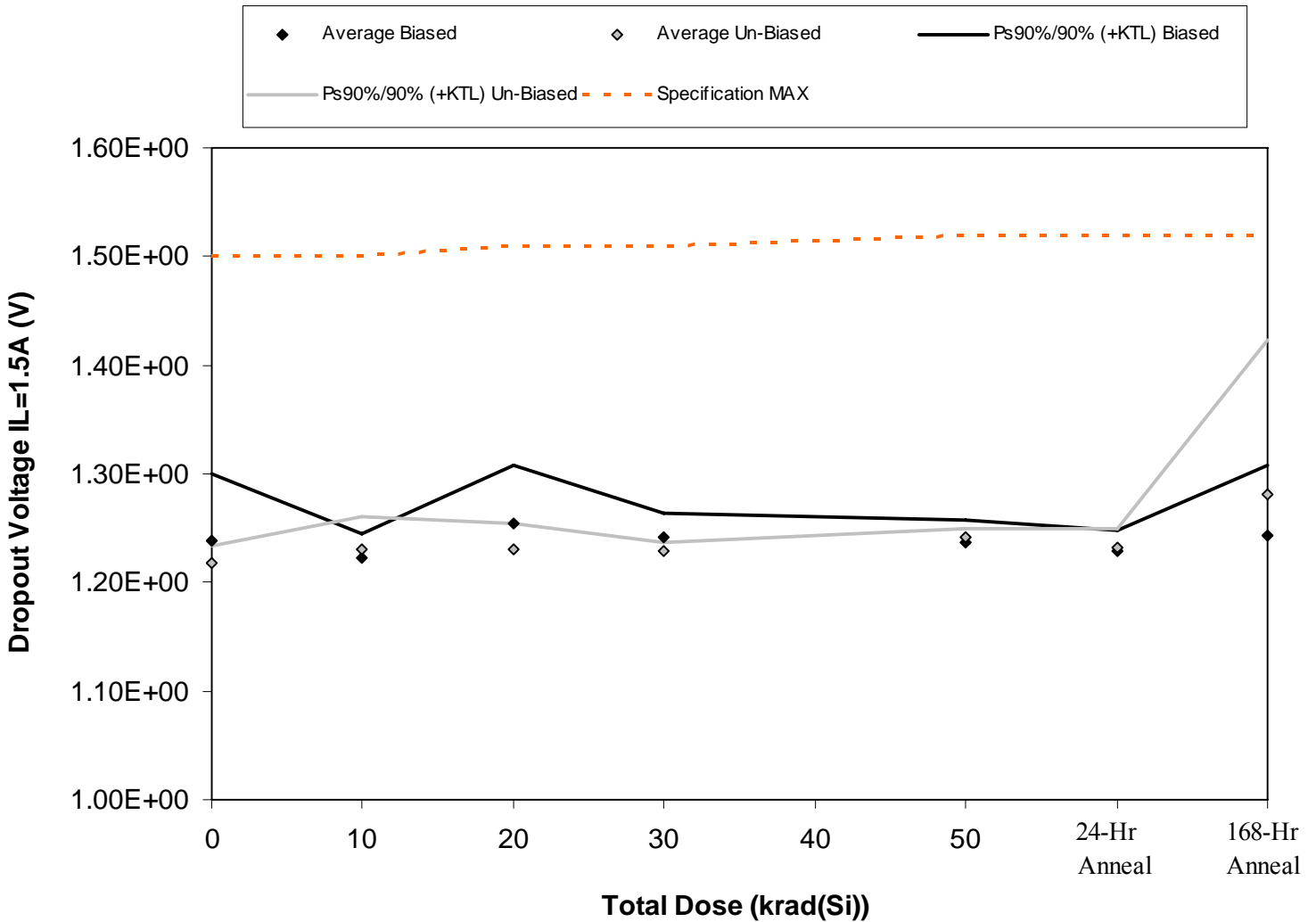

Figure 5.21. Plot of Dropout Voltage IL=1.5A (V) versus total dose. The solid diamonds are the average of the measured data points for the samples irradiated under electrical bias while the shaded diamonds are the average of the measured data points for the samples irradiated with all pins tied to ground. The black lines (solid and/or dashed) are the average of the data points after application of the KTL statistics on the samples irradiated under electrical bias while the gray lines (solid and/or dashed) are the average of the data points after application of the KTL statistics on the samples irradiated in the unbiased condition. The red dotted line(s) are the pre- and/or post-irradiation minimum and/or maximum specification value as defined in the datasheet and/or test plan.





Table 5.21. Raw data for Dropout Voltage IL=1.5A (V) versus total dose, including the statistical analysis, specification and the status of the testing (pass/fail).

Dropout Voltage IL=1.5A (V)	Total Dose (krad(Si))					24-hr Anneal	168-hr Anneal
	0	10	20	30	50		
Device							
4	1.22E+00	1.21E+00	1.28E+00	1.24E+00	1.24E+00	1.23E+00	1.24E+00
8	1.22E+00	1.22E+00	1.23E+00	1.24E+00	1.23E+00	1.23E+00	1.28E+00
11	1.26E+00	1.22E+00	1.25E+00	1.25E+00	1.25E+00	1.23E+00	1.25E+00
14	1.22E+00	1.22E+00	1.27E+00	1.23E+00	1.23E+00	1.22E+00	1.22E+00
17	1.26E+00	1.23E+00	1.25E+00	1.24E+00	1.24E+00	1.24E+00	1.23E+00
19	1.22E+00	1.25E+00	1.24E+00	1.23E+00	1.24E+00	1.23E+00	1.30E+00
41	1.22E+00	1.22E+00	1.23E+00	1.23E+00	1.24E+00	1.23E+00	1.23E+00
60	1.21E+00	1.23E+00	1.22E+00	1.23E+00	1.24E+00	1.23E+00	1.36E+00
62	1.22E+00	1.23E+00	1.23E+00	1.23E+00	1.24E+00	1.24E+00	1.28E+00
65	1.22E+00	1.23E+00	1.23E+00	1.23E+00	1.24E+00	1.24E+00	1.23E+00
149	1.27E+00	1.27E+00	1.31E+00	1.27E+00	1.22E+00	1.24E+00	1.24E+00
153	1.21E+00	1.21E+00	1.21E+00	1.21E+00	1.21E+00	1.20E+00	1.21E+00
<b>Biased Statistics</b>							
Average Biased	1.24E+00	1.22E+00	1.25E+00	1.24E+00	1.24E+00	1.23E+00	1.24E+00
Std Dev Biased	2.24E-02	8.22E-03	1.94E-02	7.68E-03	7.42E-03	6.77E-03	2.37E-02
Ps90%/90% (+KTL) Biased	1.30E+00	1.24E+00	1.31E+00	1.26E+00	1.26E+00	1.25E+00	1.31E+00
Ps90%/90% (-KTL) Biased	1.18E+00	1.20E+00	1.20E+00	1.22E+00	1.22E+00	1.21E+00	1.18E+00
<b>Un-Biased Statistics</b>							
Average Un-Biased	1.22E+00	1.23E+00	1.23E+00	1.23E+00	1.24E+00	1.23E+00	1.28E+00
Std Dev Un-Biased	6.02E-03	1.09E-02	8.56E-03	2.66E-03	2.91E-03	6.17E-03	5.19E-02
Ps90%/90% (+KTL) Un-Biased	1.23E+00	1.26E+00	1.25E+00	1.24E+00	1.25E+00	1.25E+00	1.42E+00
Ps90%/90% (-KTL) Un-Biased	1.20E+00	1.20E+00	1.21E+00	1.22E+00	1.23E+00	1.22E+00	1.14E+00
<b>Specification MAX</b>	<b>1.500</b>	<b>1.500</b>	<b>1.510</b>	<b>1.510</b>	<b>1.520</b>	<b>1.520</b>	<b>1.520</b>
Status	PASS	PASS	PASS	PASS	PASS	PASS	PASS



## **6.0. Summary / Conclusions**

The ELDRS testing described in this final report was performed using the facilities at Radiation Assured Devices' Longmire Laboratories in Colorado Springs, CO. The ELDRS source is a GB-150 irradiator modified to provide a panoramic exposure. The Co-60 rods are held in the base of the irradiator heavily shielded by lead. During the irradiation exposures the rod is raised by an electronic timer/controller and the exposure is performed in air. The dose rate for this irradiator in this configuration ranges from approximately 1rad(Si)/s to a maximum of approximately 50rad(Si)/s as determined by the distance from the source.

Samples of the RH1086MK Low Dropout Positive Adjustable Regulator described in this report were irradiated biased with a single-ended 30V supply and unbiased (all leads tied to ground). The devices were irradiated to a maximum total ionizing dose level of 50krad(Si) with a pre-irradiation baseline reading as well as incremental readings at 10, 20, and 30krad(Si). Electrical testing occurred within one hour following the end of each irradiation segment. For intermediate irradiations, the units were tested and returned to total dose exposure within two hours from the end of the previous radiation increment. In addition, all units-under-test received a 24hr room temperature and 168hr 100°C anneal, using the same bias conditions as the radiation exposure.

The parametric data was obtained as read and record and all the raw data plus an attributes summary are contained in a separate Excel file. The attributes data contains the average, standard deviation and the average with the KTL values applied. The KTL value used in this work is 2.742 per MIL-HDBK-814 using one sided tolerance limits of 90/90 and a 5-piece sample size. The 90/90 KTL values were selected to match the statistical levels specified in the MIL-PRF-38535 sampling plan for the qualification of a radiation hardness assured (RHA) component. Note that the following criteria must be met for a device to pass the low dose rate test: following the radiation exposure each of the 5 pieces irradiated under electrical bias shall pass the specification value. The units irradiated without electrical bias and the KTL statistics are included in this report for reference only. If any of the 5 pieces irradiated under electrical bias exceed the datasheet specifications, then the lot could be logged as a failure.

Using the conditions stated above, the RH1086MK Low Dropout Positive Adjustable Regulator (from the lot date code identified on the first page of this test report) passed the low dose rate test with only minor degradation to the  $V_{OUT}$  parameters.



**Appendix A: Photograph of a Sample Unit-Under-Test to Show Part Markings**





## Appendix B: TID Bias Connections

*(Extracted from LINEAR TECHNOLOGY CORPORATION RH1086M Datasheet)*

### Biased Samples:

Pin	Function	Bias
1	ADJ	GND
2	VIN	+30V decoupled with 10 $\mu$ F Tantalum Capacitor
3 (CASE)	VOUT	GND via 150 $\Omega$ Resistor in Parallel with a 10 $\mu$ F Tantalum Capacitor

### Unbiased Samples (All Pins Tied to Ground):

Pin	Function	Bias
1	ADJ	GND
2	VIN	GND
3 (CASE)	VOUT	GND

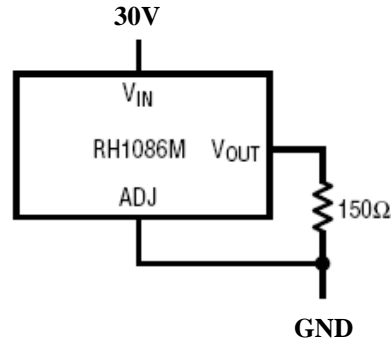

Figure B.1. Irradiation bias circuit for the units to be irradiated under electrical bias. Both the input and output must be decoupled with 10 $\mu$ F of tantalum capacitance (see bias table above). Note that this figure is intentionally different from the bias circuit defined in the LINEAR TECHNOLOGY CORPORATION RH1086M Datasheet and was approved by the customer.

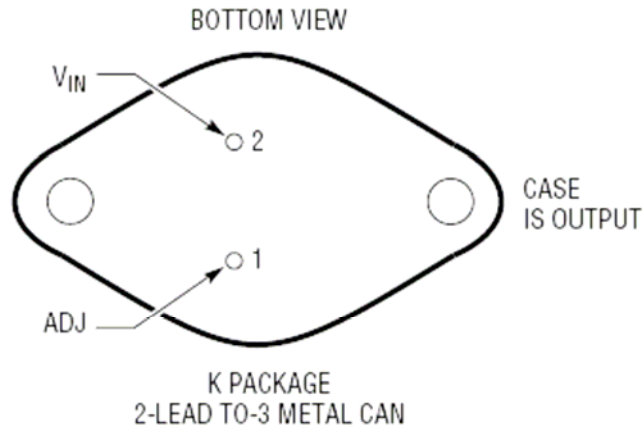

Figure B.2. K package drawing (for reference only). This figure was extracted from the LINEAR TECHNOLOGY CORPORATION RH1086M Datasheet.



## **Appendix C: Electrical Test Parameters and Conditions**

All electrical tests for this device are performed on one of Radiation Assured Device's LTS2020 Test Systems. The LTS2020 Test System is a programmable parametric tester that provides parameter measurements for a variety of digital, analog and mixed signal products including voltage regulators, voltage comparators, D to A and A to D converters. The LTS2020 Test System achieves accuracy and sensitivity through the use of software self-calibration and an internal relay matrix with separate family boards and custom personality adapter boards. The tester uses this relay matrix to connect the required test circuits, select the appropriate voltage / current sources and establish the needed measurement loops for all the tests performed. The tests will be conducted using the LTS-2101 Linear Family Board, LTS-0606 Regulator Fixture and the RH1086K BGSS-020602 DUT board. The measured parameters and test conditions are shown in Table C.1.

A listing of the measurement precision/resolution for each parameter is shown in Table C.2. The precision/resolution values were obtained either from test data or from the DAC resolution of the LTS-2020. To generate the precision/resolution shown in Table C.2, one of the units-under-test was tested repetitively (a total of 10-times with re-insertion between tests) to obtain the average test value and standard deviation. Using this test data MIL-HDBK-814 90/90 KTL statistics were applied to the measured standard deviation to generate the final measurement range. This value encompasses the precision/resolution of all aspects of the test system, including the LTS2020 mainframe, family board, socket assembly and DUT board as well as insertion error. In some cases, the measurement resolution is limited by the internal DACs, which results in a measured standard deviation of zero. In these instances the precision/resolution will be reported back as the LSB of the DAC.

Note that the testing and statistics used in this document are based on an "analysis of variables" technique, which relies on small sample sizes to qualify much larger lot sizes (see MIL-HDBK-814, p. 91 for a discussion of statistical treatments). Unfortunately, not all measured parameters are well suited to this approach due to relatively large variations within the sample population compared to the specification value. If necessary, larger samples sizes could be used to qualify these parameters using an "attributes" approach.



Table C.1. Measured parameters and test conditions for the RH1086MK. Unless otherwise noted the conditions were selected to match the post-irradiation specifications. See LINEAR TECHNOLOGY CORPORATION RH1086M Datasheet for the post irradiation test conditions and specifications.

<b>Test Description</b>	<b>Test Conditions</b> VDIFF = VIN-VOUT
Reference Voltage 1 (V)	VDIFF=3V IL=10mA
Reference Voltage 2 (V)	VDIFF=1.5V IL=10mA
Reference Voltage 3 (V)	VDIFF=1.5V IL=1.5A
Reference Voltage 4 (V)	VDIFF=15V IL=10mA
Reference Voltage 5 (V)	VDIFF=15V IL=500mA
Line Regulation (%)	VDIFF=1.5 to 15V IL=10mA
Load Regulation (%)	VDIFF=3V IL=10mA to 1.5A
Adj. Pin Current 1 (A)	VDIFF=1.5V IL=10mA
Adj. Pin Current 2 (A)	VDIFF=3V IL=10mA
Adj. Pin Current 3 (A)	VDIFF=15V IL=10mA
Adj. Pin Current 4 (A)	VDIFF=1.5V IL=1.5A
Adj. Pin Current 5 (A)	VDIFF=3V IL=1.5A
Adj. Pin Current 6 (A)	VDIFF=15V IL=500mA
Adj. Pin Current Change vs. Line 1 (A)	VDIFF=1.5 to 15V IL=10mA
Adj. Pin Current Change vs. Line 2 (A)	VDIFF=1.5 to 15V IL=500mA
Adj. Pin Current Change vs. Load 1 (A)	VDIFF=1.5V IL=10mA to 1.5A
Adj. Pin Current Change vs. Load 2 (A)	VDIFF=15V IL=10 to 500mA
Minimum Load Current (A)	(VIN-VOUT)= 25V
Current Limit 1 (A)	VDIFF=5V (A)
Current Limit 2 (A)	VDIFF=25V (A)
Dropout Voltage (V)	IL=1.5A



Table C.2. Measured parameters, pre-irradiation specifications and measurement resolution for the RH1086MK.

<b>Measured Parameter</b>	<b>Pre-Irradiation Specification</b>	<b>Measurement Precision/Resolution</b>
Reference Voltage (V)	1.238-1.262V 1.225-1.270V	±1.00E-03V
Line Regulation (%)	±0.2% MAX	±2.12E-02%
Load Regulation (%)	±0.3% MAX	±4.25E-02A
Adj. Pin Current (A)	120µA MAX	±6.45E-07A
Adj. Pin Current Change (A)	±5µA MAX	±4.98E-07A
Minimum Load Current (A)	10mA MAX	±5.51E-06A
Current Limit (A)	1.5A MIN 50mA MIN	±1E-03A
Dropout Voltage (V)	1.5V MAX	±5.94E-03V





## Appendix D: List of Figures used in Section 5 (Test Results)

- 5.1 Output Voltage (V) @  $V_{diff}=3V$ ,  $I_l=10mA$
- 5.2 Output Voltage (V) @  $V_{diff}=1.5V$ ,  $I_l=10mA$
- 5.3 Output Voltage (V) @  $V_{diff}=3V$ ,  $I_l=1.5A$
- 5.4 Output Voltage (V) @  $V_{diff}=15V$ ,  $I_l=10mA$
- 5.5 Output Voltage (V) @  $V_{diff}=15V$ ,  $I_l=0.5A$
- 5.6 Line Regulation (%);  $V_{diff}=1.5V$  to  $15V$ ,  $I_l=10mA$
- 5.7 Load Regulation (%);  $V_{diff}=3V$ ,  $I_l=10mA$  to  $1.5A$
- 5.8 Adjust pin Current (A);  $V_{diff}=1.5V$ ,  $I_l=10mA$
- 5.9 Adjust pin Current (A);  $V_{diff}=3V$ ,  $I_l=10mA$
- 5.10 Adjust pin Current (A);  $V_{diff}=15V$ ,  $I_l=10mA$
- 5.11 Adjust pin Current (A);  $V_{diff}=1.5V$ ,  $I_l=1.5A$
- 5.12 Adjust pin Current (A);  $V_{diff}=3V$ ,  $I_l=1.5A$
- 5.13 Adjust pin Current (A);  $V_{diff}=15V$ ,  $I_l=0.5A$
- 5.14 Adjust Pin Current Change (A);  $V_{diff}=1.5V$  to  $15V$ ,  $I_l=10mA$
- 5.15 Adjust Pin Current Change (A);  $V_{diff}=1.5V$  to  $15V$ ,  $I_l=0.5A$
- 5.16 Adjust Pin Current Change (A);  $V_{diff}=1.5V$ ,  $I_l=10mA$  to  $1.5A$
- 5.17 Adjust Pin Current Change (A);  $V_{diff}=1.5V$ ,  $I_l=10mA$  to  $0.5A$
- 5.18 Minimum Load Current (A);  $V_{diff}=25V$
- 5.19 Current Limit (A);  $V_{diff}=5V$
- 5.20 Current Limit (A);  $V_{diff}=25V$
- 5.21 Dropout Voltage (V) @  $I_l=1.5A$