



## ***Radiation Lot Acceptance Testing (RLAT) of the RH108AH Operational Amplifier for Linear Technology***

**Customer:** Linear Technology (PO 49797L)

**RAD Job Number:** 08-130

**Part Type Tested:** Linear Technology RH108H Operational Amplifier

**Commercial Part Number:** RH108AH

**Traceability Information:** Lot Date Code: 0737E, Fab Run # WP1270.1 W01, Can Assy Lot # 433301.5

**Quantity of Units:** 11 units total in TO cans, 5 units for biased irradiation, 5 units for unbiased irradiation and 1 control unit.

**External Traveler:** None required

**Pre-Irradiation Burn-In:** Burn-In performed by Linear Technology prior to receipt by RAD, Inc.

**TID Dose Rate and Maximum Total Dose:** 50-300rad(Si)/s to 50krad(Si) total ionizing dose

**TID Test Increments:** Pre-Irradiation, 10krad(Si), 20krad(Si), 30krad(Si) and 50krad(Si)

**TID Overtest and Post-Irradiation Anneal:** No overtest. 24-hour room temperature anneal followed by a 168-hour 100°C anneal. Both anneals were performed in the same electrical bias condition as the irradiations. Electrical measurements were made following each anneal increment.

**TID Test Standard:** MIL-STD-883G, Method 1019.7, Condition A

**TID Electrical Test Conditions:** Pre-irradiation, and within one hour following each radiation exposure.

**Test Programs:** RH108AS2.SRC

**Hardware:** LTS2020 Tester, 2101 Family Board, 0607 Fixture and RH108A DUT Board

**TID Bias Conditions:** Serial numbers 386-390 were biased during irradiation, serial numbers 391-395 were unbiased during irradiation and serial number 396 was used as the control.

**Facility:** Radiation Assured Devices Longmire Laboratories, Colorado Springs, CO

**Radiation Sources:** Co60 (JLSA 81-24)

**Irradiation and Test Temperature:** Ambient, room temperature

**RLAT Result: PASSED. All parts met datasheet specifications to 50krad(Si) with no substantial degradation to any measured parameter**

**An ISO 9001:2000 Certified Company**



## **1.0. Overview and Background**

It is well known that total dose ionizing radiation can cause parametric degradation and ultimately functional failure in electronic devices. The damage occurs via electron-hole pair production, transport and trapping in the dielectric and interface regions. In discrete devices the bulk of the damage is frequently manifested as a reduction in the gain and/or breakdown voltage of the device. The damage will usually anneal with time following the end of the radiation exposure. Due to this annealing, and to ensure a worst-case test condition MIL-STD-883 TM1019.7 calls out a dose rate of 50 to 300rad(Si)/s as Condition A and further specifies that the time from the end of an incremental radiation exposure and electrical testing shall be 1-hour or less and the total time from the end of one incremental irradiation to the beginning of the next incremental radiation step should be 2-hours or less. The work described in this report was performed to meet MIL-STD-883 TM1019.7 Condition A.

## **2.0. Radiation Test Apparatus**

The total ionizing dose testing described in this final report was performed using the facilities at Radiation Assured Devices' Longmire Laboratories in Colorado Springs, CO. The high dose rate total ionizing dose (TID) source is a JLSA 84-21 irradiator modified to provide a panoramic exposure. The Co-60 rods are held in the base of the irradiator heavily shielded by lead, during the radiation exposures the rod is raised by an electronic timer/controller and the exposure is performed in air. The dose rate for this irradiator in this configuration ranges from <1rad(Si)/s to a maximum of approximately 120rad(Si)/s, determined by the distance from the source. For high-dose rate experiments the bias boards are placed in a radial fashion equidistant from the raised Co-60 rods with the distance adjusted to provide the required dose rate. The irradiator calibration is maintained by Radiation Assured Devices Longmire Laboratories using thermoluminescent dosimeters (TLDs) traceable to the National Institute of Standards and Technology (NIST). Figure 2.1 shows a photograph of the JLSA 81-24 Co-60 irradiator at RAD's Longmire Laboratory facility.

RAD is currently certified by the Defense Supply Center Columbus (DSCC) for Laboratory Suitability under MIL STD 750. Additional details regarding Radiation Assured Devices dosimetry for TM1019 Condition A testing are available in RAD's report to DSCC entitled: "Dose Rate Mapping of the J.L. Shepherd and Associates Model 81 Irradiator Installed by Radiation Assured Devices"



Figure 2.1. Radiation Assured Devices' high dose rate Co-60 irradiator. The dose rate is obtained by positioning the device-under-test at a fixed distance from the gamma cell. The dose rate for this irradiator varies from approximately 120rad(Si)/s close to the rods down to 1rad(Si)/s at a distance of approximately 2-feet.



### **3.0. Radiation Test Conditions**

The RH108AH Operational Amplifier described in this final report was tested using two bias conditions, biased with a split 15V supply and all pins tied to ground, see Appendix A for details on biasing conditions. These bias circuits satisfy the requirements of MIL-STD-883G TM1019.7 Section 3.9.3 Bias and Loading Conditions which states “The bias applied to the test devices shall be selected to produce the greatest radiation induced damage or the worst-case damage for the intended application, if known. While maximum voltage is often worst case some bipolar linear device parameters (e.g. input bias current or maximum output load current) exhibit more degradation with 0 V bias.”

The devices were irradiated to a maximum total ionizing dose level of 50krad(Si) with incremental readings at 10, 20, 30 and 50krad(Si). Electrical testing occurred within one hour following the end of each irradiation segment. For intermediate irradiations, the units were tested and returned to total dose exposure within two hours from the end of the previous radiation increment. The TID bias board was positioned in the Co-60 cell to provide the required minimum of 50rad(Si)/s and was located inside a lead-aluminum enclosure. The lead-aluminum enclosure is required under MIL-STD-883G TM1019.7 Section 3.4 that reads as follows: “Lead/Aluminum (Pb/Al) container. Test specimens shall be enclosed in a Pb/Al container to minimize dose enhancement effects caused by low-energy, scattered radiation. A minimum of 1.5 mm Pb, surrounding an inner shield of at least 0.7 mm Al, is required. This Pb/Al container produces an approximate charged particle equilibrium for Si and for TLDs such as CaF<sub>2</sub>. The radiation field intensity shall be measured inside the Pb/Al container (1) initially, (2) when the source is changed, or (3) when the orientation or configuration of the source, container, or test-fixture is changed. This measurement shall be performed by placing a dosimeter (e.g., a TLD) in the device-irradiation container at the approximate test-device position. If it can be demonstrated that low energy scattered radiation is small enough that it will not cause dosimetry errors due to dose enhancement, the Pb/Al container may be omitted”.

The final dose rate within the lead-aluminum box was determined based on TLD dosimetry measurements just prior to the beginning of the total dose irradiations. The final dose rate for this work was 50rad(Si)/s with a precision of  $\pm 5\%$ .



#### **4.0. Tested Parameters**

The following parameters were tested during the course of this work:

1. Positive Supply Current
2. Negative Supply Current
3. Input Offset Voltage
4. Input Offset Current
5. + Input Bias Current
6. - Input Bias Current
7. Large Signal Voltage Gain
8. Common Mode Rejection Ratio
9. Power Supply Rejection Ratio

Appendix C details the measured parameters, test conditions, pre-irradiation specification and measurement resolution for each of the measurements.

The parametric data was obtained as “read and record” and all the raw data plus an attributes summary are contained in this report as well as in a separate Excel file. The attributes data contains the average, standard deviation and the average with the KTL values applied. The KTL values used is 2.742 per MIL HDBK 814 using one sided tolerance limits of 90/90 and a 5-piece sample size. This survival probability/level of confidence is consistent with a 22-piece sample size and zero failures analyzed using a lot tolerance percent defective (LTPD) approach. Note that the following criteria must be met for a device to pass the TID testing: following the radiation exposure the unit shall pass the specification value and the average value for the each device must pass the specification value when the KTL limits are applied. If either of these conditions is not satisfied following the radiation exposure, then the lot could be logged as an RLAT failure.

Further, MIL-STD-883G, TM 1019.7 Section 3.13.1.1 Characterization test to determine if a part exhibits ELDRS” states the following: Select a minimum random sample of 21 devices from a population representative of recent production runs. Smaller sample sizes may be used if agreed upon between the parties to the test. All of the selected devices shall have undergone appropriate elevated temperature reliability screens, e.g. burn-in and high temperature storage life. Divide the samples into four groups of 5 each and use the remaining part for a control. Perform pre-irradiation electrical characterization on all parts assuring that they meet the Group A electrical tests. Irradiate 5 samples under a 0 volt bias and another 5 under the irradiation bias given in the acquisition specification at 50-300 rad(Si)/s and room temperature. Irradiate 5 samples under a 0 volt bias and another 5 under irradiation bias given in the acquisition specification at < 10mrad(Si)/s and room temperature. Irradiate all samples to the same dose levels, including 0.5 and 1.0 times the anticipated specification dose, and repeat the electrical characterization on each part at each dose level. Post irradiation electrical measurements shall be performed per paragraph 3.10 where the low dose rate test is considered



Condition D. Calculate the radiation induced change in each electrical parameter ( $\Delta$ para) for each sample at each radiation level. Calculate the ratio of the median  $\Delta$ para at low dose rate to the median  $\Delta$ para at high dose rate for each irradiation bias group at each total dose level. If this ratio exceeds 1.5 for any of the most sensitive parameters then the part is considered to be ELDRS susceptible. This test does not apply to parameters which exhibit changes that are within experimental error or whose values are below the pre-irradiation electrical specification limits at low dose rate at the specification dose.

Therefore, the data in this report can be analyzed along with the low dose rate report titled “Enhanced Low Dose Rate Sensitivity (ELDRS) Radiation Testing of the RH108AH Operational Amplifier for Linear Technology” to demonstrate that these parts do not exhibit ELDRS as defined in the current test method.

### **5.0. TID Test Results**

Using the conditions stated above, the RH108AH devices passed the radiation lot acceptance test to 50krad(Si) with no degradation to any measured parameter sufficient to cause it to go out of specification, including after application of the KTL statistics. Figures 5.1 through 5.24 show plots of all the measured parameters versus total ionizing dose. In these data plots the solid diamonds are the average of the measured data points for the sample irradiated under electrical bias while the shaded diamonds are the average of the measured data points for the units irradiated with all pins tied to ground. The black lines (solid or dashed) are the average of the data points after application of the KTL statistics on the sample irradiated in the biased condition while the shaded lines (solid or dashed) are the average of the data points after application of the KTL statistics on the sample irradiated in the unbiased condition. The red dotted line(s) are the pre- and/or post-irradiation minimum and/or maximum specification value as defined in the datasheet and/or test plan. Similarly, tables 5.1 through 5.24 show the raw data, averages, standard deviation, +KTL statistics, -KTL statistics, specification limit and Pass/Fail condition for each parameter.

As seen clearly in these figures, the pre- and post-irradiation data are well within the specification even after application of the KTL statistics and the control units, as expected, show no significant changes to any of the parameters throughout the course of the measurements. Therefore we can conclude that any observed degradation was due to the radiation exposure.



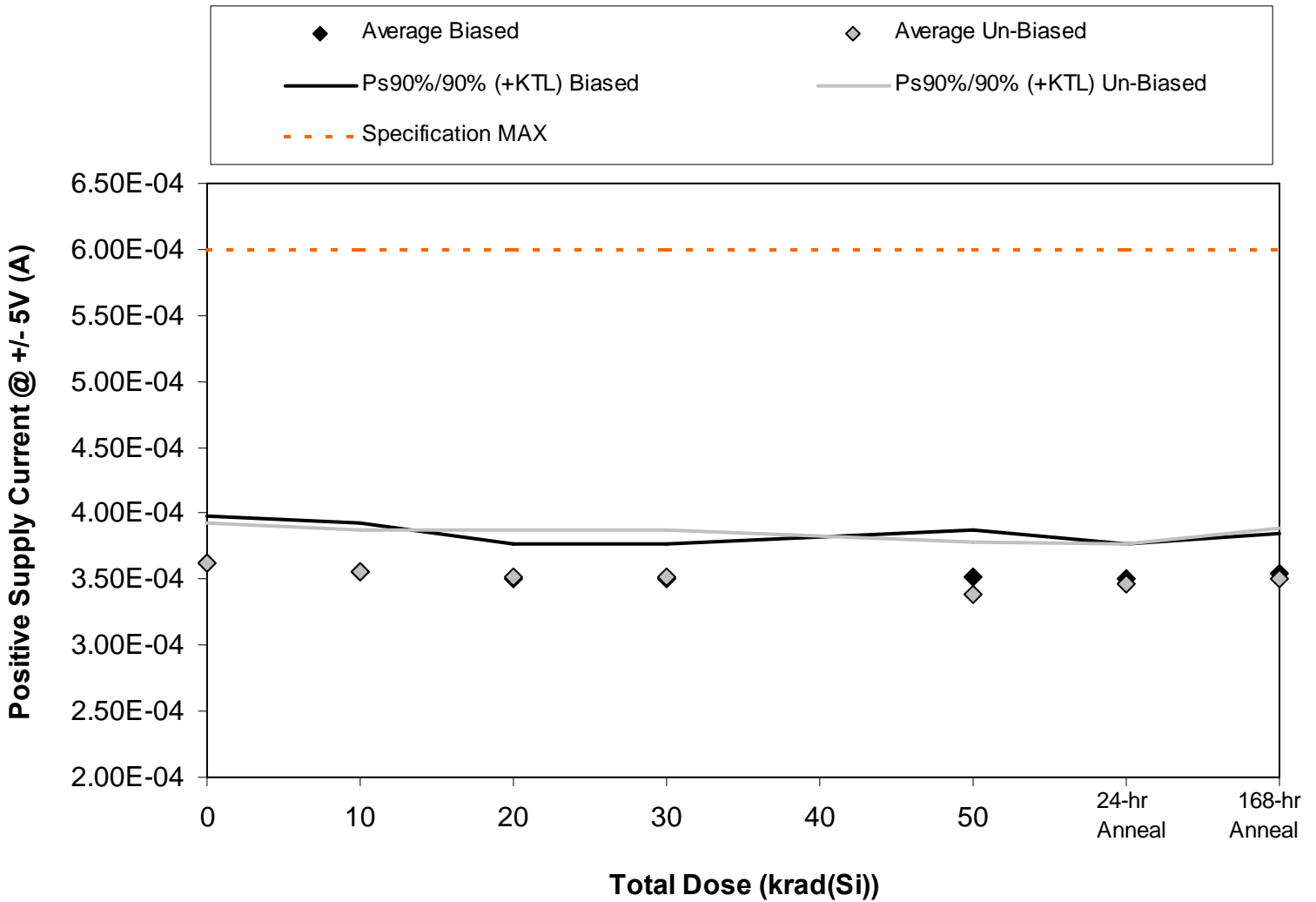

Figure 5.1. Plot of positive supply current at  $V_S = \pm 5V$  versus total dose. The data shows no significant degradation with dose. The solid diamonds are the average of the measured data points for the sample irradiated under electrical bias while the shaded diamonds are the average of the measured data points for the units irradiated with all pins tied to ground. The black lines (solid or dashed) are the average of the data points after application of the KTL statistics on the sample irradiated in the biased condition while the shaded lines (solid or dashed) are the average of the data points after application of the KTL statistics on the sample irradiated in the unbiased condition. The red dotted line(s) are the pre- and/or post-irradiation minimum and/or maximum specification value as defined in the datasheet and/or test plan.



Table 5.1. Raw data for the positive supply current at  $V_S = \pm 5V$  versus total dose, including the statistical analysis, specification and the status of the testing (pass/fail)

Positive Supply Current @ +/- 5V (A)	Total Dose (krad(Si))					24 Hr Anneal	168 Hr Anneal
	0	10	20	30	50		
Device							
386	3.50E-04	3.40E-04	3.40E-04	3.40E-04	3.40E-04	3.40E-04	3.40E-04
387	3.50E-04	3.50E-04	3.40E-04	3.60E-04	3.40E-04	3.40E-04	3.50E-04
388	3.70E-04	3.70E-04	3.60E-04	3.40E-04	3.60E-04	3.60E-04	3.70E-04
389	3.60E-04	3.50E-04	3.50E-04	3.50E-04	3.50E-04	3.50E-04	3.50E-04
390	3.80E-04	3.70E-04	3.60E-04	3.60E-04	3.70E-04	3.60E-04	3.60E-04
391	3.50E-04	3.50E-04	3.40E-04	3.40E-04	3.30E-04	3.40E-04	3.50E-04
392	3.60E-04	3.60E-04	3.50E-04	3.50E-04	3.40E-04	3.50E-04	3.50E-04
393	3.80E-04	3.70E-04	3.70E-04	3.70E-04	3.60E-04	3.60E-04	3.70E-04
394	3.60E-04	3.60E-04	3.60E-04	3.60E-04	3.40E-04	3.50E-04	3.50E-04
395	3.60E-04	3.40E-04	3.40E-04	3.40E-04	3.20E-04	3.30E-04	3.30E-04
396	3.50E-04	3.50E-04	3.60E-04	3.60E-04	3.50E-04	3.50E-04	3.50E-04
<b>Biased Statistics</b>							
Average Biased	3.62E-04	3.56E-04	3.50E-04	3.50E-04	3.52E-04	3.50E-04	3.54E-04
Std Dev Biased	1.30E-05	1.34E-05	1.00E-05	1.00E-05	1.30E-05	1.00E-05	1.14E-05
Ps90%/90% (+KTL) Biased	3.98E-04	3.93E-04	3.77E-04	3.77E-04	3.88E-04	3.77E-04	3.85E-04
Ps90%/90% (-KTL) Biased	3.26E-04	3.19E-04	3.23E-04	3.23E-04	3.16E-04	3.23E-04	3.23E-04
<b>Un-Biased Statistics</b>							
Average Un-Biased	3.62E-04	3.56E-04	3.52E-04	3.52E-04	3.38E-04	3.46E-04	3.50E-04
Std Dev Un-Biased	1.10E-05	1.14E-05	1.30E-05	1.30E-05	1.48E-05	1.14E-05	1.41E-05
Ps90%/90% (+KTL) Un-Biased	3.92E-04	3.87E-04	3.88E-04	3.88E-04	3.79E-04	3.77E-04	3.89E-04
Ps90%/90% (-KTL) Un-Biased	3.32E-04	3.25E-04	3.16E-04	3.16E-04	2.97E-04	3.15E-04	3.11E-04
<b>Specification MAX</b>	<b>6.00E-04</b>	<b>6.00E-04</b>	<b>6.00E-04</b>	<b>6.00E-04</b>	<b>6.00E-04</b>	<b>6.00E-04</b>	<b>6.00E-04</b>
Status	PASS	PASS	PASS	PASS	PASS	PASS	PASS



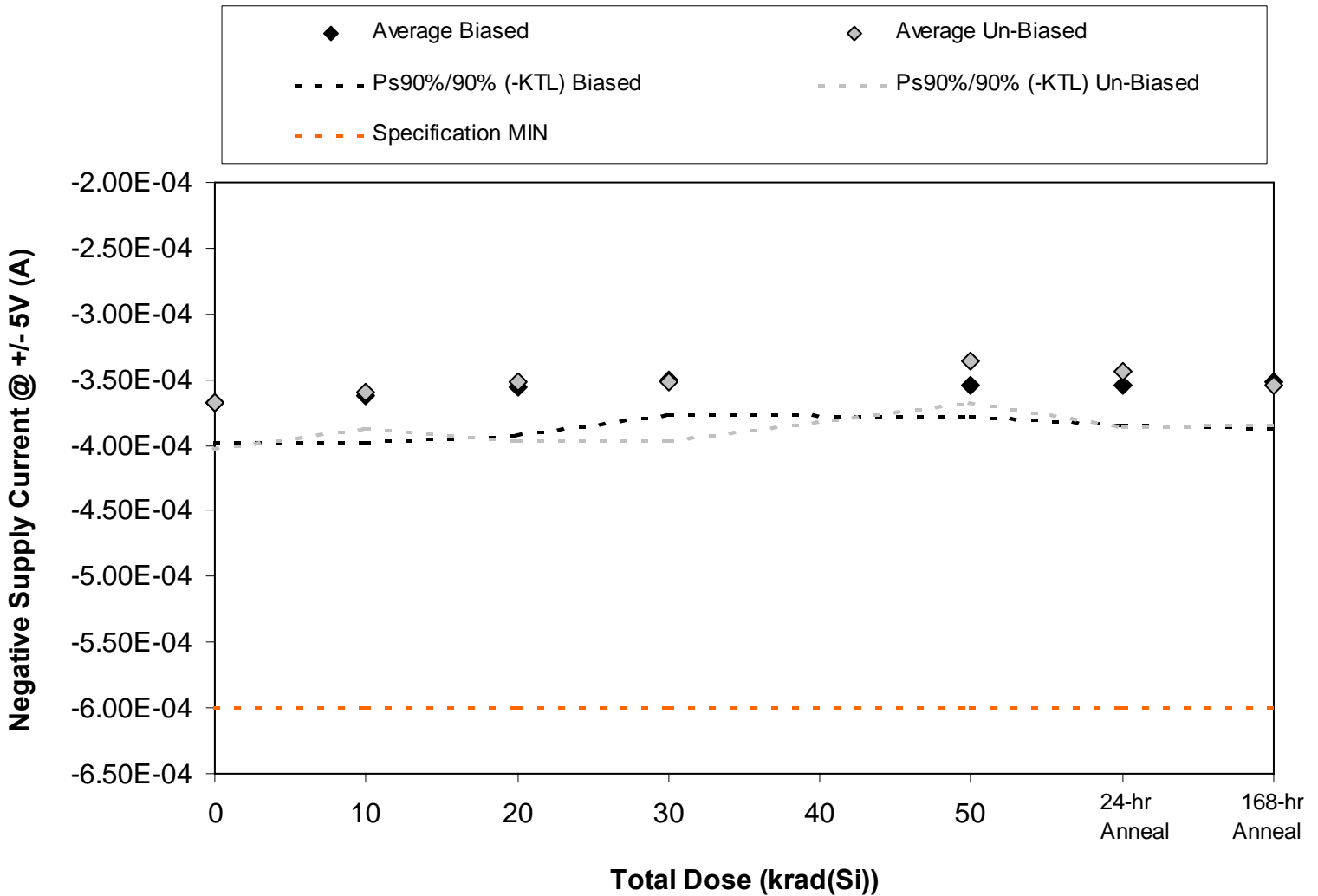

Figure 5.2. Plot of negative supply current at  $V_S = \pm 5V$  versus total dose. The data shows no significant degradation with dose. The solid diamonds are the average of the measured data points for the sample irradiated under electrical bias while the shaded diamonds are the average of the measured data points for the units irradiated with all pins tied to ground. The black lines (solid or dashed) are the average of the data points after application of the KTL statistics on the sample irradiated in the biased condition while the shaded lines (solid or dashed) are the average of the data points after application of the KTL statistics on the sample irradiated in the unbiased condition. The red dotted line(s) are the pre- and/or post-irradiation minimum and/or maximum specification value as defined in the datasheet and/or test plan.



Table 5.2. Raw data for the negative supply current at  $V_S = \pm 5V$  versus total dose, including the statistical analysis, the specification and the status of the testing (pass/fail).

Negative Supply Current @ +/- 5V (A)	Total Dose (krad(Si))					24 Hr Anneal	168 Hr Anneal
	0	10	20	30	50		
Device							
386	-3.60E-04	-3.50E-04	-3.50E-04	-3.40E-04	-3.50E-04	-3.50E-04	-3.40E-04
387	-3.60E-04	-3.50E-04	-3.40E-04	-3.60E-04	-3.40E-04	-3.40E-04	-3.40E-04
388	-3.80E-04	-3.70E-04	-3.70E-04	-3.40E-04	-3.60E-04	-3.60E-04	-3.70E-04
389	-3.60E-04	-3.60E-04	-3.50E-04	-3.50E-04	-3.60E-04	-3.50E-04	-3.50E-04
390	-3.80E-04	-3.80E-04	-3.70E-04	-3.60E-04	-3.60E-04	-3.70E-04	-3.60E-04
391	-3.60E-04	-3.50E-04	-3.40E-04	-3.40E-04	-3.30E-04	-3.40E-04	-3.50E-04
392	-3.70E-04	-3.60E-04	-3.60E-04	-3.60E-04	-3.40E-04	-3.50E-04	-3.60E-04
393	-3.80E-04	-3.70E-04	-3.70E-04	-3.70E-04	-3.50E-04	-3.60E-04	-3.70E-04
394	-3.80E-04	-3.70E-04	-3.60E-04	-3.60E-04	-3.40E-04	-3.50E-04	-3.50E-04
395	-3.50E-04	-3.50E-04	-3.30E-04	-3.30E-04	-3.20E-04	-3.20E-04	-3.40E-04
396	-3.50E-04	-3.50E-04	-3.60E-04	-3.60E-04	-3.50E-04	-3.60E-04	-3.50E-04
<b>Biased Statistics</b>							
Average Biased	-3.68E-04	-3.62E-04	-3.56E-04	-3.50E-04	-3.54E-04	-3.54E-04	-3.52E-04
Std Dev Biased	1.10E-05	1.30E-05	1.34E-05	1.00E-05	8.94E-06	1.14E-05	1.30E-05
Ps90%/90% (+KTL) Biased	-3.38E-04	-3.26E-04	-3.19E-04	-3.23E-04	-3.29E-04	-3.23E-04	-3.16E-04
Ps90%/90% (-KTL) Biased	-3.98E-04	-3.98E-04	-3.93E-04	-3.77E-04	-3.79E-04	-3.85E-04	-3.88E-04
<b>Un-Biased Statistics</b>							
Average Un-Biased	-3.68E-04	-3.60E-04	-3.52E-04	-3.52E-04	-3.36E-04	-3.44E-04	-3.54E-04
Std Dev Un-Biased	1.30E-05	1.00E-05	1.64E-05	1.64E-05	1.14E-05	1.52E-05	1.14E-05
Ps90%/90% (+KTL) Un-Biased	-3.32E-04	-3.33E-04	-3.07E-04	-3.07E-04	-3.05E-04	-3.02E-04	-3.23E-04
Ps90%/90% (-KTL) Un-Biased	-4.04E-04	-3.87E-04	-3.97E-04	-3.97E-04	-3.67E-04	-3.86E-04	-3.85E-04
Specification MIN	-6.00E-04	-6.00E-04	-6.00E-04	-6.00E-04	-6.00E-04	-6.00E-04	-6.00E-04
Status	PASS	PASS	PASS	PASS	PASS	PASS	PASS

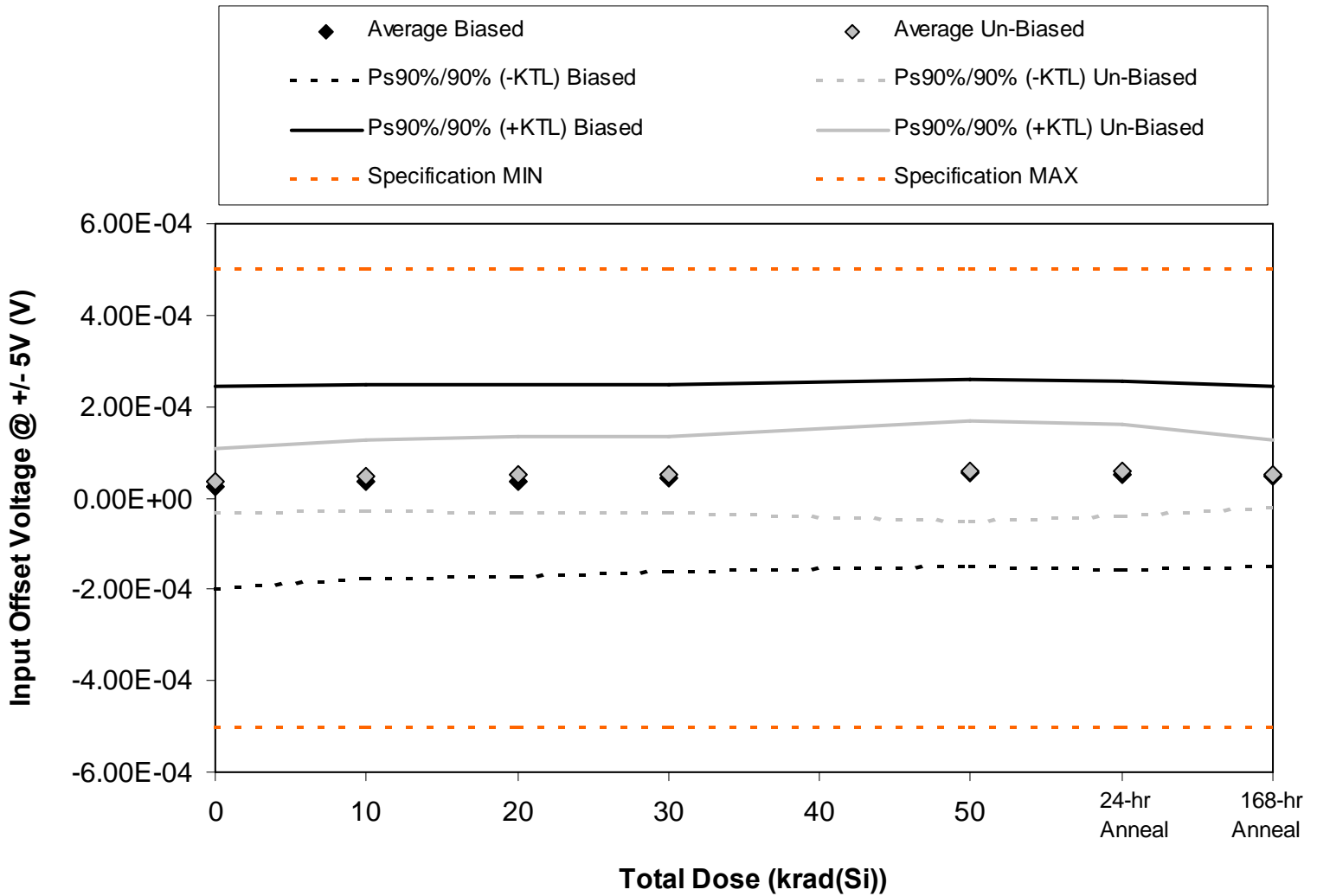

Figure 5.3. Plot of input offset voltage at  $V_S = \pm 5V$  versus total dose. The data shows no significant degradation with dose. The solid diamonds are the average of the measured data points for the sample irradiated under electrical bias while the shaded diamonds are the average of the measured data points for the units irradiated with all pins tied to ground. The black lines (solid or dashed) are the average of the data points after application of the KTL statistics on the sample irradiated in the biased condition while the shaded lines (solid or dashed) are the average of the data points after application of the KTL statistics on the sample irradiated in the unbiased condition. The red dotted line(s) are the pre- and/or post-irradiation minimum and/or maximum specification value as defined in the datasheet and/or test plan.



Table 5.3. Raw data for the input offset voltage at  $V_s = \pm 5V$  versus total dose, including the statistical analysis, the specification and the status of the testing (pass/fail)

Input Offset Voltage @ +/- 5V (V)	Total Dose (krad(Si))					24 Hr Anneal	168 Hr Anneal
	0	10	20	30	50		
Device							
386	-9.80E-05	-8.10E-05	-7.30E-05	-6.30E-05	-5.20E-05	-5.60E-05	-5.40E-05
387	5.30E-05	6.30E-05	6.60E-05	3.90E-05	8.50E-05	8.00E-05	7.50E-05
388	3.70E-05	4.70E-05	4.10E-05	7.20E-05	4.90E-05	4.60E-05	5.30E-05
389	5.00E-06	1.60E-05	1.50E-05	2.70E-05	3.80E-05	3.10E-05	2.10E-05
390	1.23E-04	1.31E-04	1.38E-04	1.42E-04	1.54E-04	1.50E-04	1.40E-04
391	2.90E-05	2.70E-05	2.10E-05	2.10E-05	8.00E-06	1.50E-05	3.70E-05
392	-2.00E-06	1.00E-05	1.50E-05	1.50E-05	2.40E-05	2.60E-05	1.20E-05
393	4.60E-05	5.90E-05	6.40E-05	6.40E-05	7.90E-05	7.70E-05	6.20E-05
394	6.10E-05	7.60E-05	8.10E-05	8.10E-05	9.20E-05	9.10E-05	7.60E-05
395	5.40E-05	7.00E-05	7.50E-05	7.50E-05	9.20E-05	9.00E-05	7.10E-05
396	4.90E-05	5.90E-05	5.60E-05	5.60E-05	5.60E-05	5.40E-05	4.70E-05
<b>Biased Statistics</b>							
Average Biased	2.40E-05	3.52E-05	3.74E-05	4.34E-05	5.48E-05	5.02E-05	4.70E-05
Std Dev Biased	8.07E-05	7.74E-05	7.69E-05	7.44E-05	7.50E-05	7.50E-05	7.13E-05
Ps90%/90% (+KTL) Biased	2.45E-04	2.47E-04	2.48E-04	2.47E-04	2.60E-04	2.56E-04	2.43E-04
Ps90%/90% (-KTL) Biased	-1.97E-04	-1.77E-04	-1.73E-04	-1.61E-04	-1.51E-04	-1.56E-04	-1.49E-04
<b>Un-Biased Statistics</b>							
Average Un-Biased	3.76E-05	4.84E-05	5.12E-05	5.12E-05	5.90E-05	5.98E-05	5.16E-05
Std Dev Un-Biased	2.51E-05	2.86E-05	3.10E-05	3.10E-05	4.00E-05	3.65E-05	2.67E-05
Ps90%/90% (+KTL) Un-Biased	1.07E-04	1.27E-04	1.36E-04	1.36E-04	1.69E-04	1.60E-04	1.25E-04
Ps90%/90% (-KTL) Un-Biased	-3.13E-05	-3.00E-05	-3.38E-05	-3.38E-05	-5.07E-05	-4.03E-05	-2.17E-05
<b>Specification MIN</b>	<b>-5.00E-04</b>	<b>-5.00E-04</b>	<b>-5.00E-04</b>	<b>-5.00E-04</b>	<b>-5.00E-04</b>	<b>-5.00E-04</b>	<b>-5.00E-04</b>
Status	PASS	PASS	PASS	PASS	PASS	PASS	PASS
<b>Specification MAX</b>	<b>5.00E-04</b>	<b>5.00E-04</b>	<b>5.00E-04</b>	<b>5.00E-04</b>	<b>5.00E-04</b>	<b>5.00E-04</b>	<b>5.00E-04</b>
Status	PASS	PASS	PASS	PASS	PASS	PASS	PASS

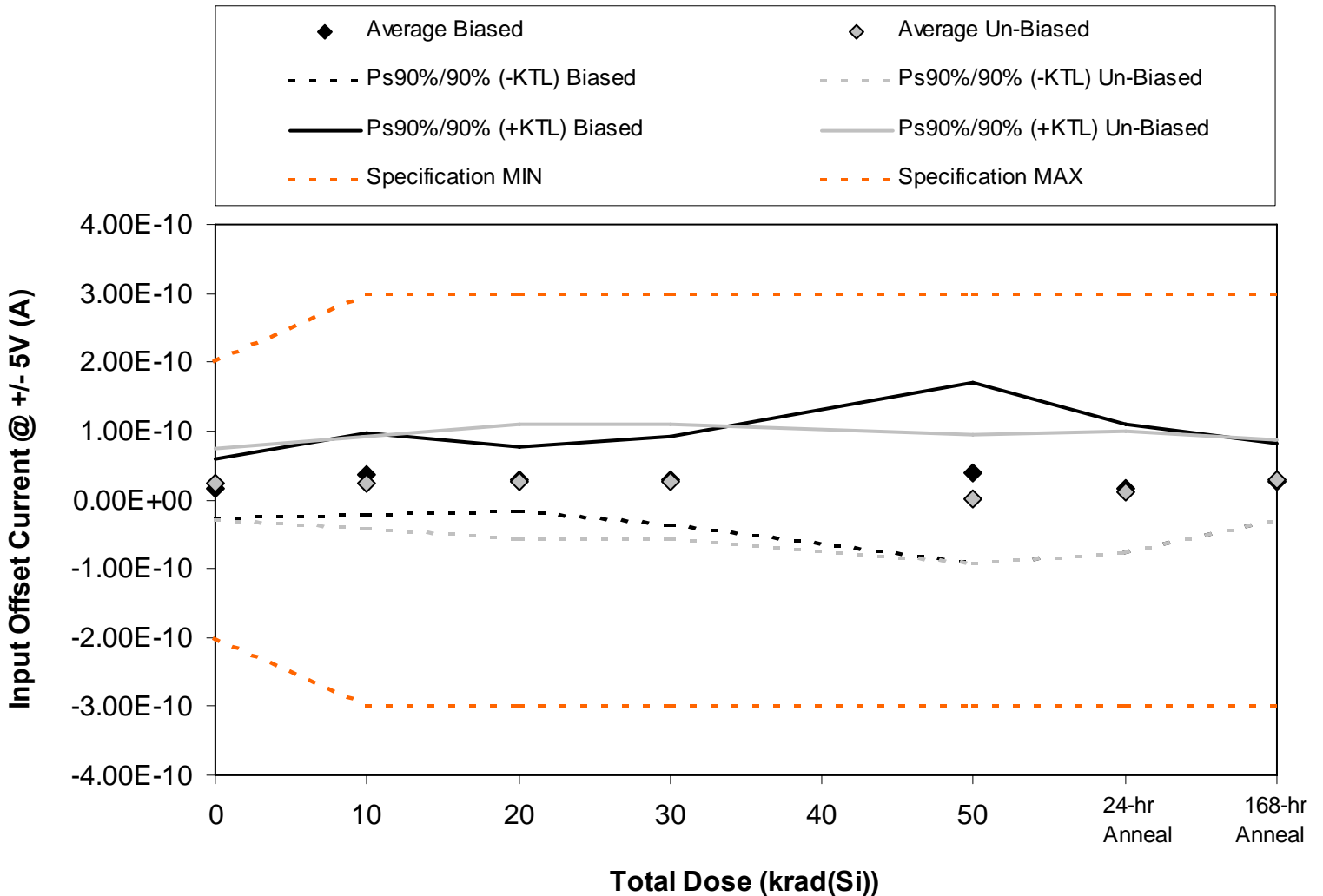

Figure 5.4. Plot of input offset current at  $V_S = \pm 5V$  versus total dose. The data no significant increase with dose. The solid diamonds are the average of the measured data points for the sample irradiated under electrical bias while the shaded diamonds are the average of the measured data points for the units irradiated with all pins tied to ground. The black lines (solid or dashed) are the average of the data points after application of the KTL statistics on the sample irradiated in the biased condition while the shaded lines (solid or dashed) are the average of the data points after application of the KTL statistics on the sample irradiated in the unbiased condition. The red dotted line(s) are the pre- and/or post-irradiation minimum and/or maximum specification value as defined in the datasheet and/or test plan.



Table 5.4. Raw data for input offset current at  $V_S = \pm 5V$  versus total dose, including the statistical analysis, the specification and the status of the testing (pass/fail).

Input Offset Current @ +/- 5V (A)	Total Dose (krad(Si))					24 Hr Anneal	168 Hr Anneal
	0	10	20	30	50		
Device							
386	0.00E+00	4.00E-11	2.20E-11	0.00E+00	-3.10E-11	-1.10E-11	-3.00E-12
387	0.00E+00	6.50E-11	2.20E-11	2.80E-11	1.40E-11	-7.00E-12	5.20E-11
388	1.80E-11	4.00E-12	1.10E-11	1.40E-11	5.50E-11	3.60E-11	2.40E-11
389	3.10E-11	3.60E-11	5.40E-11	3.60E-11	9.00E-11	6.80E-11	3.80E-11
390	3.10E-11	4.30E-11	4.00E-11	6.10E-11	6.60E-11	-4.00E-12	2.10E-11
391	4.50E-11	5.60E-11	3.80E-11	3.80E-11	7.00E-12	4.00E-12	3.00E-12
392	3.60E-11	4.30E-11	7.20E-11	7.20E-11	5.60E-11	6.10E-11	5.50E-11
393	4.00E-12	-3.00E-12	0.00E+00	0.00E+00	-2.80E-11	-2.90E-11	1.70E-11
394	4.00E-12	1.30E-11	0.00E+00	0.00E+00	-7.00E-12	4.00E-12	4.50E-11
395	2.70E-11	1.30E-11	1.70E-11	1.70E-11	-2.30E-11	1.40E-11	2.60E-11
396	-1.30E-11	-1.70E-11	-1.30E-11	-1.30E-11	-1.00E-11	-1.70E-11	-1.30E-11
<b>Biased Statistics</b>							
Average Biased	1.60E-11	3.76E-11	2.98E-11	2.78E-11	3.88E-11	1.64E-11	2.64E-11
Std Dev Biased	1.55E-11	2.19E-11	1.71E-11	2.31E-11	4.77E-11	3.45E-11	2.05E-11
Ps90%/90% (+KTL) Biased	5.86E-11	9.76E-11	7.66E-11	9.11E-11	1.70E-10	1.11E-10	8.27E-11
Ps90%/90% (-KTL) Biased	-2.66E-11	-2.24E-11	-1.70E-11	-3.55E-11	-9.21E-11	-7.82E-11	-2.99E-11
<b>Un-Biased Statistics</b>							
Average Un-Biased	2.32E-11	2.44E-11	2.54E-11	2.54E-11	1.00E-12	1.08E-11	2.92E-11
Std Dev Un-Biased	1.86E-11	2.43E-11	3.04E-11	3.04E-11	3.37E-11	3.24E-11	2.10E-11
Ps90%/90% (+KTL) Un-Biased	7.43E-11	9.09E-11	1.09E-10	1.09E-10	9.34E-11	9.97E-11	8.67E-11
Ps90%/90% (-KTL) Un-Biased	-2.79E-11	-4.21E-11	-5.79E-11	-5.79E-11	-9.14E-11	-7.81E-11	-2.83E-11
<b>Specification MIN</b>	<b>-2.00E-10</b>	<b>-3.00E-10</b>	<b>-3.00E-10</b>	<b>-3.00E-10</b>	<b>-3.00E-10</b>	<b>-3.00E-10</b>	<b>-3.00E-10</b>
Status	PASS	PASS	PASS	PASS	PASS	PASS	PASS
<b>Specification MAX</b>	<b>2.00E-10</b>	<b>3.00E-10</b>	<b>3.00E-10</b>	<b>3.00E-10</b>	<b>3.00E-10</b>	<b>3.00E-10</b>	<b>3.00E-10</b>
Status	PASS	PASS	PASS	PASS	PASS	PASS	PASS



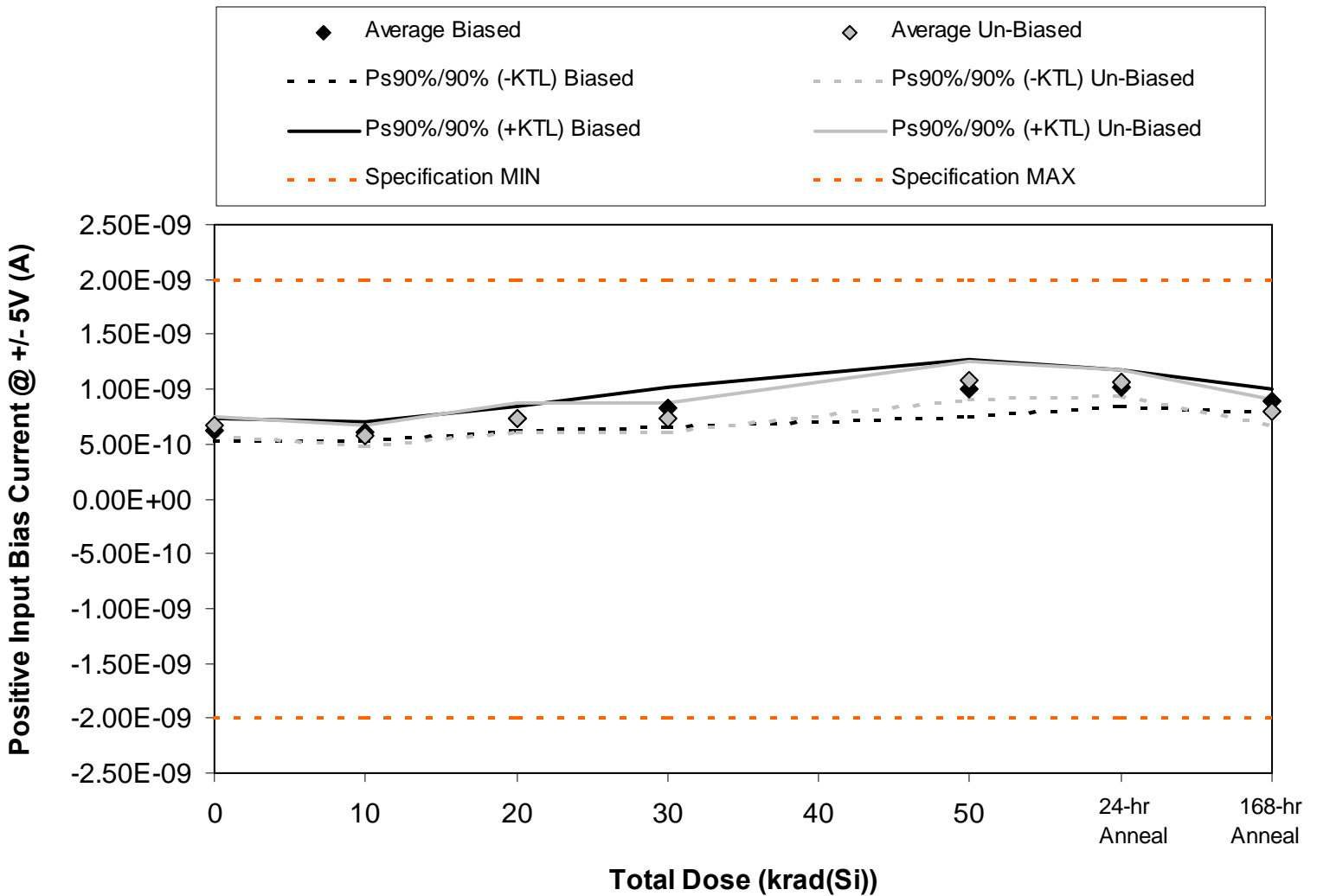

Figure 5.5. Plot of input bias current (non-inverting input) at  $V_S = \pm 5V$  versus total dose. The data shows no significant degradation with dose. The solid diamonds are the average of the measured data points for the sample irradiated under electrical bias while the shaded diamonds are the average of the measured data points for the units irradiated with all pins tied to ground. The black lines (solid or dashed) are the average of the data points after application of the KTL statistics on the sample irradiated in the biased condition while the shaded lines (solid or dashed) are the average of the data points after application of the KTL statistics on the sample irradiated in the unbiased condition. The red dotted line(s) are the pre- and/or post-irradiation minimum and/or maximum specification value as defined in the datasheet and/or test plan.



Table 5.5. Raw data for input bias current (non-inverting input) at  $V_S = \pm 5V$  versus total dose, including the statistical analysis, the specification and the status of the testing (pass/fail).

Positive Input Bias Current @ +/- 5V (A)	Total Dose (krad(Si))					24 Hr Anneal	168 Hr Anneal
	0	10	20	30	50		
Device							
386	6.77E-10	6.52E-10	7.67E-10	8.66E-10	1.05E-09	1.03E-09	9.22E-10
387	6.45E-10	6.34E-10	7.38E-10	7.25E-10	1.05E-09	1.03E-09	9.01E-10
388	5.92E-10	5.80E-10	6.59E-10	8.32E-10	8.35E-10	9.11E-10	8.15E-10
389	6.32E-10	5.98E-10	7.38E-10	8.54E-10	1.05E-09	1.03E-09	8.98E-10
390	5.88E-10	5.83E-10	7.31E-10	8.93E-10	1.04E-09	1.07E-09	8.91E-10
391	6.72E-10	5.86E-10	7.49E-10	7.49E-10	1.03E-09	1.01E-09	7.28E-10
392	6.94E-10	6.12E-10	8.18E-10	8.18E-10	1.19E-09	1.13E-09	8.39E-10
393	6.32E-10	5.33E-10	6.95E-10	6.95E-10	1.06E-09	1.04E-09	7.91E-10
394	6.36E-10	5.53E-10	7.28E-10	7.28E-10	1.06E-09	1.04E-09	8.22E-10
395	6.99E-10	6.02E-10	7.15E-10	7.15E-10	1.07E-09	1.07E-09	7.64E-10
396	6.19E-10	4.60E-10	4.60E-10	4.60E-10	4.60E-10	5.01E-10	4.60E-10
<b>Biased Statistics</b>							
Average Biased	6.27E-10	6.09E-10	7.27E-10	8.34E-10	1.00E-09	1.02E-09	8.85E-10
Std Dev Biased	3.74E-11	3.21E-11	4.03E-11	6.48E-11	9.46E-11	6.06E-11	4.10E-11
Ps90%/90% (+KTL) Biased	7.29E-10	6.97E-10	8.37E-10	1.01E-09	1.26E-09	1.18E-09	9.98E-10
Ps90%/90% (-KTL) Biased	5.24E-10	5.21E-10	6.16E-10	6.56E-10	7.45E-10	8.50E-10	7.73E-10
<b>Un-Biased Statistics</b>							
Average Un-Biased	6.67E-10	5.77E-10	7.41E-10	7.41E-10	1.08E-09	1.06E-09	7.89E-10
Std Dev Un-Biased	3.15E-11	3.33E-11	4.73E-11	4.73E-11	6.14E-11	4.22E-11	4.45E-11
Ps90%/90% (+KTL) Un-Biased	7.53E-10	6.69E-10	8.71E-10	8.71E-10	1.25E-09	1.18E-09	9.11E-10
Ps90%/90% (-KTL) Un-Biased	5.80E-10	4.86E-10	6.11E-10	6.11E-10	9.11E-10	9.44E-10	6.67E-10
Specification MIN	-2.00E-09	-2.00E-09	-2.00E-09	-2.00E-09	-2.00E-09	-2.00E-09	-2.00E-09
Status	PASS	PASS	PASS	PASS	PASS	PASS	PASS
Specification MAX	2.00E-09	2.00E-09	2.00E-09	2.00E-09	2.00E-09	2.00E-09	2.00E-09
Status	PASS	PASS	PASS	PASS	PASS	PASS	PASS

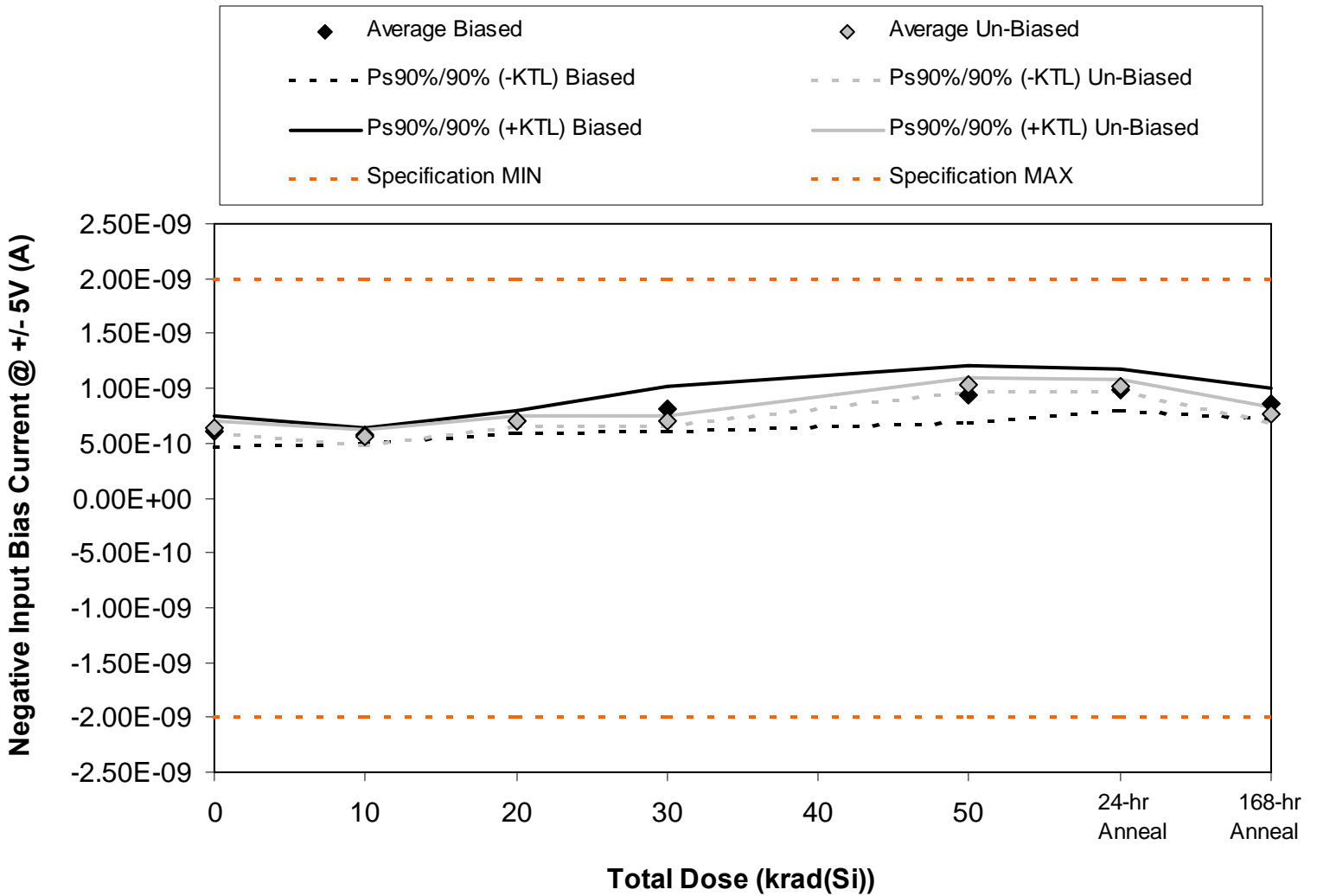

Figure 5.6. Plot of input bias current (inverting input) at  $V_S = \pm 5V$  versus total dose. The data shows no significant degradation with dose. The solid diamonds are the average of the measured data points for the sample irradiated under electrical bias while the shaded diamonds are the average of the measured data points for the units irradiated with all pins tied to ground. The black lines (solid or dashed) are the average of the data points after application of the KTL statistics on the sample irradiated in the biased condition while the shaded lines (solid or dashed) are the average of the data points after application of the KTL statistics on the sample irradiated in the unbiased condition. The red dotted line(s) are the pre- and/or post-irradiation minimum and/or maximum specification value as defined in the datasheet and/or test plan.



Table 5.6. Raw data for input bias current (inverting input) at  $V_S = \pm 5V$  versus total dose, including the statistical analysis, the specification and the status of the testing (pass/fail).

Negative Input Bias Current @ +/- 5V (A)	Total Dose (krad(Si))					24 Hr Anneal	168 Hr Anneal
	0	10	20	30	50		
Device							
386	6.72E-10	6.12E-10	7.42E-10	9.04E-10	1.01E-09	1.02E-09	9.25E-10
387	6.41E-10	5.76E-10	7.24E-10	6.97E-10	1.01E-09	1.04E-09	8.49E-10
388	5.70E-10	5.69E-10	6.48E-10	8.15E-10	7.80E-10	8.75E-10	7.80E-10
389	6.01E-10	5.65E-10	6.81E-10	8.10E-10	9.42E-10	9.62E-10	8.56E-10
390	5.52E-10	5.40E-10	6.91E-10	8.28E-10	9.80E-10	1.05E-09	8.67E-10
391	6.28E-10	5.33E-10	7.11E-10	7.11E-10	1.03E-09	1.00E-09	7.25E-10
392	6.63E-10	5.72E-10	7.35E-10	7.35E-10	1.07E-09	1.05E-09	7.84E-10
393	6.28E-10	5.36E-10	6.92E-10	6.92E-10	1.02E-09	1.03E-09	7.70E-10
394	6.32E-10	5.39E-10	6.95E-10	6.95E-10	1.00E-09	1.01E-09	7.80E-10
395	6.72E-10	5.92E-10	7.01E-10	7.01E-10	1.04E-09	1.03E-09	7.35E-10
396	6.36E-10	4.73E-10	4.73E-10	4.73E-10	4.70E-10	5.15E-10	4.70E-10
<b>Biased Statistics</b>							
Average Biased	6.07E-10	5.72E-10	6.97E-10	8.11E-10	9.44E-10	9.87E-10	8.55E-10
Std Dev Biased	4.95E-11	2.60E-11	3.69E-11	7.41E-11	9.57E-11	7.08E-11	5.17E-11
Ps90%/90% (+KTL) Biased	7.43E-10	6.44E-10	7.98E-10	1.01E-09	1.21E-09	1.18E-09	9.97E-10
Ps90%/90% (-KTL) Biased	4.71E-10	5.01E-10	5.96E-10	6.08E-10	6.82E-10	7.93E-10	7.14E-10
<b>Un-Biased Statistics</b>							
Average Un-Biased	6.45E-10	5.54E-10	7.07E-10	7.07E-10	1.03E-09	1.02E-09	7.59E-10
Std Dev Un-Biased	2.12E-11	2.63E-11	1.74E-11	1.74E-11	2.45E-11	1.83E-11	2.70E-11
Ps90%/90% (+KTL) Un-Biased	7.03E-10	6.26E-10	7.54E-10	7.54E-10	1.10E-09	1.07E-09	8.33E-10
Ps90%/90% (-KTL) Un-Biased	5.86E-10	4.82E-10	6.59E-10	6.59E-10	9.65E-10	9.74E-10	6.85E-10
<b>Specification MIN</b>	<b>-2.00E-09</b>	<b>-2.00E-09</b>	<b>-2.00E-09</b>	<b>-2.00E-09</b>	<b>-2.00E-09</b>	<b>-2.00E-09</b>	<b>-2.00E-09</b>
Status	PASS	PASS	PASS	PASS	PASS	PASS	PASS
<b>Specification MAX</b>	<b>2.00E-09</b>	<b>2.00E-09</b>	<b>2.00E-09</b>	<b>2.00E-09</b>	<b>2.00E-09</b>	<b>2.00E-09</b>	<b>2.00E-09</b>
Status	PASS	PASS	PASS	PASS	PASS	PASS	PASS

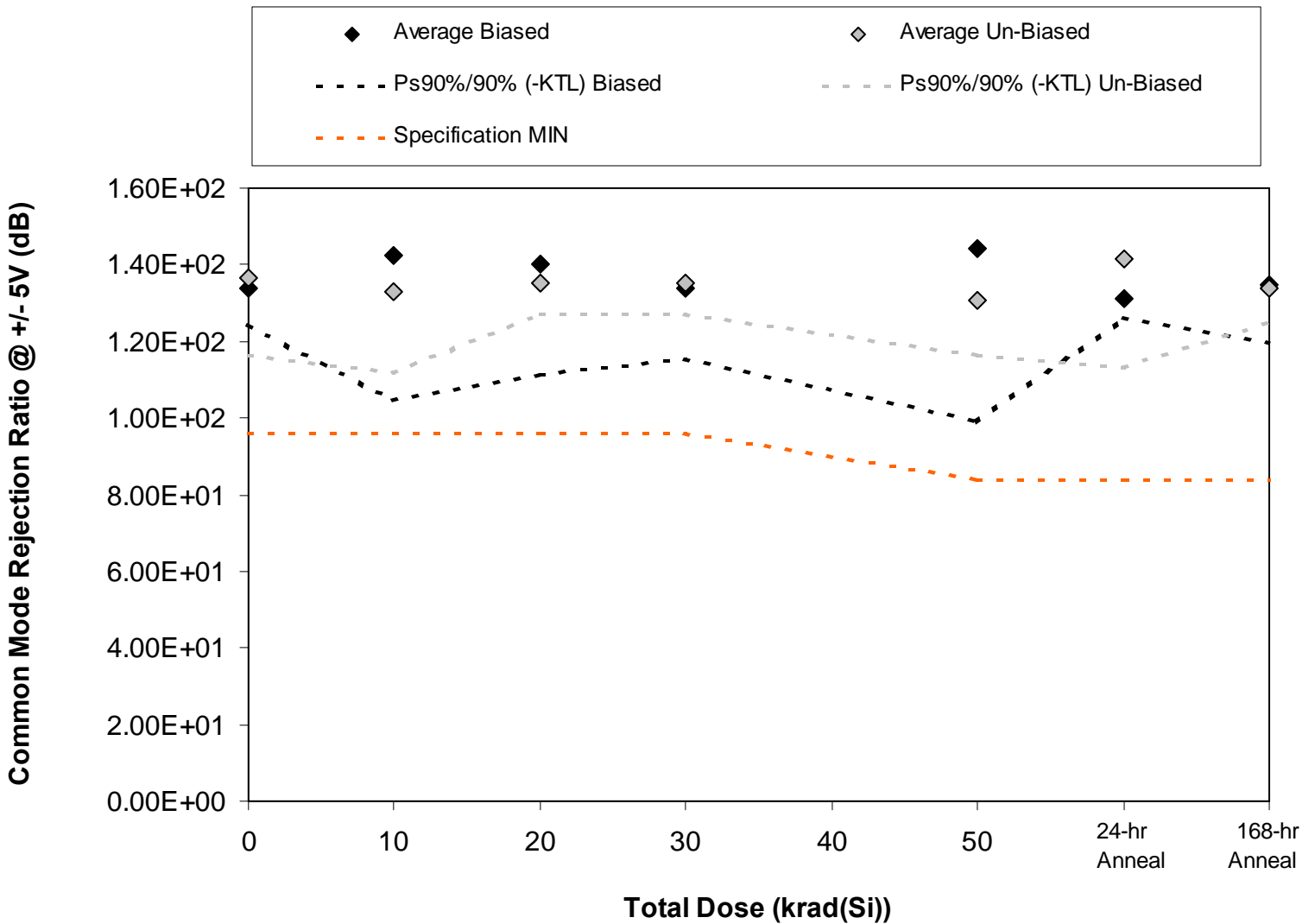

Figure 5.7. Plot of the common mode rejection ratio (CMRR) at  $V_S = \pm 5V$  versus total dose. The data show no significant degradation with total dose. The solid diamonds are the average of the measured data points for the sample irradiated under electrical bias while the shaded diamonds are the average of the measured data points for the units irradiated with all pins tied to ground. The black lines (solid or dashed) are the average of the data points after application of the KTL statistics on the sample irradiated in the biased condition while the shaded lines (solid or dashed) are the average of the data points after application of the KTL statistics on the sample irradiated in the unbiased condition. The red dotted line(s) are the pre- and/or post-irradiation minimum and/or maximum specification value as defined in the datasheet and/or test plan.



Table 5.7. Raw data of common mode rejection ratio (CMRR) at  $V_S=\pm 5V$  versus total dose, including the statistical analysis, the specification and the status of the testing (pass/fail).

Common Mode Rejection Ratio @ +/- 5V (dB)	Total Dose (krad(Si))					24 Hr Anneal	168 Hr Anneal
	0	10	20	30	50		
Device							
386	1.31E+02	1.31E+02	1.28E+02	1.27E+02	1.28E+02	1.33E+02	1.39E+02
387	1.40E+02	1.38E+02	1.31E+02	1.32E+02	1.42E+02	1.33E+02	1.38E+02
388	1.35E+02	1.65E+02	1.51E+02	1.45E+02	1.29E+02	1.31E+02	1.28E+02
389	1.34E+02	1.46E+02	1.49E+02	1.29E+02	1.61E+02	1.28E+02	1.40E+02
390	1.31E+02	1.33E+02	1.42E+02	1.36E+02	1.62E+02	1.31E+02	1.30E+02
391	1.40E+02	1.28E+02	1.36E+02	1.36E+02	1.37E+02	1.34E+02	1.38E+02
392	1.33E+02	1.31E+02	1.34E+02	1.34E+02	1.24E+02	1.60E+02	1.36E+02
393	1.48E+02	1.25E+02	1.31E+02	1.31E+02	1.27E+02	1.39E+02	1.31E+02
394	1.29E+02	1.45E+02	1.40E+02	1.40E+02	1.33E+02	1.36E+02	1.33E+02
395	1.32E+02	1.36E+02	1.34E+02	1.34E+02	1.31E+02	1.39E+02	1.31E+02
396	1.33E+02	1.35E+02	1.47E+02	1.47E+02	1.29E+02	1.39E+02	1.82E+02
<b>Biased Statistics</b>							
Average Biased	1.34E+02	1.43E+02	1.40E+02	1.34E+02	1.44E+02	1.31E+02	1.35E+02
Std Dev Biased	3.55E+00	1.39E+01	1.06E+01	6.83E+00	1.64E+01	1.88E+00	5.60E+00
Ps90%/90% (+KTL) Biased	1.44E+02	1.81E+02	1.69E+02	1.53E+02	1.89E+02	1.36E+02	1.50E+02
Ps90%/90% (-KTL) Biased	1.24E+02	1.05E+02	1.11E+02	1.15E+02	9.94E+01	1.26E+02	1.20E+02
<b>Un-Biased Statistics</b>							
Average Un-Biased	1.36E+02	1.33E+02	1.35E+02	1.35E+02	1.31E+02	1.42E+02	1.34E+02
Std Dev Un-Biased	7.41E+00	7.73E+00	3.02E+00	3.02E+00	5.28E+00	1.05E+01	3.26E+00
Ps90%/90% (+KTL) Un-Biased	1.57E+02	1.54E+02	1.43E+02	1.43E+02	1.45E+02	1.70E+02	1.43E+02
Ps90%/90% (-KTL) Un-Biased	1.16E+02	1.12E+02	1.27E+02	1.27E+02	1.16E+02	1.13E+02	1.25E+02
<b>Specification MIN</b>	<b>9.60E+01</b>	<b>9.60E+01</b>	<b>9.60E+01</b>	<b>9.60E+01</b>	<b>8.40E+01</b>	<b>8.40E+01</b>	<b>8.40E+01</b>
Status	PASS	PASS	PASS	PASS	PASS	PASS	PASS



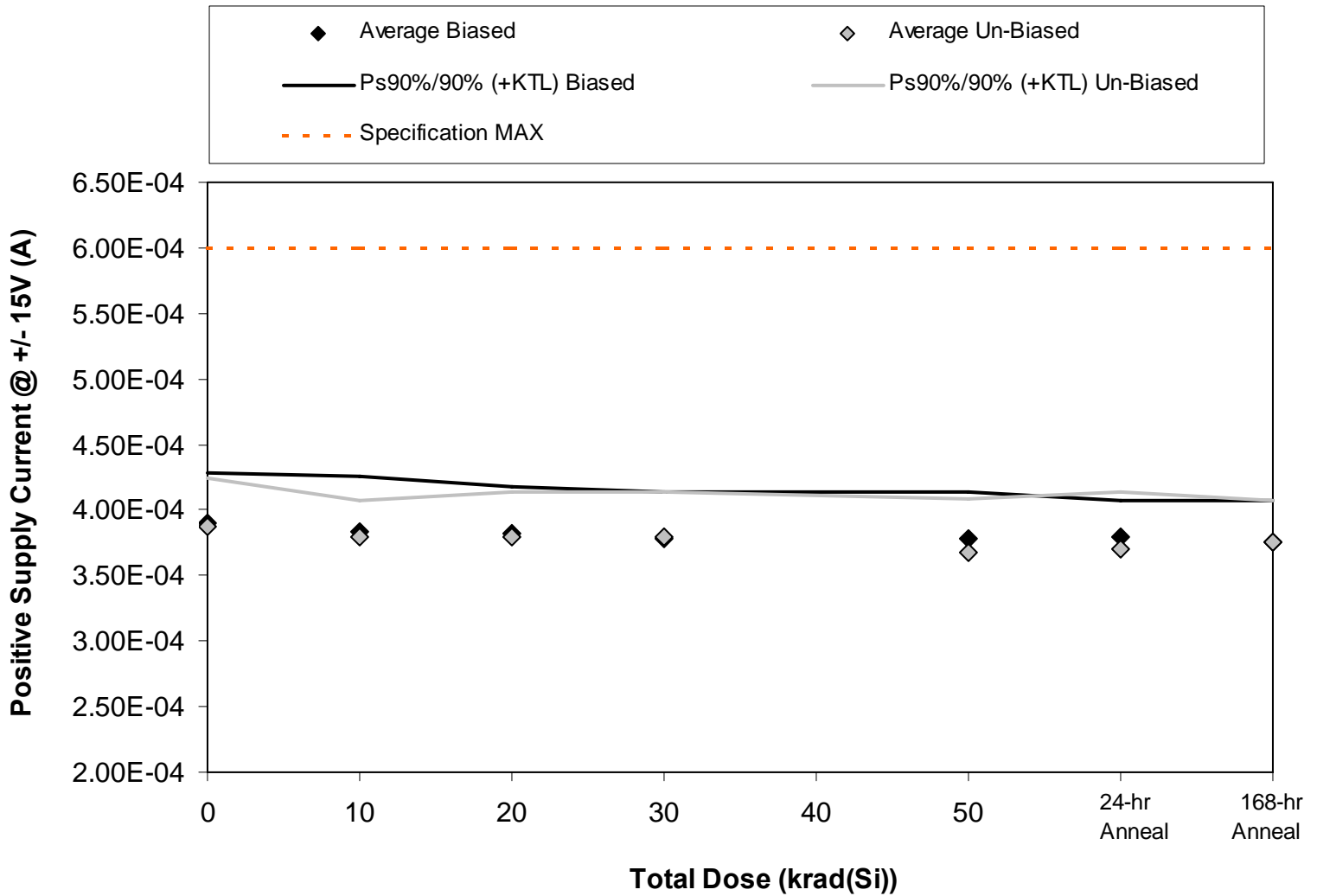

Figure 5.8. Plot of positive supply current at  $V_S = \pm 15V$  versus total dose. The data shows no significant degradation with dose. The solid diamonds are the average of the measured data points for the sample irradiated under electrical bias while the shaded diamonds are the average of the measured data points for the units irradiated with all pins tied to ground. The black lines (solid or dashed) are the average of the data points after application of the KTL statistics on the sample irradiated in the biased condition while the shaded lines (solid or dashed) are the average of the data points after application of the KTL statistics on the sample irradiated in the unbiased condition. The red dotted line(s) are the pre- and/or post-irradiation minimum and/or maximum specification value as defined in the datasheet and/or test plan.



Table 5.8. Raw data for the positive supply current at  $V_S = \pm 15V$  versus total dose, including the statistical analysis, specification and the status of the testing (pass/fail)

Positive Supply Current @ +/- 15V (A)	Total Dose (krad(Si))					24 Hr Anneal	168 Hr Anneal
	0	10	20	30	50		
Device 386	3.80E-04	3.70E-04	3.70E-04	3.60E-04	3.70E-04	3.70E-04	3.60E-04
387	3.80E-04	3.70E-04	3.70E-04	3.90E-04	3.60E-04	3.70E-04	3.80E-04
388	4.10E-04	4.00E-04	4.00E-04	3.70E-04	3.80E-04	3.90E-04	3.90E-04
389	3.80E-04	3.80E-04	3.80E-04	3.80E-04	3.90E-04	3.80E-04	3.70E-04
390	4.00E-04	4.00E-04	3.90E-04	3.90E-04	3.90E-04	3.90E-04	3.80E-04
391	3.80E-04	3.70E-04	3.80E-04	3.80E-04	3.60E-04	3.60E-04	3.70E-04
392	3.80E-04	3.80E-04	3.80E-04	3.80E-04	3.70E-04	3.70E-04	3.80E-04
393	4.10E-04	3.90E-04	3.90E-04	3.90E-04	3.90E-04	3.90E-04	3.90E-04
394	3.90E-04	3.90E-04	3.90E-04	3.90E-04	3.70E-04	3.80E-04	3.80E-04
395	3.80E-04	3.70E-04	3.60E-04	3.60E-04	3.50E-04	3.50E-04	3.60E-04
396	3.80E-04	3.80E-04	3.80E-04	3.80E-04	3.70E-04	3.80E-04	3.80E-04
<b>Biased Statistics</b>							
Average Biased	3.90E-04	3.84E-04	3.82E-04	3.78E-04	3.78E-04	3.80E-04	3.76E-04
Std Dev Biased	1.41E-05	1.52E-05	1.30E-05	1.30E-05	1.30E-05	1.00E-05	1.14E-05
Ps90%/90% (+KTL) Biased	4.29E-04	4.26E-04	4.18E-04	4.14E-04	4.14E-04	4.07E-04	4.07E-04
Ps90%/90% (-KTL) Biased	3.51E-04	3.42E-04	3.46E-04	3.42E-04	3.42E-04	3.53E-04	3.45E-04
<b>Un-Biased Statistics</b>							
Average Un-Biased	3.88E-04	3.80E-04	3.80E-04	3.80E-04	3.68E-04	3.70E-04	3.76E-04
Std Dev Un-Biased	1.30E-05	1.00E-05	1.22E-05	1.22E-05	1.48E-05	1.58E-05	1.14E-05
Ps90%/90% (+KTL) Un-Biased	4.24E-04	4.07E-04	4.14E-04	4.14E-04	4.09E-04	4.13E-04	4.07E-04
Ps90%/90% (-KTL) Un-Biased	3.52E-04	3.53E-04	3.46E-04	3.46E-04	3.27E-04	3.27E-04	3.45E-04
<b>Specification MAX</b>	<b>6.00E-04</b>	<b>6.00E-04</b>	<b>6.00E-04</b>	<b>6.00E-04</b>	<b>6.00E-04</b>	<b>6.00E-04</b>	<b>6.00E-04</b>
Status	PASS	PASS	PASS	PASS	PASS	PASS	PASS

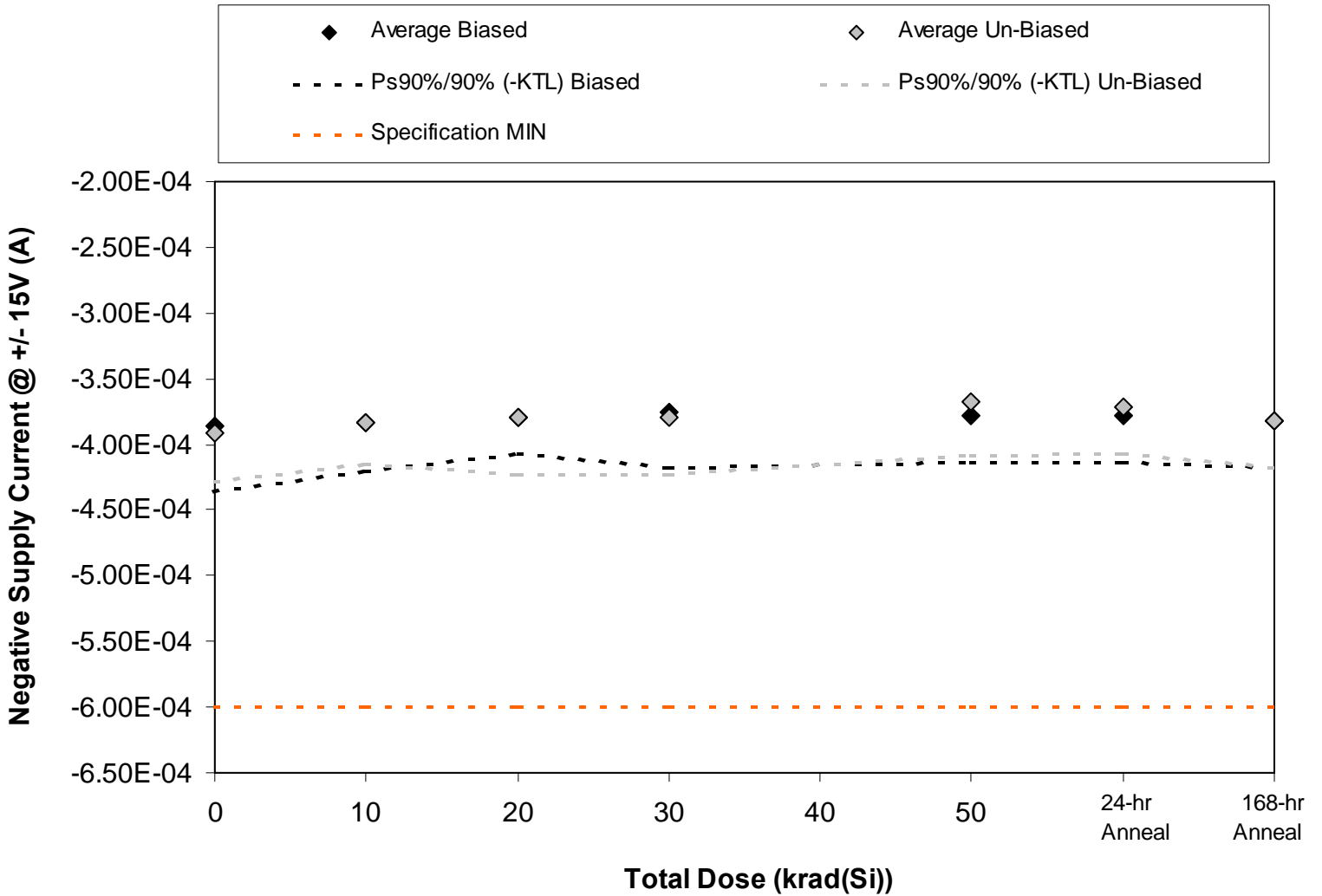

Figure 5.9. Plot of negative supply current at  $V_S = \pm 15V$  versus total dose. The data shows no significant degradation with dose. The solid diamonds are the average of the measured data points for the sample irradiated under electrical bias while the shaded diamonds are the average of the measured data points for the units irradiated with all pins tied to ground. The black lines (solid or dashed) are the average of the data points after application of the KTL statistics on the sample irradiated in the biased condition while the shaded lines (solid or dashed) are the average of the data points after application of the KTL statistics on the sample irradiated in the unbiased condition. The red dotted line(s) are the pre- and/or post-irradiation minimum and/or maximum specification value as defined in the datasheet and/or test plan.



Table 5.9. Raw data for the negative supply current at  $V_S = \pm 15V$  versus total dose, including the statistical analysis, the specification and the status of the testing (pass/fail).

Negative Supply Current @ +/- 15V (A)	Total Dose (krad(Si))					24 Hr Anneal	168 Hr Anneal
	0	10	20	30	50		
Device							
386	-3.70E-04	-3.70E-04	-3.70E-04	-3.60E-04	-3.70E-04	-3.60E-04	-3.70E-04
387	-3.70E-04	-3.70E-04	-3.80E-04	-3.90E-04	-3.60E-04	-3.70E-04	-3.70E-04
388	-4.10E-04	-3.90E-04	-3.90E-04	-3.60E-04	-3.90E-04	-3.90E-04	-4.00E-04
389	-3.80E-04	-3.90E-04	-3.70E-04	-3.80E-04	-3.80E-04	-3.80E-04	-3.80E-04
390	-4.00E-04	-4.00E-04	-3.90E-04	-3.90E-04	-3.90E-04	-3.90E-04	-3.90E-04
391	-3.80E-04	-3.80E-04	-3.70E-04	-3.70E-04	-3.60E-04	-3.60E-04	-3.70E-04
392	-3.90E-04	-3.80E-04	-3.80E-04	-3.80E-04	-3.70E-04	-3.70E-04	-3.80E-04
393	-4.10E-04	-4.00E-04	-4.00E-04	-4.00E-04	-3.90E-04	-3.90E-04	-4.00E-04
394	-4.00E-04	-3.90E-04	-3.90E-04	-3.90E-04	-3.70E-04	-3.80E-04	-3.90E-04
395	-3.80E-04	-3.70E-04	-3.60E-04	-3.60E-04	-3.50E-04	-3.60E-04	-3.70E-04
396	-3.80E-04	-3.70E-04	-3.70E-04	-3.70E-04	-3.80E-04	-3.80E-04	-3.80E-04
<b>Biased Statistics</b>							
Average Biased	-3.86E-04	-3.84E-04	-3.80E-04	-3.76E-04	-3.78E-04	-3.78E-04	-3.82E-04
Std Dev Biased	1.82E-05	1.34E-05	1.00E-05	1.52E-05	1.30E-05	1.30E-05	1.30E-05
Ps90%/90% (+KTL) Biased	-3.36E-04	-3.47E-04	-3.53E-04	-3.34E-04	-3.42E-04	-3.42E-04	-3.46E-04
Ps90%/90% (-KTL) Biased	-4.36E-04	-4.21E-04	-4.07E-04	-4.18E-04	-4.14E-04	-4.14E-04	-4.18E-04
<b>Un-Biased Statistics</b>							
Average Un-Biased	-3.92E-04	-3.84E-04	-3.80E-04	-3.80E-04	-3.68E-04	-3.72E-04	-3.82E-04
Std Dev Un-Biased	1.30E-05	1.14E-05	1.58E-05	1.58E-05	1.48E-05	1.30E-05	1.30E-05
Ps90%/90% (+KTL) Un-Biased	-3.56E-04	-3.53E-04	-3.37E-04	-3.37E-04	-3.27E-04	-3.36E-04	-3.46E-04
Ps90%/90% (-KTL) Un-Biased	-4.28E-04	-4.15E-04	-4.23E-04	-4.23E-04	-4.09E-04	-4.08E-04	-4.18E-04
<b>Specification MIN</b>	<b>-6.00E-04</b>	<b>-6.00E-04</b>	<b>-6.00E-04</b>	<b>-6.00E-04</b>	<b>-6.00E-04</b>	<b>-6.00E-04</b>	<b>-6.00E-04</b>
Status	PASS	PASS	PASS	PASS	PASS	PASS	PASS

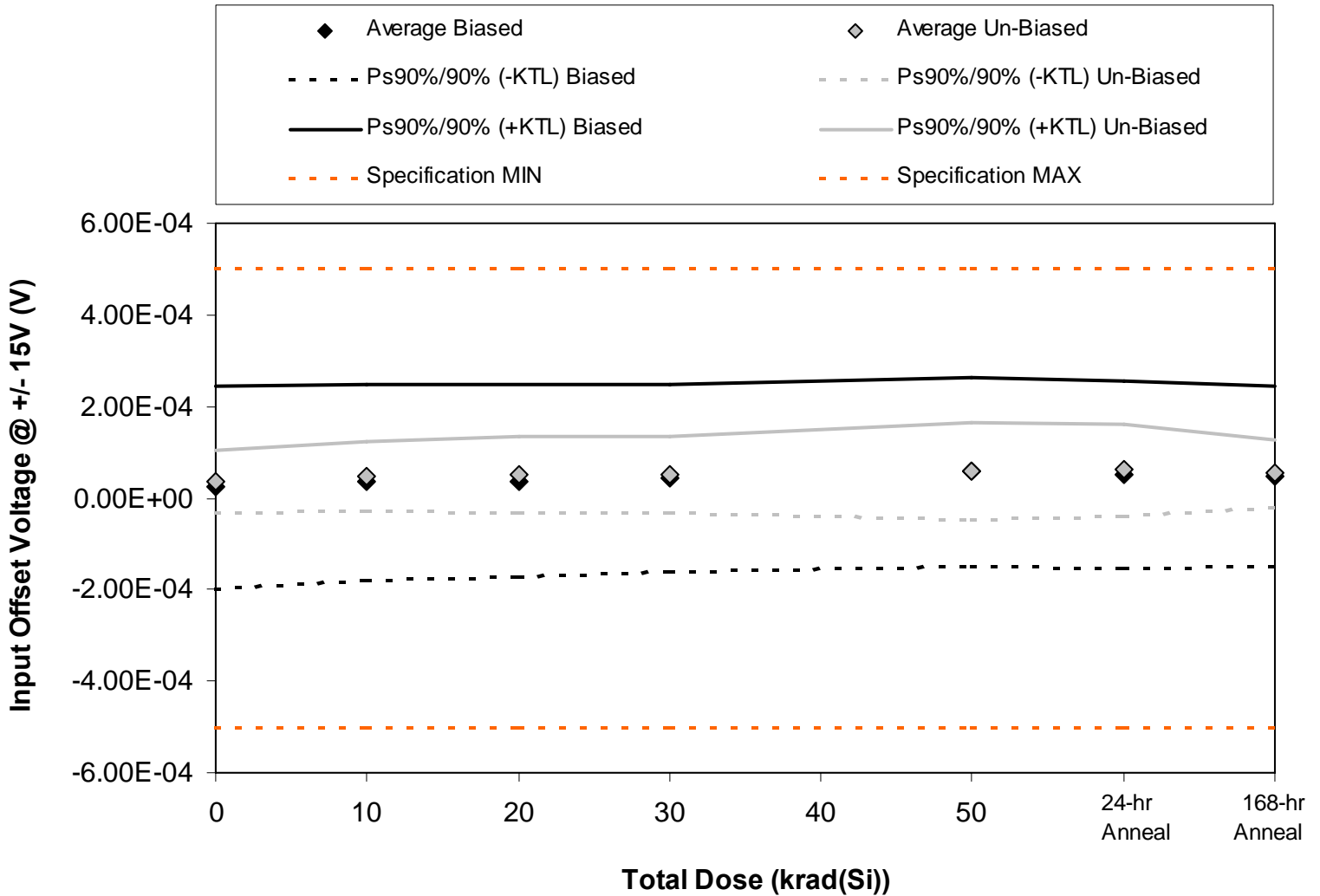

Figure 5.10. Plot of input offset voltage at  $V_S = \pm 15V$  versus total dose. The data shows no significant degradation with dose. The solid diamonds are the average of the measured data points for the sample irradiated under electrical bias while the shaded diamonds are the average of the measured data points for the units irradiated with all pins tied to ground. The black lines (solid or dashed) are the average of the data points after application of the KTL statistics on the sample irradiated in the biased condition while the shaded lines (solid or dashed) are the average of the data points after application of the KTL statistics on the sample irradiated in the unbiased condition. The red dotted line(s) are the pre- and/or post-irradiation minimum and/or maximum specification value as defined in the datasheet and/or test plan.



Table 5.10. Raw data for the input offset voltage at  $V_S = \pm 15V$  versus total dose, including the statistical analysis, the specification and the status of the testing (pass/fail).

Input Offset Voltage @ +/- 15V (V)	Total Dose (krad(Si))					24 Hr Anneal	168 Hr Anneal
	0	10	20	30	50		
Device							
386	-9.80E-05	-8.20E-05	-7.30E-05	-6.40E-05	-4.90E-05	-5.50E-05	-5.60E-05
387	5.30E-05	6.30E-05	6.70E-05	4.10E-05	8.40E-05	7.90E-05	7.40E-05
388	3.60E-05	4.60E-05	4.20E-05	7.10E-05	5.10E-05	4.70E-05	5.30E-05
389	2.00E-06	1.30E-05	1.40E-05	2.70E-05	4.10E-05	3.10E-05	2.10E-05
390	1.21E-04	1.31E-04	1.38E-04	1.42E-04	1.58E-04	1.51E-04	1.40E-04
391	2.80E-05	2.80E-05	2.30E-05	2.30E-05	1.10E-05	1.90E-05	4.00E-05
392	-3.00E-06	9.00E-06	1.30E-05	1.30E-05	2.40E-05	2.60E-05	1.30E-05
393	4.30E-05	5.50E-05	6.20E-05	6.20E-05	7.50E-05	7.80E-05	6.20E-05
394	6.00E-05	7.40E-05	7.80E-05	7.80E-05	9.10E-05	9.20E-05	7.70E-05
395	5.40E-05	7.10E-05	7.50E-05	7.50E-05	9.40E-05	9.40E-05	7.30E-05
396	4.80E-05	5.90E-05	5.60E-05	5.60E-05	5.50E-05	5.40E-05	4.60E-05
<b>Biased Statistics</b>							
Average Biased	2.28E-05	3.42E-05	3.76E-05	4.34E-05	5.70E-05	5.06E-05	4.64E-05
Std Dev Biased	8.02E-05	7.79E-05	7.71E-05	7.47E-05	7.49E-05	7.49E-05	7.19E-05
Ps90%/90% (+KTL) Biased	2.43E-04	2.48E-04	2.49E-04	2.48E-04	2.62E-04	2.56E-04	2.44E-04
Ps90%/90% (-KTL) Biased	-1.97E-04	-1.79E-04	-1.74E-04	-1.61E-04	-1.48E-04	-1.55E-04	-1.51E-04
<b>Un-Biased Statistics</b>							
Average Un-Biased	3.64E-05	4.74E-05	5.02E-05	5.02E-05	5.90E-05	6.18E-05	5.30E-05
Std Dev Un-Biased	2.52E-05	2.82E-05	3.02E-05	3.02E-05	3.88E-05	3.65E-05	2.66E-05
Ps90%/90% (+KTL) Un-Biased	1.05E-04	1.25E-04	1.33E-04	1.33E-04	1.65E-04	1.62E-04	1.26E-04
Ps90%/90% (-KTL) Un-Biased	-3.26E-05	-2.98E-05	-3.26E-05	-3.26E-05	-4.75E-05	-3.82E-05	-1.99E-05
<b>Specification MIN</b>	<b>-5.00E-04</b>	<b>-5.00E-04</b>	<b>-5.00E-04</b>	<b>-5.00E-04</b>	<b>-5.00E-04</b>	<b>-5.00E-04</b>	<b>-5.00E-04</b>
Status	PASS	PASS	PASS	PASS	PASS	PASS	PASS
<b>Specification MAX</b>	<b>5.00E-04</b>	<b>5.00E-04</b>	<b>5.00E-04</b>	<b>5.00E-04</b>	<b>5.00E-04</b>	<b>5.00E-04</b>	<b>5.00E-04</b>
Status	PASS	PASS	PASS	PASS	PASS	PASS	PASS



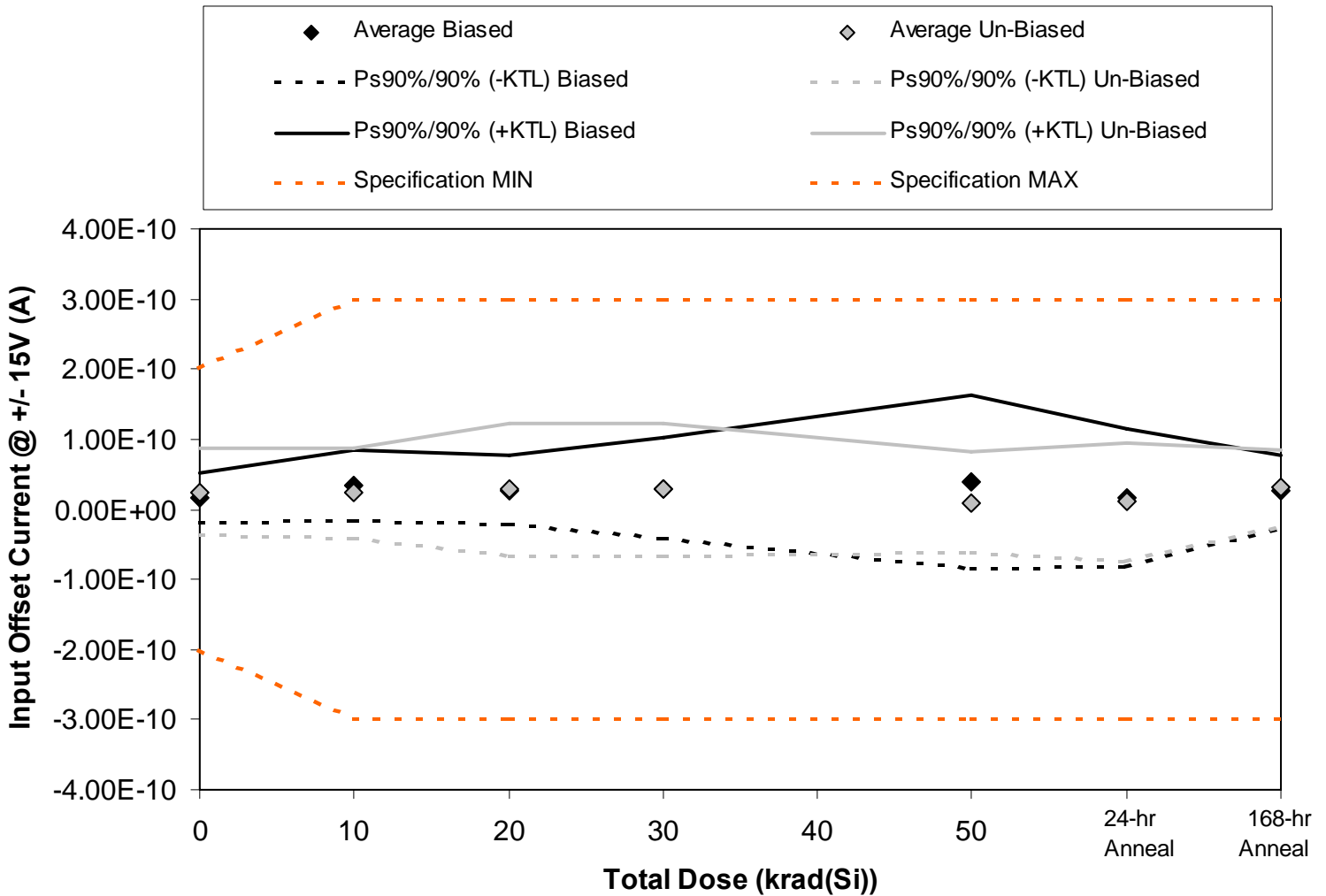

Figure 5.11. Plot of input offset current at  $V_S = \pm 15V$  versus total dose. The data no significant increase with dose. The solid diamonds are the average of the measured data points for the sample irradiated under electrical bias while the shaded diamonds are the average of the measured data points for the units irradiated with all pins tied to ground. The black lines (solid or dashed) are the average of the data points after application of the KTL statistics on the sample irradiated in the biased condition while the shaded lines (solid or dashed) are the average of the data points after application of the KTL statistics on the sample irradiated in the unbiased condition. The red dotted line(s) are the pre- and/or post-irradiation minimum and/or maximum specification value as defined in the datasheet and/or test plan.



Table 5.11. Raw data for input offset current at  $V_S = \pm 15V$  versus total dose, including the statistical analysis, the specification and the status of the testing (pass/fail).

Input Offset Current @ +/- 15V (A)	Total Dose (krad(Si))					24 Hr Anneal	168 Hr Anneal
	0	10	20	30	50		
Device							
386	9.00E-12	3.60E-11	2.20E-11	-4.00E-12	-2.80E-11	-1.40E-11	-3.00E-12
387	0.00E+00	5.80E-11	1.80E-11	3.10E-11	2.10E-11	-7.00E-12	4.80E-11
388	1.80E-11	7.00E-12	7.00E-12	1.40E-11	4.10E-11	3.20E-11	2.80E-11
389	2.70E-11	3.20E-11	5.40E-11	4.30E-11	9.00E-11	7.20E-11	3.50E-11
390	3.10E-11	4.00E-11	3.60E-11	6.50E-11	6.60E-11	-4.00E-12	2.10E-11
391	5.30E-11	5.30E-11	3.80E-11	3.80E-11	1.30E-11	1.40E-11	7.00E-12
392	3.60E-11	4.30E-11	8.30E-11	8.30E-11	5.30E-11	5.80E-11	5.50E-11
393	4.00E-12	0.00E+00	-7.00E-12	-7.00E-12	-1.30E-11	-2.20E-11	1.70E-11
394	0.00E+00	1.30E-11	1.00E-11	1.00E-11	0.00E+00	-1.10E-11	4.50E-11
395	3.10E-11	7.00E-12	1.70E-11	1.70E-11	-7.00E-12	1.40E-11	2.80E-11
396	-1.30E-11	-1.00E-11	-1.00E-11	-1.00E-11	-1.30E-11	-1.80E-11	-1.30E-11
<b>Biased Statistics</b>							
Average Biased	1.70E-11	3.46E-11	2.74E-11	2.98E-11	3.80E-11	1.58E-11	2.58E-11
Std Dev Biased	1.27E-11	1.84E-11	1.81E-11	2.65E-11	4.51E-11	3.61E-11	1.89E-11
Ps90%/90% (+KTL) Biased	5.20E-11	8.49E-11	7.71E-11	1.02E-10	1.62E-10	1.15E-10	7.77E-11
Ps90%/90% (-KTL) Biased	-1.80E-11	-1.57E-11	-2.23E-11	-4.28E-11	-8.57E-11	-8.33E-11	-2.61E-11
<b>Un-Biased Statistics</b>							
Average Un-Biased	2.48E-11	2.32E-11	2.82E-11	2.82E-11	9.20E-12	1.06E-11	3.04E-11
Std Dev Un-Biased	2.24E-11	2.34E-11	3.46E-11	3.46E-11	2.63E-11	3.08E-11	1.97E-11
Ps90%/90% (+KTL) Un-Biased	8.62E-11	8.73E-11	1.23E-10	1.23E-10	8.14E-11	9.51E-11	8.44E-11
Ps90%/90% (-KTL) Un-Biased	-3.66E-11	-4.09E-11	-6.67E-11	-6.67E-11	-6.30E-11	-7.39E-11	-2.36E-11
<b>Specification MIN</b>	<b>-2.00E-10</b>	<b>-3.00E-10</b>	<b>-3.00E-10</b>	<b>-3.00E-10</b>	<b>-3.00E-10</b>	<b>-3.00E-10</b>	<b>-3.00E-10</b>
Status	PASS	PASS	PASS	PASS	PASS	PASS	PASS
<b>Specification MAX</b>	<b>2.00E-10</b>	<b>3.00E-10</b>	<b>3.00E-10</b>	<b>3.00E-10</b>	<b>3.00E-10</b>	<b>3.00E-10</b>	<b>3.00E-10</b>
Status	PASS	PASS	PASS	PASS	PASS	PASS	PASS

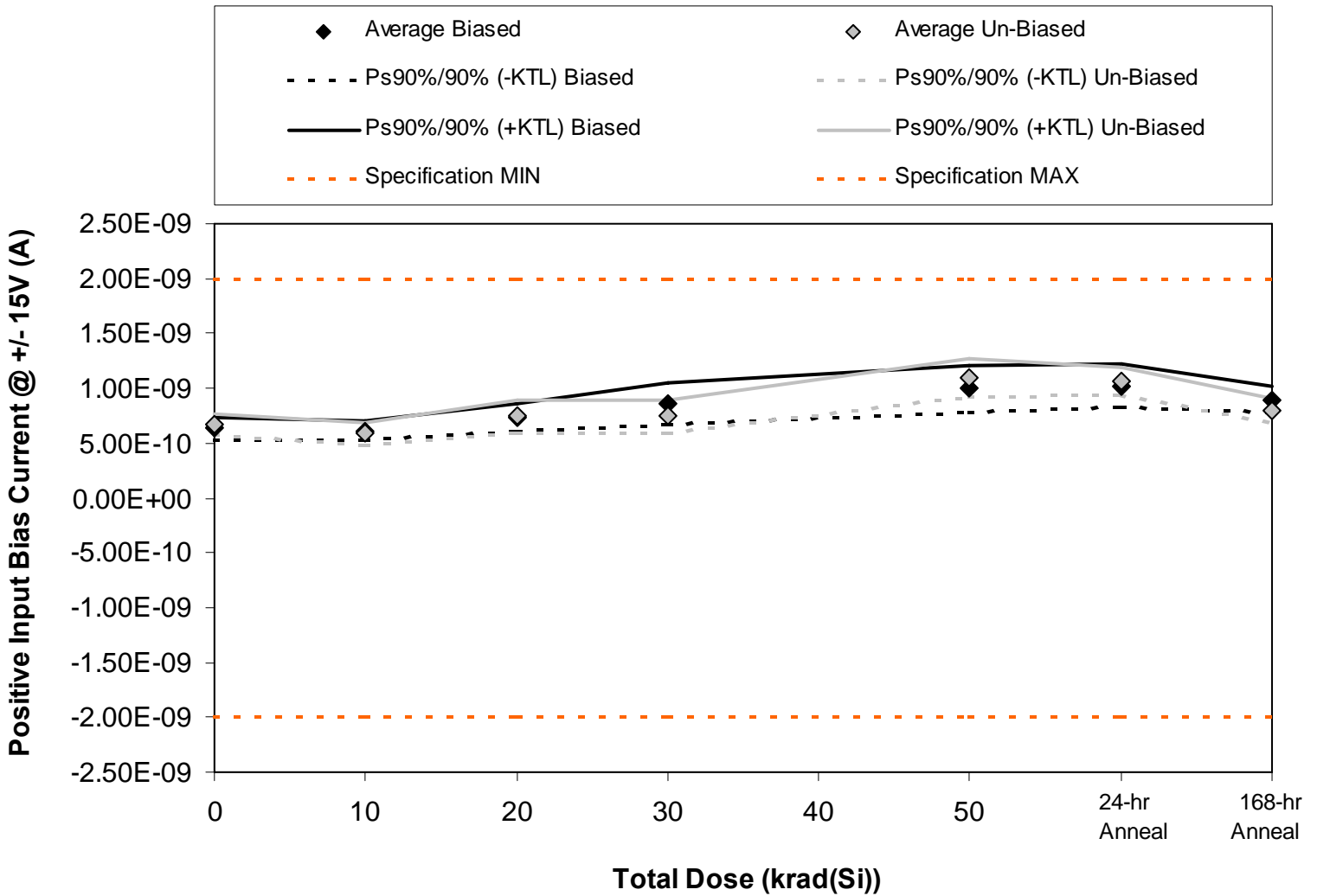

Figure 5.12. Plot of input bias current (non-inverting input) at  $V_S = \pm 15V$  versus total dose. The data shows no significant degradation with dose. The solid diamonds are the average of the measured data points for the sample irradiated under electrical bias while the shaded diamonds are the average of the measured data points for the units irradiated with all pins tied to ground. The black lines (solid or dashed) are the average of the data points after application of the KTL statistics on the sample irradiated in the biased condition while the shaded lines (solid or dashed) are the average of the data points after application of the KTL statistics on the sample irradiated in the unbiased condition. The red dotted line(s) are the pre- and/or post-irradiation minimum and/or maximum specification value as defined in the datasheet and/or test plan.



Table 5.12. Raw data for input bias current (non-inverting input) at  $V_S = \pm 15V$  versus total dose, including the statistical analysis, the specification and the status of the testing (pass/fail).

Positive Input Bias Current @ +/- 15V (A)	Total Dose (krad(Si))					24 Hr Anneal	168 Hr Anneal
	0	10	20	30	50		
Device							
386	6.81E-10	6.52E-10	7.78E-10	9.22E-10	1.03E-09	1.06E-09	9.39E-10
387	6.50E-10	6.48E-10	7.42E-10	7.46E-10	1.06E-09	1.01E-09	9.11E-10
388	5.96E-10	5.87E-10	6.55E-10	8.42E-10	8.60E-10	9.33E-10	8.29E-10
389	6.36E-10	5.98E-10	7.45E-10	8.72E-10	1.03E-09	1.01E-09	9.11E-10
390	5.92E-10	5.87E-10	7.31E-10	9.00E-10	1.00E-09	1.12E-09	9.04E-10
391	6.81E-10	5.89E-10	7.63E-10	7.63E-10	1.07E-09	1.07E-09	7.35E-10
392	6.99E-10	6.22E-10	8.25E-10	8.25E-10	1.20E-09	1.15E-09	8.39E-10
393	6.36E-10	5.43E-10	6.85E-10	6.85E-10	1.07E-09	1.04E-09	8.01E-10
394	6.36E-10	5.53E-10	7.08E-10	7.08E-10	1.03E-09	1.04E-09	8.25E-10
395	7.08E-10	6.15E-10	7.35E-10	7.35E-10	1.10E-09	1.06E-09	7.71E-10
396	6.28E-10	4.67E-10	4.67E-10	4.67E-10	4.63E-10	5.08E-10	4.60E-10
<b>Biased Statistics</b>							
Average Biased	6.31E-10	6.14E-10	7.30E-10	8.56E-10	9.97E-10	1.03E-09	8.99E-10
Std Dev Biased	3.75E-11	3.28E-11	4.55E-11	6.86E-11	7.93E-11	7.03E-11	4.13E-11
Ps90%/90% (+KTL) Biased	7.34E-10	7.04E-10	8.55E-10	1.04E-09	1.21E-09	1.22E-09	1.01E-09
Ps90%/90% (-KTL) Biased	5.28E-10	5.24E-10	6.05E-10	6.68E-10	7.79E-10	8.32E-10	7.86E-10
<b>Un-Biased Statistics</b>							
Average Un-Biased	6.72E-10	5.84E-10	7.43E-10	7.43E-10	1.10E-09	1.07E-09	7.94E-10
Std Dev Un-Biased	3.43E-11	3.56E-11	5.43E-11	5.43E-11	6.30E-11	4.48E-11	4.20E-11
Ps90%/90% (+KTL) Un-Biased	7.66E-10	6.82E-10	8.92E-10	8.92E-10	1.27E-09	1.19E-09	9.09E-10
Ps90%/90% (-KTL) Un-Biased	5.78E-10	4.87E-10	5.94E-10	5.94E-10	9.22E-10	9.46E-10	6.79E-10
<b>Specification MIN</b>	<b>-2.00E-09</b>	<b>-2.00E-09</b>	<b>-2.00E-09</b>	<b>-2.00E-09</b>	<b>-2.00E-09</b>	<b>-2.00E-09</b>	<b>-2.00E-09</b>
Status	PASS	PASS	PASS	PASS	PASS	PASS	PASS
<b>Specification MAX</b>	<b>2.00E-09</b>	<b>2.00E-09</b>	<b>2.00E-09</b>	<b>2.00E-09</b>	<b>2.00E-09</b>	<b>2.00E-09</b>	<b>2.00E-09</b>
Status	PASS	PASS	PASS	PASS	PASS	PASS	PASS

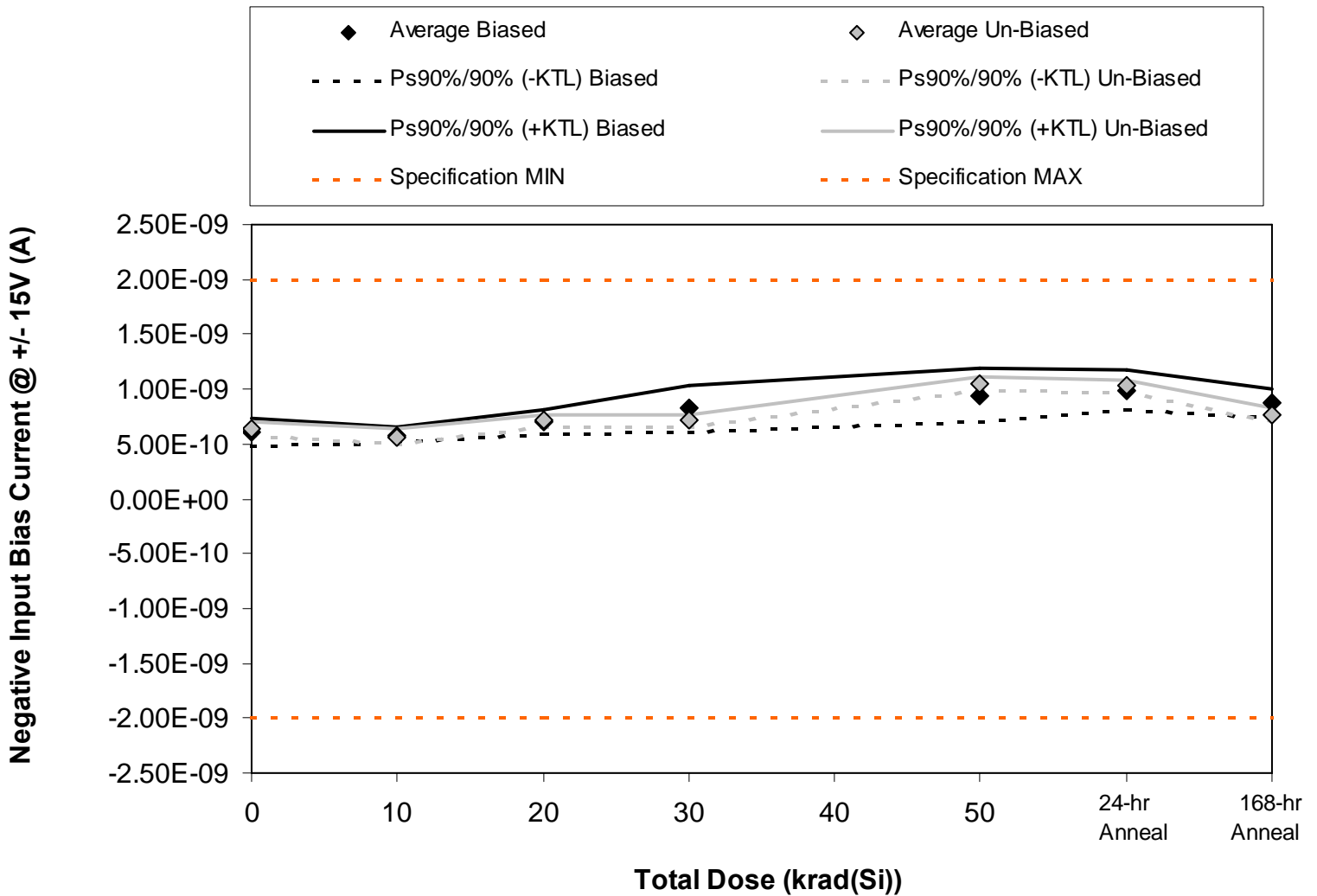

Figure 5.13. Plot of input bias current (inverting input) at  $V_S = \pm 15V$  versus total dose. The data shows no significant degradation with dose. The solid diamonds are the average of the measured data points for the sample irradiated under electrical bias while the shaded diamonds are the average of the measured data points for the units irradiated with all pins tied to ground. The black lines (solid or dashed) are the average of the data points after application of the KTL statistics on the sample irradiated in the biased condition while the shaded lines (solid or dashed) are the average of the data points after application of the KTL statistics on the sample irradiated in the unbiased condition. The red dotted line(s) are the pre- and/or post-irradiation minimum and/or maximum specification value as defined in the datasheet and/or test plan.



Table 5.13. Raw data for input bias current (inverting input) at  $V_S = \pm 15V$  versus total dose, including the statistical analysis, the specification and the status of the testing (pass/fail).

Negative Input Bias Current @ +/- 15V (A)	Total Dose (krad(Si))					24 Hr Anneal	168 Hr Anneal
	0	10	20	30	50		
Device							
386	6.72E-10	6.16E-10	7.53E-10	9.26E-10	1.02E-09	1.02E-09	9.39E-10
387	6.41E-10	5.87E-10	7.35E-10	7.08E-10	1.02E-09	1.01E-09	8.60E-10
388	5.79E-10	5.76E-10	6.52E-10	8.35E-10	8.04E-10	8.90E-10	8.01E-10
389	6.05E-10	5.69E-10	6.88E-10	8.25E-10	9.49E-10	9.76E-10	8.73E-10
390	5.61E-10	5.47E-10	6.95E-10	8.39E-10	9.39E-10	1.07E-09	8.84E-10
391	6.28E-10	5.43E-10	7.18E-10	7.18E-10	1.04E-09	1.00E-09	7.32E-10
392	6.59E-10	5.82E-10	7.42E-10	7.42E-10	1.09E-09	1.05E-09	7.84E-10
393	6.23E-10	5.49E-10	6.88E-10	6.88E-10	1.04E-09	1.04E-09	7.80E-10
394	6.32E-10	5.43E-10	7.28E-10	7.28E-10	1.03E-09	1.03E-09	7.77E-10
395	6.77E-10	6.02E-10	7.11E-10	7.11E-10	1.04E-09	1.02E-09	7.41E-10
396	6.36E-10	4.76E-10	4.76E-10	4.76E-10	4.73E-10	5.19E-10	4.73E-10
<b>Biased Statistics</b>							
Average Biased	6.12E-10	5.79E-10	7.05E-10	8.27E-10	9.46E-10	9.93E-10	8.71E-10
Std Dev Biased	4.52E-11	2.53E-11	4.00E-11	7.77E-11	8.77E-11	6.59E-11	4.95E-11
Ps90%/90% (+KTL) Biased	7.36E-10	6.48E-10	8.14E-10	1.04E-09	1.19E-09	1.17E-09	1.01E-09
Ps90%/90% (-KTL) Biased	4.88E-10	5.10E-10	5.95E-10	6.13E-10	7.05E-10	8.12E-10	7.36E-10
<b>Un-Biased Statistics</b>							
Average Un-Biased	6.44E-10	5.64E-10	7.17E-10	7.17E-10	1.05E-09	1.03E-09	7.63E-10
Std Dev Un-Biased	2.32E-11	2.68E-11	2.01E-11	2.01E-11	2.32E-11	1.77E-11	2.43E-11
Ps90%/90% (+KTL) Un-Biased	7.07E-10	6.37E-10	7.73E-10	7.73E-10	1.11E-09	1.07E-09	8.30E-10
Ps90%/90% (-KTL) Un-Biased	5.80E-10	4.90E-10	6.62E-10	6.62E-10	9.84E-10	9.78E-10	6.96E-10
<b>Specification MIN</b>	<b>-2.00E-09</b>	<b>-2.00E-09</b>	<b>-2.00E-09</b>	<b>-2.00E-09</b>	<b>-2.00E-09</b>	<b>-2.00E-09</b>	<b>-2.00E-09</b>
Status	PASS	PASS	PASS	PASS	PASS	PASS	PASS
<b>Specification MAX</b>	<b>2.00E-09</b>	<b>2.00E-09</b>	<b>2.00E-09</b>	<b>2.00E-09</b>	<b>2.00E-09</b>	<b>2.00E-09</b>	<b>2.00E-09</b>
Status	PASS	PASS	PASS	PASS	PASS	PASS	PASS

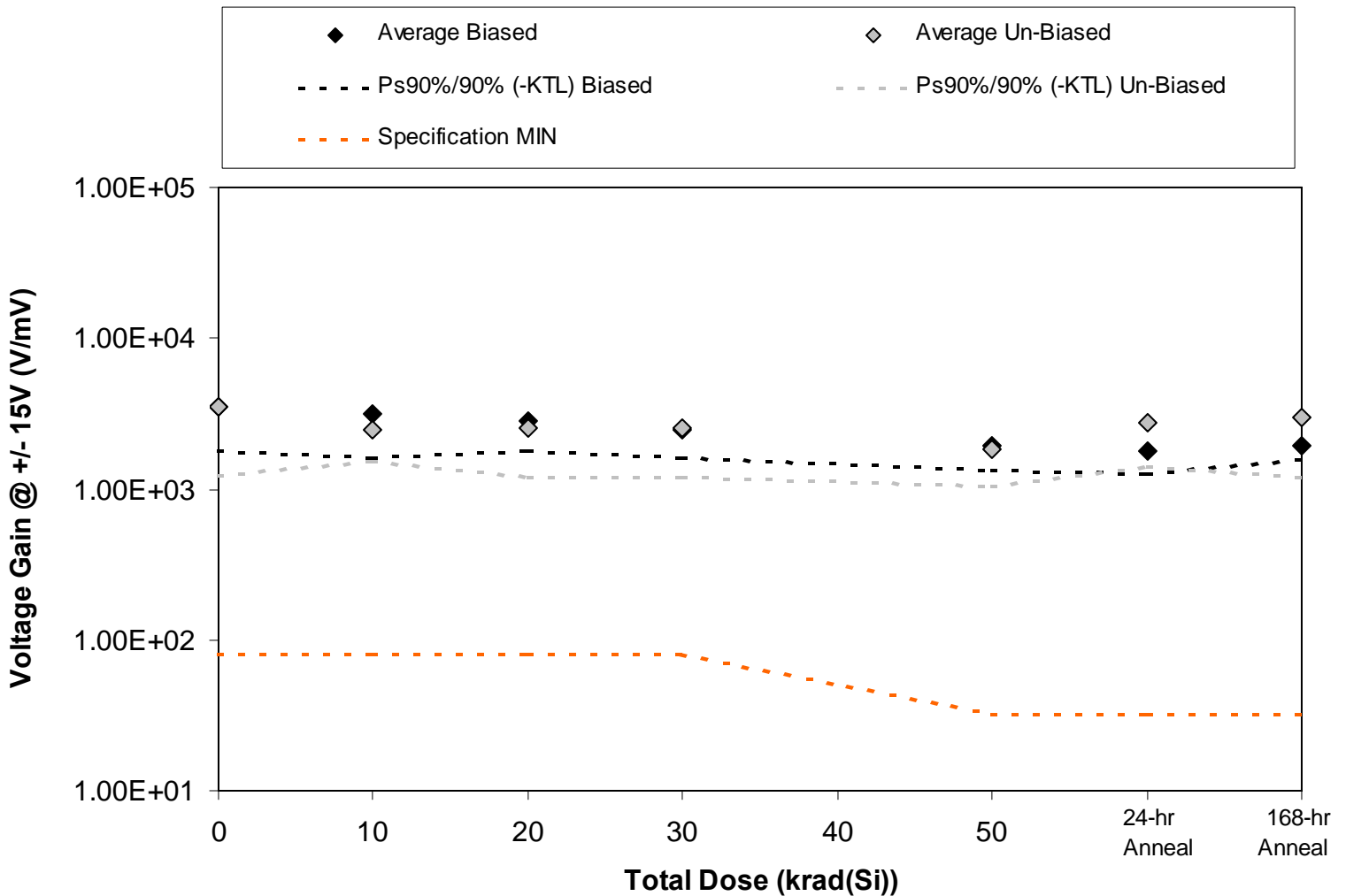

Figure 5.14. Plot of large signal voltage gain (AVOL) at  $V_S = \pm 15V$  versus total dose. The units irradiated under bias show a small decrease with total dose, however not sufficient to cause the data to fall below specification (even after application of the KTL statistics). The solid diamonds are the average of the measured data points for the sample irradiated under electrical bias while the shaded diamonds are the average of the measured data points for the units irradiated with all pins tied to ground. The black lines (solid or dashed) are the average of the data points after application of the KTL statistics on the sample irradiated in the biased condition while the shaded lines (solid or dashed) are the average of the data points after application of the KTL statistics on the sample irradiated in the unbiased condition. The red dotted line(s) are the pre- and/or post-irradiation minimum and/or maximum specification value as defined in the datasheet and/or test plan.



Table 5.14. Raw data of large signal voltage gain (AVOL) at  $V_S = \pm 15V$  versus total dose, including the statistical analysis, the specification and the status of the testing (pass/fail).

Voltage Gain @ +/- 15V (V/mV)	Total Dose (krad(Si))					24 Hr Anneal	168 Hr Anneal
	0	10	20	30	50		
Device							
386	4.27E+03	3.68E+03	3.25E+03	2.66E+03	2.05E+03	1.94E+03	2.03E+03
387	3.32E+03	2.81E+03	2.71E+03	2.49E+03	1.86E+03	1.79E+03	1.85E+03
388	3.80E+03	3.47E+03	2.73E+03	2.27E+03	1.82E+03	1.86E+03	1.88E+03
389	2.56E+03	2.34E+03	2.36E+03	2.08E+03	1.64E+03	1.46E+03	1.76E+03
390	3.67E+03	3.53E+03	3.26E+03	2.88E+03	2.22E+03	1.97E+03	2.09E+03
391	4.65E+03	2.76E+03	3.28E+03	3.28E+03	2.24E+03	3.57E+03	3.88E+03
392	3.62E+03	2.65E+03	2.50E+03	2.50E+03	2.01E+03	2.80E+03	3.08E+03
393	2.28E+03	1.88E+03	1.96E+03	1.96E+03	1.53E+03	2.23E+03	2.14E+03
394	3.41E+03	2.52E+03	2.39E+03	2.39E+03	1.80E+03	2.64E+03	2.63E+03
395	3.69E+03	2.48E+03	2.43E+03	2.43E+03	1.60E+03	2.56E+03	3.06E+03
396	2.98E+03	2.84E+03	2.87E+03	2.87E+03	2.96E+03	3.06E+03	2.89E+03
<b>Biased Statistics</b>							
Average Biased	3.52E+03	3.16E+03	2.86E+03	2.48E+03	1.92E+03	1.80E+03	1.92E+03
Std Dev Biased	6.38E+02	5.70E+02	3.85E+02	3.16E+02	2.21E+02	2.01E+02	1.36E+02
Ps90%/90% (+KTL) Biased	5.27E+03	4.73E+03	3.91E+03	3.35E+03	2.53E+03	2.36E+03	2.30E+03
Ps90%/90% (-KTL) Biased	1.77E+03	1.60E+03	1.80E+03	1.61E+03	1.31E+03	1.25E+03	1.55E+03
<b>Un-Biased Statistics</b>							
Average Un-Biased	3.53E+03	2.46E+03	2.51E+03	2.51E+03	1.83E+03	2.76E+03	2.96E+03
Std Dev Un-Biased	8.46E+02	3.42E+02	4.79E+02	4.79E+02	2.93E+02	5.00E+02	6.44E+02
Ps90%/90% (+KTL) Un-Biased	5.85E+03	3.39E+03	3.82E+03	3.82E+03	2.64E+03	4.13E+03	4.73E+03
Ps90%/90% (-KTL) Un-Biased	1.21E+03	1.52E+03	1.20E+03	1.20E+03	1.03E+03	1.39E+03	1.19E+03
<b>Specification MIN</b>	<b>8.00E+01</b>	<b>8.00E+01</b>	<b>8.00E+01</b>	<b>8.00E+01</b>	<b>3.20E+01</b>	<b>3.20E+01</b>	<b>3.20E+01</b>
Status	PASS	PASS	PASS	PASS	PASS	PASS	PASS



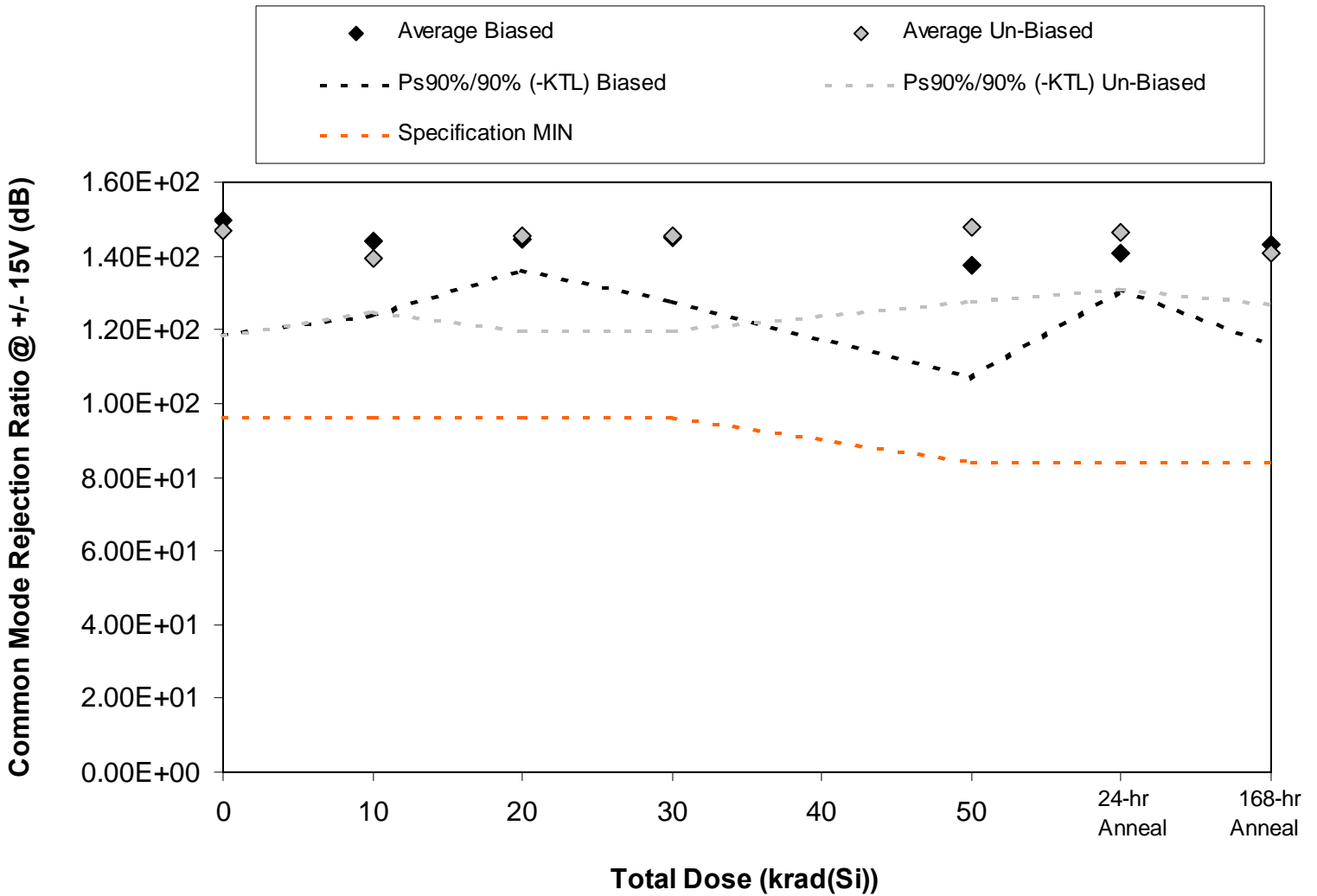

Figure 5.15. Plot of common mode rejection ratio (CMRR) at  $V_S = \pm 15V$  versus total dose. The units irradiated under bias show a small decrease with total dose, however not sufficient to cause the data to fall below specification (even after application of the KTL statistics). The solid diamonds are the average of the measured data points for the sample irradiated under electrical bias while the shaded diamonds are the average of the measured data points for the units irradiated with all pins tied to ground. The black lines (solid or dashed) are the average of the data points after application of the KTL statistics on the sample irradiated in the biased condition while the shaded lines (solid or dashed) are the average of the data points after application of the KTL statistics on the sample irradiated in the unbiased condition. The red dotted line(s) are the pre- and/or post-irradiation minimum and/or maximum specification value as defined in the datasheet and/or test plan.



Table 5.15. Raw data of common mode rejection ratio (CMRR) at  $V_S = \pm 15V$  versus total dose, including the statistical analysis, the specification and the status of the testing (pass/fail).

Common Mode Rejection Ratio @ +/- 15V (dB)	Total Dose (krad(Si))					24 Hr Anneal	168 Hr Anneal
	0	10	20	30	50		
Device							
386	1.45E+02	1.37E+02	1.46E+02	1.43E+02	1.27E+02	1.40E+02	1.39E+02
387	1.61E+02	1.43E+02	1.46E+02	1.39E+02	1.51E+02	1.39E+02	1.32E+02
388	1.62E+02	1.38E+02	1.44E+02	1.39E+02	1.47E+02	1.36E+02	1.38E+02
389	1.39E+02	1.55E+02	1.48E+02	1.51E+02	1.34E+02	1.45E+02	1.51E+02
390	1.41E+02	1.47E+02	1.40E+02	1.52E+02	1.27E+02	1.44E+02	1.55E+02
391	1.62E+02	1.35E+02	1.39E+02	1.39E+02	1.41E+02	1.40E+02	1.36E+02
392	1.43E+02	1.48E+02	1.51E+02	1.51E+02	1.56E+02	1.44E+02	1.39E+02
393	1.52E+02	1.41E+02	1.40E+02	1.40E+02	1.55E+02	1.51E+02	1.38E+02
394	1.39E+02	1.37E+02	1.60E+02	1.60E+02	1.44E+02	1.53E+02	1.48E+02
395	1.38E+02	1.36E+02	1.38E+02	1.38E+02	1.42E+02	1.44E+02	1.45E+02
396	1.44E+02	1.46E+02	1.51E+02	1.51E+02	1.55E+02	1.40E+02	1.44E+02
<b>Biased Statistics</b>							
Average Biased	1.49E+02	1.44E+02	1.45E+02	1.45E+02	1.37E+02	1.41E+02	1.43E+02
Std Dev Biased	1.12E+01	7.27E+00	3.08E+00	6.36E+00	1.10E+01	3.73E+00	9.84E+00
Ps90%/90% (+KTL) Biased	1.80E+02	1.64E+02	1.53E+02	1.62E+02	1.68E+02	1.51E+02	1.70E+02
Ps90%/90% (-KTL) Biased	1.19E+02	1.24E+02	1.36E+02	1.27E+02	1.07E+02	1.31E+02	1.16E+02
<b>Un-Biased Statistics</b>							
Average Un-Biased	1.47E+02	1.39E+02	1.46E+02	1.46E+02	1.48E+02	1.46E+02	1.41E+02
Std Dev Un-Biased	1.04E+01	5.26E+00	9.41E+00	9.41E+00	7.23E+00	5.63E+00	5.18E+00
Ps90%/90% (+KTL) Un-Biased	1.75E+02	1.54E+02	1.71E+02	1.71E+02	1.67E+02	1.62E+02	1.55E+02
Ps90%/90% (-KTL) Un-Biased	1.18E+02	1.25E+02	1.20E+02	1.20E+02	1.28E+02	1.31E+02	1.27E+02
<b>Specification MIN</b>	<b>9.60E+01</b>	<b>9.60E+01</b>	<b>9.60E+01</b>	<b>9.60E+01</b>	<b>8.40E+01</b>	<b>8.40E+01</b>	<b>8.40E+01</b>
Status	PASS	PASS	PASS	PASS	PASS	PASS	PASS

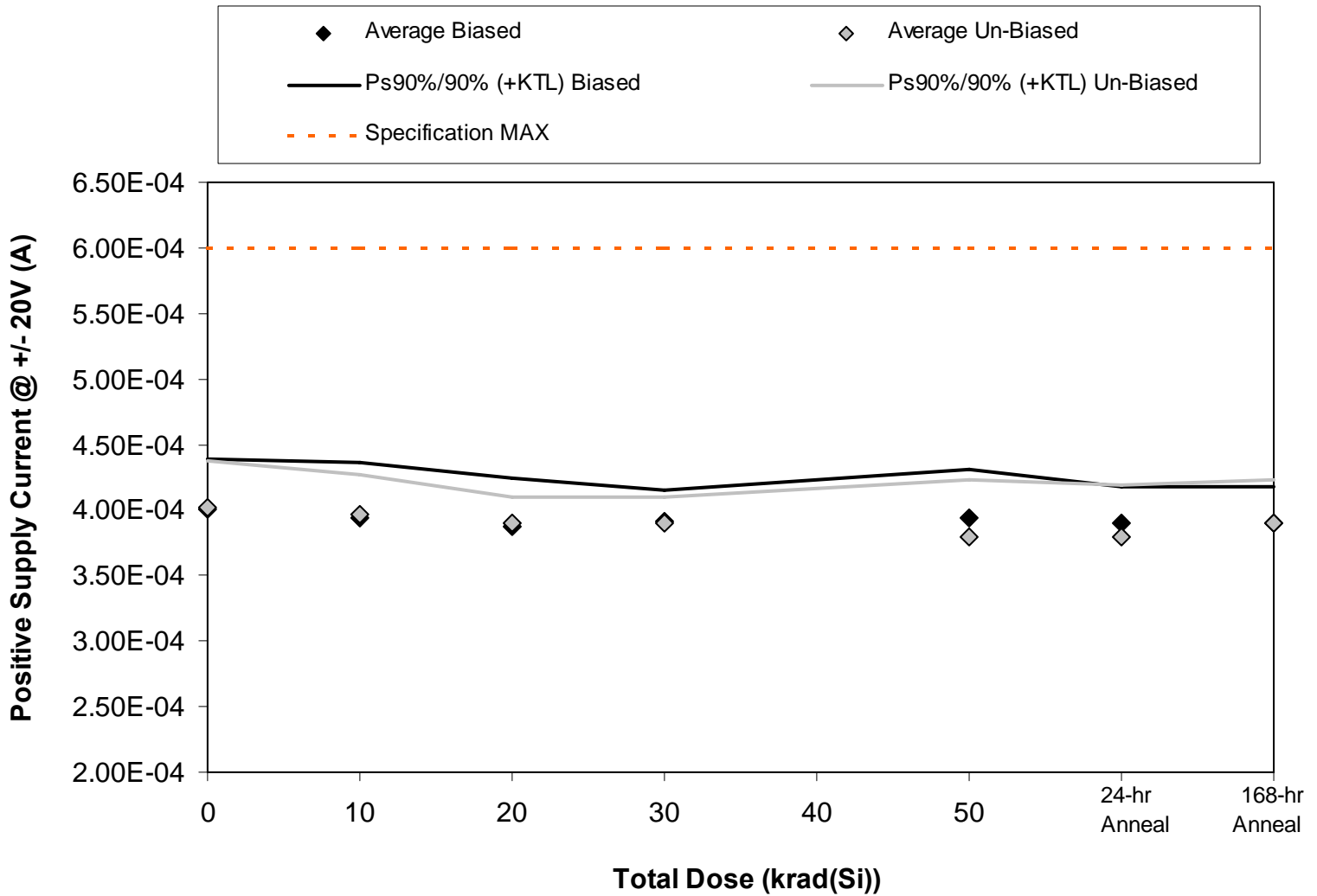

Figure 5.16. Plot of positive supply current at  $V_S = \pm 20V$  versus total dose. The data shows no significant degradation with dose. The solid diamonds are the average of the measured data points for the sample irradiated under electrical bias while the shaded diamonds are the average of the measured data points for the units irradiated with all pins tied to ground. The black lines (solid or dashed) are the average of the data points after application of the KTL statistics on the sample irradiated in the biased condition while the shaded lines (solid or dashed) are the average of the data points after application of the KTL statistics on the sample irradiated in the unbiased condition. The red dotted line(s) are the pre- and/or post-irradiation minimum and/or maximum specification value as defined in the datasheet and/or test plan.



Table 5.16. Raw data for the positive supply current at  $V_S = \pm 20V$  versus total dose, including the statistical analysis, specification and the status of the testing (pass/fail)

Positive Supply Current @ +/- 20V (A)	Total Dose (krad(Si))					24 Hr Anneal	168 Hr Anneal
	0	10	20	30	50		
Device							
386	3.90E-04	3.80E-04	3.80E-04	3.80E-04	3.80E-04	3.80E-04	3.80E-04
387	3.90E-04	3.80E-04	3.70E-04	4.00E-04	3.80E-04	3.80E-04	3.80E-04
388	4.20E-04	4.10E-04	4.00E-04	3.90E-04	4.00E-04	4.00E-04	4.00E-04
389	3.90E-04	3.90E-04	3.90E-04	3.90E-04	4.00E-04	3.90E-04	3.90E-04
390	4.10E-04	4.10E-04	4.00E-04	4.00E-04	4.10E-04	4.00E-04	4.00E-04
391	3.90E-04	3.90E-04	3.90E-04	3.90E-04	3.70E-04	3.70E-04	3.80E-04
392	4.00E-04	4.00E-04	3.90E-04	3.90E-04	3.80E-04	3.90E-04	3.90E-04
393	4.20E-04	4.10E-04	4.00E-04	4.00E-04	4.00E-04	3.90E-04	4.10E-04
394	4.10E-04	4.00E-04	3.90E-04	3.90E-04	3.90E-04	3.90E-04	3.90E-04
395	3.90E-04	3.80E-04	3.80E-04	3.80E-04	3.60E-04	3.60E-04	3.80E-04
396	3.80E-04	3.90E-04	3.90E-04	3.90E-04	3.80E-04	3.90E-04	3.80E-04
<b>Biased Statistics</b>							
Average Biased	4.00E-04	3.94E-04	3.88E-04	3.92E-04	3.94E-04	3.90E-04	3.90E-04
Std Dev Biased	1.41E-05	1.52E-05	1.30E-05	8.37E-06	1.34E-05	1.00E-05	1.00E-05
Ps90%/90% (+KTL) Biased	4.39E-04	4.36E-04	4.24E-04	4.15E-04	4.31E-04	4.17E-04	4.17E-04
Ps90%/90% (-KTL) Biased	3.61E-04	3.52E-04	3.52E-04	3.69E-04	3.57E-04	3.63E-04	3.63E-04
<b>Un-Biased Statistics</b>							
Average Un-Biased	4.02E-04	3.96E-04	3.90E-04	3.90E-04	3.80E-04	3.80E-04	3.90E-04
Std Dev Un-Biased	1.30E-05	1.14E-05	7.07E-06	7.07E-06	1.58E-05	1.41E-05	1.22E-05
Ps90%/90% (+KTL) Un-Biased	4.38E-04	4.27E-04	4.09E-04	4.09E-04	4.23E-04	4.19E-04	4.24E-04
Ps90%/90% (-KTL) Un-Biased	3.66E-04	3.65E-04	3.71E-04	3.71E-04	3.37E-04	3.41E-04	3.56E-04
<b>Specification MAX</b>	<b>6.00E-04</b>	<b>6.00E-04</b>	<b>6.00E-04</b>	<b>6.00E-04</b>	<b>6.00E-04</b>	<b>6.00E-04</b>	<b>6.00E-04</b>
Status	PASS	PASS	PASS	PASS	PASS	PASS	PASS

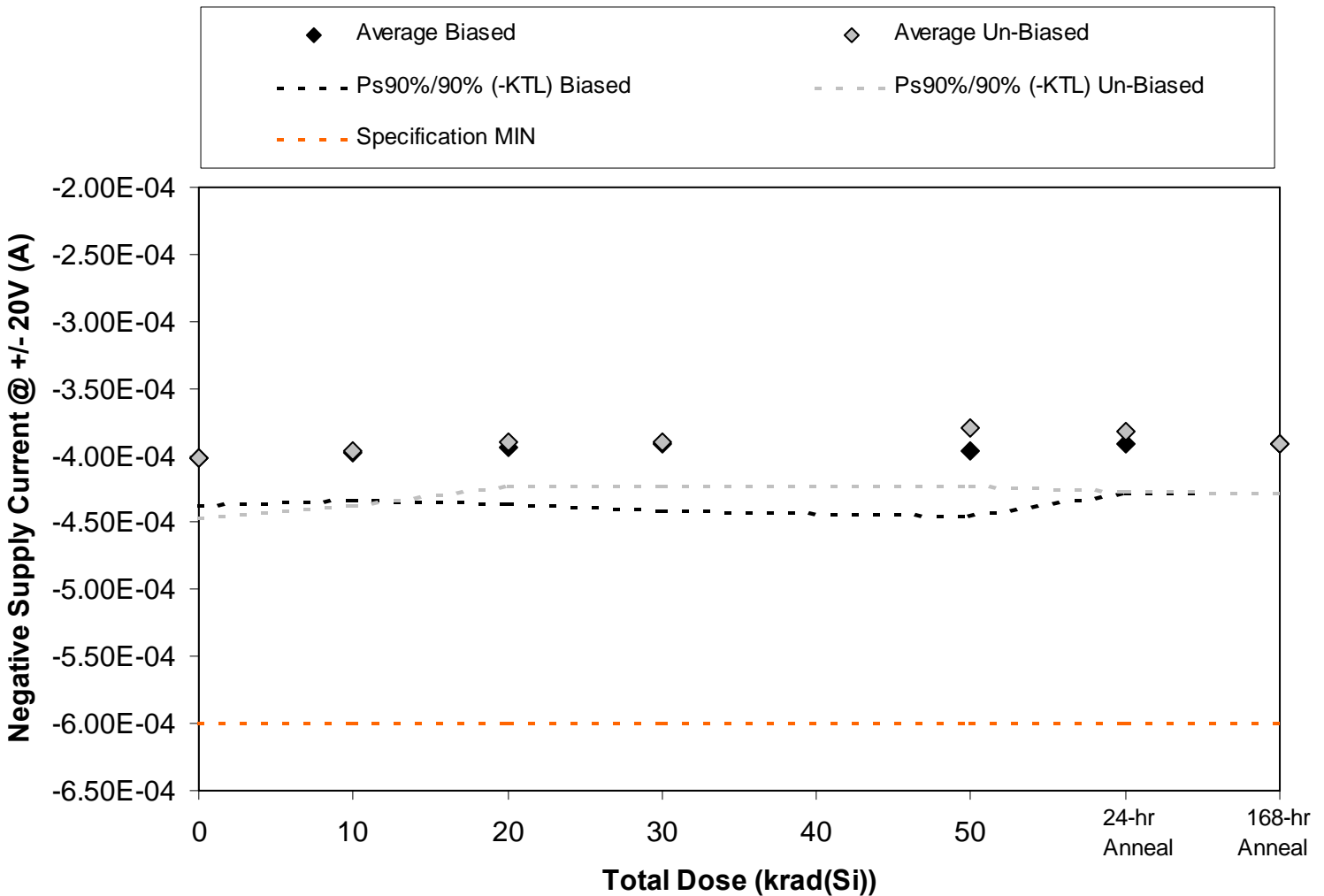

Figure 5.17. Plot of negative supply current at  $V_S = \pm 20V$  versus total dose. The data shows no significant degradation with dose. The solid diamonds are the average of the measured data points for the sample irradiated under electrical bias while the shaded diamonds are the average of the measured data points for the units irradiated with all pins tied to ground. The black lines (solid or dashed) are the average of the data points after application of the KTL statistics on the sample irradiated in the biased condition while the shaded lines (solid or dashed) are the average of the data points after application of the KTL statistics on the sample irradiated in the unbiased condition. The red dotted line(s) are the pre- and/or post-irradiation minimum and/or maximum specification value as defined in the datasheet and/or test plan.



Table 5.17. Raw data for the negative supply current at  $V_S = \pm 20V$  versus total dose, including the statistical analysis, the specification and the status of the testing (pass/fail)

Negative Supply Current @ +/- 20V (A)	Total Dose (krad(Si))					24 Hr Anneal	168 Hr Anneal
	0	10	20	30	50		
Device							
386	-3.90E-04	-3.80E-04	-3.80E-04	-3.80E-04	-3.90E-04	-3.80E-04	-3.80E-04
387	-3.90E-04	-3.90E-04	-3.80E-04	-4.10E-04	-3.70E-04	-3.80E-04	-3.80E-04
388	-4.20E-04	-4.10E-04	-4.10E-04	-3.70E-04	-4.00E-04	-4.00E-04	-4.10E-04
389	-4.00E-04	-4.00E-04	-3.90E-04	-3.90E-04	-4.00E-04	-3.90E-04	-3.90E-04
390	-4.10E-04	-4.10E-04	-4.10E-04	-4.10E-04	-4.20E-04	-4.10E-04	-4.00E-04
391	-3.90E-04	-3.80E-04	-3.90E-04	-3.90E-04	-3.70E-04	-3.70E-04	-3.80E-04
392	-4.10E-04	-4.00E-04	-3.90E-04	-3.90E-04	-3.90E-04	-3.90E-04	-3.90E-04
393	-4.20E-04	-4.10E-04	-4.00E-04	-4.00E-04	-4.00E-04	-4.00E-04	-4.10E-04
394	-4.10E-04	-4.10E-04	-4.00E-04	-4.00E-04	-3.80E-04	-3.90E-04	-4.00E-04
395	-3.80E-04	-3.80E-04	-3.70E-04	-3.70E-04	-3.60E-04	-3.60E-04	-3.80E-04
396	-3.90E-04	-3.90E-04	-3.90E-04	-3.90E-04	-3.90E-04	-3.80E-04	-3.90E-04
<b>Biased Statistics</b>							
Average Biased	-4.02E-04	-3.98E-04	-3.94E-04	-3.92E-04	-3.96E-04	-3.92E-04	-3.92E-04
Std Dev Biased	1.30E-05	1.30E-05	1.52E-05	1.79E-05	1.82E-05	1.30E-05	1.30E-05
Ps90%/90% (+KTL) Biased	-3.66E-04	-3.62E-04	-3.52E-04	-3.43E-04	-3.46E-04	-3.56E-04	-3.56E-04
Ps90%/90% (-KTL) Biased	-4.38E-04	-4.34E-04	-4.36E-04	-4.41E-04	-4.46E-04	-4.28E-04	-4.28E-04
<b>Un-Biased Statistics</b>							
Average Un-Biased	-4.02E-04	-3.96E-04	-3.90E-04	-3.90E-04	-3.80E-04	-3.82E-04	-3.92E-04
Std Dev Un-Biased	1.64E-05	1.52E-05	1.22E-05	1.22E-05	1.58E-05	1.64E-05	1.30E-05
Ps90%/90% (+KTL) Un-Biased	-3.57E-04	-3.54E-04	-3.56E-04	-3.56E-04	-3.37E-04	-3.37E-04	-3.56E-04
Ps90%/90% (-KTL) Un-Biased	-4.47E-04	-4.38E-04	-4.24E-04	-4.24E-04	-4.23E-04	-4.27E-04	-4.28E-04
<b>Specification MIN</b>	<b>-6.00E-04</b>	<b>-6.00E-04</b>	<b>-6.00E-04</b>	<b>-6.00E-04</b>	<b>-6.00E-04</b>	<b>-6.00E-04</b>	<b>-6.00E-04</b>
Status	PASS	PASS	PASS	PASS	PASS	PASS	PASS

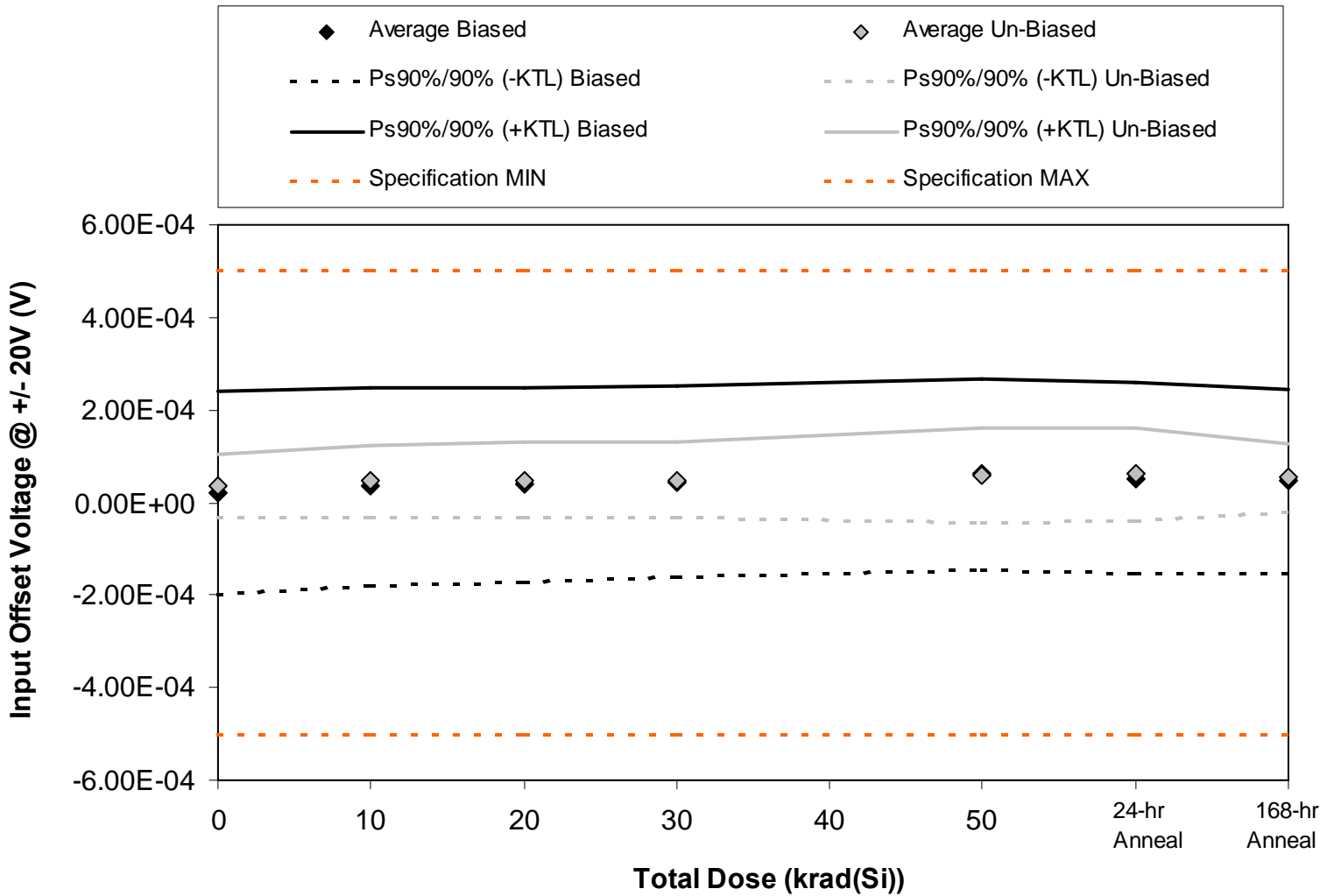

Figure 5.18. Plot of input offset voltage at  $V_S = \pm 20V$  versus total dose. The data shows no significant degradation with dose. The solid diamonds are the average of the measured data points for the sample irradiated under electrical bias while the shaded diamonds are the average of the measured data points for the units irradiated with all pins tied to ground. The black lines (solid or dashed) are the average of the data points after application of the KTL statistics on the sample irradiated in the biased condition while the shaded lines (solid or dashed) are the average of the data points after application of the KTL statistics on the sample irradiated in the unbiased condition. The red dotted line(s) are the pre- and/or post-irradiation minimum and/or maximum specification value as defined in the datasheet and/or test plan.



Table 5.18. Raw data for the input offset voltage at  $V_S = \pm 20V$  versus total dose, including the statistical analysis, the specification and the status of the testing (pass/fail)

Input Offset Voltage @ +/- 20V (V)	Total Dose (krad(Si))					24 Hr Anneal	168 Hr Anneal
	0	10	20	30	50		
Device							
386	-9.80E-05	-8.20E-05	-7.20E-05	-6.50E-05	-4.40E-05	-5.30E-05	-5.60E-05
387	5.20E-05	6.50E-05	6.80E-05	4.40E-05	8.60E-05	8.10E-05	7.40E-05
388	3.60E-05	4.50E-05	4.20E-05	7.10E-05	5.30E-05	4.80E-05	5.30E-05
389	1.00E-06	1.20E-05	1.50E-05	2.80E-05	4.50E-05	3.40E-05	2.20E-05
390	1.20E-04	1.32E-04	1.37E-04	1.43E-04	1.63E-04	1.53E-04	1.42E-04
391	2.80E-05	2.70E-05	2.30E-05	2.30E-05	1.20E-05	1.90E-05	4.20E-05
392	-4.00E-06	8.00E-06	1.20E-05	1.20E-05	2.30E-05	2.60E-05	1.30E-05
393	4.20E-05	5.40E-05	6.10E-05	6.10E-05	7.10E-05	7.70E-05	6.20E-05
394	6.00E-05	7.40E-05	7.60E-05	7.60E-05	8.90E-05	9.30E-05	7.80E-05
395	5.30E-05	6.90E-05	7.20E-05	7.20E-05	9.10E-05	9.30E-05	7.50E-05
396	4.70E-05	5.90E-05	5.70E-05	5.70E-05	5.60E-05	5.50E-05	4.60E-05
<b>Biased Statistics</b>							
Average Biased	2.22E-05	3.44E-05	3.80E-05	4.42E-05	6.06E-05	5.26E-05	4.70E-05
Std Dev Biased	7.99E-05	7.85E-05	7.64E-05	7.53E-05	7.48E-05	7.48E-05	7.25E-05
Ps90%/90% (+KTL) Biased	2.41E-04	2.50E-04	2.47E-04	2.51E-04	2.66E-04	2.58E-04	2.46E-04
Ps90%/90% (-KTL) Biased	-1.97E-04	-1.81E-04	-1.71E-04	-1.62E-04	-1.44E-04	-1.53E-04	-1.52E-04
<b>Un-Biased Statistics</b>							
Average Un-Biased	3.58E-05	4.64E-05	4.88E-05	4.88E-05	5.72E-05	6.16E-05	5.40E-05
Std Dev Un-Biased	2.53E-05	2.82E-05	2.94E-05	2.94E-05	3.73E-05	3.64E-05	2.70E-05
Ps90%/90% (+KTL) Un-Biased	1.05E-04	1.24E-04	1.29E-04	1.29E-04	1.59E-04	1.61E-04	1.28E-04
Ps90%/90% (-KTL) Un-Biased	-3.36E-05	-3.09E-05	-3.17E-05	-3.17E-05	-4.50E-05	-3.81E-05	-1.99E-05
<b>Specification MIN</b>	<b>-5.00E-04</b>	<b>-5.00E-04</b>	<b>-5.00E-04</b>	<b>-5.00E-04</b>	<b>-5.00E-04</b>	<b>-5.00E-04</b>	<b>-5.00E-04</b>
Status	PASS	PASS	PASS	PASS	PASS	PASS	PASS
<b>Specification MAX</b>	<b>5.00E-04</b>	<b>5.00E-04</b>	<b>5.00E-04</b>	<b>5.00E-04</b>	<b>5.00E-04</b>	<b>5.00E-04</b>	<b>5.00E-04</b>
Status	PASS	PASS	PASS	PASS	PASS	PASS	PASS



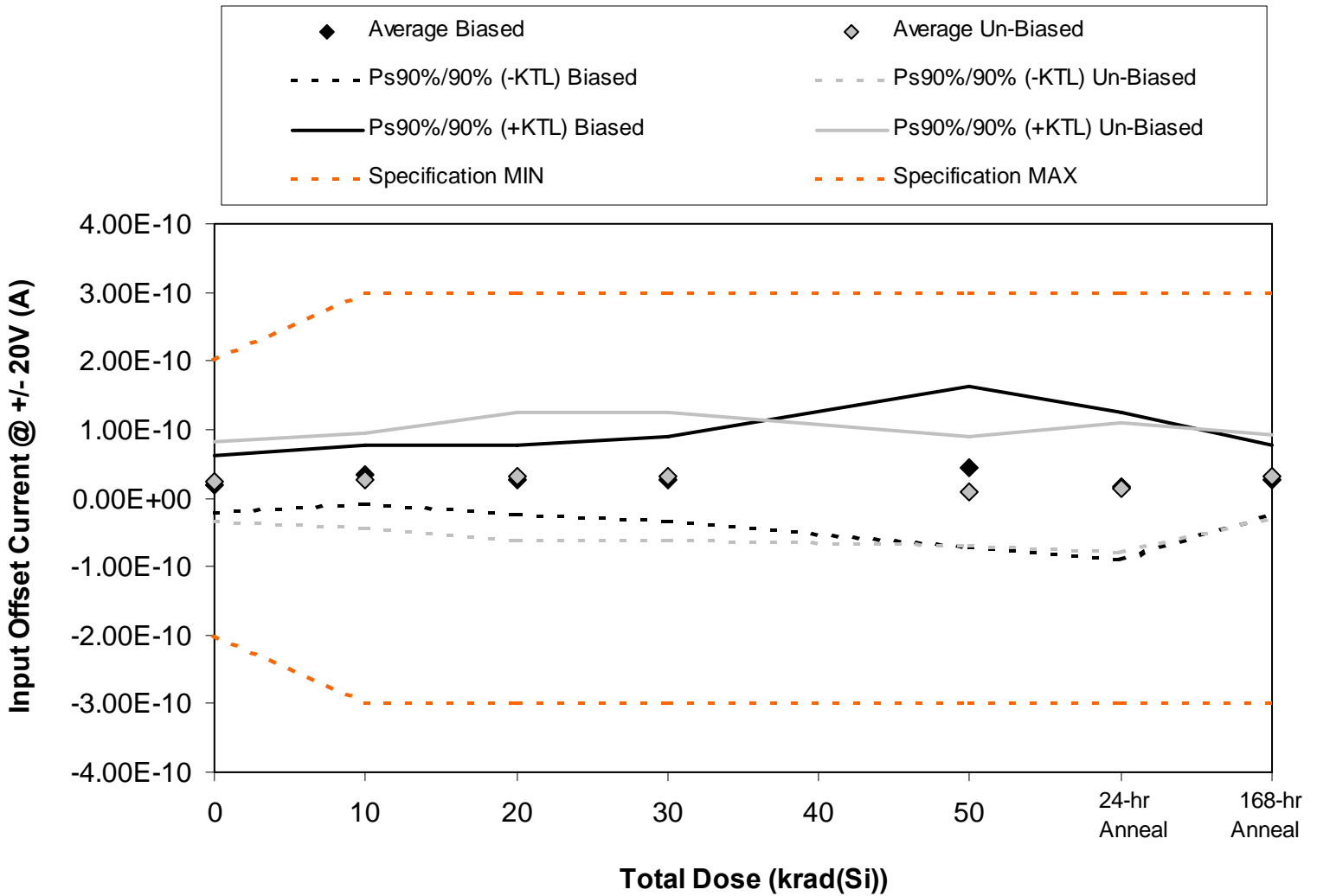

Figure 5.19. Plot of input offset current at  $V_s = \pm 20V$  versus total dose. The data no significant increase with dose. The solid diamonds are the average of the measured data points for the sample irradiated under electrical bias while the shaded diamonds are the average of the measured data points for the units irradiated with all pins tied to ground. The black lines (solid or dashed) are the average of the data points after application of the KTL statistics on the sample irradiated in the biased condition while the shaded lines (solid or dashed) are the average of the data points after application of the KTL statistics on the sample irradiated in the unbiased condition. The red dotted line(s) are the pre- and/or post-irradiation minimum and/or maximum specification value as defined in the datasheet and/or test plan.



Table 5.19. Raw data for input offset current at  $V_S = \pm 20V$  versus total dose, including the statistical analysis, the specification and the status of the testing (pass/fail).

Input Offset Current @ +/- 20V (A)	Total Dose (krad(Si))					24 Hr Anneal	168 Hr Anneal
	0	10	20	30	50		
Device 386	9.00E-12	3.20E-11	1.40E-11	3.00E-12	-1.40E-11	-1.80E-11	0.00E+00
387	0.00E+00	5.40E-11	1.10E-11	2.80E-11	2.40E-11	-1.10E-11	4.80E-11
388	2.20E-11	1.10E-11	1.40E-11	1.00E-11	4.50E-11	3.60E-11	2.80E-11
389	3.60E-11	3.20E-11	5.00E-11	3.60E-11	9.70E-11	7.60E-11	3.80E-11
390	3.10E-11	4.30E-11	4.30E-11	6.10E-11	7.30E-11	0.00E+00	2.10E-11
391	4.90E-11	6.00E-11	4.10E-11	4.10E-11	1.30E-11	1.10E-11	7.00E-12
392	3.60E-11	4.30E-11	8.60E-11	8.60E-11	5.60E-11	7.20E-11	6.20E-11
393	4.00E-12	-3.00E-12	3.00E-12	3.00E-12	-2.30E-11	-2.20E-11	1.70E-11
394	0.00E+00	1.30E-11	1.70E-11	1.70E-11	3.00E-12	0.00E+00	4.50E-11
395	3.10E-11	1.70E-11	1.00E-11	1.00E-11	0.00E+00	1.40E-11	3.00E-11
396	-1.30E-11	-1.00E-11	-1.00E-11	-1.00E-11	-1.00E-11	-1.40E-11	-1.00E-11
<b>Biased Statistics</b>							
Average Biased	1.96E-11	3.44E-11	2.64E-11	2.76E-11	4.50E-11	1.66E-11	2.70E-11
Std Dev Biased	1.50E-11	1.59E-11	1.86E-11	2.29E-11	4.30E-11	3.92E-11	1.82E-11
Ps90%/90% (+KTL) Biased	6.08E-11	7.81E-11	7.73E-11	9.04E-11	1.63E-10	1.24E-10	7.70E-11
Ps90%/90% (-KTL) Biased	-2.16E-11	-9.33E-12	-2.45E-11	-3.52E-11	-7.30E-11	-9.08E-11	-2.30E-11
<b>Un-Biased Statistics</b>							
Average Un-Biased	2.40E-11	2.60E-11	3.14E-11	3.14E-11	9.80E-12	1.50E-11	3.22E-11
Std Dev Un-Biased	2.12E-11	2.52E-11	3.37E-11	3.37E-11	2.90E-11	3.49E-11	2.19E-11
Ps90%/90% (+KTL) Un-Biased	8.21E-11	9.50E-11	1.24E-10	1.24E-10	8.93E-11	1.11E-10	9.23E-11
Ps90%/90% (-KTL) Un-Biased	-3.41E-11	-4.30E-11	-6.10E-11	-6.10E-11	-6.97E-11	-8.06E-11	-2.79E-11
<b>Specification MIN</b>	<b>-2.00E-10</b>	<b>-3.00E-10</b>	<b>-3.00E-10</b>	<b>-3.00E-10</b>	<b>-3.00E-10</b>	<b>-3.00E-10</b>	<b>-3.00E-10</b>
Status	PASS	PASS	PASS	PASS	PASS	PASS	PASS
<b>Specification MAX</b>	<b>2.00E-10</b>	<b>3.00E-10</b>	<b>3.00E-10</b>	<b>3.00E-10</b>	<b>3.00E-10</b>	<b>3.00E-10</b>	<b>3.00E-10</b>
Status	PASS	PASS	PASS	PASS	PASS	PASS	PASS

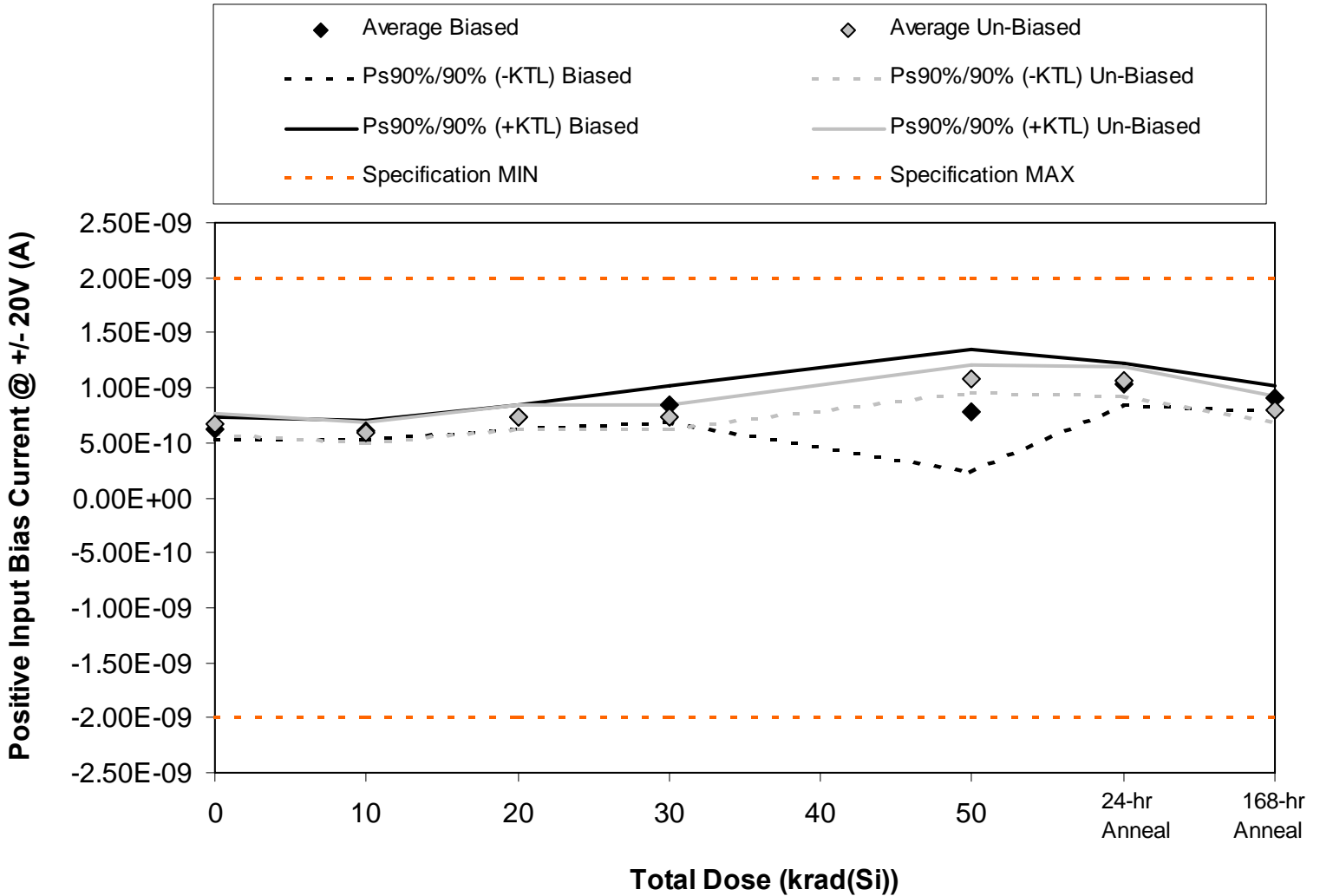

Figure 5.20. Plot of input bias current (non-inverting input) at  $V_s = \pm 20V$  versus total dose. The data shows no significant degradation with dose. The solid diamonds are the average of the measured data points for the sample irradiated under electrical bias while the shaded diamonds are the average of the measured data points for the units irradiated with all pins tied to ground. The black lines (solid or dashed) are the average of the data points after application of the KTL statistics on the sample irradiated in the biased condition while the shaded lines (solid or dashed) are the average of the data points after application of the KTL statistics on the sample irradiated in the unbiased condition. The red dotted line(s) are the pre- and/or post-irradiation minimum and/or maximum specification value as defined in the datasheet and/or test plan.



Table 5.20. Raw data for input bias current (non-inverting input) at  $V_S = \pm 5V$  versus total dose, including the statistical analysis, the specification and the status of the testing (pass/fail).

Positive Input Bias Current @ +/- 20V (A)	Total Dose (krad(Si))					24 Hr Anneal	168 Hr Anneal
	0	10	20	30	50		
Device							
386	6.77E-10	6.52E-10	7.74E-10	8.84E-10	5.66E-10	1.07E-09	9.39E-10
387	6.45E-10	6.45E-10	7.38E-10	7.46E-10	1.03E-09	1.00E-09	9.11E-10
388	5.96E-10	5.83E-10	6.70E-10	8.46E-10	8.39E-10	9.36E-10	8.29E-10
389	6.41E-10	6.01E-10	7.42E-10	8.68E-10	9.01E-10	1.06E-09	9.18E-10
390	5.92E-10	5.87E-10	7.38E-10	8.93E-10	5.83E-10	1.12E-09	9.11E-10
391	6.81E-10	5.99E-10	7.59E-10	7.59E-10	1.05E-09	1.03E-09	7.35E-10
392	6.94E-10	6.22E-10	7.91E-10	7.91E-10	1.15E-09	1.14E-09	8.49E-10
393	6.36E-10	5.46E-10	6.88E-10	6.88E-10	1.05E-09	1.02E-09	8.04E-10
394	6.41E-10	5.62E-10	7.05E-10	7.05E-10	1.07E-09	1.03E-09	8.22E-10
395	7.12E-10	6.15E-10	7.31E-10	7.31E-10	1.05E-09	1.07E-09	8.08E-10
396	6.28E-10	4.63E-10	4.63E-10	4.63E-10	4.63E-10	5.08E-10	4.63E-10
<b>Biased Statistics</b>							
Average Biased	6.30E-10	6.14E-10	7.32E-10	8.47E-10	7.84E-10	1.04E-09	9.02E-10
Std Dev Biased	3.59E-11	3.26E-11	3.80E-11	5.94E-11	2.03E-10	7.04E-11	4.22E-11
Ps90%/90% (+KTL) Biased	7.29E-10	7.03E-10	8.37E-10	1.01E-09	1.34E-09	1.23E-09	1.02E-09
Ps90%/90% (-KTL) Biased	5.32E-10	5.24E-10	6.28E-10	6.84E-10	2.27E-10	8.44E-10	7.86E-10
<b>Un-Biased Statistics</b>							
Average Un-Biased	6.73E-10	5.89E-10	7.35E-10	7.35E-10	1.07E-09	1.06E-09	8.04E-10
Std Dev Un-Biased	3.32E-11	3.33E-11	4.13E-11	4.13E-11	4.56E-11	4.93E-11	4.22E-11
Ps90%/90% (+KTL) Un-Biased	7.64E-10	6.80E-10	8.48E-10	8.48E-10	1.20E-09	1.19E-09	9.19E-10
Ps90%/90% (-KTL) Un-Biased	5.82E-10	4.97E-10	6.21E-10	6.21E-10	9.49E-10	9.22E-10	6.88E-10
<b>Specification MIN</b>	<b>-2.00E-09</b>	<b>-2.00E-09</b>	<b>-2.00E-09</b>	<b>-2.00E-09</b>	<b>-2.00E-09</b>	<b>-2.00E-09</b>	<b>-2.00E-09</b>
Status	PASS	PASS	PASS	PASS	PASS	PASS	PASS
<b>Specification MAX</b>	<b>2.00E-09</b>	<b>2.00E-09</b>	<b>2.00E-09</b>	<b>2.00E-09</b>	<b>2.00E-09</b>	<b>2.00E-09</b>	<b>2.00E-09</b>
Status	PASS	PASS	PASS	PASS	PASS	PASS	PASS

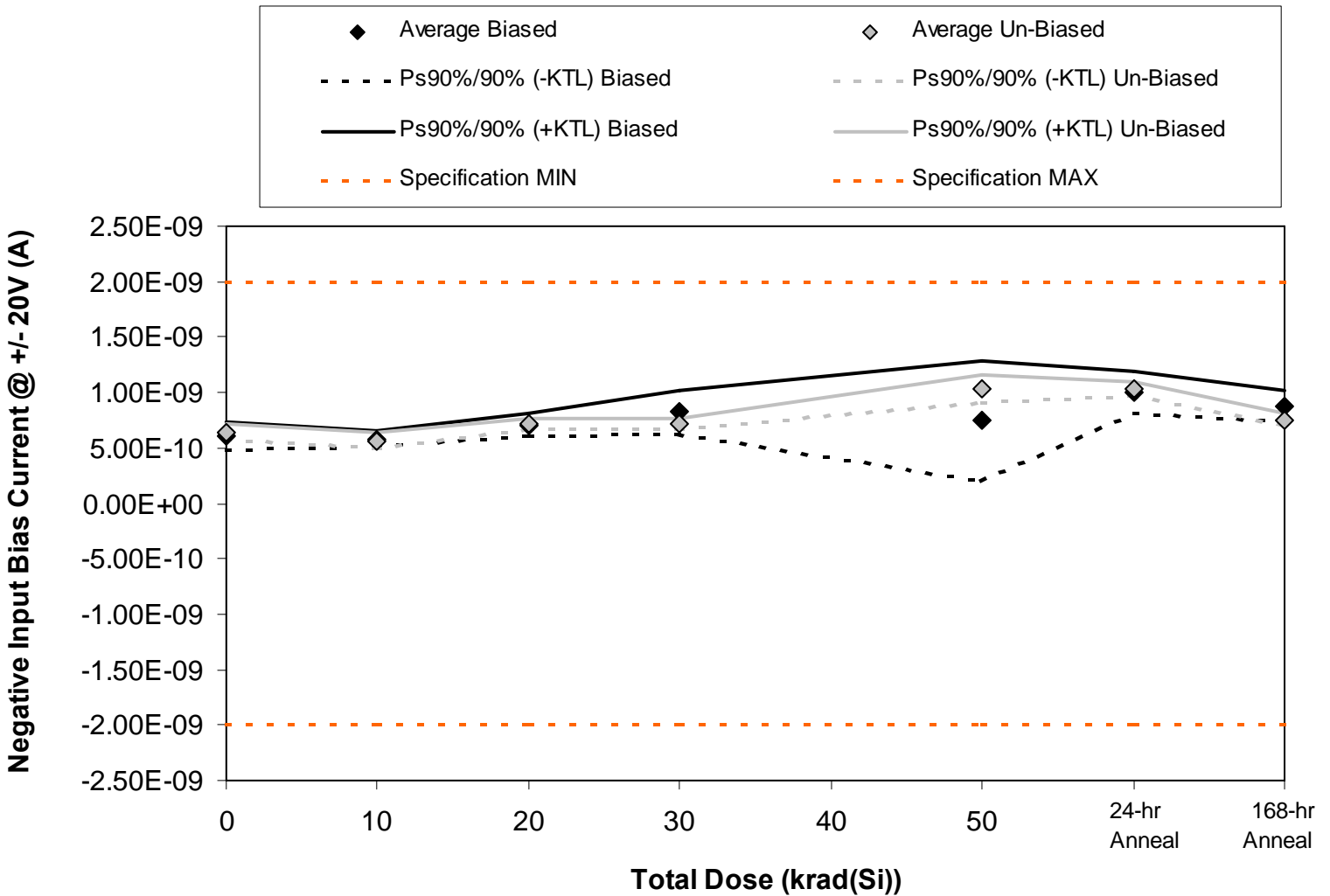

Figure 5.21. Plot of input bias current (inverting input) at  $V_S = \pm 20V$  versus total dose. The data shows no significant degradation with dose. The solid diamonds are the average of the measured data points for the sample irradiated under electrical bias while the shaded diamonds are the average of the measured data points for the units irradiated with all pins tied to ground. The black lines (solid or dashed) are the average of the data points after application of the KTL statistics on the sample irradiated in the biased condition while the shaded lines (solid or dashed) are the average of the data points after application of the KTL statistics on the sample irradiated in the unbiased condition. The red dotted line(s) are the pre- and/or post-irradiation minimum and/or maximum specification value as defined in the datasheet and/or test plan.



Table 5.21. Raw data for input bias current (inverting input) at  $V_S = \pm 20V$  versus total dose, including the statistical analysis, the specification and the status of the testing (pass/fail).

Negative Input Bias Current @ +/- 20V (A)	Total Dose (krad(Si))					24 Hr Anneal	168 Hr Anneal
	0	10	20	30	50		
Device							
386	6.72E-10	6.16E-10	7.56E-10	9.18E-10	5.83E-10	1.01E-09	9.39E-10
387	6.41E-10	5.91E-10	7.31E-10	7.15E-10	1.01E-09	1.06E-09	8.56E-10
388	5.74E-10	5.73E-10	6.55E-10	8.35E-10	7.97E-10	8.93E-10	8.01E-10
389	6.10E-10	5.73E-10	6.91E-10	8.21E-10	8.15E-10	9.80E-10	8.77E-10
390	5.61E-10	5.44E-10	6.99E-10	8.39E-10	5.14E-10	1.07E-09	8.91E-10
391	6.28E-10	5.39E-10	7.18E-10	7.18E-10	9.76E-10	1.02E-09	7.25E-10
392	6.59E-10	5.79E-10	7.42E-10	7.42E-10	1.06E-09	1.02E-09	7.80E-10
393	6.28E-10	5.53E-10	7.18E-10	7.18E-10	1.08E-09	1.04E-09	7.54E-10
394	6.32E-10	5.43E-10	6.92E-10	6.92E-10	9.86E-10	1.08E-09	7.48E-10
395	6.81E-10	6.02E-10	7.15E-10	7.15E-10	1.05E-09	1.04E-09	7.45E-10
396	6.36E-10	4.73E-10	4.73E-10	4.73E-10	4.73E-10	5.15E-10	4.73E-10
<b>Biased Statistics</b>							
Average Biased	6.12E-10	5.79E-10	7.06E-10	8.26E-10	7.44E-10	1.00E-09	8.73E-10
Std Dev Biased	4.61E-11	2.65E-11	3.87E-11	7.26E-11	1.98E-10	6.99E-11	5.04E-11
Ps90%/90% (+KTL) Biased	7.38E-10	6.52E-10	8.13E-10	1.02E-09	1.29E-09	1.19E-09	1.01E-09
Ps90%/90% (-KTL) Biased	4.85E-10	5.07E-10	6.00E-10	6.27E-10	2.00E-10	8.10E-10	7.35E-10
<b>Un-Biased Statistics</b>							
Average Un-Biased	6.46E-10	5.63E-10	7.17E-10	7.17E-10	1.03E-09	1.04E-09	7.50E-10
Std Dev Un-Biased	2.36E-11	2.67E-11	1.77E-11	1.77E-11	4.57E-11	2.37E-11	1.98E-11
Ps90%/90% (+KTL) Un-Biased	7.10E-10	6.36E-10	7.66E-10	7.66E-10	1.16E-09	1.10E-09	8.05E-10
Ps90%/90% (-KTL) Un-Biased	5.81E-10	4.90E-10	6.68E-10	6.68E-10	9.04E-10	9.73E-10	6.96E-10
<b>Specification MIN</b>	<b>-2.00E-09</b>	<b>-2.00E-09</b>	<b>-2.00E-09</b>	<b>-2.00E-09</b>	<b>-2.00E-09</b>	<b>-2.00E-09</b>	<b>-2.00E-09</b>
Status	PASS	PASS	PASS	PASS	PASS	PASS	PASS
<b>Specification MAX</b>	<b>2.00E-09</b>	<b>2.00E-09</b>	<b>2.00E-09</b>	<b>2.00E-09</b>	<b>2.00E-09</b>	<b>2.00E-09</b>	<b>2.00E-09</b>
Status	PASS	PASS	PASS	PASS	PASS	PASS	PASS

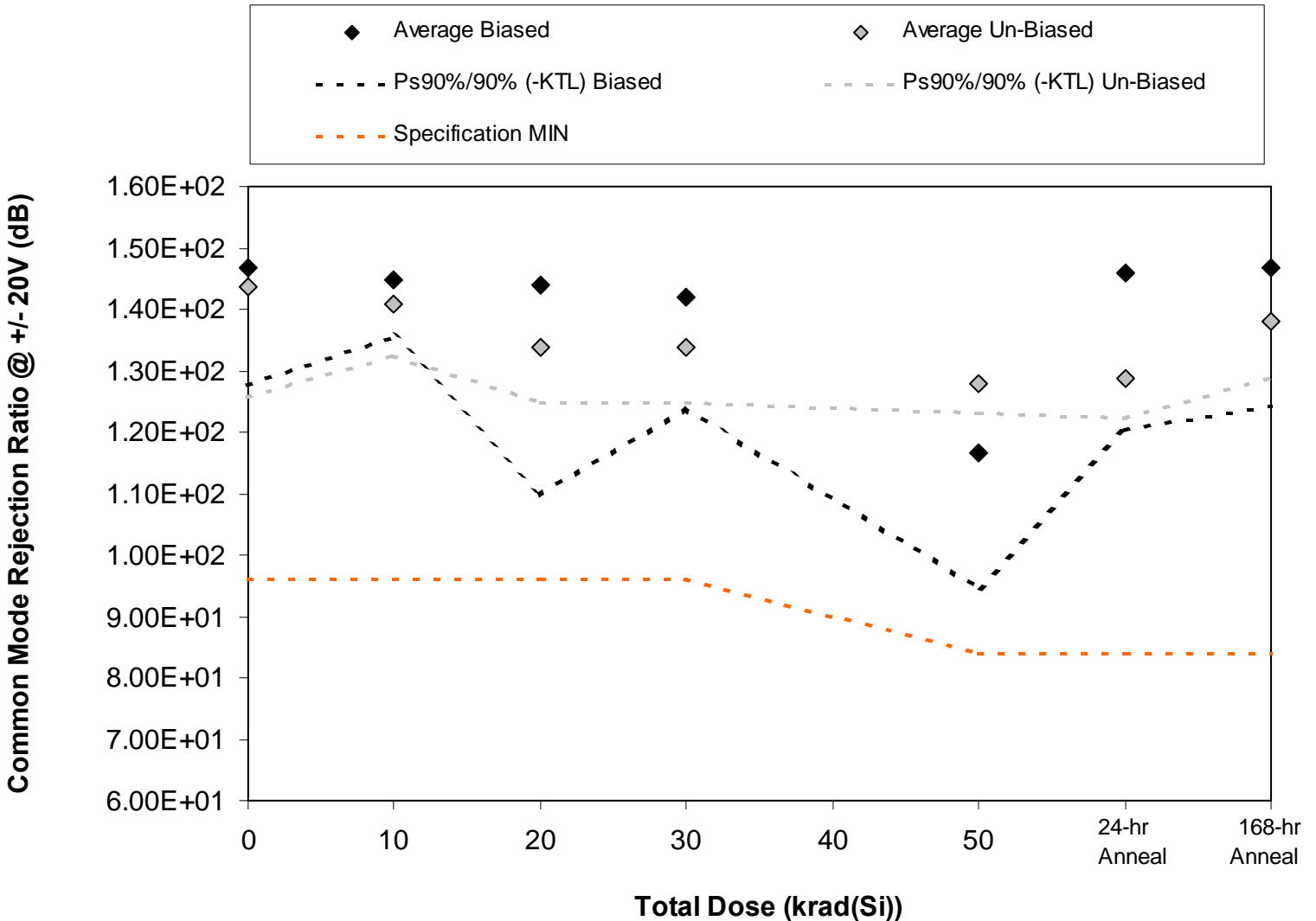

Figure 5.22. Plot of the common mode rejection ratio (CMRR) at  $V_S = \pm 20V$  versus total dose. The data show no significant degradation with total dose. The solid diamonds are the average of the measured data points for the sample irradiated under electrical bias while the shaded diamonds are the average of the measured data points for the units irradiated with all pins tied to ground. The black lines (solid or dashed) are the average of the data points after application of the KTL statistics on the sample irradiated in the biased condition while the shaded lines (solid or dashed) are the average of the data points after application of the KTL statistics on the sample irradiated in the unbiased condition. The red dotted line(s) are the pre- and/or post-irradiation minimum and/or maximum specification value as defined in the datasheet and/or test plan.



Table 5.22. Raw data of common mode rejection ratio (CMRR) at  $V_S = \pm 20V$  versus total dose, including the statistical analysis, the specification and the status of the testing (pass/fail).

Common Mode Rejection Ratio @ +/- 20V (dB)	Total Dose (krad(Si))					24 Hr Anneal	168 Hr Anneal
	0	10	20	30	50		
Device							
386	1.59E+02	1.44E+02	1.39E+02	1.36E+02	1.07E+02	1.36E+02	1.43E+02
387	1.42E+02	1.42E+02	1.38E+02	1.46E+02	1.23E+02	1.50E+02	1.53E+02
388	1.44E+02	1.47E+02	1.41E+02	1.39E+02	1.27E+02	1.55E+02	1.55E+02
389	1.44E+02	1.41E+02	1.36E+02	1.38E+02	1.15E+02	1.53E+02	1.48E+02
390	1.45E+02	1.49E+02	1.66E+02	1.52E+02	1.11E+02	1.36E+02	1.35E+02
391	1.37E+02	1.39E+02	1.39E+02	1.39E+02	1.30E+02	1.32E+02	1.36E+02
392	1.45E+02	1.46E+02	1.34E+02	1.34E+02	1.29E+02	1.28E+02	1.36E+02
393	1.40E+02	1.41E+02	1.32E+02	1.32E+02	1.28E+02	1.29E+02	1.39E+02
394	1.54E+02	1.41E+02	1.32E+02	1.32E+02	1.27E+02	1.28E+02	1.37E+02
395	1.41E+02	1.37E+02	1.32E+02	1.32E+02	1.25E+02	1.26E+02	1.44E+02
396	1.78E+02	1.48E+02	1.42E+02	1.42E+02	1.52E+02	1.45E+02	1.42E+02
<b>Biased Statistics</b>							
Average Biased	1.47E+02	1.45E+02	1.44E+02	1.42E+02	1.17E+02	1.46E+02	1.47E+02
Std Dev Biased	6.96E+00	3.37E+00	1.24E+01	6.56E+00	8.01E+00	9.32E+00	8.26E+00
Ps90%/90% (+KTL) Biased	1.66E+02	1.54E+02	1.78E+02	1.60E+02	1.39E+02	1.72E+02	1.70E+02
Ps90%/90% (-KTL) Biased	1.28E+02	1.36E+02	1.10E+02	1.24E+02	9.46E+01	1.20E+02	1.24E+02
<b>Un-Biased Statistics</b>							
Average Un-Biased	1.44E+02	1.41E+02	1.34E+02	1.34E+02	1.28E+02	1.29E+02	1.38E+02
Std Dev Un-Biased	6.53E+00	3.09E+00	3.30E+00	3.30E+00	1.70E+00	2.31E+00	3.43E+00
Ps90%/90% (+KTL) Un-Biased	1.61E+02	1.49E+02	1.43E+02	1.43E+02	1.33E+02	1.35E+02	1.48E+02
Ps90%/90% (-KTL) Un-Biased	1.26E+02	1.32E+02	1.25E+02	1.25E+02	1.23E+02	1.22E+02	1.29E+02
<b>Specification MIN</b>	<b>9.60E+01</b>	<b>9.60E+01</b>	<b>9.60E+01</b>	<b>9.60E+01</b>	<b>8.40E+01</b>	<b>8.40E+01</b>	<b>8.40E+01</b>
Status	PASS	PASS	PASS	PASS	PASS	PASS	PASS



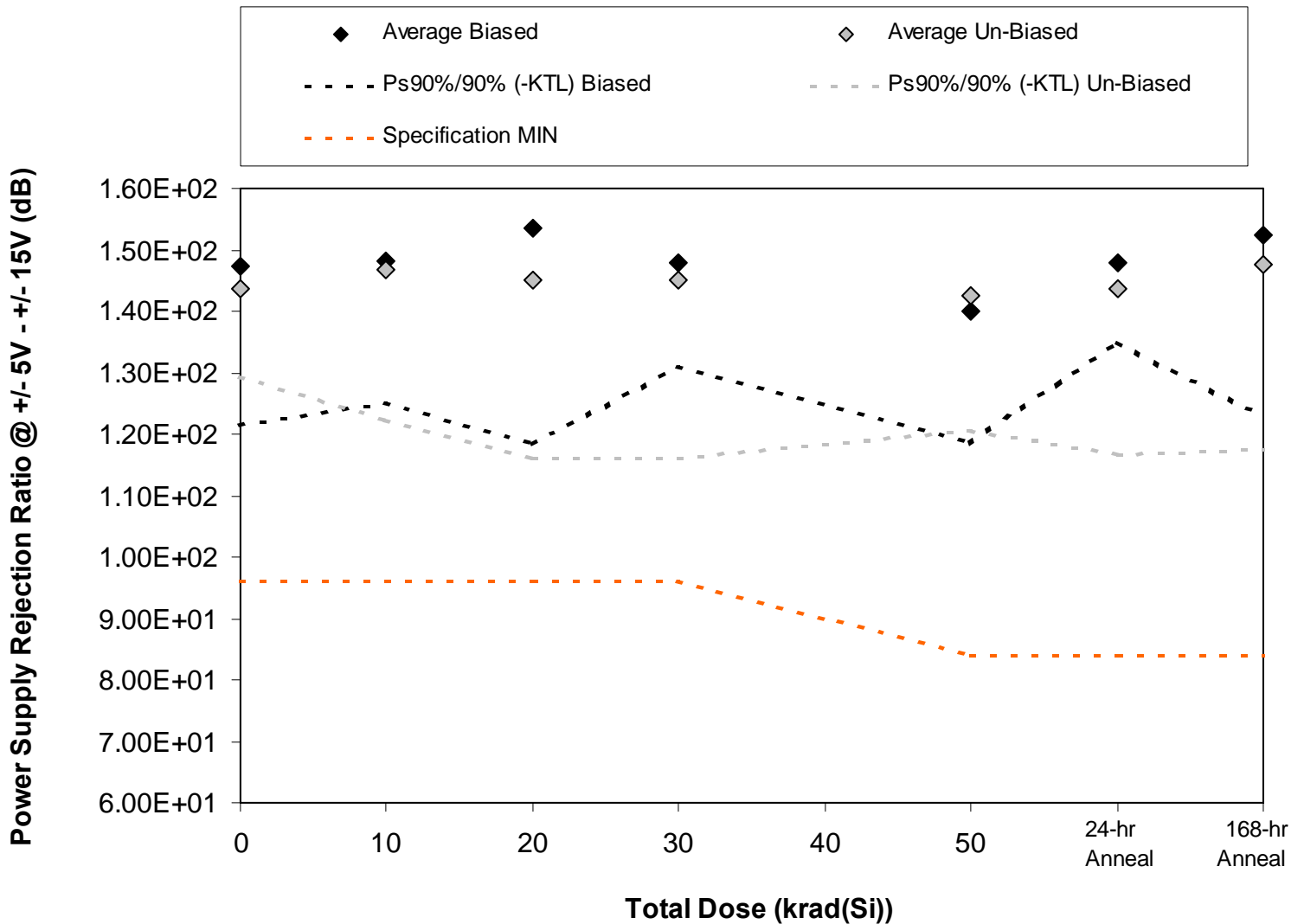

Figure 5.23. Plot of the power supply rejection ratio (PSRR) at  $V_S = \pm 5V$  to  $\pm 15V$  versus total dose. The data show no significant degradation with total dose. The solid diamonds are the average of the measured data points for the sample irradiated under electrical bias while the shaded diamonds are the average of the measured data points for the units irradiated with all pins tied to ground. The black lines (solid or dashed) are the average of the data points after application of the KTL statistics on the sample irradiated in the biased condition while the shaded lines (solid or dashed) are the average of the data points after application of the KTL statistics on the sample irradiated in the unbiased condition. The red dotted line(s) are the pre- and/or post-irradiation minimum and/or maximum specification value as defined in the datasheet and/or test plan.



Table 5.23. Raw data of power supply rejection ratio (PSRR) at  $V_S = \pm 5V$  to  $\pm 15V$  versus total dose, including the statistical analysis, the specification and the status of the testing (pass/fail).

Power Supply Rejection Ratio @ +/- 5V - +/- 15V (dB)	Total Dose (krad(Si))					24 Hr Anneal	168 Hr Anneal
	0	10	20	30	50		
Device							
386	1.60E+02	1.43E+02	1.73E+02	1.49E+02	1.36E+02	1.46E+02	1.41E+02
387	1.48E+02	1.53E+02	1.44E+02	1.40E+02	1.53E+02	1.54E+02	1.49E+02
388	1.53E+02	1.48E+02	1.45E+02	1.47E+02	1.39E+02	1.44E+02	1.48E+02
389	1.37E+02	1.38E+02	1.45E+02	1.57E+02	1.38E+02	1.52E+02	1.70E+02
390	1.39E+02	1.60E+02	1.61E+02	1.47E+02	1.34E+02	1.43E+02	1.55E+02
391	1.44E+02	1.47E+02	1.43E+02	1.43E+02	1.36E+02	1.34E+02	1.39E+02
392	1.44E+02	1.56E+02	1.41E+02	1.41E+02	1.55E+02	1.56E+02	1.47E+02
393	1.35E+02	1.35E+02	1.40E+02	1.40E+02	1.35E+02	1.49E+02	1.66E+02
394	1.44E+02	1.42E+02	1.38E+02	1.38E+02	1.44E+02	1.46E+02	1.47E+02
395	1.50E+02	1.55E+02	1.64E+02	1.64E+02	1.41E+02	1.33E+02	1.40E+02
396	1.42E+02	1.68E+02	1.52E+02	1.52E+02	1.56E+02	1.64E+02	1.42E+02
<b>Biased Statistics</b>							
Average Biased	1.47E+02	1.48E+02	1.54E+02	1.48E+02	1.40E+02	1.48E+02	1.52E+02
Std Dev Biased	9.44E+00	8.45E+00	1.29E+01	6.10E+00	7.77E+00	4.75E+00	1.08E+01
Ps90%/90% (+KTL) Biased	1.73E+02	1.71E+02	1.89E+02	1.65E+02	1.61E+02	1.61E+02	1.82E+02
Ps90%/90% (-KTL) Biased	1.21E+02	1.25E+02	1.18E+02	1.31E+02	1.19E+02	1.35E+02	1.23E+02
<b>Un-Biased Statistics</b>							
Average Un-Biased	1.44E+02	1.47E+02	1.45E+02	1.45E+02	1.42E+02	1.44E+02	1.48E+02
Std Dev Un-Biased	5.19E+00	9.03E+00	1.05E+01	1.05E+01	7.98E+00	9.87E+00	1.10E+01
Ps90%/90% (+KTL) Un-Biased	1.58E+02	1.72E+02	1.74E+02	1.74E+02	1.64E+02	1.71E+02	1.78E+02
Ps90%/90% (-KTL) Un-Biased	1.29E+02	1.22E+02	1.16E+02	1.16E+02	1.21E+02	1.17E+02	1.17E+02
<b>Specification MIN</b>	<b>9.60E+01</b>	<b>9.60E+01</b>	<b>9.60E+01</b>	<b>9.60E+01</b>	<b>8.40E+01</b>	<b>8.40E+01</b>	<b>8.40E+01</b>
Status	PASS	PASS	PASS	PASS	PASS	PASS	PASS

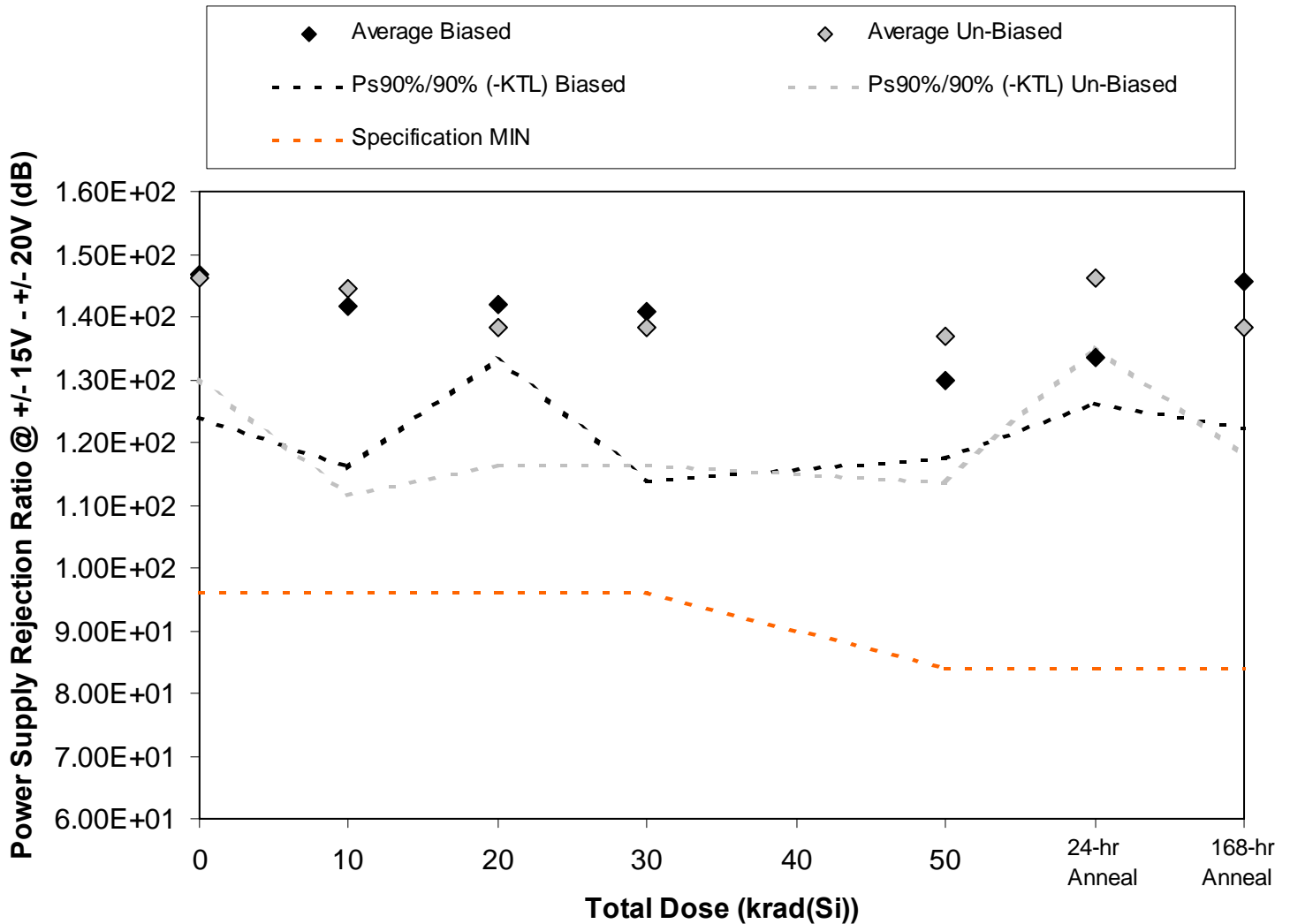

Figure 5.24. Plot of the power supply rejection ratio (PSRR) at  $V_s = \pm 15V$  to  $\pm 20V$  versus total dose. The data show no significant degradation with total dose. The solid diamonds are the average of the measured data points for the sample irradiated under electrical bias while the shaded diamonds are the average of the measured data points for the units irradiated with all pins tied to ground. The black lines (solid or dashed) are the average of the data points after application of the KTL statistics on the sample irradiated in the biased condition while the shaded lines (solid or dashed) are the average of the data points after application of the KTL statistics on the sample irradiated in the unbiased condition. The red dotted line(s) are the pre- and/or post-irradiation minimum and/or maximum specification value as defined in the datasheet and/or test plan.



Table 5.24. Raw data of power supply rejection ratio (PSRR) at  $V_S = \pm 15V$  to  $\pm 20V$  versus total dose, including the statistical analysis, the specification and the status of the testing (pass/fail).

Device	0	10	20	30	50		
386	1.47E+02	1.58E+02	1.42E+02	1.37E+02	1.27E+02	1.32E+02	1.57E+02
387	1.43E+02	1.36E+02	1.42E+02	1.32E+02	1.34E+02	1.35E+02	1.48E+02
388	1.61E+02	1.39E+02	1.46E+02	1.58E+02	1.36E+02	1.37E+02	1.49E+02
389	1.44E+02	1.37E+02	1.38E+02	1.40E+02	1.27E+02	1.30E+02	1.38E+02
390	1.40E+02	1.39E+02	1.41E+02	1.39E+02	1.26E+02	1.34E+02	1.36E+02
391	1.48E+02	1.45E+02	1.50E+02	1.50E+02	1.46E+02	1.50E+02	1.32E+02
392	1.43E+02	1.38E+02	1.40E+02	1.40E+02	1.45E+02	1.51E+02	1.44E+02
393	1.42E+02	1.40E+02	1.39E+02	1.39E+02	1.26E+02	1.44E+02	1.48E+02
394	1.56E+02	1.65E+02	1.34E+02	1.34E+02	1.35E+02	1.43E+02	1.35E+02
395	1.42E+02	1.36E+02	1.28E+02	1.28E+02	1.32E+02	1.43E+02	1.32E+02
396	1.42E+02	1.59E+02	1.43E+02	1.43E+02	1.43E+02	1.46E+02	1.73E+02
<b>Biased Statistics</b>							
Average Biased	1.47E+02	1.42E+02	1.42E+02	1.41E+02	1.30E+02	1.34E+02	1.46E+02
Std Dev Biased	8.37E+00	9.37E+00	3.05E+00	9.84E+00	4.55E+00	2.73E+00	8.53E+00
Ps90%/90% (+KTL) Biased	1.70E+02	1.67E+02	1.50E+02	1.68E+02	1.42E+02	1.41E+02	1.69E+02
Ps90%/90% (-KTL) Biased	1.24E+02	1.16E+02	1.34E+02	1.14E+02	1.17E+02	1.26E+02	1.22E+02
<b>Un-Biased Statistics</b>							
Average Un-Biased	1.46E+02	1.45E+02	1.38E+02	1.38E+02	1.37E+02	1.46E+02	1.38E+02
Std Dev Un-Biased	5.77E+00	1.20E+01	8.07E+00	8.07E+00	8.59E+00	3.99E+00	7.37E+00
Ps90%/90% (+KTL) Un-Biased	1.62E+02	1.77E+02	1.61E+02	1.61E+02	1.61E+02	1.57E+02	1.59E+02
Ps90%/90% (-KTL) Un-Biased	1.30E+02	1.12E+02	1.16E+02	1.16E+02	1.13E+02	1.35E+02	1.18E+02
Specification MIN	9.60E+01	9.60E+01	9.60E+01	9.60E+01	8.40E+01	8.40E+01	8.40E+01
Status	PASS	PASS	PASS	PASS	PASS	PASS	PASS



## **6.0. Summary / Conclusions**

The high dose rate total ionizing dose testing described in this final report was performed using the facilities at Radiation Assured Devices' Longmire Laboratories in Colorado Springs, CO. The high dose rate total ionizing dose (TID) source is a JLSA 84-21 irradiator modified to provide a panoramic exposure. The dose rate for this irradiator in this configuration ranges from  $<1\text{rad(Si)/s}$  to a maximum of approximately  $120\text{rad(Si)/s}$ , determined by the distance from the source. Samples of the RH108AH Operational Amplifier described in this report were irradiated biased with a split 15V supply and unbiased (all leads tied to ground). The devices were irradiated to a maximum total ionizing dose level of  $50\text{krad(Si)}$  with a pre-rad baseline reading as well as incremental readings at 10, 20, and  $30\text{krad(Si)}$ . Electrical testing occurred within one hour following the end of each irradiation segment. For intermediate irradiations, the units were tested and returned to total dose exposure within two hours from the end of the previous radiation increment. In addition, all units-under-test received a 24hr room temperature and 168hr  $100^{\circ}\text{C}$  anneal, using the same bias conditions as the radiation exposure.

The parametric data was obtained as "read and record" and all the raw data plus an attributes summary were presented in this report. The attributes data contains the average, standard deviation and the average with the KTL values applied. The KTL value used was 2.742 per MIL HDBK 814 using one-sided tolerance limits of 90/90 and a 5-piece sample size. Note that the following criteria was used to determine the outcome of the testing: following the radiation exposure each parameter had to pass the specification value and the average value for each five-piece sample must pass the specification value when the KTL limits are applied. If these conditions were not satisfied following the radiation exposure, then the lot would be logged as an RLAT failure.

Based on these criteria, the RH108AH Operational Amplifier discussed in this report passed the TID radiation lot acceptance test to the highest level tested of  $50\text{krad(Si)}$ . The units showed little or no degradation as a function of dose and were consistently within specification including after the application of the KTL statistics. Further, the data in this report can be analyzed along with the low dose rate report titled "Enhanced Low Dose Rate Sensitivity (ELDRS) Radiation Testing of the RH108AH Operational Amplifier for Linear Technology" to demonstrate that these parts do not exhibit ELDRS as defined in the current test method.



## Appendix A: TID Bias Connections

### Biased Samples:

Pin	Function	Bias
1	COMP 1	To Pin 8 Via 30pF Capacitor
2	-INPUT	To Pin 6 Via 10kΩ Resistor
3	+INPUT	8V Via 10kΩ Resistor
4	V-	-15V Decoupled to GND W/ 0.1μF
5	N/C	N/C
6	OUTPUT	To Pin 2 Via 10kΩ Resistor
7	V+	+15V Decoupled to GND W/ 0.1μF
8	COMP 2	To Pin 1 Via 30pF Capacitor

### Unbiased Samples:

Pin	Function	Bias
1	COMP 1	GND
2	-INPUT	GND
3	+INPUT	GND
4	V-	GND
5	N/C	GND
6	OUTPUT	GND
7	V+	GND
8	COMP 2	GND

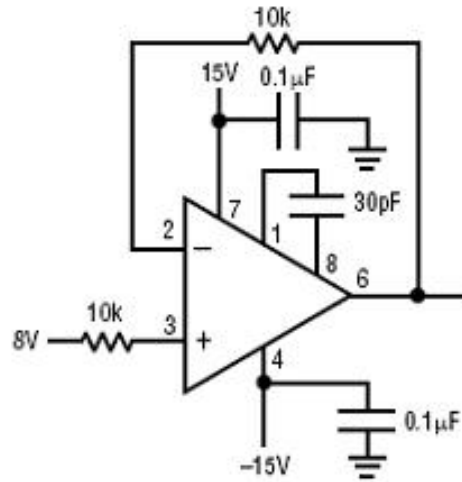

Figure A.1. Irradiation bias drawing for the units to be irradiated under electrical bias. This figure was extracted from the LINEAR TECHNOLOGY CORPORATION RH108A Operational Amplifier Datasheet.

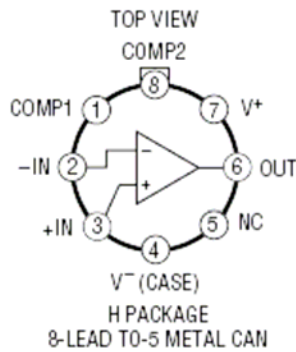

Figure A.2. Package drawing (for reference only). This figure was extracted from the LINEAR TECHNOLOGY CORPORATION RH108A Operational Amplifier Datasheet.



Appendix B: Photograph of device-under-test to show part markings







## **Appendix C: Electrical Test Parameters and Conditions (All Subgroup 1 Parameters plus $A_{VOL}$ )**

All electrical tests for this device are performed on Radiation Assured Device's LTS2020 Test System. The LTS2020 Test System is a programmable parametric tester that provides parameter measurements for a variety of digital, analog and mixed signal products including voltage regulators, Operational Amplifiers, D to A and A to D converters. The LTS2020 Test System achieves accuracy and sensitivity through the use of software self-calibration and an internal relay matrix with separate family boards and custom personality adapter boards. The tester uses this relay matrix to connect the required test circuits, select the appropriate voltage / current sources and establish the needed measurement loops for all the tests performed. The measured parameters and test conditions are shown in Table C.1.

A listing of the measurement precision/resolution for each parameter is shown in Table C.2. The precision/resolution values were obtained either from test data or from the DAC resolution of the LTS-2020. To generate the precision/resolution shown in Table C.2, one of the units-under-test was tested repetitively (a total of 10-times with re-insertion between tests) to obtain the average test value and standard deviation. Using this test data MIL-HDBK-814 90/90 KTL statistics were applied to the measured standard deviation to generate the final measurement range. This value encompasses the precision/resolution of all aspects of the test system, including the LTS2020 mainframe, family board, socket assembly and DUT board as well as insertion error. In some cases, the measurement resolution is limited by the internal DACs, which results in a measured standard deviation of zero. In these instances the precision/resolution will be reported back as the LSB of the DAC.

Note that the testing and statistics used in this document are based on an "analysis of variables" technique, which relies on small sample sizes to qualify much larger lot sizes (see MIL-HDBK-814, p. 91 for a discussion of statistical treatments). Unfortunately, not all measured parameters are well suited to this approach due to inherent large variations. One such parameter is pre-irradiation Open Loop Gain, where the device exhibits extreme sensitivity to input conditions, resulting in a very large standard deviation and a statistical error often greater than the measured value. If necessary, larger samples sizes could be used to qualify these parameters using an "attributes" approach.



Table C.1. Measured parameters and test conditions for the RH108AH (all Subgroup 1 parameters plus  $A_{VOL}$ ) at the  $V_S=\pm 15V$  supply condition, unless otherwise noted, to match the post-irradiation specification. See Note 5 on the Linear Technology RH108 Datasheet for the post irradiation test conditions.

TEST NUMBER	TEST DESCRIPTION	TEST CONDITIONS
1	Positive Supply Current	$V_S=\pm 15V$
2	Negative Supply Current	$V_S=\pm 15V$
3	Input Offset Voltage	$V_S=\pm 15V$
4	Input Offset Current	$V_S=\pm 15V$
5	+ Input Bias Current	$V_S=\pm 15V$
6	- Input Bias Current	$V_S=\pm 15V$
7	Large Signal Voltage Gain	$V_S=\pm 15V$ , $R_L=10k\Omega$ , $V_{OUT} = \pm 10V$
8	Common Mode Rejection Ratio	$V_S=\pm 15V$
9	Power Supply Rejection Ratio	$V_S= \pm 5V$ to $\pm 15V$



Table C.2. Measured parameters, pre-irradiation specifications and measurement resolution for the RH108AH.

<b>Measured Parameter</b>	<b>Pre-Irradiation Specification</b>	<b>Measurement Resolution/Precision</b>
<b>Positive Supply Current</b>	0.6mA	$\pm 8.35E-06A$
<b>Negative Supply Current</b>	0.6mA	$\pm 1.25E-05A$
<b>Input Offset Voltage</b>	0.5mV	$\pm 1.87E-06V$
<b>Input Offset Current</b>	0.2nA	$\pm 4.31E-12A$
<b>+ Input Bias Current</b>	$\pm 2nA$	$\pm 4.74E-12A$
<b>- Input Bias Current</b>	$\pm 2nA$	$\pm 5.01E-12A$
<b>Large Signal Voltage Gain</b>	80V/mV	$\pm 7.77E+02V/mV$
<b>Common Mode Rejection Ratio</b>	96dB	$\pm 9.88E+00dB$
<b>Power Supply Rejection Ratio</b>	96dB	$\pm 1.66E+01dB$