



## ***Radiation Lot Acceptance Testing (RLAT) of the RH117K Positive Adjustable Regulator for Linear Technology***

**Customer:** Linear Technology, PO# 63138L

**RAD Job Number:** 12-508

**Part Type Tested:** RH117K Positive Adjustable Regulator.

**Traceability Information:** Fab Lot Number: W0944174.1, Wafer Number: 7, Assembly Lot Number: 660845.1, Date Code: 1210A. See photograph of unit under test in Appendix A.

**Quantity of Units:** 12 units received, 5 units for biased irradiation, 5 units for unbiased irradiation and 2 units for control. Serial numbers 59, 60, 74, 76 and 77 were biased during irradiation, serial numbers 78, 79, 80, 81 and 82 were unbiased during irradiation and serial numbers 83 and 84 were used as control. See Appendix B for the radiation bias connection table.

**Radiation and Electrical Test Increments:** 50-300rad(Si)/s ionizing radiation with electrical test increments: pre-irradiation, 20krad(Si), 50krad(Si), 100krad(Si) and 200krad(Si). Note that Linear Technology datasheet guarantees post-irradiation performance to only the 100krad(Si) dose level. Testing to 200krad(Si), as reported herein is an overtest of the datasheet guaranteed radiation performance specification.

**Pre-Irradiation Burn-In:** Burn-In performed by Linear Technology prior to receipt by RAD

**Post-Irradiation Anneal:** No anneal.

**Radiation Test Standard:** MIL-STD-750E TM1019 and/or MIL-STD-883H TM1019 Condition A.

**Test Hardware and Software:** LTS2020 Automated Tester, Entity ID TS04, Calibration Date: 4/26/2012, Calibration Due: 4/26/2013. LTS2101 Family Board, Entity ID FB02. LTS0606A Test Fixture, Entity ID TF35. RH117K DUT Board. Test Program: RH117LTK.SRC

**Facility and Radiation Source:** Aeroflex RAD's Longmire Laboratories, Colorado Springs, CO. Gamma rays provided by JLSA 81-24 Co60 source. Dosimetry performed by Air Ionization Chamber (AIC) traceable to NIST. Aeroflex RAD's dosimetry has been audited by DSCC and Aeroflex RAD has been awarded Laboratory Suitability for MIL-STD-750 and MIL-STD-883 TM 1019.

**Irradiation and Test Temperature:** Room temperature controlled to  $24^{\circ}\text{C} \pm 6^{\circ}\text{C}$  per MIL-STD-883 and MIL-STD-750.

**RLAT Result: PASSED. The units-under-test passed the total ionizing dose test to the 100krad(Si) dose level with all parameters remaining within their datasheet specifications.**



## ***1.0. Overview and Background***

It is well known that total dose ionizing radiation can cause parametric degradation and ultimately functional failure in electronic devices. The damage occurs via electron-hole pair production, transport and trapping in the dielectric and interface regions. In discrete devices the bulk of the damage is frequently manifested as a reduction in the gain and/or breakdown voltage of the device. The damage will usually anneal with time following the end of the radiation exposure. Due to this annealing, and to ensure a worst-case test condition MIL-STD-883 TM1019.8 calls out a dose rate of 50 to 300rad(Si)/s as Condition A and further specifies that the time from the end of an incremental radiation exposure and electrical testing shall be 1-hour or less and the total time from the end of one incremental irradiation to the beginning of the next incremental radiation step should be 2-hours or less. The work described in this report was performed to meet MIL-STD-883 TM1019.8 Condition A.

## ***2.0. Radiation Test Apparatus***

The total ionizing dose testing described in this final report was performed using the facilities at Aeroflex RAD's Longmire Laboratories in Colorado Springs, CO. The high dose rate total ionizing dose (TID) source is a JLSA 81-24 irradiator modified to provide a panoramic exposure. The Co-60 rods are held in the base of the irradiator heavily shielded by lead. During the radiation exposures the rod is raised by an electronic timer/controller and the exposure is performed in air. The dose rate for this irradiator in this configuration ranges from <1rad(Si)/s to a maximum of approximately 120rad(Si)/s, determined by the distance from the source. For high-dose rate experiments the bias boards are placed in a radial fashion equidistant from the raised Co-60 rods with the distance adjusted to provide the required dose rate. The irradiator calibration is maintained by Aeroflex RAD Longmire Laboratories using air ionization chamber (AIC) equipment calibrated with traceability to the National Institute of Standards and Technology (NIST). Figure 2.1 shows a photograph of the JLSA 81-24 Co-60 irradiator at Aeroflex RAD's Longmire Laboratory facility.

Aeroflex RAD is currently certified by the Defense Supply Center Columbus (DSCC) for Laboratory Suitability under MIL STD 750 and MIL-STD-883. Additional details regarding Aeroflex RAD dosimetry for TM1019 Condition A testing are available in Aeroflex RAD's report to DSCC entitled: "Dose Rate Mapping of the J.L. Shepherd and Associates Model 81 Irradiator Installed by Radiation Assured Devices".



Figure 2.1. Aeroflex RAD's high dose rate Co-60 irradiator. The dose rate is obtained by positioning the device-under-test at a fixed distance from the gamma cell. The dose rate for this irradiator varies from approximately 120rad(Si)/s close to the rods down to 1rad(Si)/s at a distance of approximately 2-feet.



### **3.0. Radiation Test Conditions**

The RH117K Positive Adjustable Regulator described in this final report were irradiated under two different bias conditions, one when biased with a split 15V supply, and one when unbiased with all pins tied to ground. See the TID Bias Table in Appendix B for the full bias circuits. In our opinion, this bias circuit satisfies the requirements of MIL-STD-883H TM1019.8 Section 3.9.3 Bias and Loading Conditions which states "The bias applied to the test devices shall be selected to produce the greatest radiation induced damage or the worst-case damage for the intended application, if known. While maximum voltage is often worst case some bipolar linear device parameters (e.g. input bias current or maximum output load current) exhibit more degradation with 0 V bias."

The devices were irradiated to a maximum total ionizing dose level of 200krad(Si) with incremental readings at 20krad(Si), 50krad(Si) and 100krad(Si). Electrical testing occurred within one hour following the end of each irradiation segment. For intermediate irradiations, the parts were tested and returned to total dose exposure within two hours from the end of the previous radiation increment.

The TID bias board was positioned in the Co-60 cell to provide the required minimum of 50rad(Si)/s and was located inside a lead-aluminum enclosure. The lead-aluminum enclosure is required under MIL-STD-883H TM1019.8 Section 3.4 that reads as follows: "Lead/Aluminum (Pb/Al) container. Test specimens shall be enclosed in a Pb/Al container to minimize dose enhancement effects caused by low-energy, scattered radiation. A minimum of 1.5 mm Pb, surrounding an inner shield of at least 0.7 mm Al, is required. This Pb/Al container produces an approximate charged particle equilibrium for Si and for TLDs such as CaF<sub>2</sub>. The radiation field intensity shall be measured inside the Pb/Al container (1) initially, (2) when the source is changed, or (3) when the orientation or configuration of the source, container, or test-fixture is changed. This measurement shall be performed by placing a dosimeter (e.g., a TLD) in the device-irradiation container at the approximate test-device position. If it can be demonstrated that low energy scattered radiation is small enough that it will not cause dosimetry errors due to dose enhancement, the Pb/Al container may be omitted."

The final dose rate within the high dose rate lead-aluminum enclosure was determined using calibration calculations based on air ionization chamber (AIC) dosimetry performed just prior to beginning the total dose irradiations. The final dose rate for this work was 192.54rad(Si)/s with a precision of  $\pm 5\%$ .



#### **4.0. Tested Parameters**

During the total ionizing dose characterization testing the following electrical parameters were measured pre- and post-irradiation:

1. Reference Voltage-1 (V) @ VDIFFF=3V IL=10mA
2. Reference Voltage-2 (V) @ VDIFFF=40V IL=10mA
3. Reference Voltage-3 (V) @ VDIFFF=3V IL=0.5A
4. Reference Voltage-4 (V) @ VDIFFF=40V IL=0.15A
5. Line Regulation (%/V) @ VDIFFF=3V TO 40V IL=10mA
6. Load Regulation-1 (V) @ VOUT<=5V IL=10mA TO 0.5A
7. Load Regulation-2 (%) @ VOUT>=5V IL=10mA TO 0.5A
8. Adjust Pin Current-1 (A) @ VDIFFF=2.5V IL=10mA
9. Adjust Pin Current-2 (A) @ VDIFFF=5V IL=10mA
10. Adjust Pin Current-3 (A) @ VDIFFF=40V IL=10mA
11. Adjust Pin Current Change-1 (A) @ VDIFFF=5V IL=10mA TO 0.5A
12. Adjust Pin Current Change-2 (A) @ VDIFFF=2.5V TO 40V IL=10mA
13. Minimum Load Current (A) @ VDIFFF=40V
14. Current Limit-1 (A) @ VIN-VOUT=15V
15. Current Limit-2 (A) @ VIN-VOUT=40V

Appendix C details the measured parameters, test conditions, pre-irradiation specification and measurement resolution for each of the measurements.

The parametric data was obtained as "read and record" and all the raw data plus an attributes summary are contained in this report as well as in a separate Excel file. The attributes data contains the average, standard deviation and the average with the KTL values applied. The KTL value used in this work is 2.742 per MIL-HDBK-814 using one sided tolerance limits of 90/90 and a 5-piece sample size. The 90/90 KTL values were selected to match the statistical levels specified in the MIL-PRF-38535 sampling plan for the qualification of a radiation hardness assured (RHA) component. Note that the following criteria must be met for a device to pass the total ionizing dose test: following the radiation exposure each of the 5 pieces irradiated under electrical bias shall pass the specification value. The units irradiated without electrical bias and the KTL statistics are included in this report for reference only. If any of the 5 pieces irradiated under electrical bias exceed the device post radiation data sheet specification limits, then the lot could be logged as a failure.



### **5.0. Total Ionizing Dose Test Results**

Based on this criterion the RH117K Positive Adjustable Regulator (from the lot traceability information provided on the first page of this test report) PASSED the total ionizing dose test to the 100krad(Si) dose level with all parameters remaining within their datasheet specifications. Note that the LINEAR TECHNOLOGY datasheet guarantees post-irradiation performance only to the 100krad(Si) dose level and data shown here at 200krad(Si) is for reference only.

Figures 5.1 through 5.15 show plots of all the measured parameters versus total ionizing dose while Tables 5.1 - 5.15 show the corresponding raw data for each of these parameters. In the data plots the solid diamonds are the average of the measured data points for the sample irradiated under electrical bias while the shaded diamonds are the average of the measured data points for the units irradiated with all pins tied to ground. The black lines (solid or dashed) are the average of the data points after application of the KTL statistics on the sample irradiated in the biased condition while the shaded lines (solid or dashed) are the average of the data points after application of the KTL statistics on the sample irradiated in the unbiased condition. The red dotted line(s) are the pre- and/or post-irradiation minimum and/or maximum specification value as defined in the datasheet and/or test plan.

The control units, as expected, show no significant changes to any of the parameters. Therefore we can conclude that the electrical testing remained in control throughout the duration of the tests and the observed degradation was due to the radiation exposure. Appendix D lists the figures used in this section to facilitate the location of a particular parameter.

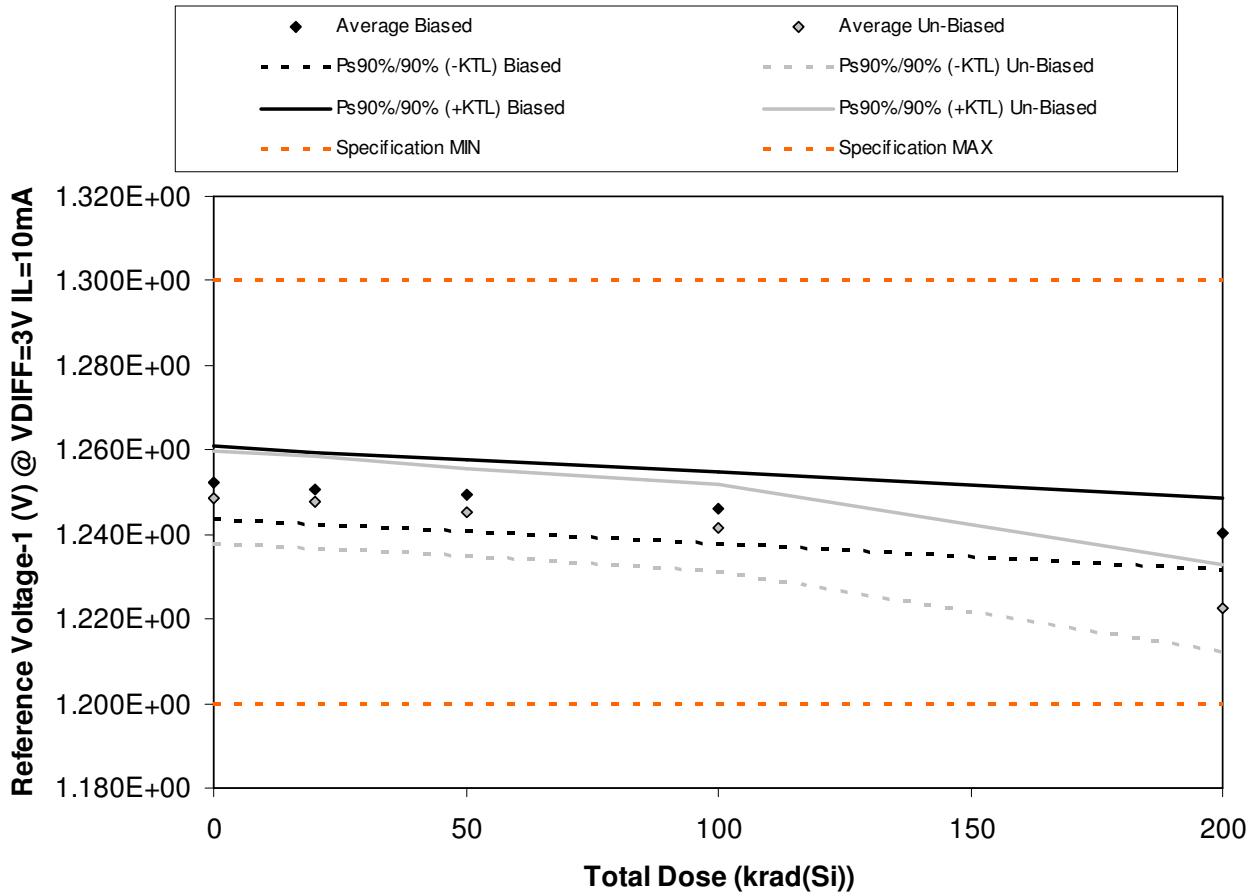

Figure 5.1. Plot of Reference Voltage-1 (V) @ VDIFF=3V IL=10mA versus total dose. The solid diamonds are the average of the measured data points for the samples irradiated under electrical bias while the shaded diamonds are the average of the measured data points for the samples irradiated with all pins tied to ground. The black lines (solid and/or dashed) are the average of the data points after application of the KTL statistics on the samples irradiated under electrical bias while the gray lines (solid and/or dashed) are the average of the data points after application of the KTL statistics on the samples irradiated in the unbiased condition. The red dotted line(s) are the pre- and/or post-irradiation minimum and/or maximum specification value as defined in the datasheet and/or test plan.



**TID Report**  
**12-508 120615 R1.0**

**Aeroflex RAD**  
**5017 N. 30th Street**  
**Colorado Springs, CO 80919**  
**(719) 531-0800**

Table 5.1. Raw data for Reference Voltage-1 (V) @ VDIFF=3V IL=10mA versus total dose, including the statistical analysis, specification and the status of the testing (pass/fail).

| Reference Voltage-1 (V) @<br>VDIFF=3V IL=10mA | Total Dose (krad(Si)) |                 |                 |                 |           |
|---|-----------------------|-----------------|-----------------|-----------------|-----------|
|   | 6/8/2012              | 6/14/2012       | 6/14/2012       | 6/14/2012       | 6/14/2012 |
| Device  | 0                     | 20              | 50              | 100             | 200       |
| 59  | 1.256E+00             | 1.255E+00       | 1.253E+00       | 1.250E+00       | 1.244E+00 |
| 60  | 1.255E+00             | 1.253E+00       | 1.252E+00       | 1.249E+00       | 1.243E+00 |
| 74  | 1.251E+00             | 1.250E+00       | 1.248E+00       | 1.245E+00       | 1.239E+00 |
| 76  | 1.249E+00             | 1.248E+00       | 1.247E+00       | 1.244E+00       | 1.238E+00 |
| 77  | 1.250E+00             | 1.248E+00       | 1.246E+00       | 1.243E+00       | 1.237E+00 |
| 78  | 1.251E+00             | 1.250E+00       | 1.248E+00       | 1.244E+00       | 1.224E+00 |
| 79  | 1.248E+00             | 1.247E+00       | 1.245E+00       | 1.241E+00       | 1.223E+00 |
| 80  | 1.250E+00             | 1.249E+00       | 1.247E+00       | 1.243E+00       | 1.225E+00 |
| 81  | 1.252E+00             | 1.251E+00       | 1.248E+00       | 1.244E+00       | 1.225E+00 |
| 82  | 1.242E+00             | 1.241E+00       | 1.239E+00       | 1.235E+00       | 1.216E+00 |
| 83  | 1.241E+00             | 1.242E+00       | 1.242E+00       | 1.242E+00       | 1.241E+00 |
| 84  | 1.244E+00             | 1.244E+00       | 1.244E+00       | 1.244E+00       | 1.244E+00 |
| <b>Biased Statistics</b>                      |                       |                 |                 |                 |           |
| Average Biased                                | 1.252E+00             | 1.251E+00       | 1.249E+00       | 1.246E+00       | 1.240E+00 |
| Std Dev Biased                                | 3.11E-03              | 3.11E-03        | 3.11E-03        | 3.11E-03        | 3.11E-03  |
| Ps90%/90% (+KTL) Biased                       | 1.261E+00             | 1.259E+00       | 1.258E+00       | 1.255E+00       | 1.249E+00 |
| Ps90%/90% (-KTL) Biased                       | 1.244E+00             | 1.242E+00       | 1.241E+00       | 1.238E+00       | 1.232E+00 |
| <b>Un-Biased Statistics</b>                   |                       |                 |                 |                 |           |
| Average Un-Biased                             | 1.249E+00             | 1.248E+00       | 1.245E+00       | 1.241E+00       | 1.223E+00 |
| Std Dev Un-Biased                             | 3.97E-03              | 3.97E-03        | 3.78E-03        | 3.78E-03        | 3.78E-03  |
| Ps90%/90% (+KTL) Un-Biased                    | 1.259E+00             | 1.258E+00       | 1.256E+00       | 1.252E+00       | 1.233E+00 |
| Ps90%/90% (-KTL) Un-Biased                    | 1.238E+00             | 1.237E+00       | 1.235E+00       | 1.231E+00       | 1.212E+00 |
| <b>Specification MIN</b>                      | <b>1.20E+00</b>       | <b>1.20E+00</b> | <b>1.20E+00</b> | <b>1.20E+00</b> |           |
| Status  | PASS                  | PASS            | PASS            | PASS            |           |
| <b>Specification MAX</b>                      | <b>1.30E+00</b>       | <b>1.30E+00</b> | <b>1.30E+00</b> | <b>1.30E+00</b> |           |
| Status  | PASS                  | PASS            | PASS            | PASS            |           |



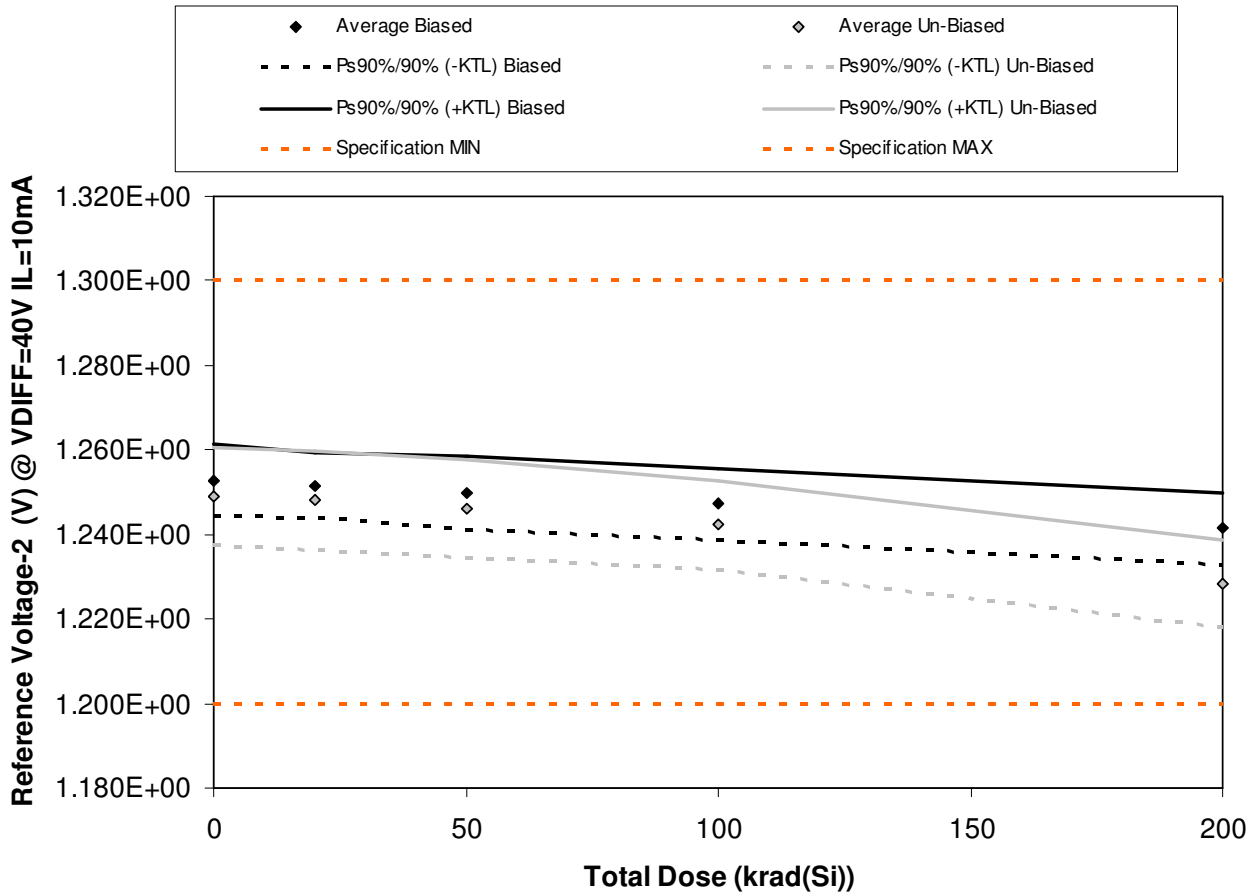

Figure 5.2. Plot of Reference Voltage-2 (V) @ VDIF=40V IL=10mA versus total dose. The solid diamonds are the average of the measured data points for the samples irradiated under electrical bias while the shaded diamonds are the average of the measured data points for the samples irradiated with all pins tied to ground. The black lines (solid and/or dashed) are the average of the data points after application of the KTL statistics on the samples irradiated under electrical bias while the gray lines (solid and/or dashed) are the average of the data points after application of the KTL statistics on the samples irradiated in the unbiased condition. The red dotted line(s) are the pre- and/or post-irradiation minimum and/or maximum specification value as defined in the datasheet and/or test plan.



**TID Report  
12-508 120615 R1.0**

**Aeroflex RAD  
5017 N. 30th Street  
Colorado Springs, CO 80919  
(719) 531-0800**

Table 5.2. Raw data for Reference Voltage-2 (V) @ VDIFF=40V IL=10mA versus total dose, including the statistical analysis, specification and the status of the testing (pass/fail).

| Reference Voltage-2 (V) @<br>VDIFF=40V IL=10mA | Total Dose (krad(Si)) |                 |                 |                 |           |
|--|-----------------------|-----------------|-----------------|-----------------|-----------|
|  | 6/8/2012              | 6/14/2012       | 6/14/2012       | 6/14/2012       | 6/14/2012 |
| Device   | 0                     | 20              | 50              | 100             | 200       |
| 59   | 1.257E+00             | 1.255E+00       | 1.254E+00       | 1.251E+00       | 1.245E+00 |
| 60   | 1.255E+00             | 1.254E+00       | 1.252E+00       | 1.250E+00       | 1.244E+00 |
| 74   | 1.252E+00             | 1.251E+00       | 1.249E+00       | 1.246E+00       | 1.241E+00 |
| 76   | 1.250E+00             | 1.249E+00       | 1.247E+00       | 1.245E+00       | 1.239E+00 |
| 77   | 1.250E+00             | 1.249E+00       | 1.247E+00       | 1.244E+00       | 1.238E+00 |
| 78   | 1.252E+00             | 1.251E+00       | 1.249E+00       | 1.245E+00       | 1.230E+00 |
| 79   | 1.248E+00             | 1.247E+00       | 1.245E+00       | 1.241E+00       | 1.228E+00 |
| 80   | 1.251E+00             | 1.250E+00       | 1.248E+00       | 1.244E+00       | 1.231E+00 |
| 81   | 1.252E+00             | 1.251E+00       | 1.249E+00       | 1.245E+00       | 1.231E+00 |
| 82   | 1.242E+00             | 1.241E+00       | 1.239E+00       | 1.236E+00       | 1.222E+00 |
| 83   | 1.242E+00             | 1.242E+00       | 1.242E+00       | 1.242E+00       | 1.242E+00 |
| 84   | 1.244E+00             | 1.244E+00       | 1.244E+00       | 1.244E+00       | 1.244E+00 |
| <b>Biased Statistics</b>                       |                       |                 |                 |                 |           |
| Average Biased                                 | 1.253E+00             | 1.252E+00       | 1.250E+00       | 1.247E+00       | 1.241E+00 |
| Std Dev Biased                                 | 3.11E-03              | 2.79E-03        | 3.11E-03        | 3.11E-03        | 3.05E-03  |
| Ps90%/90% (+KTL) Biased                        | 1.261E+00             | 1.259E+00       | 1.258E+00       | 1.256E+00       | 1.250E+00 |
| Ps90%/90% (-KTL) Biased                        | 1.244E+00             | 1.244E+00       | 1.241E+00       | 1.239E+00       | 1.233E+00 |
| <b>Un-Biased Statistics</b>                    |                       |                 |                 |                 |           |
| Average Un-Biased                              | 1.249E+00             | 1.248E+00       | 1.246E+00       | 1.242E+00       | 1.228E+00 |
| Std Dev Un-Biased                              | 4.24E-03              | 4.24E-03        | 4.24E-03        | 3.83E-03        | 3.78E-03  |
| Ps90%/90% (+KTL) Un-Biased                     | 1.261E+00             | 1.260E+00       | 1.258E+00       | 1.253E+00       | 1.239E+00 |
| Ps90%/90% (-KTL) Un-Biased                     | 1.237E+00             | 1.236E+00       | 1.234E+00       | 1.232E+00       | 1.218E+00 |
| <b>Specification MIN</b>                       | <b>1.20E+00</b>       | <b>1.20E+00</b> | <b>1.20E+00</b> | <b>1.20E+00</b> |           |
| Status   | PASS                  | PASS            | PASS            | PASS            |           |
| <b>Specification MAX</b>                       | <b>1.30E+00</b>       | <b>1.30E+00</b> | <b>1.30E+00</b> | <b>1.30E+00</b> |           |
| Status   | PASS                  | PASS            | PASS            | PASS            |           |

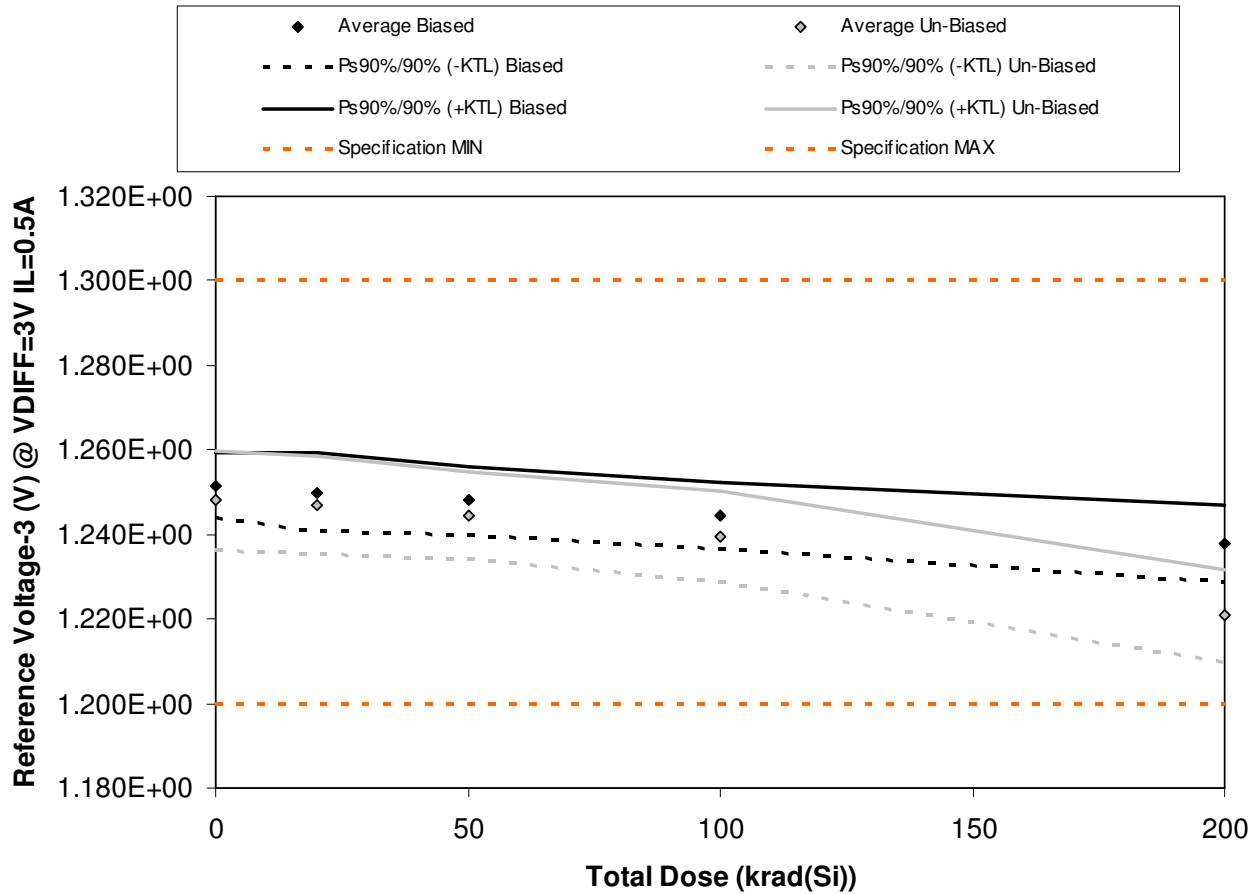

Figure 5.3. Plot of Reference Voltage-3 (V) @ VDIFF=3V IL=0.5A versus total dose. The solid diamonds are the average of the measured data points for the samples irradiated under electrical bias while the shaded diamonds are the average of the measured data points for the samples irradiated with all pins tied to ground. The black lines (solid and/or dashed) are the average of the data points after application of the KTL statistics on the samples irradiated under electrical bias while the gray lines (solid and/or dashed) are the average of the data points after application of the KTL statistics on the samples irradiated in the unbiased condition. The red dotted line(s) are the pre- and/or post-irradiation minimum and/or maximum specification value as defined in the datasheet and/or test plan.



**TID Report  
12-508 120615 R1.0**

**Aeroflex RAD  
5017 N. 30th Street  
Colorado Springs, CO 80919  
(719) 531-0800**

Table 5.3. Raw data for Reference Voltage-3 (V) @ VDIFF=3V IL=0.5A versus total dose, including the statistical analysis, specification and the status of the testing (pass/fail).

| Reference Voltage-3 (V) @<br>VDIFF=3V IL=0.5A | Total Dose (krad(Si)) |                 |                 |                 |           |
|---|-----------------------|-----------------|-----------------|-----------------|-----------|
|   | 6/8/2012              | 6/14/2012       | 6/14/2012       | 6/14/2012       | 6/14/2012 |
| Device  | 0                     | 20              | 50              | 100             | 200       |
| 59  | 1.255E+00             | 1.254E+00       | 1.252E+00       | 1.248E+00       | 1.242E+00 |
| 60  | 1.254E+00             | 1.253E+00       | 1.250E+00       | 1.247E+00       | 1.241E+00 |
| 74  | 1.251E+00             | 1.249E+00       | 1.247E+00       | 1.243E+00       | 1.237E+00 |
| 76  | 1.249E+00             | 1.247E+00       | 1.245E+00       | 1.242E+00       | 1.235E+00 |
| 77  | 1.249E+00             | 1.247E+00       | 1.246E+00       | 1.242E+00       | 1.235E+00 |
| 78  | 1.251E+00             | 1.250E+00       | 1.247E+00       | 1.242E+00       | 1.222E+00 |
| 79  | 1.247E+00             | 1.246E+00       | 1.244E+00       | 1.239E+00       | 1.221E+00 |
| 80  | 1.250E+00             | 1.249E+00       | 1.246E+00       | 1.242E+00       | 1.223E+00 |
| 81  | 1.251E+00             | 1.250E+00       | 1.247E+00       | 1.242E+00       | 1.224E+00 |
| 82  | 1.241E+00             | 1.240E+00       | 1.238E+00       | 1.233E+00       | 1.214E+00 |
| 83  | 1.241E+00             | 1.241E+00       | 1.241E+00       | 1.241E+00       | 1.241E+00 |
| 84  | 1.242E+00             | 1.243E+00       | 1.243E+00       | 1.243E+00       | 1.243E+00 |
| <b>Biased Statistics</b>                      |                       |                 |                 |                 |           |
| Average Biased                                | 1.252E+00             | 1.250E+00       | 1.248E+00       | 1.244E+00       | 1.238E+00 |
| Std Dev Biased                                | 2.79E-03              | 3.32E-03        | 2.92E-03        | 2.88E-03        | 3.32E-03  |
| Ps90%/90% (+KTL) Biased                       | 1.259E+00             | 1.259E+00       | 1.256E+00       | 1.252E+00       | 1.247E+00 |
| Ps90%/90% (-KTL) Biased                       | 1.244E+00             | 1.241E+00       | 1.240E+00       | 1.237E+00       | 1.229E+00 |
| <b>Un-Biased Statistics</b>                   |                       |                 |                 |                 |           |
| Average Un-Biased                             | 1.248E+00             | 1.247E+00       | 1.244E+00       | 1.240E+00       | 1.221E+00 |
| Std Dev Un-Biased                             | 4.24E-03              | 4.24E-03        | 3.78E-03        | 3.91E-03        | 3.96E-03  |
| Ps90%/90% (+KTL) Un-Biased                    | 1.260E+00             | 1.259E+00       | 1.255E+00       | 1.250E+00       | 1.232E+00 |
| Ps90%/90% (-KTL) Un-Biased                    | 1.236E+00             | 1.235E+00       | 1.234E+00       | 1.229E+00       | 1.210E+00 |
| <b>Specification MIN</b>                      | <b>1.20E+00</b>       | <b>1.20E+00</b> | <b>1.20E+00</b> | <b>1.20E+00</b> |           |
| Status  | PASS                  | PASS            | PASS            | PASS            |           |
| <b>Specification MAX</b>                      | <b>1.30E+00</b>       | <b>1.30E+00</b> | <b>1.30E+00</b> | <b>1.30E+00</b> |           |
| Status  | PASS                  | PASS            | PASS            | PASS            |           |

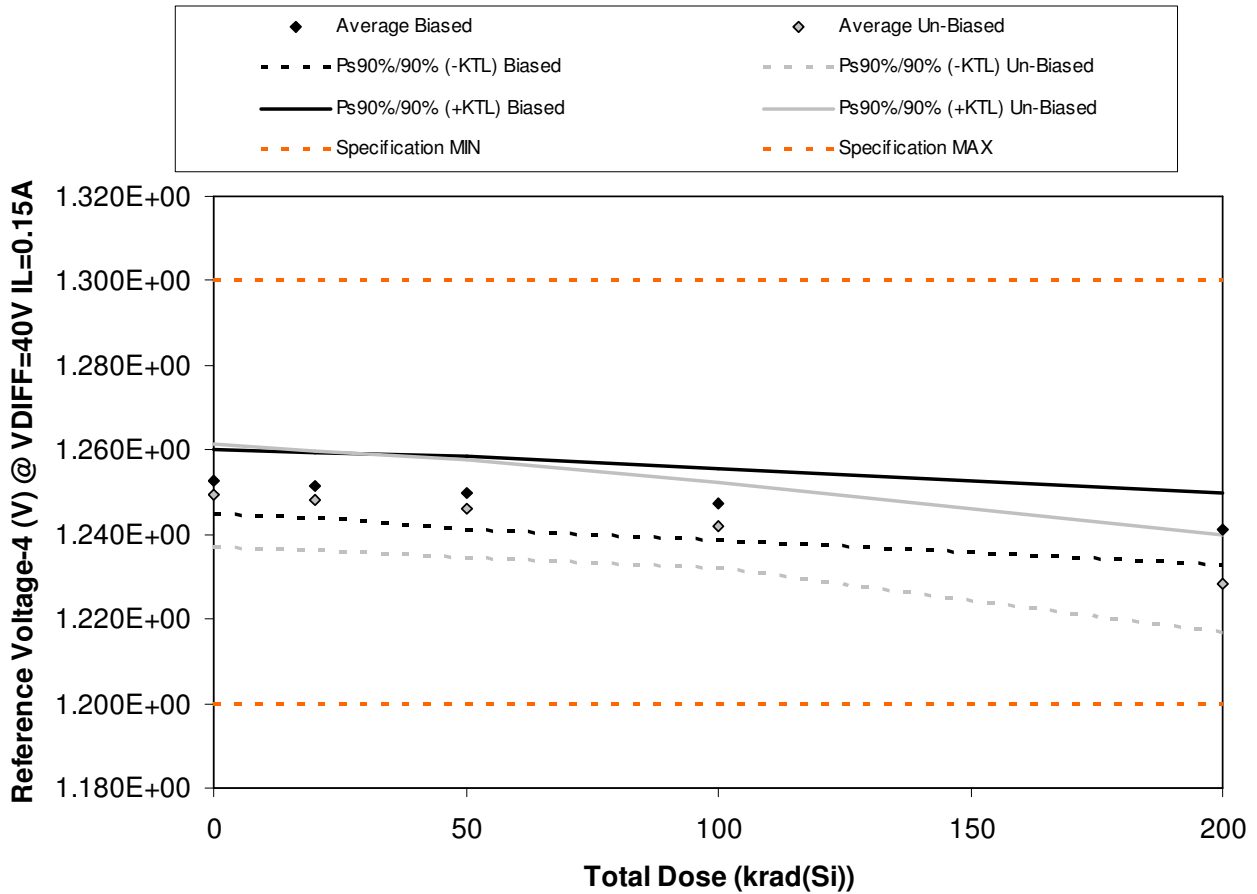

Figure 5.4. Plot of Reference Voltage-4 (V) @ VDIFF=40V IL=0.15A versus total dose. The solid diamonds are the average of the measured data points for the samples irradiated under electrical bias while the shaded diamonds are the average of the measured data points for the samples irradiated with all pins tied to ground. The black lines (solid and/or dashed) are the average of the data points after application of the KTL statistics on the samples irradiated under electrical bias while the gray lines (solid and/or dashed) are the average of the data points after application of the KTL statistics on the samples irradiated in the unbiased condition. The red dotted line(s) are the pre- and/or post-irradiation minimum and/or maximum specification value as defined in the datasheet and/or test plan.



**TID Report  
12-508 120615 R1.0**

**Aeroflex RAD  
5017 N. 30th Street  
Colorado Springs, CO 80919  
(719) 531-0800**

Table 5.4. Raw data for Reference Voltage-4 (V) @ VDIFF=40V IL=0.15A versus total dose, including the statistical analysis, specification and the status of the testing (pass/fail).

| Reference Voltage-4 (V) @<br>VDIFF=40V IL=0.15A | Total Dose (krad(Si)) |                 |                 |                 |           |
|---|-----------------------|-----------------|-----------------|-----------------|-----------|
|   | 6/8/2012              | 6/14/2012       | 6/14/2012       | 6/14/2012       | 6/14/2012 |
| Device  | 0                     | 20              | 50              | 100             | 200       |
| 59  | 1.256E+00             | 1.255E+00       | 1.254E+00       | 1.251E+00       | 1.245E+00 |
| 60  | 1.255E+00             | 1.254E+00       | 1.252E+00       | 1.250E+00       | 1.244E+00 |
| 74  | 1.252E+00             | 1.251E+00       | 1.249E+00       | 1.246E+00       | 1.240E+00 |
| 76  | 1.250E+00             | 1.249E+00       | 1.247E+00       | 1.245E+00       | 1.239E+00 |
| 77  | 1.250E+00             | 1.249E+00       | 1.247E+00       | 1.244E+00       | 1.238E+00 |
| 78  | 1.252E+00             | 1.251E+00       | 1.249E+00       | 1.244E+00       | 1.230E+00 |
| 79  | 1.248E+00             | 1.247E+00       | 1.245E+00       | 1.241E+00       | 1.228E+00 |
| 80  | 1.251E+00             | 1.250E+00       | 1.248E+00       | 1.244E+00       | 1.231E+00 |
| 81  | 1.253E+00             | 1.251E+00       | 1.249E+00       | 1.245E+00       | 1.231E+00 |
| 82  | 1.242E+00             | 1.241E+00       | 1.239E+00       | 1.236E+00       | 1.221E+00 |
| 83  | 1.242E+00             | 1.242E+00       | 1.242E+00       | 1.242E+00       | 1.242E+00 |
| 84  | 1.244E+00             | 1.245E+00       | 1.244E+00       | 1.244E+00       | 1.244E+00 |
| <b>Biased Statistics</b>                        |                       |                 |                 |                 |           |
| Average Biased                                  | 1.253E+00             | 1.252E+00       | 1.250E+00       | 1.247E+00       | 1.241E+00 |
| Std Dev Biased                                  | 2.79E-03              | 2.79E-03        | 3.11E-03        | 3.11E-03        | 3.11E-03  |
| Ps90%/90% (+KTL) Biased                         | 1.260E+00             | 1.259E+00       | 1.258E+00       | 1.256E+00       | 1.250E+00 |
| Ps90%/90% (-KTL) Biased                         | 1.245E+00             | 1.244E+00       | 1.241E+00       | 1.239E+00       | 1.233E+00 |
| <b>Un-Biased Statistics</b>                     |                       |                 |                 |                 |           |
| Average Un-Biased                               | 1.249E+00             | 1.248E+00       | 1.246E+00       | 1.242E+00       | 1.228E+00 |
| Std Dev Un-Biased                               | 4.44E-03              | 4.24E-03        | 4.24E-03        | 3.67E-03        | 4.21E-03  |
| Ps90%/90% (+KTL) Un-Biased                      | 1.261E+00             | 1.260E+00       | 1.258E+00       | 1.252E+00       | 1.240E+00 |
| Ps90%/90% (-KTL) Un-Biased                      | 1.237E+00             | 1.236E+00       | 1.234E+00       | 1.232E+00       | 1.217E+00 |
| <b>Specification MIN</b>                        | <b>1.20E+00</b>       | <b>1.20E+00</b> | <b>1.20E+00</b> | <b>1.20E+00</b> |           |
| Status  | PASS                  | PASS            | PASS            | PASS            |           |
| <b>Specification MAX</b>                        | <b>1.30E+00</b>       | <b>1.30E+00</b> | <b>1.30E+00</b> | <b>1.30E+00</b> |           |
| Status  | PASS                  | PASS            | PASS            | PASS            |           |

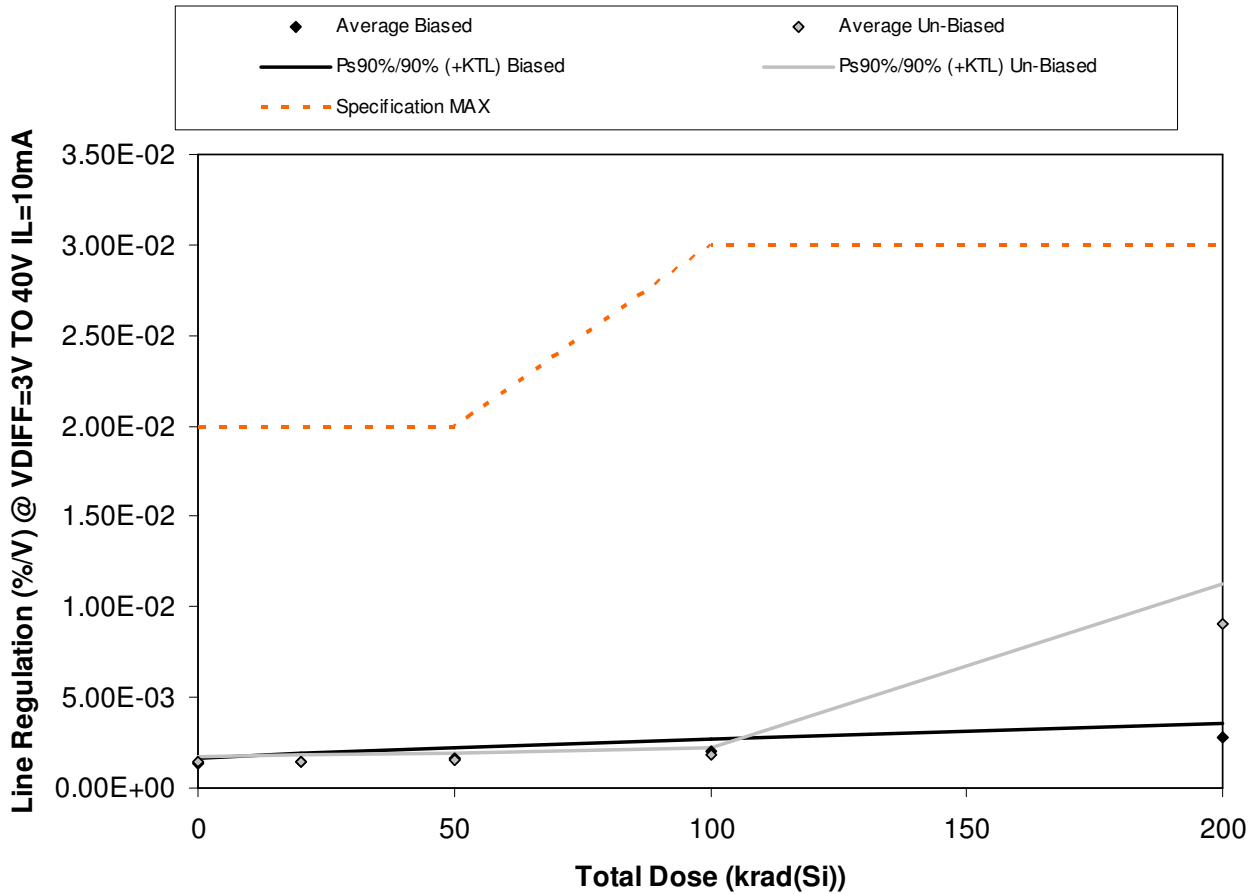

Figure 5.5. Plot of Line Regulation (%/V) @ VDIFF=3V TO 40V IL=10mA versus total dose. The solid diamonds are the average of the measured data points for the samples irradiated under electrical bias while the shaded diamonds are the average of the measured data points for the samples irradiated with all pins tied to ground. The black lines (solid and/or dashed) are the average of the data points after application of the KTL statistics on the samples irradiated under electrical bias while the gray lines (solid and/or dashed) are the average of the data points after application of the KTL statistics on the samples irradiated in the unbiased condition. The red dotted line(s) are the pre- and/or post-irradiation minimum and/or maximum specification value as defined in the datasheet and/or test plan.



**TID Report  
12-508 120615 R1.0**

**Aeroflex RAD  
5017 N. 30th Street  
Colorado Springs, CO 80919  
(719) 531-0800**

Table 5.5. Raw data for Line Regulation (%/V) @ VDIFF=3V TO 40V IL=10mA versus total dose, including the statistical analysis, specification and the status of the testing (pass/fail).

| Line Regulation (%/V) @<br>VDIFF=3V TO 40V IL=10mA | Total Dose (krad(Si)) |                 |                 |                 |           |
|--|-----------------------|-----------------|-----------------|-----------------|-----------|
|  | 6/8/2012              | 6/14/2012       | 6/14/2012       | 6/14/2012       | 6/14/2012 |
| Device   | 0                     | 20              | 50              | 100             | 200       |
| 59   | 1.30E-03              | 1.40E-03        | 1.50E-03        | 1.80E-03        | 2.70E-03  |
| 60   | 1.30E-03              | 1.20E-03        | 1.30E-03        | 1.60E-03        | 2.30E-03  |
| 74   | 1.40E-03              | 1.40E-03        | 1.70E-03        | 2.10E-03        | 2.80E-03  |
| 76   | 1.40E-03              | 1.60E-03        | 1.90E-03        | 2.30E-03        | 3.10E-03  |
| 77   | 1.50E-03              | 1.60E-03        | 1.70E-03        | 2.10E-03        | 2.90E-03  |
| 78   | 1.50E-03              | 1.60E-03        | 1.50E-03        | 1.90E-03        | 9.70E-03  |
| 79   | 1.60E-03              | 1.50E-03        | 1.50E-03        | 2.00E-03        | 8.10E-03  |
| 80   | 1.40E-03              | 1.50E-03        | 1.80E-03        | 2.00E-03        | 9.20E-03  |
| 81   | 1.40E-03              | 1.40E-03        | 1.50E-03        | 1.80E-03        | 9.90E-03  |
| 82   | 1.30E-03              | 1.20E-03        | 1.40E-03        | 1.70E-03        | 8.20E-03  |
| 83   | 1.30E-03              | 1.30E-03        | 1.40E-03        | 1.50E-03        | 1.40E-03  |
| 84   | 1.40E-03              | 1.30E-03        | 1.40E-03        | 1.30E-03        | 1.40E-03  |
| <b>Biased Statistics</b>                           |                       |                 |                 |                 |           |
| Average Biased                                     | 1.38E-03              | 1.44E-03        | 1.62E-03        | 1.98E-03        | 2.76E-03  |
| Std Dev Biased                                     | 8.37E-05              | 1.67E-04        | 2.28E-04        | 2.77E-04        | 2.97E-04  |
| Ps90%/90% (+KTL) Biased                            | 1.61E-03              | 1.90E-03        | 2.25E-03        | 2.74E-03        | 3.57E-03  |
| Ps90%/90% (-KTL) Biased                            | 1.15E-03              | 9.81E-04        | 9.95E-04        | 1.22E-03        | 1.95E-03  |
| <b>Un-Biased Statistics</b>                        |                       |                 |                 |                 |           |
| Average Un-Biased                                  | 1.44E-03              | 1.44E-03        | 1.54E-03        | 1.88E-03        | 9.02E-03  |
| Std Dev Un-Biased                                  | 1.14E-04              | 1.52E-04        | 1.52E-04        | 1.30E-04        | 8.35E-04  |
| Ps90%/90% (+KTL) Un-Biased                         | 1.75E-03              | 1.86E-03        | 1.96E-03        | 2.24E-03        | 1.13E-02  |
| Ps90%/90% (-KTL) Un-Biased                         | 1.13E-03              | 1.02E-03        | 1.12E-03        | 1.52E-03        | 6.73E-03  |
| <b>Specification MAX</b>                           | <b>2.00E-02</b>       | <b>2.00E-02</b> | <b>2.00E-02</b> | <b>3.00E-02</b> |           |
| Status   | PASS                  | PASS            | PASS            | PASS            |           |



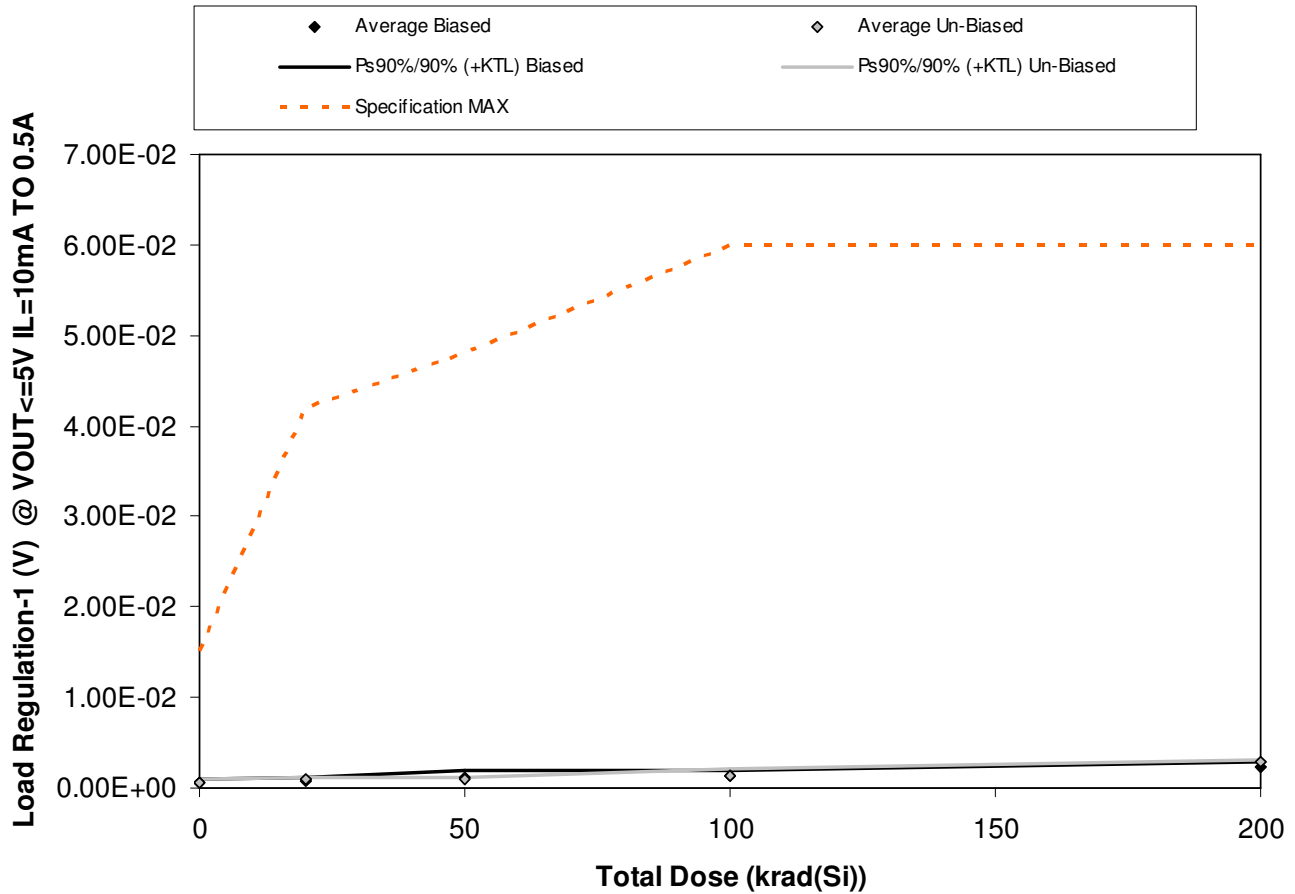

Figure 5.6. Plot of Load Regulation-1 (V) @ VOUT<=5V IL=10mA TO 0.5A versus total dose. The solid diamonds are the average of the measured data points for the samples irradiated under electrical bias while the shaded diamonds are the average of the measured data points for the samples irradiated with all pins tied to ground. The black lines (solid and/or dashed) are the average of the data points after application of the KTL statistics on the samples irradiated under electrical bias while the gray lines (solid and/or dashed) are the average of the data points after application of the KTL statistics on the samples irradiated in the unbiased condition. The red dotted line(s) are the pre- and/or post-irradiation minimum and/or maximum specification value as defined in the datasheet and/or test plan.



**TID Report  
12-508 120615 R1.0**

**Aeroflex RAD  
5017 N. 30th Street  
Colorado Springs, CO 80919  
(719) 531-0800**

Table 5.6. Raw data for Load Regulation-1 (V) @ VOUT<=5V IL=10mA TO 0.5A versus total dose, including the statistical analysis, specification and the status of the testing (pass/fail).

| Load Regulation-1 (V) @<br>VOUT<=5V IL=10mA TO 0.5A | Total Dose (krad(Si)) |                 |                 |                 |           |
|---|-----------------------|-----------------|-----------------|-----------------|-----------|
|   | 6/8/2012              | 6/14/2012       | 6/14/2012       | 6/14/2012       | 6/14/2012 |
| Device  | 0                     | 20              | 50              | 100             | 200       |
| 59  | 5.15E-04              | 8.54E-04        | 1.59E-03        | 1.51E-03        | 2.36E-03  |
| 60  | 3.45E-04              | 7.83E-04        | 8.41E-04        | 1.59E-03        | 2.09E-03  |
| 74  | 5.71E-04              | 8.25E-04        | 1.28E-03        | 1.43E-03        | 2.19E-03  |
| 76  | 7.21E-04              | 3.82E-04        | 7.92E-04        | 1.25E-03        | 2.39E-03  |
| 77  | 3.40E-04              | 6.67E-04        | 1.01E-03        | 1.00E-03        | 2.65E-03  |
| 78  | 4.23E-04              | 9.26E-04        | 8.99E-04        | 1.50E-03        | 2.80E-03  |
| 79  | 6.20E-04              | 8.84E-04        | 9.20E-04        | 1.25E-03        | 2.67E-03  |
| 80  | 5.78E-04              | 6.84E-04        | 9.95E-04        | 1.28E-03        | 2.73E-03  |
| 81  | 7.07E-04              | 8.29E-04        | 9.87E-04        | 1.08E-03        | 2.85E-03  |
| 82  | 6.60E-04              | 1.04E-03        | 1.02E-03        | 1.79E-03        | 2.99E-03  |
| 83  | 5.34E-04              | 3.30E-04        | 5.84E-04        | 3.50E-04        | 8.07E-04  |
| 84  | 9.53E-04              | 5.12E-04        | 8.27E-04        | 6.15E-04        | 7.75E-04  |
| <b>Biased Statistics</b>                            |                       |                 |                 |                 |           |
| Average Biased                                      | 4.98E-04              | 7.02E-04        | 1.10E-03        | 1.35E-03        | 2.34E-03  |
| Std Dev Biased                                      | 1.61E-04              | 1.93E-04        | 3.34E-04        | 2.35E-04        | 2.17E-04  |
| Ps90%/90% (+KTL) Biased                             | 9.40E-04              | 1.23E-03        | 2.02E-03        | 2.00E-03        | 2.93E-03  |
| Ps90%/90% (-KTL) Biased                             | 5.69E-05              | 1.74E-04        | 1.87E-04        | 7.11E-04        | 1.74E-03  |
| <b>Un-Biased Statistics</b>                         |                       |                 |                 |                 |           |
| Average Un-Biased                                   | 5.98E-04              | 8.72E-04        | 9.65E-04        | 1.38E-03        | 2.81E-03  |
| Std Dev Un-Biased                                   | 1.09E-04              | 1.30E-04        | 5.30E-05        | 2.73E-04        | 1.21E-04  |
| Ps90%/90% (+KTL) Un-Biased                          | 8.96E-04              | 1.23E-03        | 1.11E-03        | 2.13E-03        | 3.14E-03  |
| Ps90%/90% (-KTL) Un-Biased                          | 3.00E-04              | 5.17E-04        | 8.20E-04        | 6.31E-04        | 2.47E-03  |
| <b>Specification MAX</b>                            | <b>1.50E-02</b>       | <b>4.20E-02</b> | <b>4.80E-02</b> | <b>6.00E-02</b> |           |
| Status  | PASS                  | PASS            | PASS            | PASS            |           |

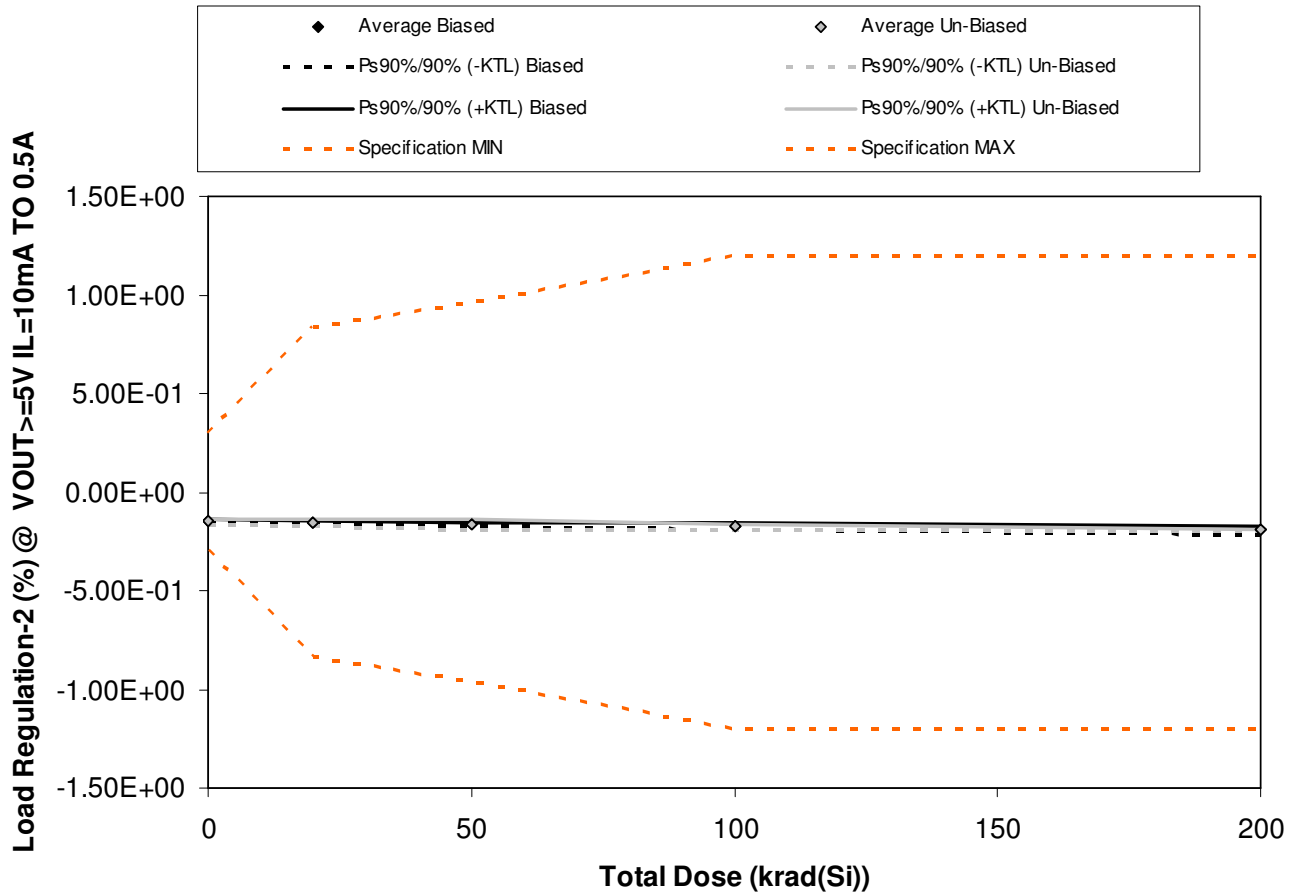

Figure 5.7. Plot of Load Regulation-2 (%) @  $V_{OUT} \geq 5V$   $I_L = 10mA$  TO 0.5A versus total dose. The solid diamonds are the average of the measured data points for the samples irradiated under electrical bias while the shaded diamonds are the average of the measured data points for the samples irradiated with all pins tied to ground. The black lines (solid and/or dashed) are the average of the data points after application of the KTL statistics on the samples irradiated under electrical bias while the gray lines (solid and/or dashed) are the average of the data points after application of the KTL statistics on the samples irradiated in the unbiased condition. The red dotted line(s) are the pre- and/or post-irradiation minimum and/or maximum specification value as defined in the datasheet and/or test plan.



**TID Report  
12-508 120615 R1.0**

**Aeroflex RAD  
5017 N. 30th Street  
Colorado Springs, CO 80919  
(719) 531-0800**

Table 5.7. Raw data for Load Regulation-2 (%) @ VOUT>=5V IL=10mA TO 0.5A versus total dose, including the statistical analysis, specification and the status of the testing (pass/fail).

| Load Regulation-2 (%) @<br>VOUT>=5V IL=10mA TO 0.5A | Total Dose (krad(Si)) |                  |                  |                  |           |
|---|-----------------------|------------------|------------------|------------------|-----------|
|   | 6/8/2012              | 6/14/2012        | 6/14/2012        | 6/14/2012        | 6/14/2012 |
| Device  | 0                     | 20               | 50               | 100              | 200       |
| 59  | -1.46E-01             | -1.55E-01        | -1.59E-01        | -1.73E-01        | -1.93E-01 |
| 60  | -1.46E-01             | -1.54E-01        | -1.65E-01        | -1.65E-01        | -1.90E-01 |
| 74  | -1.44E-01             | -1.56E-01        | -1.71E-01        | -1.81E-01        | -2.07E-01 |
| 76  | -1.45E-01             | -1.52E-01        | -1.63E-01        | -1.76E-01        | -1.95E-01 |
| 77  | -1.41E-01             | -1.53E-01        | -1.64E-01        | -1.72E-01        | -1.85E-01 |
| 78  | -1.52E-01             | -1.57E-01        | -1.50E-01        | -1.76E-01        | -1.93E-01 |
| 79  | -1.46E-01             | -1.51E-01        | -1.59E-01        | -1.75E-01        | -1.90E-01 |
| 80  | -1.53E-01             | -1.61E-01        | -1.64E-01        | -1.78E-01        | -1.89E-01 |
| 81  | -1.43E-01             | -1.47E-01        | -1.78E-01        | -1.80E-01        | -1.92E-01 |
| 82  | -1.52E-01             | -1.60E-01        | -1.64E-01        | -1.66E-01        | -1.94E-01 |
| 83  | -1.52E-01             | -1.56E-01        | -1.71E-01        | -1.54E-01        | -1.53E-01 |
| 84  | -1.53E-01             | -1.60E-01        | -1.52E-01        | -1.53E-01        | -1.50E-01 |
| <b>Biased Statistics</b>                            |                       |                  |                  |                  |           |
| Average Biased                                      | -1.44E-01             | -1.54E-01        | -1.64E-01        | -1.73E-01        | -1.94E-01 |
| Std Dev Biased                                      | 2.07E-03              | 1.58E-03         | 4.34E-03         | 5.86E-03         | 8.19E-03  |
| Ps90%/90% (+KTL) Biased                             | -1.39E-01             | -1.50E-01        | -1.53E-01        | -1.57E-01        | -1.72E-01 |
| Ps90%/90% (-KTL) Biased                             | -1.50E-01             | -1.58E-01        | -1.76E-01        | -1.89E-01        | -2.16E-01 |
| <b>Un-Biased Statistics</b>                         |                       |                  |                  |                  |           |
| Average Un-Biased                                   | -1.49E-01             | -1.55E-01        | -1.63E-01        | -1.75E-01        | -1.92E-01 |
| Std Dev Un-Biased                                   | 4.44E-03              | 6.02E-03         | 1.01E-02         | 5.39E-03         | 2.07E-03  |
| Ps90%/90% (+KTL) Un-Biased                          | -1.37E-01             | -1.39E-01        | -1.35E-01        | -1.60E-01        | -1.86E-01 |
| Ps90%/90% (-KTL) Un-Biased                          | -1.61E-01             | -1.72E-01        | -1.91E-01        | -1.90E-01        | -1.97E-01 |
| <b>Specification MIN</b>                            | <b>-3.00E-01</b>      | <b>-8.40E-01</b> | <b>-9.60E-01</b> | <b>-1.20E+00</b> |           |
| Status  | PASS                  | PASS             | PASS             | PASS             |           |
| <b>Specification MAX</b>                            | <b>3.00E-01</b>       | <b>8.40E-01</b>  | <b>9.60E-01</b>  | <b>1.20E+00</b>  |           |
| Status  | PASS                  | PASS             | PASS             | PASS             |           |

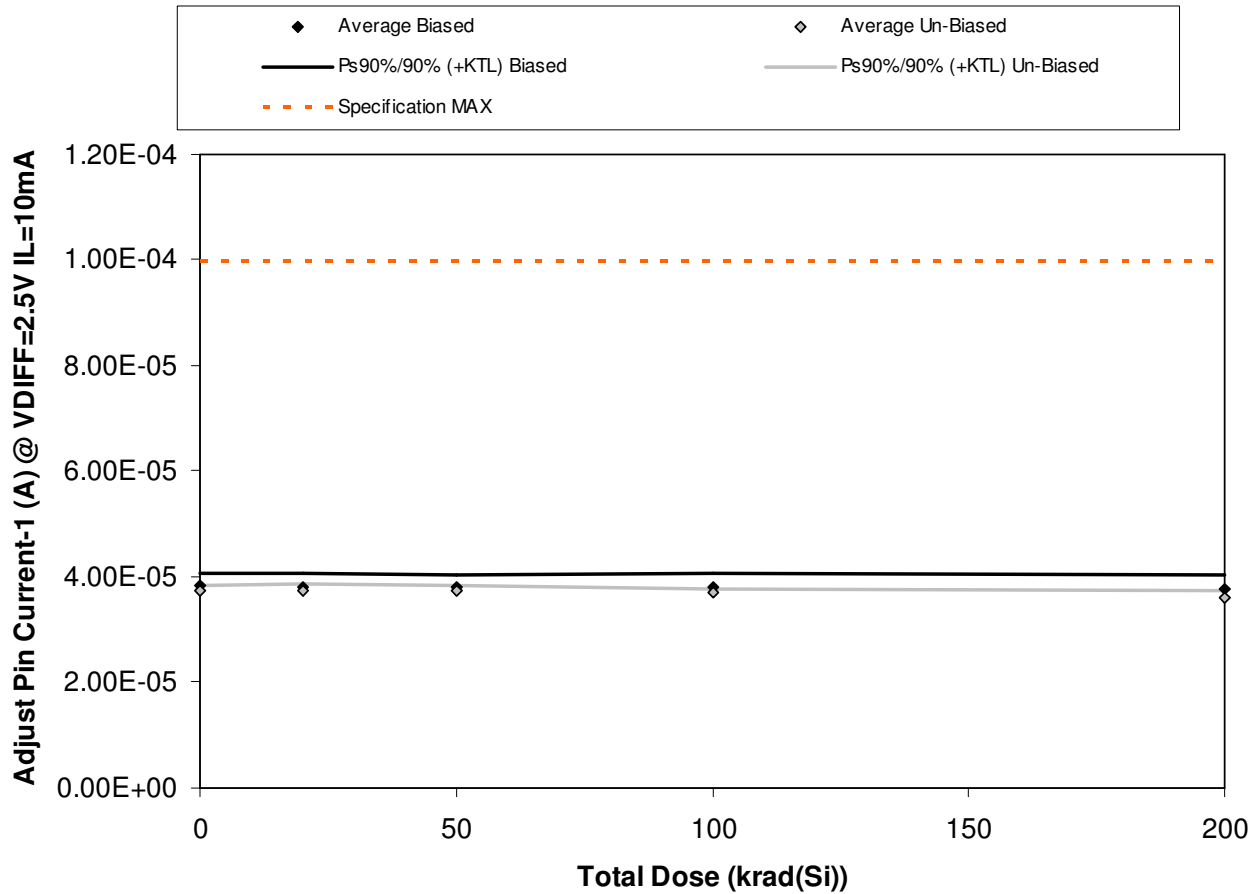

Figure 5.8. Plot of Adjust Pin Current-1 (A) @ VDIFF=2.5V IL=10mA versus total dose. The solid diamonds are the average of the measured data points for the samples irradiated under electrical bias while the shaded diamonds are the average of the measured data points for the samples irradiated with all pins tied to ground. The black lines (solid and/or dashed) are the average of the data points after application of the KTL statistics on the samples irradiated under electrical bias while the gray lines (solid and/or dashed) are the average of the data points after application of the KTL statistics on the samples irradiated in the unbiased condition. The red dotted line(s) are the pre- and/or post-irradiation minimum and/or maximum specification value as defined in the datasheet and/or test plan.



**TID Report  
12-508 120615 R1.0**

**Aeroflex RAD  
5017 N. 30th Street  
Colorado Springs, CO 80919  
(719) 531-0800**

Table 5.8. Raw data for Adjust Pin Current-1 (A) @ VDIFF=2.5V IL=10mA versus total dose, including the statistical analysis, specification and the status of the testing (pass/fail).

| Adjust Pin Current-1 (A) @<br>VDIFF=2.5V IL=10mA | Total Dose (krad(Si)) |                 |                 |                 |           |
|--|-----------------------|-----------------|-----------------|-----------------|-----------|
|  | 6/8/2012              | 6/14/2012       | 6/14/2012       | 6/14/2012       | 6/14/2012 |
| Device   | 0                     | 20              | 50              | 100             | 200       |
| 59   | 3.96E-05              | 3.95E-05        | 3.93E-05        | 3.94E-05        | 3.92E-05  |
| 60   | 3.87E-05              | 3.86E-05        | 3.86E-05        | 3.86E-05        | 3.80E-05  |
| 74   | 3.74E-05              | 3.74E-05        | 3.74E-05        | 3.73E-05        | 3.68E-05  |
| 76   | 3.79E-05              | 3.75E-05        | 3.76E-05        | 3.75E-05        | 3.74E-05  |
| 77   | 3.74E-05              | 3.73E-05        | 3.73E-05        | 3.70E-05        | 3.68E-05  |
| 78   | 3.80E-05              | 3.80E-05        | 3.79E-05        | 3.74E-05        | 3.67E-05  |
| 79   | 3.74E-05              | 3.74E-05        | 3.72E-05        | 3.68E-05        | 3.62E-05  |
| 80   | 3.74E-05              | 3.74E-05        | 3.74E-05        | 3.70E-05        | 3.62E-05  |
| 81   | 3.71E-05              | 3.68E-05        | 3.68E-05        | 3.68E-05        | 3.56E-05  |
| 82   | 3.74E-05              | 3.74E-05        | 3.72E-05        | 3.68E-05        | 3.62E-05  |
| 83   | 3.69E-05              | 3.68E-05        | 3.68E-05        | 3.68E-05        | 3.68E-05  |
| 84   | 3.71E-05              | 3.68E-05        | 3.68E-05        | 3.68E-05        | 3.68E-05  |
| <b>Biased Statistics</b>                         |                       |                 |                 |                 |           |
| Average Biased                                   | 3.82E-05              | 3.81E-05        | 3.80E-05        | 3.80E-05        | 3.76E-05  |
| Std Dev Biased                                   | 9.33E-07              | 9.86E-07        | 8.84E-07        | 1.01E-06        | 1.02E-06  |
| Ps90%/90% (+KTL) Biased                          | 4.08E-05              | 4.08E-05        | 4.05E-05        | 4.07E-05        | 4.04E-05  |
| Ps90%/90% (-KTL) Biased                          | 3.56E-05              | 3.54E-05        | 3.56E-05        | 3.52E-05        | 3.49E-05  |
| <b>Un-Biased Statistics</b>                      |                       |                 |                 |                 |           |
| Average Un-Biased                                | 3.75E-05              | 3.74E-05        | 3.73E-05        | 3.70E-05        | 3.62E-05  |
| Std Dev Un-Biased                                | 3.44E-07              | 4.31E-07        | 4.14E-07        | 2.68E-07        | 3.93E-07  |
| Ps90%/90% (+KTL) Un-Biased                       | 3.84E-05              | 3.86E-05        | 3.85E-05        | 3.77E-05        | 3.72E-05  |
| Ps90%/90% (-KTL) Un-Biased                       | 3.65E-05              | 3.62E-05        | 3.62E-05        | 3.62E-05        | 3.51E-05  |
| <b>Specification MAX</b>                         | <b>1.00E-04</b>       | <b>1.00E-04</b> | <b>1.00E-04</b> | <b>1.00E-04</b> |           |
| Status   | PASS                  | PASS            | PASS            | PASS            |           |

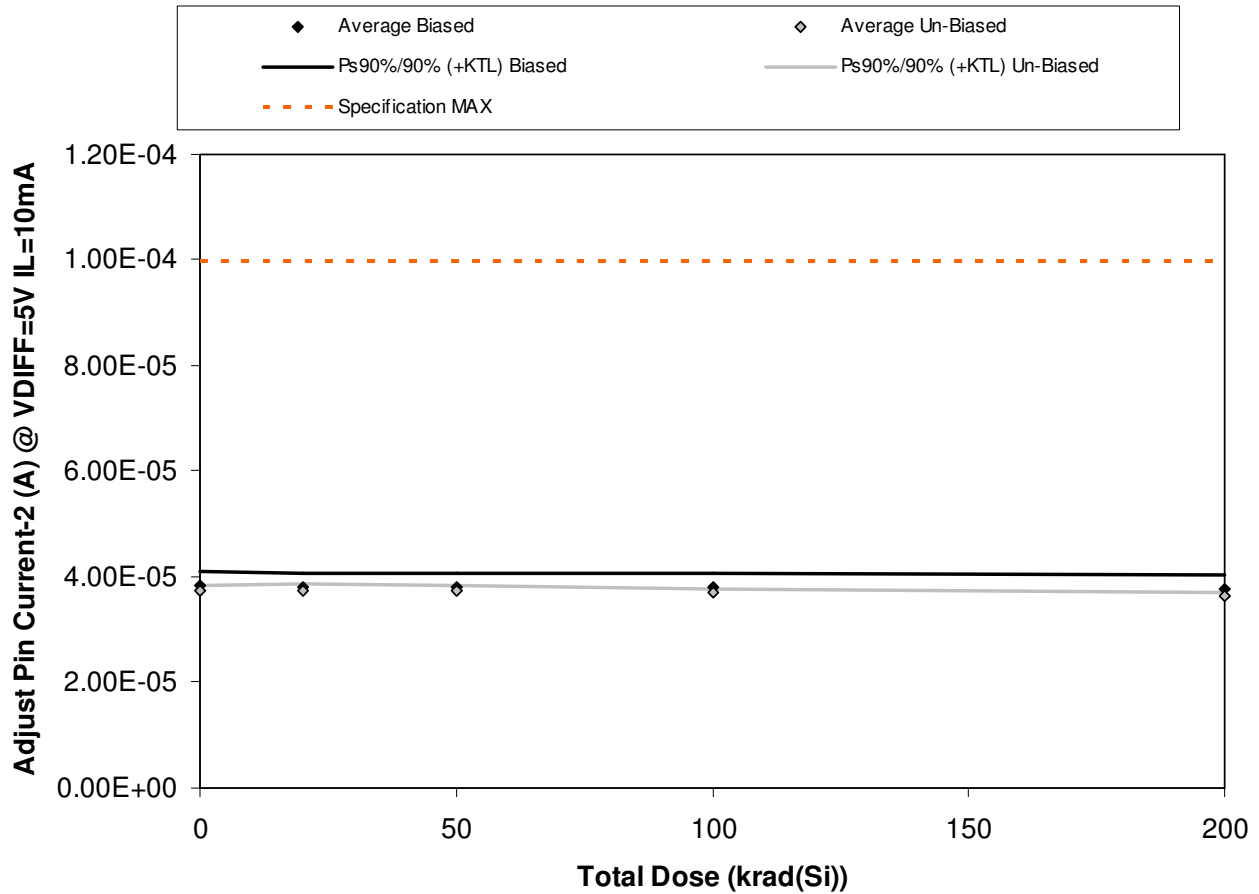

Figure 5.9. Plot of Adjust Pin Current-2 (A) @ VDIFF=5V IL=10mA versus total dose. The solid diamonds are the average of the measured data points for the samples irradiated under electrical bias while the shaded diamonds are the average of the measured data points for the samples irradiated with all pins tied to ground. The black lines (solid and/or dashed) are the average of the data points after application of the KTL statistics on the samples irradiated under electrical bias while the gray lines (solid and/or dashed) are the average of the data points after application of the KTL statistics on the samples irradiated in the unbiased condition. The red dotted line(s) are the pre- and/or post-irradiation minimum and/or maximum specification value as defined in the datasheet and/or test plan.



**TID Report  
12-508 120615 R1.0**

**Aeroflex RAD  
5017 N. 30th Street  
Colorado Springs, CO 80919  
(719) 531-0800**

Table 5.9. Raw data for Adjust Pin Current-2 (A) @ VDIFF=5V IL=10mA versus total dose, including the statistical analysis, specification and the status of the testing (pass/fail).

| Adjust Pin Current-2 (A) @<br>VDIFF=5V IL=10mA | Total Dose (krad(Si)) |                 |                 |                 |           |
|--|-----------------------|-----------------|-----------------|-----------------|-----------|
|  | 6/8/2012              | 6/14/2012       | 6/14/2012       | 6/14/2012       | 6/14/2012 |
| Device   | 0                     | 20              | 50              | 100             | 200       |
| 59   | 3.97E-05              | 3.95E-05        | 3.93E-05        | 3.94E-05        | 3.92E-05  |
| 60   | 3.87E-05              | 3.86E-05        | 3.86E-05        | 3.86E-05        | 3.80E-05  |
| 74   | 3.74E-05              | 3.74E-05        | 3.74E-05        | 3.73E-05        | 3.68E-05  |
| 76   | 3.80E-05              | 3.76E-05        | 3.76E-05        | 3.74E-05        | 3.74E-05  |
| 77   | 3.74E-05              | 3.72E-05        | 3.72E-05        | 3.70E-05        | 3.68E-05  |
| 78   | 3.80E-05              | 3.80E-05        | 3.78E-05        | 3.74E-05        | 3.68E-05  |
| 79   | 3.74E-05              | 3.74E-05        | 3.72E-05        | 3.68E-05        | 3.62E-05  |
| 80   | 3.74E-05              | 3.74E-05        | 3.74E-05        | 3.70E-05        | 3.62E-05  |
| 81   | 3.70E-05              | 3.68E-05        | 3.68E-05        | 3.68E-05        | 3.60E-05  |
| 82   | 3.74E-05              | 3.74E-05        | 3.73E-05        | 3.68E-05        | 3.62E-05  |
| 83   | 3.69E-05              | 3.68E-05        | 3.68E-05        | 3.68E-05        | 3.68E-05  |
| 84   | 3.72E-05              | 3.68E-05        | 3.68E-05        | 3.68E-05        | 3.68E-05  |
| <b>Biased Statistics</b>                       |                       |                 |                 |                 |           |
| Average Biased                                 | 3.82E-05              | 3.81E-05        | 3.80E-05        | 3.80E-05        | 3.76E-05  |
| Std Dev Biased                                 | 9.66E-07              | 9.85E-07        | 8.99E-07        | 1.01E-06        | 1.00E-06  |
| Ps90%/90% (+KTL) Biased                        | 4.09E-05              | 4.08E-05        | 4.05E-05        | 4.07E-05        | 4.04E-05  |
| Ps90%/90% (-KTL) Biased                        | 3.56E-05              | 3.54E-05        | 3.56E-05        | 3.52E-05        | 3.49E-05  |
| <b>Un-Biased Statistics</b>                    |                       |                 |                 |                 |           |
| Average Un-Biased                              | 3.74E-05              | 3.74E-05        | 3.73E-05        | 3.69E-05        | 3.63E-05  |
| Std Dev Un-Biased                              | 3.71E-07              | 4.28E-07        | 3.72E-07        | 2.64E-07        | 3.05E-07  |
| Ps90%/90% (+KTL) Un-Biased                     | 3.85E-05              | 3.86E-05        | 3.83E-05        | 3.77E-05        | 3.71E-05  |
| Ps90%/90% (-KTL) Un-Biased                     | 3.64E-05              | 3.62E-05        | 3.63E-05        | 3.62E-05        | 3.54E-05  |
| <b>Specification MAX</b>                       | <b>1.00E-04</b>       | <b>1.00E-04</b> | <b>1.00E-04</b> | <b>1.00E-04</b> |           |
| Status   | PASS                  | PASS            | PASS            | PASS            |           |



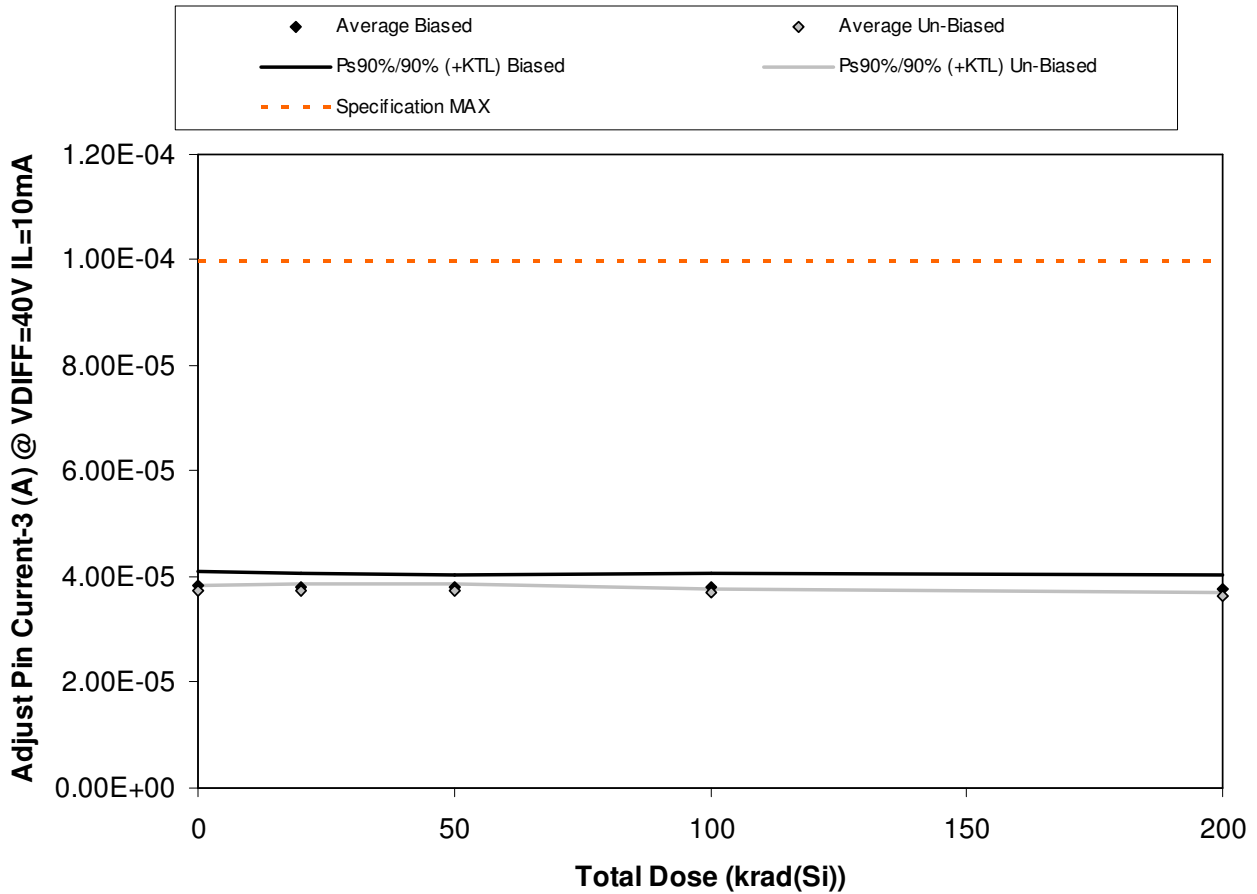

Figure 5.10. Plot of Adjust Pin Current-3 (A) @ VDIFF=40V IL=10mA versus total dose. The solid diamonds are the average of the measured data points for the samples irradiated under electrical bias while the shaded diamonds are the average of the measured data points for the samples irradiated with all pins tied to ground. The black lines (solid and/or dashed) are the average of the data points after application of the KTL statistics on the samples irradiated under electrical bias while the gray lines (solid and/or dashed) are the average of the data points after application of the KTL statistics on the samples irradiated in the unbiased condition. The red dotted line(s) are the pre- and/or post-irradiation minimum and/or maximum specification value as defined in the datasheet and/or test plan.



**TID Report  
12-508 120615 R1.0**

**Aeroflex RAD  
5017 N. 30th Street  
Colorado Springs, CO 80919  
(719) 531-0800**

Table 5.10. Raw data for Adjust Pin Current-3 (A) @ VDIFF=40V IL=10mA versus total dose, including the statistical analysis, specification and the status of the testing (pass/fail).

| Adjust Pin Current-3 (A) @<br>VDIFF=40V IL=10mA | Total Dose (krad(Si)) |                 |                 |                 |           |
|---|-----------------------|-----------------|-----------------|-----------------|-----------|
|   | 6/8/2012              | 6/14/2012       | 6/14/2012       | 6/14/2012       | 6/14/2012 |
| Device  | 0                     | 20              | 50              | 100             | 200       |
| 59  | 3.97E-05              | 3.96E-05        | 3.93E-05        | 3.96E-05        | 3.92E-05  |
| 60  | 3.87E-05              | 3.86E-05        | 3.86E-05        | 3.86E-05        | 3.80E-05  |
| 74  | 3.74E-05              | 3.74E-05        | 3.74E-05        | 3.74E-05        | 3.68E-05  |
| 76  | 3.80E-05              | 3.78E-05        | 3.79E-05        | 3.77E-05        | 3.74E-05  |
| 77  | 3.74E-05              | 3.74E-05        | 3.74E-05        | 3.73E-05        | 3.68E-05  |
| 78  | 3.80E-05              | 3.80E-05        | 3.80E-05        | 3.74E-05        | 3.68E-05  |
| 79  | 3.74E-05              | 3.74E-05        | 3.74E-05        | 3.68E-05        | 3.62E-05  |
| 80  | 3.74E-05              | 3.74E-05        | 3.74E-05        | 3.73E-05        | 3.65E-05  |
| 81  | 3.73E-05              | 3.68E-05        | 3.68E-05        | 3.68E-05        | 3.62E-05  |
| 82  | 3.74E-05              | 3.74E-05        | 3.74E-05        | 3.68E-05        | 3.62E-05  |
| 83  | 3.72E-05              | 3.68E-05        | 3.68E-05        | 3.68E-05        | 3.68E-05  |
| 84  | 3.73E-05              | 3.69E-05        | 3.69E-05        | 3.70E-05        | 3.69E-05  |
| <b>Biased Statistics</b>                        |                       |                 |                 |                 |           |
| Average Biased                                  | 3.82E-05              | 3.82E-05        | 3.81E-05        | 3.81E-05        | 3.76E-05  |
| Std Dev Biased                                  | 9.66E-07              | 9.39E-07        | 8.33E-07        | 9.77E-07        | 1.02E-06  |
| Ps90%/90% (+KTL) Biased                         | 4.09E-05              | 4.07E-05        | 4.04E-05        | 4.08E-05        | 4.05E-05  |
| Ps90%/90% (-KTL) Biased                         | 3.56E-05              | 3.56E-05        | 3.58E-05        | 3.54E-05        | 3.48E-05  |
| <b>Un-Biased Statistics</b>                     |                       |                 |                 |                 |           |
| Average Un-Biased                               | 3.75E-05              | 3.74E-05        | 3.74E-05        | 3.70E-05        | 3.64E-05  |
| Std Dev Un-Biased                               | 2.79E-07              | 4.28E-07        | 4.28E-07        | 2.90E-07        | 2.72E-07  |
| Ps90%/90% (+KTL) Un-Biased                      | 3.83E-05              | 3.86E-05        | 3.86E-05        | 3.78E-05        | 3.71E-05  |
| Ps90%/90% (-KTL) Un-Biased                      | 3.68E-05              | 3.62E-05        | 3.62E-05        | 3.62E-05        | 3.56E-05  |
| <b>Specification MAX</b>                        | <b>1.00E-04</b>       | <b>1.00E-04</b> | <b>1.00E-04</b> | <b>1.00E-04</b> |           |
| Status  | PASS                  | PASS            | PASS            | PASS            |           |

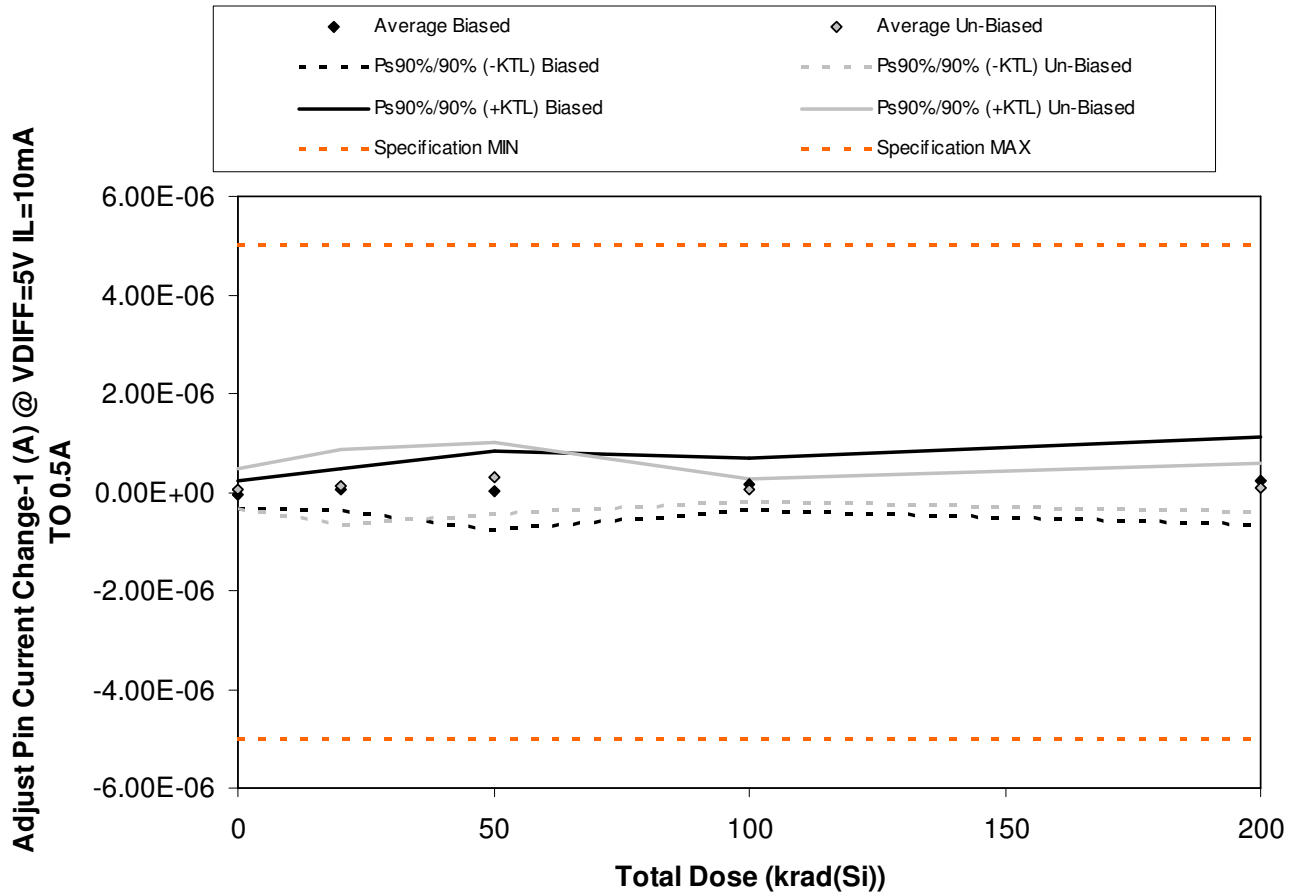

Figure 5.11. Plot of Adjust Pin Current Change-1 (A) @ VDIFF=5V IL=10mA TO 0.5A versus total dose. The solid diamonds are the average of the measured data points for the samples irradiated under electrical bias while the shaded diamonds are the average of the measured data points for the samples irradiated with all pins tied to ground. The black lines (solid and/or dashed) are the average of the data points after application of the KTL statistics on the samples irradiated under electrical bias while the gray lines (solid and/or dashed) are the average of the data points after application of the KTL statistics on the samples irradiated in the unbiased condition. The red dotted line(s) are the pre- and/or post-irradiation minimum and/or maximum specification value as defined in the datasheet and/or test plan.



**TID Report  
12-508 120615 R1.0**

**Aeroflex RAD  
5017 N. 30th Street  
Colorado Springs, CO 80919  
(719) 531-0800**

Table 5.11. Raw data for Adjust Pin Current Change-1 (A) @ VDIFF=5V IL=10mA TO 0.5A versus total dose, including the statistical analysis, specification and the status of the testing (pass/fail).

| Adjust Pin Current Change-1 (A)<br>@ VDIFF=5V IL=10mA TO 0.5A | Total Dose (krad(Si)) |                  |                  |                  |                  |
|---|-----------------------|------------------|------------------|------------------|------------------|
|   | 6/8/2012              | 6/14/2012        | 6/14/2012        | 6/14/2012        | 6/14/2012        |
| Device  | 0                     | 20               | 50               | 100              | 200              |
| 59  | -2.20E-07             | 3.06E-07         | 6.10E-08         | 1.34E-07         | 5.87E-07         |
| 60  | 4.90E-08              | 0.00E+00         | 0.00E+00         | 0.00E+00         | 0.00E+00         |
| 74  | -1.20E-08             | -2.40E-08        | 0.00E+00         | 4.89E-07         | 0.00E+00         |
| 76  | -2.40E-08             | 8.60E-08         | -3.91E-07        | 3.70E-08         | 5.99E-07         |
| 77  | 0.00E+00              | -1.10E-07        | 4.28E-07         | 1.47E-07         | 0.00E+00         |
| 78  | 0.00E+00              | 0.00E+00         | 4.89E-07         | 0.00E+00         | 0.00E+00         |
| 79  | 0.00E+00              | -2.40E-08        | 5.01E-07         | 0.00E+00         | 0.00E+00         |
| 80  | 0.00E+00              | 0.00E+00         | 0.00E+00         | 1.83E-07         | 1.20E-08         |
| 81  | 3.42E-07              | 0.00E+00         | 0.00E+00         | 0.00E+00         | 4.16E-07         |
| 82  | 0.00E+00              | 6.11E-07         | 4.52E-07         | 0.00E+00         | 0.00E+00         |
| 83  | 1.59E-07              | 0.00E+00         | 0.00E+00         | 0.00E+00         | 0.00E+00         |
| 84  | 3.30E-07              | 1.20E-08         | 0.00E+00         | 2.40E-08         | 3.70E-08         |
| <b>Biased Statistics</b>                                      |                       |                  |                  |                  |                  |
| Average Biased  | -4.14E-08             | 5.16E-08         | 1.96E-08         | 1.61E-07         | 2.37E-07         |
| Std Dev Biased  | 1.04E-07              | 1.58E-07         | 2.91E-07         | 1.94E-07         | 3.25E-07         |
| Ps90%/90% (+KTL) Biased                                       | 2.43E-07              | 4.86E-07         | 8.17E-07         | 6.92E-07         | 1.13E-06         |
| Ps90%/90% (-KTL) Biased                                       | -3.26E-07             | -3.83E-07        | -7.77E-07        | -3.69E-07        | -6.53E-07        |
| <b>Un-Biased Statistics</b>                                   |                       |                  |                  |                  |                  |
| Average Un-Biased   | 6.84E-08              | 1.17E-07         | 2.88E-07         | 3.66E-08         | 8.56E-08         |
| Std Dev Un-Biased   | 1.53E-07              | 2.76E-07         | 2.64E-07         | 8.18E-08         | 1.85E-07         |
| Ps90%/90% (+KTL) Un-Biased                                    | 4.88E-07              | 8.75E-07         | 1.01E-06         | 2.61E-07         | 5.92E-07         |
| Ps90%/90% (-KTL) Un-Biased                                    | -3.51E-07             | -6.40E-07        | -4.35E-07        | -1.88E-07        | -4.21E-07        |
| <b>Specification MIN</b>                                      | <b>-5.00E-06</b>      | <b>-5.00E-06</b> | <b>-5.00E-06</b> | <b>-5.00E-06</b> | <b>-5.00E-06</b> |
| Status  | PASS                  | PASS             | PASS             | PASS             |                  |
| <b>Specification MAX</b>                                      | <b>5.00E-06</b>       | <b>5.00E-06</b>  | <b>5.00E-06</b>  | <b>5.00E-06</b>  | <b>5.00E-06</b>  |
| Status  | PASS                  | PASS             | PASS             | PASS             |                  |

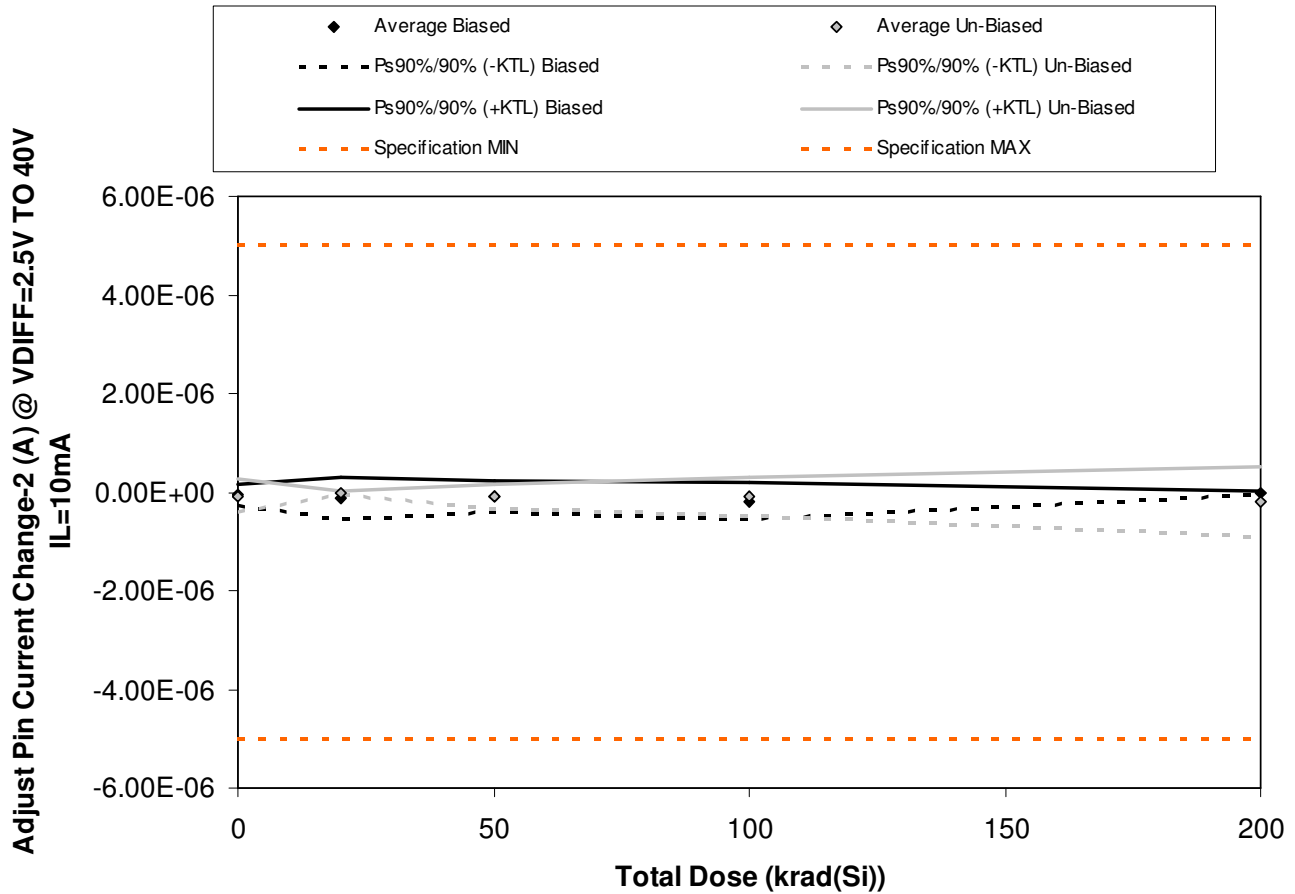

Figure 5.12. Plot of Adjust Pin Current Change-2 (A) @ VDIFF=2.5V TO 40V IL=10mA versus total dose. The solid diamonds are the average of the measured data points for the samples irradiated under electrical bias while the shaded diamonds are the average of the measured data points for the samples irradiated with all pins tied to ground. The black lines (solid and/or dashed) are the average of the data points after application of the KTL statistics on the samples irradiated under electrical bias while the gray lines (solid and/or dashed) are the average of the data points after application of the KTL statistics on the samples irradiated in the unbiased condition. The red dotted line(s) are the pre- and/or post-irradiation minimum and/or maximum specification value as defined in the datasheet and/or test plan.



**TID Report  
12-508 120615 R1.0**

**Aeroflex RAD  
5017 N. 30th Street  
Colorado Springs, CO 80919  
(719) 531-0800**

Table 5.12. Raw data for Adjust Pin Current Change-2 (A) @ VDIFF=2.5V TO 40V IL=10mA versus total dose, including the statistical analysis, specification and the status of the testing (pass/fail).

| Adjust Pin Current Change-2 (A)<br>@ VDIFF=2.5V TO 40V IL=10mA | Total Dose (krad(Si)) |                  |                  |                  |                  |
|--|-----------------------|------------------|------------------|------------------|------------------|
|  | 6/8/2012              | 6/14/2012        | 6/14/2012        | 6/14/2012        | 6/14/2012        |
| Device   | 0                     | 20               | 50               | 100              | 200              |
| 59   | -1.83E-07             | -2.20E-07        | -6.10E-08        | -1.96E-07        | -2.40E-08        |
| 60   | -3.70E-08             | 0.00E+00         | 0.00E+00         | 0.00E+00         | 0.00E+00         |
| 74   | 0.00E+00              | -1.20E-08        | 0.00E+00         | -1.71E-07        | 0.00E+00         |
| 76   | -3.70E-08             | -3.54E-07        | -2.93E-07        | -1.59E-07        | -1.20E-08        |
| 77   | -1.20E-08             | -6.10E-08        | -1.10E-07        | -3.79E-07        | 0.00E+00         |
| 78   | 0.00E+00              | 0.00E+00         | -1.96E-07        | 0.00E+00         | -3.70E-08        |
| 79   | 0.00E+00              | 0.00E+00         | -1.34E-07        | -4.90E-08        | -2.40E-08        |
| 80   | -6.10E-08             | 0.00E+00         | -1.20E-08        | -3.42E-07        | -3.42E-07        |
| 81   | -2.93E-07             | -3.70E-08        | 0.00E+00         | 0.00E+00         | -5.87E-07        |
| 82   | 0.00E+00              | -2.40E-08        | -1.71E-07        | -3.70E-08        | 0.00E+00         |
| 83   | -3.42E-07             | 0.00E+00         | 0.00E+00         | 0.00E+00         | 0.00E+00         |
| 84   | -1.47E-07             | -7.30E-08        | -9.80E-08        | -1.10E-07        | -1.59E-07        |
| <b>Biased Statistics</b>                                       |                       |                  |                  |                  |                  |
| Average Biased   | -5.38E-08             | -1.29E-07        | -9.28E-08        | -1.81E-07        | -7.20E-09        |
| Std Dev Biased   | 7.40E-08              | 1.53E-07         | 1.21E-07         | 1.35E-07         | 1.07E-08         |
| Ps90%/90% (+KTL) Biased  | 1.49E-07              | 2.91E-07         | 2.39E-07         | 1.89E-07         | 2.22E-08         |
| Ps90%/90% (-KTL) Biased  | -2.57E-07             | -5.49E-07        | -4.25E-07        | -5.51E-07        | -3.66E-08        |
| <b>Un-Biased Statistics</b>                                    |                       |                  |                  |                  |                  |
| Average Un-Biased  | -7.08E-08             | -1.22E-08        | -1.03E-07        | -8.56E-08        | -1.98E-07        |
| Std Dev Un-Biased  | 1.27E-07              | 1.73E-08         | 9.10E-08         | 1.45E-07         | 2.59E-07         |
| Ps90%/90% (+KTL) Un-Biased                                     | 2.77E-07              | 3.53E-08         | 1.47E-07         | 3.12E-07         | 5.11E-07         |
| Ps90%/90% (-KTL) Un-Biased                                     | -4.19E-07             | -5.97E-08        | -3.52E-07        | -4.83E-07        | -9.07E-07        |
| <b>Specification MIN</b>                                       | <b>-5.00E-06</b>      | <b>-5.00E-06</b> | <b>-5.00E-06</b> | <b>-5.00E-06</b> | <b>-5.00E-06</b> |
| Status   | PASS                  | PASS             | PASS             | PASS             |                  |
| <b>Specification MAX</b>                                       | <b>5.00E-06</b>       | <b>5.00E-06</b>  | <b>5.00E-06</b>  | <b>5.00E-06</b>  | <b>5.00E-06</b>  |
| Status   | PASS                  | PASS             | PASS             | PASS             |                  |

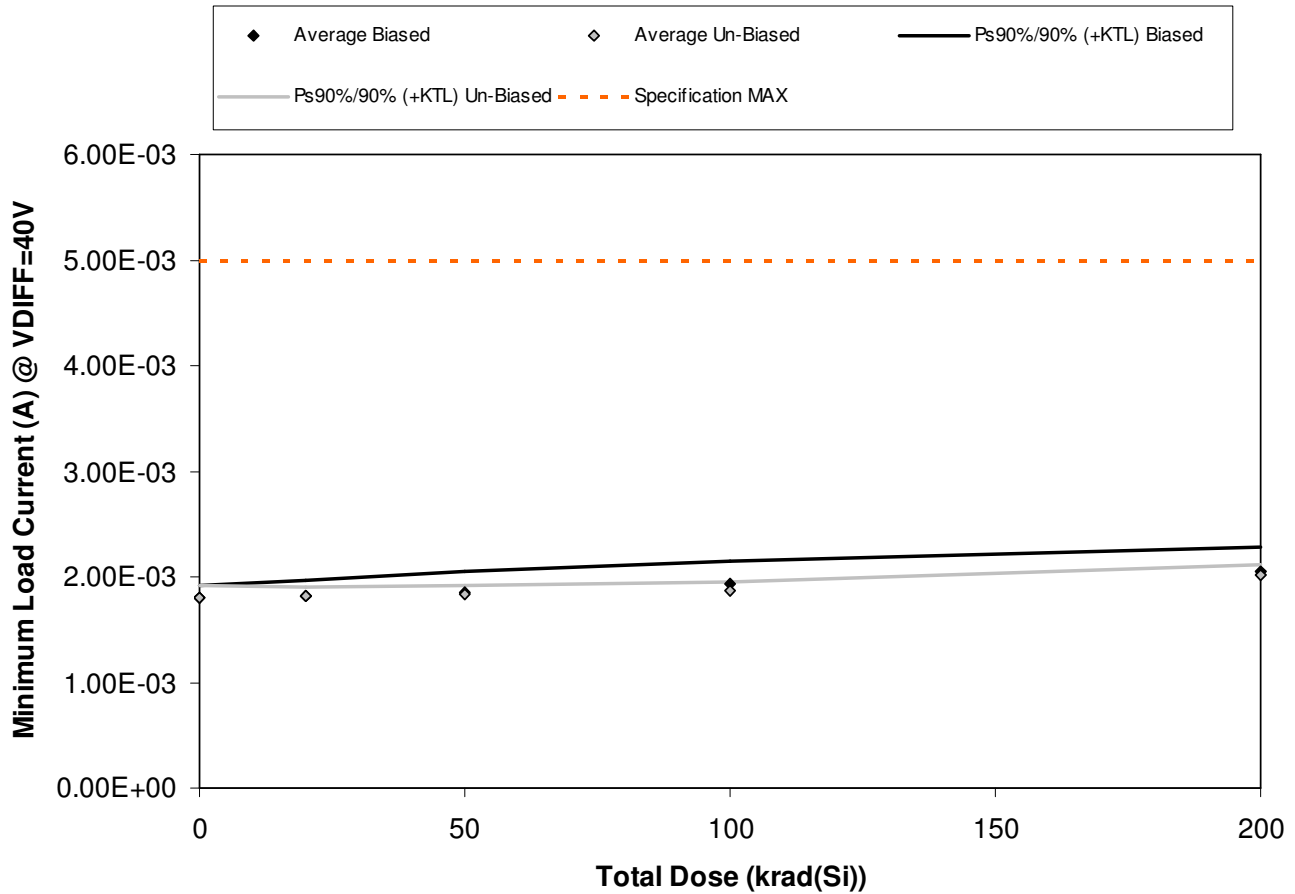

Figure 5.13. Plot of Minimum Load Current (A) @ VDIFF=40V versus total dose. The solid diamonds are the average of the measured data points for the samples irradiated under electrical bias while the shaded diamonds are the average of the measured data points for the samples irradiated with all pins tied to ground. The black lines (solid and/or dashed) are the average of the data points after application of the KTL statistics on the samples irradiated under electrical bias while the gray lines (solid and/or dashed) are the average of the data points after application of the KTL statistics on the samples irradiated in the unbiased condition. The red dotted line(s) are the pre- and/or post-irradiation minimum and/or maximum specification value as defined in the datasheet and/or test plan.



**TID Report  
12-508 120615 R1.0**

**Aeroflex RAD  
5017 N. 30th Street  
Colorado Springs, CO 80919  
(719) 531-0800**

Table 5.13. Raw data for Minimum Load Current (A) @ VDIFF=40V versus total dose, including the statistical analysis, specification and the status of the testing (pass/fail).

| Minimum Load Current (A) @<br>VDIFF=40V | Total Dose (krad(Si)) |                 |                 |                 |           |
|---|-----------------------|-----------------|-----------------|-----------------|-----------|
|   | 6/8/2012              | 6/14/2012       | 6/14/2012       | 6/14/2012       | 6/14/2012 |
| Device                                  | 0                     | 20              | 50              | 100             | 200       |
| 59                                      | 1.77E-03              | 1.79E-03        | 1.83E-03        | 1.88E-03        | 2.02E-03  |
| 60                                      | 1.75E-03              | 1.75E-03        | 1.79E-03        | 1.85E-03        | 1.96E-03  |
| 74                                      | 1.79E-03              | 1.81E-03        | 1.83E-03        | 1.90E-03        | 2.02E-03  |
| 76                                      | 1.87E-03              | 1.90E-03        | 1.96E-03        | 2.06E-03        | 2.18E-03  |
| 77                                      | 1.81E-03              | 1.83E-03        | 1.88E-03        | 1.94E-03        | 2.08E-03  |
| 78                                      | 1.85E-03              | 1.85E-03        | 1.86E-03        | 1.90E-03        | 2.06E-03  |
| 79                                      | 1.85E-03              | 1.85E-03        | 1.86E-03        | 1.90E-03        | 2.04E-03  |
| 80                                      | 1.77E-03              | 1.79E-03        | 1.81E-03        | 1.85E-03        | 1.96E-03  |
| 81                                      | 1.79E-03              | 1.81E-03        | 1.83E-03        | 1.85E-03        | 1.98E-03  |
| 82                                      | 1.77E-03              | 1.79E-03        | 1.81E-03        | 1.85E-03        | 2.02E-03  |
| 83                                      | 1.77E-03              | 1.79E-03        | 1.79E-03        | 1.79E-03        | 1.79E-03  |
| 84                                      | 1.71E-03              | 1.73E-03        | 1.73E-03        | 1.71E-03        | 1.73E-03  |
| <b>Biased Statistics</b>                |                       |                 |                 |                 |           |
| Average Biased                          | 1.80E-03              | 1.81E-03        | 1.86E-03        | 1.93E-03        | 2.05E-03  |
| Std Dev Biased                          | 4.53E-05              | 5.69E-05        | 6.89E-05        | 8.30E-05        | 8.05E-05  |
| Ps90%/90% (+KTL) Biased                 | 1.92E-03              | 1.97E-03        | 2.05E-03        | 2.16E-03        | 2.27E-03  |
| Ps90%/90% (-KTL) Biased                 | 1.67E-03              | 1.66E-03        | 1.67E-03        | 1.70E-03        | 1.83E-03  |
| <b>Un-Biased Statistics</b>             |                       |                 |                 |                 |           |
| Average Un-Biased                       | 1.80E-03              | 1.81E-03        | 1.83E-03        | 1.87E-03        | 2.01E-03  |
| Std Dev Un-Biased                       | 3.99E-05              | 3.15E-05        | 2.93E-05        | 2.96E-05        | 3.91E-05  |
| Ps90%/90% (+KTL) Un-Biased              | 1.91E-03              | 1.90E-03        | 1.91E-03        | 1.95E-03        | 2.12E-03  |
| Ps90%/90% (-KTL) Un-Biased              | 1.69E-03              | 1.73E-03        | 1.75E-03        | 1.79E-03        | 1.91E-03  |
| <b>Specification MAX</b>                | <b>5.00E-03</b>       | <b>5.00E-03</b> | <b>5.00E-03</b> | <b>5.00E-03</b> |           |
| Status                                  | PASS                  | PASS            | PASS            | PASS            |           |



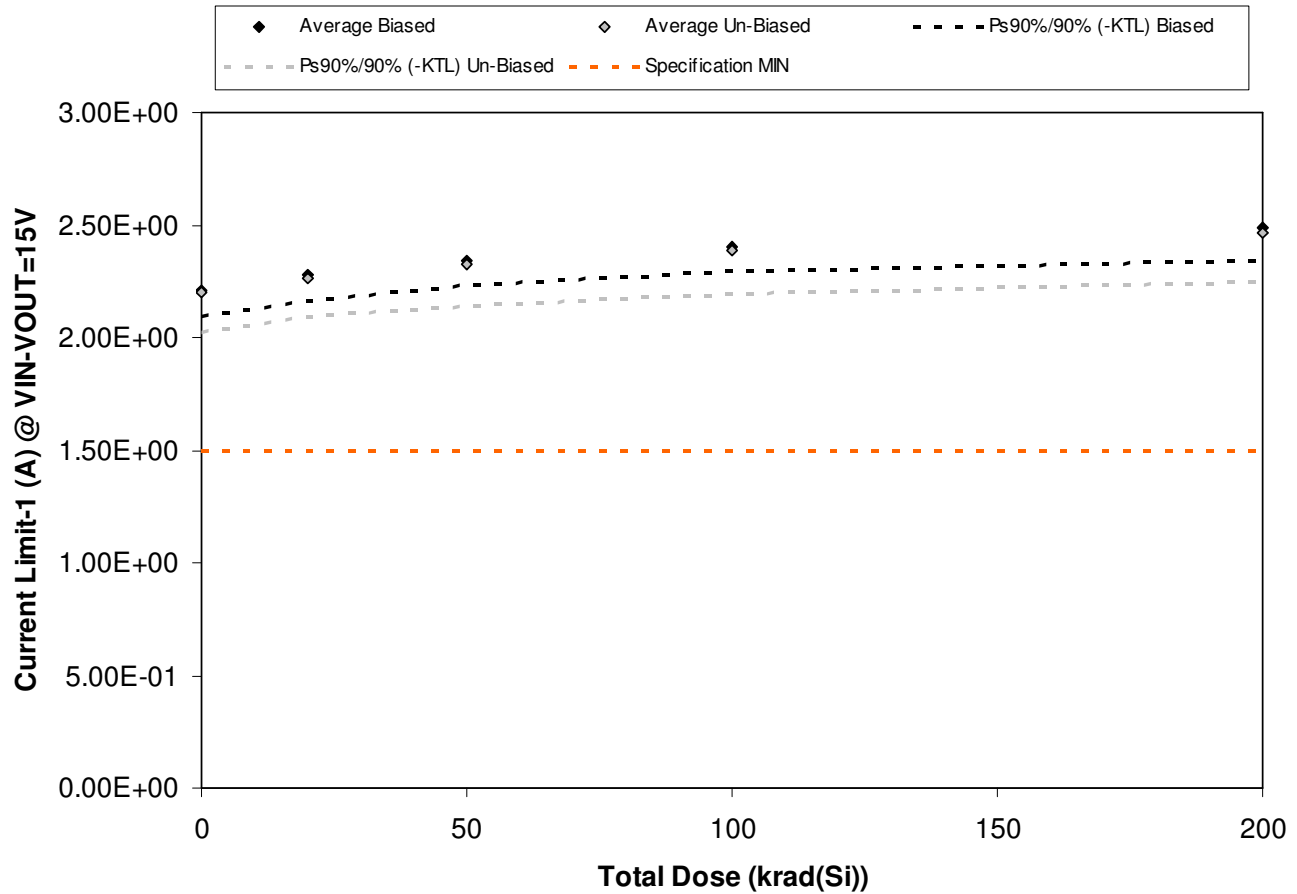

Figure 5.14. Plot of Current Limit-1 (A) @ VIN-VOUT=15V versus total dose. The solid diamonds are the average of the measured data points for the samples irradiated under electrical bias while the shaded diamonds are the average of the measured data points for the samples irradiated with all pins tied to ground. The black lines (solid and/or dashed) are the average of the data points after application of the KTL statistics on the samples irradiated under electrical bias while the gray lines (solid and/or dashed) are the average of the data points after application of the KTL statistics on the samples irradiated in the unbiased condition. The red dotted line(s) are the pre- and/or post-irradiation minimum and/or maximum specification value as defined in the datasheet and/or test plan.



**TID Report  
12-508 120615 R1.0**

**Aeroflex RAD  
5017 N. 30th Street  
Colorado Springs, CO 80919  
(719) 531-0800**

Table 5.14. Raw data for Current Limit-1 (A) @ VIN-VOUT=15V versus total dose, including the statistical analysis, specification and the status of the testing (pass/fail).

| Current Limit-1 (A) @<br>VIN-VOUT=15V | Total Dose (krad(Si)) |                 |                 |                 |           |
|---------------------------------------|-----------------------|-----------------|-----------------|-----------------|-----------|
|                                       | 6/8/2012              | 6/14/2012       | 6/14/2012       | 6/14/2012       | 6/14/2012 |
| Device                                | 0                     | 20              | 50              | 100             | 200       |
| 59                                    | 2.28E+00              | 2.35E+00        | 2.40E+00        | 2.46E+00        | 2.54E+00  |
| 60                                    | 2.20E+00              | 2.27E+00        | 2.33E+00        | 2.39E+00        | 2.45E+00  |
| 74                                    | 2.16E+00              | 2.23E+00        | 2.30E+00        | 2.35E+00        | 2.42E+00  |
| 76                                    | 2.21E+00              | 2.29E+00        | 2.35E+00        | 2.43E+00        | 2.54E+00  |
| 77                                    | 2.19E+00              | 2.26E+00        | 2.33E+00        | 2.39E+00        | 2.49E+00  |
| 78                                    | 2.25E+00              | 2.32E+00        | 2.39E+00        | 2.46E+00        | 2.55E+00  |
| 79                                    | 2.24E+00              | 2.30E+00        | 2.36E+00        | 2.43E+00        | 2.52E+00  |
| 80                                    | 2.14E+00              | 2.21E+00        | 2.27E+00        | 2.33E+00        | 2.38E+00  |
| 81                                    | 2.24E+00              | 2.31E+00        | 2.38E+00        | 2.44E+00        | 2.50E+00  |
| 82                                    | 2.12E+00              | 2.19E+00        | 2.24E+00        | 2.30E+00        | 2.38E+00  |
| 83                                    | 2.17E+00              | 2.18E+00        | 2.17E+00        | 2.18E+00        | 2.17E+00  |
| 84                                    | 2.10E+00              | 2.10E+00        | 2.10E+00        | 2.10E+00        | 2.09E+00  |
| <b>Biased Statistics</b>              |                       |                 |                 |                 |           |
| Average Biased                        | 2.21E+00              | 2.28E+00        | 2.34E+00        | 2.40E+00        | 2.49E+00  |
| Std Dev Biased                        | 4.28E-02              | 4.27E-02        | 3.91E-02        | 4.10E-02        | 5.36E-02  |
| Ps90%/90% (+KTL) Biased               | 2.33E+00              | 2.40E+00        | 2.45E+00        | 2.52E+00        | 2.64E+00  |
| Ps90%/90% (-KTL) Biased               | 2.09E+00              | 2.16E+00        | 2.24E+00        | 2.29E+00        | 2.34E+00  |
| <b>Un-Biased Statistics</b>           |                       |                 |                 |                 |           |
| Average Un-Biased                     | 2.20E+00              | 2.26E+00        | 2.33E+00        | 2.39E+00        | 2.46E+00  |
| Std Dev Un-Biased                     | 6.26E-02              | 6.29E-02        | 6.80E-02        | 7.09E-02        | 7.87E-02  |
| Ps90%/90% (+KTL) Un-Biased            | 2.37E+00              | 2.44E+00        | 2.51E+00        | 2.58E+00        | 2.68E+00  |
| Ps90%/90% (-KTL) Un-Biased            | 2.03E+00              | 2.09E+00        | 2.14E+00        | 2.20E+00        | 2.25E+00  |
| <b>Specification MIN</b>              | <b>1.50E+00</b>       | <b>1.50E+00</b> | <b>1.50E+00</b> | <b>1.50E+00</b> |           |
| Status                                | PASS                  | PASS            | PASS            | PASS            |           |

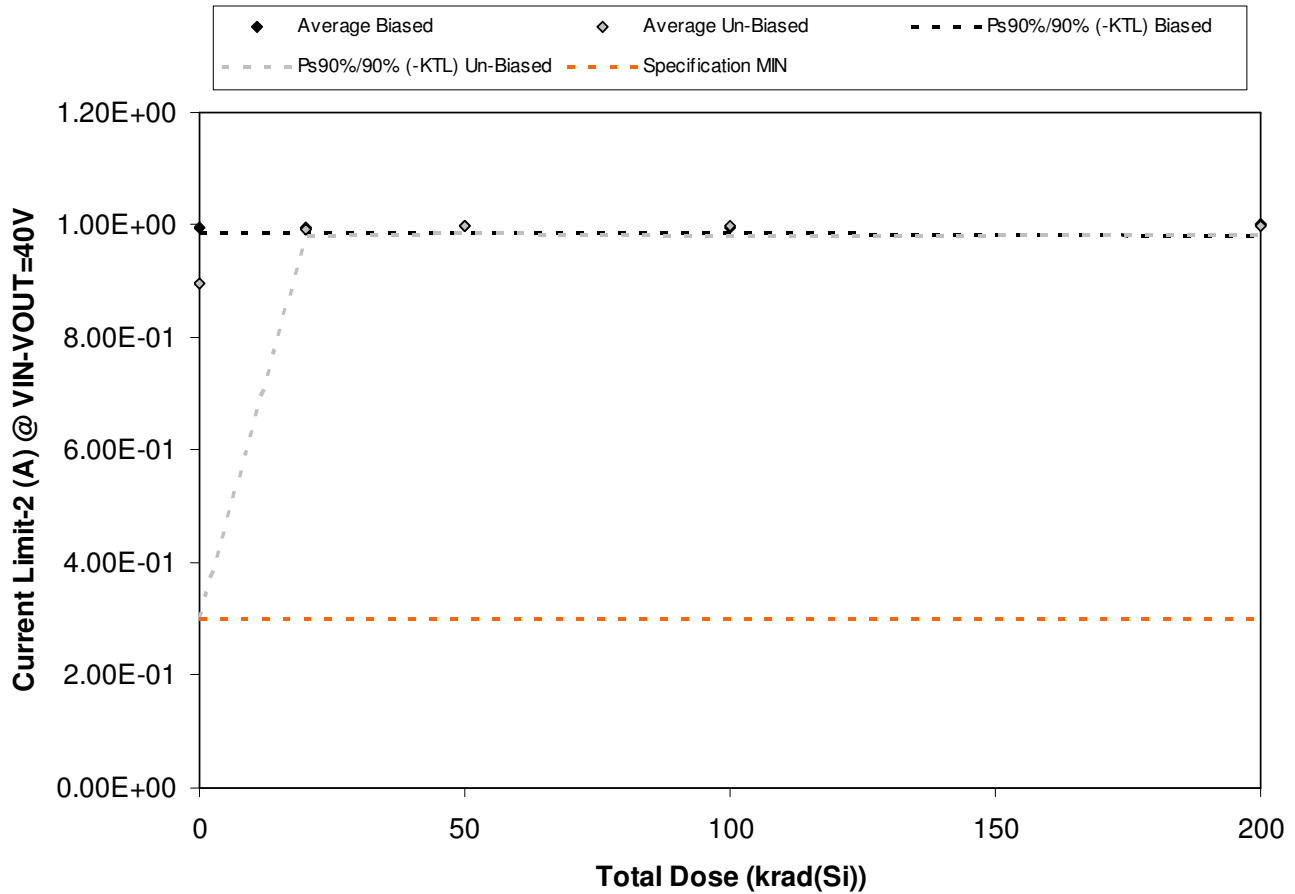

Figure 5.15. Plot of Current Limit-2 (A) @ VIN-VOUT=40V versus total dose. The solid diamonds are the average of the measured data points for the samples irradiated under electrical bias while the shaded diamonds are the average of the measured data points for the samples irradiated with all pins tied to ground. The black lines (solid and/or dashed) are the average of the data points after application of the KTL statistics on the samples irradiated under electrical bias while the gray lines (solid and/or dashed) are the average of the data points after application of the KTL statistics on the samples irradiated in the unbiased condition. The red dotted line(s) are the pre- and/or post-irradiation minimum and/or maximum specification value as defined in the datasheet and/or test plan.



**TID Report  
12-508 120615 R1.0**

**Aeroflex RAD  
5017 N. 30th Street  
Colorado Springs, CO 80919  
(719) 531-0800**

Table 5.15. Raw data for Current Limit-2 (A) @ VIN-VOUT=40V versus total dose, including the statistical analysis, specification and the status of the testing (pass/fail).

| Current Limit-2 (A) @<br>VIN-VOUT=40V | Total Dose (krad(Si)) |                 |                 |                 |           |
|---------------------------------------|-----------------------|-----------------|-----------------|-----------------|-----------|
|                                       | 6/8/2012              | 6/14/2012       | 6/14/2012       | 6/14/2012       | 6/14/2012 |
| Device                                | 0                     | 20              | 50              | 100             | 200       |
| 59                                    | 9.97E-01              | 9.92E-01        | 9.97E-01        | 9.97E-01        | 9.96E-01  |
| 60                                    | 9.97E-01              | 9.97E-01        | 9.97E-01        | 9.97E-01        | 1.00E+00  |
| 74                                    | 9.91E-01              | 9.97E-01        | 9.97E-01        | 9.92E-01        | 1.01E+00  |
| 76                                    | 9.97E-01              | 9.97E-01        | 9.92E-01        | 9.92E-01        | 9.91E-01  |
| 77                                    | 9.91E-01              | 9.92E-01        | 1.00E+00        | 9.92E-01        | 1.01E+00  |
| 78                                    | 9.97E-01              | 9.92E-01        | 1.00E+00        | 1.00E+00        | 1.00E+00  |
| 79                                    | 1.00E+00              | 9.92E-01        | 9.97E-01        | 9.92E-01        | 9.96E-01  |
| 80                                    | 9.86E-01              | 9.86E-01        | 9.97E-01        | 1.01E+00        | 1.01E+00  |
| 81                                    | 9.91E-01              | 9.92E-01        | 9.97E-01        | 9.97E-01        | 9.91E-01  |
| 82                                    | 5.08E-01              | 9.97E-01        | 9.92E-01        | 9.92E-01        | 9.96E-01  |
| 83                                    | 9.75E-01              | 9.97E-01        | 9.97E-01        | 9.97E-01        | 9.91E-01  |
| 84                                    | 9.69E-01              | 9.92E-01        | 9.97E-01        | 9.97E-01        | 9.91E-01  |
| <b>Biased Statistics</b>              |                       |                 |                 |                 |           |
| Average Biased                        | 9.95E-01              | 9.95E-01        | 9.97E-01        | 9.94E-01        | 1.00E+00  |
| Std Dev Biased                        | 3.29E-03              | 2.74E-03        | 3.90E-03        | 2.74E-03        | 7.02E-03  |
| Ps90%/90% (+KTL) Biased               | 1.00E+00              | 1.00E+00        | 1.01E+00        | 1.00E+00        | 1.02E+00  |
| Ps90%/90% (-KTL) Biased               | 9.86E-01              | 9.87E-01        | 9.87E-01        | 9.86E-01        | 9.81E-01  |
| <b>Un-Biased Statistics</b>           |                       |                 |                 |                 |           |
| Average Un-Biased                     | 8.97E-01              | 9.92E-01        | 9.97E-01        | 9.98E-01        | 9.98E-01  |
| Std Dev Un-Biased                     | 2.17E-01              | 3.90E-03        | 3.90E-03        | 7.02E-03        | 6.19E-03  |
| Ps90%/90% (+KTL) Un-Biased            | 1.49E+00              | 1.00E+00        | 1.01E+00        | 1.02E+00        | 1.02E+00  |
| Ps90%/90% (-KTL) Un-Biased            | 3.01E-01              | 9.81E-01        | 9.87E-01        | 9.79E-01        | 9.81E-01  |
| <b>Specification MIN</b>              | <b>3.00E-01</b>       | <b>3.00E-01</b> | <b>3.00E-01</b> | <b>3.00E-01</b> |           |
| Status                                | PASS                  | PASS            | PASS            | PASS            |           |



## **6.0. Summary / Conclusions**

The total ionizing dose testing described in this final report was performed using the facilities at Aeroflex RAD's Longmire Laboratories in Colorado Springs, CO. The high dose rate total ionizing dose (TID) source is a JLSA 81-24 irradiator modified to provide a panoramic exposure. The Co-60 rods are held in the base of the irradiator heavily shielded by lead, during the radiation exposures the rod is raised by an electronic timer/controller and the exposure is performed in air. The dose rate for this irradiator in this configuration ranges from <math><1\text{rad(Si)/s}</math> to a maximum of approximately

The parametric data was obtained as "read and record" and all the raw data plus an attributes summary are contained in this report as well as in a separate Excel file. The attributes data contains the average, standard deviation and the average with the KTL values applied. The KTL value used in this work is 2.742 per MIL-HDBK-814 using one sided tolerance limits of 90/90 and a 5-piece sample size. The 90/90 KTL values were selected to match the statistical levels specified in the MIL-PRF-38535 sampling plan for the qualification of a radiation hardness assured (RHA) component. Note that the following criteria must be met for a device to pass the total ionizing dose test: following the radiation exposure each of the 5 pieces irradiated under electrical bias shall pass the specification value. The units irradiated without electrical bias and the KTL statistics are included in this report for reference only. If any of the 5 pieces irradiated under electrical bias exceed the device post radiation data sheet specification limits, then the lot could be logged as a failure.

Based on this criterion the RH117K Positive Adjustable Regulator (from the lot traceability information provided on the first page of this test report) PASSED the total ionizing dose test to the



***Appendix A: Photograph of Packing Label and a Sample Unit-Under-Test to Show Part Traceability***



**Appendix B: Radiation Bias Connections and Absolute Maximum Ratings**

**TID Radiation Biased Conditions:** Extracted from Linear Technology RH117 Datasheet.

| Pin      | Function | Connection / Bias                   |
|----------|----------|-------------------------------------|
| 1        | ADJUST   | 2kΩ to -15V                         |
| 2        | INPUT    | To 15V,<br>0.1μF decoupling to -15V |
| 3 (Case) | OUTPUT   | 61.9Ω to -15V                       |

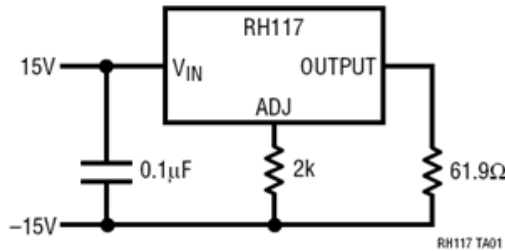

Figure B.1. Irradiation bias drawing for the units to be irradiated under electrical bias. This figure was extracted from LINEAR TECHNOLOGY RH117 Datasheet.

**TID Radiation Unbiased Conditions:**

| Pin      | Function | Connection / Bias |
|----------|----------|-------------------|
| 1        | ADJUST   | GND               |
| 2        | INPUT    | GND               |
| 3 (Case) | OUTPUT   | GND               |

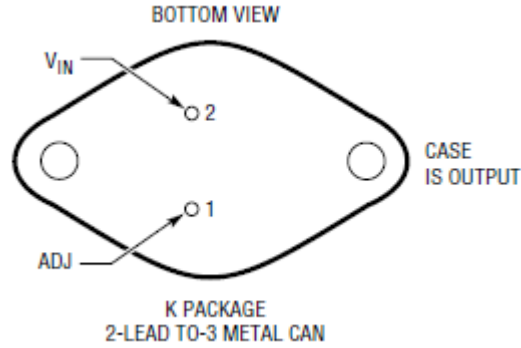

Figure B.2. K package drawing (for reference only). This figure was extracted from the LINEAR TECHNOLOGY RH117 Datasheet.

**Absolute Maximum Ratings:**

| Parameter                            | Max Rating         |
|--------------------------------------|--------------------|
| Power Dissipation                    | Internally Limited |
| Input-to-Output Voltage Differential | 40V                |





### ***Appendix C: Electrical Test Parameters and Conditions***

The expected ranges of values as well as the measurement conditions are taken from Linear Technology RH117 Datasheet. All electrical tests for this device are performed on one of Aeroflex RAD's LTS2020 Test Systems. The LTS2020 Test System is a programmable parametric tester that provides parameter measurements for a variety of digital, analog and mixed signal products including voltage regulators, voltage comparators, D to A and A to D converters. The LTS2020 Test System achieves accuracy and sensitivity through the use of software self-calibration and an internal relay matrix with separate family boards and custom personality adapter boards. The tester uses this relay matrix to connect the required test circuits, select the appropriate voltage / current sources and establish the needed measurement loops for all the tests performed. The measured parameters and test conditions are shown in Table C.1.

A listing of the measurement precision/resolution for each parameter is shown in Table C.2. The precision/resolution values were obtained from test data or from the DAC resolution of the LTS-2020 for the particular test shown, whichever is greater. To generate the precision/resolution shown in Table C.2, one of the units-under-test was tested repetitively (a total of 10-times with re-insertion between tests) to obtain the average test value and standard deviation. Using this test data MIL-HDBK-814 90/90 KTL statistics were applied to the measured standard deviation to generate the final measurement range. This value encompasses the precision/resolution of all aspects of the test system, including the LTS2020 mainframe, family board, socket assembly and DUT board as well as insertion error. In some cases, the measurement resolution is limited by the internal DACs, which results in a measured standard deviation of zero. In these instances the precision/resolution will be reported back as the LSB of the DAC.

Note that the testing and statistics used in this document are based on an "analysis of variables" technique, which relies on small sample sizes to qualify much larger lot sizes (see MIL-HDBK-814, p. 91 for a discussion of statistical treatments). Not all measured parameters are well suited to this approach due to inherent large variations. If necessary, larger samples sizes could be used to qualify these parameters using an "attributes" approach.



Table C.1. Measured parameters and test conditions for the RH117K Positive Adjustable Regulator.

| Parameter                       | Symbol    | Test Conditions           |
|---------------------------------|-----------|---------------------------|
| Reference Voltage-1 (V)         | VREF1     | VDIFF=3V IL=10mA          |
| Reference Voltage-2 (V)         | VREF2     | VDIFF=40V IL=10mA         |
| Reference Voltage-3 (V)         | VREF3     | VDIFF=3V IL=0.5A          |
| Reference Voltage-4 (V)         | VREF4     | VDIFF=40V IL=0.15A        |
| Line Regulation (%/V)           | LINE REG  | VDIFF=3V TO 40V IL=10mA   |
| Load Regulation-1 (V)           | LOAD REG1 | VOUT<=5V IL=10mA TO 0.5A  |
| Load Regulation-2 (%)           | LOAD REG2 | VOUT>=5V IL=10mA TO 0.5A  |
| Adjust Pin Current-1 (A)        | IADJ1     | VDIFF=2.5V IL=10mA        |
| Adjust Pin Current-2 (A)        | IADJ2     | VDIFF=5V IL=10mA          |
| Adjust Pin Current-3 (A)        | IADJ3     | VDIFF=40V IL=10mA         |
| Adjust Pin Current Change-1 (A) | ΔIADJ1    | VDIFF=5V IL=10mA TO 0.5A  |
| Adjust Pin Current Change-2 (A) | ΔIADJ2    | VDIFF=2.5V TO 40V IL=10mA |
| Minimum Load Current (A)        | IMIN      | VDIFF=40V                 |
| Current Limit-1 (A)             | ISC1      | VIN-VOUT=15V              |
| Current Limit-2 (A)             | ISC2      | VIN-VOUT=40V              |

Table C.2. Measured parameters, pre-irradiation specifications and measurement precision for the RH117K Positive Adjustable Regulator.

| Parameter                     | Pre-Irradiation Specification |          | Measurement Precision/Resolution |
|-------------------------------|-------------------------------|----------|----------------------------------|
|                               | MIN                           | MAX      |                                  |
| Reference Voltage (V)         | 1.20E+00                      | 1.30E+00 | ±1.00E-03                        |
| Line Regulation (%/V)         |                               | 2.00E-02 | ±2.00E-04                        |
| Load Regulation-1 (V)         |                               | 1.50E-02 | ±4.26E-04                        |
| Load Regulation-2 (%)         | -3.00E-01                     | 3.00E-01 | ±4.00E-02                        |
| Adjust Pin Current (A)        |                               | 1.00E-04 | ±2.20E-07                        |
| Adjust Pin Current Change (A) | -5.00E-06                     | 5.00E-06 | ±5.00E-07                        |
| Minimum Load Current (A)      |                               | 5.00E-03 | ±3.00E-05                        |
| Current Limit-1 (A)           | 1.50E+00                      |          | ±1.50E-02                        |
| Current Limit-2 (A)           | 3.00E-01                      |          | ±1.70E-02                        |



**Appendix D: List of Figures Used in the Results Section (Section 5)**

- 5.1. Reference Voltage-1 (V) @  $V_{DIFF}=3V$   $I_L=10mA$
- 5.2. Reference Voltage-2 (V) @  $V_{DIFF}=40V$   $I_L=10mA$
- 5.3. Reference Voltage-3 (V) @  $V_{DIFF}=3V$   $I_L=0.5A$
- 5.4. Reference Voltage-4 (V) @  $V_{DIFF}=40V$   $I_L=0.15A$
- 5.5. Line Regulation (%/V) @  $V_{DIFF}=3V$  TO  $40V$   $I_L=10mA$
- 5.6. Load Regulation-1 (V) @  $V_{OUT}\leq 5V$   $I_L=10mA$  TO  $0.5A$
- 5.7. Load Regulation-2 (%) @  $V_{OUT}\geq 5V$   $I_L=10mA$  TO  $0.5A$
- 5.8. Adjust Pin Current-1 (A) @  $V_{DIFF}=2.5V$   $I_L=10mA$
- 5.9. Adjust Pin Current-2 (A) @  $V_{DIFF}=5V$   $I_L=10mA$
- 5.10. Adjust Pin Current-3 (A) @  $V_{DIFF}=40V$   $I_L=10mA$
- 5.11. Adjust Pin Current Change-1 (A) @  $V_{DIFF}=5V$   $I_L=10mA$  TO  $0.5A$
- 5.12. Adjust Pin Current Change-2 (A) @  $V_{DIFF}=2.5V$  TO  $40V$   $I_L=10mA$
- 5.13. Minimum Load Current (A) @  $V_{DIFF}=40V$
- 5.14. Current Limit-1 (A) @  $V_{IN}-V_{OUT}=15V$
- 5.15. Current Limit-2 (A) @  $V_{IN}-V_{OUT}=40V$