



Radiation Lot Acceptance Testing (RLAT) of the RH1498MW Dual Rail-to-Rail Input and Output Precision C-Load Op Amp for Linear Technology

Customer: Linear Technology, PO# 71928L

RAD Job Number: 15-0091

Part Type Tested: RH1498MW Dual Rail-to-Rail Input and Output Precision C-Load Op Amp, Linear Technology RH1498M Datasheet Revision F.

Traceability Information: Fab Lot Number: W1403645.3, Lot Number: 759406.1, Wafer Number: 10, Date Code: 1422A. See photograph of unit under test in Appendix A.

Quantity of Units: 12 units received, 5 units for biased irradiation, 5 units for unbiased irradiation and 2 units for control. Serial numbers 680, 681, 682, 683 and 684 were biased during irradiation, serial numbers 685, 686, 688, 689 and 690 were unbiased during irradiation and serial numbers 691 and 692 were used as control. See Appendix B for the radiation bias connection table.

Radiation and Electrical Test Increments: 50rad(Si)/s ionizing radiation with electrical test increments: pre-irradiation, 20krad(Si), 50krad(Si), 100krad(Si) and 200krad(Si).

Pre-Irradiation Burn-In: Burn-In performed by Linear Technology prior to receipt by RAD

Overtest and Post-Irradiation Anneal: No overtest. 24-hour room temperature anneal followed by a 168-hour 100°C anneal. Both anneals were performed in the same electrical bias condition as the irradiations. Electrical measurements were made following each anneal increment.

Radiation Test Standard: MIL-STD-750 TM1019 and/or MIL-STD-883 TM1019 Condition A and Linear Technology RH1498M Datasheet Revision F.

Test Hardware and Software: LTS2020 Automated Tester, Entity ID TS04, Calibration Date: 4/30/2014, Calibration Due: 4/30/2015. LTS2101 Family Board, Entity ID FB02. LTS0600 Test Fixture, Entity ID TF03. RH1498 DUT Board. Test Program: RH1498X.SRC

Facility and Radiation Source: Aeroflex RAD's, Colorado Springs, CO. Gamma rays provided by JLSA 81-24 Co60 source. Dosimetry performed by Air Ionization Chamber (AIC) traceable to NIST. Aeroflex RAD's dosimetry has been audited by DLA and Aeroflex RAD has been awarded Laboratory Suitability for MIL-STD-750 and MIL-STD-883 TM 1019.

Irradiation and Test Temperature: Room temperature controlled to 24°C±6°C per MIL-STD-883 and MIL-STD-750.

RLAT Test Result:

- **PASSED the total ionizing dose test to the 200krad(Si) dose level**
- **PASSED following 24-hour room temperature anneal**
- **PASSED following 168-hour 100°C anneal**



1.0. Overview and Background

It is well known that total dose ionizing radiation can cause parametric degradation and ultimately functional failure in electronic devices. The damage occurs via electron-hole pair production, transport and trapping in the dielectric and interface regions. In discrete devices the bulk of the damage is frequently manifested as a reduction in the gain and/or breakdown voltage of the device. The damage will usually anneal with time following the end of the radiation exposure. Due to this annealing, and to ensure a worst-case test condition MIL-STD-883H TM1019 calls out a dose rate of 50 to 300rad(Si)/s as Condition A and further specifies that the time from the end of an incremental radiation exposure and electrical testing shall be 1-hour or less and the total time from the end of one incremental irradiation to the beginning of the next incremental radiation step should be 2-hours or less. The work described in this report was performed to meet MIL-STD-883H TM1019 Condition A.

2.0. Radiation Test Apparatus

The total ionizing dose testing described in this final report was performed using the facilities at Aeroflex RAD's Longmire Laboratories in Colorado Springs, CO. The high dose rate total ionizing dose (TID) source is a JLSA 81-24 irradiator modified to provide a panoramic exposure. The Co-60 rods are held in the base of the irradiator heavily shielded by lead. During the radiation exposures the rod is raised by an electronic timer/controller and the exposure is performed in air. The dose rate for this irradiator in this configuration ranges from $<1\text{rad(Si)/s}$ to a maximum of approximately 300rad(Si)/s , determined by the distance from the source. For high-dose rate experiments the bias boards are placed in a radial fashion equidistant from the raised Co-60 rods with the distance adjusted to provide the required dose rate. The irradiator calibration is maintained by Aeroflex RAD Longmire Laboratories using air ionization chamber (AIC) equipment calibrated with traceability to the National Institute of Standards and Technology (NIST). Figure 2.1 shows a photograph of the JLSA 81-24 Co-60 irradiator at Aeroflex RAD's Longmire Laboratory facility.

Aeroflex RAD is currently certified by the Defense Supply Center Columbus (DLA) for Laboratory Suitability under MIL STD 750 and MIL-STD-883H. Additional details regarding Aeroflex RAD dosimetry for TM1019 Condition A testing are available in Aeroflex RAD's report to DLA entitled: "Dose Rate Mapping of the J.L. Shepherd and Associates Model 81 Irradiator Installed by Radiation Assured Devices".



Figure 2.1. Aeroflex RAD's high dose rate Co-60 irradiator. The dose rate is obtained by positioning the device-under-test at a fixed distance from the gamma cell. The dose rate for this irradiator varies from approximately 300rad(Si)/s close to the rods down to 1rad(Si)/s at a distance of approximately 2-feet.



3.0. Radiation Test Conditions

The RH1498MW Dual Rail-to-Rail Input and Output Precision C-Load Op Amp described in this final report were irradiated using a split +/-15V supply and with all pins tied to ground, that is biased and unbiased. See the TID Bias Table in Appendix B for the full bias circuits. In our opinion, this bias circuit satisfies the requirements of MIL-STD-883H TM1019 Section 3.9.3 Bias and Loading Conditions which states "The bias applied to the test devices shall be selected to produce the greatest radiation induced damage or the worst-case damage for the intended application, if known. While maximum voltage is often worst case some bipolar linear device parameters (e.g. input bias current or maximum output load current) exhibit more degradation with 0 V bias."

The devices were irradiated to a maximum total ionizing dose level of 200krad(Si) with incremental readings at 20krad(Si), 50krad(Si) and 100krad(Si). Electrical testing occurred within one hour following the end of each irradiation segment. For intermediate irradiations, the parts were tested and returned to total dose exposure within two hours from the end of the previous radiation increment.

The TID bias board was positioned in the Co-60 cell to provide the required minimum of 50rad(Si)/s and was located inside a lead-aluminum enclosure. The lead-aluminum enclosure is required under MIL-STD-883H TM1019 Section 3.4 that reads as follows: "Lead/Aluminum (Pb/Al) container. Test specimens shall be enclosed in a Pb/Al container to minimize dose enhancement effects caused by low-energy, scattered radiation. A minimum of 1.5 mm Pb, surrounding an inner shield of at least 0.7 mm Al, is required. This Pb/Al container produces an approximate charged particle equilibrium for Si and for TLDs such as CaF₂. The radiation field intensity shall be measured inside the Pb/Al container (1) initially, (2) when the source is changed, or (3) when the orientation or configuration of the source, container, or test-fixture is changed. This measurement shall be performed by placing a dosimeter (e.g., a TLD) in the device-irradiation container at the approximate test-device position. If it can be demonstrated that low energy scattered radiation is small enough that it will not cause dosimetry errors due to dose enhancement, the Pb/Al container may be omitted."

The final dose rate within the high dose rate lead-aluminum enclosure was determined using calibration calculations based on air ionization chamber (AIC) dosimetry performed just prior to beginning the total dose irradiations. The final dose rate for this work was 54.25rad(Si)/s with a precision of ±5%.



4.0. Tested Parameters

During the total ionizing dose characterization testing the following electrical parameters were measured pre- and post-irradiation:

1. +Supply Current 15V (A) @ VS=+/-15V
2. -Supply Current 15V (A) @ VS=+/-15V
3. Input Offset Voltage1_1 15V (V) @ VS=+/-15V, VCM=0V
4. Input Offset Voltage1_2 15V (V) @ VS=+/-15V, VCM=0V
5. Input Offset Current1_1 15V (A) @ VS=+/-15V, VCM=0V
6. Input Offset Current1_2 15V (A) @ VS=+/-15V, VCM=0V
7. +Input Bias Current1_1 15V (A) @ VS=+/-15V, VCM=0V
8. +Input Bias Current1_2 15V (A) @ VS=+/-15V, VCM=0V
9. -Input Bias Current1_1 15V (A) @ VS=+/-15V, VCM=0V
10. -Input Bias Current1_2 15V (A) @ VS=+/-15V, VCM=0V
11. Input Offset Voltage2_1 15V (V) @ VS=+/-15V, VCM=15V
12. Input Offset Voltage2_2 15V (V) @ VS=+/-15V, VCM=15V
13. Input Offset Current2_1 15V (A) @ VS=+/-15V, VCM=15V
14. Input Offset Current2_2 15V (A) @ VS=+/-15V, VCM=15V
15. +Input Bias Current2_1 15V (A) @ VS=+/-15V, VCM=15V
16. +Input Bias Current2_2 15V (A) @ VS=+/-15V, VCM=15V
17. -Input Bias Current2_1 15V (A) @ VS=+/-15V, VCM=15V
18. -Input Bias Current2_2 15V (A) @ VS=+/-15V, VCM=15V
19. Input Offset Voltage3_1 15V (V) @ VS=+/-15V, VCM=-15V
20. Input Offset Voltage3_2 15V (V) @ VS=+/-15V, VCM=-15V
21. Input Offset Current3_1 15V (A) @ VS=+/-15V, VCM=-15V
22. Input Offset Current3_2 15V (A) @ VS=+/-15V, VCM=-15V
23. +Input Bias Current3_1 15V (A) @ VS=+/-15V, VCM=-15V
24. +Input Bias Current3_2 15V (A) @ VS=+/-15V, VCM=-15V
25. -Input Bias Current3_1 15V (A) @ VS=+/-15V, VCM=-15V
26. -Input Bias Current3_2 15V (A) @ VS=+/-15V, VCM=-15V
27. Output Voltage Swing High1_1 15V (V) @ VS=+/-15V, IL=0mA
28. Output Voltage Swing High1_2 15V (V) @ VS=+/-15V, IL=0mA
29. Output Voltage Swing High2_1 15V (V) @ VS=+/-15V, IL=1mA
30. Output Voltage Swing High2_2 15V (V) @ VS=+/-15V, IL=1mA
31. Output Voltage Swing High3_1 15V (V) @ VS=+/-15V, IL=10mA
32. Output Voltage Swing High3_2 15V (V) @ VS=+/-15V, IL=10mA
33. Output Voltage Swing Low1_1 15V (V) @ VS=+/-15V, IL=0mA
34. Output Voltage Swing Low1_2 15V (V) @ VS=+/-15V, IL=0mA
35. Output Voltage Swing Low2_1 15V (V) @ VS=+/-15V, IL=1mA
36. Output Voltage Swing Low2_2 15V (V) @ VS=+/-15V, IL=1mA
37. Output Voltage Swing Low3_1 15V (V) @ VS=+/-15V, IL=10mA



- 38. Output Voltage Swing Low3_2 15V (V) @ $V_S = \pm 15V$, $I_L = 10mA$
- 39. Large Signal Voltage Gain1_1 15V (V/mV) @ $V_S = \pm 15V$, $V_O = \pm 14.5V$, $R_L = 10k\Omega$
- 40. Large Signal Voltage Gain1_2 15V (V/mV) @ $V_S = \pm 15V$, $V_O = \pm 14.5V$, $R_L = 10k\Omega$
- 41. Large Signal Voltage Gain2_1 15V (V/mV) @ $V_S = \pm 15V$, $V_O = \pm 10V$, $R_L = 2k\Omega$
- 42. Large Signal Voltage Gain2_2 15V (V/mV) @ $V_S = \pm 15V$, $V_O = \pm 10V$, $R_L = 2k\Omega$
- 43. Common Mode Rejection Ratio1_1 15V (dB) @ $V_S = \pm 15V$, $V_{CM} = \pm 15V$
- 44. Common Mode Rejection Ratio1_2 15V (dB) @ $V_S = \pm 15V$, $V_{CM} = \pm 15V$
- 45. CMRR Match1 15V (dB) @ $V_S = \pm 15V$, $V_{CM} = \pm 15V$
- 46. Power Supply Rejection Ratio1_1 (dB) @ $V_S = \pm 2V$ to $\pm 16V$
- 47. Power Supply Rejection Ratio1_2 (dB) @ $V_S = \pm 2V$ to $\pm 16V$
- 48. PSRR Match1 15V (dB) @ $V_S = \pm 2V$ to $\pm 16V$
- 49. +Short-Circuit Current1_1 15V (A) @ $V_S = \pm 15V$, $V_{OUT} = 0V$
- 50. +Short-Circuit Current1_2 15V (A) @ $V_S = \pm 15V$, $V_{OUT} = 0V$
- 51. -Short-Circuit Current1_1 15V (A) @ $V_S = \pm 15V$, $V_{OUT} = 0V$
- 52. -Short-Circuit Current1_2 15V (A) @ $V_S = \pm 15V$, $V_{OUT} = 0V$
- 53. Gain-Bandwidth Product1_1 15V (MHz) @ $V_S = \pm 15V$, $f = 100kHz$
- 54. Gain-Bandwidth Product1_2 15V (MHz) @ $V_S = \pm 15V$, $f = 100kHz$
- 55. +Slew Rate1_1 15V (V/ μs) @ $V_S = \pm 15V$, $A_V = 1$, $R_L = 10k\Omega$
- 56. +Slew Rate1_2 15V (V/ μs) @ $V_S = \pm 15V$, $A_V = 1$, $R_L = 10k\Omega$
- 57. -Slew Rate1_1 15V (V/ μs) @ $V_S = \pm 15V$, $A_V = 1$, $R_L = 10k\Omega$
- 58. -Slew Rate1_2 15V (V/ μs) @ $V_S = \pm 15V$, $A_V = 1$, $R_L = 10k\Omega$
- 59. +Supply Current 5V (A) @ $V_S = +5V$
- 60. -Supply Current 5V (A) @ $V_S = +5V$
- 61. Input Offset Voltage1_1 5V (V) @ $V_S = +5V$, $V_{CM} = 0V$
- 62. Input Offset Voltage1_2 5V (V) @ $V_S = +5V$, $V_{CM} = 0V$
- 63. Input Offset Current1_1 5V (A) @ $V_S = +5V$, $V_{CM} = 0V$
- 64. Input Offset Current1_2 5V (A) @ $V_S = +5V$, $V_{CM} = 0V$
- 65. +Input Bias Current1_1 5V (A) @ $V_S = +5V$, $V_{CM} = 0V$
- 66. +Input Bias Current1_2 5V (A) @ $V_S = +5V$, $V_{CM} = 0V$
- 67. -Input Bias Current1_1 5V (A) @ $V_S = +5V$, $V_{CM} = 0V$
- 68. -Input Bias Current1_2 5V (A) @ $V_S = +5V$, $V_{CM} = 0V$
- 69. Input Offset Voltage2_1 5V (V) @ $V_S = +5V$, $V_{CM} = 5V$
- 70. Input Offset Voltage2_2 5V (V) @ $V_S = +5V$, $V_{CM} = 5V$
- 71. Input Offset Current2_1 5V (A) @ $V_S = +5V$, $V_{CM} = 5V$
- 72. Input Offset Current2_2 5V (A) @ $V_S = +5V$, $V_{CM} = 5V$
- 73. +Input Bias Current2_1 5V (A) @ $V_S = +5V$, $V_{CM} = 5V$
- 74. +Input Bias Current2_2 5V (A) @ $V_S = +5V$, $V_{CM} = 5V$
- 75. -Input Bias Current2_1 5V (A) @ $V_S = +5V$, $V_{CM} = 5V$
- 76. -Input Bias Current2_2 5V (A) @ $V_S = +5V$, $V_{CM} = 5V$
- 77. Output Voltage Swing High1_1 5V (V) @ $V_S = +5V$, $I_L = 0mA$
- 78. Output Voltage Swing High1_2 5V (V) @ $V_S = +5V$, $I_L = 0mA$
- 79. Output Voltage Swing High2_1 5V (V) @ $V_S = +5V$, $I_L = 1mA$



TID Report
15-0091 03/20/15 R1.0

Aeroflex RAD
5030 Centennial Blvd.
Colorado Springs, CO 80919
(719) 531-0800

- 80. Output Voltage Swing High2_2 5V (V) @ VS=+5V, IL=1mA
- 81. Output Voltage Swing High3_1 5V (V) @ VS=+5V, IL=2.5mA
- 82. Output Voltage Swing High3_2 5V (V) @ VS=+5V, IL=2.5mA
- 83. Output Voltage Swing Low1_1 5V (V) @ VS=+5V, IL=0mA
- 84. Output Voltage Swing Low1_2 5V (V) @ VS=+5V, IL=0mA
- 85. Output Voltage Swing Low2_1 5V (V) @ VS=+5V, IL=1mA
- 86. Output Voltage Swing Low2_2 5V (V) @ VS=+5V, IL=1mA
- 87. Output Voltage Swing Low3_1 5V (V) @ VS=+5V, IL=2.5mA
- 88. Output Voltage Swing Low3_2 5V (V) @ VS=+5V, IL=2.5mA
- 89. Large Signal Voltage Gain1_1 5V (V/mV) @ VS=+5V, VO=75mV TO 4.8V, RL=10kΩ
- 90. Large Signal Voltage Gain1_2 5V (V/mV) @ VS=+5V, VO=75mV TO 4.8V, RL=10kΩ
- 91. Common Mode Rejection Ratio1_1 5V (dB) @ VS=+5V, VCM=0 TO 5V
- 92. Common Mode Rejection Ratio1_2 5V (dB) @ VS=+5V, VCM=0 TO 5V
- 93. CMRR Match1 5V (dB) @ VS=+5V
- 94. Power Supply Rejection Ratio1_1 5V (dB) @ VS=+4.5V TO +12V
- 95. Power Supply Rejection Ratio1_2 5V (dB) @ VS=+4.5V TO +12V
- 96. PSRR Match1 5V (dB) @ VS=+4.5V to +12V
- 97. +Short-Circuit Current1_1 5V (A) @ VS=+5V, VOUT=1/2 SUPPLY
- 98. +Short-Circuit Current1_2 5V (A) @ VS=+5V, VOUT=1/2 SUPPLY
- 99. -Short-Circuit Current1_1 5V (A) @ VS=+5V, VOUT=1/2 SUPPLY
- 100. -Short-Circuit Current1_2 5V (A) @ VS=+5V, VOUT=1/2 SUPPLY
- 101. +Slew Rate1_1 5V (V/μs) @ VS=+/-2.5V, AV=1, RL=10kΩ
- 102. +Slew Rate1_2 5V (V/μs) @ VS=+/-2.5V, AV=1, RL=10kΩ
- 103. -Slew Rate1_1 5V (V/μs) @ VS=+/-2.5V, AV=1, RL=10kΩ
- 104. -Slew Rate1_2 5V (V/μs) @ VS=+/-2.5V, AV=1, RL=10kΩ

Appendix C details the measured parameters, test conditions, pre-irradiation specification and measurement resolution for each of the measurements.

The parametric data was obtained as "read and record" and all the raw data plus an attributes summary are contained in this report as well as in a separate Excel file. The attributes data contains the average, standard deviation and the average with the KTL values applied. The KTL value used in this work is 2.742 per MIL-HDBK-814 using one sided tolerance limits of 90/90 and a 5-piece sample size. The 90/90 KTL values were selected to match the statistical levels specified in the MIL-PRF-38535 sampling plan for the qualification of a radiation hardness assured (RHA) component. Note that the following criteria must be met for a device to pass the total ionizing dose test: following the radiation exposure each of the 5 pieces irradiated under electrical bias shall pass the specification value. The units irradiated without electrical bias and the KTL statistics are included in this report for reference only. If any of the 5 pieces irradiated under electrical bias exceed the device post radiation data sheet specification limits, then the lot could be logged as a failure.



5.0. Total Ionizing Dose Test Results

Based on this criterion the RH1498MW Dual Rail-to-Rail Input and Output Precision C-Load Op Amp (from the lot traceability information provided on the first page of this test report) the units-under-test:

- PASSED the total ionizing dose test to the 200krad(Si) dose level
- PASSED following 24-hour room temperature anneal
- PASSED following 168-hour 100°C anneal

Figures 5.1 through 5.104 show plots of all the measured parameters versus total ionizing dose while Tables 5.1 - 5.104 show the corresponding raw data for each of these parameters. In the data plots the solid diamonds are the average of the measured data points for the sample irradiated under electrical bias while the shaded diamonds are the average of the measured data points for the units irradiated with all pins tied to ground. The black lines (solid or dashed) are the upper and/or lower confidence limits, as determined by KTL statistics, on the sample irradiated in the biased condition while the shaded lines (solid or dashed) are the upper and/or lower confidence limits, as determined by KTL statistics, on the sample irradiated in the unbiased condition. The red dotted line(s) are the pre- and/or post-irradiation minimum and/or maximum specification value as defined in the datasheet and/or test plan.

The control units, as expected, show no significant changes to any of the parameters. Therefore we can conclude that the electrical testing remained in control throughout the duration of the tests and the observed degradation was due to the radiation exposure. Appendix D lists the figures used in this section to facilitate the location of a particular parameter.

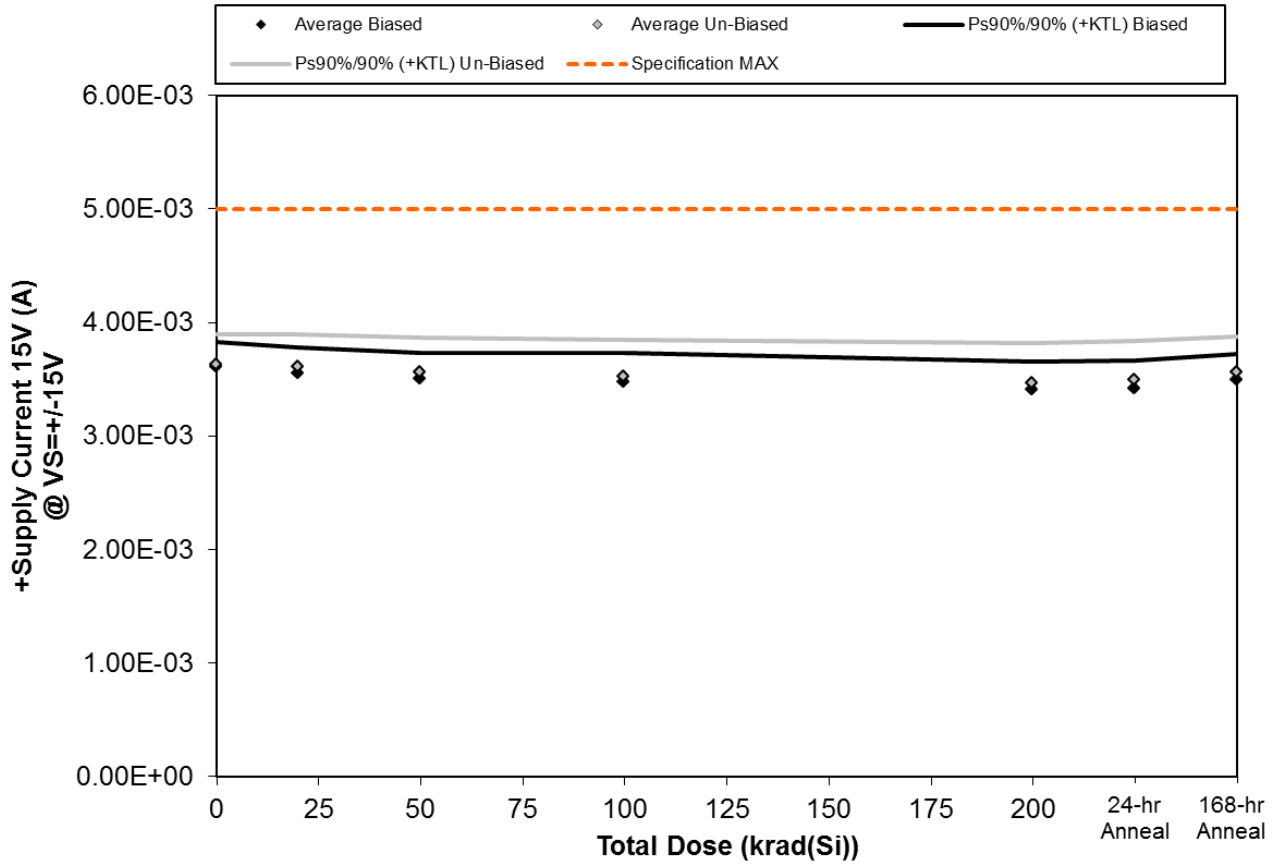

Figure 5.1. Plot of +Supply Current 15V (A) @ VS=+-15V versus total dose. The solid diamonds are the average of the measured data points for the samples irradiated under electrical bias while the shaded diamonds are the average of the measured data points for the samples irradiated with all pins tied to ground. The black lines (solid and/or dashed) are the upper and/or lower confidence limits, as determined by KTL statistics, on the samples irradiated under electrical bias while the gray lines (solid and/or dashed) are the upper and/or lower confidence limits, as determined by KTL statistics, on the samples irradiated in the unbiased condition. The red dotted line(s) are the pre- and/or post-irradiation minimum and/or maximum specification value as defined in the datasheet and/or test plan.



TID Report
15-0091 03/20/15 R1.0

Aeroflex RAD
5030 Centennial Blvd.
Colorado Springs, CO 80919
(719) 531-0800

Table 5.1. Raw data for +Supply Current 15V (A) @ VS=+/-15V versus total dose, including the statistical analysis, specification and the status of the testing (pass/fail).

+Supply Current 15V (A) @ VS=+/-15V	Total Dose (krad(Si))					24-hr Anneal	168-hr Anneal
	0	20	50	100	200		
Device							
680	3.61E-03	3.56E-03	3.49E-03	3.53E-03	3.38E-03	3.40E-03	3.49E-03
681	3.58E-03	3.51E-03	3.46E-03	3.42E-03	3.37E-03	3.39E-03	3.46E-03
682	3.72E-03	3.66E-03	3.61E-03	3.58E-03	3.54E-03	3.54E-03	3.60E-03
683	3.51E-03	3.44E-03	3.39E-03	3.34E-03	3.31E-03	3.31E-03	3.39E-03
684	3.66E-03	3.60E-03	3.55E-03	3.50E-03	3.47E-03	3.47E-03	3.55E-03
685	3.56E-03	3.53E-03	3.49E-03	3.44E-03	3.39E-03	3.40E-03	3.48E-03
686	3.58E-03	3.54E-03	3.50E-03	3.46E-03	3.40E-03	3.43E-03	3.51E-03
688	3.80E-03	3.78E-03	3.76E-03	3.73E-03	3.69E-03	3.71E-03	3.76E-03
689	3.60E-03	3.57E-03	3.54E-03	3.51E-03	3.45E-03	3.48E-03	3.53E-03
690	3.62E-03	3.63E-03	3.54E-03	3.49E-03	3.41E-03	3.44E-03	3.53E-03
691	3.63E-03	3.63E-03	3.62E-03	3.63E-03	3.63E-03	3.63E-03	3.63E-03
692	3.59E-03	3.59E-03	3.59E-03	3.59E-03	3.59E-03	3.60E-03	3.59E-03
Biased Statistics							
Average Biased	3.61E-03	3.55E-03	3.50E-03	3.48E-03	3.41E-03	3.42E-03	3.50E-03
Std Dev Biased	7.92E-05	8.21E-05	8.34E-05	9.26E-05	8.97E-05	8.76E-05	8.08E-05
Ps90%/90% (+KTL) Biased	3.83E-03	3.78E-03	3.73E-03	3.73E-03	3.66E-03	3.66E-03	3.72E-03
Ps90%/90% (-KTL) Biased	3.40E-03	3.33E-03	3.27E-03	3.22E-03	3.17E-03	3.18E-03	3.28E-03
Un-Biased Statistics							
Average Un-Biased	3.63E-03	3.61E-03	3.56E-03	3.53E-03	3.47E-03	3.49E-03	3.56E-03
Std Dev Un-Biased	9.85E-05	1.05E-04	1.11E-04	1.18E-04	1.27E-04	1.26E-04	1.13E-04
Ps90%/90% (+KTL) Un-Biased	3.90E-03	3.90E-03	3.87E-03	3.85E-03	3.82E-03	3.84E-03	3.87E-03
Ps90%/90% (-KTL) Un-Biased	3.36E-03	3.32E-03	3.26E-03	3.20E-03	3.12E-03	3.15E-03	3.25E-03
Specification MAX	5.00E-03	5.00E-03	5.00E-03	5.00E-03	5.00E-03	5.00E-03	5.00E-03
Status	PASS	PASS	PASS	PASS	PASS	PASS	PASS

An ISO 9001:2008 and DLA Certified Company

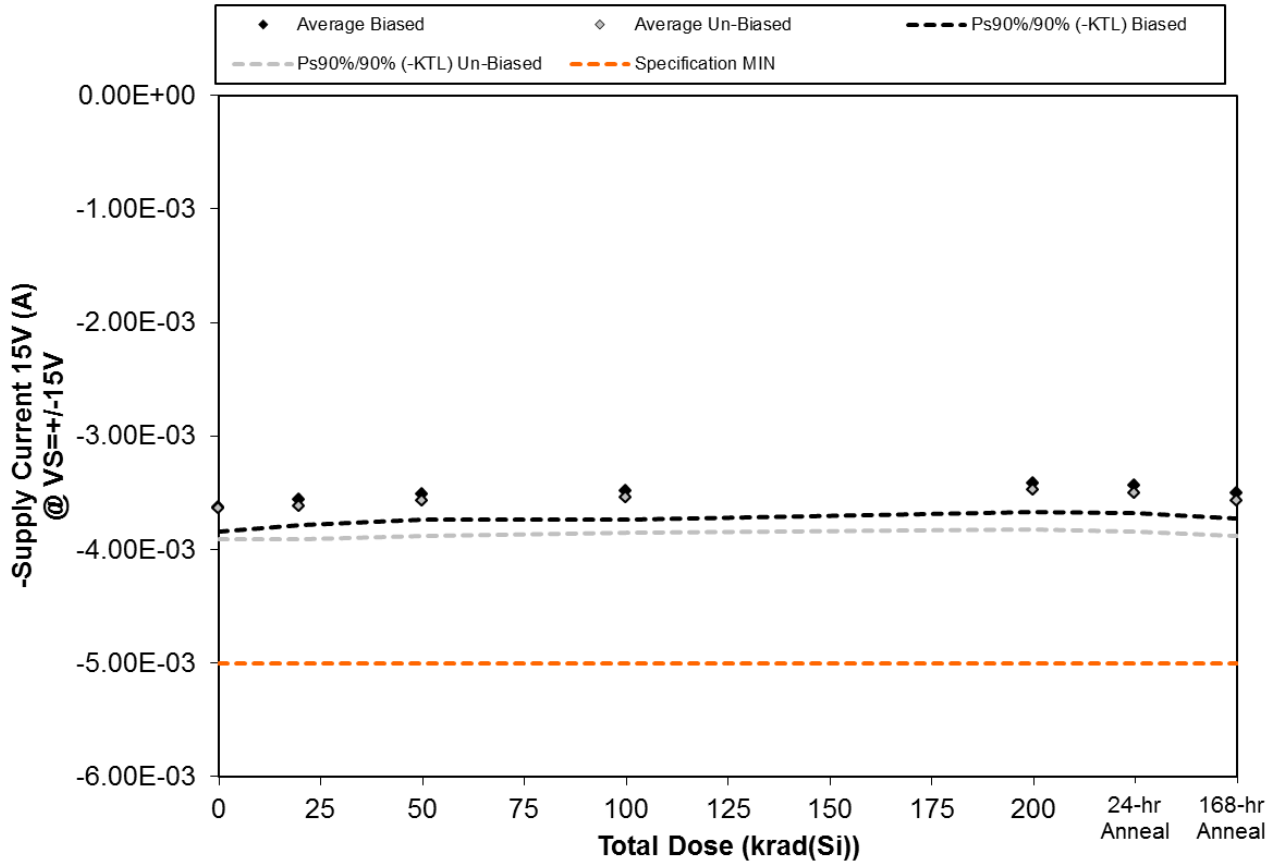

Figure 5.2. Plot of -Supply Current 15V (A) @ VS=+/-15V versus total dose. The solid diamonds are the average of the measured data points for the samples irradiated under electrical bias while the shaded diamonds are the average of the measured data points for the samples irradiated with all pins tied to ground. The black lines (solid and/or dashed) are the upper and/or lower confidence limits, as determined by KTL statistics, on the samples irradiated under electrical bias while the gray lines (solid and/or dashed) are the upper and/or lower confidence limits, as determined by KTL statistics, on the samples irradiated in the unbiased condition. The red dotted line(s) are the pre- and/or post-irradiation minimum and/or maximum specification value as defined in the datasheet and/or test plan.



TID Report
15-0091 03/20/15 R1.0

Aeroflex RAD
5030 Centennial Blvd.
Colorado Springs, CO 80919
(719) 531-0800

Table 5.2. Raw data for -Supply Current 15V (A) @ VS=+/-15V versus total dose, including the statistical analysis, specification and the status of the testing (pass/fail).

-Supply Current 15V (A) @ VS=+/-15V	Total Dose (krad(Si))					24-hr Anneal	168-hr Anneal
	0	20	50	100	200		
Device							
680	-3.62E-03	-3.56E-03	-3.50E-03	-3.54E-03	-3.39E-03	-3.41E-03	-3.50E-03
681	-3.59E-03	-3.52E-03	-3.47E-03	-3.43E-03	-3.38E-03	-3.39E-03	-3.47E-03
682	-3.73E-03	-3.67E-03	-3.62E-03	-3.58E-03	-3.54E-03	-3.55E-03	-3.61E-03
683	-3.52E-03	-3.45E-03	-3.40E-03	-3.35E-03	-3.31E-03	-3.32E-03	-3.40E-03
684	-3.67E-03	-3.61E-03	-3.56E-03	-3.51E-03	-3.47E-03	-3.48E-03	-3.55E-03
685	-3.56E-03	-3.53E-03	-3.49E-03	-3.45E-03	-3.40E-03	-3.41E-03	-3.49E-03
686	-3.58E-03	-3.55E-03	-3.51E-03	-3.47E-03	-3.40E-03	-3.44E-03	-3.51E-03
688	-3.81E-03	-3.79E-03	-3.77E-03	-3.74E-03	-3.70E-03	-3.72E-03	-3.77E-03
689	-3.61E-03	-3.58E-03	-3.55E-03	-3.52E-03	-3.46E-03	-3.48E-03	-3.54E-03
690	-3.62E-03	-3.64E-03	-3.54E-03	-3.50E-03	-3.41E-03	-3.45E-03	-3.54E-03
691	-3.64E-03	-3.64E-03	-3.63E-03	-3.64E-03	-3.64E-03	-3.64E-03	-3.64E-03
692	-3.60E-03	-3.60E-03	-3.60E-03	-3.60E-03	-3.60E-03	-3.60E-03	-3.60E-03
Biased Statistics							
Average Biased	-3.62E-03	-3.56E-03	-3.51E-03	-3.48E-03	-3.42E-03	-3.43E-03	-3.51E-03
Std Dev Biased	7.96E-05	8.19E-05	8.35E-05	9.08E-05	8.98E-05	8.90E-05	8.07E-05
Ps90%/90% (+KTL) Biased	-3.41E-03	-3.34E-03	-3.28E-03	-3.23E-03	-3.17E-03	-3.19E-03	-3.28E-03
Ps90%/90% (-KTL) Biased	-3.84E-03	-3.79E-03	-3.74E-03	-3.73E-03	-3.67E-03	-3.67E-03	-3.73E-03
Un-Biased Statistics							
Average Un-Biased	-3.64E-03	-3.62E-03	-3.57E-03	-3.54E-03	-3.47E-03	-3.50E-03	-3.57E-03
Std Dev Un-Biased	9.79E-05	1.05E-04	1.12E-04	1.17E-04	1.28E-04	1.26E-04	1.13E-04
Ps90%/90% (+KTL) Un-Biased	-3.37E-03	-3.33E-03	-3.26E-03	-3.22E-03	-3.12E-03	-3.16E-03	-3.26E-03
Ps90%/90% (-KTL) Un-Biased	-3.90E-03	-3.91E-03	-3.88E-03	-3.86E-03	-3.82E-03	-3.85E-03	-3.88E-03
Specification MIN	-5.00E-03	-5.00E-03	-5.00E-03	-5.00E-03	-5.00E-03	-5.00E-03	-5.00E-03
Status	PASS	PASS	PASS	PASS	PASS	PASS	PASS

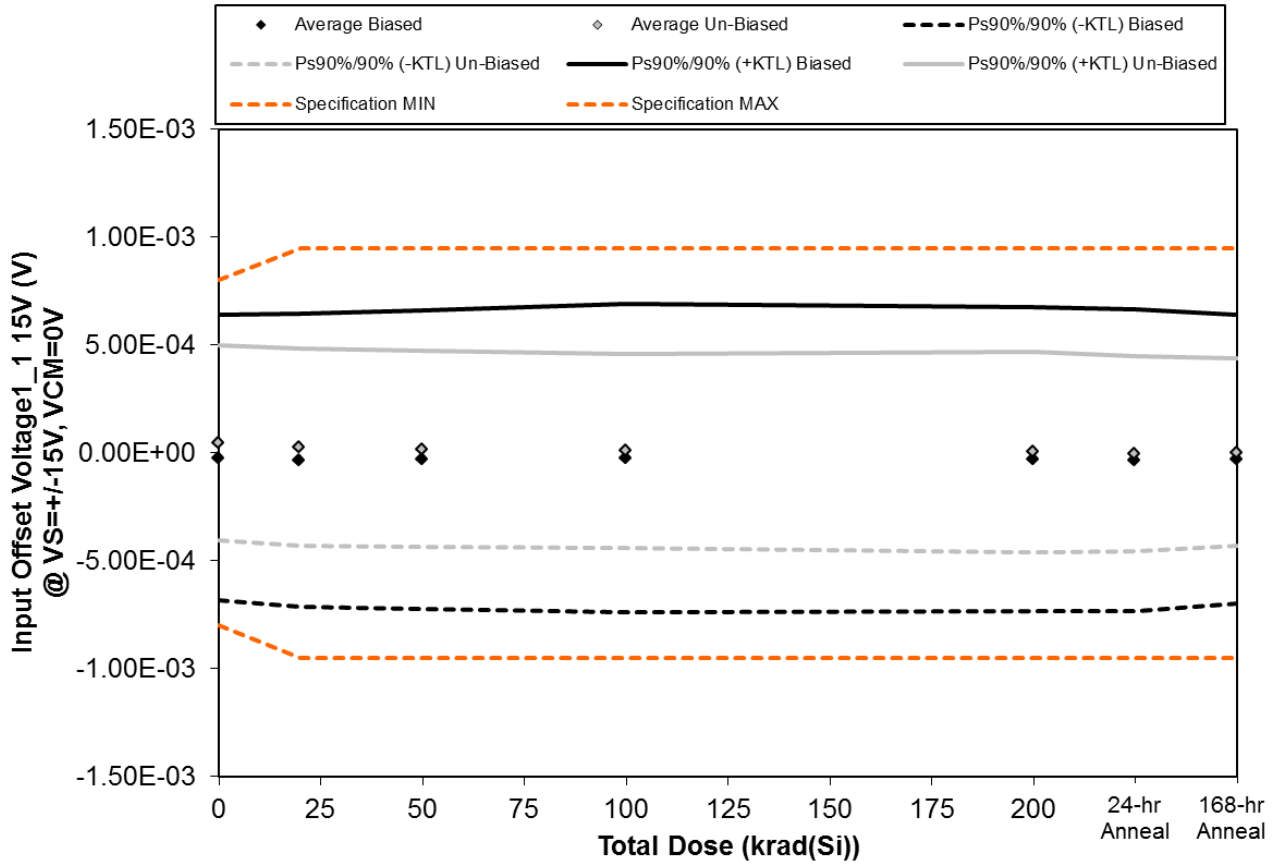

Figure 5.3. Plot of Input Offset Voltage1_1 15V (V) @ VS=+-15V, VCM=0V versus total dose. The solid diamonds are the average of the measured data points for the samples irradiated under electrical bias while the shaded diamonds are the average of the measured data points for the samples irradiated with all pins tied to ground. The black lines (solid and/or dashed) are the upper and/or lower confidence limits, as determined by KTL statistics, on the samples irradiated under electrical bias while the gray lines (solid and/or dashed) are the upper and/or lower confidence limits, as determined by KTL statistics, on the samples irradiated in the unbiased condition. The red dotted line(s) are the pre- and/or post-irradiation minimum and/or maximum specification value as defined in the datasheet and/or test plan.



TID Report
15-0091 03/20/15 R1.0

Aeroflex RAD
5030 Centennial Blvd.
Colorado Springs, CO 80919
(719) 531-0800

Table 5.3. Raw data for Input Offset Voltage1_1 15V (V) @ VS=+/-15V, VCM=0V versus total dose, including the statistical analysis, specification and the status of the testing (pass/fail).

Input Offset Voltage1_1 15V (V) @ VS=+/-15V, VCM=0V	Total Dose (krad(Si))					24-hr	168-hr
	0	20	50	100	200	Anneal	Anneal
Device							
680	3.04E-04	2.99E-04	3.03E-04	3.21E-04	3.00E-04	2.97E-04	2.91E-04
681	-3.10E-04	-3.31E-04	-3.34E-04	-3.35E-04	-3.40E-04	-3.42E-04	-3.23E-04
682	-1.99E-04	-2.15E-04	-2.23E-04	-2.24E-04	-2.32E-04	-2.29E-04	-2.15E-04
683	7.34E-06	6.13E-06	1.13E-05	2.18E-05	2.82E-05	1.62E-05	9.76E-06
684	8.43E-05	7.89E-05	8.65E-05	9.19E-05	8.97E-05	8.48E-05	8.34E-05
685	1.05E-04	9.69E-05	7.96E-05	6.81E-05	6.71E-05	5.65E-05	5.84E-05
686	7.70E-05	6.86E-05	6.25E-05	6.07E-05	5.53E-05	4.56E-05	3.88E-05
688	-2.37E-04	-2.60E-04	-2.66E-04	-2.74E-04	-2.88E-04	-2.89E-04	-2.69E-04
689	1.96E-04	1.73E-04	1.65E-04	1.50E-04	1.51E-04	1.37E-04	1.48E-04
690	8.33E-05	6.13E-05	5.27E-05	4.35E-05	4.17E-05	3.36E-05	3.18E-05
691	-1.84E-04	-1.84E-04	-1.84E-04	-1.83E-04	-1.83E-04	-1.84E-04	-1.84E-04
692	-3.34E-04	-3.33E-04	-3.33E-04	-3.34E-04	-3.33E-04	-3.34E-04	-3.34E-04
Biased Statistics							
Average Biased	-2.25E-05	-3.24E-05	-3.13E-05	-2.51E-05	-3.09E-05	-3.47E-05	-3.10E-05
Std Dev Biased	2.41E-04	2.48E-04	2.53E-04	2.61E-04	2.57E-04	2.54E-04	2.44E-04
Ps90%/90% (+KTL) Biased	6.38E-04	6.47E-04	6.62E-04	6.89E-04	6.73E-04	6.63E-04	6.37E-04
Ps90%/90% (-KTL) Biased	-6.83E-04	-7.12E-04	-7.24E-04	-7.39E-04	-7.35E-04	-7.32E-04	-6.99E-04
Un-Biased Statistics							
Average Un-Biased	4.49E-05	2.79E-05	1.87E-05	9.80E-06	5.36E-06	-3.15E-06	1.74E-06
Std Dev Un-Biased	1.65E-04	1.67E-04	1.65E-04	1.64E-04	1.70E-04	1.65E-04	1.58E-04
Ps90%/90% (+KTL) Un-Biased	4.96E-04	4.86E-04	4.72E-04	4.59E-04	4.70E-04	4.49E-04	4.36E-04
Ps90%/90% (-KTL) Un-Biased	-4.07E-04	-4.30E-04	-4.35E-04	-4.39E-04	-4.60E-04	-4.55E-04	-4.32E-04
Specification MIN	-8.00E-04	-9.50E-04	-9.50E-04	-9.50E-04	-9.50E-04	-9.50E-04	-9.50E-04
Status	PASS	PASS	PASS	PASS	PASS	PASS	PASS
Specification MAX	8.00E-04	9.50E-04	9.50E-04	9.50E-04	9.50E-04	9.50E-04	9.50E-04
Status	PASS	PASS	PASS	PASS	PASS	PASS	PASS

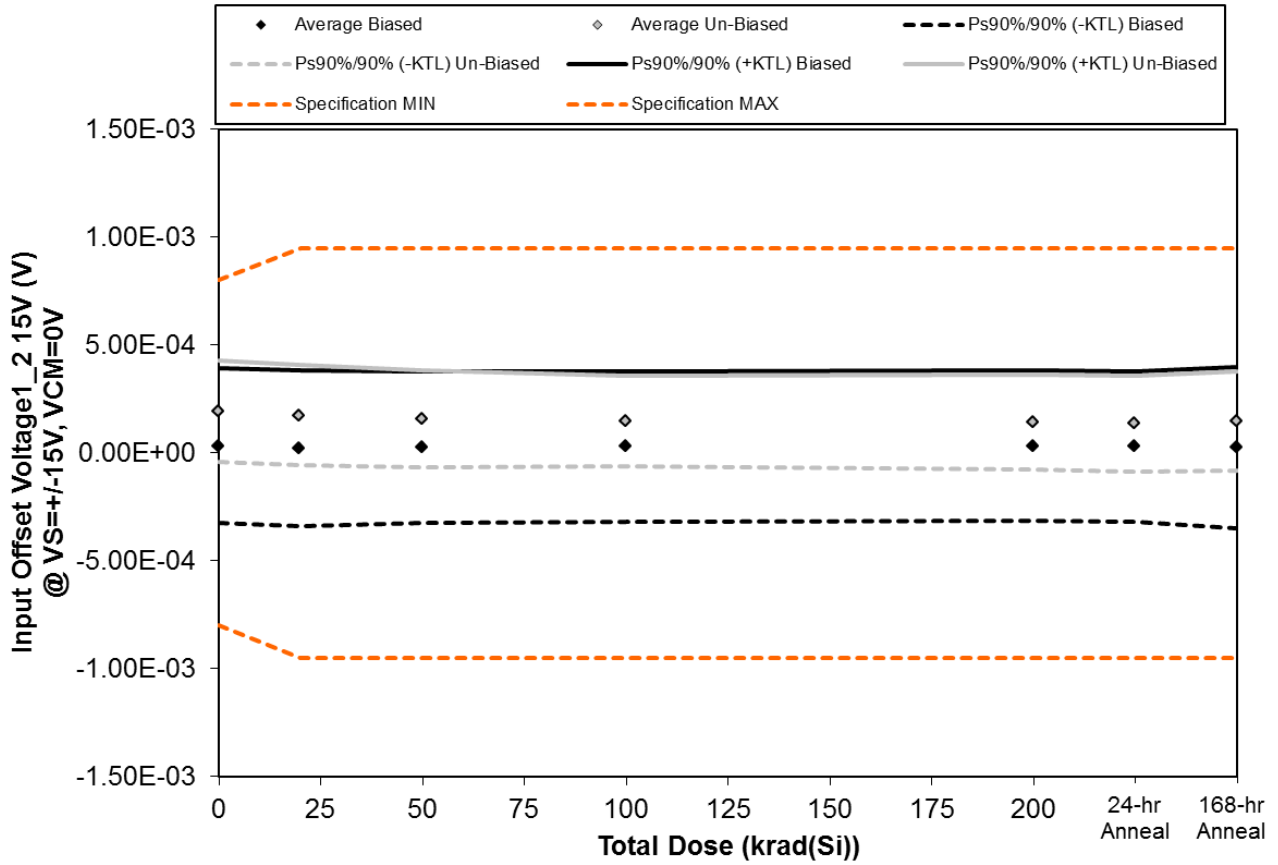

Figure 5.4. Plot of Input Offset Voltage_{1_2} 15V (V) @ VS=±15V, VCM=0V versus total dose. The solid diamonds are the average of the measured data points for the samples irradiated under electrical bias while the shaded diamonds are the average of the measured data points for the samples irradiated with all pins tied to ground. The black lines (solid and/or dashed) are the upper and/or lower confidence limits, as determined by KTL statistics, on the samples irradiated under electrical bias while the gray lines (solid and/or dashed) are the upper and/or lower confidence limits, as determined by KTL statistics, on the samples irradiated in the unbiased condition. The red dotted line(s) are the pre- and/or post-irradiation minimum and/or maximum specification value as defined in the datasheet and/or test plan.



TID Report
15-0091 03/20/15 R1.0

Aeroflex RAD
5030 Centennial Blvd.
Colorado Springs, CO 80919
(719) 531-0800

Table 5.4. Raw data for Input Offset Voltage1_2 15V (V) @ VS=+/-15V, VCM=0V versus total dose, including the statistical analysis, specification and the status of the testing (pass/fail).

Input Offset Voltage1_2 15V (V) @ VS=+/-15V, VCM=0V	Total Dose (krad(Si))					24-hr	168-hr
	0	20	50	100	200	Anneal	Anneal
Device							
680	-5.34E-05	-5.94E-05	-4.84E-05	-5.01E-05	-4.41E-05	-5.25E-05	-6.35E-05
681	3.89E-05	2.93E-05	3.44E-05	3.36E-05	3.67E-05	3.90E-05	2.49E-05
682	-9.87E-05	-1.12E-04	-1.04E-04	-1.00E-04	-9.29E-05	-9.91E-05	-1.12E-04
683	3.86E-05	2.52E-05	2.71E-05	3.05E-05	3.16E-05	2.46E-05	3.50E-05
684	2.41E-04	2.34E-04	2.33E-04	2.33E-04	2.38E-04	2.33E-04	2.42E-04
685	3.35E-04	3.17E-04	2.96E-04	2.73E-04	2.73E-04	2.72E-04	2.88E-04
686	1.20E-04	1.02E-04	8.61E-05	7.31E-05	5.88E-05	6.05E-05	7.23E-05
688	1.94E-04	1.70E-04	1.58E-04	1.49E-04	1.46E-04	1.41E-04	1.49E-04
689	1.36E-04	1.23E-04	1.20E-04	1.09E-04	1.10E-04	1.03E-04	1.02E-04
690	1.75E-04	1.59E-04	1.28E-04	1.21E-04	1.26E-04	1.06E-04	1.23E-04
691	-8.42E-05	-8.66E-05	-8.78E-05	-8.48E-05	-8.70E-05	-8.64E-05	-9.46E-05
692	1.96E-04	1.94E-04	1.95E-04	1.93E-04	1.95E-04	1.94E-04	1.91E-04
Biased Statistics							
Average Biased	3.33E-05	2.33E-05	2.84E-05	2.93E-05	3.39E-05	2.91E-05	2.52E-05
Std Dev Biased	1.31E-04	1.32E-04	1.28E-04	1.27E-04	1.27E-04	1.27E-04	1.36E-04
Ps90%/90% (+KTL) Biased	3.92E-04	3.84E-04	3.79E-04	3.77E-04	3.81E-04	3.78E-04	3.98E-04
Ps90%/90% (-KTL) Biased	-3.25E-04	-3.38E-04	-3.22E-04	-3.19E-04	-3.13E-04	-3.20E-04	-3.47E-04
Un-Biased Statistics							
Average Un-Biased	1.92E-04	1.74E-04	1.58E-04	1.45E-04	1.43E-04	1.37E-04	1.47E-04
Std Dev Un-Biased	8.51E-05	8.45E-05	8.12E-05	7.65E-05	7.98E-05	8.08E-05	8.38E-05
Ps90%/90% (+KTL) Un-Biased	4.25E-04	4.06E-04	3.80E-04	3.55E-04	3.61E-04	3.58E-04	3.76E-04
Ps90%/90% (-KTL) Un-Biased	-4.14E-05	-5.72E-05	-6.51E-05	-6.44E-05	-7.59E-05	-8.49E-05	-8.31E-05
Specification MIN	-8.00E-04	-9.50E-04	-9.50E-04	-9.50E-04	-9.50E-04	-9.50E-04	-9.50E-04
Status	PASS	PASS	PASS	PASS	PASS	PASS	PASS
Specification MAX	8.00E-04	9.50E-04	9.50E-04	9.50E-04	9.50E-04	9.50E-04	9.50E-04
Status	PASS	PASS	PASS	PASS	PASS	PASS	PASS

An ISO 9001:2008 and DLA Certified Company

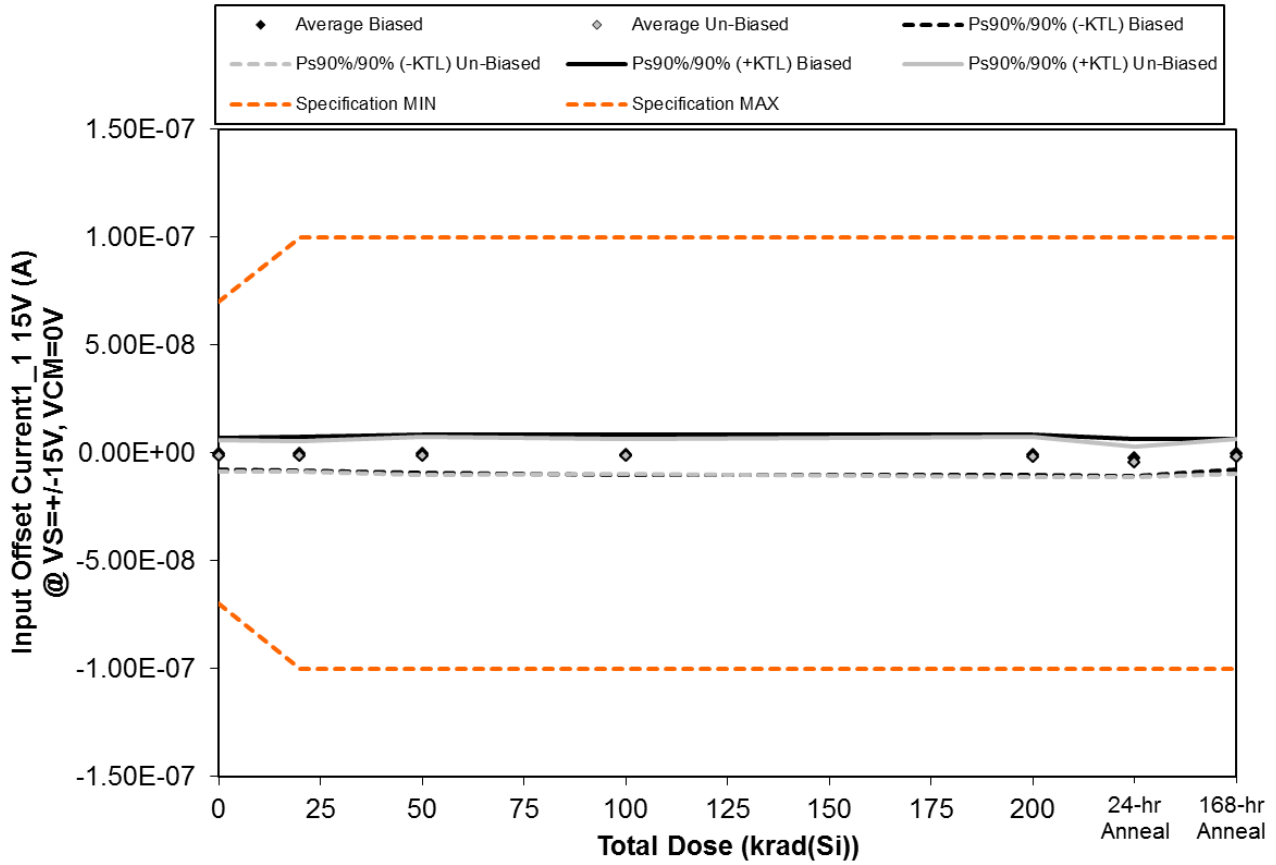

Figure 5.5. Plot of Input Offset Current1_1 15V (A) @ VS=+-15V, VCM=0V versus total dose. The solid diamonds are the average of the measured data points for the samples irradiated under electrical bias while the shaded diamonds are the average of the measured data points for the samples irradiated with all pins tied to ground. The black lines (solid and/or dashed) are the upper and/or lower confidence limits, as determined by KTL statistics, on the samples irradiated under electrical bias while the gray lines (solid and/or dashed) are the upper and/or lower confidence limits, as determined by KTL statistics, on the samples irradiated in the unbiased condition. The red dotted line(s) are the pre- and/or post-irradiation minimum and/or maximum specification value as defined in the datasheet and/or test plan.



TID Report
15-0091 03/20/15 R1.0

Aeroflex RAD
5030 Centennial Blvd.
Colorado Springs, CO 80919
(719) 531-0800

Table 5.5. Raw data for Input Offset Current1_1 15V (A) @ VS=+/-15V, VCM=0V versus total dose, including the statistical analysis, specification and the status of the testing (pass/fail).

Input Offset Current1_1 15V (A) @ VS=+/-15V, VCM=0V	Total Dose (krad(Si))					24-hr Anneal	168-hr Anneal
	0	20	50	100	200		
Device							
680	2.31E-09	2.23E-09	1.53E-09	-2.40E-09	0.00E+00	2.00E-11	1.71E-09
681	-4.41E-09	-4.50E-09	-5.20E-09	-4.53E-09	-4.37E-09	-6.59E-09	-4.24E-09
682	-1.16E-09	-1.31E-09	-1.67E-09	-2.35E-09	-3.37E-09	-4.07E-09	-1.85E-09
683	1.70E-09	2.23E-09	3.27E-09	4.55E-09	4.27E-09	1.37E-09	1.78E-09
684	-7.40E-10	-9.00E-10	0.00E+00	-3.00E-10	-2.00E-10	-1.74E-09	-2.00E-10
685	-2.68E-09	-2.77E-09	-3.47E-09	-4.56E-09	-4.88E-09	-6.03E-09	-2.90E-09
686	-1.83E-09	-1.50E-09	-1.51E-09	-1.60E-09	-1.30E-09	-4.58E-09	-2.01E-09
688	-2.54E-09	-3.00E-09	-3.20E-09	-3.67E-09	-6.00E-09	-6.16E-09	-3.54E-09
689	3.33E-09	2.90E-09	4.35E-09	3.16E-09	2.20E-09	3.20E-10	3.40E-09
690	-2.87E-09	-3.60E-09	-2.95E-09	-1.24E-09	-1.50E-10	-4.67E-09	-3.84E-09
691	-2.01E-09	-2.08E-09	-2.19E-09	-2.30E-09	-2.38E-09	-2.41E-09	-2.51E-09
692	-6.89E-09	-6.91E-09	-7.02E-09	-7.08E-09	-7.13E-09	-7.18E-09	-7.17E-09
Biased Statistics							
Average Biased	-4.60E-10	-4.50E-10	-4.14E-10	-1.01E-09	-7.34E-10	-2.20E-09	-5.60E-10
Std Dev Biased	2.67E-09	2.82E-09	3.24E-09	3.45E-09	3.39E-09	3.19E-09	2.55E-09
Ps90%/90% (+KTL) Biased	6.86E-09	7.27E-09	8.47E-09	8.45E-09	8.57E-09	6.54E-09	6.43E-09
Ps90%/90% (-KTL) Biased	-7.78E-09	-8.17E-09	-9.30E-09	-1.05E-08	-1.00E-08	-1.09E-08	-7.55E-09
Un-Biased Statistics							
Average Un-Biased	-1.32E-09	-1.59E-09	-1.36E-09	-1.58E-09	-2.03E-09	-4.22E-09	-1.78E-09
Std Dev Un-Biased	2.63E-09	2.63E-09	3.28E-09	2.99E-09	3.39E-09	2.64E-09	2.98E-09
Ps90%/90% (+KTL) Un-Biased	5.89E-09	5.61E-09	7.63E-09	6.62E-09	7.26E-09	3.03E-09	6.39E-09
Ps90%/90% (-KTL) Un-Biased	-8.52E-09	-8.80E-09	-1.03E-08	-9.79E-09	-1.13E-08	-1.15E-08	-9.94E-09
Specification MIN	-7.00E-08	-1.00E-07	-1.00E-07	-1.00E-07	-1.00E-07	-1.00E-07	-1.00E-07
Status	PASS	PASS	PASS	PASS	PASS	PASS	PASS
Specification MAX	7.00E-08	1.00E-07	1.00E-07	1.00E-07	1.00E-07	1.00E-07	1.00E-07
Status	PASS	PASS	PASS	PASS	PASS	PASS	PASS

An ISO 9001:2008 and DLA Certified Company

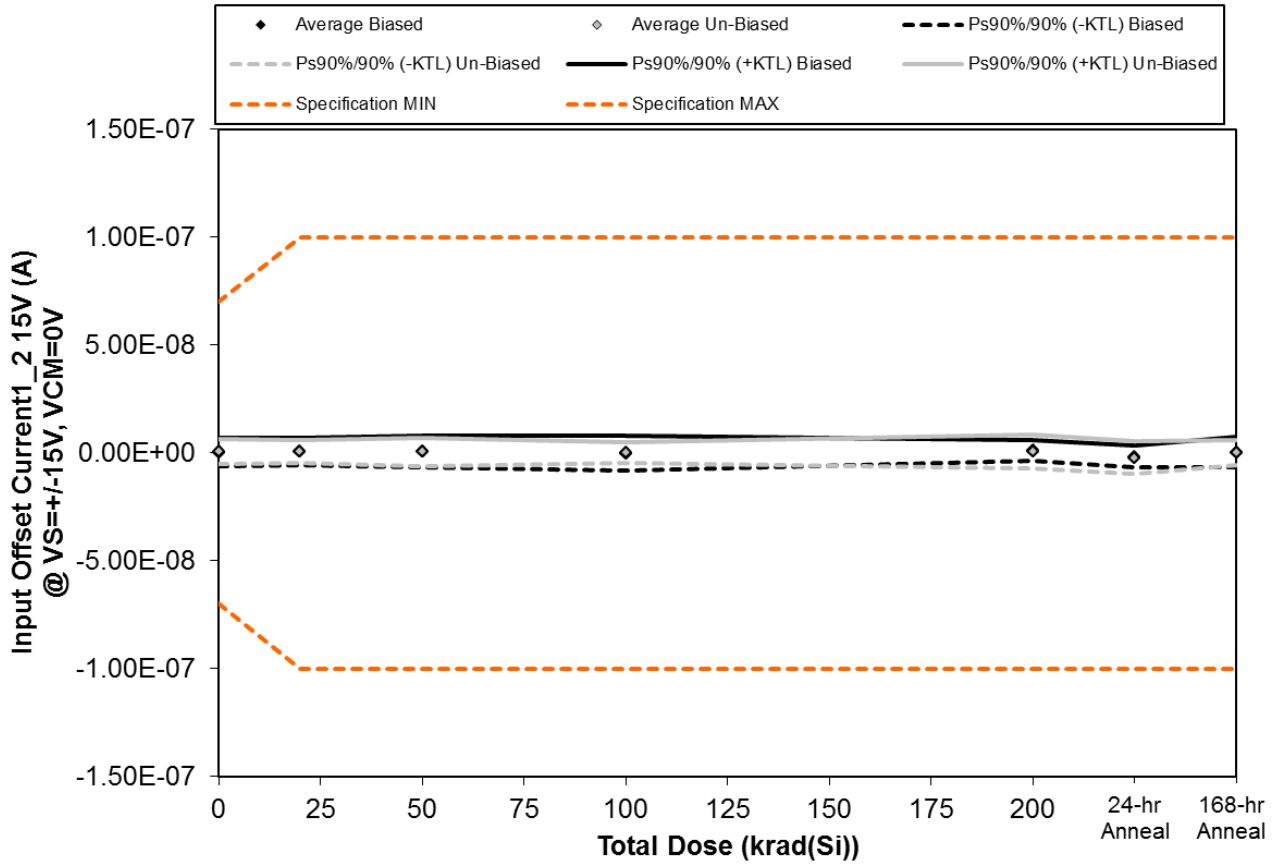

Figure 5.6. Plot of Input Offset Current1_2 15V (A) @ VS=+/-15V, VCM=0V versus total dose. The solid diamonds are the average of the measured data points for the samples irradiated under electrical bias while the shaded diamonds are the average of the measured data points for the samples irradiated with all pins tied to ground. The black lines (solid and/or dashed) are the upper and/or lower confidence limits, as determined by KTL statistics, on the samples irradiated under electrical bias while the gray lines (solid and/or dashed) are the upper and/or lower confidence limits, as determined by KTL statistics, on the samples irradiated in the unbiased condition. The red dotted line(s) are the pre- and/or post-irradiation minimum and/or maximum specification value as defined in the datasheet and/or test plan.



TID Report
15-0091 03/20/15 R1.0

Aeroflex RAD
5030 Centennial Blvd.
Colorado Springs, CO 80919
(719) 531-0800

Table 5.6. Raw data for Input Offset Current1_2 15V (A) @ VS=+/-15V, VCM=0V versus total dose, including the statistical analysis, specification and the status of the testing (pass/fail).

Input Offset Current1_2 15V (A) @ VS=+/-15V, VCM=0V	Total Dose (krad(Si))					24-hr Anneal	168-hr Anneal
	0	20	50	100	200		
Device							
680	-4.80E-10	9.00E-10	9.00E-10	-3.19E-09	7.50E-10	-2.65E-09	-5.20E-10
681	3.60E-10	-3.00E-11	-9.80E-10	-1.38E-09	1.00E-11	-2.75E-09	-1.05E-09
682	-4.60E-10	-2.70E-10	-3.90E-10	-2.60E-10	1.59E-09	-1.97E-09	-1.22E-09
683	-2.10E-09	-1.80E-09	-1.87E-09	-7.90E-10	-1.80E-10	-2.87E-09	-3.30E-10
684	4.18E-09	4.29E-09	4.92E-09	4.63E-09	4.13E-09	1.38E-09	4.91E-09
685	3.66E-09	3.35E-09	2.35E-09	1.51E-09	3.39E-09	-2.30E-10	2.87E-09
686	-1.55E-09	-9.20E-10	-5.10E-10	-7.00E-10	-1.66E-09	-4.26E-09	-1.60E-09
688	1.21E-09	7.30E-10	1.70E-09	1.89E-09	2.01E-09	-7.60E-10	6.40E-10
689	1.34E-09	1.70E-09	1.99E-09	-1.90E-10	2.04E-09	-1.10E-10	9.00E-10
690	-1.00E-09	-1.34E-09	-3.31E-09	-2.54E-09	-3.44E-09	-6.27E-09	-2.48E-09
691	-5.21E-09	-5.26E-09	-5.37E-09	-5.41E-09	-5.48E-09	-5.55E-09	-5.64E-09
692	-1.18E-09	-1.19E-09	-1.28E-09	-1.31E-09	-1.38E-09	-1.35E-09	-1.41E-09
Biased Statistics							
Average Biased	3.00E-10	6.18E-10	5.16E-10	-1.98E-10	1.26E-09	-1.77E-09	3.58E-10
Std Dev Biased	2.35E-09	2.27E-09	2.66E-09	2.92E-09	1.75E-09	1.80E-09	2.57E-09
Ps90%/90% (+KTL) Biased	6.73E-09	6.84E-09	7.81E-09	7.80E-09	6.06E-09	3.15E-09	7.41E-09
Ps90%/90% (-KTL) Biased	-6.13E-09	-5.61E-09	-6.78E-09	-8.19E-09	-3.54E-09	-6.70E-09	-6.69E-09
Un-Biased Statistics							
Average Un-Biased	7.32E-10	7.04E-10	4.44E-10	-6.00E-12	4.68E-10	-2.33E-09	6.60E-11
Std Dev Un-Biased	2.08E-09	1.92E-09	2.38E-09	1.79E-09	2.88E-09	2.79E-09	2.13E-09
Ps90%/90% (+KTL) Un-Biased	6.45E-09	5.98E-09	6.96E-09	4.90E-09	8.37E-09	5.31E-09	5.91E-09
Ps90%/90% (-KTL) Un-Biased	-4.98E-09	-4.57E-09	-6.07E-09	-4.92E-09	-7.43E-09	-9.97E-09	-5.77E-09
Specification MIN	-7.00E-08	-1.00E-07	-1.00E-07	-1.00E-07	-1.00E-07	-1.00E-07	-1.00E-07
Status	PASS	PASS	PASS	PASS	PASS	PASS	PASS
Specification MAX	7.00E-08	1.00E-07	1.00E-07	1.00E-07	1.00E-07	1.00E-07	1.00E-07
Status	PASS	PASS	PASS	PASS	PASS	PASS	PASS

An ISO 9001:2008 and DLA Certified Company

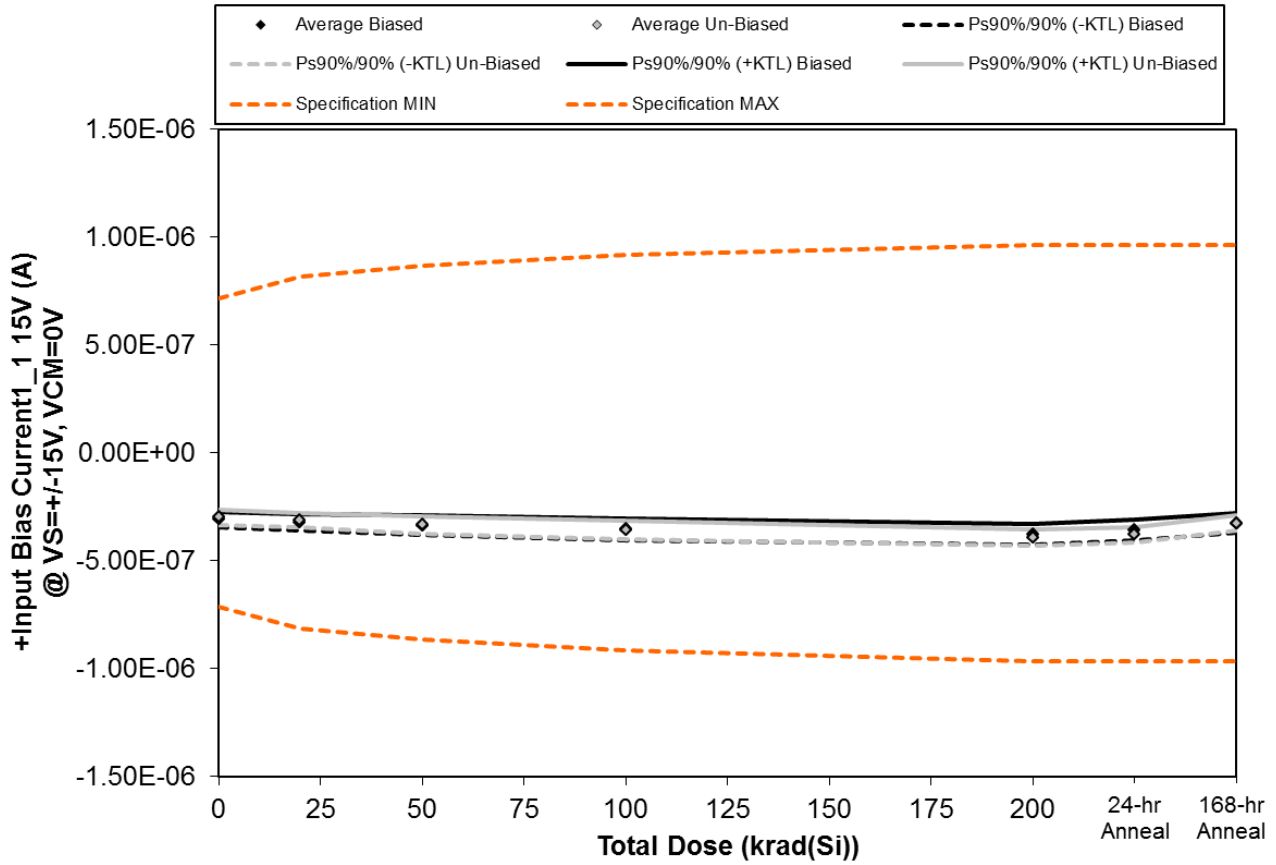

Figure 5.7. Plot of +Input Bias Current1_1 15V (A) @ VS=+-15V, VCM=0V versus total dose. The solid diamonds are the average of the measured data points for the samples irradiated under electrical bias while the shaded diamonds are the average of the measured data points for the samples irradiated with all pins tied to ground. The black lines (solid and/or dashed) are the upper and/or lower confidence limits, as determined by KTL statistics, on the samples irradiated under electrical bias while the gray lines (solid and/or dashed) are the upper and/or lower confidence limits, as determined by KTL statistics, on the samples irradiated in the unbiased condition. The red dotted line(s) are the pre- and/or post-irradiation minimum and/or maximum specification value as defined in the datasheet and/or test plan.



TID Report
15-0091 03/20/15 R1.0

Aeroflex RAD
5030 Centennial Blvd.
Colorado Springs, CO 80919
(719) 531-0800

Table 5.7. Raw data for +Input Bias Current1_1 15V (A) @ VS=+/-15V, VCM=0V versus total dose, including the statistical analysis, specification and the status of the testing (pass/fail).

+Input Bias Current1_1 15V (A) @ VS=+/-15V, VCM=0V	Total Dose (krad(Si))					24-hr	168-hr
	0	20	50	100	200	Anneal	Anneal
Device							
680	-3.11E-07	-3.21E-07	-3.34E-07	-3.50E-07	-3.73E-07	-3.55E-07	-3.24E-07
681	-3.08E-07	-3.19E-07	-3.33E-07	-3.53E-07	-3.76E-07	-3.56E-07	-3.22E-07
682	-3.27E-07	-3.40E-07	-3.60E-07	-3.77E-07	-4.03E-07	-3.80E-07	-3.48E-07
683	-2.89E-07	-3.00E-07	-3.14E-07	-3.29E-07	-3.54E-07	-3.31E-07	-3.03E-07
684	-3.11E-07	-3.24E-07	-3.40E-07	-3.62E-07	-3.84E-07	-3.65E-07	-3.27E-07
685	-2.92E-07	-3.05E-07	-3.24E-07	-3.50E-07	-3.81E-07	-3.69E-07	-3.18E-07
686	-3.08E-07	-3.22E-07	-3.40E-07	-3.63E-07	-3.98E-07	-3.85E-07	-3.33E-07
688	-3.00E-07	-3.17E-07	-3.36E-07	-3.70E-07	-4.06E-07	-3.92E-07	-3.33E-07
689	-2.78E-07	-2.94E-07	-3.12E-07	-3.33E-07	-3.73E-07	-3.61E-07	-3.07E-07
690	-3.10E-07	-3.17E-07	-3.50E-07	-3.69E-07	-3.99E-07	-3.90E-07	-3.39E-07
691	-3.02E-07	-3.02E-07	-3.03E-07	-3.02E-07	-3.03E-07	-3.03E-07	-3.02E-07
692	-3.05E-07	-3.04E-07	-3.05E-07	-3.05E-07	-3.05E-07	-3.05E-07	-3.05E-07
Biased Statistics							
Average Biased	-3.09E-07	-3.21E-07	-3.36E-07	-3.54E-07	-3.78E-07	-3.57E-07	-3.25E-07
Std Dev Biased	1.36E-08	1.40E-08	1.64E-08	1.76E-08	1.76E-08	1.79E-08	1.61E-08
Ps90%/90% (+KTL) Biased	-2.72E-07	-2.82E-07	-2.91E-07	-3.06E-07	-3.30E-07	-3.08E-07	-2.80E-07
Ps90%/90% (-KTL) Biased	-3.46E-07	-3.59E-07	-3.81E-07	-4.03E-07	-4.26E-07	-4.06E-07	-3.69E-07
Un-Biased Statistics							
Average Un-Biased	-2.98E-07	-3.11E-07	-3.32E-07	-3.57E-07	-3.92E-07	-3.80E-07	-3.26E-07
Std Dev Un-Biased	1.29E-08	1.14E-08	1.48E-08	1.54E-08	1.39E-08	1.36E-08	1.31E-08
Ps90%/90% (+KTL) Un-Biased	-2.62E-07	-2.80E-07	-2.92E-07	-3.15E-07	-3.54E-07	-3.42E-07	-2.90E-07
Ps90%/90% (-KTL) Un-Biased	-3.33E-07	-3.42E-07	-3.73E-07	-3.99E-07	-4.30E-07	-4.17E-07	-3.62E-07
Specification MIN	-7.15E-07	-8.15E-07	-8.65E-07	-9.15E-07	-9.65E-07	-9.65E-07	-9.65E-07
Status	PASS	PASS	PASS	PASS	PASS	PASS	PASS
Specification MAX	7.15E-07	8.15E-07	8.65E-07	9.15E-07	9.65E-07	9.65E-07	9.65E-07
Status	PASS	PASS	PASS	PASS	PASS	PASS	PASS

An ISO 9001:2008 and DLA Certified Company

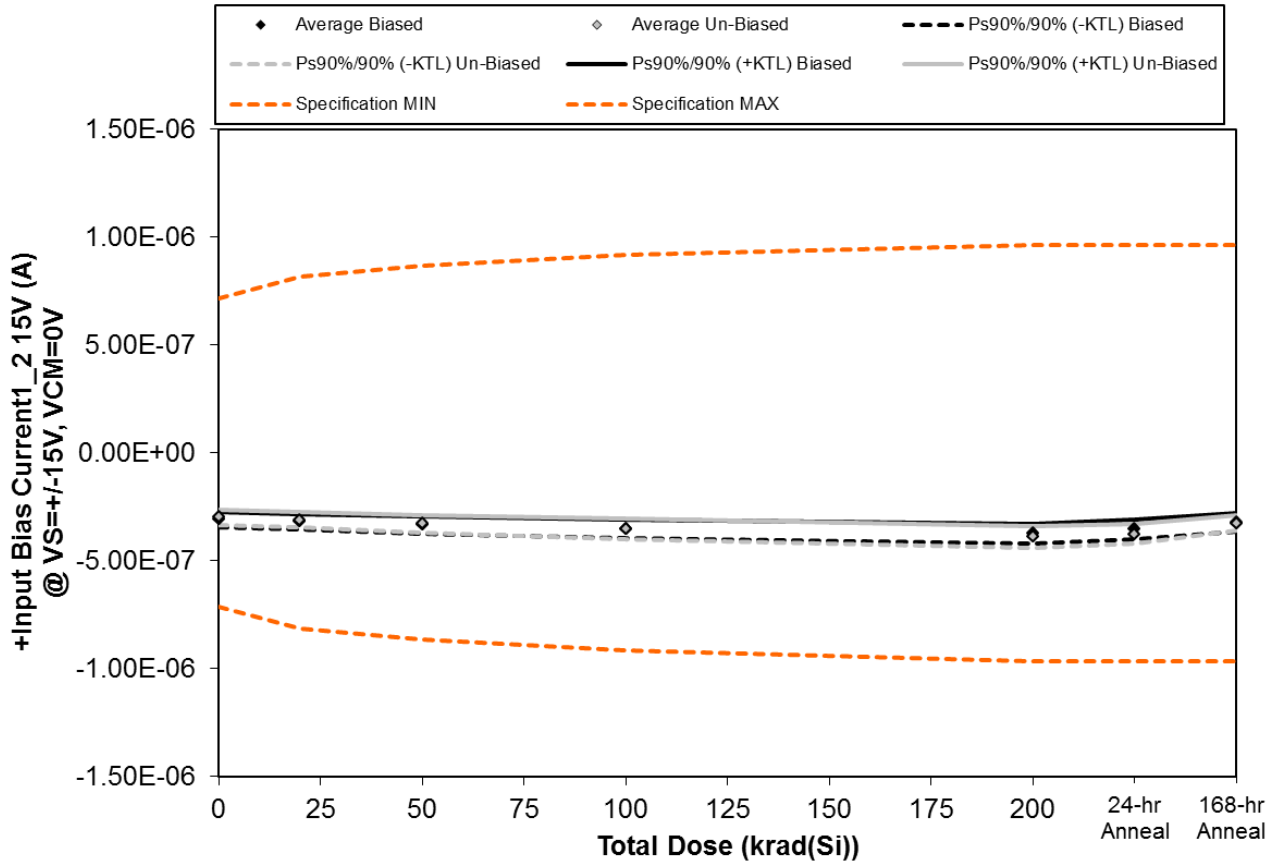

Figure 5.8. Plot of +Input Bias Current1_2 15V (A) @ VS=+-15V, VCM=0V versus total dose. The solid diamonds are the average of the measured data points for the samples irradiated under electrical bias while the shaded diamonds are the average of the measured data points for the samples irradiated with all pins tied to ground. The black lines (solid and/or dashed) are the upper and/or lower confidence limits, as determined by KTL statistics, on the samples irradiated under electrical bias while the gray lines (solid and/or dashed) are the upper and/or lower confidence limits, as determined by KTL statistics, on the samples irradiated in the unbiased condition. The red dotted line(s) are the pre- and/or post-irradiation minimum and/or maximum specification value as defined in the datasheet and/or test plan.



TID Report
15-0091 03/20/15 R1.0

Aeroflex RAD
5030 Centennial Blvd.
Colorado Springs, CO 80919
(719) 531-0800

Table 5.8. Raw data for +Input Bias Current1_2 15V (A) @ VS=+/-15V, VCM=0V versus total dose, including the statistical analysis, specification and the status of the testing (pass/fail).

+Input Bias Current1_2 15V (A) @ VS=+/-15V, VCM=0V	Total Dose (krad(Si))					24-hr Anneal	168-hr Anneal
	0	20	50	100	200		
Device							
680	-3.10E-07	-3.20E-07	-3.34E-07	-3.50E-07	-3.75E-07	-3.56E-07	-3.23E-07
681	-3.05E-07	-3.17E-07	-3.32E-07	-3.53E-07	-3.74E-07	-3.54E-07	-3.20E-07
682	-3.27E-07	-3.39E-07	-3.58E-07	-3.75E-07	-3.97E-07	-3.77E-07	-3.47E-07
683	-2.91E-07	-3.02E-07	-3.16E-07	-3.30E-07	-3.52E-07	-3.31E-07	-3.03E-07
684	-3.04E-07	-3.16E-07	-3.31E-07	-3.52E-07	-3.73E-07	-3.55E-07	-3.19E-07
685	-2.86E-07	-2.99E-07	-3.15E-07	-3.36E-07	-3.68E-07	-3.60E-07	-3.12E-07
686	-3.09E-07	-3.23E-07	-3.40E-07	-3.63E-07	-3.97E-07	-3.83E-07	-3.33E-07
688	-3.04E-07	-3.21E-07	-3.39E-07	-3.68E-07	-4.06E-07	-3.90E-07	-3.35E-07
689	-2.81E-07	-2.95E-07	-3.12E-07	-3.32E-07	-3.68E-07	-3.56E-07	-3.08E-07
690	-3.05E-07	-3.12E-07	-3.40E-07	-3.66E-07	-4.01E-07	-3.89E-07	-3.35E-07
691	-3.06E-07	-3.06E-07	-3.07E-07	-3.06E-07	-3.07E-07	-3.07E-07	-3.07E-07
692	-2.96E-07	-2.96E-07	-2.96E-07	-2.96E-07	-2.96E-07	-2.96E-07	-2.96E-07
Biased Statistics							
Average Biased	-3.07E-07	-3.19E-07	-3.34E-07	-3.52E-07	-3.74E-07	-3.55E-07	-3.23E-07
Std Dev Biased	1.30E-08	1.32E-08	1.54E-08	1.60E-08	1.59E-08	1.64E-08	1.56E-08
Ps90%/90% (+KTL) Biased	-2.72E-07	-2.83E-07	-2.92E-07	-3.08E-07	-3.31E-07	-3.10E-07	-2.80E-07
Ps90%/90% (-KTL) Biased	-3.43E-07	-3.55E-07	-3.76E-07	-3.96E-07	-4.18E-07	-4.00E-07	-3.66E-07
Un-Biased Statistics							
Average Un-Biased	-2.97E-07	-3.10E-07	-3.29E-07	-3.53E-07	-3.88E-07	-3.76E-07	-3.25E-07
Std Dev Un-Biased	1.28E-08	1.27E-08	1.43E-08	1.76E-08	1.85E-08	1.64E-08	1.36E-08
Ps90%/90% (+KTL) Un-Biased	-2.62E-07	-2.75E-07	-2.90E-07	-3.05E-07	-3.37E-07	-3.31E-07	-2.87E-07
Ps90%/90% (-KTL) Un-Biased	-3.32E-07	-3.45E-07	-3.68E-07	-4.01E-07	-4.39E-07	-4.21E-07	-3.62E-07
Specification MIN	-7.15E-07	-8.15E-07	-8.65E-07	-9.15E-07	-9.65E-07	-9.65E-07	-9.65E-07
Status	PASS	PASS	PASS	PASS	PASS	PASS	PASS
Specification MAX	7.15E-07	8.15E-07	8.65E-07	9.15E-07	9.65E-07	9.65E-07	9.65E-07
Status	PASS	PASS	PASS	PASS	PASS	PASS	PASS

An ISO 9001:2008 and DLA Certified Company

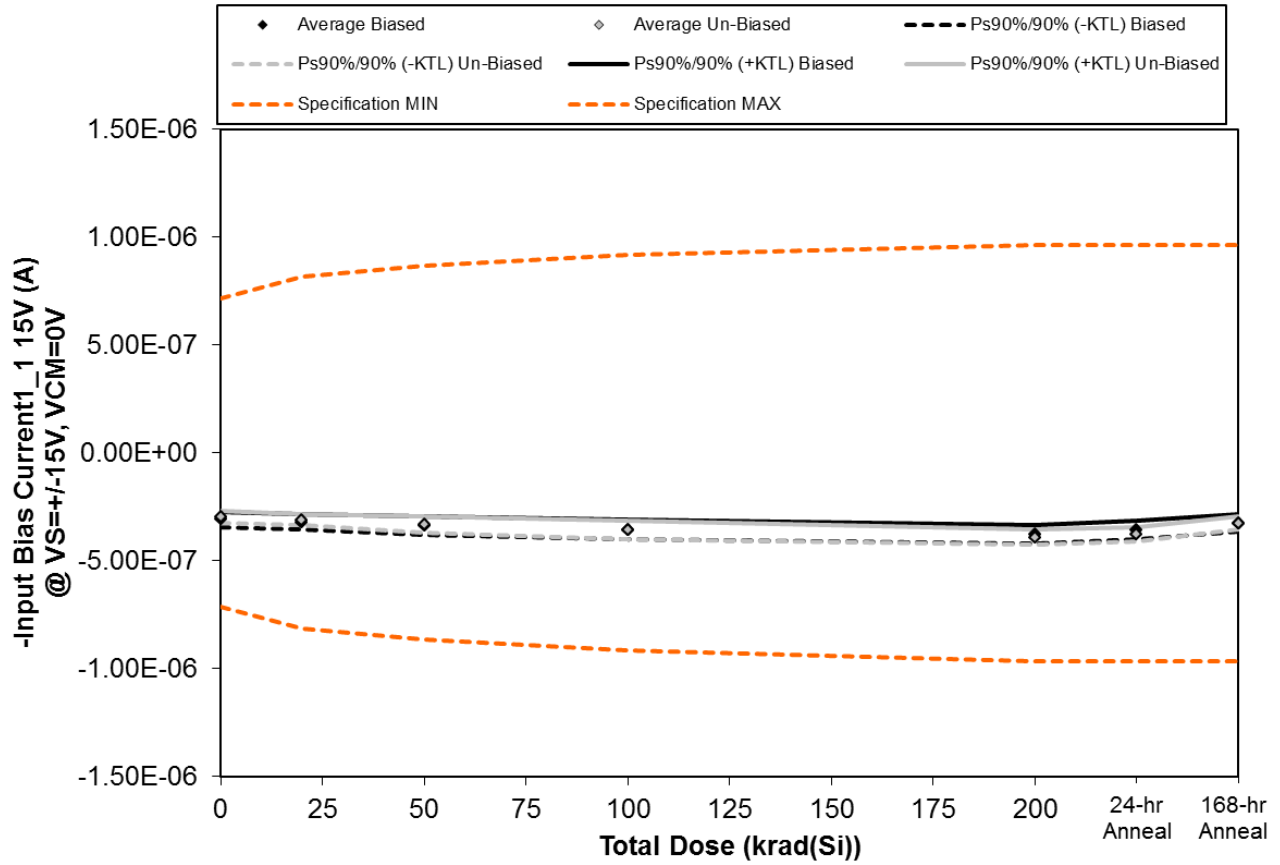

Figure 5.9. Plot of -Input Bias Current1_1 15V (A) @ VS=+-15V, VCM=0V versus total dose. The solid diamonds are the average of the measured data points for the samples irradiated under electrical bias while the shaded diamonds are the average of the measured data points for the samples irradiated with all pins tied to ground. The black lines (solid and/or dashed) are the upper and/or lower confidence limits, as determined by KTL statistics, on the samples irradiated under electrical bias while the gray lines (solid and/or dashed) are the upper and/or lower confidence limits, as determined by KTL statistics, on the samples irradiated in the unbiased condition. The red dotted line(s) are the pre- and/or post-irradiation minimum and/or maximum specification value as defined in the datasheet and/or test plan.



TID Report
15-0091 03/20/15 R1.0

Aeroflex RAD
5030 Centennial Blvd.
Colorado Springs, CO 80919
(719) 531-0800

Table 5.9. Raw data for -Input Bias Current1_1 15V (A) @ VS=+/-15V, VCM=0V versus total dose, including the statistical analysis, specification and the status of the testing (pass/fail).

-Input Bias Current1_1 15V (A) @ VS=+/-15V, VCM=0V	Total Dose (krad(Si))					24-hr	168-hr
	0	20	50	100	200	Anneal	Anneal
Device							
680	-3.14E-07	-3.24E-07	-3.36E-07	-3.50E-07	-3.76E-07	-3.57E-07	-3.26E-07
681	-3.04E-07	-3.15E-07	-3.29E-07	-3.52E-07	-3.71E-07	-3.52E-07	-3.18E-07
682	-3.26E-07	-3.39E-07	-3.60E-07	-3.77E-07	-4.00E-07	-3.76E-07	-3.48E-07
683	-2.91E-07	-3.03E-07	-3.18E-07	-3.34E-07	-3.60E-07	-3.33E-07	-3.05E-07
684	-3.10E-07	-3.24E-07	-3.40E-07	-3.64E-07	-3.87E-07	-3.65E-07	-3.27E-07
685	-2.89E-07	-3.03E-07	-3.20E-07	-3.40E-07	-3.77E-07	-3.65E-07	-3.15E-07
686	-3.06E-07	-3.21E-07	-3.38E-07	-3.64E-07	-3.96E-07	-3.81E-07	-3.31E-07
688	-2.98E-07	-3.14E-07	-3.34E-07	-3.65E-07	-4.00E-07	-3.86E-07	-3.29E-07
689	-2.82E-07	-2.97E-07	-3.16E-07	-3.36E-07	-3.75E-07	-3.62E-07	-3.11E-07
690	-3.07E-07	-3.14E-07	-3.49E-07	-3.69E-07	-4.04E-07	-3.88E-07	-3.36E-07
691	-3.01E-07	-3.01E-07	-3.01E-07	-3.00E-07	-3.01E-07	-3.01E-07	-3.00E-07
692	-2.99E-07	-2.98E-07	-2.98E-07	-2.98E-07	-2.98E-07	-2.98E-07	-2.98E-07
Biased Statistics							
Average Biased	-3.09E-07	-3.21E-07	-3.37E-07	-3.55E-07	-3.79E-07	-3.57E-07	-3.25E-07
Std Dev Biased	1.30E-08	1.31E-08	1.55E-08	1.61E-08	1.53E-08	1.62E-08	1.55E-08
Ps90%/90% (+KTL) Biased	-2.74E-07	-2.85E-07	-2.94E-07	-3.11E-07	-3.37E-07	-3.12E-07	-2.82E-07
Ps90%/90% (-KTL) Biased	-3.45E-07	-3.57E-07	-3.79E-07	-4.00E-07	-4.21E-07	-4.01E-07	-3.67E-07
Un-Biased Statistics							
Average Un-Biased	-2.97E-07	-3.10E-07	-3.31E-07	-3.55E-07	-3.90E-07	-3.76E-07	-3.25E-07
Std Dev Un-Biased	1.09E-08	9.55E-09	1.34E-08	1.56E-08	1.34E-08	1.20E-08	1.09E-08
Ps90%/90% (+KTL) Un-Biased	-2.67E-07	-2.84E-07	-2.95E-07	-3.12E-07	-3.54E-07	-3.43E-07	-2.95E-07
Ps90%/90% (-KTL) Un-Biased	-3.27E-07	-3.36E-07	-3.68E-07	-3.98E-07	-4.27E-07	-4.09E-07	-3.54E-07
Specification MIN	-7.15E-07	-8.15E-07	-8.65E-07	-9.15E-07	-9.65E-07	-9.65E-07	-9.65E-07
Status	PASS	PASS	PASS	PASS	PASS	PASS	PASS
Specification MAX	7.15E-07	8.15E-07	8.65E-07	9.15E-07	9.65E-07	9.65E-07	9.65E-07
Status	PASS	PASS	PASS	PASS	PASS	PASS	PASS

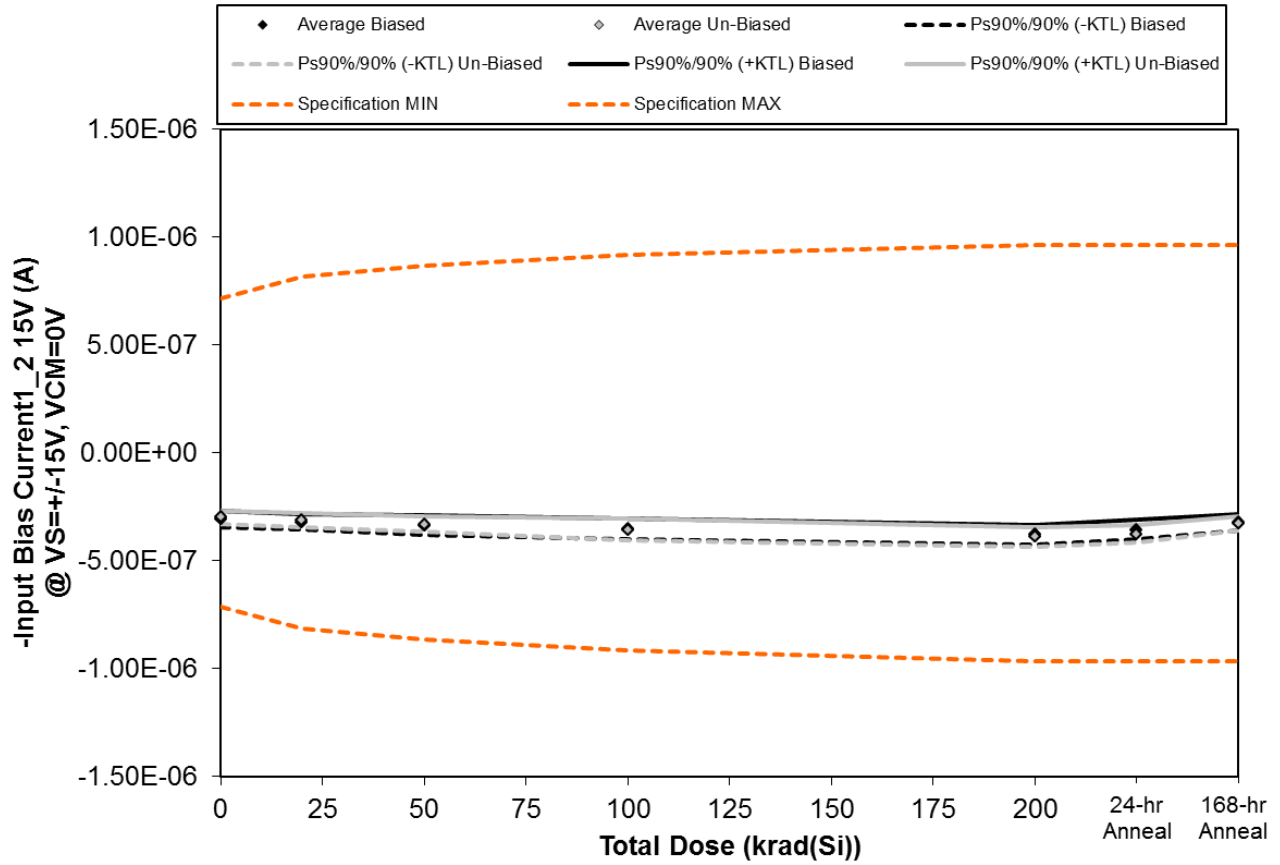

Figure 5.10. Plot of -Input Bias Current1_2 15V (A) @ VS=+-15V, VCM=0V versus total dose. The solid diamonds are the average of the measured data points for the samples irradiated under electrical bias while the shaded diamonds are the average of the measured data points for the samples irradiated with all pins tied to ground. The black lines (solid and/or dashed) are the upper and/or lower confidence limits, as determined by KTL statistics, on the samples irradiated under electrical bias while the gray lines (solid and/or dashed) are the upper and/or lower confidence limits, as determined by KTL statistics, on the samples irradiated in the unbiased condition. The red dotted line(s) are the pre- and/or post-irradiation minimum and/or maximum specification value as defined in the datasheet and/or test plan.



**TID Report
15-0091 03/20/15 R1.0**

**Aeroflex RAD
5030 Centennial Blvd.
Colorado Springs, CO 80919
(719) 531-0800**

Table 5.10. Raw data for -Input Bias Current1_2 15V (A) @ VS=+/-15V, VCM=0V versus total dose, including the statistical analysis, specification and the status of the testing (pass/fail).

-Input Bias Current1_2 15V (A) @ VS=+/-15V, VCM=0V	Total Dose (krad(Si))					24-hr	168-hr
	0	20	50	100	200	Anneal	Anneal
Device							
680	-3.10E-07	-3.22E-07	-3.36E-07	-3.50E-07	-3.77E-07	-3.56E-07	-3.23E-07
681	-3.06E-07	-3.18E-07	-3.31E-07	-3.53E-07	-3.76E-07	-3.54E-07	-3.20E-07
682	-3.27E-07	-3.39E-07	-3.60E-07	-3.78E-07	-4.01E-07	-3.77E-07	-3.41E-07
683	-2.89E-07	-3.01E-07	-3.14E-07	-3.30E-07	-3.55E-07	-3.29E-07	-3.03E-07
684	-3.09E-07	-3.21E-07	-3.36E-07	-3.60E-07	-3.79E-07	-3.59E-07	-3.24E-07
685	-2.90E-07	-3.02E-07	-3.18E-07	-3.38E-07	-3.72E-07	-3.62E-07	-3.15E-07
686	-3.08E-07	-3.22E-07	-3.40E-07	-3.65E-07	-3.96E-07	-3.82E-07	-3.32E-07
688	-3.06E-07	-3.21E-07	-3.40E-07	-3.73E-07	-4.09E-07	-3.93E-07	-3.36E-07
689	-2.82E-07	-2.97E-07	-3.14E-07	-3.32E-07	-3.72E-07	-3.57E-07	-3.09E-07
690	-3.05E-07	-3.12E-07	-3.37E-07	-3.66E-07	-3.98E-07	-3.84E-07	-3.33E-07
691	-3.02E-07	-3.02E-07	-3.02E-07	-3.01E-07	-3.02E-07	-3.01E-07	-3.01E-07
692	-2.96E-07	-2.95E-07	-2.95E-07	-2.95E-07	-2.95E-07	-2.95E-07	-2.95E-07
Biased Statistics							
Average Biased	-3.08E-07	-3.20E-07	-3.35E-07	-3.54E-07	-3.78E-07	-3.55E-07	-3.22E-07
Std Dev Biased	1.34E-08	1.35E-08	1.62E-08	1.73E-08	1.65E-08	1.72E-08	1.33E-08
Ps90%/90% (+KTL) Biased	-2.71E-07	-2.83E-07	-2.91E-07	-3.07E-07	-3.32E-07	-3.07E-07	-2.86E-07
Ps90%/90% (-KTL) Biased	-3.45E-07	-3.57E-07	-3.80E-07	-4.02E-07	-4.23E-07	-4.02E-07	-3.59E-07
Un-Biased Statistics							
Average Un-Biased	-2.98E-07	-3.11E-07	-3.30E-07	-3.55E-07	-3.89E-07	-3.76E-07	-3.25E-07
Std Dev Un-Biased	1.14E-08	1.13E-08	1.29E-08	1.84E-08	1.66E-08	1.53E-08	1.21E-08
Ps90%/90% (+KTL) Un-Biased	-2.67E-07	-2.80E-07	-2.95E-07	-3.04E-07	-3.44E-07	-3.34E-07	-2.92E-07
Ps90%/90% (-KTL) Un-Biased	-3.29E-07	-3.42E-07	-3.65E-07	-4.05E-07	-4.35E-07	-4.17E-07	-3.58E-07
Specification MIN	-7.15E-07	-8.15E-07	-8.65E-07	-9.15E-07	-9.65E-07	-9.65E-07	-9.65E-07
Status	PASS	PASS	PASS	PASS	PASS	PASS	PASS
Specification MAX	7.15E-07	8.15E-07	8.65E-07	9.15E-07	9.65E-07	9.65E-07	9.65E-07
Status	PASS	PASS	PASS	PASS	PASS	PASS	PASS

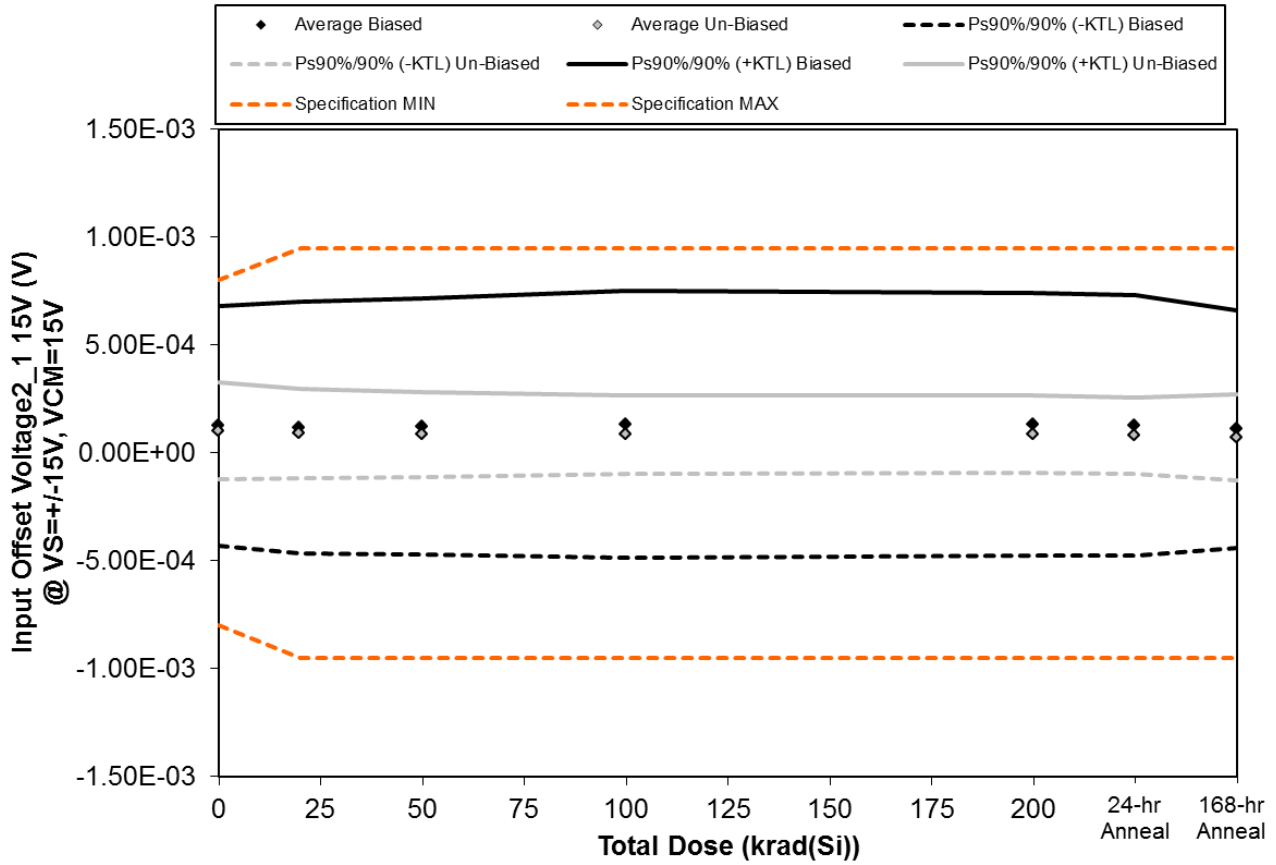

Figure 5.11. Plot of Input Offset Voltage2_1 15V (V) @ VS=+-15V, VCM=15V versus total dose. The solid diamonds are the average of the measured data points for the samples irradiated under electrical bias while the shaded diamonds are the average of the measured data points for the samples irradiated with all pins tied to ground. The black lines (solid and/or dashed) are the upper and/or lower confidence limits, as determined by KTL statistics, on the samples irradiated under electrical bias while the gray lines (solid and/or dashed) are the upper and/or lower confidence limits, as determined by KTL statistics, on the samples irradiated in the unbiased condition. The red dotted line(s) are the pre- and/or post-irradiation minimum and/or maximum specification value as defined in the datasheet and/or test plan.



TID Report
15-0091 03/20/15 R1.0

Aeroflex RAD
5030 Centennial Blvd.
Colorado Springs, CO 80919
(719) 531-0800

Table 5.11. Raw data for Input Offset Voltage2_1 15V (V) @ VS=+/-15V, VCM=15V versus total dose, including the statistical analysis, specification and the status of the testing (pass/fail).

Input Offset Voltage2_1 15V (V) @ VS=+/-15V, VCM=15V	Total Dose (krad(Si))					24-hr	168-hr
	Device	0	20	50	100	200	Anneal
680	4.11E-04	4.17E-04	4.28E-04	4.55E-04	4.43E-04	4.38E-04	3.91E-04
681	-1.19E-04	-1.41E-04	-1.42E-04	-1.41E-04	-1.41E-04	-1.43E-04	-1.28E-04
682	2.12E-05	8.10E-06	1.05E-05	1.34E-05	1.43E-05	1.49E-05	-1.12E-05
683	2.27E-04	2.17E-04	2.23E-04	2.30E-04	2.42E-04	2.28E-04	2.12E-04
684	8.72E-05	8.18E-05	9.21E-05	1.02E-04	1.05E-04	1.03E-04	9.21E-05
685	1.09E-04	1.04E-04	9.82E-05	9.98E-05	1.07E-04	9.54E-05	9.05E-05
686	-1.30E-06	-2.86E-06	-5.03E-06	2.67E-06	4.22E-06	-3.95E-06	-2.86E-05
688	6.54E-05	5.29E-05	5.38E-05	5.23E-05	4.88E-05	4.90E-05	4.01E-05
689	2.21E-04	2.02E-04	1.92E-04	1.82E-04	1.81E-04	1.72E-04	1.70E-04
690	1.17E-04	9.73E-05	9.35E-05	9.21E-05	9.40E-05	8.93E-05	7.84E-05
691	-1.21E-04	-1.20E-04	-1.20E-04	-1.19E-04	-1.18E-04	-1.19E-04	-1.17E-04
692	-5.00E-05	-4.90E-05	-4.93E-05	-4.89E-05	-4.86E-05	-4.88E-05	-4.79E-05
Biased Statistics							
Average Biased	1.25E-04	1.17E-04	1.22E-04	1.32E-04	1.33E-04	1.28E-04	1.11E-04
Std Dev Biased	2.03E-04	2.12E-04	2.16E-04	2.26E-04	2.22E-04	2.20E-04	2.01E-04
Ps90%/90% (+KTL) Biased	6.81E-04	6.98E-04	7.15E-04	7.51E-04	7.42E-04	7.30E-04	6.61E-04
Ps90%/90% (-KTL) Biased	-4.30E-04	-4.65E-04	-4.71E-04	-4.87E-04	-4.77E-04	-4.74E-04	-4.39E-04
Un-Biased Statistics							
Average Un-Biased	1.02E-04	9.07E-05	8.64E-05	8.58E-05	8.69E-05	8.03E-05	7.01E-05
Std Dev Un-Biased	8.13E-05	7.56E-05	7.19E-05	6.63E-05	6.62E-05	6.47E-05	7.26E-05
Ps90%/90% (+KTL) Un-Biased	3.25E-04	2.98E-04	2.83E-04	2.68E-04	2.68E-04	2.58E-04	2.69E-04
Ps90%/90% (-KTL) Un-Biased	-1.21E-04	-1.17E-04	-1.11E-04	-9.60E-05	-9.45E-05	-9.72E-05	-1.29E-04
Specification MIN	-8.00E-04	-9.50E-04	-9.50E-04	-9.50E-04	-9.50E-04	-9.50E-04	-9.50E-04
Status	PASS	PASS	PASS	PASS	PASS	PASS	PASS
Specification MAX	8.00E-04	9.50E-04	9.50E-04	9.50E-04	9.50E-04	9.50E-04	9.50E-04
Status	PASS	PASS	PASS	PASS	PASS	PASS	PASS

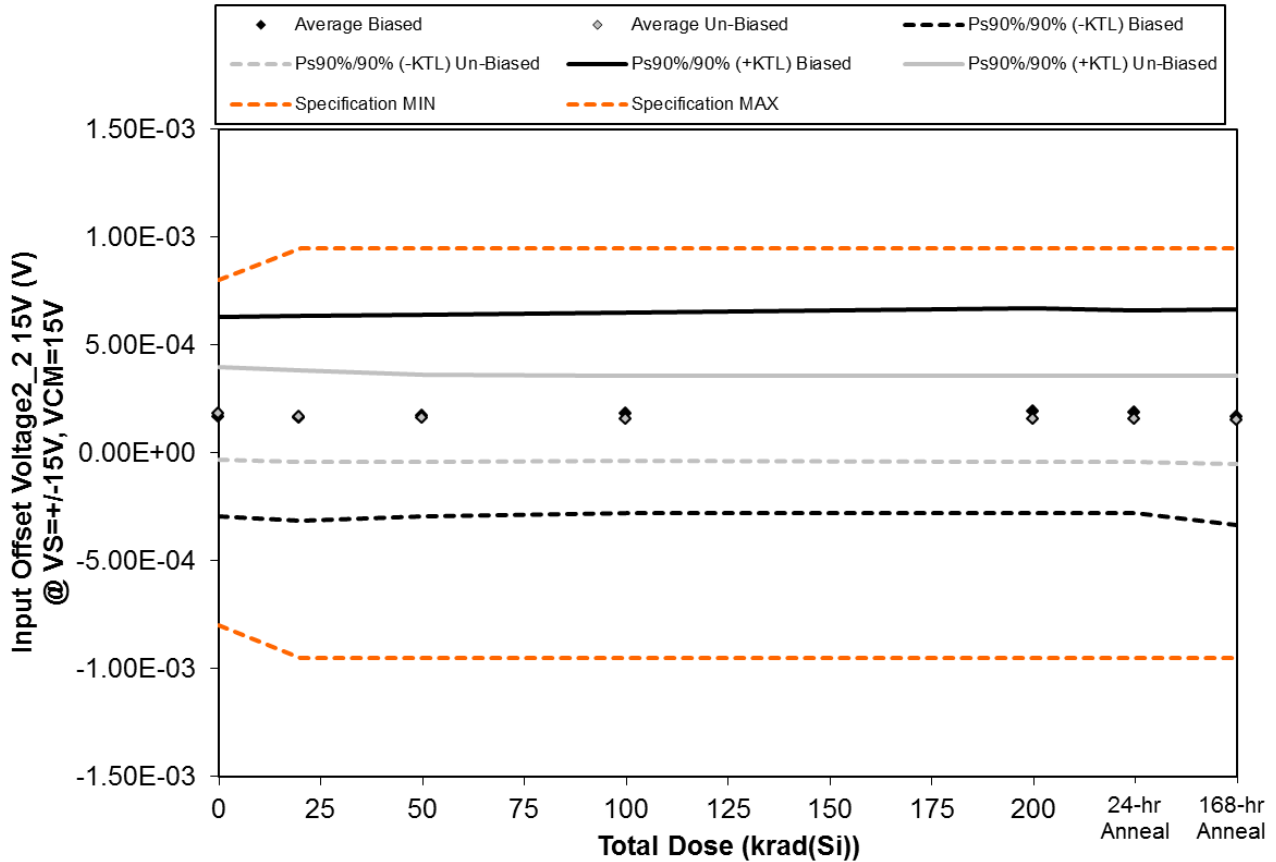

Figure 5.12. Plot of Input Offset Voltage2_2 15V (V) @ VS=+-15V, VCM=15V versus total dose. The solid diamonds are the average of the measured data points for the samples irradiated under electrical bias while the shaded diamonds are the average of the measured data points for the samples irradiated with all pins tied to ground. The black lines (solid and/or dashed) are the upper and/or lower confidence limits, as determined by KTL statistics, on the samples irradiated under electrical bias while the gray lines (solid and/or dashed) are the upper and/or lower confidence limits, as determined by KTL statistics, on the samples irradiated in the unbiased condition. The red dotted line(s) are the pre- and/or post-irradiation minimum and/or maximum specification value as defined in the datasheet and/or test plan.



TID Report
15-0091 03/20/15 R1.0

Aeroflex RAD
5030 Centennial Blvd.
Colorado Springs, CO 80919
(719) 531-0800

Table 5.12. Raw data for Input Offset Voltage_{2_2} 15V (V) @ VS=+/-15V, VCM=15V versus total dose, including the statistical analysis, specification and the status of the testing (pass/fail).

Input Offset Voltage _{2_2} 15V (V) @ VS=+/-15V, VCM=15V	Total Dose (krad(Si))					24-hr	168-hr	
	Device	0	20	50	100	200	Anneal	Anneal
680	1.81E-05	9.88E-06	2.62E-05	3.95E-05	3.85E-05	3.54E-05	9.17E-06	
681	1.39E-04	1.33E-04	1.44E-04	1.53E-04	1.60E-04	1.63E-04	1.28E-04	
682	7.86E-05	6.45E-05	7.50E-05	8.44E-05	9.66E-05	9.38E-05	5.93E-05	
683	1.51E-04	1.47E-04	1.61E-04	1.74E-04	1.87E-04	1.80E-04	1.62E-04	
684	4.55E-04	4.55E-04	4.62E-04	4.72E-04	4.85E-04	4.79E-04	4.75E-04	
685	3.04E-04	2.90E-04	2.80E-04	2.74E-04	2.72E-04	2.76E-04	2.67E-04	
686	1.58E-04	1.48E-04	1.39E-04	1.37E-04	1.31E-04	1.34E-04	1.26E-04	
688	1.30E-04	1.12E-04	1.06E-04	1.06E-04	9.93E-05	1.01E-04	1.00E-04	
689	1.08E-04	9.88E-05	1.00E-04	1.00E-04	1.00E-04	9.86E-05	8.46E-05	
690	2.12E-04	2.01E-04	1.82E-04	1.80E-04	1.82E-04	1.75E-04	1.82E-04	
691	-3.06E-05	-3.25E-05	-3.19E-05	-2.96E-05	-3.12E-05	-2.78E-05	-3.38E-05	
692	3.24E-04	3.24E-04	3.24E-04	3.25E-04	3.26E-04	3.28E-04	3.26E-04	
Biased Statistics								
Average Biased	1.68E-04	1.62E-04	1.74E-04	1.85E-04	1.93E-04	1.90E-04	1.67E-04	
Std Dev Biased	1.69E-04	1.73E-04	1.70E-04	1.70E-04	1.73E-04	1.71E-04	1.82E-04	
Ps90%/90% (+KTL) Biased	6.31E-04	6.36E-04	6.40E-04	6.50E-04	6.68E-04	6.60E-04	6.67E-04	
Ps90%/90% (-KTL) Biased	-2.95E-04	-3.12E-04	-2.92E-04	-2.80E-04	-2.81E-04	-2.80E-04	-3.33E-04	
Un-Biased Statistics								
Average Un-Biased	1.83E-04	1.70E-04	1.61E-04	1.59E-04	1.57E-04	1.57E-04	1.52E-04	
Std Dev Un-Biased	7.83E-05	7.79E-05	7.37E-05	7.14E-05	7.28E-05	7.31E-05	7.42E-05	
Ps90%/90% (+KTL) Un-Biased	3.97E-04	3.84E-04	3.64E-04	3.55E-04	3.56E-04	3.57E-04	3.56E-04	
Ps90%/90% (-KTL) Un-Biased	-3.22E-05	-4.35E-05	-4.08E-05	-3.65E-05	-4.27E-05	-4.36E-05	-5.15E-05	
Specification MIN	-8.00E-04	-9.50E-04	-9.50E-04	-9.50E-04	-9.50E-04	-9.50E-04	-9.50E-04	
Status	PASS	PASS	PASS	PASS	PASS	PASS	PASS	
Specification MAX	8.00E-04	9.50E-04	9.50E-04	9.50E-04	9.50E-04	9.50E-04	9.50E-04	
Status	PASS	PASS	PASS	PASS	PASS	PASS	PASS	

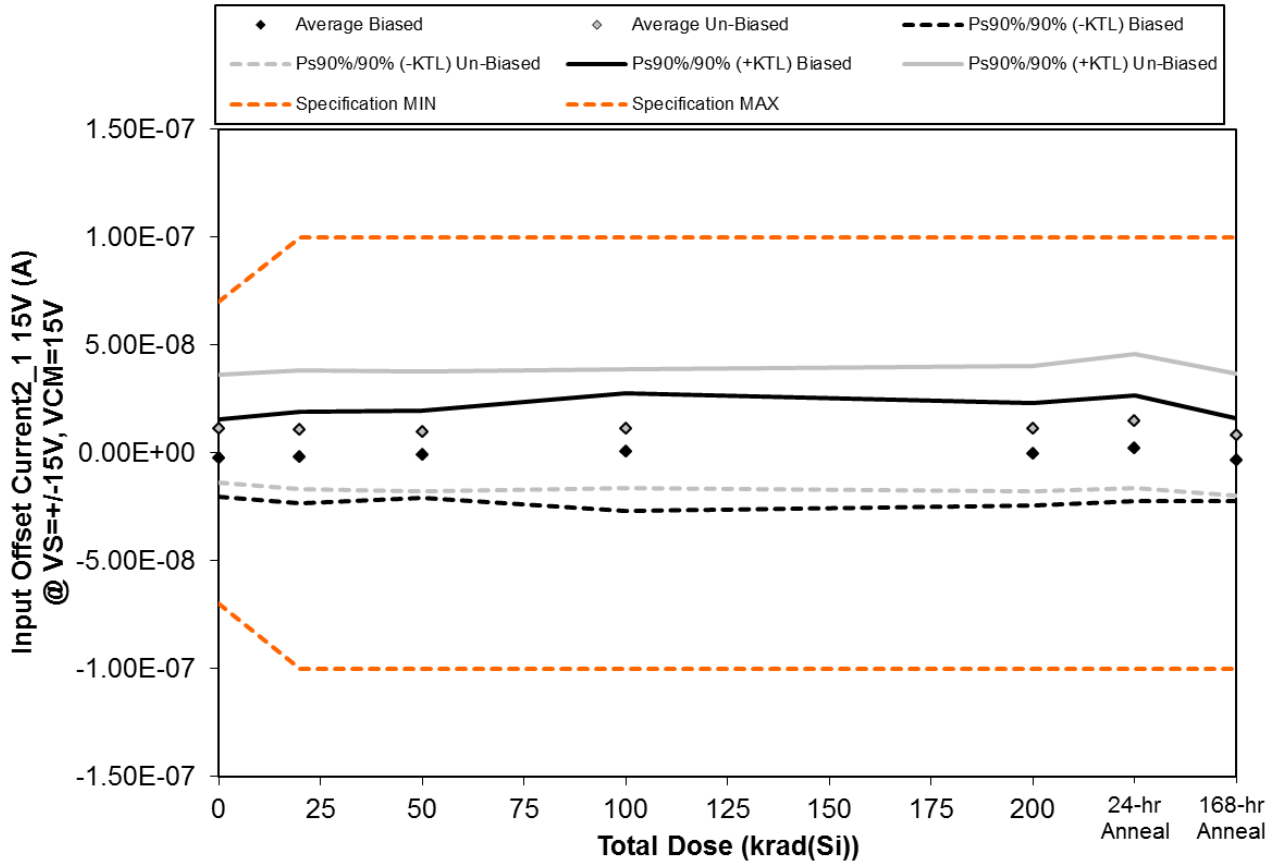

Figure 5.13. Plot of Input Offset Current2_1 15V (A) @ VS=+-15V, VCM=15V versus total dose. The solid diamonds are the average of the measured data points for the samples irradiated under electrical bias while the shaded diamonds are the average of the measured data points for the samples irradiated with all pins tied to ground. The black lines (solid and/or dashed) are the upper and/or lower confidence limits, as determined by KTL statistics, on the samples irradiated under electrical bias while the gray lines (solid and/or dashed) are the upper and/or lower confidence limits, as determined by KTL statistics, on the samples irradiated in the unbiased condition. The red dotted line(s) are the pre- and/or post-irradiation minimum and/or maximum specification value as defined in the datasheet and/or test plan.



TID Report
15-0091 03/20/15 R1.0

Aeroflex RAD
5030 Centennial Blvd.
Colorado Springs, CO 80919
(719) 531-0800

Table 5.13. Raw data for Input Offset Current_{2_1} 15V (A) @ VS=+/-15V, VCM=15V versus total dose, including the statistical analysis, specification and the status of the testing (pass/fail).

Input Offset Current _{2_1} 15V (A) @ VS=+/-15V, VCM=15V	Total Dose (krad(Si))					24-hr Anneal	168-hr Anneal
	0	20	50	100	200		
Device							
680	0.00E+00	4.49E-09	6.87E-09	1.23E-08	8.85E-09	1.19E-08	2.70E-09
681	-3.73E-09	-3.97E-09	-4.18E-09	-1.07E-09	-1.65E-09	6.60E-10	-4.77E-09
682	-1.15E-08	-1.30E-08	-9.80E-09	-1.29E-08	-1.36E-08	-9.82E-09	-1.29E-08
683	-3.39E-09	-4.23E-09	-3.68E-09	-4.06E-09	-1.52E-09	-1.91E-09	-5.37E-09
684	6.74E-09	5.98E-09	6.74E-09	7.83E-09	5.70E-09	9.90E-09	4.49E-09
685	1.06E-08	8.81E-09	7.83E-09	1.13E-08	1.00E-08	1.50E-08	8.32E-09
686	7.62E-09	6.31E-09	5.54E-09	6.67E-09	7.13E-09	8.61E-09	1.89E-09
688	1.30E-08	1.52E-08	1.66E-08	1.70E-08	1.74E-08	2.23E-08	1.22E-08
689	-3.90E-10	-2.01E-09	-3.41E-09	-2.27E-09	-2.94E-09	-5.90E-10	-3.91E-09
690	2.46E-08	2.48E-08	2.28E-08	2.41E-08	2.51E-08	2.83E-08	2.31E-08
691	2.21E-09	2.89E-09	3.25E-09	3.42E-09	3.65E-09	3.80E-09	4.24E-09
692	1.37E-08	1.46E-08	1.47E-08	1.50E-08	1.50E-08	1.51E-08	1.55E-08
Biased Statistics							
Average Biased	-2.38E-09	-2.14E-09	-8.10E-10	4.18E-10	-4.38E-10	2.15E-09	-3.16E-09
Std Dev Biased	6.61E-09	7.67E-09	7.36E-09	9.94E-09	8.65E-09	8.90E-09	6.98E-09
Ps90%/90% (+KTL) Biased	1.58E-08	1.89E-08	1.94E-08	2.77E-08	2.33E-08	2.66E-08	1.60E-08
Ps90%/90% (-KTL) Biased	-2.05E-08	-2.32E-08	-2.10E-08	-2.68E-08	-2.41E-08	-2.23E-08	-2.23E-08
Un-Biased Statistics							
Average Un-Biased	1.11E-08	1.06E-08	9.87E-09	1.13E-08	1.13E-08	1.47E-08	8.31E-09
Std Dev Un-Biased	9.09E-09	1.00E-08	1.01E-08	1.00E-08	1.06E-08	1.13E-08	1.03E-08
Ps90%/90% (+KTL) Un-Biased	3.60E-08	3.81E-08	3.77E-08	3.88E-08	4.04E-08	4.57E-08	3.66E-08
Ps90%/90% (-KTL) Un-Biased	-1.38E-08	-1.69E-08	-1.80E-08	-1.61E-08	-1.77E-08	-1.63E-08	-1.99E-08
Specification MIN	-7.00E-08	-1.00E-07	-1.00E-07	-1.00E-07	-1.00E-07	-1.00E-07	-1.00E-07
Status	PASS	PASS	PASS	PASS	PASS	PASS	PASS
Specification MAX	7.00E-08	1.00E-07	1.00E-07	1.00E-07	1.00E-07	1.00E-07	1.00E-07
Status	PASS	PASS	PASS	PASS	PASS	PASS	PASS

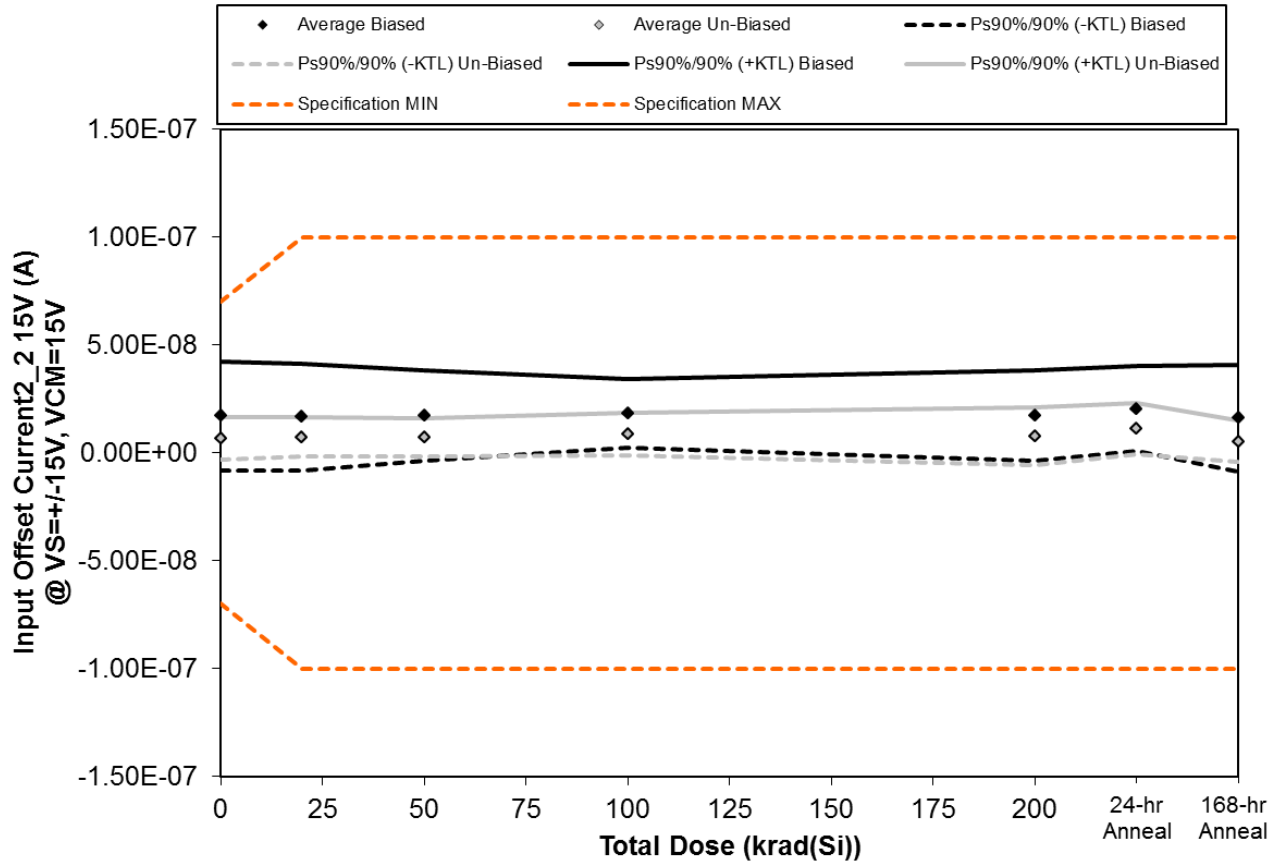

Figure 5.14. Plot of Input Offset Current2_2 15V (A) @ VS=+-15V, VCM=15V versus total dose. The solid diamonds are the average of the measured data points for the samples irradiated under electrical bias while the shaded diamonds are the average of the measured data points for the samples irradiated with all pins tied to ground. The black lines (solid and/or dashed) are the upper and/or lower confidence limits, as determined by KTL statistics, on the samples irradiated under electrical bias while the gray lines (solid and/or dashed) are the upper and/or lower confidence limits, as determined by KTL statistics, on the samples irradiated in the unbiased condition. The red dotted line(s) are the pre- and/or post-irradiation minimum and/or maximum specification value as defined in the datasheet and/or test plan.



TID Report
15-0091 03/20/15 R1.0

Aeroflex RAD
5030 Centennial Blvd.
Colorado Springs, CO 80919
(719) 531-0800

Table 5.14. Raw data for Input Offset Current_{2_2} 15V (A) @ VS=+/-15V, VCM=15V versus total dose, including the statistical analysis, specification and the status of the testing (pass/fail).

Input Offset Current _{2_2} 15V (A) @ VS=+/-15V, VCM=15V	Total Dose (krad(Si))					24-hr Anneal	168-hr Anneal
	Device	0	20	50	100		
680	1.11E-09	1.07E-09	4.16E-09	9.55E-09	4.96E-09	8.55E-09	7.30E-10
681	2.25E-08	2.12E-08	2.10E-08	2.02E-08	1.75E-08	2.22E-08	2.02E-08
682	2.21E-08	2.08E-08	2.18E-08	2.33E-08	2.30E-08	2.69E-08	2.20E-08
683	1.71E-08	1.67E-08	1.65E-08	1.56E-08	1.69E-08	1.97E-08	1.54E-08
684	2.26E-08	2.29E-08	2.27E-08	2.32E-08	2.41E-08	2.52E-08	2.19E-08
685	9.39E-09	9.13E-09	1.10E-08	1.17E-08	1.17E-08	1.59E-08	8.62E-09
686	1.02E-08	1.10E-08	9.35E-09	1.19E-08	1.18E-08	1.46E-08	6.92E-09
688	2.71E-09	2.91E-09	3.76E-09	4.42E-09	1.11E-09	5.78E-09	1.34E-09
689	8.27E-09	9.19E-09	8.56E-09	1.05E-08	1.01E-08	1.26E-08	8.27E-09
690	2.70E-09	4.84E-09	4.04E-09	5.30E-09	3.91E-09	7.96E-09	1.76E-09
691	1.50E-08	1.61E-08	1.72E-08	1.79E-08	1.89E-08	2.00E-08	2.11E-08
692	2.54E-08	2.59E-08	2.61E-08	2.70E-08	2.77E-08	2.79E-08	2.79E-08
Biased Statistics							
Average Biased	1.71E-08	1.65E-08	1.72E-08	1.84E-08	1.73E-08	2.05E-08	1.60E-08
Std Dev Biased	9.21E-09	8.94E-09	7.67E-09	5.83E-09	7.61E-09	7.22E-09	8.97E-09
Ps90%/90% (+KTL) Biased	4.23E-08	4.10E-08	3.83E-08	3.43E-08	3.82E-08	4.03E-08	4.07E-08
Ps90%/90% (-KTL) Biased	-8.18E-09	-7.98E-09	-3.83E-09	2.40E-09	-3.57E-09	7.09E-10	-8.55E-09
Un-Biased Statistics							
Average Un-Biased	6.65E-09	7.42E-09	7.33E-09	8.76E-09	7.72E-09	1.14E-08	5.38E-09
Std Dev Un-Biased	3.67E-09	3.39E-09	3.25E-09	3.61E-09	4.91E-09	4.34E-09	3.56E-09
Ps90%/90% (+KTL) Un-Biased	1.67E-08	1.67E-08	1.62E-08	1.87E-08	2.12E-08	2.33E-08	1.51E-08
Ps90%/90% (-KTL) Un-Biased	-3.40E-09	-1.88E-09	-1.58E-09	-1.15E-09	-5.73E-09	-5.26E-10	-4.37E-09
Specification MIN	-7.00E-08	-1.00E-07	-1.00E-07	-1.00E-07	-1.00E-07	-1.00E-07	-1.00E-07
Status	PASS	PASS	PASS	PASS	PASS	PASS	PASS
Specification MAX	7.00E-08	1.00E-07	1.00E-07	1.00E-07	1.00E-07	1.00E-07	1.00E-07
Status	PASS	PASS	PASS	PASS	PASS	PASS	PASS

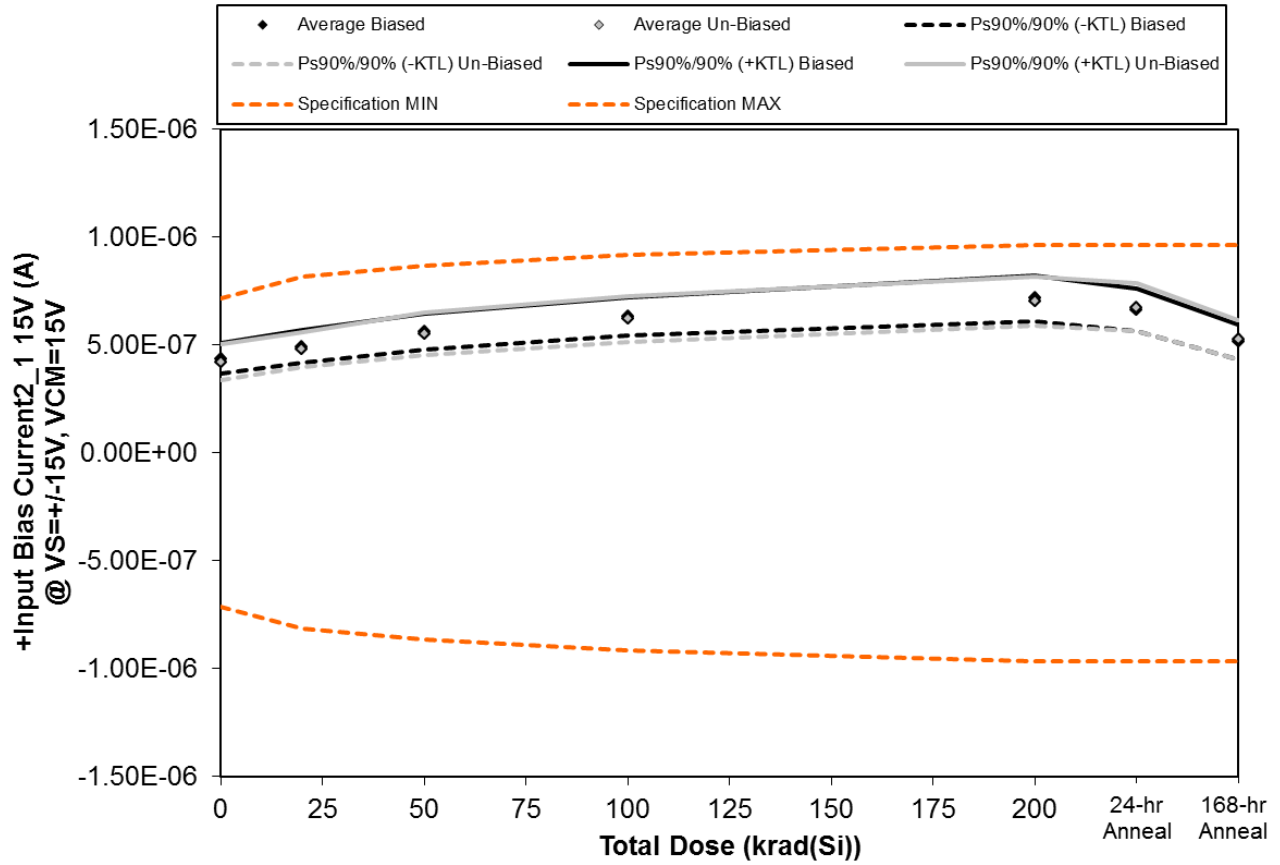

Figure 5.15. Plot of +Input Bias Current2_1 15V (A) @ VS=+-15V, VCM=15V versus total dose. The solid diamonds are the average of the measured data points for the samples irradiated under electrical bias while the shaded diamonds are the average of the measured data points for the samples irradiated with all pins tied to ground. The black lines (solid and/or dashed) are the upper and/or lower confidence limits, as determined by KTL statistics, on the samples irradiated under electrical bias while the gray lines (solid and/or dashed) are the upper and/or lower confidence limits, as determined by KTL statistics, on the samples irradiated in the unbiased condition. The red dotted line(s) are the pre- and/or post-irradiation minimum and/or maximum specification value as defined in the datasheet and/or test plan.



TID Report
15-0091 03/20/15 R1.0

Aeroflex RAD
5030 Centennial Blvd.
Colorado Springs, CO 80919
(719) 531-0800

Table 5.15. Raw data for +Input Bias Current2_1 15V (A) @ VS=+/-15V, VCM=15V versus total dose, including the statistical analysis, specification and the status of the testing (pass/fail).

+Input Bias Current2_1 15V (A) @ VS=+/-15V, VCM=15V	Total Dose (krad(Si))					24-hr	168-hr
	0	20	50	100	200	Anneal	Anneal
Device							
680	4.48E-07	5.05E-07	5.81E-07	6.50E-07	7.38E-07	6.84E-07	5.26E-07
681	4.32E-07	4.87E-07	5.54E-07	6.26E-07	7.09E-07	6.53E-07	5.09E-07
682	4.67E-07	5.25E-07	5.93E-07	6.65E-07	7.55E-07	6.97E-07	5.48E-07
683	3.96E-07	4.49E-07	5.16E-07	5.82E-07	6.55E-07	6.04E-07	4.68E-07
684	4.45E-07	4.98E-07	5.70E-07	6.39E-07	7.22E-07	6.67E-07	5.24E-07
685	4.31E-07	4.88E-07	5.60E-07	6.31E-07	7.11E-07	6.84E-07	5.36E-07
686	4.38E-07	4.98E-07	5.70E-07	6.40E-07	7.26E-07	6.94E-07	5.38E-07
688	3.77E-07	4.39E-07	5.03E-07	5.69E-07	6.51E-07	6.23E-07	4.80E-07
689	4.00E-07	4.60E-07	5.30E-07	5.95E-07	6.69E-07	6.43E-07	5.06E-07
690	4.51E-07	5.08E-07	5.96E-07	6.66E-07	7.52E-07	7.24E-07	5.66E-07
691	4.37E-07	4.37E-07	4.40E-07	4.39E-07	4.41E-07	4.41E-07	4.42E-07
692	4.37E-07	4.35E-07	4.37E-07	4.37E-07	4.36E-07	4.38E-07	4.40E-07
Biased Statistics							
Average Biased	4.38E-07	4.93E-07	5.63E-07	6.32E-07	7.16E-07	6.61E-07	5.15E-07
Std Dev Biased	2.65E-08	2.81E-08	3.00E-08	3.17E-08	3.82E-08	3.59E-08	2.98E-08
Ps90%/90% (+KTL) Biased	5.10E-07	5.70E-07	6.45E-07	7.19E-07	8.21E-07	7.59E-07	5.97E-07
Ps90%/90% (-KTL) Biased	3.65E-07	4.16E-07	4.81E-07	5.45E-07	6.11E-07	5.63E-07	4.33E-07
Un-Biased Statistics							
Average Un-Biased	4.19E-07	4.79E-07	5.52E-07	6.20E-07	7.02E-07	6.73E-07	5.25E-07
Std Dev Un-Biased	3.04E-08	2.87E-08	3.62E-08	3.81E-08	4.13E-08	4.04E-08	3.31E-08
Ps90%/90% (+KTL) Un-Biased	5.03E-07	5.57E-07	6.51E-07	7.25E-07	8.15E-07	7.84E-07	6.16E-07
Ps90%/90% (-KTL) Un-Biased	3.36E-07	4.00E-07	4.52E-07	5.15E-07	5.88E-07	5.63E-07	4.34E-07
Specification MIN	-7.15E-07	-8.15E-07	-8.65E-07	-9.15E-07	-9.65E-07	-9.65E-07	-9.65E-07
Status	PASS	PASS	PASS	PASS	PASS	PASS	PASS
Specification MAX	7.15E-07	8.15E-07	8.65E-07	9.15E-07	9.65E-07	9.65E-07	9.65E-07
Status	PASS	PASS	PASS	PASS	PASS	PASS	PASS

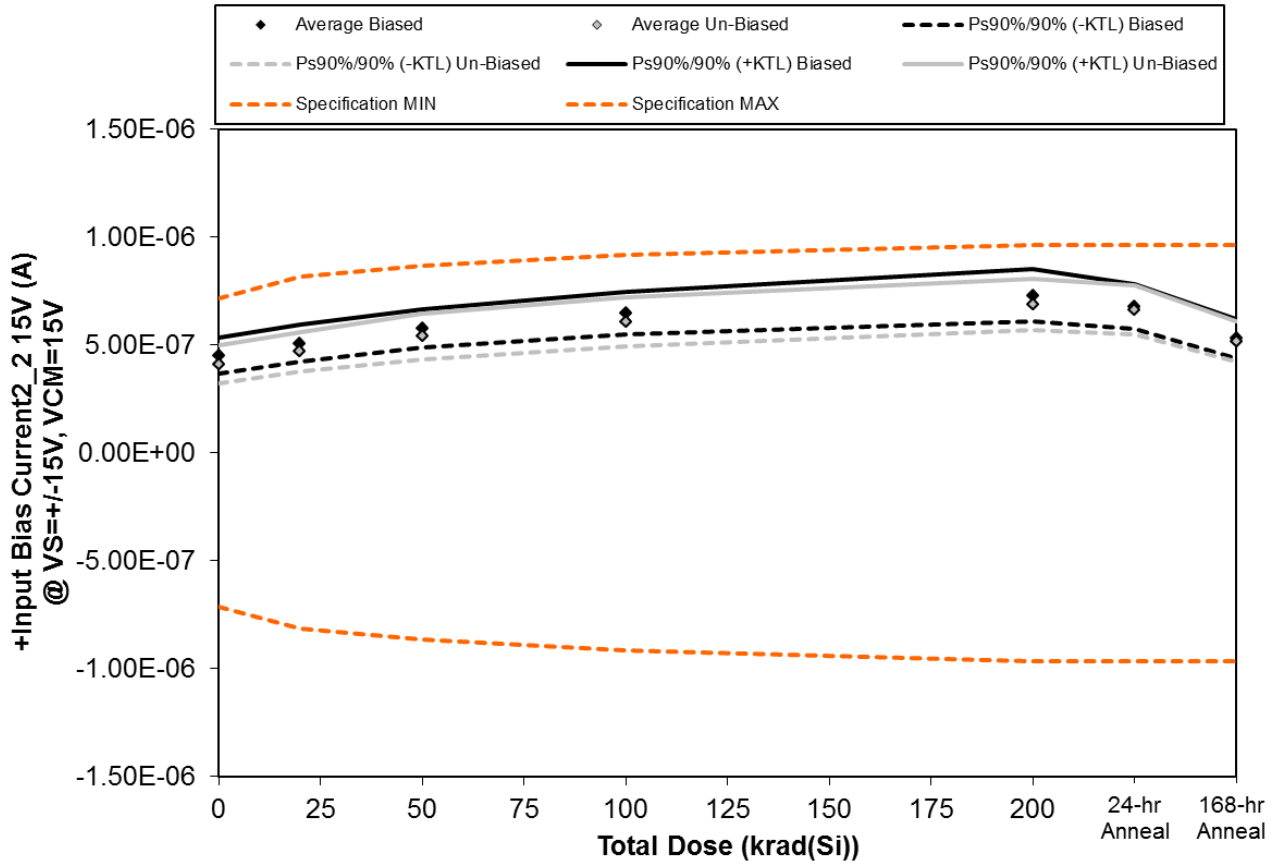

Figure 5.16. Plot of +Input Bias Current2_2 15V (A) @ VS=+-15V, VCM=15V versus total dose. The solid diamonds are the average of the measured data points for the samples irradiated under electrical bias while the shaded diamonds are the average of the measured data points for the samples irradiated with all pins tied to ground. The black lines (solid and/or dashed) are the upper and/or lower confidence limits, as determined by KTL statistics, on the samples irradiated under electrical bias while the gray lines (solid and/or dashed) are the upper and/or lower confidence limits, as determined by KTL statistics, on the samples irradiated in the unbiased condition. The red dotted line(s) are the pre- and/or post-irradiation minimum and/or maximum specification value as defined in the datasheet and/or test plan.



TID Report
15-0091 03/20/15 R1.0

Aeroflex RAD
5030 Centennial Blvd.
Colorado Springs, CO 80919
(719) 531-0800

Table 5.16. Raw data for +Input Bias Current_{2_2} 15V (A) @ VS=+/-15V, VCM=15V versus total dose, including the statistical analysis, specification and the status of the testing (pass/fail).

+Input Bias Current _{2_2} 15V (A) @ VS=+/-15V, VCM=15V	Total Dose (krad(Si))					24-hr Anneal	168-hr Anneal
	0	20	50	100	200		
Device							
680	4.48E-07	5.07E-07	5.82E-07	6.53E-07	7.43E-07	6.86E-07	5.27E-07
681	4.57E-07	5.12E-07	5.77E-07	6.45E-07	7.27E-07	6.74E-07	5.33E-07
682	4.87E-07	5.44E-07	6.12E-07	6.87E-07	7.81E-07	7.21E-07	5.67E-07
683	4.05E-07	4.58E-07	5.24E-07	5.90E-07	6.62E-07	6.16E-07	4.77E-07
684	4.61E-07	5.19E-07	5.89E-07	6.62E-07	7.40E-07	6.86E-07	5.45E-07
685	4.28E-07	4.86E-07	5.56E-07	6.27E-07	7.09E-07	6.80E-07	5.33E-07
686	4.39E-07	4.99E-07	5.70E-07	6.41E-07	7.25E-07	6.95E-07	5.41E-07
688	3.59E-07	4.16E-07	4.78E-07	5.43E-07	6.25E-07	6.00E-07	4.61E-07
689	4.02E-07	4.60E-07	5.25E-07	5.91E-07	6.64E-07	6.41E-07	5.07E-07
690	4.26E-07	4.86E-07	5.70E-07	6.40E-07	7.23E-07	6.97E-07	5.40E-07
691	4.51E-07	4.50E-07	4.52E-07	4.53E-07	4.53E-07	4.55E-07	4.56E-07
692	4.46E-07	4.46E-07	4.46E-07	4.47E-07	4.48E-07	4.46E-07	4.48E-07
Biased Statistics							
Average Biased	4.51E-07	5.08E-07	5.77E-07	6.47E-07	7.30E-07	6.76E-07	5.30E-07
Std Dev Biased	2.99E-08	3.13E-08	3.26E-08	3.58E-08	4.33E-08	3.82E-08	3.33E-08
Ps90%/90% (+KTL) Biased	5.34E-07	5.94E-07	6.66E-07	7.45E-07	8.49E-07	7.81E-07	6.21E-07
Ps90%/90% (-KTL) Biased	3.69E-07	4.22E-07	4.87E-07	5.49E-07	6.12E-07	5.72E-07	4.39E-07
Un-Biased Statistics							
Average Un-Biased	4.11E-07	4.70E-07	5.40E-07	6.09E-07	6.89E-07	6.63E-07	5.16E-07
Std Dev Un-Biased	3.21E-08	3.29E-08	3.91E-08	4.16E-08	4.34E-08	4.18E-08	3.40E-08
Ps90%/90% (+KTL) Un-Biased	4.99E-07	5.60E-07	6.47E-07	7.22E-07	8.08E-07	7.77E-07	6.09E-07
Ps90%/90% (-KTL) Un-Biased	3.23E-07	3.79E-07	4.33E-07	4.95E-07	5.70E-07	5.48E-07	4.23E-07
Specification MIN	-7.15E-07	-8.15E-07	-8.65E-07	-9.15E-07	-9.65E-07	-9.65E-07	-9.65E-07
Status	PASS	PASS	PASS	PASS	PASS	PASS	PASS
Specification MAX	7.15E-07	8.15E-07	8.65E-07	9.15E-07	9.65E-07	9.65E-07	9.65E-07
Status	PASS	PASS	PASS	PASS	PASS	PASS	PASS

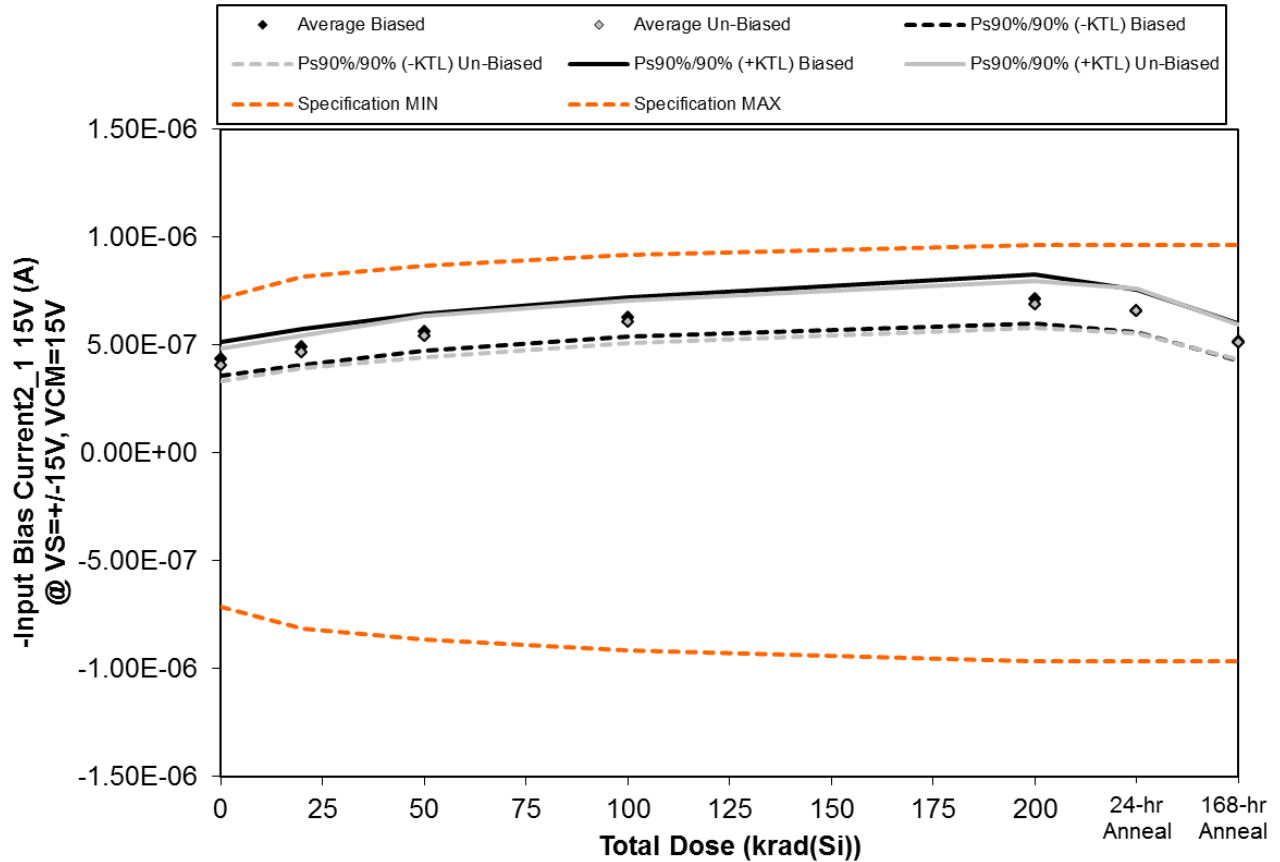

Figure 5.17. Plot of -Input Bias Current2_1 15V (A) @ VS=+-15V, VCM=15V versus total dose. The solid diamonds are the average of the measured data points for the samples irradiated under electrical bias while the shaded diamonds are the average of the measured data points for the samples irradiated with all pins tied to ground. The black lines (solid and/or dashed) are the upper and/or lower confidence limits, as determined by KTL statistics, on the samples irradiated under electrical bias while the gray lines (solid and/or dashed) are the upper and/or lower confidence limits, as determined by KTL statistics, on the samples irradiated in the unbiased condition. The red dotted line(s) are the pre- and/or post-irradiation minimum and/or maximum specification value as defined in the datasheet and/or test plan.



**TID Report
15-0091 03/20/15 R1.0**

**Aeroflex RAD
5030 Centennial Blvd.
Colorado Springs, CO 80919
(719) 531-0800**

Table 5.17. Raw data for -Input Bias Current2_1 15V (A) @ VS=+/-15V, VCM=15V versus total dose, including the statistical analysis, specification and the status of the testing (pass/fail).

-Input Bias Current2_1 15V (A) @ VS=+/-15V, VCM=15V	Total Dose (krad(Si))					24-hr	168-hr
	0	20	50	100	200	Anneal	Anneal
Device							
680	4.42E-07	4.98E-07	5.71E-07	6.35E-07	7.27E-07	6.68E-07	5.20E-07
681	4.31E-07	4.88E-07	5.53E-07	6.22E-07	7.06E-07	6.49E-07	5.09E-07
682	4.75E-07	5.35E-07	6.02E-07	6.76E-07	7.68E-07	7.03E-07	5.55E-07
683	3.94E-07	4.49E-07	5.15E-07	5.82E-07	6.54E-07	6.03E-07	4.69E-07
684	4.34E-07	4.90E-07	5.60E-07	6.29E-07	7.11E-07	6.55E-07	5.15E-07
685	4.19E-07	4.78E-07	5.50E-07	6.16E-07	6.98E-07	6.67E-07	5.25E-07
686	4.29E-07	4.91E-07	5.64E-07	6.32E-07	7.16E-07	6.84E-07	5.34E-07
688	3.61E-07	4.21E-07	4.83E-07	5.49E-07	6.29E-07	6.00E-07	4.65E-07
689	3.98E-07	4.59E-07	5.30E-07	5.94E-07	6.69E-07	6.43E-07	5.05E-07
690	4.25E-07	4.83E-07	5.71E-07	6.39E-07	7.25E-07	6.93E-07	5.38E-07
691	4.32E-07	4.33E-07	4.32E-07	4.31E-07	4.33E-07	4.34E-07	4.33E-07
692	4.19E-07	4.19E-07	4.19E-07	4.19E-07	4.19E-07	4.20E-07	4.20E-07
Biased Statistics							
Average Biased	4.35E-07	4.92E-07	5.60E-07	6.29E-07	7.13E-07	6.56E-07	5.14E-07
Std Dev Biased	2.87E-08	3.05E-08	3.13E-08	3.35E-08	4.10E-08	3.61E-08	3.05E-08
Ps90%/90% (+KTL) Biased	5.14E-07	5.76E-07	6.46E-07	7.21E-07	8.25E-07	7.54E-07	5.98E-07
Ps90%/90% (-KTL) Biased	3.56E-07	4.08E-07	4.74E-07	5.37E-07	6.01E-07	5.57E-07	4.30E-07
Un-Biased Statistics							
Average Un-Biased	4.06E-07	4.66E-07	5.39E-07	6.06E-07	6.87E-07	6.57E-07	5.13E-07
Std Dev Un-Biased	2.78E-08	2.79E-08	3.52E-08	3.60E-08	3.92E-08	3.74E-08	3.00E-08
Ps90%/90% (+KTL) Un-Biased	4.82E-07	5.43E-07	6.36E-07	7.05E-07	7.95E-07	7.60E-07	5.95E-07
Ps90%/90% (-KTL) Un-Biased	3.30E-07	3.90E-07	4.43E-07	5.07E-07	5.80E-07	5.55E-07	4.31E-07
Specification MIN	-7.15E-07	-8.15E-07	-8.65E-07	-9.15E-07	-9.65E-07	-9.65E-07	-9.65E-07
Status	PASS	PASS	PASS	PASS	PASS	PASS	PASS
Specification MAX	7.15E-07	8.15E-07	8.65E-07	9.15E-07	9.65E-07	9.65E-07	9.65E-07
Status	PASS	PASS	PASS	PASS	PASS	PASS	PASS

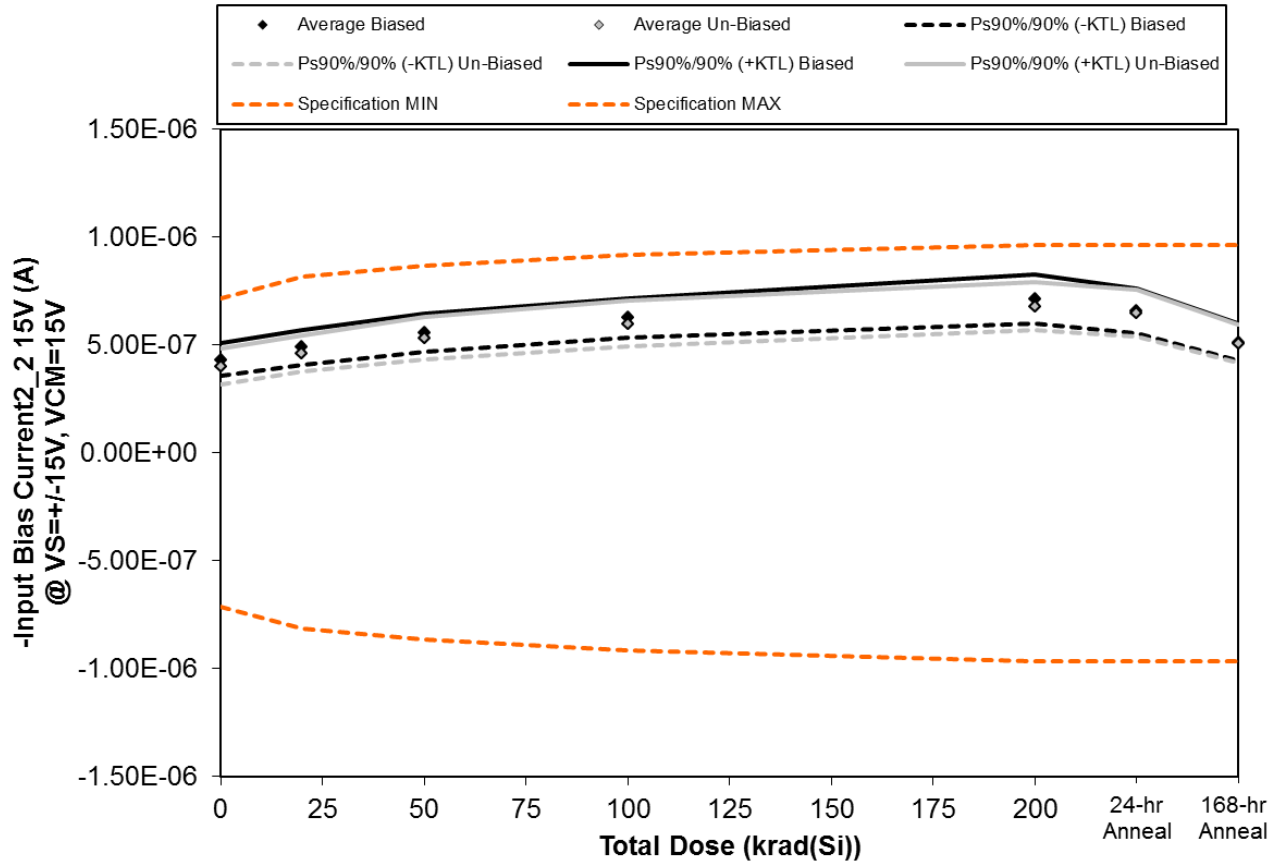

Figure 5.18. Plot of -Input Bias Current2_2 15V (A) @ VS=+-15V, VCM=15V versus total dose. The solid diamonds are the average of the measured data points for the samples irradiated under electrical bias while the shaded diamonds are the average of the measured data points for the samples irradiated with all pins tied to ground. The black lines (solid and/or dashed) are the upper and/or lower confidence limits, as determined by KTL statistics, on the samples irradiated under electrical bias while the gray lines (solid and/or dashed) are the upper and/or lower confidence limits, as determined by KTL statistics, on the samples irradiated in the unbiased condition. The red dotted line(s) are the pre- and/or post-irradiation minimum and/or maximum specification value as defined in the datasheet and/or test plan.



TID Report
15-0091 03/20/15 R1.0

Aeroflex RAD
5030 Centennial Blvd.
Colorado Springs, CO 80919
(719) 531-0800

Table 5.18. Raw data for -Input Bias Current_{2_2} 15V (A) @ VS=+/-15V, VCM=15V versus total dose, including the statistical analysis, specification and the status of the testing (pass/fail).

-Input Bias Current _{2_2} 15V (A) @ VS=+/-15V, VCM=15V	Total Dose (krad(Si))					24-hr	168-hr
	0	20	50	100	200	Anneal	Anneal
Device							
680	4.42E-07	5.02E-07	5.76E-07	6.41E-07	7.33E-07	6.76E-07	5.23E-07
681	4.31E-07	4.87E-07	5.55E-07	6.23E-07	7.07E-07	6.52E-07	5.10E-07
682	4.61E-07	5.21E-07	5.88E-07	6.62E-07	7.55E-07	6.92E-07	5.43E-07
683	3.86E-07	4.40E-07	5.04E-07	5.73E-07	6.45E-07	5.93E-07	4.59E-07
684	4.38E-07	4.94E-07	5.65E-07	6.32E-07	7.16E-07	6.64E-07	5.20E-07
685	4.16E-07	4.73E-07	5.44E-07	6.12E-07	6.92E-07	6.62E-07	5.21E-07
686	4.25E-07	4.86E-07	5.57E-07	6.28E-07	7.12E-07	6.79E-07	5.30E-07
688	3.53E-07	4.11E-07	4.74E-07	5.38E-07	6.22E-07	5.92E-07	4.55E-07
689	3.91E-07	4.49E-07	5.16E-07	5.78E-07	6.52E-07	6.25E-07	4.95E-07
690	4.21E-07	4.79E-07	5.63E-07	6.29E-07	7.14E-07	6.86E-07	5.33E-07
691	4.32E-07	4.31E-07	4.32E-07	4.32E-07	4.32E-07	4.33E-07	4.33E-07
692	4.16E-07	4.16E-07	4.17E-07	4.17E-07	4.16E-07	4.17E-07	4.17E-07
Biased Statistics							
Average Biased	4.32E-07	4.89E-07	5.57E-07	6.26E-07	7.11E-07	6.55E-07	5.11E-07
Std Dev Biased	2.78E-08	3.02E-08	3.24E-08	3.32E-08	4.13E-08	3.77E-08	3.13E-08
Ps90%/90% (+KTL) Biased	5.08E-07	5.71E-07	6.46E-07	7.17E-07	8.24E-07	7.59E-07	5.97E-07
Ps90%/90% (-KTL) Biased	3.55E-07	4.06E-07	4.69E-07	5.35E-07	5.98E-07	5.52E-07	4.25E-07
Un-Biased Statistics							
Average Un-Biased	4.01E-07	4.59E-07	5.31E-07	5.97E-07	6.79E-07	6.49E-07	5.07E-07
Std Dev Un-Biased	2.99E-08	3.03E-08	3.66E-08	3.86E-08	4.05E-08	3.93E-08	3.24E-08
Ps90%/90% (+KTL) Un-Biased	4.83E-07	5.43E-07	6.31E-07	7.03E-07	7.89E-07	7.56E-07	5.96E-07
Ps90%/90% (-KTL) Un-Biased	3.19E-07	3.76E-07	4.31E-07	4.91E-07	5.68E-07	5.41E-07	4.18E-07
Specification MIN	-7.15E-07	-8.15E-07	-8.65E-07	-9.15E-07	-9.65E-07	-9.65E-07	-9.65E-07
Status	PASS	PASS	PASS	PASS	PASS	PASS	PASS
Specification MAX	7.15E-07	8.15E-07	8.65E-07	9.15E-07	9.65E-07	9.65E-07	9.65E-07
Status	PASS	PASS	PASS	PASS	PASS	PASS	PASS

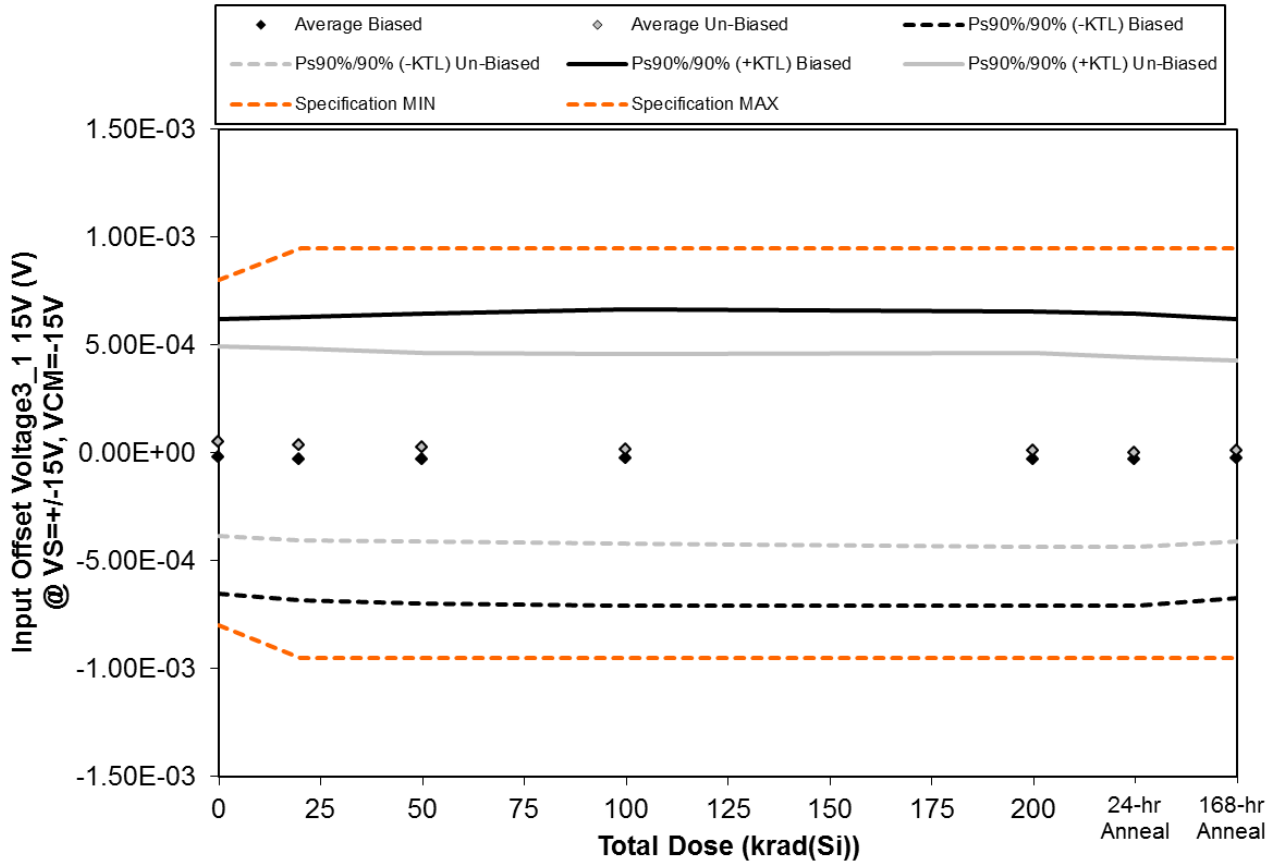

Figure 5.19. Plot of Input Offset Voltage3_1 15V (V) @ VS=+-15V, VCM=-15V versus total dose. The solid diamonds are the average of the measured data points for the samples irradiated under electrical bias while the shaded diamonds are the average of the measured data points for the samples irradiated with all pins tied to ground. The black lines (solid and/or dashed) are the upper and/or lower confidence limits, as determined by KTL statistics, on the samples irradiated under electrical bias while the gray lines (solid and/or dashed) are the upper and/or lower confidence limits, as determined by KTL statistics, on the samples irradiated in the unbiased condition. The red dotted line(s) are the pre- and/or post-irradiation minimum and/or maximum specification value as defined in the datasheet and/or test plan.



TID Report
15-0091 03/20/15 R1.0

Aeroflex RAD
5030 Centennial Blvd.
Colorado Springs, CO 80919
(719) 531-0800

Table 5.19. Raw data for Input Offset Voltage3_1 15V (V) @ VS=+/-15V, VCM=-15V versus total dose, including the statistical analysis, specification and the status of the testing (pass/fail).

Input Offset Voltage3_1 15V (V) @ VS=+/-15V, VCM=-15V	Total Dose (krad(Si))					24-hr	168-hr
	0	20	50	100	200	Anneal	Anneal
Device							
680	3.15E-04	3.11E-04	3.13E-04	3.26E-04	3.12E-04	3.09E-04	3.03E-04
681	-2.99E-04	-3.22E-04	-3.26E-04	-3.28E-04	-3.34E-04	-3.35E-04	-3.14E-04
682	-1.48E-04	-1.64E-04	-1.75E-04	-1.78E-04	-1.89E-04	-1.82E-04	-1.66E-04
683	-3.04E-05	-3.27E-05	-2.72E-05	-1.37E-05	-1.16E-05	-2.43E-05	-2.69E-05
684	7.79E-05	7.38E-05	7.98E-05	8.37E-05	8.27E-05	7.65E-05	7.60E-05
685	9.26E-05	8.17E-05	6.47E-05	5.61E-05	5.14E-05	3.95E-05	4.30E-05
686	1.12E-04	1.06E-04	9.61E-05	9.59E-05	8.95E-05	7.73E-05	7.43E-05
688	-2.26E-04	-2.46E-04	-2.52E-04	-2.62E-04	-2.74E-04	-2.80E-04	-2.56E-04
689	1.83E-04	1.62E-04	1.50E-04	1.36E-04	1.36E-04	1.18E-04	1.35E-04
690	1.06E-04	8.43E-05	6.95E-05	6.79E-05	6.25E-05	5.52E-05	5.28E-05
691	-1.50E-04	-1.49E-04	-1.50E-04	-1.49E-04	-1.50E-04	-1.51E-04	-1.49E-04
692	-2.53E-04	-2.51E-04	-2.52E-04	-2.54E-04	-2.52E-04	-2.53E-04	-2.54E-04
Biased Statistics							
Average Biased	-1.69E-05	-2.66E-05	-2.69E-05	-2.20E-05	-2.79E-05	-3.11E-05	-2.56E-05
Std Dev Biased	2.33E-04	2.40E-04	2.44E-04	2.50E-04	2.49E-04	2.46E-04	2.35E-04
Ps90%/90% (+KTL) Biased	6.21E-04	6.32E-04	6.42E-04	6.64E-04	6.54E-04	6.44E-04	6.20E-04
Ps90%/90% (-KTL) Biased	-6.55E-04	-6.85E-04	-6.96E-04	-7.08E-04	-7.10E-04	-7.06E-04	-6.71E-04
Un-Biased Statistics							
Average Un-Biased	5.37E-05	3.75E-05	2.55E-05	1.88E-05	1.31E-05	2.09E-06	9.68E-06
Std Dev Un-Biased	1.60E-04	1.62E-04	1.59E-04	1.60E-04	1.64E-04	1.60E-04	1.53E-04
Ps90%/90% (+KTL) Un-Biased	4.93E-04	4.82E-04	4.61E-04	4.58E-04	4.63E-04	4.42E-04	4.29E-04
Ps90%/90% (-KTL) Un-Biased	-3.85E-04	-4.07E-04	-4.10E-04	-4.20E-04	-4.36E-04	-4.38E-04	-4.10E-04
Specification MIN	-8.00E-04	-9.50E-04	-9.50E-04	-9.50E-04	-9.50E-04	-9.50E-04	-9.50E-04
Status	PASS	PASS	PASS	PASS	PASS	PASS	PASS
Specification MAX	8.00E-04	9.50E-04	9.50E-04	9.50E-04	9.50E-04	9.50E-04	9.50E-04
Status	PASS	PASS	PASS	PASS	PASS	PASS	PASS

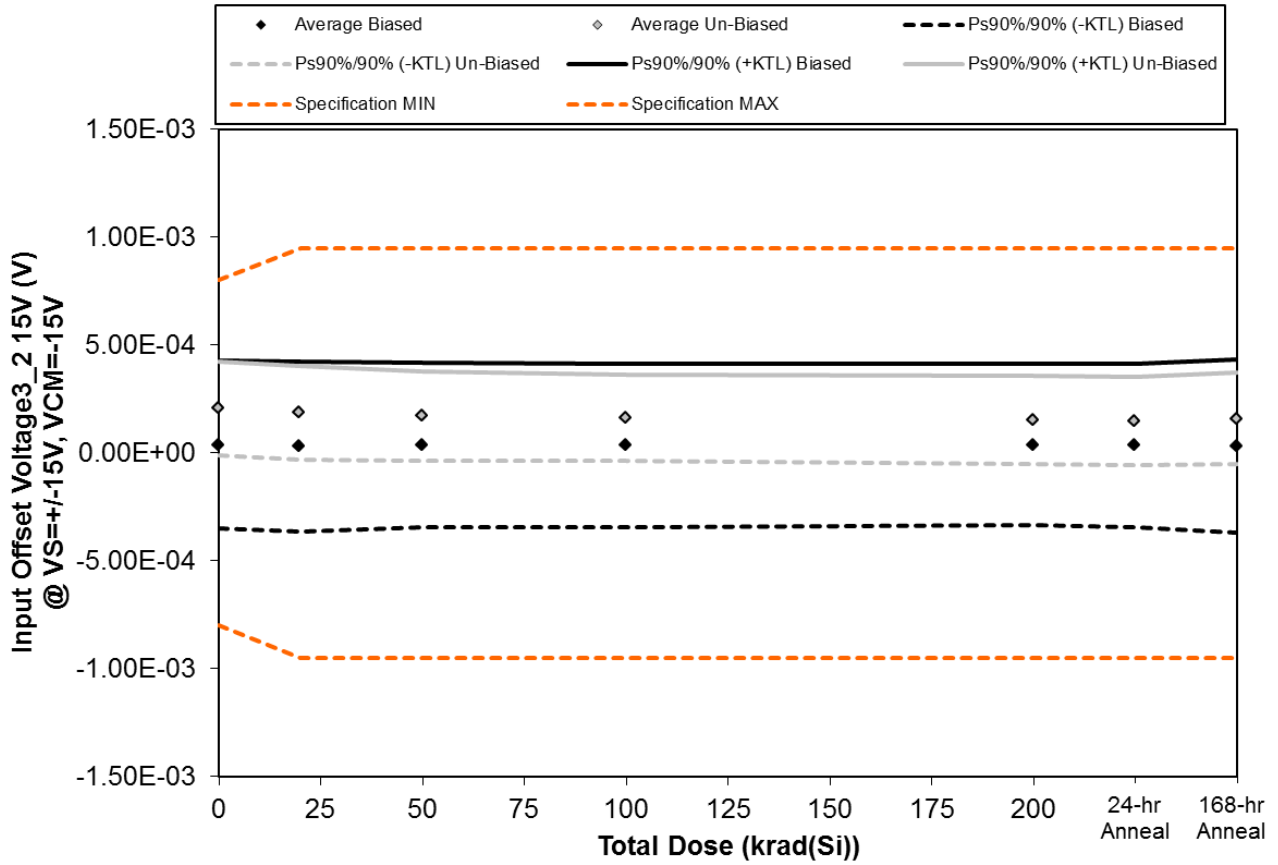

Figure 5.20. Plot of Input Offset Voltage_{3_2 15V (V) @ VS=+-15V, VCM=-15V versus total dose. The solid diamonds are the average of the measured data points for the samples irradiated under electrical bias while the shaded diamonds are the average of the measured data points for the samples irradiated with all pins tied to ground. The black lines (solid and/or dashed) are the upper and/or lower confidence limits, as determined by KTL statistics, on the samples irradiated under electrical bias while the gray lines (solid and/or dashed) are the upper and/or lower confidence limits, as determined by KTL statistics, on the samples irradiated in the unbiased condition. The red dotted line(s) are the pre- and/or post-irradiation minimum and/or maximum specification value as defined in the datasheet and/or test plan.}



TID Report
15-0091 03/20/15 R1.0

Aeroflex RAD
5030 Centennial Blvd.
Colorado Springs, CO 80919
(719) 531-0800

Table 5.20. Raw data for Input Offset Voltage_{3_2} 15V (V) @ VS=+/-15V, VCM=-15V versus total dose, including the statistical analysis, specification and the status of the testing (pass/fail).

Input Offset Voltage _{3_2} 15V (V) @ VS=+/-15V, VCM=-15V	Total Dose (krad(Si))					24-hr Anneal	168-hr Anneal
	0	20	50	100	200		
Device							
680	-7.07E-05	-7.56E-05	-6.46E-05	-6.90E-05	-6.05E-05	-7.09E-05	-7.81E-05
681	5.38E-05	4.44E-05	4.84E-05	4.84E-05	4.95E-05	5.21E-05	4.11E-05
682	-1.25E-04	-1.39E-04	-1.30E-04	-1.24E-04	-1.20E-04	-1.25E-04	-1.37E-04
683	1.02E-04	8.83E-05	8.97E-05	9.46E-05	9.62E-05	8.90E-05	9.74E-05
684	2.33E-04	2.26E-04	2.28E-04	2.25E-04	2.30E-04	2.26E-04	2.33E-04
685	3.36E-04	3.19E-04	2.98E-04	2.81E-04	2.74E-04	2.69E-04	2.89E-04
686	1.27E-04	1.09E-04	9.39E-05	8.15E-05	6.69E-05	6.49E-05	7.89E-05
688	1.96E-04	1.70E-04	1.60E-04	1.55E-04	1.46E-04	1.44E-04	1.49E-04
689	1.65E-04	1.50E-04	1.46E-04	1.37E-04	1.36E-04	1.29E-04	1.29E-04
690	2.05E-04	1.84E-04	1.59E-04	1.53E-04	1.46E-04	1.32E-04	1.53E-04
691	1.46E-05	1.23E-05	1.09E-05	1.41E-05	1.06E-05	1.29E-05	5.98E-06
692	1.81E-04	1.78E-04	1.78E-04	1.81E-04	1.79E-04	1.79E-04	1.81E-04
Biased Statistics							
Average Biased	3.86E-05	2.90E-05	3.43E-05	3.49E-05	3.89E-05	3.42E-05	3.13E-05
Std Dev Biased	1.42E-04	1.43E-04	1.39E-04	1.38E-04	1.37E-04	1.39E-04	1.46E-04
Ps90%/90% (+KTL) Biased	4.28E-04	4.21E-04	4.15E-04	4.13E-04	4.14E-04	4.14E-04	4.32E-04
Ps90%/90% (-KTL) Biased	-3.51E-04	-3.63E-04	-3.47E-04	-3.43E-04	-3.37E-04	-3.46E-04	-3.69E-04
Un-Biased Statistics							
Average Un-Biased	2.06E-04	1.86E-04	1.71E-04	1.61E-04	1.54E-04	1.48E-04	1.60E-04
Std Dev Un-Biased	7.89E-05	7.94E-05	7.57E-05	7.30E-05	7.50E-05	7.46E-05	7.80E-05
Ps90%/90% (+KTL) Un-Biased	4.22E-04	4.04E-04	3.79E-04	3.62E-04	3.59E-04	3.52E-04	3.73E-04
Ps90%/90% (-KTL) Un-Biased	-1.06E-05	-3.12E-05	-3.63E-05	-3.88E-05	-5.20E-05	-5.67E-05	-5.42E-05
Specification MIN	-8.00E-04	-9.50E-04	-9.50E-04	-9.50E-04	-9.50E-04	-9.50E-04	-9.50E-04
Status	PASS	PASS	PASS	PASS	PASS	PASS	PASS
Specification MAX	8.00E-04	9.50E-04	9.50E-04	9.50E-04	9.50E-04	9.50E-04	9.50E-04
Status	PASS	PASS	PASS	PASS	PASS	PASS	PASS

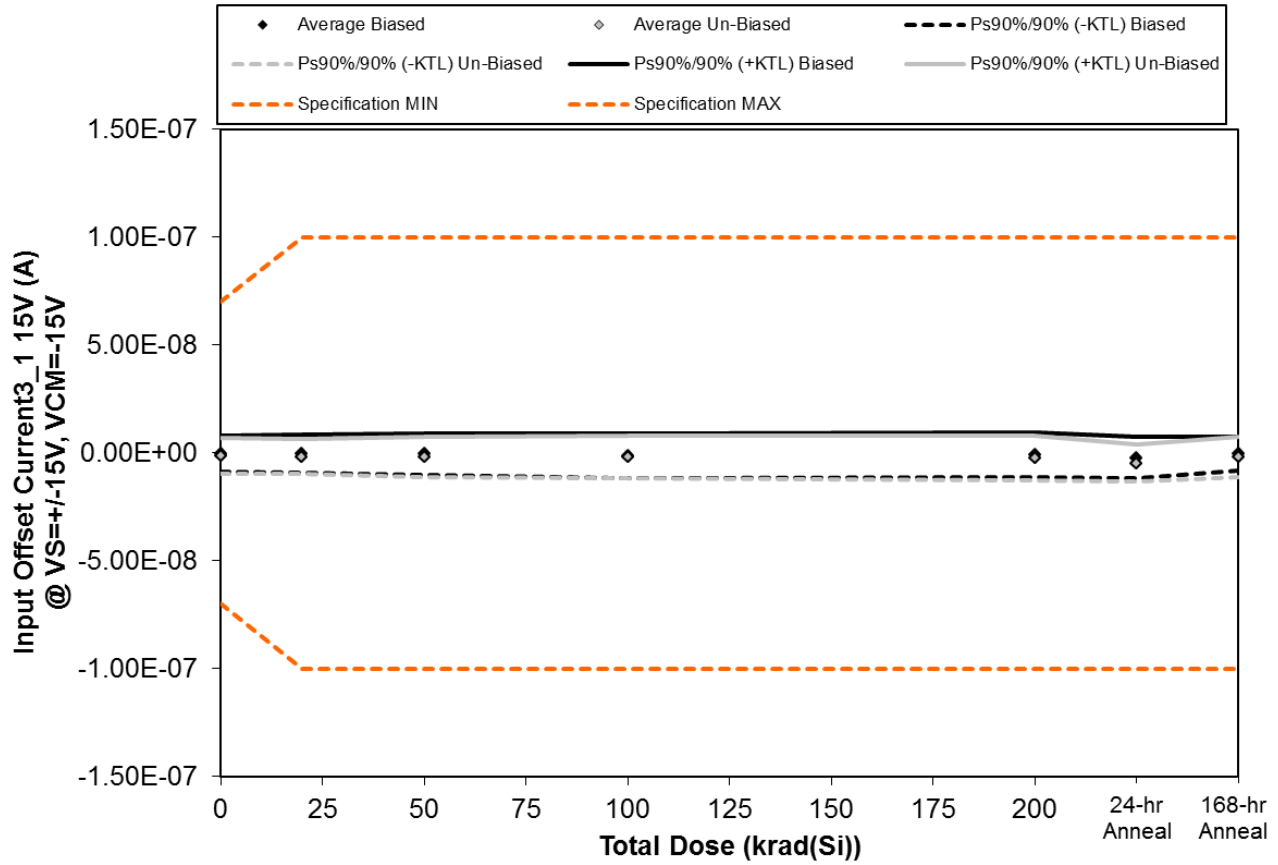

Figure 5.21. Plot of Input Offset Current3_1 15V (A) @ VS=+-15V, VCM=-15V versus total dose. The solid diamonds are the average of the measured data points for the samples irradiated under electrical bias while the shaded diamonds are the average of the measured data points for the samples irradiated with all pins tied to ground. The black lines (solid and/or dashed) are the upper and/or lower confidence limits, as determined by KTL statistics, on the samples irradiated under electrical bias while the gray lines (solid and/or dashed) are the upper and/or lower confidence limits, as determined by KTL statistics, on the samples irradiated in the unbiased condition. The red dotted line(s) are the pre- and/or post-irradiation minimum and/or maximum specification value as defined in the datasheet and/or test plan.



TID Report
15-0091 03/20/15 R1.0

Aeroflex RAD
5030 Centennial Blvd.
Colorado Springs, CO 80919
(719) 531-0800

Table 5.21. Raw data for Input Offset Current3_1 15V (A) @ VS=+/-15V, VCM=-15V versus total dose, including the statistical analysis, specification and the status of the testing (pass/fail).

Input Offset Current3_1 15V (A) @ VS=+/-15V, VCM=-15V	Total Dose (krad(Si))					24-hr Anneal	168-hr Anneal
	0	20	50	100	200		
Device							
680	2.86E-09	2.73E-09	1.85E-09	-2.54E-09	-7.00E-11	4.00E-10	2.24E-09
681	-4.98E-09	-5.37E-09	-5.87E-09	-5.48E-09	-5.26E-09	-7.27E-09	-4.71E-09
682	-6.70E-10	-9.00E-10	-1.22E-09	-2.61E-09	-3.70E-09	-3.81E-09	-1.46E-09
683	1.61E-09	2.22E-09	3.21E-09	4.62E-09	4.58E-09	1.39E-09	1.91E-09
684	-8.80E-10	-1.17E-09	-1.00E-10	-8.90E-10	-8.40E-10	-1.88E-09	-2.00E-10
685	-3.32E-09	-3.24E-09	-4.69E-09	-5.60E-09	-6.14E-09	-7.14E-09	-3.47E-09
686	-1.60E-09	-1.40E-09	-1.74E-09	-2.09E-09	-6.30E-10	-4.83E-09	-1.69E-09
688	-2.81E-09	-3.40E-09	-3.24E-09	-4.55E-09	-6.45E-09	-7.12E-09	-3.80E-09
689	3.82E-09	3.42E-09	4.07E-09	3.74E-09	2.38E-09	6.30E-10	3.93E-09
690	-2.96E-09	-3.70E-09	-3.33E-09	-1.25E-09	-8.60E-10	-5.18E-09	-4.10E-09
691	-2.01E-09	-2.08E-09	-2.16E-09	-2.28E-09	-2.39E-09	-2.40E-09	-2.47E-09
692	-6.87E-09	-6.89E-09	-7.00E-09	-7.07E-09	-7.10E-09	-7.17E-09	-7.15E-09
Biased Statistics							
Average Biased	-4.12E-10	-4.98E-10	-4.26E-10	-1.38E-09	-1.06E-09	-2.23E-09	-4.44E-10
Std Dev Biased	3.00E-09	3.25E-09	3.49E-09	3.74E-09	3.79E-09	3.47E-09	2.83E-09
Ps90%/90% (+KTL) Biased	7.81E-09	8.40E-09	9.15E-09	8.87E-09	9.33E-09	7.27E-09	7.32E-09
Ps90%/90% (-KTL) Biased	-8.63E-09	-9.40E-09	-1.00E-08	-1.16E-08	-1.14E-08	-1.17E-08	-8.20E-09
Un-Biased Statistics							
Average Un-Biased	-1.37E-09	-1.66E-09	-1.79E-09	-1.95E-09	-2.34E-09	-4.73E-09	-1.83E-09
Std Dev Un-Biased	2.97E-09	2.98E-09	3.44E-09	3.64E-09	3.83E-09	3.18E-09	3.35E-09
Ps90%/90% (+KTL) Un-Biased	6.78E-09	6.51E-09	7.64E-09	8.03E-09	8.17E-09	3.99E-09	7.36E-09
Ps90%/90% (-KTL) Un-Biased	-9.53E-09	-9.84E-09	-1.12E-08	-1.19E-08	-1.28E-08	-1.34E-08	-1.10E-08
Specification MIN	-7.00E-08	-1.00E-07	-1.00E-07	-1.00E-07	-1.00E-07	-1.00E-07	-1.00E-07
Status	PASS	PASS	PASS	PASS	PASS	PASS	PASS
Specification MAX	7.00E-08	1.00E-07	1.00E-07	1.00E-07	1.00E-07	1.00E-07	1.00E-07
Status	PASS	PASS	PASS	PASS	PASS	PASS	PASS

An ISO 9001:2008 and DLA Certified Company

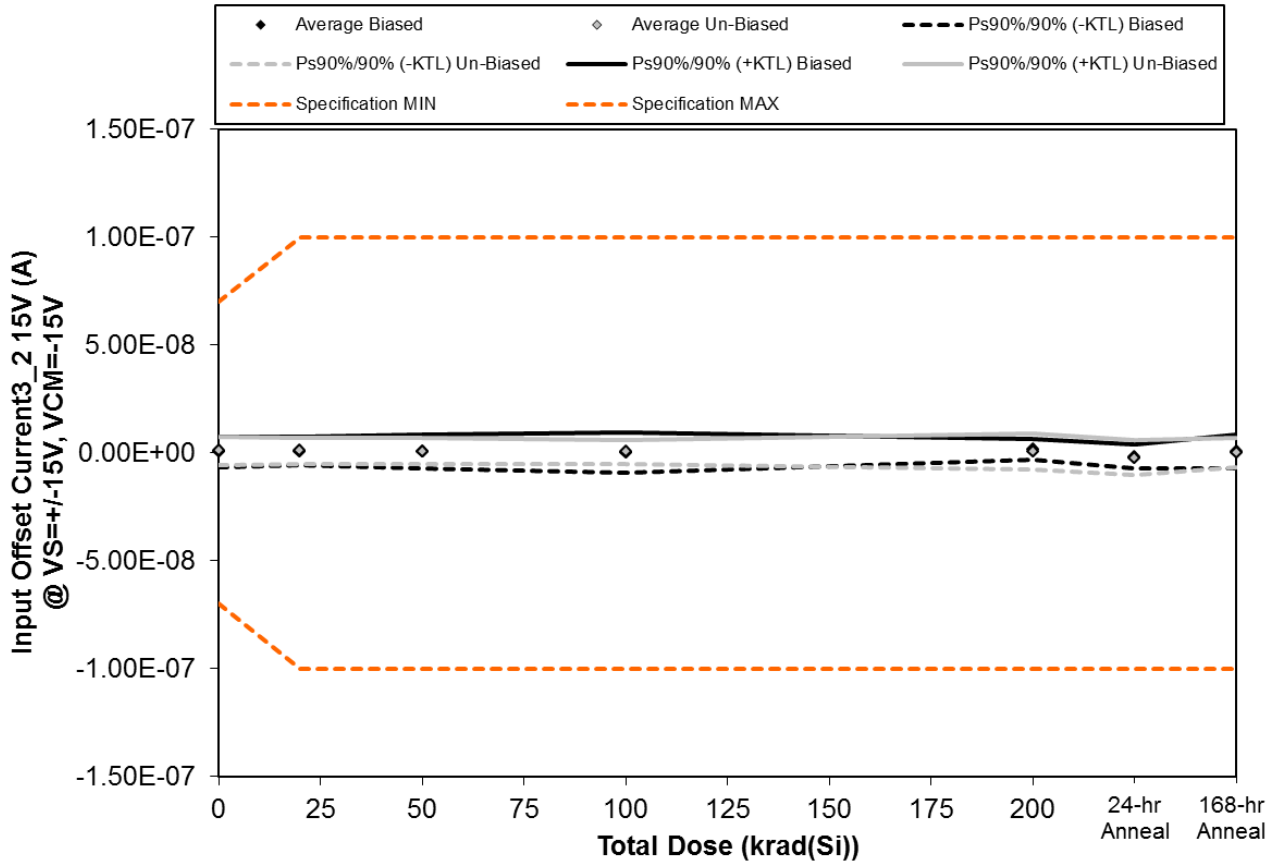

Figure 5.22. Plot of Input Offset Current3_2 15V (A) @ VS=+-15V, VCM=-15V versus total dose. The solid diamonds are the average of the measured data points for the samples irradiated under electrical bias while the shaded diamonds are the average of the measured data points for the samples irradiated with all pins tied to ground. The black lines (solid and/or dashed) are the upper and/or lower confidence limits, as determined by KTL statistics, on the samples irradiated under electrical bias while the gray lines (solid and/or dashed) are the upper and/or lower confidence limits, as determined by KTL statistics, on the samples irradiated in the unbiased condition. The red dotted line(s) are the pre- and/or post-irradiation minimum and/or maximum specification value as defined in the datasheet and/or test plan.



TID Report
15-0091 03/20/15 R1.0

Aeroflex RAD
5030 Centennial Blvd.
Colorado Springs, CO 80919
(719) 531-0800

Table 5.22. Raw data for Input Offset Current_{3_2} 15V (A) @ VS=+/-15V, VCM=-15V versus total dose, including the statistical analysis, specification and the status of the testing (pass/fail).

Input Offset Current _{3_2} 15V (A) @ VS=+/-15V, VCM=-15V	Total Dose (krad(Si))					24-hr Anneal	168-hr Anneal
	Device	0	20	50	100		
680	-5.50E-10	9.90E-10	7.40E-10	-3.74E-09	8.90E-10	-3.00E-09	-5.30E-10
681	5.10E-10	1.50E-10	-1.10E-09	-1.25E-09	6.70E-10	-2.87E-09	-1.02E-09
682	-8.70E-10	-7.90E-10	-8.10E-10	-9.00E-10	1.18E-09	-2.44E-09	-1.64E-09
683	-1.64E-09	-1.03E-09	-1.13E-09	2.60E-10	8.00E-10	-2.31E-09	4.00E-10
684	4.79E-09	4.84E-09	5.43E-09	5.41E-09	4.60E-09	1.78E-09	5.59E-09
685	4.16E-09	4.00E-09	2.97E-09	2.28E-09	3.09E-09	-5.10E-10	3.54E-09
686	-1.84E-09	-1.27E-09	-2.90E-10	-7.70E-10	-2.02E-09	-4.30E-09	-1.81E-09
688	1.38E-09	1.16E-09	1.85E-09	2.00E-09	2.19E-09	-6.70E-10	8.70E-10
689	1.91E-09	2.09E-09	2.20E-09	1.10E-09	3.13E-09	1.90E-10	1.60E-09
690	-9.00E-10	-1.20E-09	-2.47E-09	-2.41E-09	-3.24E-09	-6.62E-09	-2.51E-09
691	-4.81E-09	-4.89E-09	-5.00E-09	-5.05E-09	-5.12E-09	-5.19E-09	-5.28E-09
692	-1.51E-09	-1.57E-09	-1.66E-09	-1.69E-09	-1.75E-09	-1.73E-09	-1.77E-09
Biased Statistics							
Average Biased	4.48E-10	8.32E-10	6.26E-10	-4.40E-11	1.63E-09	-1.77E-09	5.60E-10
Std Dev Biased	2.55E-09	2.38E-09	2.79E-09	3.38E-09	1.67E-09	2.00E-09	2.91E-09
Ps90%/90% (+KTL) Biased	7.43E-09	7.36E-09	8.29E-09	9.22E-09	6.21E-09	3.73E-09	8.54E-09
Ps90%/90% (-KTL) Biased	-6.54E-09	-5.69E-09	-7.03E-09	-9.31E-09	-2.96E-09	-7.26E-09	-7.42E-09
Un-Biased Statistics							
Average Un-Biased	9.42E-10	9.56E-10	8.52E-10	4.40E-10	6.30E-10	-2.38E-09	3.38E-10
Std Dev Un-Biased	2.38E-09	2.25E-09	2.22E-09	1.99E-09	3.03E-09	2.94E-09	2.49E-09
Ps90%/90% (+KTL) Un-Biased	7.46E-09	7.12E-09	6.93E-09	5.90E-09	8.94E-09	5.69E-09	7.17E-09
Ps90%/90% (-KTL) Un-Biased	-5.58E-09	-5.21E-09	-5.22E-09	-5.02E-09	-7.68E-09	-1.05E-08	-6.50E-09
Specification MIN	-7.00E-08	-1.00E-07	-1.00E-07	-1.00E-07	-1.00E-07	-1.00E-07	-1.00E-07
Status	PASS	PASS	PASS	PASS	PASS	PASS	PASS
Specification MAX	7.00E-08	1.00E-07	1.00E-07	1.00E-07	1.00E-07	1.00E-07	1.00E-07
Status	PASS	PASS	PASS	PASS	PASS	PASS	PASS

An ISO 9001:2008 and DLA Certified Company

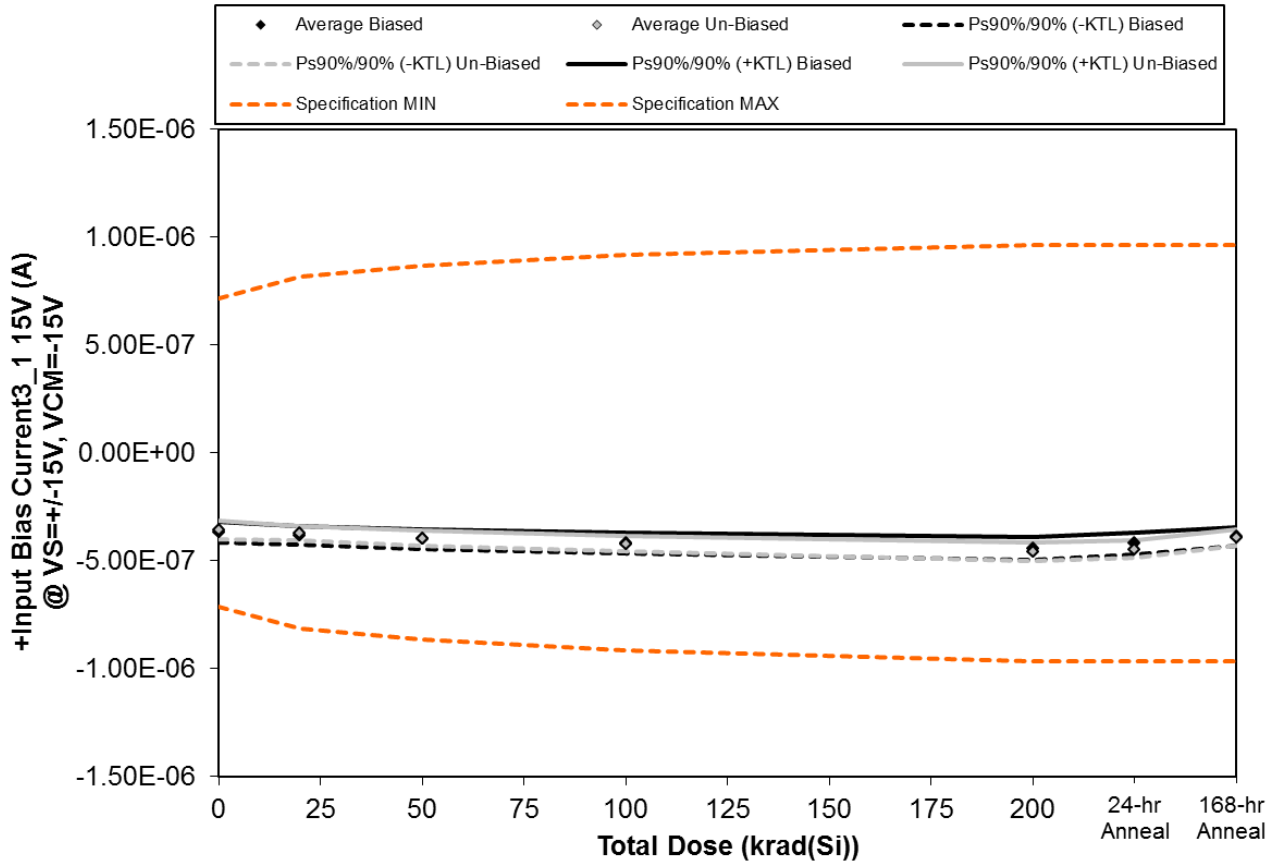

Figure 5.23. Plot of +Input Bias Current3_1 15V (A) @ VS=+-15V, VCM=-15V versus total dose. The solid diamonds are the average of the measured data points for the samples irradiated under electrical bias while the shaded diamonds are the average of the measured data points for the samples irradiated with all pins tied to ground. The black lines (solid and/or dashed) are the upper and/or lower confidence limits, as determined by KTL statistics, on the samples irradiated under electrical bias while the gray lines (solid and/or dashed) are the upper and/or lower confidence limits, as determined by KTL statistics, on the samples irradiated in the unbiased condition. The red dotted line(s) are the pre- and/or post-irradiation minimum and/or maximum specification value as defined in the datasheet and/or test plan.



TID Report
15-0091 03/20/15 R1.0

Aeroflex RAD
5030 Centennial Blvd.
Colorado Springs, CO 80919
(719) 531-0800

Table 5.23. Raw data for +Input Bias Current3_1 15V (A) @ VS=+/-15V, VCM=-15V versus total dose, including the statistical analysis, specification and the status of the testing (pass/fail).

+Input Bias Current3_1 15V (A) @ VS=+/-15V, VCM=-15V	Total Dose (krad(Si))					24-hr Anneal	168-hr Anneal
	0	20	50	100	200		
Device							
680	-3.72E-07	-3.84E-07	-3.99E-07	-4.15E-07	-4.39E-07	-4.17E-07	-3.87E-07
681	-3.66E-07	-3.79E-07	-3.97E-07	-4.15E-07	-4.41E-07	-4.17E-07	-3.83E-07
682	-3.89E-07	-4.04E-07	-4.21E-07	-4.42E-07	-4.71E-07	-4.44E-07	-4.08E-07
683	-3.41E-07	-3.60E-07	-3.76E-07	-3.95E-07	-4.16E-07	-3.94E-07	-3.63E-07
684	-3.72E-07	-3.86E-07	-4.05E-07	-4.25E-07	-4.50E-07	-4.27E-07	-3.91E-07
685	-3.53E-07	-3.68E-07	-3.91E-07	-4.14E-07	-4.49E-07	-4.38E-07	-3.83E-07
686	-3.68E-07	-3.86E-07	-4.05E-07	-4.26E-07	-4.62E-07	-4.52E-07	-4.00E-07
688	-3.62E-07	-3.82E-07	-4.03E-07	-4.33E-07	-4.78E-07	-4.61E-07	-3.99E-07
689	-3.32E-07	-3.56E-07	-3.77E-07	-4.03E-07	-4.39E-07	-4.26E-07	-3.71E-07
690	-3.69E-07	-3.79E-07	-4.08E-07	-4.31E-07	-4.70E-07	-4.58E-07	-4.05E-07
691	-3.68E-07	-3.67E-07	-3.68E-07	-3.67E-07	-3.69E-07	-3.69E-07	-3.67E-07
692	-3.65E-07	-3.67E-07	-3.65E-07	-3.64E-07	-3.65E-07	-3.66E-07	-3.65E-07
Biased Statistics							
Average Biased	-3.68E-07	-3.83E-07	-4.00E-07	-4.19E-07	-4.43E-07	-4.20E-07	-3.86E-07
Std Dev Biased	1.74E-08	1.59E-08	1.60E-08	1.73E-08	1.99E-08	1.82E-08	1.60E-08
Ps90%/90% (+KTL) Biased	-3.20E-07	-3.39E-07	-3.56E-07	-3.71E-07	-3.89E-07	-3.70E-07	-3.42E-07
Ps90%/90% (-KTL) Biased	-4.16E-07	-4.26E-07	-4.44E-07	-4.66E-07	-4.98E-07	-4.70E-07	-4.30E-07
Un-Biased Statistics							
Average Un-Biased	-3.57E-07	-3.74E-07	-3.97E-07	-4.21E-07	-4.60E-07	-4.47E-07	-3.92E-07
Std Dev Un-Biased	1.52E-08	1.20E-08	1.30E-08	1.25E-08	1.57E-08	1.49E-08	1.40E-08
Ps90%/90% (+KTL) Un-Biased	-3.15E-07	-3.41E-07	-3.61E-07	-3.87E-07	-4.17E-07	-4.06E-07	-3.53E-07
Ps90%/90% (-KTL) Un-Biased	-3.98E-07	-4.07E-07	-4.32E-07	-4.56E-07	-5.02E-07	-4.88E-07	-4.30E-07
Specification MIN	-7.15E-07	-8.15E-07	-8.65E-07	-9.15E-07	-9.65E-07	-9.65E-07	-9.65E-07
Status	PASS	PASS	PASS	PASS	PASS	PASS	PASS
Specification MAX	7.15E-07	8.15E-07	8.65E-07	9.15E-07	9.65E-07	9.65E-07	9.65E-07
Status	PASS	PASS	PASS	PASS	PASS	PASS	PASS

An ISO 9001:2008 and DLA Certified Company

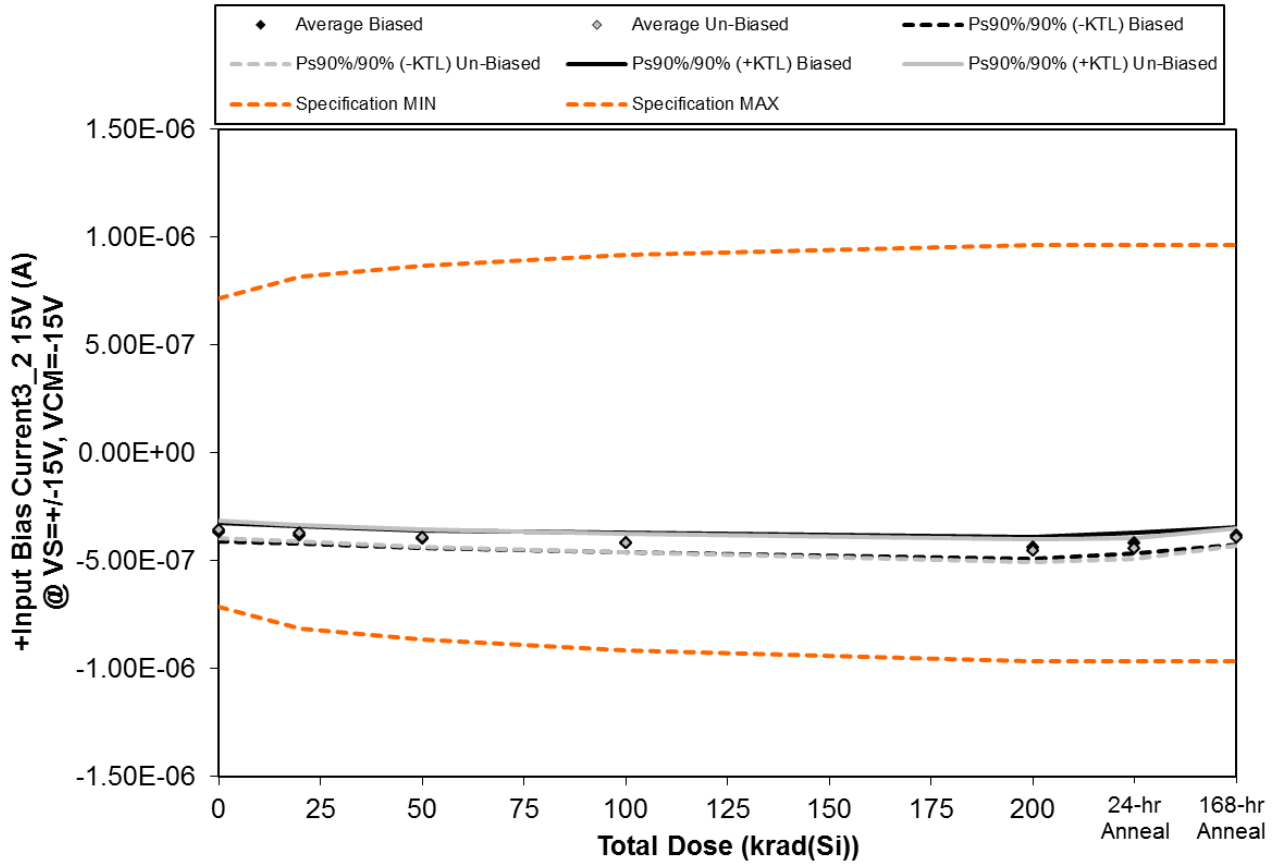

Figure 5.24. Plot of +Input Bias Current3_2 15V (A) @ VS=+-15V, VCM=-15V versus total dose. The solid diamonds are the average of the measured data points for the samples irradiated under electrical bias while the shaded diamonds are the average of the measured data points for the samples irradiated with all pins tied to ground. The black lines (solid and/or dashed) are the upper and/or lower confidence limits, as determined by KTL statistics, on the samples irradiated under electrical bias while the gray lines (solid and/or dashed) are the upper and/or lower confidence limits, as determined by KTL statistics, on the samples irradiated in the unbiased condition. The red dotted line(s) are the pre- and/or post-irradiation minimum and/or maximum specification value as defined in the datasheet and/or test plan.



TID Report
15-0091 03/20/15 R1.0

Aeroflex RAD
5030 Centennial Blvd.
Colorado Springs, CO 80919
(719) 531-0800

Table 5.24. Raw data for +Input Bias Current3_2 15V (A) @ VS=+/-15V, VCM=-15V versus total dose, including the statistical analysis, specification and the status of the testing (pass/fail).

+Input Bias Current3_2 15V (A) @ VS=+/-15V, VCM=-15V	Total Dose (krad(Si))					24-hr Anneal	168-hr Anneal
	0	20	50	100	200		
Device							
680	-3.71E-07	-3.83E-07	-4.00E-07	-4.16E-07	-4.40E-07	-4.18E-07	-3.87E-07
681	-3.64E-07	-3.79E-07	-3.96E-07	-4.13E-07	-4.38E-07	-4.16E-07	-3.82E-07
682	-3.91E-07	-4.04E-07	-4.21E-07	-4.41E-07	-4.67E-07	-4.43E-07	-4.08E-07
683	-3.49E-07	-3.62E-07	-3.79E-07	-3.95E-07	-4.15E-07	-3.96E-07	-3.64E-07
684	-3.64E-07	-3.79E-07	-3.97E-07	-4.14E-07	-4.38E-07	-4.18E-07	-3.83E-07
685	-3.46E-07	-3.62E-07	-3.82E-07	-4.03E-07	-4.35E-07	-4.26E-07	-3.77E-07
686	-3.69E-07	-3.87E-07	-4.05E-07	-4.30E-07	-4.63E-07	-4.52E-07	-3.99E-07
688	-3.66E-07	-3.84E-07	-4.05E-07	-4.34E-07	-4.75E-07	-4.60E-07	-4.03E-07
689	-3.35E-07	-3.57E-07	-3.76E-07	-4.01E-07	-4.33E-07	-4.23E-07	-3.73E-07
690	-3.65E-07	-3.74E-07	-4.05E-07	-4.27E-07	-4.65E-07	-4.54E-07	-3.99E-07
691	-3.71E-07	-3.70E-07	-3.72E-07	-3.71E-07	-3.73E-07	-3.73E-07	-3.72E-07
692	-3.56E-07	-3.56E-07	-3.56E-07	-3.57E-07	-3.57E-07	-3.57E-07	-3.58E-07
Biased Statistics							
Average Biased	-3.68E-07	-3.81E-07	-3.98E-07	-4.16E-07	-4.40E-07	-4.18E-07	-3.85E-07
Std Dev Biased	1.51E-08	1.51E-08	1.50E-08	1.63E-08	1.83E-08	1.68E-08	1.54E-08
Ps90%/90% (+KTL) Biased	-3.26E-07	-3.40E-07	-3.57E-07	-3.71E-07	-3.89E-07	-3.72E-07	-3.43E-07
Ps90%/90% (-KTL) Biased	-4.09E-07	-4.23E-07	-4.39E-07	-4.60E-07	-4.90E-07	-4.64E-07	-4.27E-07
Un-Biased Statistics							
Average Un-Biased	-3.56E-07	-3.73E-07	-3.95E-07	-4.19E-07	-4.54E-07	-4.43E-07	-3.90E-07
Std Dev Un-Biased	1.50E-08	1.31E-08	1.47E-08	1.55E-08	1.90E-08	1.71E-08	1.43E-08
Ps90%/90% (+KTL) Un-Biased	-3.15E-07	-3.37E-07	-3.54E-07	-3.76E-07	-4.02E-07	-3.96E-07	-3.51E-07
Ps90%/90% (-KTL) Un-Biased	-3.98E-07	-4.09E-07	-4.35E-07	-4.61E-07	-5.06E-07	-4.90E-07	-4.29E-07
Specification MIN	-7.15E-07	-8.15E-07	-8.65E-07	-9.15E-07	-9.65E-07	-9.65E-07	-9.65E-07
Status	PASS	PASS	PASS	PASS	PASS	PASS	PASS
Specification MAX	7.15E-07	8.15E-07	8.65E-07	9.15E-07	9.65E-07	9.65E-07	9.65E-07
Status	PASS	PASS	PASS	PASS	PASS	PASS	PASS

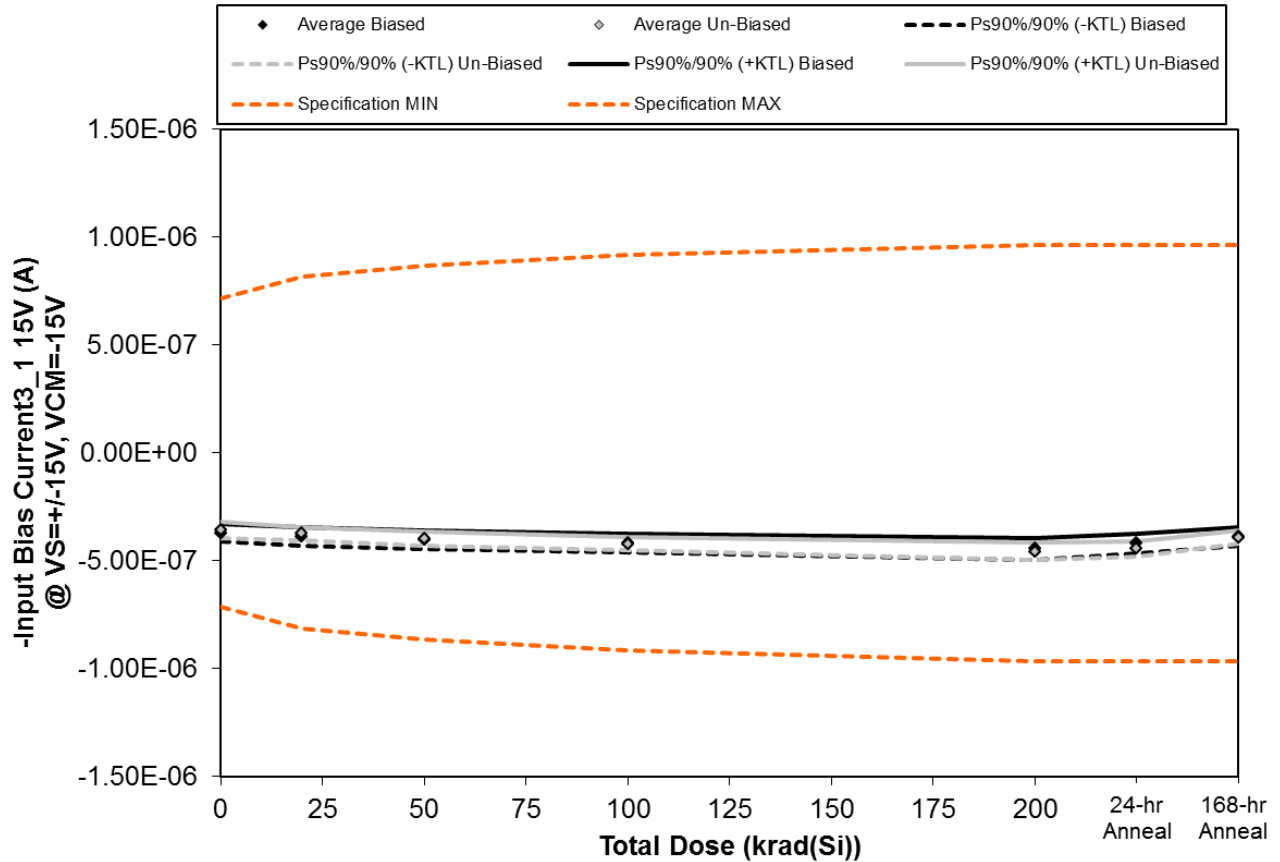

Figure 5.25. Plot of -Input Bias Current3_1 15V (A) @ VS=+-15V, VCM=-15V versus total dose. The solid diamonds are the average of the measured data points for the samples irradiated under electrical bias while the shaded diamonds are the average of the measured data points for the samples irradiated with all pins tied to ground. The black lines (solid and/or dashed) are the upper and/or lower confidence limits, as determined by KTL statistics, on the samples irradiated under electrical bias while the gray lines (solid and/or dashed) are the upper and/or lower confidence limits, as determined by KTL statistics, on the samples irradiated in the unbiased condition. The red dotted line(s) are the pre- and/or post-irradiation minimum and/or maximum specification value as defined in the datasheet and/or test plan.



TID Report
15-0091 03/20/15 R1.0

Aeroflex RAD
5030 Centennial Blvd.
Colorado Springs, CO 80919
(719) 531-0800

Table 5.25. Raw data for -Input Bias Current3_1 15V (A) @ VS=+/-15V, VCM=-15V versus total dose, including the statistical analysis, specification and the status of the testing (pass/fail).

-Input Bias Current3_1 15V (A) @ VS=+/-15V, VCM=-15V	Total Dose (krad(Si))					24-hr	168-hr
	0	20	50	100	200	Anneal	Anneal
Device							
680	-3.76E-07	-3.89E-07	-4.05E-07	-4.13E-07	-4.42E-07	-4.19E-07	-3.92E-07
681	-3.63E-07	-3.77E-07	-3.94E-07	-4.12E-07	-4.37E-07	-4.12E-07	-3.80E-07
682	-3.90E-07	-4.07E-07	-4.23E-07	-4.41E-07	-4.70E-07	-4.43E-07	-4.07E-07
683	-3.49E-07	-3.65E-07	-3.82E-07	-4.01E-07	-4.22E-07	-3.98E-07	-3.65E-07
684	-3.72E-07	-3.89E-07	-4.09E-07	-4.27E-07	-4.53E-07	-4.27E-07	-3.91E-07
685	-3.51E-07	-3.67E-07	-3.88E-07	-4.10E-07	-4.44E-07	-4.32E-07	-3.81E-07
686	-3.68E-07	-3.85E-07	-4.07E-07	-4.26E-07	-4.65E-07	-4.49E-07	-3.99E-07
688	-3.61E-07	-3.81E-07	-4.03E-07	-4.30E-07	-4.71E-07	-4.56E-07	-3.99E-07
689	-3.37E-07	-3.60E-07	-3.82E-07	-4.07E-07	-4.40E-07	-4.29E-07	-3.77E-07
690	-3.69E-07	-3.79E-07	-4.07E-07	-4.30E-07	-4.69E-07	-4.55E-07	-4.01E-07
691	-3.68E-07	-3.68E-07	-3.68E-07	-3.68E-07	-3.67E-07	-3.68E-07	-3.68E-07
692	-3.59E-07	-3.60E-07	-3.61E-07	-3.61E-07	-3.60E-07	-3.61E-07	-3.59E-07
Biased Statistics							
Average Biased	-3.70E-07	-3.86E-07	-4.02E-07	-4.19E-07	-4.45E-07	-4.20E-07	-3.87E-07
Std Dev Biased	1.53E-08	1.57E-08	1.55E-08	1.55E-08	1.78E-08	1.67E-08	1.57E-08
Ps90%/90% (+KTL) Biased	-3.28E-07	-3.42E-07	-3.60E-07	-3.77E-07	-3.96E-07	-3.74E-07	-3.44E-07
Ps90%/90% (-KTL) Biased	-4.12E-07	-4.29E-07	-4.45E-07	-4.61E-07	-4.94E-07	-4.65E-07	-4.30E-07
Un-Biased Statistics							
Average Un-Biased	-3.57E-07	-3.75E-07	-3.97E-07	-4.21E-07	-4.58E-07	-4.44E-07	-3.91E-07
Std Dev Un-Biased	1.36E-08	1.04E-08	1.14E-08	1.14E-08	1.47E-08	1.28E-08	1.15E-08
Ps90%/90% (+KTL) Un-Biased	-3.20E-07	-3.46E-07	-3.66E-07	-3.89E-07	-4.18E-07	-4.09E-07	-3.60E-07
Ps90%/90% (-KTL) Un-Biased	-3.95E-07	-4.03E-07	-4.29E-07	-4.52E-07	-4.98E-07	-4.79E-07	-4.23E-07
Specification MIN	-7.15E-07	-8.15E-07	-8.65E-07	-9.15E-07	-9.65E-07	-9.65E-07	-9.65E-07
Status	PASS	PASS	PASS	PASS	PASS	PASS	PASS
Specification MAX	7.15E-07	8.15E-07	8.65E-07	9.15E-07	9.65E-07	9.65E-07	9.65E-07
Status	PASS	PASS	PASS	PASS	PASS	PASS	PASS

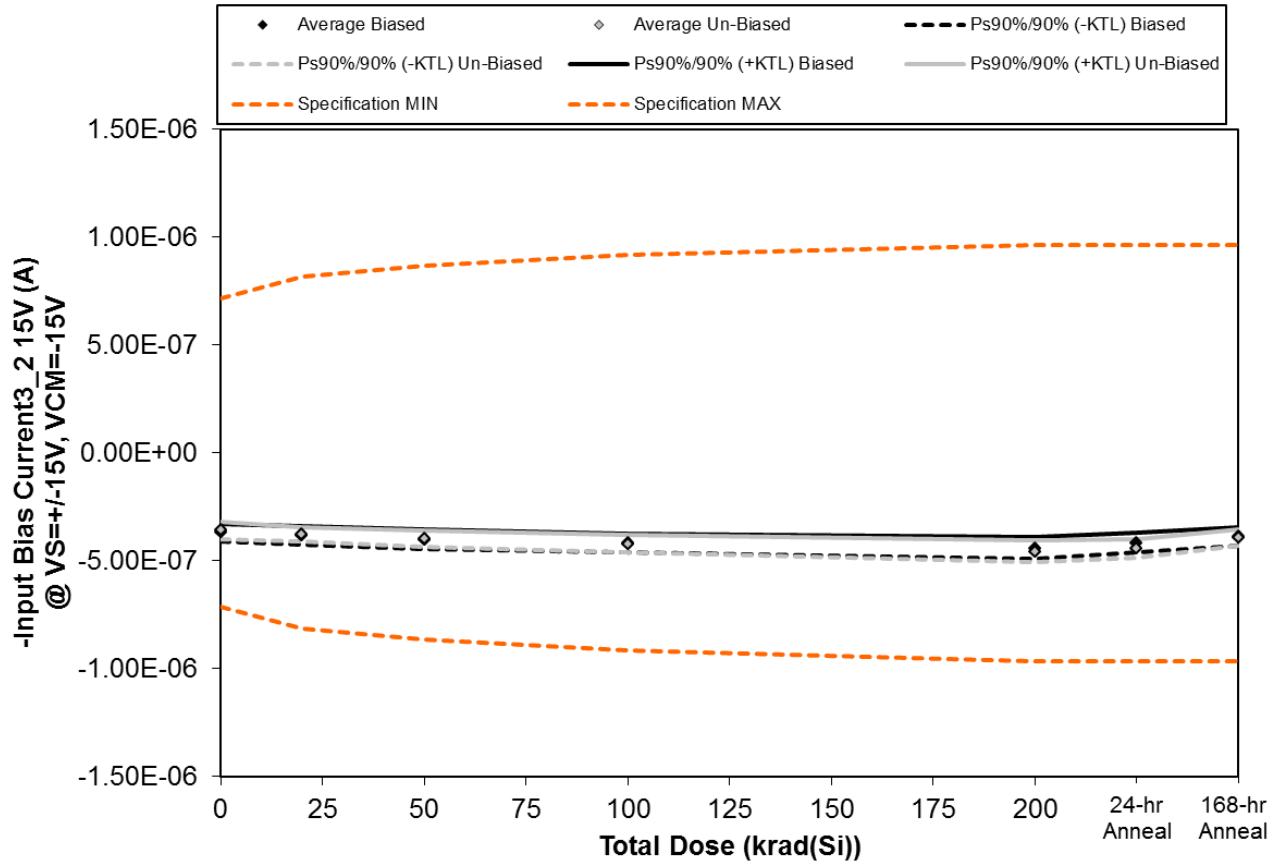

Figure 5.26. Plot of -Input Bias Current3_2 15V (A) @ VS=+-15V, VCM=-15V versus total dose. The solid diamonds are the average of the measured data points for the samples irradiated under electrical bias while the shaded diamonds are the average of the measured data points for the samples irradiated with all pins tied to ground. The black lines (solid and/or dashed) are the upper and/or lower confidence limits, as determined by KTL statistics, on the samples irradiated under electrical bias while the gray lines (solid and/or dashed) are the upper and/or lower confidence limits, as determined by KTL statistics, on the samples irradiated in the unbiased condition. The red dotted line(s) are the pre- and/or post-irradiation minimum and/or maximum specification value as defined in the datasheet and/or test plan.



TID Report
15-0091 03/20/15 R1.0

Aeroflex RAD
5030 Centennial Blvd.
Colorado Springs, CO 80919
(719) 531-0800

Table 5.26. Raw data for -Input Bias Current_{3_2} 15V (A) @ VS=+/-15V, VCM=-15V versus total dose, including the statistical analysis, specification and the status of the testing (pass/fail).

-Input Bias Current _{3_2} 15V (A) @ VS=+/-15V, VCM=-15V	Total Dose (krad(Si))					24-hr	168-hr
	0	20	50	100	200	Anneal	Anneal
Device							
680	-3.71E-07	-3.86E-07	-4.04E-07	-4.14E-07	-4.42E-07	-4.17E-07	-3.89E-07
681	-3.64E-07	-3.81E-07	-3.97E-07	-4.14E-07	-4.39E-07	-4.13E-07	-3.83E-07
682	-3.91E-07	-4.06E-07	-4.23E-07	-4.40E-07	-4.70E-07	-4.41E-07	-4.08E-07
683	-3.48E-07	-3.63E-07	-3.78E-07	-3.97E-07	-4.18E-07	-3.95E-07	-3.66E-07
684	-3.71E-07	-3.86E-07	-4.03E-07	-4.21E-07	-4.45E-07	-4.21E-07	-3.90E-07
685	-3.52E-07	-3.69E-07	-3.86E-07	-4.08E-07	-4.38E-07	-4.27E-07	-3.82E-07
686	-3.70E-07	-3.88E-07	-4.09E-07	-4.30E-07	-4.66E-07	-4.50E-07	-4.00E-07
688	-3.70E-07	-3.87E-07	-4.11E-07	-4.38E-07	-4.79E-07	-4.62E-07	-4.06E-07
689	-3.37E-07	-3.60E-07	-3.80E-07	-4.01E-07	-4.35E-07	-4.25E-07	-3.76E-07
690	-3.66E-07	-3.76E-07	-4.03E-07	-4.26E-07	-4.63E-07	-4.51E-07	-3.99E-07
691	-3.69E-07	-3.68E-07	-3.68E-07	-3.67E-07	-3.68E-07	-3.68E-07	-3.68E-07
692	-3.57E-07	-3.57E-07	-3.57E-07	-3.57E-07	-3.58E-07	-3.57E-07	-3.56E-07
Biased Statistics							
Average Biased	-3.69E-07	-3.85E-07	-4.01E-07	-4.17E-07	-4.43E-07	-4.18E-07	-3.87E-07
Std Dev Biased	1.52E-08	1.56E-08	1.60E-08	1.57E-08	1.84E-08	1.66E-08	1.51E-08
Ps90%/90% (+KTL) Biased	-3.27E-07	-3.42E-07	-3.57E-07	-3.74E-07	-3.92E-07	-3.72E-07	-3.46E-07
Ps90%/90% (-KTL) Biased	-4.11E-07	-4.27E-07	-4.45E-07	-4.60E-07	-4.93E-07	-4.63E-07	-4.29E-07
Un-Biased Statistics							
Average Un-Biased	-3.59E-07	-3.76E-07	-3.98E-07	-4.21E-07	-4.56E-07	-4.43E-07	-3.92E-07
Std Dev Un-Biased	1.41E-08	1.19E-08	1.39E-08	1.53E-08	1.88E-08	1.61E-08	1.30E-08
Ps90%/90% (+KTL) Un-Biased	-3.20E-07	-3.43E-07	-3.60E-07	-3.79E-07	-4.05E-07	-3.99E-07	-3.57E-07
Ps90%/90% (-KTL) Un-Biased	-3.98E-07	-4.09E-07	-4.36E-07	-4.62E-07	-5.08E-07	-4.87E-07	-4.28E-07
Specification MIN	-7.15E-07	-8.15E-07	-8.65E-07	-9.15E-07	-9.65E-07	-9.65E-07	-9.65E-07
Status	PASS	PASS	PASS	PASS	PASS	PASS	PASS
Specification MAX	7.15E-07	8.15E-07	8.65E-07	9.15E-07	9.65E-07	9.65E-07	9.65E-07
Status	PASS	PASS	PASS	PASS	PASS	PASS	PASS

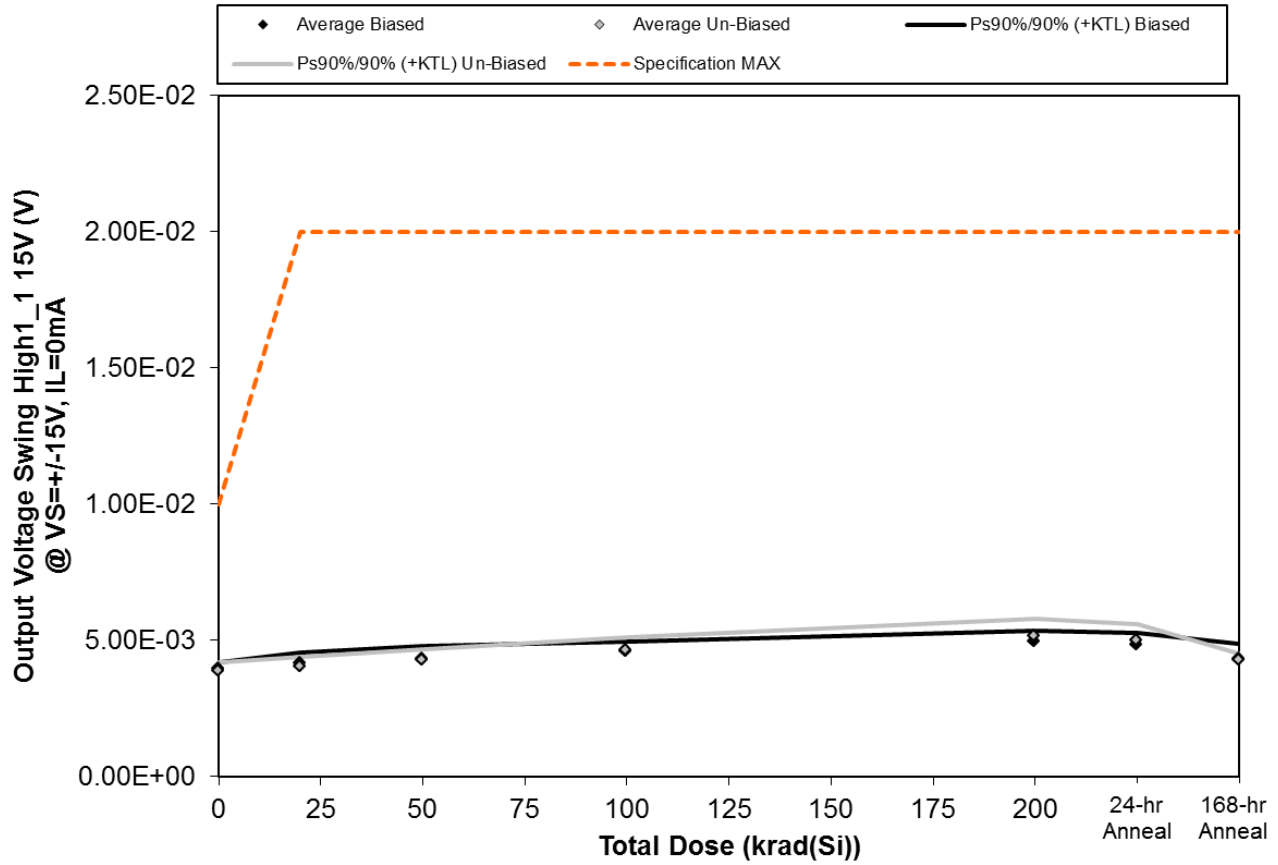

Figure 5.27. Plot of Output Voltage Swing High1_1 15V (V) @ VS=+-15V, IL=0mA versus total dose. The solid diamonds are the average of the measured data points for the samples irradiated under electrical bias while the shaded diamonds are the average of the measured data points for the samples irradiated with all pins tied to ground. The black lines (solid and/or dashed) are the upper and/or lower confidence limits, as determined by KTL statistics, on the samples irradiated under electrical bias while the gray lines (solid and/or dashed) are the upper and/or lower confidence limits, as determined by KTL statistics, on the samples irradiated in the unbiased condition. The red dotted line(s) are the pre- and/or post-irradiation minimum and/or maximum specification value as defined in the datasheet and/or test plan.



TID Report
15-0091 03/20/15 R1.0

Aeroflex RAD
5030 Centennial Blvd.
Colorado Springs, CO 80919
(719) 531-0800

Table 5.27. Raw data for Output Voltage Swing High1_1 15V (V) @ VS=+/-15V, IL=0mA versus total dose, including the statistical analysis, specification and the status of the testing (pass/fail).

Output Voltage Swing High1_1 15V (V) @ VS=+/-15V, IL=0mA	Total Dose (krad(Si))					24-hr Anneal	168-hr Anneal
	0	20	50	100	200		
Device							
680	3.99E-03	4.09E-03	4.37E-03	4.62E-03	5.10E-03	4.90E-03	4.35E-03
681	4.06E-03	4.37E-03	4.48E-03	4.69E-03	5.03E-03	4.88E-03	4.49E-03
682	3.87E-03	4.03E-03	4.10E-03	4.45E-03	4.81E-03	4.64E-03	4.19E-03
683	4.03E-03	4.26E-03	4.50E-03	4.77E-03	5.11E-03	5.06E-03	4.59E-03
684	3.91E-03	4.03E-03	4.24E-03	4.52E-03	4.89E-03	4.71E-03	4.15E-03
685	3.92E-03	4.08E-03	4.39E-03	4.76E-03	5.16E-03	5.05E-03	4.36E-03
686	3.95E-03	4.05E-03	4.33E-03	4.63E-03	5.29E-03	5.03E-03	4.34E-03
688	3.69E-03	3.89E-03	4.05E-03	4.37E-03	4.87E-03	4.73E-03	4.16E-03
689	3.89E-03	4.03E-03	4.21E-03	4.63E-03	5.11E-03	4.99E-03	4.32E-03
690	3.96E-03	4.22E-03	4.41E-03	4.83E-03	5.48E-03	5.31E-03	4.35E-03
691	3.82E-03	3.76E-03	3.80E-03	3.76E-03	3.82E-03	3.87E-03	3.89E-03
692	4.07E-03	4.16E-03	4.16E-03	4.11E-03	4.18E-03	4.23E-03	4.16E-03
Biased Statistics							
Average Biased	3.97E-03	4.16E-03	4.34E-03	4.61E-03	4.99E-03	4.84E-03	4.35E-03
Std Dev Biased	8.01E-05	1.52E-04	1.69E-04	1.28E-04	1.33E-04	1.66E-04	1.89E-04
Ps90%/90% (+KTL) Biased	4.19E-03	4.57E-03	4.80E-03	4.96E-03	5.35E-03	5.29E-03	4.87E-03
Ps90%/90% (-KTL) Biased	3.75E-03	3.74E-03	3.88E-03	4.26E-03	4.62E-03	4.38E-03	3.84E-03
Un-Biased Statistics							
Average Un-Biased	3.88E-03	4.05E-03	4.28E-03	4.64E-03	5.18E-03	5.02E-03	4.31E-03
Std Dev Un-Biased	1.11E-04	1.18E-04	1.49E-04	1.76E-04	2.26E-04	2.06E-04	8.29E-05
Ps90%/90% (+KTL) Un-Biased	4.19E-03	4.38E-03	4.69E-03	5.13E-03	5.80E-03	5.59E-03	4.53E-03
Ps90%/90% (-KTL) Un-Biased	3.58E-03	3.73E-03	3.87E-03	4.16E-03	4.56E-03	4.46E-03	4.08E-03
Specification MAX	1.00E-02	2.00E-02	2.00E-02	2.00E-02	2.00E-02	2.00E-02	2.00E-02
Status	PASS	PASS	PASS	PASS	PASS	PASS	PASS

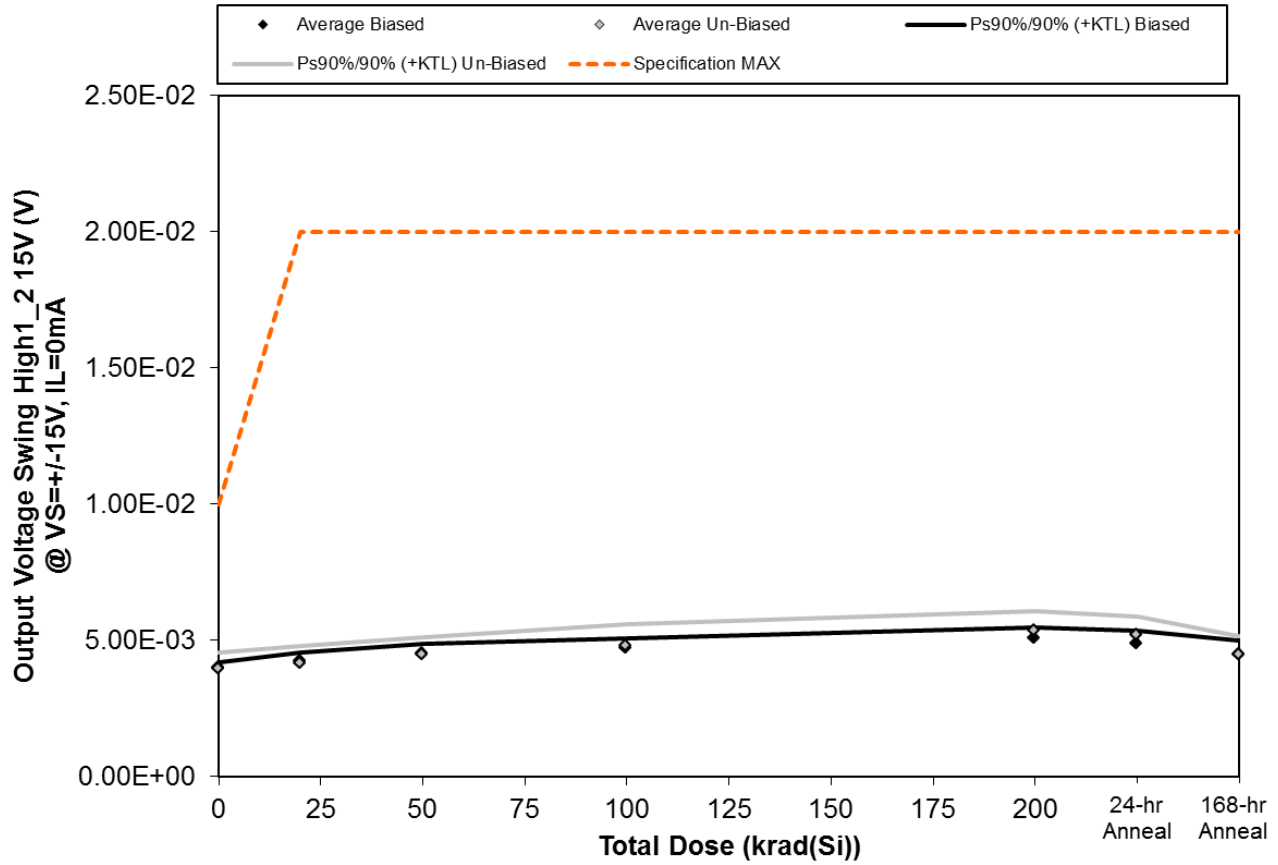

Figure 5.28. Plot of Output Voltage Swing High1_2 15V (V) @ VS=+-15V, IL=0mA versus total dose. The solid diamonds are the average of the measured data points for the samples irradiated under electrical bias while the shaded diamonds are the average of the measured data points for the samples irradiated with all pins tied to ground. The black lines (solid and/or dashed) are the upper and/or lower confidence limits, as determined by KTL statistics, on the samples irradiated under electrical bias while the gray lines (solid and/or dashed) are the upper and/or lower confidence limits, as determined by KTL statistics, on the samples irradiated in the unbiased condition. The red dotted line(s) are the pre- and/or post-irradiation minimum and/or maximum specification value as defined in the datasheet and/or test plan.



TID Report
15-0091 03/20/15 R1.0

Aeroflex RAD
5030 Centennial Blvd.
Colorado Springs, CO 80919
(719) 531-0800

Table 5.28. Raw data for Output Voltage Swing High1_2 15V (V) @ VS=+/-15V, IL=0mA versus total dose, including the statistical analysis, specification and the status of the testing (pass/fail).

Output Voltage Swing High1_2 15V (V) @ VS=+/-15V, IL=0mA	Total Dose (krad(Si))					24-hr Anneal	168-hr Anneal
	0	20	50	100	200		
Device							
680	4.00E-03	4.31E-03	4.46E-03	4.75E-03	5.13E-03	4.94E-03	4.43E-03
681	4.10E-03	4.34E-03	4.58E-03	4.77E-03	5.13E-03	5.00E-03	4.61E-03
682	3.90E-03	4.11E-03	4.37E-03	4.61E-03	4.89E-03	4.64E-03	4.30E-03
683	4.04E-03	4.36E-03	4.72E-03	4.93E-03	5.26E-03	5.07E-03	4.75E-03
684	3.97E-03	4.18E-03	4.53E-03	4.68E-03	5.06E-03	4.84E-03	4.46E-03
685	4.33E-03	4.50E-03	4.80E-03	5.20E-03	5.62E-03	5.52E-03	4.83E-03
686	3.87E-03	4.10E-03	4.50E-03	4.93E-03	5.34E-03	5.23E-03	4.46E-03
688	3.75E-03	3.89E-03	4.15E-03	4.43E-03	5.05E-03	4.90E-03	4.15E-03
689	3.95E-03	4.15E-03	4.46E-03	4.71E-03	5.20E-03	5.04E-03	4.37E-03
690	3.97E-03	4.27E-03	4.50E-03	4.87E-03	5.62E-03	5.33E-03	4.59E-03
691	3.91E-03	3.97E-03	3.96E-03	3.99E-03	3.94E-03	4.00E-03	4.01E-03
692	4.08E-03	4.13E-03	4.13E-03	4.21E-03	4.22E-03	4.24E-03	4.15E-03
Biased Statistics							
Average Biased	4.00E-03	4.26E-03	4.53E-03	4.75E-03	5.09E-03	4.90E-03	4.51E-03
Std Dev Biased	7.50E-05	1.09E-04	1.31E-04	1.20E-04	1.35E-04	1.67E-04	1.74E-04
Ps90%/90% (+KTL) Biased	4.21E-03	4.56E-03	4.89E-03	5.08E-03	5.46E-03	5.36E-03	4.99E-03
Ps90%/90% (-KTL) Biased	3.80E-03	3.96E-03	4.17E-03	4.42E-03	4.72E-03	4.44E-03	4.03E-03
Un-Biased Statistics							
Average Un-Biased	3.97E-03	4.18E-03	4.48E-03	4.83E-03	5.37E-03	5.20E-03	4.48E-03
Std Dev Un-Biased	2.17E-04	2.25E-04	2.30E-04	2.84E-04	2.54E-04	2.43E-04	2.53E-04
Ps90%/90% (+KTL) Un-Biased	4.57E-03	4.80E-03	5.11E-03	5.61E-03	6.06E-03	5.87E-03	5.17E-03
Ps90%/90% (-KTL) Un-Biased	3.38E-03	3.57E-03	3.85E-03	4.05E-03	4.67E-03	4.54E-03	3.79E-03
Specification MAX	1.00E-02	2.00E-02	2.00E-02	2.00E-02	2.00E-02	2.00E-02	2.00E-02
Status	PASS	PASS	PASS	PASS	PASS	PASS	PASS

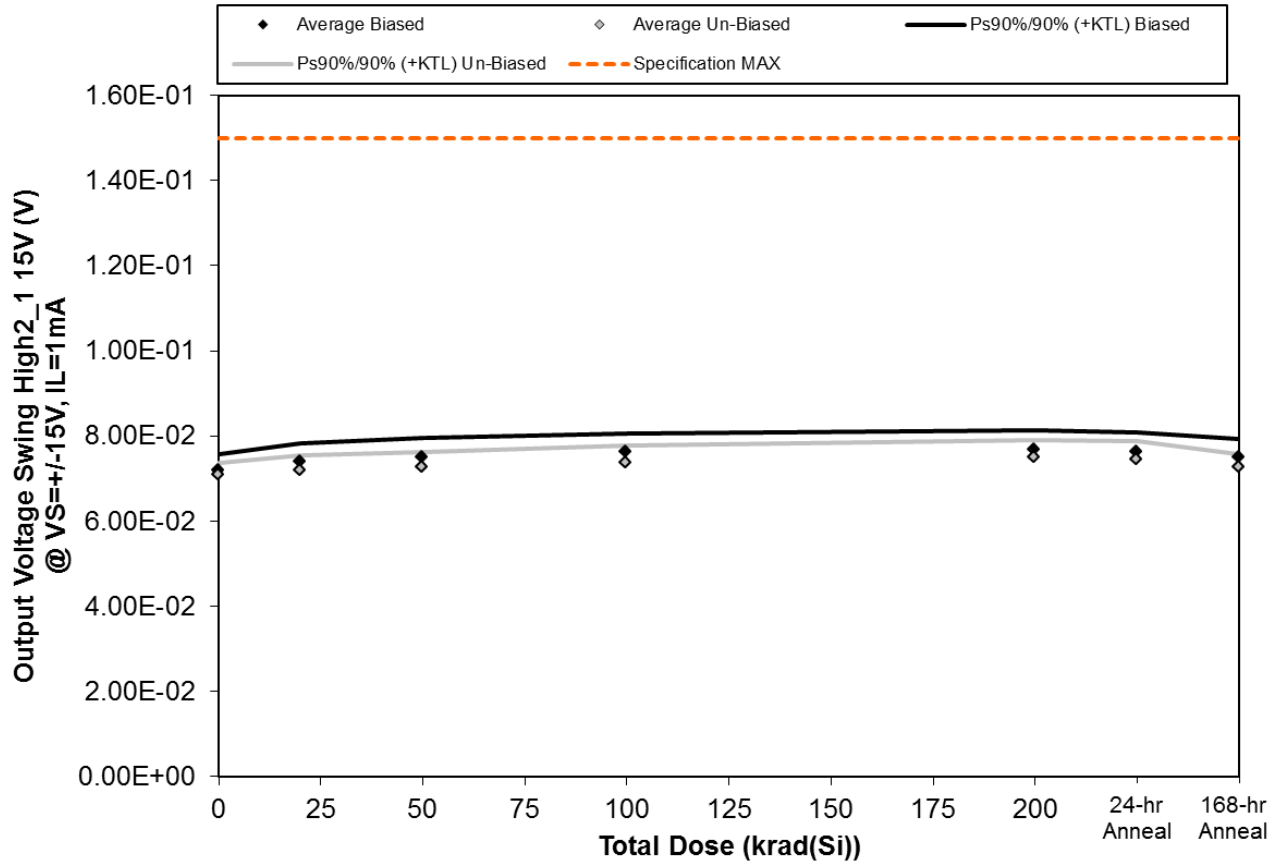

Figure 5.29. Plot of Output Voltage Swing High2_1 15V (V) @ VS=+-15V, IL=1mA versus total dose. The solid diamonds are the average of the measured data points for the samples irradiated under electrical bias while the shaded diamonds are the average of the measured data points for the samples irradiated with all pins tied to ground. The black lines (solid and/or dashed) are the upper and/or lower confidence limits, as determined by KTL statistics, on the samples irradiated under electrical bias while the gray lines (solid and/or dashed) are the upper and/or lower confidence limits, as determined by KTL statistics, on the samples irradiated in the unbiased condition. The red dotted line(s) are the pre- and/or post-irradiation minimum and/or maximum specification value as defined in the datasheet and/or test plan.



TID Report
15-0091 03/20/15 R1.0

Aeroflex RAD
5030 Centennial Blvd.
Colorado Springs, CO 80919
(719) 531-0800

Table 5.29. Raw data for Output Voltage Swing High2_1 15V (V) @ VS=+/-15V, IL=1mA versus total dose, including the statistical analysis, specification and the status of the testing (pass/fail).

Output Voltage Swing High2_1 15V (V) @ VS=+/-15V, IL=1mA	Total Dose (krad(Si))					24-hr Anneal	168-hr Anneal
	0	20	50	100	200		
Device							
680	7.14E-02	7.36E-02	7.48E-02	7.65E-02	7.68E-02	7.63E-02	7.46E-02
681	7.28E-02	7.52E-02	7.63E-02	7.72E-02	7.77E-02	7.75E-02	7.61E-02
682	7.02E-02	7.22E-02	7.31E-02	7.42E-02	7.47E-02	7.43E-02	7.30E-02
683	7.38E-02	7.60E-02	7.71E-02	7.81E-02	7.90E-02	7.84E-02	7.70E-02
684	7.14E-02	7.35E-02	7.46E-02	7.55E-02	7.62E-02	7.55E-02	7.43E-02
685	7.11E-02	7.21E-02	7.29E-02	7.39E-02	7.52E-02	7.47E-02	7.29E-02
686	7.07E-02	7.17E-02	7.26E-02	7.35E-02	7.52E-02	7.47E-02	7.25E-02
688	6.97E-02	7.06E-02	7.11E-02	7.17E-02	7.30E-02	7.25E-02	7.14E-02
689	7.14E-02	7.21E-02	7.30E-02	7.40E-02	7.52E-02	7.49E-02	7.31E-02
690	7.24E-02	7.40E-02	7.45E-02	7.57E-02	7.70E-02	7.67E-02	7.44E-02
691	6.84E-02	6.84E-02	6.83E-02	6.83E-02	6.84E-02	6.84E-02	6.84E-02
692	7.24E-02	7.22E-02	7.25E-02	7.26E-02	7.25E-02	7.24E-02	7.23E-02
Biased Statistics							
Average Biased	7.19E-02	7.41E-02	7.52E-02	7.63E-02	7.69E-02	7.64E-02	7.50E-02
Std Dev Biased	1.41E-03	1.50E-03	1.56E-03	1.53E-03	1.60E-03	1.63E-03	1.57E-03
Ps90%/90% (+KTL) Biased	7.58E-02	7.82E-02	7.95E-02	8.05E-02	8.13E-02	8.09E-02	7.93E-02
Ps90%/90% (-KTL) Biased	6.80E-02	7.00E-02	7.09E-02	7.21E-02	7.25E-02	7.19E-02	7.07E-02
Un-Biased Statistics							
Average Un-Biased	7.10E-02	7.21E-02	7.28E-02	7.38E-02	7.51E-02	7.47E-02	7.28E-02
Std Dev Un-Biased	9.91E-04	1.23E-03	1.23E-03	1.42E-03	1.42E-03	1.47E-03	1.10E-03
Ps90%/90% (+KTL) Un-Biased	7.38E-02	7.54E-02	7.62E-02	7.77E-02	7.90E-02	7.87E-02	7.58E-02
Ps90%/90% (-KTL) Un-Biased	6.83E-02	6.87E-02	6.94E-02	6.99E-02	7.12E-02	7.07E-02	6.98E-02
Specification MAX	1.50E-01	1.50E-01	1.50E-01	1.50E-01	1.50E-01	1.50E-01	1.50E-01
Status	PASS	PASS	PASS	PASS	PASS	PASS	PASS

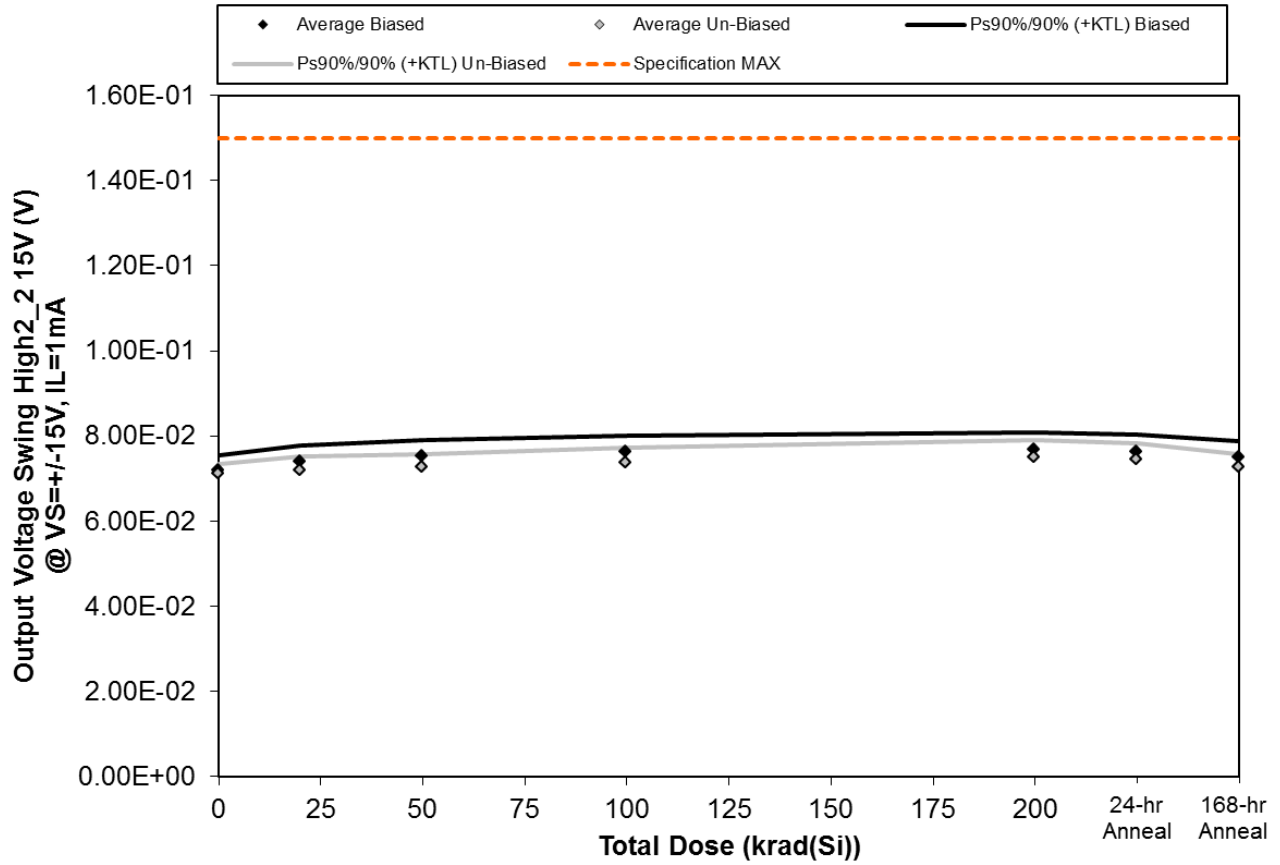

Figure 5.30. Plot of Output Voltage Swing High2_2 15V (V) @ VS=+-15V, IL=1mA versus total dose. The solid diamonds are the average of the measured data points for the samples irradiated under electrical bias while the shaded diamonds are the average of the measured data points for the samples irradiated with all pins tied to ground. The black lines (solid and/or dashed) are the upper and/or lower confidence limits, as determined by KTL statistics, on the samples irradiated under electrical bias while the gray lines (solid and/or dashed) are the upper and/or lower confidence limits, as determined by KTL statistics, on the samples irradiated in the unbiased condition. The red dotted line(s) are the pre- and/or post-irradiation minimum and/or maximum specification value as defined in the datasheet and/or test plan.



TID Report
15-0091 03/20/15 R1.0

Aeroflex RAD
5030 Centennial Blvd.
Colorado Springs, CO 80919
(719) 531-0800

Table 5.30. Raw data for Output Voltage Swing High2_2 15V (V) @ VS=+/-15V, IL=1mA versus total dose, including the statistical analysis, specification and the status of the testing (pass/fail).

Output Voltage Swing High2_2 15V (V) @ VS=+/-15V, IL=1mA	Total Dose (krad(Si))					24-hr Anneal	168-hr Anneal
	0	20	50	100	200		
Device							
680	7.17E-02	7.38E-02	7.50E-02	7.67E-02	7.70E-02	7.63E-02	7.47E-02
681	7.27E-02	7.49E-02	7.58E-02	7.68E-02	7.74E-02	7.71E-02	7.58E-02
682	7.05E-02	7.24E-02	7.34E-02	7.41E-02	7.48E-02	7.45E-02	7.30E-02
683	7.37E-02	7.58E-02	7.70E-02	7.79E-02	7.87E-02	7.83E-02	7.67E-02
684	7.19E-02	7.40E-02	7.50E-02	7.58E-02	7.65E-02	7.59E-02	7.46E-02
685	7.12E-02	7.19E-02	7.26E-02	7.37E-02	7.50E-02	7.43E-02	7.28E-02
686	7.11E-02	7.19E-02	7.28E-02	7.37E-02	7.52E-02	7.47E-02	7.28E-02
688	6.99E-02	7.05E-02	7.12E-02	7.19E-02	7.28E-02	7.27E-02	7.14E-02
689	7.12E-02	7.20E-02	7.27E-02	7.38E-02	7.48E-02	7.48E-02	7.29E-02
690	7.24E-02	7.39E-02	7.44E-02	7.56E-02	7.70E-02	7.65E-02	7.44E-02
691	6.88E-02	6.89E-02	6.88E-02	6.88E-02	6.88E-02	6.90E-02	6.89E-02
692	7.24E-02	7.22E-02	7.21E-02	7.21E-02	7.22E-02	7.20E-02	7.21E-02
Biased Statistics							
Average Biased	7.21E-02	7.42E-02	7.52E-02	7.62E-02	7.69E-02	7.64E-02	7.50E-02
Std Dev Biased	1.21E-03	1.30E-03	1.34E-03	1.44E-03	1.43E-03	1.42E-03	1.37E-03
Ps90%/90% (+KTL) Biased	7.54E-02	7.77E-02	7.89E-02	8.02E-02	8.08E-02	8.03E-02	7.87E-02
Ps90%/90% (-KTL) Biased	6.88E-02	7.06E-02	7.16E-02	7.23E-02	7.29E-02	7.25E-02	7.12E-02
Un-Biased Statistics							
Average Un-Biased	7.11E-02	7.20E-02	7.27E-02	7.37E-02	7.50E-02	7.46E-02	7.29E-02
Std Dev Un-Biased	8.64E-04	1.19E-03	1.12E-03	1.31E-03	1.48E-03	1.33E-03	1.07E-03
Ps90%/90% (+KTL) Un-Biased	7.35E-02	7.53E-02	7.58E-02	7.73E-02	7.90E-02	7.82E-02	7.58E-02
Ps90%/90% (-KTL) Un-Biased	6.88E-02	6.88E-02	6.97E-02	7.02E-02	7.09E-02	7.09E-02	6.99E-02
Specification MAX	1.50E-01	1.50E-01	1.50E-01	1.50E-01	1.50E-01	1.50E-01	1.50E-01
Status	PASS	PASS	PASS	PASS	PASS	PASS	PASS

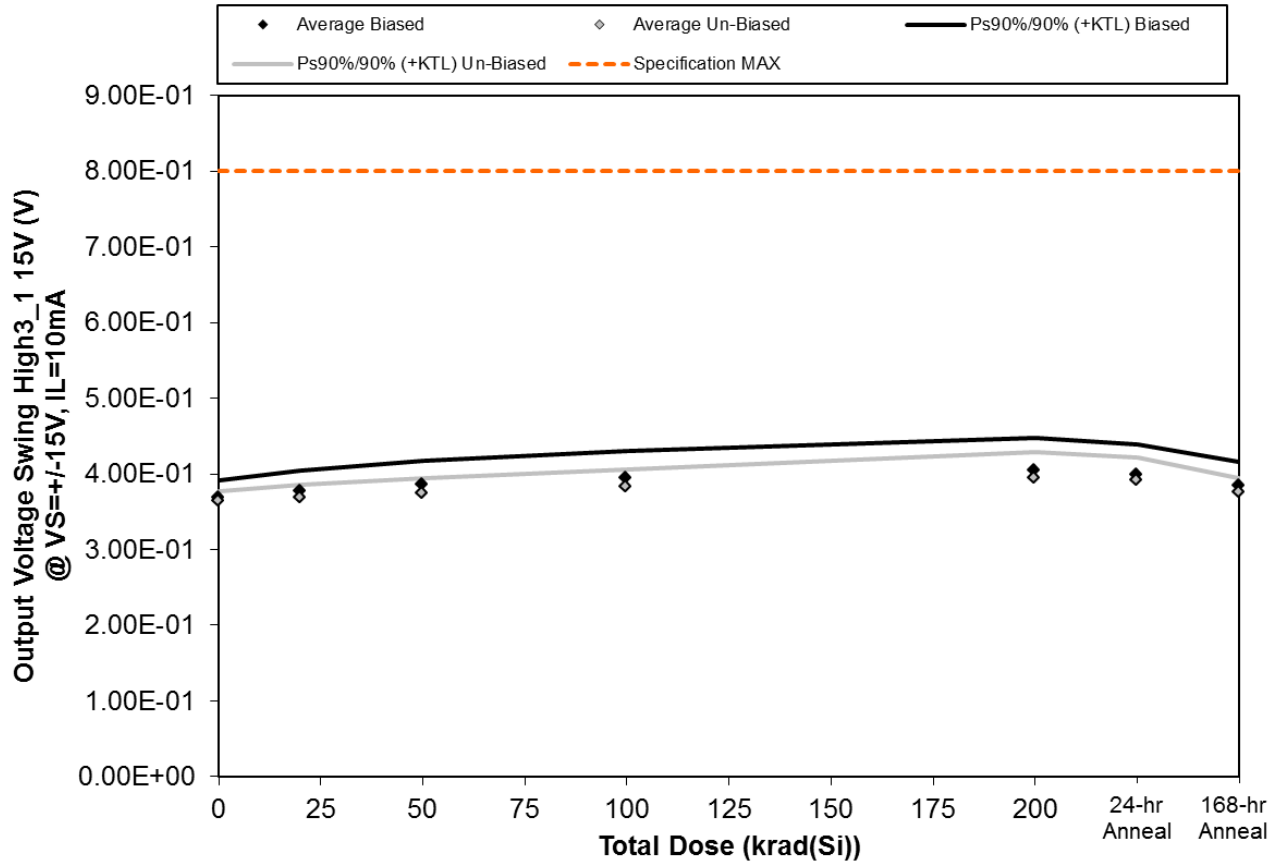

Figure 5.31. Plot of Output Voltage Swing High3_1 15V (V) @ VS=+-15V, IL=10mA versus total dose. The solid diamonds are the average of the measured data points for the samples irradiated under electrical bias while the shaded diamonds are the average of the measured data points for the samples irradiated with all pins tied to ground. The black lines (solid and/or dashed) are the upper and/or lower confidence limits, as determined by KTL statistics, on the samples irradiated under electrical bias while the gray lines (solid and/or dashed) are the upper and/or lower confidence limits, as determined by KTL statistics, on the samples irradiated in the unbiased condition. The red dotted line(s) are the pre- and/or post-irradiation minimum and/or maximum specification value as defined in the datasheet and/or test plan.



TID Report
15-0091 03/20/15 R1.0

Aeroflex RAD
5030 Centennial Blvd.
Colorado Springs, CO 80919
(719) 531-0800

Table 5.31. Raw data for Output Voltage Swing High3_1 15V (V) @ VS=+/-15V, IL=10mA versus total dose, including the statistical analysis, specification and the status of the testing (pass/fail).

Output Voltage Swing High3_1 15V (V) @ VS=+/-15V, IL=10mA	Total Dose (krad(Si))					24-hr Anneal	168-hr Anneal
	0	20	50	100	200		
Device							
680	3.66E-01	3.74E-01	3.83E-01	3.94E-01	4.05E-01	3.98E-01	3.82E-01
681	3.74E-01	3.84E-01	3.93E-01	4.03E-01	4.13E-01	4.08E-01	3.93E-01
682	3.59E-01	3.65E-01	3.72E-01	3.78E-01	3.84E-01	3.81E-01	3.72E-01
683	3.80E-01	3.91E-01	4.01E-01	4.12E-01	4.24E-01	4.18E-01	4.00E-01
684	3.65E-01	3.73E-01	3.80E-01	3.88E-01	3.96E-01	3.92E-01	3.79E-01
685	3.65E-01	3.69E-01	3.76E-01	3.84E-01	3.98E-01	3.93E-01	3.77E-01
686	3.63E-01	3.66E-01	3.73E-01	3.81E-01	3.95E-01	3.91E-01	3.73E-01
688	3.58E-01	3.61E-01	3.65E-01	3.70E-01	3.78E-01	3.76E-01	3.67E-01
689	3.66E-01	3.71E-01	3.77E-01	3.85E-01	3.96E-01	3.93E-01	3.78E-01
690	3.71E-01	3.78E-01	3.84E-01	3.94E-01	4.11E-01	4.06E-01	3.85E-01
691	3.49E-01	3.49E-01	3.49E-01	3.50E-01	3.49E-01	3.50E-01	3.49E-01
692	3.71E-01	3.70E-01	3.71E-01	3.71E-01	3.71E-01	3.71E-01	3.71E-01
Biased Statistics							
Average Biased	3.69E-01	3.77E-01	3.86E-01	3.95E-01	4.05E-01	3.99E-01	3.85E-01
Std Dev Biased	8.40E-03	9.93E-03	1.14E-02	1.31E-02	1.54E-02	1.42E-02	1.13E-02
Ps90%/90% (+KTL) Biased	3.92E-01	4.04E-01	4.17E-01	4.31E-01	4.47E-01	4.38E-01	4.16E-01
Ps90%/90% (-KTL) Biased	3.46E-01	3.50E-01	3.55E-01	3.59E-01	3.62E-01	3.60E-01	3.54E-01
Un-Biased Statistics							
Average Un-Biased	3.65E-01	3.69E-01	3.75E-01	3.83E-01	3.96E-01	3.92E-01	3.76E-01
Std Dev Un-Biased	4.53E-03	6.04E-03	6.86E-03	8.48E-03	1.19E-02	1.06E-02	6.46E-03
Ps90%/90% (+KTL) Un-Biased	3.77E-01	3.86E-01	3.94E-01	4.06E-01	4.28E-01	4.21E-01	3.94E-01
Ps90%/90% (-KTL) Un-Biased	3.52E-01	3.52E-01	3.56E-01	3.60E-01	3.63E-01	3.63E-01	3.58E-01
Specification MAX	8.00E-01	8.00E-01	8.00E-01	8.00E-01	8.00E-01	8.00E-01	8.00E-01
Status	PASS	PASS	PASS	PASS	PASS	PASS	PASS

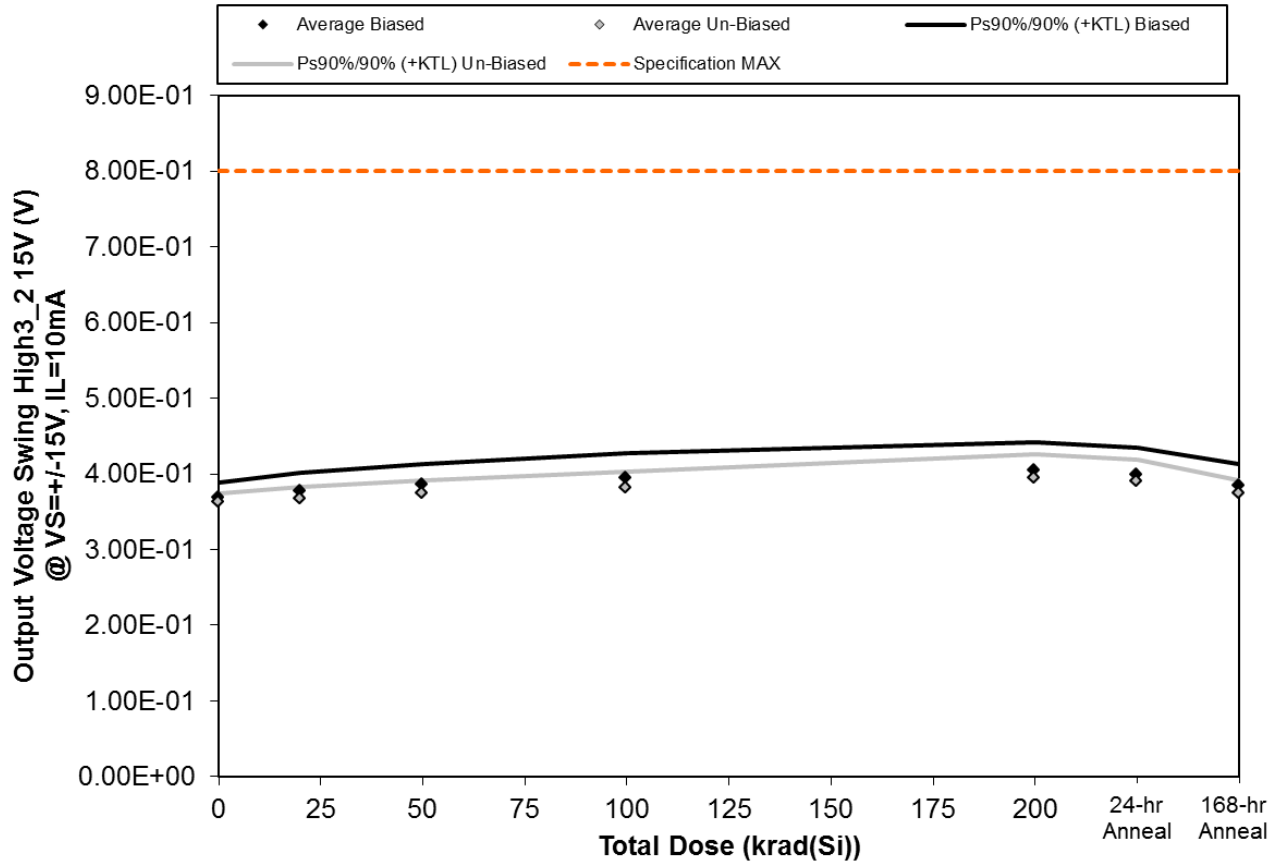

Figure 5.32. Plot of Output Voltage Swing High3_2 15V (V) @ VS=+-15V, IL=10mA versus total dose. The solid diamonds are the average of the measured data points for the samples irradiated under electrical bias while the shaded diamonds are the average of the measured data points for the samples irradiated with all pins tied to ground. The black lines (solid and/or dashed) are the upper and/or lower confidence limits, as determined by KTL statistics, on the samples irradiated under electrical bias while the gray lines (solid and/or dashed) are the upper and/or lower confidence limits, as determined by KTL statistics, on the samples irradiated in the unbiased condition. The red dotted line(s) are the pre- and/or post-irradiation minimum and/or maximum specification value as defined in the datasheet and/or test plan.



TID Report
15-0091 03/20/15 R1.0

Aeroflex RAD
5030 Centennial Blvd.
Colorado Springs, CO 80919
(719) 531-0800

Table 5.32. Raw data for Output Voltage Swing High3_2 15V (V) @ VS=+/-15V, IL=10mA versus total dose, including the statistical analysis, specification and the status of the testing (pass/fail).

Output Voltage Swing High3_2 15V (V) @ VS=+/-15V, IL=10mA	Total Dose (krad(Si))					24-hr Anneal	168-hr Anneal
	0	20	50	100	200		
Device							
680	3.66E-01	3.75E-01	3.84E-01	3.96E-01	4.06E-01	4.00E-01	3.84E-01
681	3.71E-01	3.81E-01	3.89E-01	3.98E-01	4.08E-01	4.03E-01	3.89E-01
682	3.59E-01	3.66E-01	3.72E-01	3.79E-01	3.85E-01	3.82E-01	3.72E-01
683	3.80E-01	3.90E-01	4.00E-01	4.11E-01	4.23E-01	4.17E-01	4.00E-01
684	3.67E-01	3.75E-01	3.83E-01	3.91E-01	4.00E-01	3.95E-01	3.82E-01
685	3.63E-01	3.67E-01	3.73E-01	3.81E-01	3.95E-01	3.90E-01	3.75E-01
686	3.64E-01	3.68E-01	3.74E-01	3.83E-01	3.96E-01	3.92E-01	3.75E-01
688	3.58E-01	3.61E-01	3.65E-01	3.70E-01	3.77E-01	3.76E-01	3.67E-01
689	3.65E-01	3.69E-01	3.75E-01	3.83E-01	3.94E-01	3.91E-01	3.76E-01
690	3.69E-01	3.76E-01	3.82E-01	3.92E-01	4.09E-01	4.04E-01	3.83E-01
691	3.51E-01	3.51E-01	3.51E-01	3.52E-01	3.51E-01	3.52E-01	3.52E-01
692	3.69E-01	3.69E-01	3.70E-01	3.70E-01	3.69E-01	3.69E-01	3.69E-01
Biased Statistics							
Average Biased	3.69E-01	3.77E-01	3.86E-01	3.95E-01	4.04E-01	3.99E-01	3.85E-01
Std Dev Biased	7.45E-03	8.80E-03	1.01E-02	1.18E-02	1.38E-02	1.28E-02	1.01E-02
Ps90%/90% (+KTL) Biased	3.89E-01	4.01E-01	4.13E-01	4.27E-01	4.42E-01	4.34E-01	4.13E-01
Ps90%/90% (-KTL) Biased	3.48E-01	3.53E-01	3.58E-01	3.62E-01	3.66E-01	3.64E-01	3.58E-01
Un-Biased Statistics							
Average Un-Biased	3.64E-01	3.68E-01	3.74E-01	3.82E-01	3.94E-01	3.91E-01	3.75E-01
Std Dev Un-Biased	3.89E-03	5.27E-03	6.12E-03	7.82E-03	1.13E-02	1.00E-02	5.68E-03
Ps90%/90% (+KTL) Un-Biased	3.75E-01	3.83E-01	3.91E-01	4.03E-01	4.25E-01	4.18E-01	3.91E-01
Ps90%/90% (-KTL) Un-Biased	3.53E-01	3.54E-01	3.57E-01	3.60E-01	3.63E-01	3.63E-01	3.60E-01
Specification MAX	8.00E-01	8.00E-01	8.00E-01	8.00E-01	8.00E-01	8.00E-01	8.00E-01
Status	PASS	PASS	PASS	PASS	PASS	PASS	PASS

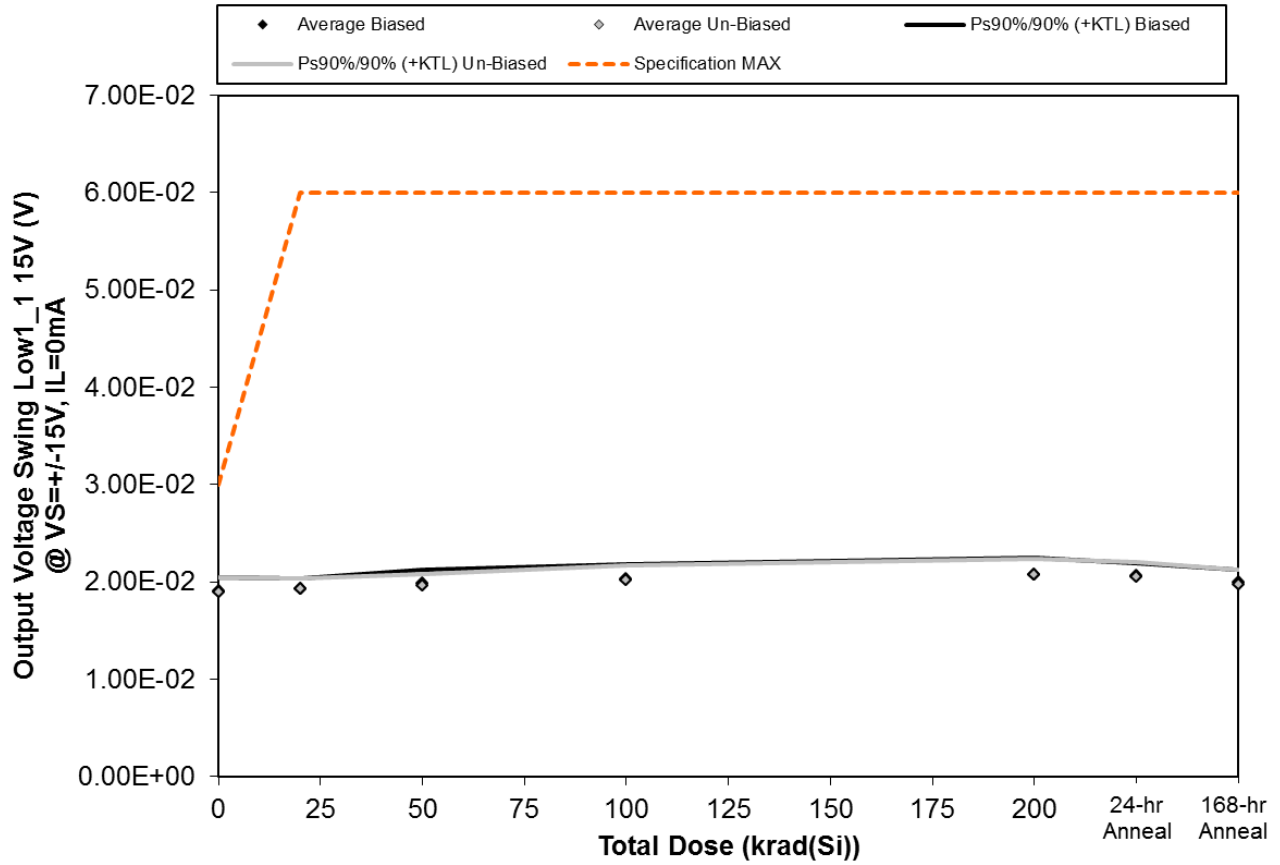

Figure 5.33. Plot of Output Voltage Swing Low1_1 15V (V) @ VS=+-15V, IL=0mA versus total dose. The solid diamonds are the average of the measured data points for the samples irradiated under electrical bias while the shaded diamonds are the average of the measured data points for the samples irradiated with all pins tied to ground. The black lines (solid and/or dashed) are the upper and/or lower confidence limits, as determined by KTL statistics, on the samples irradiated under electrical bias while the gray lines (solid and/or dashed) are the upper and/or lower confidence limits, as determined by KTL statistics, on the samples irradiated in the unbiased condition. The red dotted line(s) are the pre- and/or post-irradiation minimum and/or maximum specification value as defined in the datasheet and/or test plan.



TID Report
15-0091 03/20/15 R1.0

Aeroflex RAD
5030 Centennial Blvd.
Colorado Springs, CO 80919
(719) 531-0800

Table 5.33. Raw data for Output Voltage Swing Low1_1 15V (V) @ VS=+-15V, IL=0mA versus total dose, including the statistical analysis, specification and the status of the testing (pass/fail).

Output Voltage Swing Low1_1 15V (V) @ VS=+-15V, IL=0mA	Total Dose (krad(Si))					24-hr Anneal	168-hr Anneal
	0	20	50	100	200		
Device							
680	1.91E-02	1.93E-02	1.98E-02	2.07E-02	2.10E-02	2.10E-02	2.01E-02
681	1.93E-02	1.94E-02	1.99E-02	2.06E-02	2.09E-02	2.09E-02	2.03E-02
682	1.83E-02	1.89E-02	1.90E-02	1.94E-02	1.98E-02	1.99E-02	1.92E-02
683	1.97E-02	1.99E-02	2.05E-02	2.06E-02	2.15E-02	2.11E-02	2.04E-02
684	1.91E-02	1.92E-02	1.99E-02	2.03E-02	2.07E-02	2.04E-02	1.99E-02
685	1.94E-02	1.97E-02	2.00E-02	2.06E-02	2.13E-02	2.11E-02	2.00E-02
686	1.89E-02	1.93E-02	1.97E-02	2.02E-02	2.09E-02	2.06E-02	1.98E-02
688	1.82E-02	1.87E-02	1.91E-02	1.93E-02	1.98E-02	1.97E-02	1.88E-02
689	1.95E-02	1.96E-02	2.00E-02	2.07E-02	2.10E-02	2.09E-02	2.03E-02
690	1.86E-02	1.94E-02	1.93E-02	2.01E-02	2.08E-02	2.06E-02	1.97E-02
691	1.92E-02	1.91E-02	1.92E-02	1.94E-02	1.92E-02	1.94E-02	1.91E-02
692	1.93E-02	1.94E-02	1.94E-02	1.93E-02	1.93E-02	1.93E-02	1.94E-02
Biased Statistics							
Average Biased	1.91E-02	1.93E-02	1.98E-02	2.03E-02	2.07E-02	2.07E-02	2.00E-02
Std Dev Biased	4.95E-04	3.82E-04	5.46E-04	5.40E-04	6.28E-04	4.77E-04	4.53E-04
Ps90%/90% (+KTL) Biased	2.05E-02	2.04E-02	2.13E-02	2.18E-02	2.25E-02	2.20E-02	2.12E-02
Ps90%/90% (-KTL) Biased	1.77E-02	1.83E-02	1.83E-02	1.88E-02	1.90E-02	1.94E-02	1.87E-02
Un-Biased Statistics							
Average Un-Biased	1.89E-02	1.93E-02	1.96E-02	2.02E-02	2.08E-02	2.06E-02	1.97E-02
Std Dev Un-Biased	5.58E-04	3.95E-04	4.30E-04	5.45E-04	5.78E-04	5.41E-04	5.65E-04
Ps90%/90% (+KTL) Un-Biased	2.05E-02	2.04E-02	2.08E-02	2.17E-02	2.23E-02	2.21E-02	2.13E-02
Ps90%/90% (-KTL) Un-Biased	1.74E-02	1.82E-02	1.85E-02	1.87E-02	1.92E-02	1.91E-02	1.82E-02
Specification MAX	3.00E-02	6.00E-02	6.00E-02	6.00E-02	6.00E-02	6.00E-02	6.00E-02
Status	PASS	PASS	PASS	PASS	PASS	PASS	PASS

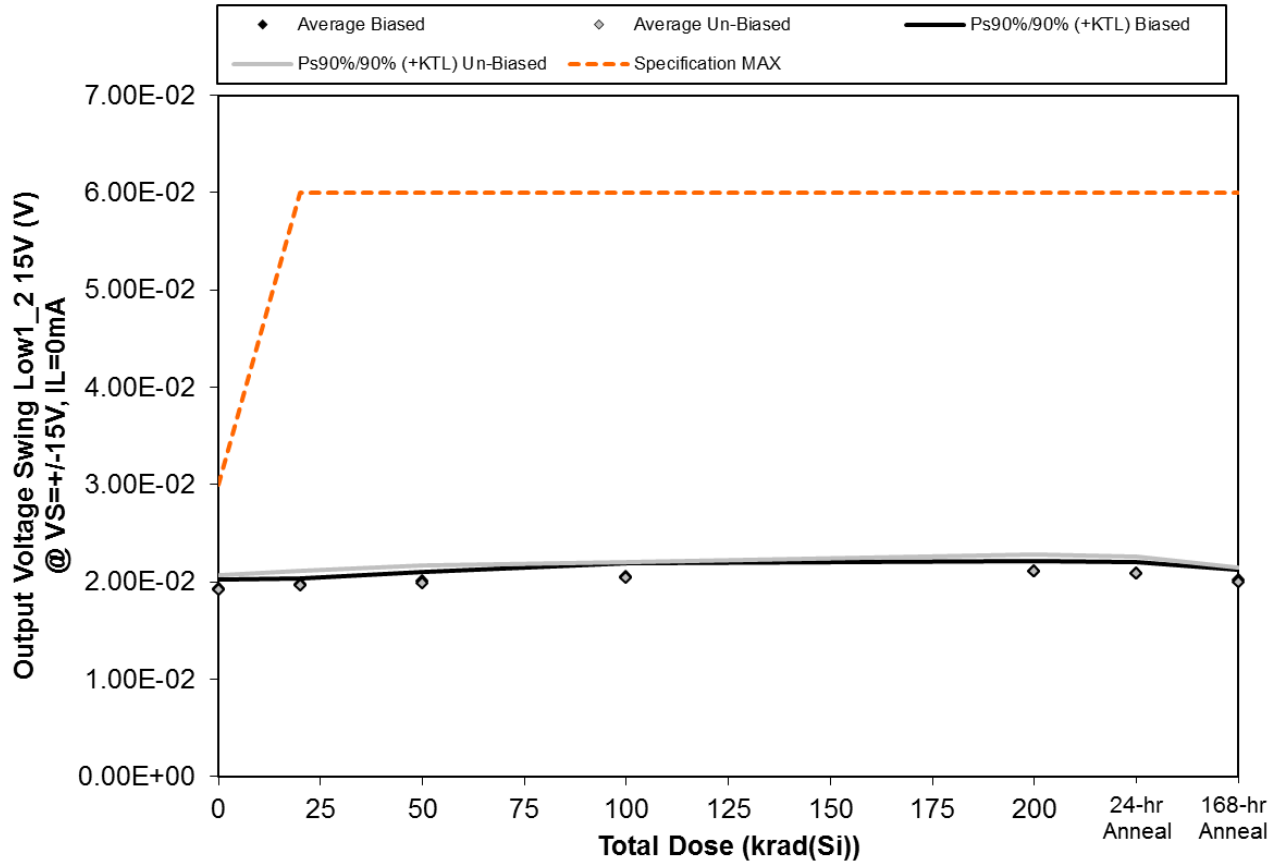

Figure 5.34. Plot of Output Voltage Swing Low1_2 15V (V) @ VS=+-15V, IL=0mA versus total dose. The solid diamonds are the average of the measured data points for the samples irradiated under electrical bias while the shaded diamonds are the average of the measured data points for the samples irradiated with all pins tied to ground. The black lines (solid and/or dashed) are the upper and/or lower confidence limits, as determined by KTL statistics, on the samples irradiated under electrical bias while the gray lines (solid and/or dashed) are the upper and/or lower confidence limits, as determined by KTL statistics, on the samples irradiated in the unbiased condition. The red dotted line(s) are the pre- and/or post-irradiation minimum and/or maximum specification value as defined in the datasheet and/or test plan.



TID Report
15-0091 03/20/15 R1.0

Aeroflex RAD
5030 Centennial Blvd.
Colorado Springs, CO 80919
(719) 531-0800

Table 5.34. Raw data for Output Voltage Swing Low1_2 15V (V) @ VS=+-15V, IL=0mA versus total dose, including the statistical analysis, specification and the status of the testing (pass/fail).

Output Voltage Swing Low1_2 15V (V) @ VS=+-15V, IL=0mA	Total Dose (krad(Si))					24-hr Anneal	168-hr Anneal
	0	20	50	100	200		
Device							
680	1.94E-02	1.97E-02	2.01E-02	2.11E-02	2.13E-02	2.10E-02	2.04E-02
681	1.96E-02	1.97E-02	2.01E-02	2.05E-02	2.13E-02	2.10E-02	2.02E-02
682	1.88E-02	1.93E-02	1.96E-02	1.97E-02	2.04E-02	2.01E-02	1.96E-02
683	1.96E-02	1.98E-02	2.05E-02	2.06E-02	2.13E-02	2.11E-02	2.06E-02
684	1.92E-02	2.00E-02	2.03E-02	2.06E-02	2.11E-02	2.11E-02	2.02E-02
685	1.96E-02	2.00E-02	2.05E-02	2.07E-02	2.16E-02	2.14E-02	2.05E-02
686	1.93E-02	1.98E-02	2.00E-02	2.08E-02	2.14E-02	2.11E-02	2.02E-02
688	1.83E-02	1.86E-02	1.88E-02	1.94E-02	2.00E-02	1.98E-02	1.91E-02
689	1.96E-02	1.98E-02	2.03E-02	2.07E-02	2.14E-02	2.13E-02	2.02E-02
690	1.92E-02	1.98E-02	1.98E-02	2.02E-02	2.10E-02	2.10E-02	1.97E-02
691	1.95E-02	1.96E-02	1.96E-02	1.96E-02	1.96E-02	1.96E-02	1.96E-02
692	1.93E-02	1.94E-02	1.95E-02	1.93E-02	1.94E-02	1.97E-02	1.97E-02
Biased Statistics							
Average Biased	1.93E-02	1.97E-02	2.01E-02	2.05E-02	2.11E-02	2.09E-02	2.02E-02
Std Dev Biased	3.42E-04	2.29E-04	3.37E-04	5.22E-04	3.90E-04	4.45E-04	3.76E-04
Ps90%/90% (+KTL) Biased	2.02E-02	2.03E-02	2.10E-02	2.19E-02	2.21E-02	2.21E-02	2.12E-02
Ps90%/90% (-KTL) Biased	1.84E-02	1.91E-02	1.92E-02	1.90E-02	2.00E-02	1.96E-02	1.91E-02
Un-Biased Statistics							
Average Un-Biased	1.92E-02	1.96E-02	1.99E-02	2.04E-02	2.11E-02	2.09E-02	1.99E-02
Std Dev Un-Biased	5.51E-04	5.80E-04	6.57E-04	5.99E-04	6.42E-04	6.29E-04	5.79E-04
Ps90%/90% (+KTL) Un-Biased	2.07E-02	2.12E-02	2.17E-02	2.20E-02	2.28E-02	2.26E-02	2.15E-02
Ps90%/90% (-KTL) Un-Biased	1.77E-02	1.80E-02	1.81E-02	1.87E-02	1.93E-02	1.92E-02	1.83E-02
Specification MAX	3.00E-02	6.00E-02	6.00E-02	6.00E-02	6.00E-02	6.00E-02	6.00E-02
Status	PASS	PASS	PASS	PASS	PASS	PASS	PASS

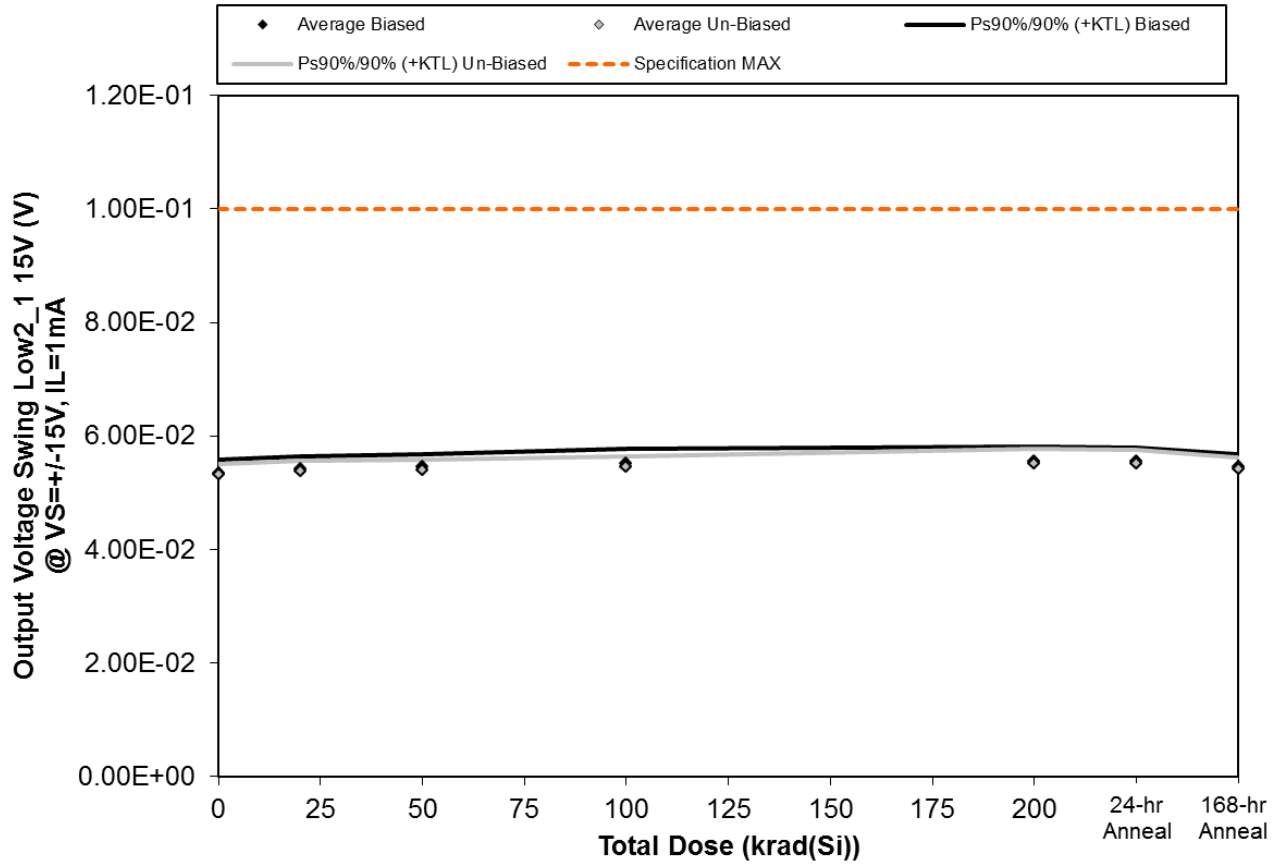

Figure 5.35. Plot of Output Voltage Swing Low2_1 15V (V) @ VS=+-15V, IL=1mA versus total dose. The solid diamonds are the average of the measured data points for the samples irradiated under electrical bias while the shaded diamonds are the average of the measured data points for the samples irradiated with all pins tied to ground. The black lines (solid and/or dashed) are the upper and/or lower confidence limits, as determined by KTL statistics, on the samples irradiated under electrical bias while the gray lines (solid and/or dashed) are the upper and/or lower confidence limits, as determined by KTL statistics, on the samples irradiated in the unbiased condition. The red dotted line(s) are the pre- and/or post-irradiation minimum and/or maximum specification value as defined in the datasheet and/or test plan.



TID Report
15-0091 03/20/15 R1.0

Aeroflex RAD
5030 Centennial Blvd.
Colorado Springs, CO 80919
(719) 531-0800

Table 5.35. Raw data for Output Voltage Swing Low2_1 15V (V) @ VS=+-15V, IL=1mA versus total dose, including the statistical analysis, specification and the status of the testing (pass/fail).

Output Voltage Swing Low2_1 15V (V) @ VS=+-15V, IL=1mA	Total Dose (krad(Si))					24-hr Anneal	168-hr Anneal
	0	20	50	100	200		
Device							
680	5.32E-02	5.36E-02	5.41E-02	5.55E-02	5.55E-02	5.54E-02	5.42E-02
681	5.39E-02	5.45E-02	5.49E-02	5.55E-02	5.60E-02	5.58E-02	5.51E-02
682	5.23E-02	5.30E-02	5.35E-02	5.36E-02	5.43E-02	5.41E-02	5.37E-02
683	5.46E-02	5.51E-02	5.56E-02	5.61E-02	5.69E-02	5.67E-02	5.56E-02
684	5.35E-02	5.44E-02	5.46E-02	5.52E-02	5.54E-02	5.55E-02	5.48E-02
685	5.36E-02	5.42E-02	5.46E-02	5.48E-02	5.58E-02	5.58E-02	5.47E-02
686	5.35E-02	5.39E-02	5.39E-02	5.48E-02	5.52E-02	5.53E-02	5.44E-02
688	5.22E-02	5.26E-02	5.29E-02	5.34E-02	5.36E-02	5.35E-02	5.28E-02
689	5.38E-02	5.42E-02	5.45E-02	5.51E-02	5.57E-02	5.57E-02	5.47E-02
690	5.34E-02	5.41E-02	5.41E-02	5.47E-02	5.55E-02	5.52E-02	5.40E-02
691	5.29E-02	5.29E-02	5.27E-02	5.28E-02	5.29E-02	5.31E-02	5.29E-02
692	5.41E-02	5.41E-02	5.41E-02	5.41E-02	5.38E-02	5.40E-02	5.40E-02
Biased Statistics							
Average Biased	5.35E-02	5.41E-02	5.45E-02	5.52E-02	5.56E-02	5.55E-02	5.47E-02
Std Dev Biased	8.24E-04	8.20E-04	7.96E-04	9.20E-04	9.35E-04	9.22E-04	7.72E-04
Ps90%/90% (+KTL) Biased	5.58E-02	5.64E-02	5.67E-02	5.77E-02	5.82E-02	5.80E-02	5.68E-02
Ps90%/90% (-KTL) Biased	5.12E-02	5.19E-02	5.23E-02	5.27E-02	5.31E-02	5.30E-02	5.25E-02
Un-Biased Statistics							
Average Un-Biased	5.33E-02	5.38E-02	5.40E-02	5.45E-02	5.52E-02	5.51E-02	5.41E-02
Std Dev Un-Biased	6.20E-04	6.49E-04	6.83E-04	6.85E-04	9.16E-04	9.32E-04	7.98E-04
Ps90%/90% (+KTL) Un-Biased	5.50E-02	5.56E-02	5.59E-02	5.64E-02	5.77E-02	5.76E-02	5.63E-02
Ps90%/90% (-KTL) Un-Biased	5.16E-02	5.20E-02	5.21E-02	5.27E-02	5.26E-02	5.25E-02	5.19E-02
Specification MAX	1.00E-01	1.00E-01	1.00E-01	1.00E-01	1.00E-01	1.00E-01	1.00E-01
Status	PASS	PASS	PASS	PASS	PASS	PASS	PASS

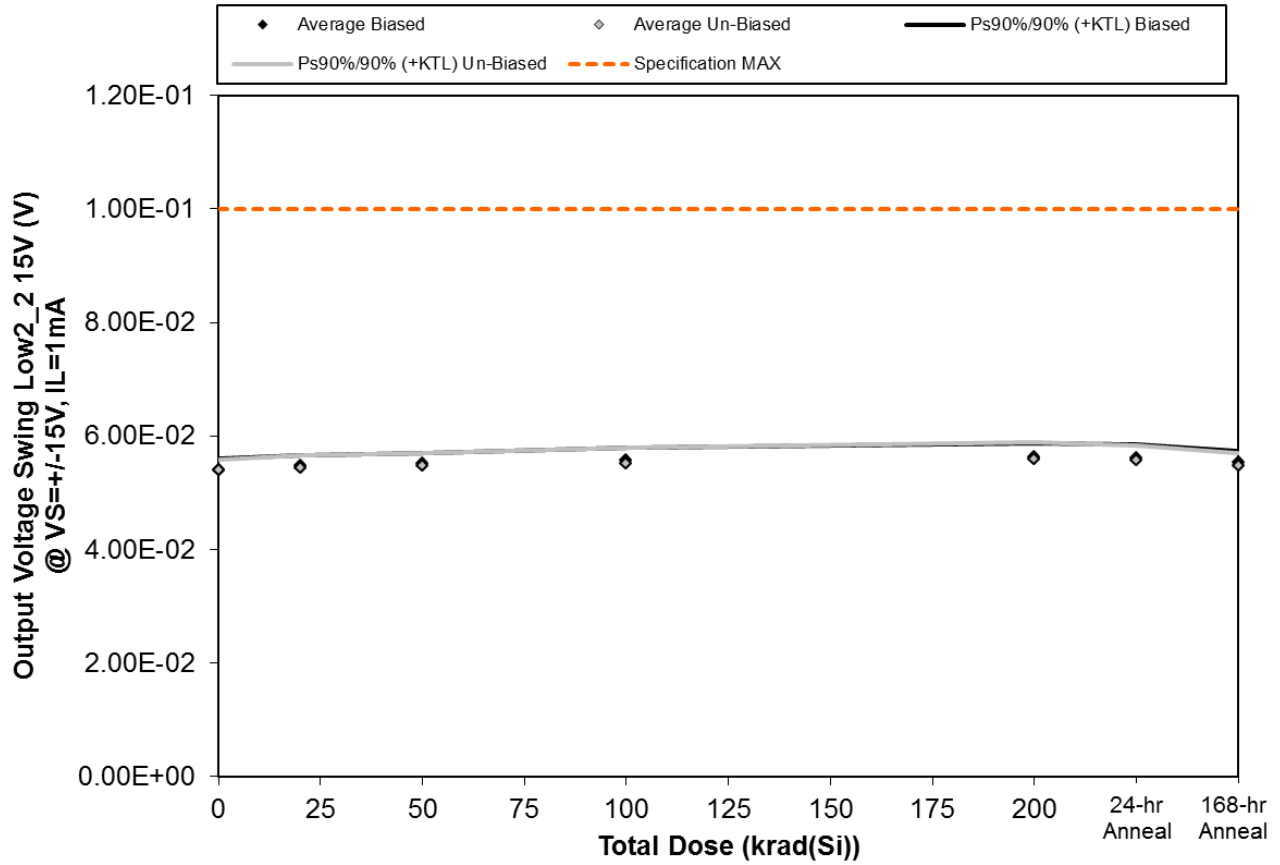

Figure 5.36. Plot of Output Voltage Swing Low2_2 15V (V) @ VS=+-15V, IL=1mA versus total dose. The solid diamonds are the average of the measured data points for the samples irradiated under electrical bias while the shaded diamonds are the average of the measured data points for the samples irradiated with all pins tied to ground. The black lines (solid and/or dashed) are the upper and/or lower confidence limits, as determined by KTL statistics, on the samples irradiated under electrical bias while the gray lines (solid and/or dashed) are the upper and/or lower confidence limits, as determined by KTL statistics, on the samples irradiated in the unbiased condition. The red dotted line(s) are the pre- and/or post-irradiation minimum and/or maximum specification value as defined in the datasheet and/or test plan.



TID Report
15-0091 03/20/15 R1.0

Aeroflex RAD
5030 Centennial Blvd.
Colorado Springs, CO 80919
(719) 531-0800

Table 5.36. Raw data for Output Voltage Swing Low2_2 15V (V) @ VS=+-15V, IL=1mA versus total dose, including the statistical analysis, specification and the status of the testing (pass/fail).

Output Voltage Swing Low2_2 15V (V) @ VS=+-15V, IL=1mA	Total Dose (krad(Si))					24-hr Anneal	168-hr Anneal
	0	20	50	100	200		
Device							
680	5.42E-02	5.45E-02	5.52E-02	5.64E-02	5.65E-02	5.61E-02	5.49E-02
681	5.42E-02	5.53E-02	5.56E-02	5.60E-02	5.67E-02	5.65E-02	5.60E-02
682	5.29E-02	5.39E-02	5.41E-02	5.46E-02	5.49E-02	5.47E-02	5.42E-02
683	5.49E-02	5.56E-02	5.58E-02	5.64E-02	5.73E-02	5.71E-02	5.60E-02
684	5.41E-02	5.46E-02	5.51E-02	5.56E-02	5.59E-02	5.61E-02	5.53E-02
685	5.44E-02	5.48E-02	5.54E-02	5.59E-02	5.65E-02	5.62E-02	5.55E-02
686	5.41E-02	5.45E-02	5.48E-02	5.51E-02	5.67E-02	5.62E-02	5.51E-02
688	5.27E-02	5.30E-02	5.34E-02	5.34E-02	5.41E-02	5.41E-02	5.35E-02
689	5.44E-02	5.47E-02	5.53E-02	5.56E-02	5.62E-02	5.60E-02	5.51E-02
690	5.40E-02	5.50E-02	5.51E-02	5.57E-02	5.64E-02	5.63E-02	5.50E-02
691	5.37E-02	5.36E-02	5.37E-02	5.38E-02	5.35E-02	5.36E-02	5.39E-02
692	5.49E-02	5.43E-02	5.47E-02	5.47E-02	5.46E-02	5.47E-02	5.46E-02
Biased Statistics							
Average Biased	5.40E-02	5.48E-02	5.52E-02	5.58E-02	5.63E-02	5.61E-02	5.53E-02
Std Dev Biased	7.48E-04	6.49E-04	6.80E-04	7.63E-04	9.00E-04	8.85E-04	7.80E-04
Ps90%/90% (+KTL) Biased	5.61E-02	5.66E-02	5.70E-02	5.79E-02	5.87E-02	5.85E-02	5.74E-02
Ps90%/90% (-KTL) Biased	5.20E-02	5.30E-02	5.33E-02	5.37E-02	5.38E-02	5.37E-02	5.31E-02
Un-Biased Statistics							
Average Un-Biased	5.39E-02	5.44E-02	5.48E-02	5.51E-02	5.60E-02	5.58E-02	5.48E-02
Std Dev Un-Biased	6.98E-04	7.87E-04	8.30E-04	1.04E-03	1.05E-03	9.33E-04	7.87E-04
Ps90%/90% (+KTL) Un-Biased	5.58E-02	5.65E-02	5.71E-02	5.80E-02	5.88E-02	5.83E-02	5.70E-02
Ps90%/90% (-KTL) Un-Biased	5.20E-02	5.22E-02	5.25E-02	5.23E-02	5.31E-02	5.32E-02	5.27E-02
Specification MAX	1.00E-01	1.00E-01	1.00E-01	1.00E-01	1.00E-01	1.00E-01	1.00E-01
Status	PASS	PASS	PASS	PASS	PASS	PASS	PASS

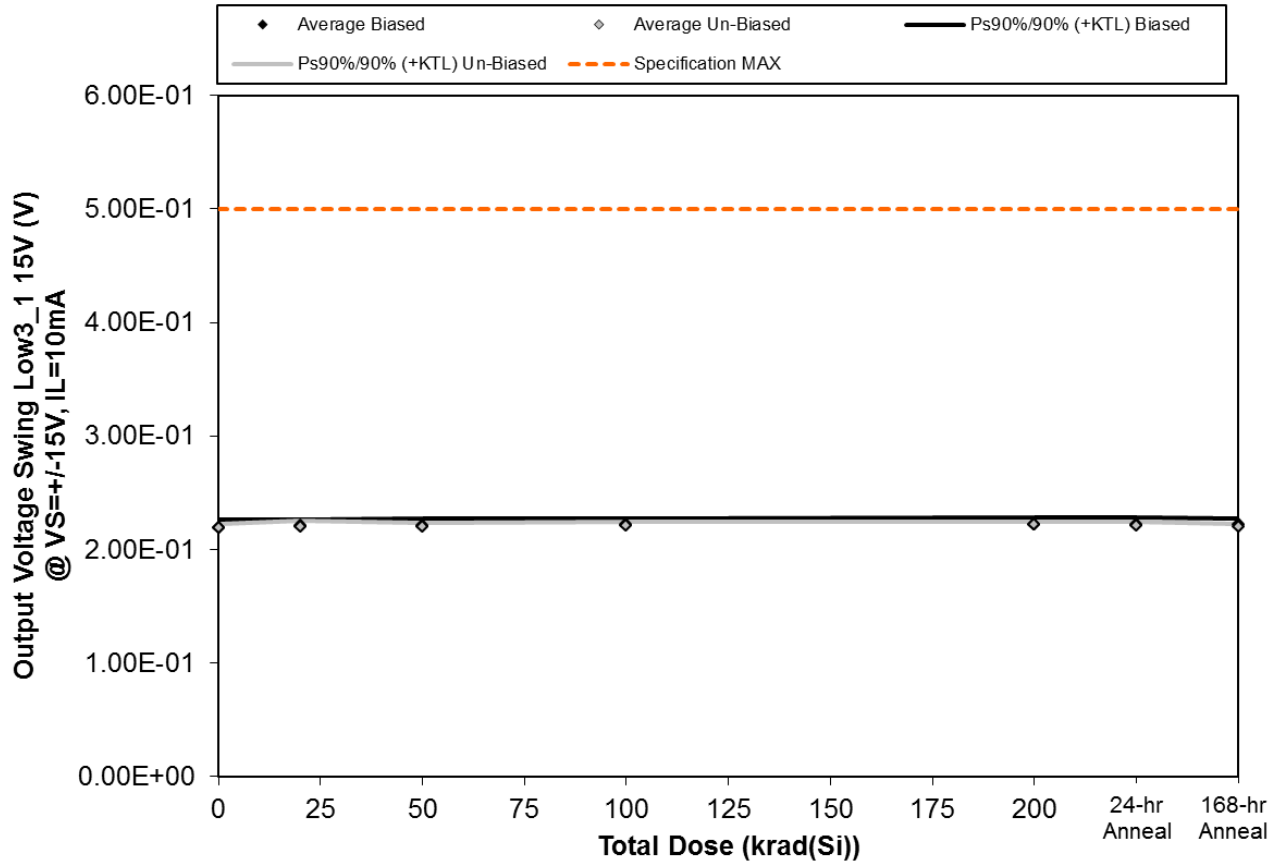

Figure 5.37. Plot of Output Voltage Swing Low3_1 15V (V) @ VS=+-15V, IL=10mA versus total dose. The solid diamonds are the average of the measured data points for the samples irradiated under electrical bias while the shaded diamonds are the average of the measured data points for the samples irradiated with all pins tied to ground. The black lines (solid and/or dashed) are the upper and/or lower confidence limits, as determined by KTL statistics, on the samples irradiated under electrical bias while the gray lines (solid and/or dashed) are the upper and/or lower confidence limits, as determined by KTL statistics, on the samples irradiated in the unbiased condition. The red dotted line(s) are the pre- and/or post-irradiation minimum and/or maximum specification value as defined in the datasheet and/or test plan.



TID Report
15-0091 03/20/15 R1.0

Aeroflex RAD
5030 Centennial Blvd.
Colorado Springs, CO 80919
(719) 531-0800

Table 5.37. Raw data for Output Voltage Swing Low3_1 15V (V) @ VS=+/-15V, IL=10mA versus total dose, including the statistical analysis, specification and the status of the testing (pass/fail).

Output Voltage Swing Low3_1 15V (V) @ VS=+/-15V, IL=10mA	Total Dose (krad(Si))					24-hr	168-hr
	0	20	50	100	200	Anneal	Anneal
Device							
680	2.16E-01	2.19E-01	2.19E-01	2.23E-01	2.21E-01	2.19E-01	2.19E-01
681	2.21E-01	2.22E-01	2.23E-01	2.23E-01	2.23E-01	2.23E-01	2.23E-01
682	2.16E-01	2.19E-01	2.19E-01	2.20E-01	2.20E-01	2.21E-01	2.20E-01
683	2.21E-01	2.23E-01	2.24E-01	2.23E-01	2.25E-01	2.24E-01	2.23E-01
684	2.21E-01	2.22E-01	2.23E-01	2.24E-01	2.24E-01	2.24E-01	2.23E-01
685	2.18E-01	2.20E-01	2.20E-01	2.20E-01	2.21E-01	2.21E-01	2.20E-01
686	2.17E-01	2.17E-01	2.18E-01	2.20E-01	2.20E-01	2.20E-01	2.19E-01
688	2.20E-01	2.20E-01	2.21E-01	2.21E-01	2.22E-01	2.22E-01	2.21E-01
689	2.21E-01	2.21E-01	2.21E-01	2.22E-01	2.23E-01	2.23E-01	2.21E-01
690	2.19E-01	2.22E-01	2.20E-01	2.22E-01	2.23E-01	2.22E-01	2.21E-01
691	2.15E-01	2.14E-01	2.14E-01	2.15E-01	2.15E-01	2.15E-01	2.15E-01
692	2.21E-01	2.22E-01	2.22E-01	2.22E-01	2.22E-01	2.22E-01	2.22E-01
Biased Statistics							
Average Biased	2.19E-01	2.21E-01	2.21E-01	2.23E-01	2.23E-01	2.22E-01	2.22E-01
Std Dev Biased	2.61E-03	2.11E-03	2.25E-03	1.59E-03	2.22E-03	2.08E-03	1.95E-03
Ps90%/90% (+KTL) Biased	2.26E-01	2.27E-01	2.28E-01	2.27E-01	2.29E-01	2.28E-01	2.27E-01
Ps90%/90% (-KTL) Biased	2.12E-01	2.15E-01	2.15E-01	2.18E-01	2.16E-01	2.17E-01	2.16E-01
Un-Biased Statistics							
Average Un-Biased	2.19E-01	2.20E-01	2.20E-01	2.21E-01	2.22E-01	2.22E-01	2.20E-01
Std Dev Un-Biased	1.32E-03	1.88E-03	1.43E-03	1.12E-03	9.80E-04	1.21E-03	7.38E-04
Ps90%/90% (+KTL) Un-Biased	2.23E-01	2.25E-01	2.24E-01	2.24E-01	2.25E-01	2.25E-01	2.22E-01
Ps90%/90% (-KTL) Un-Biased	2.16E-01	2.15E-01	2.16E-01	2.18E-01	2.19E-01	2.18E-01	2.18E-01
Specification MAX	5.00E-01	5.00E-01	5.00E-01	5.00E-01	5.00E-01	5.00E-01	5.00E-01
Status	PASS	PASS	PASS	PASS	PASS	PASS	PASS

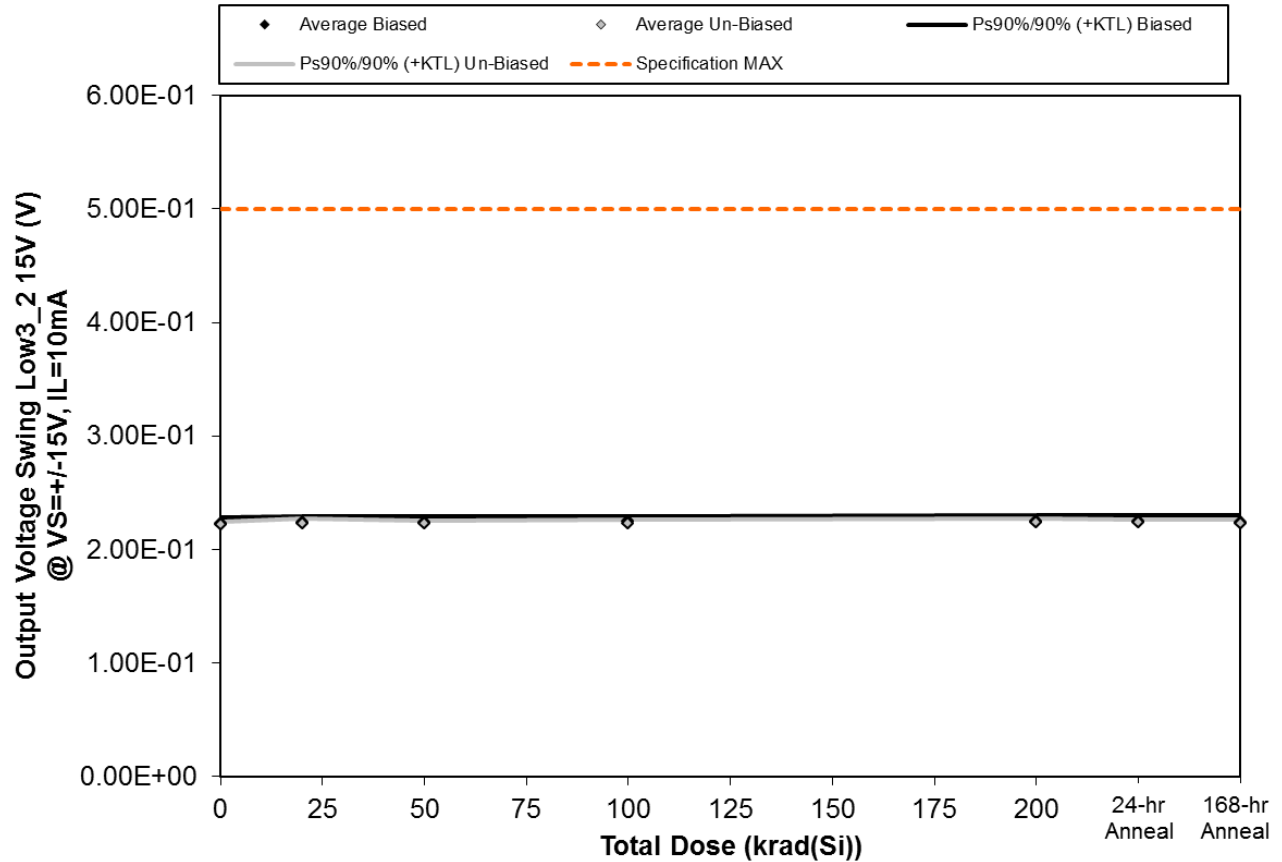

Figure 5.38. Plot of Output Voltage Swing Low3_2 15V (V) @ VS=+-15V, IL=10mA versus total dose. The solid diamonds are the average of the measured data points for the samples irradiated under electrical bias while the shaded diamonds are the average of the measured data points for the samples irradiated with all pins tied to ground. The black lines (solid and/or dashed) are the upper and/or lower confidence limits, as determined by KTL statistics, on the samples irradiated under electrical bias while the gray lines (solid and/or dashed) are the upper and/or lower confidence limits, as determined by KTL statistics, on the samples irradiated in the unbiased condition. The red dotted line(s) are the pre- and/or post-irradiation minimum and/or maximum specification value as defined in the datasheet and/or test plan.



TID Report
15-0091 03/20/15 R1.0

Aeroflex RAD
5030 Centennial Blvd.
Colorado Springs, CO 80919
(719) 531-0800

Table 5.38. Raw data for Output Voltage Swing Low3_2 15V (V) @ VS=+/-15V, IL=10mA versus total dose, including the statistical analysis, specification and the status of the testing (pass/fail).

Output Voltage Swing Low3_2 15V (V) @ VS=+/-15V, IL=10mA	Total Dose (krad(Si))					24-hr Anneal	168-hr Anneal
	0	20	50	100	200		
Device							
680	2.20E-01	2.21E-01	2.21E-01	2.25E-01	2.23E-01	2.23E-01	2.22E-01
681	2.24E-01	2.24E-01	2.24E-01	2.25E-01	2.26E-01	2.25E-01	2.25E-01
682	2.21E-01	2.22E-01	2.22E-01	2.22E-01	2.23E-01	2.22E-01	2.22E-01
683	2.24E-01	2.25E-01	2.26E-01	2.26E-01	2.27E-01	2.27E-01	2.27E-01
684	2.24E-01	2.25E-01	2.25E-01	2.26E-01	2.27E-01	2.26E-01	2.25E-01
685	2.21E-01	2.22E-01	2.23E-01	2.22E-01	2.24E-01	2.23E-01	2.22E-01
686	2.21E-01	2.20E-01	2.21E-01	2.21E-01	2.22E-01	2.23E-01	2.21E-01
688	2.22E-01	2.22E-01	2.22E-01	2.23E-01	2.23E-01	2.24E-01	2.23E-01
689	2.23E-01	2.24E-01	2.24E-01	2.25E-01	2.25E-01	2.25E-01	2.25E-01
690	2.22E-01	2.25E-01	2.23E-01	2.23E-01	2.25E-01	2.24E-01	2.24E-01
691	2.17E-01	2.17E-01	2.17E-01	2.18E-01	2.18E-01	2.18E-01	2.18E-01
692	2.25E-01	2.25E-01	2.24E-01	2.25E-01	2.25E-01	2.24E-01	2.25E-01
Biased Statistics							
Average Biased	2.23E-01	2.24E-01	2.24E-01	2.25E-01	2.25E-01	2.24E-01	2.24E-01
Std Dev Biased	1.90E-03	2.11E-03	1.94E-03	1.61E-03	1.97E-03	1.94E-03	2.15E-03
Ps90%/90% (+KTL) Biased	2.28E-01	2.29E-01	2.29E-01	2.29E-01	2.30E-01	2.30E-01	2.30E-01
Ps90%/90% (-KTL) Biased	2.18E-01	2.18E-01	2.18E-01	2.20E-01	2.20E-01	2.19E-01	2.18E-01
Un-Biased Statistics							
Average Un-Biased	2.22E-01	2.23E-01	2.23E-01	2.23E-01	2.24E-01	2.24E-01	2.23E-01
Std Dev Un-Biased	8.69E-04	1.64E-03	1.11E-03	1.29E-03	1.19E-03	9.81E-04	1.34E-03
Ps90%/90% (+KTL) Un-Biased	2.24E-01	2.27E-01	2.26E-01	2.26E-01	2.27E-01	2.27E-01	2.26E-01
Ps90%/90% (-KTL) Un-Biased	2.19E-01	2.18E-01	2.20E-01	2.19E-01	2.21E-01	2.21E-01	2.19E-01
Specification MAX	5.00E-01	5.00E-01	5.00E-01	5.00E-01	5.00E-01	5.00E-01	5.00E-01
Status	PASS	PASS	PASS	PASS	PASS	PASS	PASS

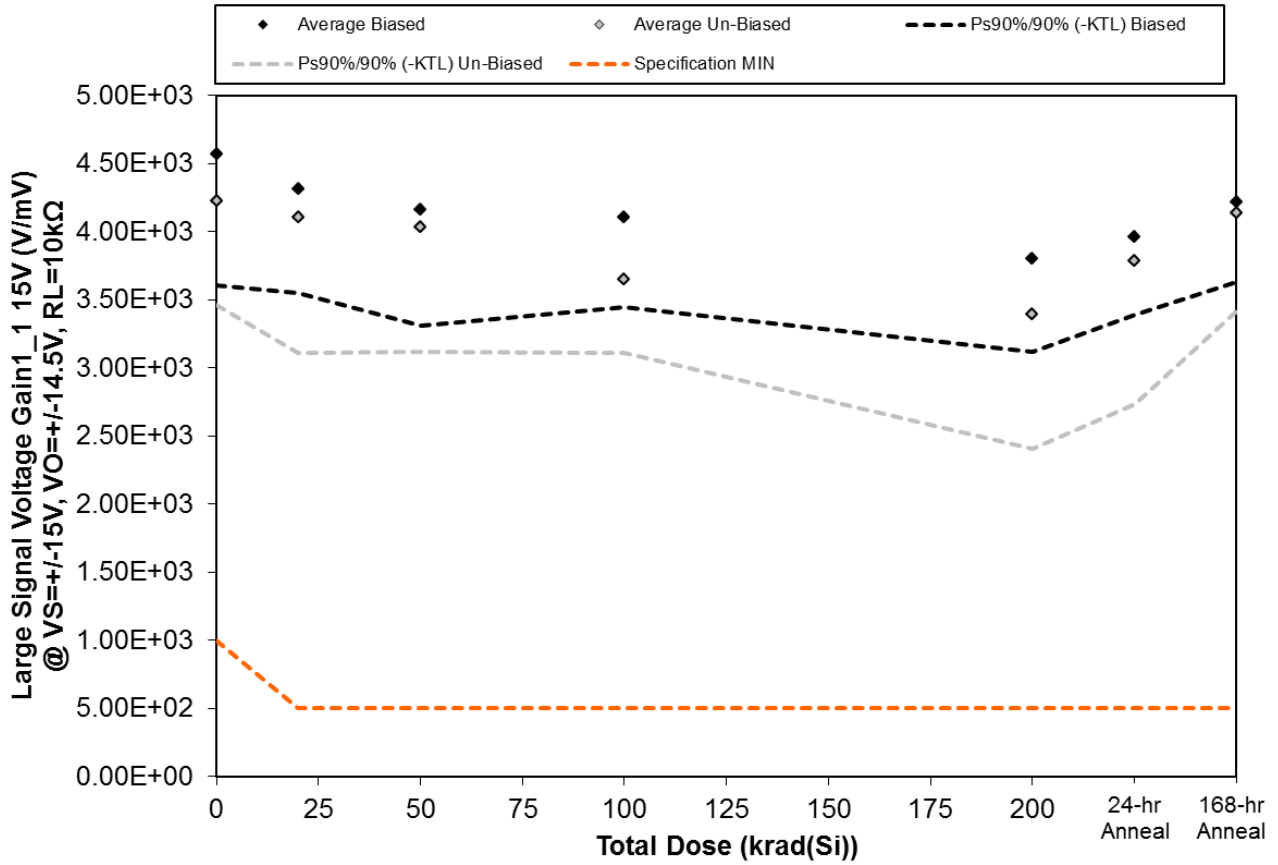

Figure 5.39. Plot of Large Signal Voltage Gain1_1 15V (V/mV) @ VS=+-15V, VO=+-14.5V, RL=10kΩ versus total dose. The solid diamonds are the average of the measured data points for the samples irradiated under electrical bias while the shaded diamonds are the average of the measured data points for the samples irradiated with all pins tied to ground. The black lines (solid and/or dashed) are the upper and/or lower confidence limits, as determined by KTL statistics, on the samples irradiated under electrical bias while the gray lines (solid and/or dashed) are the upper and/or lower confidence limits, as determined by KTL statistics, on the samples irradiated in the unbiased condition. The red dotted line(s) are the pre- and/or post-irradiation minimum and/or maximum specification value as defined in the datasheet and/or test plan.



TID Report
15-0091 03/20/15 R1.0

Aeroflex RAD
5030 Centennial Blvd.
Colorado Springs, CO 80919
(719) 531-0800

Table 5.39. Raw data for Large Signal Voltage Gain1_1 15V (V/mV) @ VS=+/-15V, VO=+/-14.5V, RL=10kΩ versus total dose, including the statistical analysis, specification and the status of the testing (pass/fail).

Large Signal Voltage Gain1_1 15V (V/mV) @ VS=+/-15V, VO=+/-14.5V, RL=10kΩ	Total Dose (krad(Si))					24-hr Anneal	168-hr Anneal
	0	20	50	100	200		
Device							
680	4.95E+03	4.61E+03	4.61E+03	4.36E+03	4.00E+03	4.10E+03	4.48E+03
681	4.69E+03	4.58E+03	4.14E+03	4.30E+03	4.12E+03	4.16E+03	4.29E+03
682	4.06E+03	3.94E+03	3.73E+03	3.76E+03	3.52E+03	3.62E+03	3.92E+03
683	4.77E+03	4.23E+03	4.14E+03	4.10E+03	3.77E+03	3.99E+03	4.29E+03
684	4.37E+03	4.23E+03	4.19E+03	4.00E+03	3.63E+03	3.95E+03	4.10E+03
685	3.76E+03	3.59E+03	3.57E+03	3.44E+03	2.97E+03	3.46E+03	4.20E+03
686	4.22E+03	4.02E+03	4.06E+03	3.56E+03	3.19E+03	3.81E+03	3.94E+03
688	4.31E+03	4.02E+03	3.84E+03	3.69E+03	3.35E+03	3.46E+03	4.07E+03
689	4.35E+03	4.35E+03	4.29E+03	3.96E+03	3.54E+03	3.81E+03	3.91E+03
690	4.49E+03	4.54E+03	4.39E+03	3.58E+03	3.92E+03	4.40E+03	4.56E+03
691	4.26E+03	4.36E+03	4.34E+03	4.24E+03	4.30E+03	4.25E+03	4.27E+03
692	3.91E+03	3.92E+03	3.91E+03	3.97E+03	3.91E+03	3.89E+03	3.93E+03
Biased Statistics							
Average Biased	4.57E+03	4.32E+03	4.16E+03	4.10E+03	3.81E+03	3.96E+03	4.22E+03
Std Dev Biased	3.52E+02	2.80E+02	3.11E+02	2.41E+02	2.49E+02	2.09E+02	2.14E+02
Ps90%/90% (+KTL) Biased	5.53E+03	5.08E+03	5.01E+03	4.77E+03	4.49E+03	4.53E+03	4.80E+03
Ps90%/90% (-KTL) Biased	3.60E+03	3.55E+03	3.31E+03	3.44E+03	3.12E+03	3.39E+03	3.63E+03
Un-Biased Statistics							
Average Un-Biased	4.23E+03	4.11E+03	4.03E+03	3.65E+03	3.39E+03	3.79E+03	4.14E+03
Std Dev Un-Biased	2.79E+02	3.62E+02	3.33E+02	1.97E+02	3.61E+02	3.84E+02	2.64E+02
Ps90%/90% (+KTL) Un-Biased	4.99E+03	5.10E+03	4.94E+03	4.19E+03	4.38E+03	4.84E+03	4.86E+03
Ps90%/90% (-KTL) Un-Biased	3.46E+03	3.11E+03	3.12E+03	3.11E+03	2.40E+03	2.73E+03	3.41E+03
Specification MIN	1.00E+03	5.00E+02	5.00E+02	5.00E+02	5.00E+02	5.00E+02	5.00E+02
Status	PASS	PASS	PASS	PASS	PASS	PASS	PASS

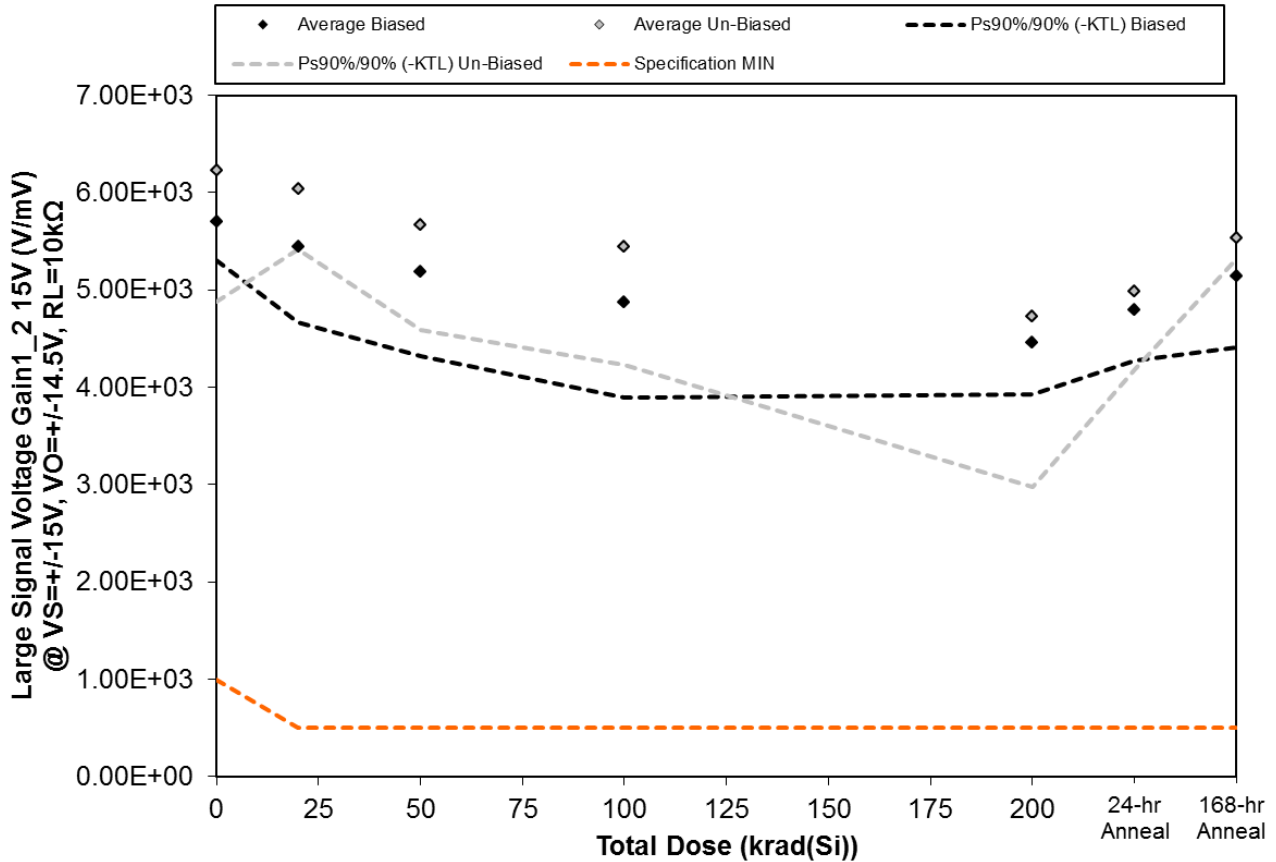

Figure 5.40. Plot of Large Signal Voltage Gain_{1_2 15V} (V/mV) @ VS=±15V, VO=±14.5V, RL=10kΩ versus total dose. The solid diamonds are the average of the measured data points for the samples irradiated under electrical bias while the shaded diamonds are the average of the measured data points for the samples irradiated with all pins tied to ground. The black lines (solid and/or dashed) are the upper and/or lower confidence limits, as determined by KTL statistics, on the samples irradiated under electrical bias while the gray lines (solid and/or dashed) are the upper and/or lower confidence limits, as determined by KTL statistics, on the samples irradiated in the unbiased condition. The red dotted line(s) are the pre- and/or post-irradiation minimum and/or maximum specification value as defined in the datasheet and/or test plan.



TID Report
15-0091 03/20/15 R1.0

Aeroflex RAD
5030 Centennial Blvd.
Colorado Springs, CO 80919
(719) 531-0800

Table 5.40. Raw data for Large Signal Voltage Gain1_2 15V (V/mV) @ VS=+/-15V, VO=+/-14.5V, RL=10kΩ versus total dose, including the statistical analysis, specification and the status of the testing (pass/fail).

Large Signal Voltage Gain1_2 15V (V/mV) @ VS=+/-15V, VO=+/-14.5V, RL=10kΩ	Total Dose (krad(Si))					24-hr Anneal	168-hr Anneal
	0	20	50	100	200		
Device							
680	5.65E+03	5.46E+03	5.50E+03	5.41E+03	4.32E+03	4.79E+03	5.23E+03
681	5.64E+03	5.58E+03	5.51E+03	4.51E+03	4.27E+03	4.73E+03	5.40E+03
682	5.63E+03	4.95E+03	4.77E+03	4.62E+03	4.54E+03	4.57E+03	5.13E+03
683	5.96E+03	5.65E+03	5.08E+03	4.79E+03	4.75E+03	4.77E+03	5.29E+03
684	5.63E+03	5.58E+03	5.08E+03	5.02E+03	4.44E+03	5.09E+03	4.70E+03
685	6.00E+03	6.42E+03	5.44E+03	5.41E+03	4.13E+03	5.28E+03	5.58E+03
686	5.90E+03	6.04E+03	5.31E+03	4.80E+03	5.05E+03	4.60E+03	5.62E+03
688	6.98E+03	5.94E+03	6.07E+03	6.01E+03	5.40E+03	4.82E+03	5.47E+03
689	5.81E+03	5.82E+03	5.41E+03	5.36E+03	5.12E+03	4.97E+03	5.44E+03
690	6.48E+03	5.97E+03	6.13E+03	5.63E+03	3.96E+03	5.25E+03	5.59E+03
691	5.57E+03	5.53E+03	5.40E+03	5.63E+03	5.68E+03	5.60E+03	5.62E+03
692	5.94E+03	6.12E+03	6.20E+03	6.43E+03	5.91E+03	6.36E+03	5.34E+03
Biased Statistics							
Average Biased	5.70E+03	5.44E+03	5.19E+03	4.87E+03	4.46E+03	4.79E+03	5.15E+03
Std Dev Biased	1.45E+02	2.84E+02	3.17E+02	3.56E+02	1.93E+02	1.90E+02	2.70E+02
Ps90%/90% (+KTL) Biased	6.10E+03	6.22E+03	6.06E+03	5.85E+03	4.99E+03	5.31E+03	5.89E+03
Ps90%/90% (-KTL) Biased	5.30E+03	4.67E+03	4.32E+03	3.89E+03	3.93E+03	4.27E+03	4.41E+03
Un-Biased Statistics							
Average Un-Biased	6.23E+03	6.04E+03	5.67E+03	5.44E+03	4.73E+03	4.98E+03	5.54E+03
Std Dev Un-Biased	4.93E+02	2.26E+02	3.94E+02	4.41E+02	6.41E+02	2.90E+02	8.02E+01
Ps90%/90% (+KTL) Un-Biased	7.59E+03	6.66E+03	6.75E+03	6.65E+03	6.49E+03	5.78E+03	5.76E+03
Ps90%/90% (-KTL) Un-Biased	4.88E+03	5.42E+03	4.59E+03	4.23E+03	2.97E+03	4.19E+03	5.32E+03
Specification MIN	1.00E+03	5.00E+02	5.00E+02	5.00E+02	5.00E+02	5.00E+02	5.00E+02
Status	PASS	PASS	PASS	PASS	PASS	PASS	PASS

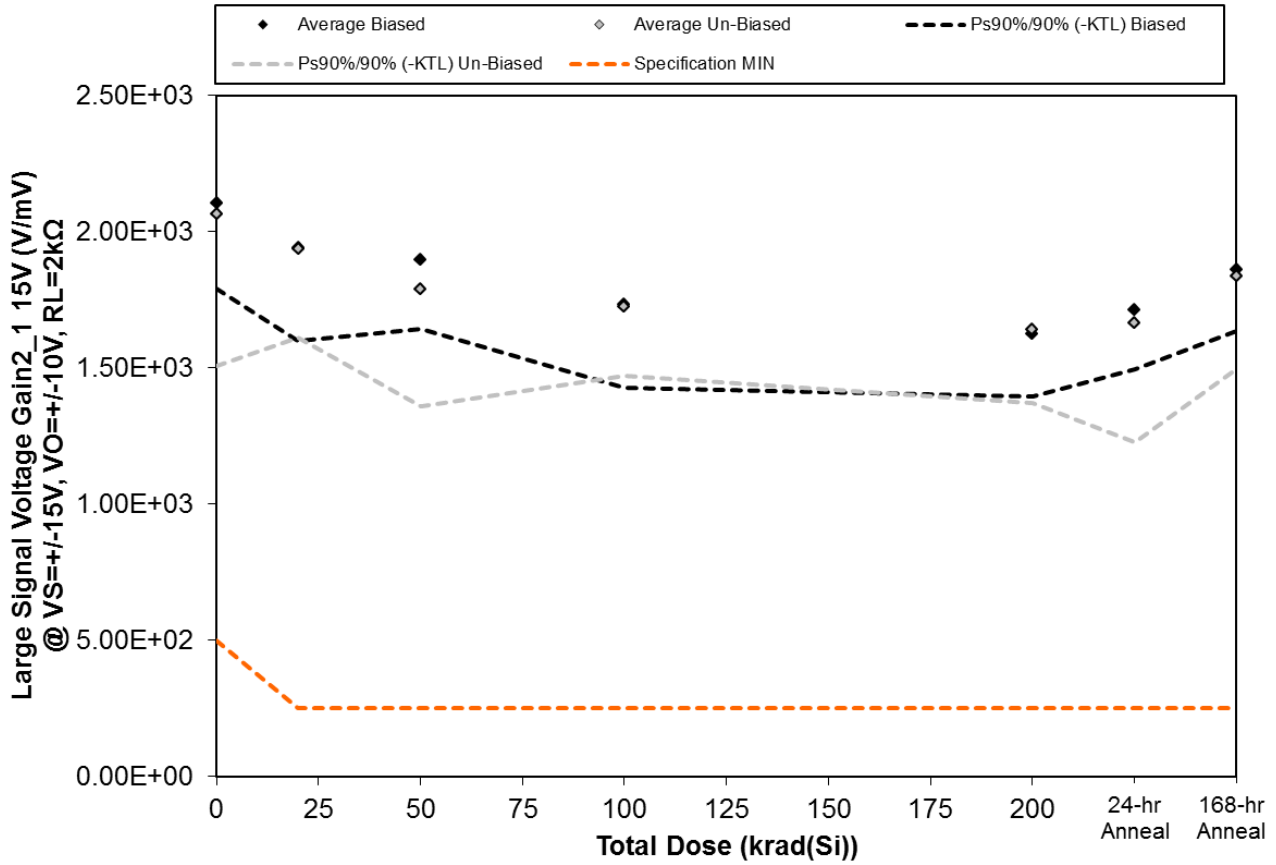

Figure 5.41. Plot of Large Signal Voltage Gain_{2_1} 15V (V/mV) @ VS= \pm 15V, VO= \pm 10V, RL=2k Ω versus total dose. The solid diamonds are the average of the measured data points for the samples irradiated under electrical bias while the shaded diamonds are the average of the measured data points for the samples irradiated with all pins tied to ground. The black lines (solid and/or dashed) are the upper and/or lower confidence limits, as determined by KTL statistics, on the samples irradiated under electrical bias while the gray lines (solid and/or dashed) are the upper and/or lower confidence limits, as determined by KTL statistics, on the samples irradiated in the unbiased condition. The red dotted line(s) are the pre- and/or post-irradiation minimum and/or maximum specification value as defined in the datasheet and/or test plan.



TID Report
15-0091 03/20/15 R1.0

Aeroflex RAD
5030 Centennial Blvd.
Colorado Springs, CO 80919
(719) 531-0800

Table 5.41. Raw data for Large Signal Voltage Gain2_1 15V (V/mV) @ VS=+/-15V, VO=+/-10V, RL=2kΩ versus total dose, including the statistical analysis, specification and the status of the testing (pass/fail).

Large Signal Voltage Gain2_1 15V (V/mV) @ VS=+/-15V, VO=+/-10V, RL=2kΩ	Total Dose (krad(Si))					24-hr	168-hr
	0	20	50	100	200	Anneal	Anneal
Device							
680	2.01E+03	1.92E+03	1.86E+03	1.72E+03	1.56E+03	1.71E+03	1.86E+03
681	2.23E+03	2.15E+03	1.99E+03	1.89E+03	1.75E+03	1.83E+03	1.95E+03
682	2.00E+03	1.82E+03	1.78E+03	1.60E+03	1.54E+03	1.63E+03	1.75E+03
683	2.23E+03	1.88E+03	2.00E+03	1.79E+03	1.65E+03	1.74E+03	1.92E+03
684	2.07E+03	1.96E+03	1.86E+03	1.68E+03	1.61E+03	1.66E+03	1.81E+03
685	1.78E+03	1.75E+03	1.60E+03	1.63E+03	1.49E+03	1.39E+03	1.64E+03
686	1.95E+03	1.92E+03	1.67E+03	1.64E+03	1.64E+03	1.75E+03	1.83E+03
688	2.13E+03	2.05E+03	1.97E+03	1.84E+03	1.63E+03	1.80E+03	1.98E+03
689	2.18E+03	2.02E+03	1.92E+03	1.79E+03	1.73E+03	1.70E+03	1.84E+03
690	2.30E+03	1.95E+03	1.79E+03	1.71E+03	1.72E+03	1.68E+03	1.89E+03
691	2.03E+03	2.01E+03	2.03E+03	2.03E+03	1.98E+03	2.01E+03	2.01E+03
692	1.90E+03	1.91E+03	1.90E+03	1.89E+03	1.89E+03	1.89E+03	1.93E+03
Biased Statistics							
Average Biased	2.11E+03	1.94E+03	1.90E+03	1.73E+03	1.62E+03	1.71E+03	1.86E+03
Std Dev Biased	1.14E+02	1.25E+02	9.31E+01	1.12E+02	8.34E+01	7.98E+01	8.21E+01
Ps90%/90% (+KTL) Biased	2.42E+03	2.29E+03	2.15E+03	2.04E+03	1.85E+03	1.93E+03	2.08E+03
Ps90%/90% (-KTL) Biased	1.79E+03	1.60E+03	1.64E+03	1.43E+03	1.39E+03	1.50E+03	1.63E+03
Un-Biased Statistics							
Average Un-Biased	2.07E+03	1.94E+03	1.79E+03	1.72E+03	1.64E+03	1.66E+03	1.84E+03
Std Dev Un-Biased	2.04E+02	1.19E+02	1.56E+02	9.26E+01	9.90E+01	1.60E+02	1.24E+02
Ps90%/90% (+KTL) Un-Biased	2.63E+03	2.26E+03	2.22E+03	1.98E+03	1.91E+03	2.10E+03	2.18E+03
Ps90%/90% (-KTL) Un-Biased	1.51E+03	1.61E+03	1.36E+03	1.47E+03	1.37E+03	1.23E+03	1.50E+03
Specification MIN	5.00E+02	2.50E+02	2.50E+02	2.50E+02	2.50E+02	2.50E+02	2.50E+02
Status	PASS	PASS	PASS	PASS	PASS	PASS	PASS

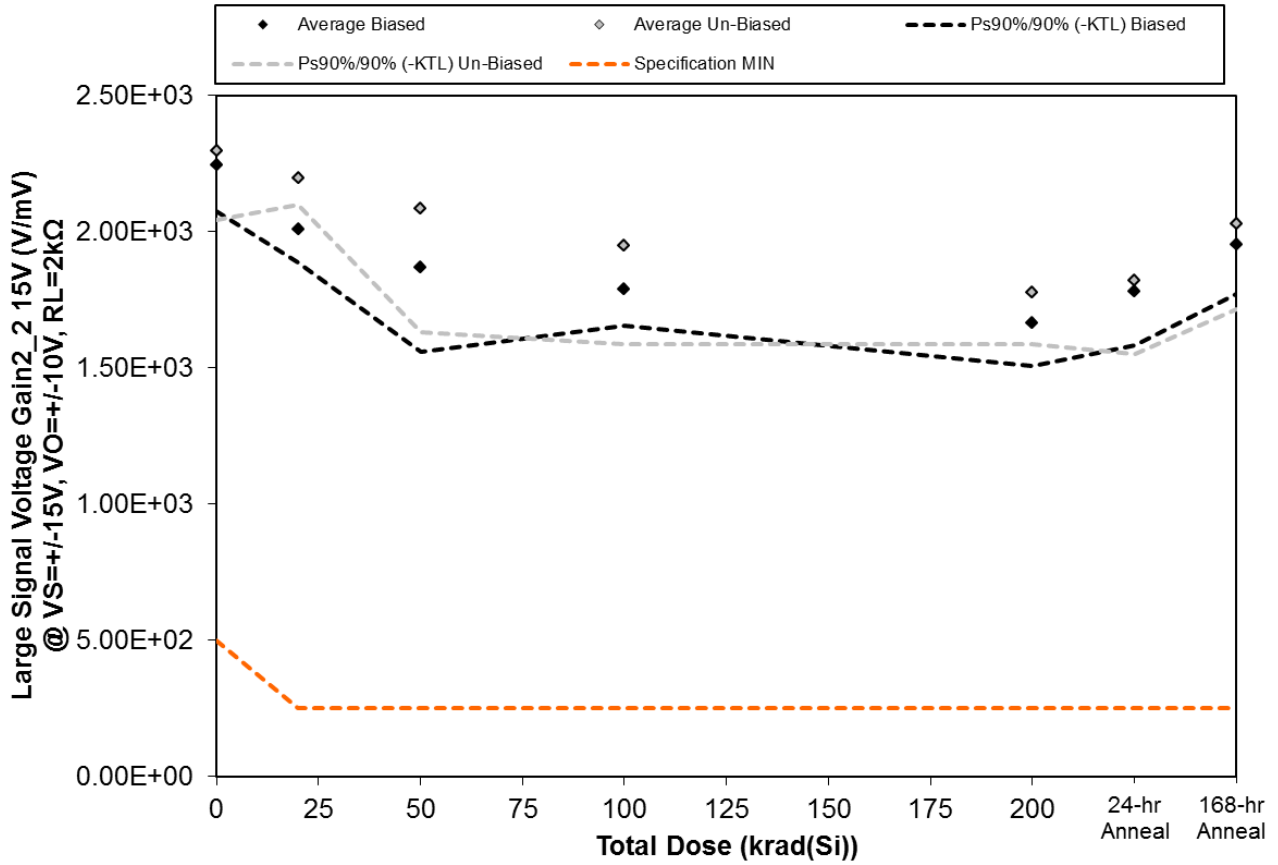

Figure 5.42. Plot of Large Signal Voltage Gain_{2_2} 15V (V/mV) @ VS=±15V, VO=±10V, RL=2kΩ versus total dose. The solid diamonds are the average of the measured data points for the samples irradiated under electrical bias while the shaded diamonds are the average of the measured data points for the samples irradiated with all pins tied to ground. The black lines (solid and/or dashed) are the upper and/or lower confidence limits, as determined by KTL statistics, on the samples irradiated under electrical bias while the gray lines (solid and/or dashed) are the upper and/or lower confidence limits, as determined by KTL statistics, on the samples irradiated in the unbiased condition. The red dotted line(s) are the pre- and/or post-irradiation minimum and/or maximum specification value as defined in the datasheet and/or test plan.



TID Report
15-0091 03/20/15 R1.0

Aeroflex RAD
5030 Centennial Blvd.
Colorado Springs, CO 80919
(719) 531-0800

Table 5.42. Raw data for Large Signal Voltage Gain2_2 15V (V/mV) @ VS=+/-15V, VO=+/-10V, RL=2kΩ versus total dose, including the statistical analysis, specification and the status of the testing (pass/fail).

Large Signal Voltage Gain2_2 15V (V/mV) @ VS=+/-15V, VO=+/-10V, RL=2kΩ	Total Dose (krad(Si))					24-hr Anneal	168-hr Anneal
	0	20	50	100	200		
Device							
680	2.30E+03	2.08E+03	1.67E+03	1.73E+03	1.60E+03	1.75E+03	1.93E+03
681	2.27E+03	2.00E+03	1.90E+03	1.79E+03	1.76E+03	1.70E+03	2.01E+03
682	2.15E+03	1.96E+03	1.87E+03	1.79E+03	1.66E+03	1.74E+03	2.04E+03
683	2.29E+03	2.02E+03	1.96E+03	1.86E+03	1.68E+03	1.88E+03	1.91E+03
684	2.21E+03	1.99E+03	1.93E+03	1.77E+03	1.65E+03	1.82E+03	1.88E+03
685	2.30E+03	2.14E+03	2.00E+03	1.88E+03	1.67E+03	1.78E+03	1.89E+03
686	2.24E+03	2.20E+03	2.17E+03	2.04E+03	1.81E+03	1.72E+03	1.99E+03
688	2.46E+03	2.24E+03	2.29E+03	2.10E+03	1.85E+03	1.86E+03	2.21E+03
689	2.23E+03	2.21E+03	2.12E+03	1.95E+03	1.80E+03	1.97E+03	2.05E+03
690	2.27E+03	2.20E+03	1.85E+03	1.77E+03	1.76E+03	1.78E+03	2.01E+03
691	2.11E+03	2.11E+03	2.12E+03	2.12E+03	2.15E+03	2.09E+03	2.07E+03
692	2.26E+03	2.29E+03	2.13E+03	2.13E+03	2.22E+03	2.19E+03	2.35E+03
Biased Statistics							
Average Biased	2.24E+03	2.01E+03	1.87E+03	1.79E+03	1.67E+03	1.78E+03	1.95E+03
Std Dev Biased	6.13E+01	4.55E+01	1.13E+02	4.85E+01	5.80E+01	7.11E+01	6.59E+01
Ps90%/90% (+KTL) Biased	2.41E+03	2.13E+03	2.18E+03	1.92E+03	1.83E+03	1.97E+03	2.13E+03
Ps90%/90% (-KTL) Biased	2.07E+03	1.88E+03	1.56E+03	1.65E+03	1.51E+03	1.58E+03	1.77E+03
Un-Biased Statistics							
Average Un-Biased	2.30E+03	2.20E+03	2.08E+03	1.95E+03	1.78E+03	1.82E+03	2.03E+03
Std Dev Un-Biased	9.23E+01	3.59E+01	1.66E+02	1.31E+02	6.86E+01	9.84E+01	1.15E+02
Ps90%/90% (+KTL) Un-Biased	2.55E+03	2.30E+03	2.54E+03	2.31E+03	1.96E+03	2.09E+03	2.35E+03
Ps90%/90% (-KTL) Un-Biased	2.04E+03	2.10E+03	1.63E+03	1.59E+03	1.59E+03	1.55E+03	1.71E+03
Specification MIN	5.00E+02	2.50E+02	2.50E+02	2.50E+02	2.50E+02	2.50E+02	2.50E+02
Status	PASS	PASS	PASS	PASS	PASS	PASS	PASS

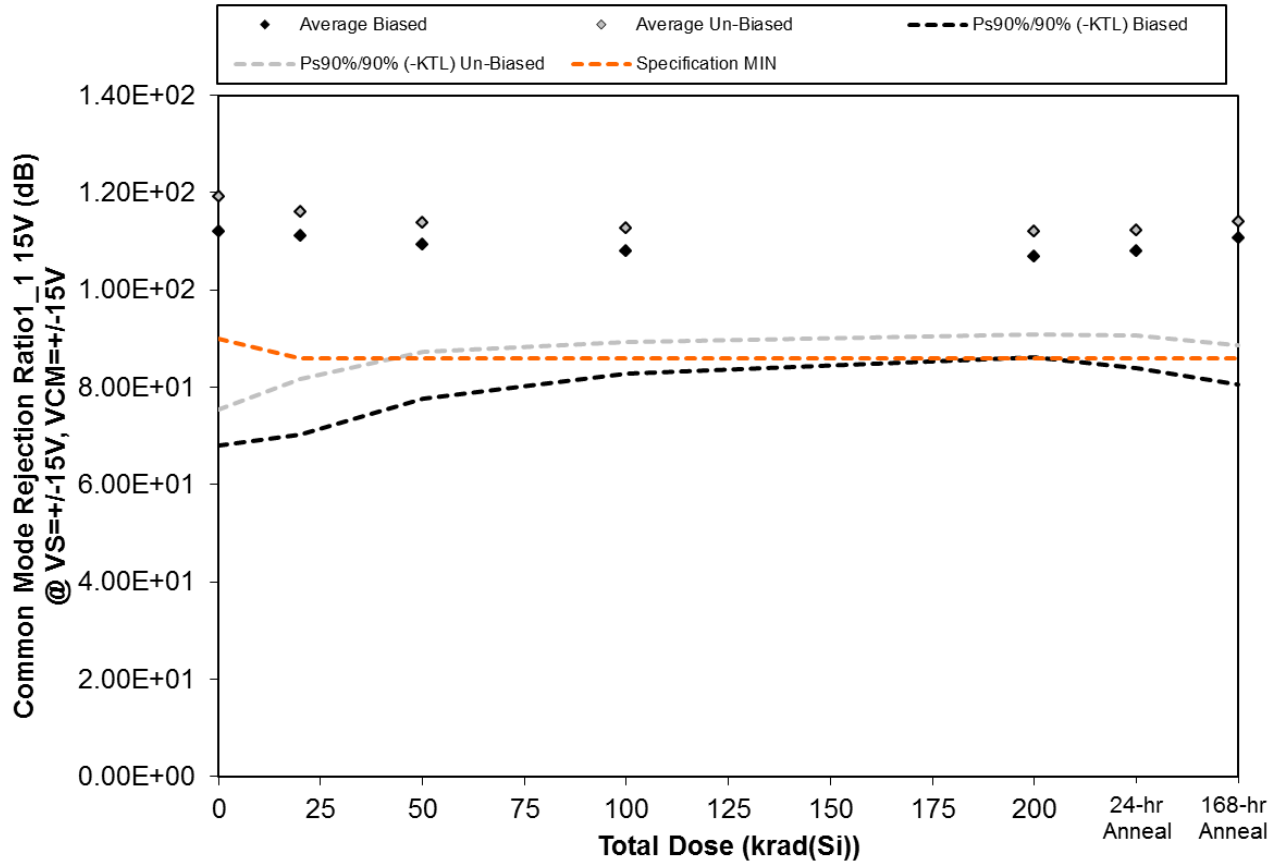

Figure 5.43. Plot of Common Mode Rejection Ratio_{1_1} 15V (dB) @ VS=±15V, VCM=±15V versus total dose. The solid diamonds are the average of the measured data points for the samples irradiated under electrical bias while the shaded diamonds are the average of the measured data points for the samples irradiated with all pins tied to ground. The black lines (solid and/or dashed) are the upper and/or lower confidence limits, as determined by KTL statistics, on the samples irradiated under electrical bias while the gray lines (solid and/or dashed) are the upper and/or lower confidence limits, as determined by KTL statistics, on the samples irradiated in the unbiased condition. The red dotted line(s) are the pre- and/or post-irradiation minimum and/or maximum specification value as defined in the datasheet and/or test plan.



TID Report
15-0091 03/20/15 R1.0

Aeroflex RAD
5030 Centennial Blvd.
Colorado Springs, CO 80919
(719) 531-0800

Table 5.43. Raw data for Common Mode Rejection Ratio1_1 15V (dB) @ VS=+/-15V, VCM=+/-15V versus total dose, including the statistical analysis, specification and the status of the testing (pass/fail).

Common Mode Rejection Ratio1_1 15V (dB) @ VS=+/-15V, VCM=+/-15V	Total Dose (krad(Si))					24-hr	168-hr
	0	20	50	100	200	Anneal	Anneal
Device							
680	1.10E+02	1.09E+02	1.08E+02	1.08E+02	1.07E+02	1.08E+02	1.11E+02
681	1.04E+02	1.04E+02	1.04E+02	1.04E+02	1.04E+02	1.04E+02	1.04E+02
682	1.05E+02	1.04E+02	1.04E+02	1.04E+02	1.03E+02	1.04E+02	1.06E+02
683	1.01E+02	1.01E+02	1.01E+02	1.02E+02	1.01E+02	1.02E+02	1.02E+02
684	1.40E+02	1.38E+02	1.30E+02	1.24E+02	1.20E+02	1.23E+02	1.29E+02
685	1.29E+02	1.23E+02	1.19E+02	1.17E+02	1.14E+02	1.15E+02	1.17E+02
686	1.08E+02	1.08E+02	1.09E+02	1.10E+02	1.11E+02	1.11E+02	1.09E+02
688	1.00E+02	9.98E+01	9.97E+01	9.95E+01	9.93E+01	9.94E+01	1.00E+02
689	1.19E+02	1.18E+02	1.17E+02	1.17E+02	1.16E+02	1.16E+02	1.20E+02
690	1.40E+02	1.32E+02	1.24E+02	1.22E+02	1.19E+02	1.20E+02	1.24E+02
691	1.21E+02	1.21E+02	1.21E+02	1.21E+02	1.21E+02	1.21E+02	1.21E+02
692	1.03E+02	1.03E+02	1.03E+02	1.03E+02	1.03E+02	1.03E+02	1.03E+02
Biased Statistics							
Average Biased	1.12E+02	1.11E+02	1.09E+02	1.08E+02	1.07E+02	1.08E+02	1.11E+02
Std Dev Biased	1.61E+01	1.50E+01	1.16E+01	9.19E+00	7.56E+00	8.79E+00	1.10E+01
Ps90%/90% (+KTL) Biased	1.56E+02	1.52E+02	1.41E+02	1.33E+02	1.28E+02	1.32E+02	1.41E+02
Ps90%/90% (-KTL) Biased	6.80E+01	7.02E+01	7.77E+01	8.29E+01	8.62E+01	8.40E+01	8.05E+01
Un-Biased Statistics							
Average Un-Biased	1.19E+02	1.16E+02	1.14E+02	1.13E+02	1.12E+02	1.12E+02	1.14E+02
Std Dev Un-Biased	1.60E+01	1.25E+01	9.67E+00	8.55E+00	7.67E+00	7.88E+00	9.25E+00
Ps90%/90% (+KTL) Un-Biased	1.63E+02	1.50E+02	1.40E+02	1.36E+02	1.33E+02	1.34E+02	1.39E+02
Ps90%/90% (-KTL) Un-Biased	7.54E+01	8.17E+01	8.74E+01	8.94E+01	9.10E+01	9.07E+01	8.86E+01
Specification MIN	9.00E+01	8.60E+01	8.60E+01	8.60E+01	8.60E+01	8.60E+01	8.60E+01
Status	PASS	PASS	PASS	PASS	PASS	PASS	PASS

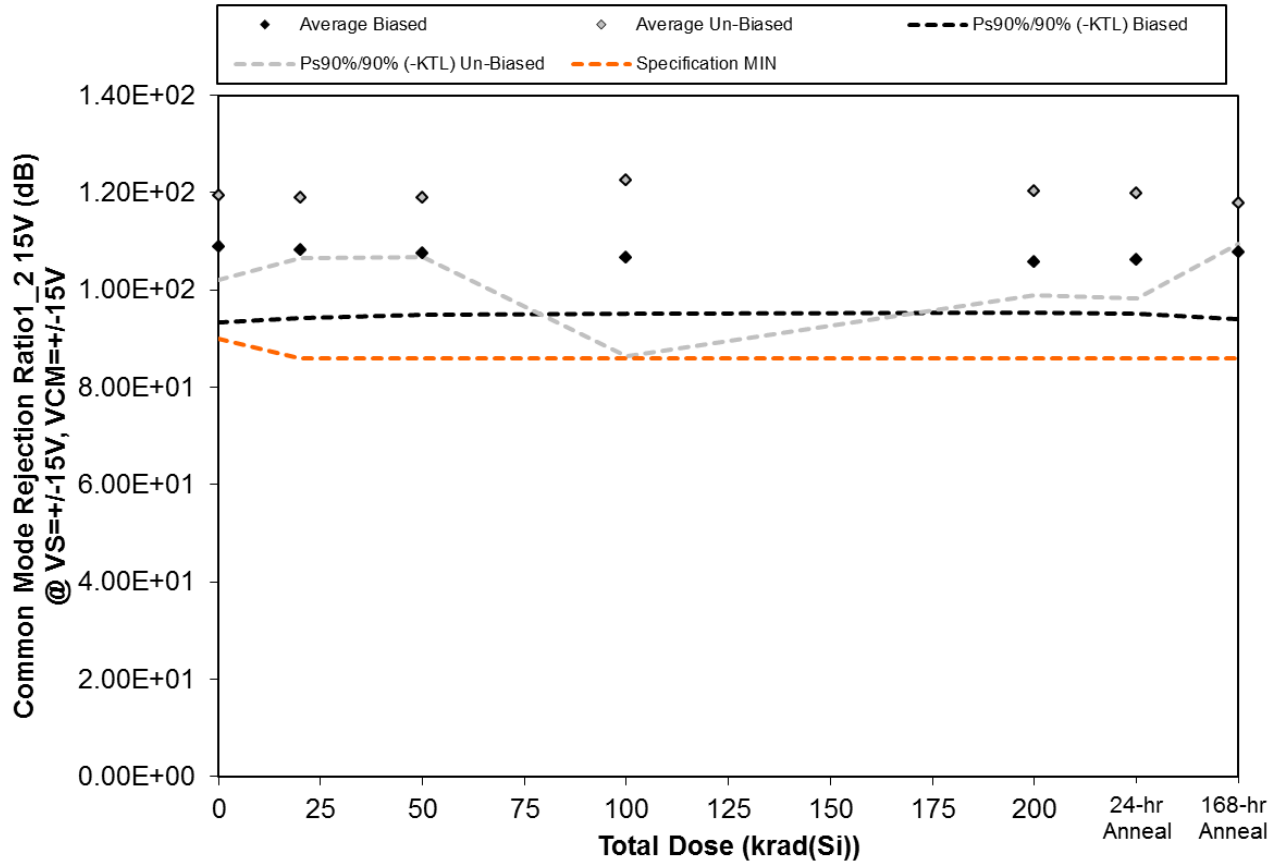

Figure 5.44. Plot of Common Mode Rejection Ratio_{1_2} 15V (dB) @ VS= \pm 15V, VCM= \pm 15V versus total dose. The solid diamonds are the average of the measured data points for the samples irradiated under electrical bias while the shaded diamonds are the average of the measured data points for the samples irradiated with all pins tied to ground. The black lines (solid and/or dashed) are the upper and/or lower confidence limits, as determined by KTL statistics, on the samples irradiated under electrical bias while the gray lines (solid and/or dashed) are the upper and/or lower confidence limits, as determined by KTL statistics, on the samples irradiated in the unbiased condition. The red dotted line(s) are the pre- and/or post-irradiation minimum and/or maximum specification value as defined in the datasheet and/or test plan.



TID Report
15-0091 03/20/15 R1.0

Aeroflex RAD
5030 Centennial Blvd.
Colorado Springs, CO 80919
(719) 531-0800

Table 5.44. Raw data for Common Mode Rejection Ratio1_2 15V (dB) @ VS=+/-15V, VCM=+/-15V versus total dose, including the statistical analysis, specification and the status of the testing (pass/fail).

Common Mode Rejection Ratio1_2 15V (dB) @ VS=+/-15V, VCM=+/-15V	Total Dose (krad(Si))					24-hr	168-hr
	0	20	50	100	200	Anneal	Anneal
Device							
680	1.11E+02	1.11E+02	1.10E+02	1.09E+02	1.08E+02	1.09E+02	1.10E+02
681	1.11E+02	1.11E+02	1.10E+02	1.09E+02	1.08E+02	1.09E+02	1.11E+02
682	1.04E+02	1.04E+02	1.03E+02	1.03E+02	1.02E+02	1.03E+02	1.03E+02
683	1.16E+02	1.14E+02	1.12E+02	1.11E+02	1.09E+02	1.10E+02	1.13E+02
684	1.03E+02	1.02E+02	1.02E+02	1.01E+02	1.01E+02	1.01E+02	1.02E+02
685	1.20E+02	1.22E+02	1.26E+02	1.46E+02	1.33E+02	1.33E+02	1.23E+02
686	1.20E+02	1.18E+02	1.16E+02	1.14E+02	1.13E+02	1.13E+02	1.16E+02
688	1.14E+02	1.15E+02	1.16E+02	1.16E+02	1.18E+02	1.17E+02	1.16E+02
689	1.15E+02	1.16E+02	1.17E+02	1.19E+02	1.22E+02	1.20E+02	1.17E+02
690	1.30E+02	1.26E+02	1.20E+02	1.18E+02	1.16E+02	1.16E+02	1.19E+02
691	1.17E+02	1.17E+02	1.17E+02	1.17E+02	1.17E+02	1.17E+02	1.17E+02
692	1.06E+02	1.06E+02	1.06E+02	1.06E+02	1.06E+02	1.06E+02	1.06E+02
Biased Statistics							
Average Biased	1.09E+02	1.08E+02	1.08E+02	1.07E+02	1.06E+02	1.06E+02	1.08E+02
Std Dev Biased	5.66E+00	5.10E+00	4.60E+00	4.16E+00	3.82E+00	4.06E+00	4.98E+00
Ps90%/90% (+KTL) Biased	1.25E+02	1.22E+02	1.20E+02	1.18E+02	1.16E+02	1.17E+02	1.21E+02
Ps90%/90% (-KTL) Biased	9.35E+01	9.42E+01	9.49E+01	9.52E+01	9.53E+01	9.52E+01	9.41E+01
Un-Biased Statistics							
Average Un-Biased	1.19E+02	1.19E+02	1.19E+02	1.23E+02	1.20E+02	1.20E+02	1.18E+02
Std Dev Un-Biased	6.33E+00	4.55E+00	4.47E+00	1.32E+01	7.79E+00	7.90E+00	3.10E+00
Ps90%/90% (+KTL) Un-Biased	1.37E+02	1.31E+02	1.31E+02	1.59E+02	1.42E+02	1.42E+02	1.26E+02
Ps90%/90% (-KTL) Un-Biased	1.02E+02	1.07E+02	1.07E+02	8.65E+01	9.90E+01	9.82E+01	1.09E+02
Specification MIN	9.00E+01	8.60E+01	8.60E+01	8.60E+01	8.60E+01	8.60E+01	8.60E+01
Status	PASS	PASS	PASS	PASS	PASS	PASS	PASS

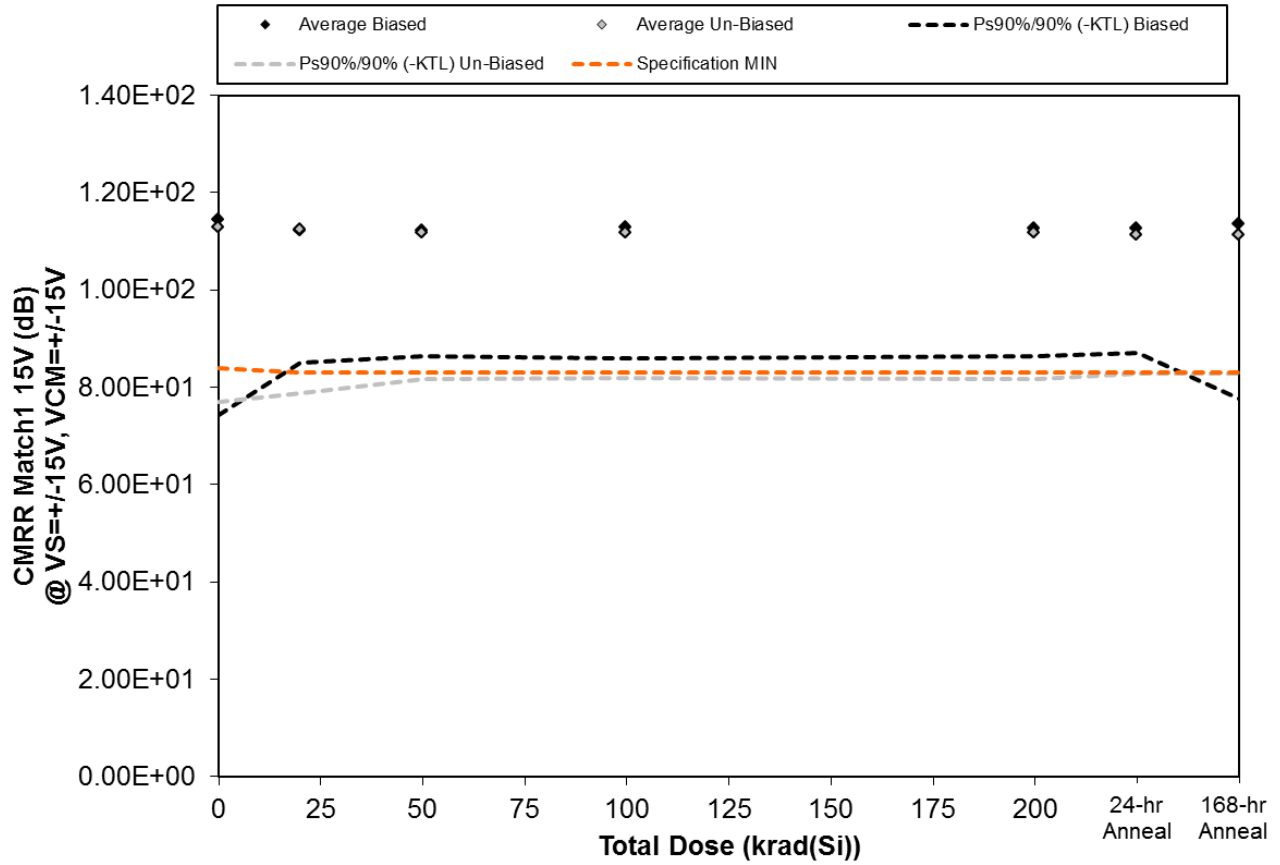

Figure 5.45. Plot of CMRR Match1 15V (dB) @ VS=+-15V, VCM=+-15V versus total dose. The solid diamonds are the average of the measured data points for the samples irradiated under electrical bias while the shaded diamonds are the average of the measured data points for the samples irradiated with all pins tied to ground. The black lines (solid and/or dashed) are the upper and/or lower confidence limits, as determined by KTL statistics, on the samples irradiated under electrical bias while the gray lines (solid and/or dashed) are the upper and/or lower confidence limits, as determined by KTL statistics, on the samples irradiated in the unbiased condition. The red dotted line(s) are the pre- and/or post-irradiation minimum and/or maximum specification value as defined in the datasheet and/or test plan.



TID Report
15-0091 03/20/15 R1.0

Aeroflex RAD
5030 Centennial Blvd.
Colorado Springs, CO 80919
(719) 531-0800

Table 5.45. Raw data for CMRR Match1 15V (dB) @ VS=+/-15V, VCM=+/-15V versus total dose, including the statistical analysis, specification and the status of the testing (pass/fail).

CMRR Match1 15V (dB) @ VS=+/-15V, VCM=+/-15V	Total Dose (krad(Si))					24-hr Anneal	168-hr Anneal
	0	20	50	100	200		
Device							
680	1.38E+02	1.25E+02	1.22E+02	1.22E+02	1.21E+02	1.22E+02	1.35E+02
681	1.10E+02	1.10E+02	1.11E+02	1.11E+02	1.11E+02	1.12E+02	1.09E+02
682	1.19E+02	1.20E+02	1.22E+02	1.24E+02	1.25E+02	1.23E+02	1.17E+02
683	1.03E+02	1.04E+02	1.04E+02	1.05E+02	1.06E+02	1.05E+02	1.05E+02
684	1.03E+02	1.02E+02	1.02E+02	1.02E+02	1.02E+02	1.02E+02	1.02E+02
685	1.17E+02	1.17E+02	1.16E+02	1.16E+02	1.15E+02	1.16E+02	1.14E+02
686	1.06E+02	1.06E+02	1.06E+02	1.06E+02	1.06E+02	1.06E+02	1.06E+02
688	9.86E+01	9.85E+01	9.85E+01	9.84E+01	9.83E+01	9.82E+01	9.88E+01
689	1.10E+02	1.11E+02	1.11E+02	1.12E+02	1.12E+02	1.12E+02	1.12E+02
690	1.33E+02	1.31E+02	1.28E+02	1.27E+02	1.28E+02	1.26E+02	1.27E+02
691	1.13E+02	1.13E+02	1.13E+02	1.13E+02	1.13E+02	1.13E+02	1.13E+02
692	1.15E+02	1.15E+02	1.15E+02	1.15E+02	1.15E+02	1.15E+02	1.15E+02
Biased Statistics							
Average Biased	1.14E+02	1.12E+02	1.12E+02	1.13E+02	1.13E+02	1.13E+02	1.14E+02
Std Dev Biased	1.46E+01	9.89E+00	9.45E+00	9.78E+00	9.63E+00	9.33E+00	1.31E+01
Ps90%/90% (+KTL) Biased	1.54E+02	1.39E+02	1.38E+02	1.40E+02	1.39E+02	1.38E+02	1.50E+02
Ps90%/90% (-KTL) Biased	7.44E+01	8.51E+01	8.63E+01	8.60E+01	8.64E+01	8.71E+01	7.76E+01
Un-Biased Statistics							
Average Un-Biased	1.13E+02	1.13E+02	1.12E+02	1.12E+02	1.12E+02	1.11E+02	1.11E+02
Std Dev Un-Biased	1.31E+01	1.23E+01	1.10E+01	1.09E+01	1.10E+01	1.04E+01	1.04E+01
Ps90%/90% (+KTL) Un-Biased	1.49E+02	1.46E+02	1.42E+02	1.42E+02	1.42E+02	1.40E+02	1.40E+02
Ps90%/90% (-KTL) Un-Biased	7.70E+01	7.87E+01	8.17E+01	8.19E+01	8.18E+01	8.29E+01	8.29E+01
Specification MIN	8.40E+01	8.30E+01	8.30E+01	8.30E+01	8.30E+01	8.30E+01	8.30E+01
Status	PASS	PASS	PASS	PASS	PASS	PASS	PASS

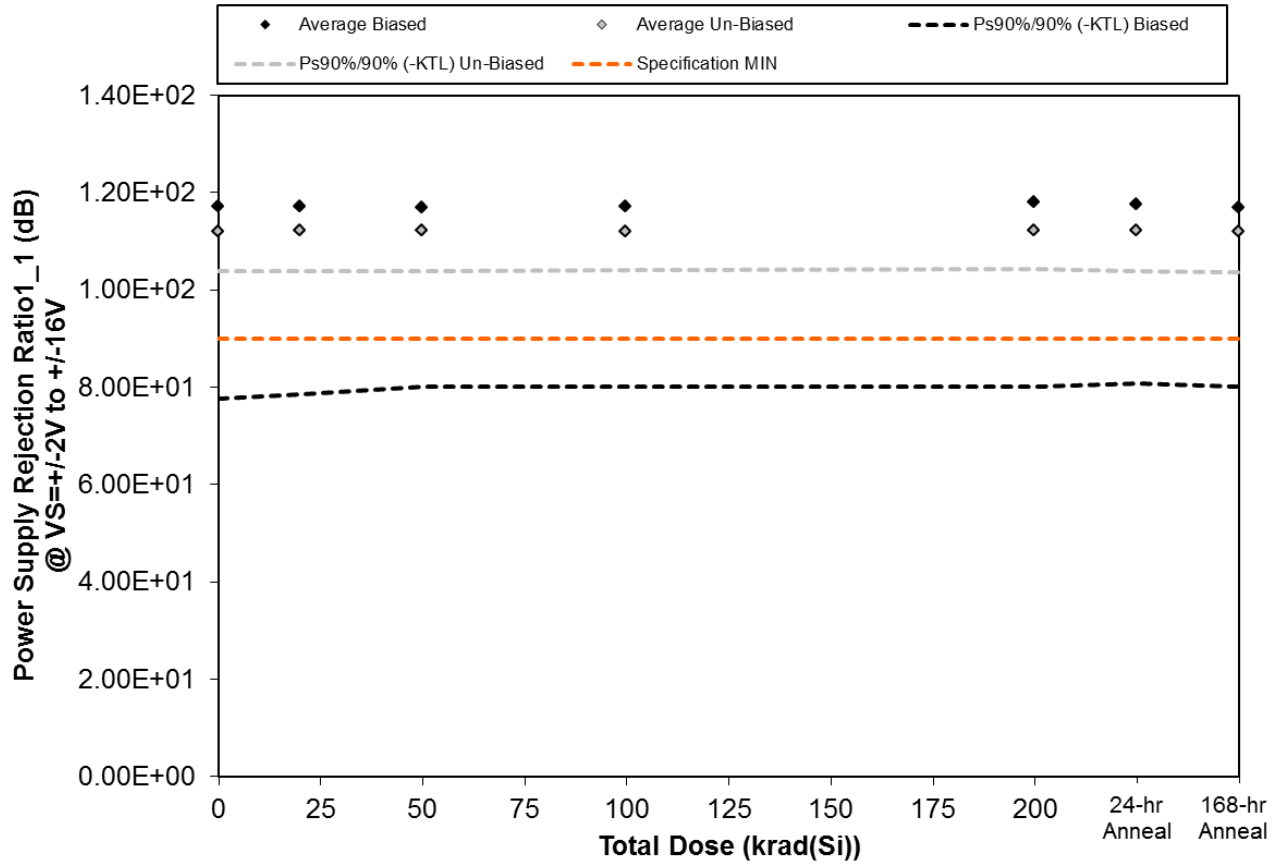

Figure 5.46. Plot of Power Supply Rejection Ratio1_1 (dB) @ VS=+-2V to +/-16V versus total dose. The solid diamonds are the average of the measured data points for the samples irradiated under electrical bias while the shaded diamonds are the average of the measured data points for the samples irradiated with all pins tied to ground. The black lines (solid and/or dashed) are the upper and/or lower confidence limits, as determined by KTL statistics, on the samples irradiated under electrical bias while the gray lines (solid and/or dashed) are the upper and/or lower confidence limits, as determined by KTL statistics, on the samples irradiated in the unbiased condition. The red dotted line(s) are the pre- and/or post-irradiation minimum and/or maximum specification value as defined in the datasheet and/or test plan.



TID Report
15-0091 03/20/15 R1.0

Aeroflex RAD
5030 Centennial Blvd.
Colorado Springs, CO 80919
(719) 531-0800

Table 5.46. Raw data for Power Supply Rejection Ratio1_1 (dB) @ VS=+-2V to +/-16V versus total dose, including the statistical analysis, specification and the status of the testing (pass/fail).

Power Supply Rejection Ratio1_1 (dB) @ VS=+-2V to +/-16V	Total Dose (krad(Si))					24-hr Anneal	168-hr Anneal
	0	20	50	100	200		
Device							
680	1.20E+02	1.21E+02	1.22E+02	1.22E+02	1.26E+02	1.25E+02	1.22E+02
681	1.06E+02	1.06E+02	1.06E+02	1.06E+02	1.06E+02	1.06E+02	1.06E+02
682	1.06E+02	1.06E+02	1.06E+02	1.06E+02	1.06E+02	1.06E+02	1.06E+02
683	1.41E+02	1.40E+02	1.38E+02	1.38E+02	1.38E+02	1.37E+02	1.38E+02
684	1.14E+02	1.14E+02	1.14E+02	1.14E+02	1.14E+02	1.14E+02	1.14E+02
685	1.11E+02	1.11E+02	1.11E+02	1.11E+02	1.11E+02	1.11E+02	1.11E+02
686	1.17E+02	1.17E+02	1.17E+02	1.17E+02	1.17E+02	1.17E+02	1.17E+02
688	1.11E+02	1.11E+02	1.11E+02	1.11E+02	1.12E+02	1.11E+02	1.11E+02
689	1.12E+02	1.13E+02	1.13E+02	1.13E+02	1.13E+02	1.13E+02	1.13E+02
690	1.09E+02	1.09E+02	1.09E+02	1.09E+02	1.09E+02	1.09E+02	1.09E+02
691	1.30E+02	1.30E+02	1.30E+02	1.30E+02	1.30E+02	1.30E+02	1.30E+02
692	1.14E+02	1.14E+02	1.14E+02	1.14E+02	1.14E+02	1.14E+02	1.14E+02
Biased Statistics							
Average Biased	1.17E+02	1.17E+02	1.17E+02	1.17E+02	1.18E+02	1.18E+02	1.17E+02
Std Dev Biased	1.44E+01	1.41E+01	1.34E+01	1.35E+01	1.39E+01	1.35E+01	1.34E+01
Ps90%/90% (+KTL) Biased	1.57E+02	1.56E+02	1.54E+02	1.54E+02	1.56E+02	1.54E+02	1.54E+02
Ps90%/90% (-KTL) Biased	7.76E+01	7.85E+01	8.02E+01	8.01E+01	8.01E+01	8.07E+01	8.02E+01
Un-Biased Statistics							
Average Un-Biased	1.12E+02	1.12E+02	1.12E+02	1.12E+02	1.12E+02	1.12E+02	1.12E+02
Std Dev Un-Biased	3.02E+00	3.00E+00	3.01E+00	2.92E+00	2.92E+00	3.06E+00	3.03E+00
Ps90%/90% (+KTL) Un-Biased	1.20E+02	1.20E+02	1.20E+02	1.20E+02	1.20E+02	1.21E+02	1.20E+02
Ps90%/90% (-KTL) Un-Biased	1.04E+02	1.04E+02	1.04E+02	1.04E+02	1.04E+02	1.04E+02	1.04E+02
Specification MIN	9.00E+01	9.00E+01	9.00E+01	9.00E+01	9.00E+01	9.00E+01	9.00E+01
Status	PASS	PASS	PASS	PASS	PASS	PASS	PASS

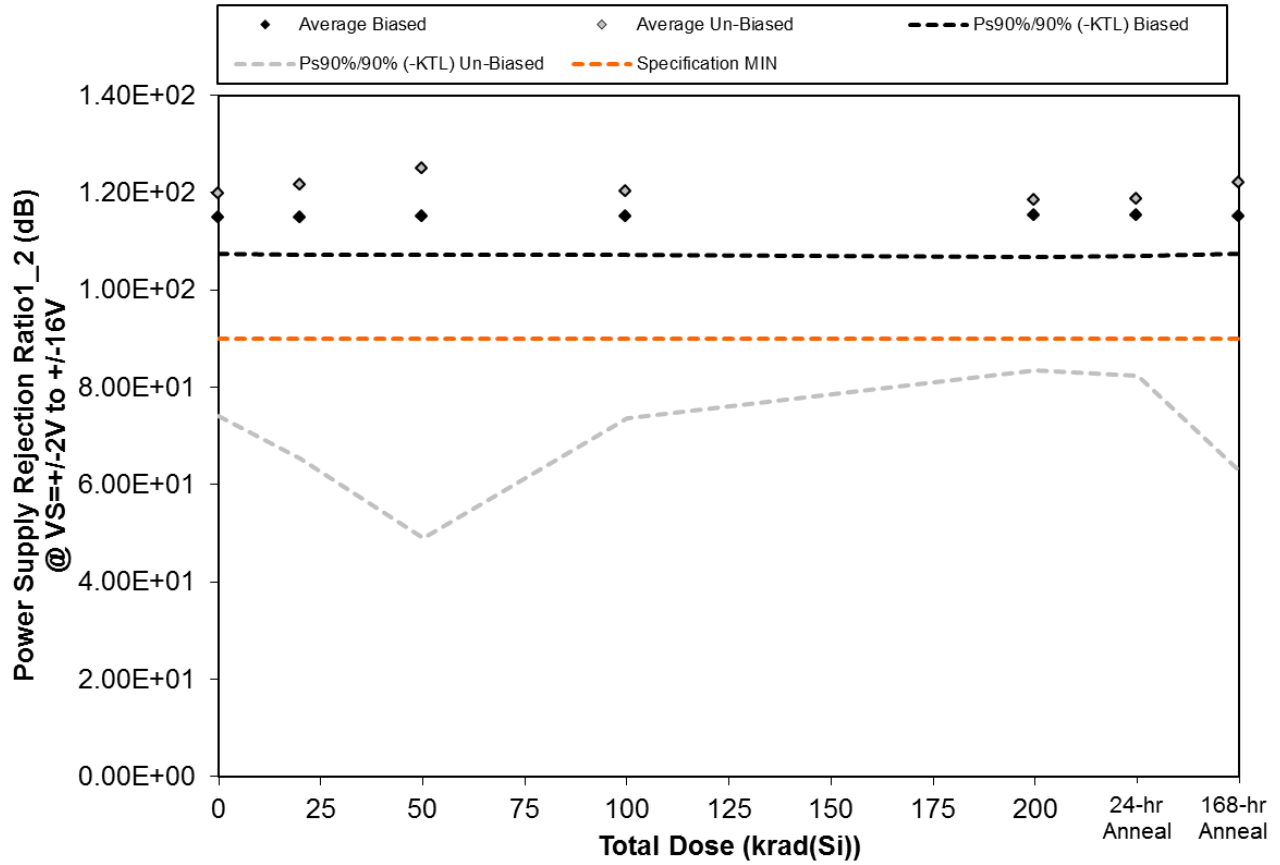

Figure 5.47. Plot of Power Supply Rejection Ratio1_2 (dB) @ VS=+-2V to +/-16V versus total dose. The solid diamonds are the average of the measured data points for the samples irradiated under electrical bias while the shaded diamonds are the average of the measured data points for the samples irradiated with all pins tied to ground. The black lines (solid and/or dashed) are the upper and/or lower confidence limits, as determined by KTL statistics, on the samples irradiated under electrical bias while the gray lines (solid and/or dashed) are the upper and/or lower confidence limits, as determined by KTL statistics, on the samples irradiated in the unbiased condition. The red dotted line(s) are the pre- and/or post-irradiation minimum and/or maximum specification value as defined in the datasheet and/or test plan.



TID Report
15-0091 03/20/15 R1.0

Aeroflex RAD
5030 Centennial Blvd.
Colorado Springs, CO 80919
(719) 531-0800

Table 5.47. Raw data for Power Supply Rejection Ratio1_2 (dB) @ VS=+-2V to +/-16V versus total dose, including the statistical analysis, specification and the status of the testing (pass/fail).

Power Supply Rejection Ratio1_2 (dB) @ VS=+-2V to +/-16V	Total Dose (krad(Si))					24-hr Anneal	168-hr Anneal
	0	20	50	100	200		
Device							
680	1.17E+02	1.17E+02	1.17E+02	1.17E+02	1.17E+02	1.17E+02	1.17E+02
681	1.16E+02	1.16E+02	1.16E+02	1.16E+02	1.16E+02	1.16E+02	1.16E+02
682	1.15E+02	1.15E+02	1.14E+02	1.14E+02	1.14E+02	1.14E+02	1.15E+02
683	1.10E+02	1.10E+02	1.11E+02	1.11E+02	1.11E+02	1.11E+02	1.11E+02
684	1.17E+02	1.18E+02	1.18E+02	1.18E+02	1.19E+02	1.19E+02	1.18E+02
685	1.15E+02	1.15E+02	1.15E+02	1.16E+02	1.16E+02	1.16E+02	1.15E+02
686	1.50E+02	1.58E+02	1.75E+02	1.51E+02	1.41E+02	1.42E+02	1.61E+02
688	1.11E+02	1.11E+02	1.11E+02	1.11E+02	1.11E+02	1.11E+02	1.11E+02
689	1.12E+02	1.12E+02	1.12E+02	1.12E+02	1.12E+02	1.12E+02	1.12E+02
690	1.12E+02	1.12E+02	1.12E+02	1.12E+02	1.12E+02	1.12E+02	1.12E+02
691	1.08E+02	1.08E+02	1.08E+02	1.08E+02	1.08E+02	1.08E+02	1.08E+02
692	1.21E+02	1.21E+02	1.21E+02	1.21E+02	1.21E+02	1.22E+02	1.21E+02
Biased Statistics							
Average Biased	1.15E+02	1.15E+02	1.15E+02	1.15E+02	1.15E+02	1.15E+02	1.15E+02
Std Dev Biased	2.75E+00	2.80E+00	2.85E+00	2.93E+00	3.17E+00	3.01E+00	2.84E+00
Ps90%/90% (+KTL) Biased	1.22E+02	1.23E+02	1.23E+02	1.23E+02	1.24E+02	1.24E+02	1.23E+02
Ps90%/90% (-KTL) Biased	1.07E+02	1.07E+02	1.07E+02	1.07E+02	1.07E+02	1.07E+02	1.07E+02
Un-Biased Statistics							
Average Un-Biased	1.20E+02	1.22E+02	1.25E+02	1.20E+02	1.18E+02	1.19E+02	1.22E+02
Std Dev Un-Biased	1.67E+01	2.06E+01	2.77E+01	1.70E+01	1.28E+01	1.33E+01	2.16E+01
Ps90%/90% (+KTL) Un-Biased	1.66E+02	1.78E+02	2.01E+02	1.67E+02	1.54E+02	1.55E+02	1.81E+02
Ps90%/90% (-KTL) Un-Biased	7.41E+01	6.53E+01	4.90E+01	7.36E+01	8.34E+01	8.23E+01	6.30E+01
Specification MIN	9.00E+01	9.00E+01	9.00E+01	9.00E+01	9.00E+01	9.00E+01	9.00E+01
Status	PASS	PASS	PASS	PASS	PASS	PASS	PASS

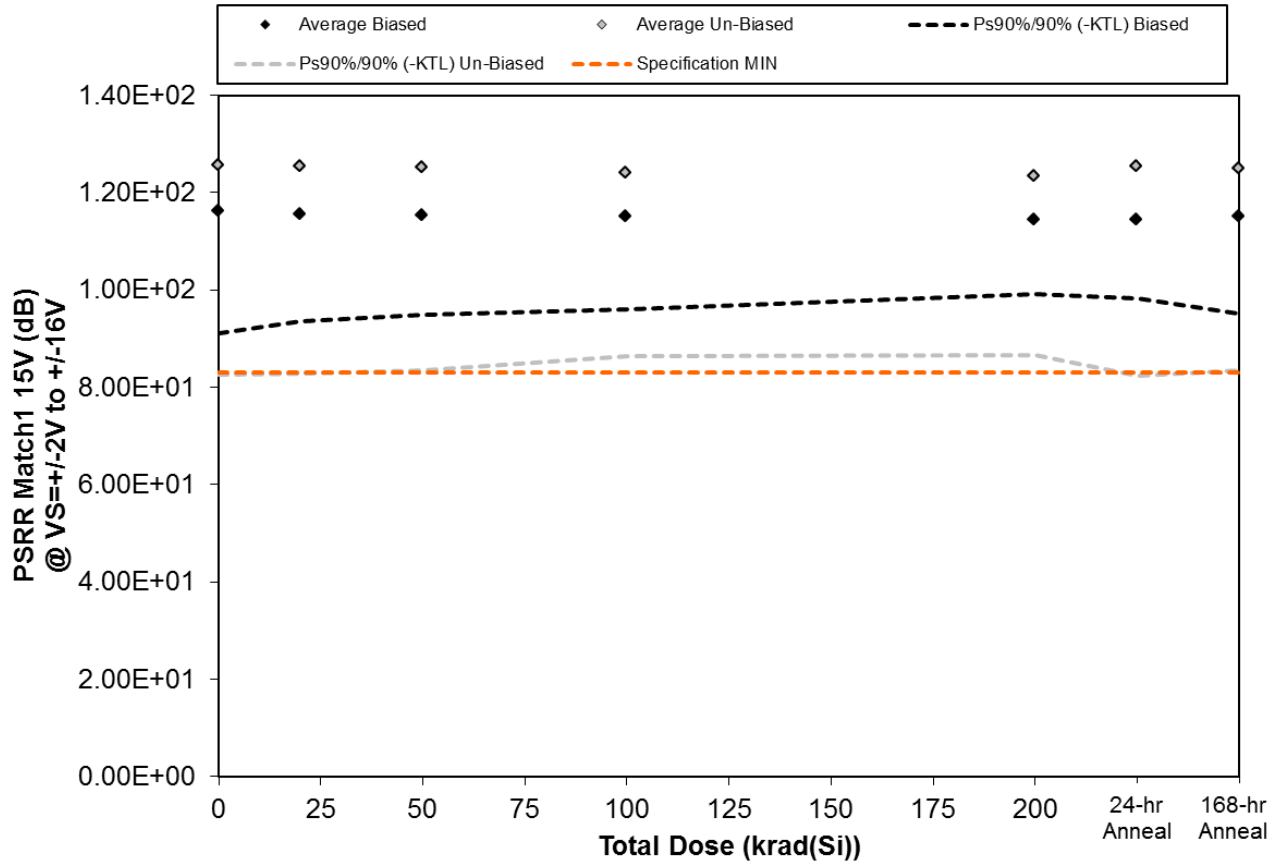

Figure 5.48. Plot of PSRR Match1 15V (dB) @ VS=+-2V to +/-16V versus total dose. The solid diamonds are the average of the measured data points for the samples irradiated under electrical bias while the shaded diamonds are the average of the measured data points for the samples irradiated with all pins tied to ground. The black lines (solid and/or dashed) are the upper and/or lower confidence limits, as determined by KTL statistics, on the samples irradiated under electrical bias while the gray lines (solid and/or dashed) are the upper and/or lower confidence limits, as determined by KTL statistics, on the samples irradiated in the unbiased condition. The red dotted line(s) are the pre- and/or post-irradiation minimum and/or maximum specification value as defined in the datasheet and/or test plan.



TID Report
15-0091 03/20/15 R1.0

Aeroflex RAD
5030 Centennial Blvd.
Colorado Springs, CO 80919
(719) 531-0800

Table 5.48. Raw data for PSRR Match1 15V (dB) @ VS=+/-2V to +/-16V versus total dose, including the statistical analysis, specification and the status of the testing (pass/fail).

PSRR Match1 15V (dB) @ VS=+/-2V to +/-16V	Total Dose (krad(Si))					24-hr Anneal	168-hr Anneal
	0	20	50	100	200		
Device							
680	1.28E+02	1.26E+02	1.24E+02	1.24E+02	1.20E+02	1.21E+02	1.24E+02
681	1.09E+02	1.09E+02	1.09E+02	1.09E+02	1.09E+02	1.09E+02	1.09E+02
682	1.09E+02	1.10E+02	1.10E+02	1.10E+02	1.11E+02	1.10E+02	1.10E+02
683	1.11E+02	1.11E+02	1.11E+02	1.11E+02	1.11E+02	1.11E+02	1.11E+02
684	1.24E+02	1.23E+02	1.22E+02	1.22E+02	1.21E+02	1.21E+02	1.23E+02
685	1.07E+02	1.07E+02	1.07E+02	1.07E+02	1.07E+02	1.07E+02	1.07E+02
686	1.17E+02	1.17E+02	1.17E+02	1.17E+02	1.17E+02	1.17E+02	1.17E+02
688	1.44E+02	1.43E+02	1.40E+02	1.39E+02	1.41E+02	1.45E+02	1.44E+02
689	1.40E+02	1.41E+02	1.42E+02	1.38E+02	1.33E+02	1.37E+02	1.37E+02
690	1.21E+02	1.20E+02	1.21E+02	1.21E+02	1.21E+02	1.21E+02	1.21E+02
691	1.09E+02	1.09E+02	1.09E+02	1.09E+02	1.09E+02	1.09E+02	1.09E+02
692	1.11E+02	1.11E+02	1.11E+02	1.11E+02	1.11E+02	1.11E+02	1.11E+02
Biased Statistics							
Average Biased	1.16E+02	1.16E+02	1.15E+02	1.15E+02	1.14E+02	1.15E+02	1.15E+02
Std Dev Biased	9.17E+00	8.09E+00	7.46E+00	7.00E+00	5.52E+00	5.97E+00	7.38E+00
Ps90%/90% (+KTL) Biased	1.41E+02	1.38E+02	1.36E+02	1.34E+02	1.30E+02	1.31E+02	1.36E+02
Ps90%/90% (-KTL) Biased	9.11E+01	9.35E+01	9.49E+01	9.59E+01	9.93E+01	9.82E+01	9.51E+01
Un-Biased Statistics							
Average Un-Biased	1.26E+02	1.25E+02	1.25E+02	1.24E+02	1.24E+02	1.25E+02	1.25E+02
Std Dev Un-Biased	1.57E+01	1.56E+01	1.52E+01	1.37E+01	1.35E+01	1.57E+01	1.51E+01
Ps90%/90% (+KTL) Un-Biased	1.69E+02	1.68E+02	1.67E+02	1.62E+02	1.60E+02	1.68E+02	1.67E+02
Ps90%/90% (-KTL) Un-Biased	8.26E+01	8.27E+01	8.36E+01	8.64E+01	8.66E+01	8.24E+01	8.35E+01
Specification MIN	8.30E+01	8.30E+01	8.30E+01	8.30E+01	8.30E+01	8.30E+01	8.30E+01
Status	PASS	PASS	PASS	PASS	PASS	PASS	PASS

An ISO 9001:2008 and DLA Certified Company

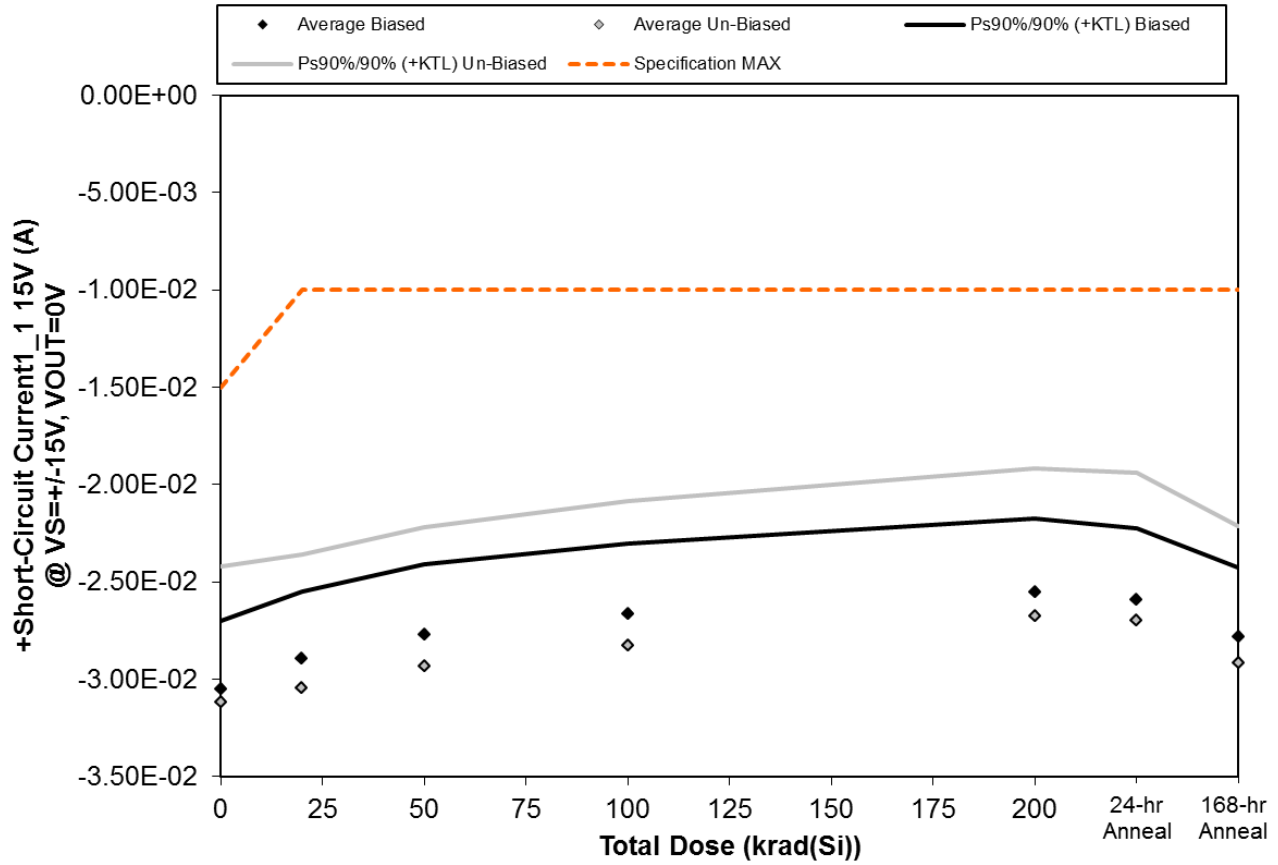

Figure 5.49. Plot of +Short-Circuit Current1_1 15V (A) @ VS=+-15V, VOUT=0V versus total dose. The solid diamonds are the average of the measured data points for the samples irradiated under electrical bias while the shaded diamonds are the average of the measured data points for the samples irradiated with all pins tied to ground. The black lines (solid and/or dashed) are the upper and/or lower confidence limits, as determined by KTL statistics, on the samples irradiated under electrical bias while the gray lines (solid and/or dashed) are the upper and/or lower confidence limits, as determined by KTL statistics, on the samples irradiated in the unbiased condition. The red dotted line(s) are the pre- and/or post-irradiation minimum and/or maximum specification value as defined in the datasheet and/or test plan.



TID Report
15-0091 03/20/15 R1.0

Aeroflex RAD
5030 Centennial Blvd.
Colorado Springs, CO 80919
(719) 531-0800

Table 5.49. Raw data for +Short-Circuit Current1_1 15V (A) @ VS=+/-15V, VOUT=0V versus total dose, including the statistical analysis, specification and the status of the testing (pass/fail).

+Short-Circuit Current1_1 15V (A) @ VS=+/-15V, VOUT=0V	Total Dose (krad(Si))					24-hr Anneal	168-hr Anneal
	0	20	50	100	200		
Device							
680	-2.99E-02	-2.83E-02	-2.70E-02	-2.59E-02	-2.45E-02	-2.50E-02	-2.71E-02
681	-2.94E-02	-2.79E-02	-2.67E-02	-2.56E-02	-2.45E-02	-2.50E-02	-2.68E-02
682	-3.19E-02	-3.03E-02	-2.93E-02	-2.82E-02	-2.72E-02	-2.75E-02	-2.92E-02
683	-2.94E-02	-2.79E-02	-2.66E-02	-2.55E-02	-2.45E-02	-2.49E-02	-2.67E-02
684	-3.18E-02	-3.03E-02	-2.90E-02	-2.79E-02	-2.68E-02	-2.72E-02	-2.92E-02
685	-2.95E-02	-2.89E-02	-2.78E-02	-2.67E-02	-2.53E-02	-2.54E-02	-2.76E-02
686	-2.97E-02	-2.88E-02	-2.78E-02	-2.67E-02	-2.52E-02	-2.54E-02	-2.77E-02
688	-3.56E-02	-3.48E-02	-3.39E-02	-3.30E-02	-3.15E-02	-3.18E-02	-3.37E-02
689	-3.11E-02	-3.02E-02	-2.92E-02	-2.82E-02	-2.67E-02	-2.70E-02	-2.91E-02
690	-3.01E-02	-2.94E-02	-2.80E-02	-2.68E-02	-2.51E-02	-2.54E-02	-2.79E-02
691	-3.03E-02	-3.03E-02	-3.02E-02	-3.03E-02	-3.03E-02	-3.02E-02	-3.03E-02
692	-3.02E-02	-3.02E-02	-3.02E-02	-3.02E-02	-3.02E-02	-3.01E-02	-3.02E-02
Biased Statistics							
Average Biased	-3.05E-02	-2.89E-02	-2.77E-02	-2.66E-02	-2.55E-02	-2.59E-02	-2.78E-02
Std Dev Biased	1.27E-03	1.26E-03	1.32E-03	1.31E-03	1.37E-03	1.33E-03	1.30E-03
Ps90%/90% (+KTL) Biased	-2.70E-02	-2.55E-02	-2.41E-02	-2.30E-02	-2.17E-02	-2.22E-02	-2.42E-02
Ps90%/90% (-KTL) Biased	-3.40E-02	-3.24E-02	-3.13E-02	-3.02E-02	-2.93E-02	-2.95E-02	-3.14E-02
Un-Biased Statistics							
Average Un-Biased	-3.12E-02	-3.04E-02	-2.93E-02	-2.83E-02	-2.68E-02	-2.70E-02	-2.92E-02
Std Dev Un-Biased	2.55E-03	2.50E-03	2.61E-03	2.70E-03	2.76E-03	2.77E-03	2.57E-03
Ps90%/90% (+KTL) Un-Biased	-2.42E-02	-2.36E-02	-2.22E-02	-2.09E-02	-1.92E-02	-1.94E-02	-2.21E-02
Ps90%/90% (-KTL) Un-Biased	-3.82E-02	-3.73E-02	-3.65E-02	-3.57E-02	-3.43E-02	-3.46E-02	-3.62E-02
Specification MAX	-1.50E-02	-1.00E-02	-1.00E-02	-1.00E-02	-1.00E-02	-1.00E-02	-1.00E-02
Status	PASS	PASS	PASS	PASS	PASS	PASS	PASS

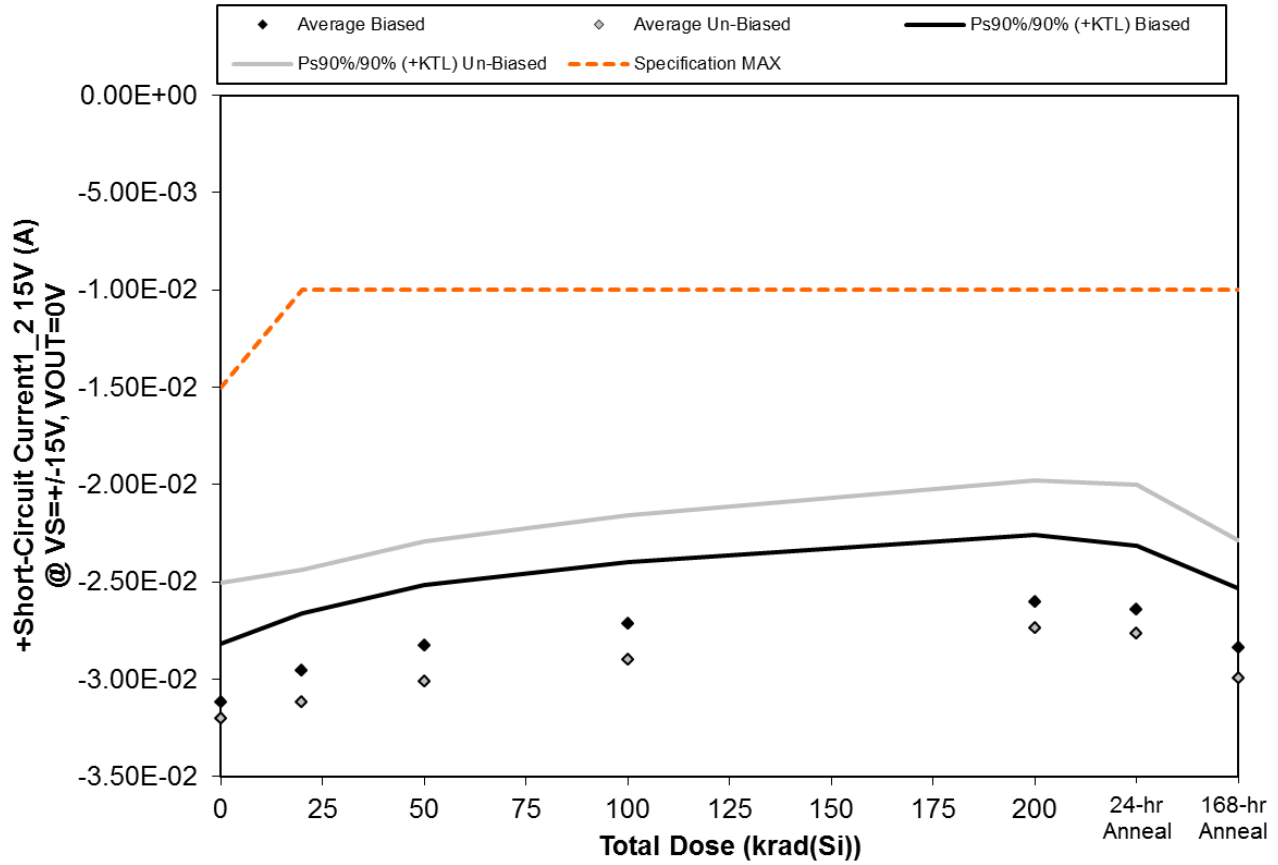

Figure 5.50. Plot of +Short-Circuit Current1_2 15V (A) @ VS=+-15V, VOUT=0V versus total dose. The solid diamonds are the average of the measured data points for the samples irradiated under electrical bias while the shaded diamonds are the average of the measured data points for the samples irradiated with all pins tied to ground. The black lines (solid and/or dashed) are the upper and/or lower confidence limits, as determined by KTL statistics, on the samples irradiated under electrical bias while the gray lines (solid and/or dashed) are the upper and/or lower confidence limits, as determined by KTL statistics, on the samples irradiated in the unbiased condition. The red dotted line(s) are the pre- and/or post-irradiation minimum and/or maximum specification value as defined in the datasheet and/or test plan.



TID Report
15-0091 03/20/15 R1.0

Aeroflex RAD
5030 Centennial Blvd.
Colorado Springs, CO 80919
(719) 531-0800

Table 5.50. Raw data for +Short-Circuit Current1_2 15V (A) @ VS=+/-15V, VOUT=0V versus total dose, including the statistical analysis, specification and the status of the testing (pass/fail).

+Short-Circuit Current1_2 15V (A) @ VS=+/-15V, VOUT=0V	Total Dose (krad(Si))					24-hr Anneal	168-hr Anneal
	0	20	50	100	200		
Device							
680	-3.04E-02	-2.87E-02	-2.74E-02	-2.63E-02	-2.48E-02	-2.53E-02	-2.75E-02
681	-3.06E-02	-2.90E-02	-2.78E-02	-2.66E-02	-2.55E-02	-2.59E-02	-2.78E-02
682	-3.25E-02	-3.08E-02	-2.97E-02	-2.87E-02	-2.76E-02	-2.80E-02	-2.98E-02
683	-3.01E-02	-2.86E-02	-2.73E-02	-2.61E-02	-2.51E-02	-2.55E-02	-2.74E-02
684	-3.21E-02	-3.05E-02	-2.93E-02	-2.81E-02	-2.70E-02	-2.74E-02	-2.94E-02
685	-3.07E-02	-2.99E-02	-2.89E-02	-2.77E-02	-2.62E-02	-2.63E-02	-2.86E-02
686	-3.01E-02	-2.92E-02	-2.81E-02	-2.70E-02	-2.55E-02	-2.57E-02	-2.80E-02
688	-3.64E-02	-3.55E-02	-3.46E-02	-3.36E-02	-3.22E-02	-3.24E-02	-3.43E-02
689	-3.21E-02	-3.11E-02	-3.01E-02	-2.90E-02	-2.75E-02	-2.78E-02	-3.00E-02
690	-3.09E-02	-3.03E-02	-2.88E-02	-2.76E-02	-2.57E-02	-2.60E-02	-2.87E-02
691	-3.06E-02	-3.07E-02	-3.06E-02	-3.07E-02	-3.07E-02	-3.05E-02	-3.06E-02
692	-3.11E-02	-3.11E-02	-3.11E-02	-3.11E-02	-3.11E-02	-3.09E-02	-3.11E-02
Biased Statistics							
Average Biased	-3.11E-02	-2.95E-02	-2.83E-02	-2.72E-02	-2.60E-02	-2.64E-02	-2.84E-02
Std Dev Biased	1.08E-03	1.07E-03	1.13E-03	1.16E-03	1.24E-03	1.19E-03	1.12E-03
Ps90%/90% (+KTL) Biased	-2.82E-02	-2.66E-02	-2.52E-02	-2.40E-02	-2.26E-02	-2.31E-02	-2.53E-02
Ps90%/90% (-KTL) Biased	-3.41E-02	-3.25E-02	-3.14E-02	-3.03E-02	-2.94E-02	-2.97E-02	-3.15E-02
Un-Biased Statistics							
Average Un-Biased	-3.20E-02	-3.12E-02	-3.01E-02	-2.90E-02	-2.74E-02	-2.76E-02	-2.99E-02
Std Dev Un-Biased	2.54E-03	2.49E-03	2.61E-03	2.71E-03	2.77E-03	2.78E-03	2.57E-03
Ps90%/90% (+KTL) Un-Biased	-2.50E-02	-2.44E-02	-2.29E-02	-2.16E-02	-1.98E-02	-2.00E-02	-2.29E-02
Ps90%/90% (-KTL) Un-Biased	-3.90E-02	-3.80E-02	-3.72E-02	-3.64E-02	-3.50E-02	-3.53E-02	-3.70E-02
Specification MAX	-1.50E-02	-1.00E-02	-1.00E-02	-1.00E-02	-1.00E-02	-1.00E-02	-1.00E-02
Status	PASS	PASS	PASS	PASS	PASS	PASS	PASS

An ISO 9001:2008 and DLA Certified Company

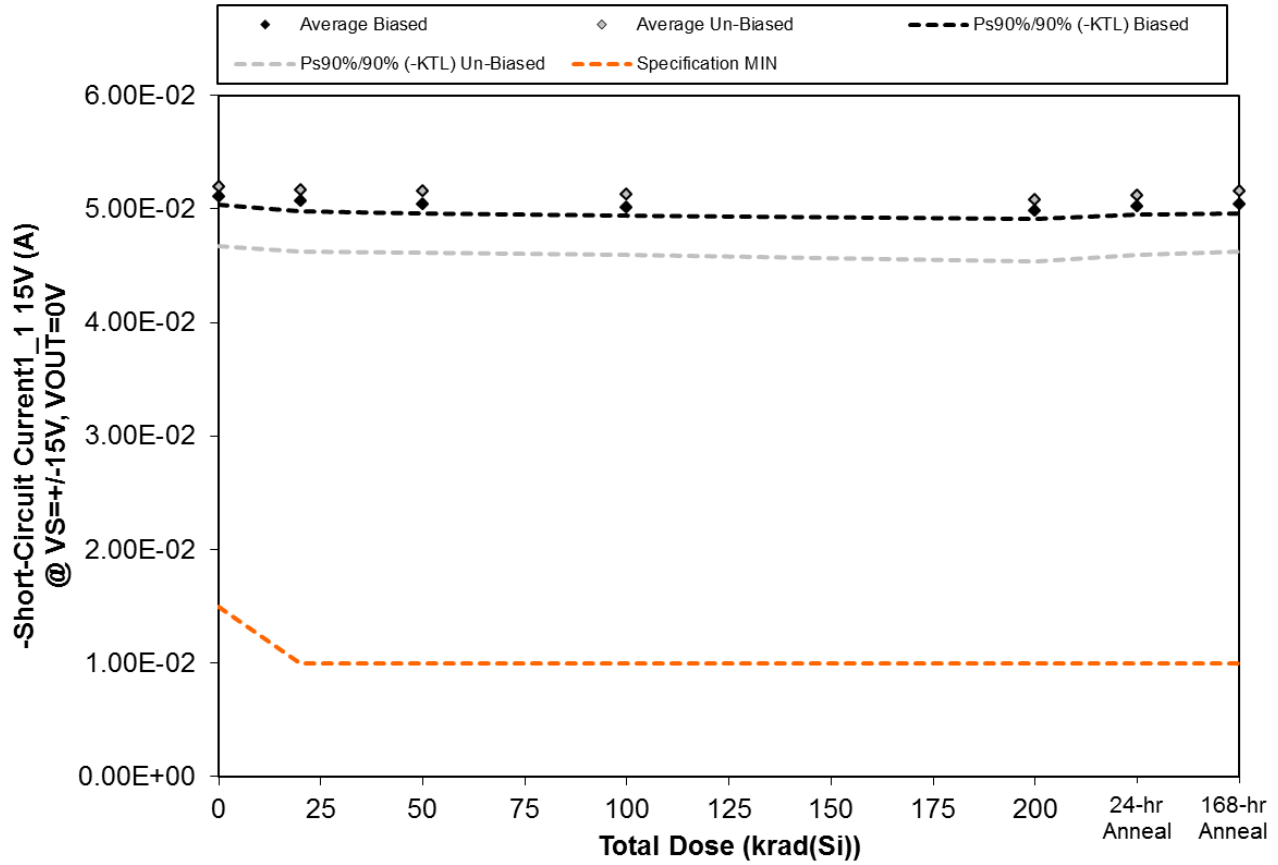

Figure 5.51. Plot of -Short-Circuit Current1_1 15V (A) @ VS=+-15V, VOUT=0V versus total dose. The solid diamonds are the average of the measured data points for the samples irradiated under electrical bias while the shaded diamonds are the average of the measured data points for the samples irradiated with all pins tied to ground. The black lines (solid and/or dashed) are the upper and/or lower confidence limits, as determined by KTL statistics, on the samples irradiated under electrical bias while the gray lines (solid and/or dashed) are the upper and/or lower confidence limits, as determined by KTL statistics, on the samples irradiated in the unbiased condition. The red dotted line(s) are the pre- and/or post-irradiation minimum and/or maximum specification value as defined in the datasheet and/or test plan.



TID Report
15-0091 03/20/15 R1.0

Aeroflex RAD
5030 Centennial Blvd.
Colorado Springs, CO 80919
(719) 531-0800

Table 5.51. Raw data for -Short-Circuit Current1_1 15V (A) @ VS=+/-15V, VOUT=0V versus total dose, including the statistical analysis, specification and the status of the testing (pass/fail).

-Short-Circuit Current1_1 15V (A) @ VS=+/-15V, VOUT=0V	Total Dose (krad(Si))					24-hr	168-hr
	0	20	50	100	200	Anneal	Anneal
Device							
680	5.12E-02	5.08E-02	5.06E-02	5.00E-02	4.99E-02	5.03E-02	5.05E-02
681	5.10E-02	5.05E-02	5.04E-02	5.01E-02	4.99E-02	5.02E-02	5.03E-02
682	5.13E-02	5.09E-02	5.06E-02	5.04E-02	5.01E-02	5.04E-02	5.06E-02
683	5.14E-02	5.10E-02	5.08E-02	5.06E-02	5.01E-02	5.06E-02	5.07E-02
684	5.07E-02	5.02E-02	5.00E-02	4.98E-02	4.94E-02	4.98E-02	5.00E-02
685	5.07E-02	5.03E-02	5.02E-02	5.00E-02	4.95E-02	5.00E-02	5.02E-02
686	5.08E-02	5.06E-02	5.04E-02	5.02E-02	4.96E-02	5.00E-02	5.04E-02
688	5.53E-02	5.51E-02	5.50E-02	5.46E-02	5.43E-02	5.45E-02	5.49E-02
689	5.16E-02	5.14E-02	5.12E-02	5.08E-02	5.05E-02	5.08E-02	5.11E-02
690	5.15E-02	5.08E-02	5.09E-02	5.05E-02	5.02E-02	5.05E-02	5.09E-02
691	5.14E-02	5.13E-02	5.14E-02	5.13E-02	5.14E-02	5.16E-02	5.14E-02
692	5.04E-02	5.04E-02	5.05E-02	5.05E-02	5.04E-02	5.06E-02	5.05E-02
Biased Statistics							
Average Biased	5.11E-02	5.07E-02	5.05E-02	5.02E-02	4.99E-02	5.03E-02	5.04E-02
Std Dev Biased	2.76E-04	3.12E-04	2.99E-04	2.81E-04	2.72E-04	2.80E-04	2.97E-04
Ps90%/90% (+KTL) Biased	5.19E-02	5.15E-02	5.13E-02	5.09E-02	5.06E-02	5.10E-02	5.12E-02
Ps90%/90% (-KTL) Biased	5.04E-02	4.98E-02	4.96E-02	4.94E-02	4.91E-02	4.95E-02	4.96E-02
Un-Biased Statistics							
Average Un-Biased	5.19E-02	5.17E-02	5.15E-02	5.12E-02	5.08E-02	5.11E-02	5.15E-02
Std Dev Un-Biased	1.89E-03	1.99E-03	1.96E-03	1.93E-03	1.97E-03	1.90E-03	1.94E-03
Ps90%/90% (+KTL) Un-Biased	5.71E-02	5.71E-02	5.69E-02	5.65E-02	5.62E-02	5.64E-02	5.69E-02
Ps90%/90% (-KTL) Un-Biased	4.68E-02	4.62E-02	4.62E-02	4.59E-02	4.54E-02	4.59E-02	4.62E-02
Specification MIN	1.50E-02	1.00E-02	1.00E-02	1.00E-02	1.00E-02	1.00E-02	1.00E-02
Status	PASS	PASS	PASS	PASS	PASS	PASS	PASS

An ISO 9001:2008 and DLA Certified Company

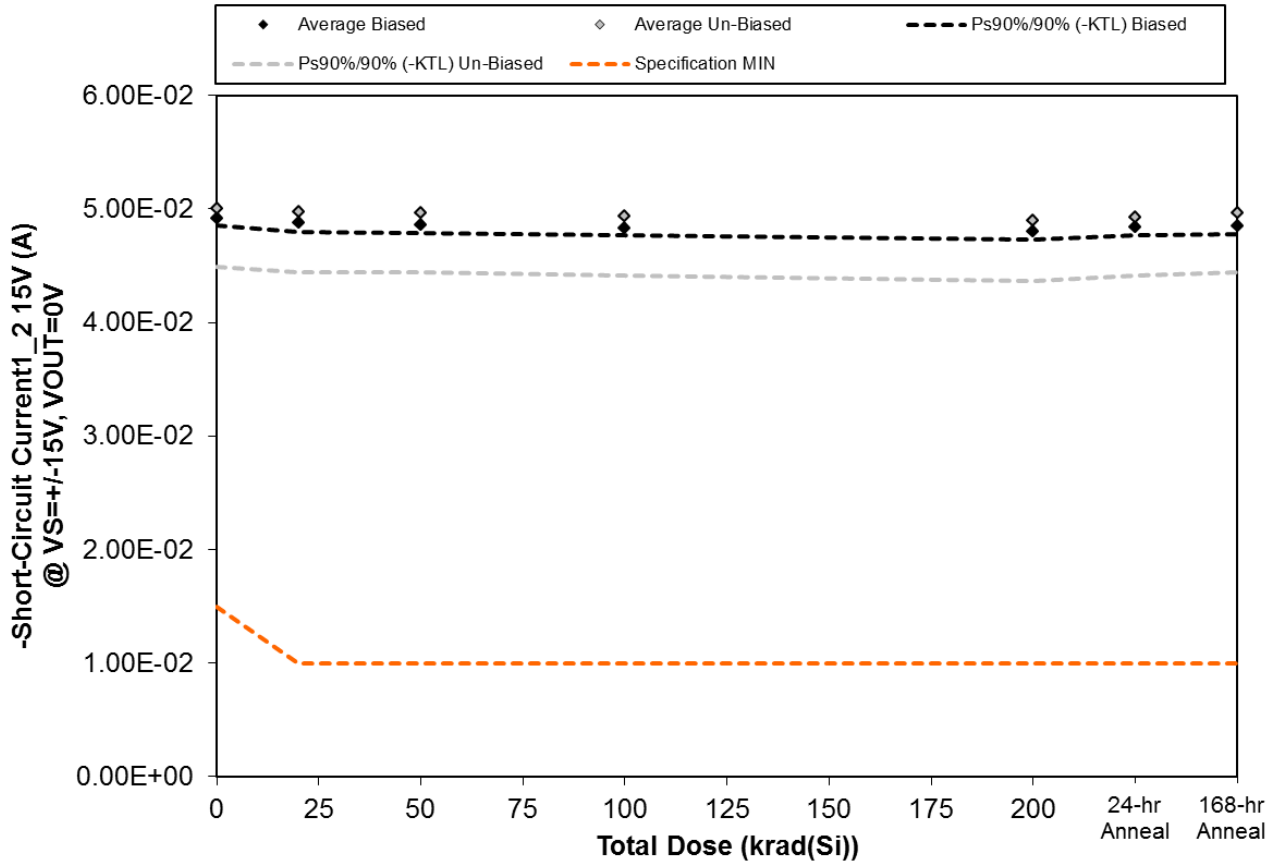

Figure 5.52. Plot of -Short-Circuit Current1_2 15V (A) @ VS=+-15V, VOUT=0V versus total dose. The solid diamonds are the average of the measured data points for the samples irradiated under electrical bias while the shaded diamonds are the average of the measured data points for the samples irradiated with all pins tied to ground. The black lines (solid and/or dashed) are the upper and/or lower confidence limits, as determined by KTL statistics, on the samples irradiated under electrical bias while the gray lines (solid and/or dashed) are the upper and/or lower confidence limits, as determined by KTL statistics, on the samples irradiated in the unbiased condition. The red dotted line(s) are the pre- and/or post-irradiation minimum and/or maximum specification value as defined in the datasheet and/or test plan.



TID Report
15-0091 03/20/15 R1.0

Aeroflex RAD
5030 Centennial Blvd.
Colorado Springs, CO 80919
(719) 531-0800

Table 5.52. Raw data for -Short-Circuit Current1_2 15V (A) @ VS=+/-15V, VOUT=0V versus total dose, including the statistical analysis, specification and the status of the testing (pass/fail).

-Short-Circuit Current1_2 15V (A) @ VS=+/-15V, VOUT=0V	Total Dose (krad(Si))					24-hr	168-hr
	0	20	50	100	200	Anneal	Anneal
Device							
680	4.93E-02	4.89E-02	4.88E-02	4.83E-02	4.81E-02	4.85E-02	4.87E-02
681	4.91E-02	4.86E-02	4.85E-02	4.82E-02	4.80E-02	4.83E-02	4.84E-02
682	4.92E-02	4.88E-02	4.86E-02	4.84E-02	4.81E-02	4.84E-02	4.86E-02
683	4.95E-02	4.90E-02	4.88E-02	4.86E-02	4.82E-02	4.86E-02	4.88E-02
684	4.89E-02	4.83E-02	4.81E-02	4.80E-02	4.75E-02	4.80E-02	4.81E-02
685	4.88E-02	4.84E-02	4.83E-02	4.81E-02	4.76E-02	4.81E-02	4.84E-02
686	4.90E-02	4.89E-02	4.87E-02	4.85E-02	4.79E-02	4.83E-02	4.87E-02
688	5.33E-02	5.31E-02	5.30E-02	5.27E-02	5.23E-02	5.26E-02	5.30E-02
689	4.97E-02	4.95E-02	4.94E-02	4.90E-02	4.87E-02	4.89E-02	4.92E-02
690	4.93E-02	4.87E-02	4.88E-02	4.85E-02	4.80E-02	4.84E-02	4.89E-02
691	4.98E-02	4.97E-02	4.98E-02	4.97E-02	4.97E-02	5.00E-02	4.98E-02
692	4.87E-02	4.87E-02	4.87E-02	4.87E-02	4.87E-02	4.90E-02	4.88E-02
Biased Statistics							
Average Biased	4.92E-02	4.87E-02	4.86E-02	4.83E-02	4.80E-02	4.84E-02	4.85E-02
Std Dev Biased	2.31E-04	2.84E-04	2.69E-04	2.31E-04	2.65E-04	2.42E-04	2.69E-04
Ps90%/90% (+KTL) Biased	4.98E-02	4.95E-02	4.93E-02	4.89E-02	4.87E-02	4.90E-02	4.92E-02
Ps90%/90% (-KTL) Biased	4.86E-02	4.80E-02	4.78E-02	4.77E-02	4.73E-02	4.77E-02	4.78E-02
Un-Biased Statistics							
Average Un-Biased	5.00E-02	4.97E-02	4.96E-02	4.93E-02	4.89E-02	4.93E-02	4.96E-02
Std Dev Un-Biased	1.87E-03	1.93E-03	1.91E-03	1.90E-03	1.94E-03	1.86E-03	1.90E-03
Ps90%/90% (+KTL) Un-Biased	5.52E-02	5.50E-02	5.49E-02	5.45E-02	5.43E-02	5.44E-02	5.48E-02
Ps90%/90% (-KTL) Un-Biased	4.49E-02	4.44E-02	4.44E-02	4.41E-02	4.36E-02	4.42E-02	4.44E-02
Specification MIN	1.50E-02	1.00E-02	1.00E-02	1.00E-02	1.00E-02	1.00E-02	1.00E-02
Status	PASS	PASS	PASS	PASS	PASS	PASS	PASS

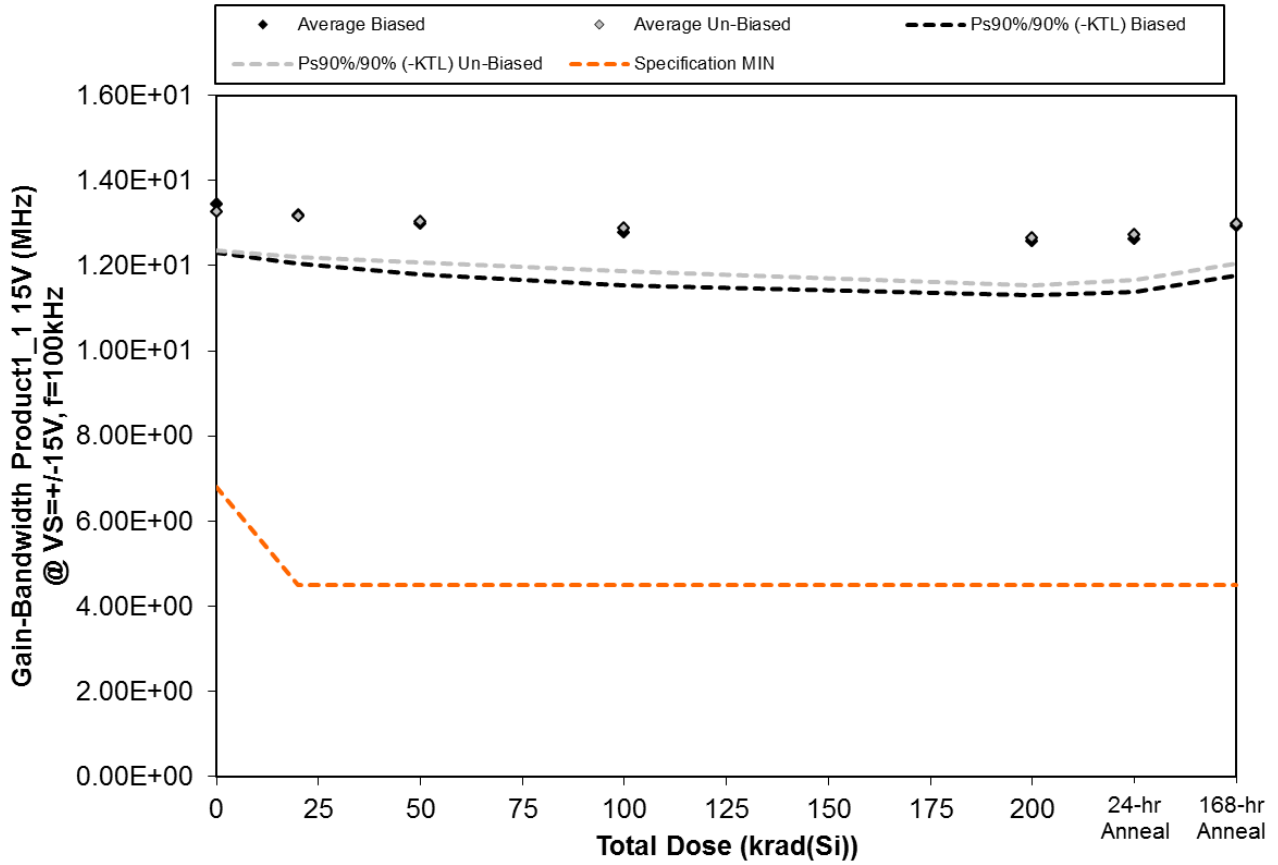

Figure 5.53. Plot of Gain-Bandwidth Product1_1 15V (MHz) @ VS=+/-15V, f=100kHz versus total dose. The solid diamonds are the average of the measured data points for the samples irradiated under electrical bias while the shaded diamonds are the average of the measured data points for the samples irradiated with all pins tied to ground. The black lines (solid and/or dashed) are the upper and/or lower confidence limits, as determined by KTL statistics, on the samples irradiated under electrical bias while the gray lines (solid and/or dashed) are the upper and/or lower confidence limits, as determined by KTL statistics, on the samples irradiated in the unbiased condition. The red dotted line(s) are the pre- and/or post-irradiation minimum and/or maximum specification value as defined in the datasheet and/or test plan.



TID Report
15-0091 03/20/15 R1.0

Aeroflex RAD
5030 Centennial Blvd.
Colorado Springs, CO 80919
(719) 531-0800

Table 5.53. Raw data for Gain-Bandwidth Product1_1 15V (MHz) @ VS=+/-15V, f=100kHz versus total dose, including the statistical analysis, specification and the status of the testing (pass/fail).

Gain-Bandwidth Product1_1 15V (MHz) @ VS=+/-15V, f=100kHz	Total Dose (krad(Si))					24-hr Anneal	168-hr Anneal
	0	20	50	100	200		
Device							
680	1.35E+01	1.32E+01	1.30E+01	1.28E+01	1.25E+01	1.26E+01	1.30E+01
681	1.33E+01	1.30E+01	1.28E+01	1.26E+01	1.24E+01	1.25E+01	1.28E+01
682	1.40E+01	1.38E+01	1.36E+01	1.34E+01	1.33E+01	1.33E+01	1.35E+01
683	1.29E+01	1.26E+01	1.24E+01	1.22E+01	1.20E+01	1.21E+01	1.24E+01
684	1.36E+01	1.33E+01	1.31E+01	1.29E+01	1.27E+01	1.28E+01	1.31E+01
685	1.29E+01	1.28E+01	1.27E+01	1.25E+01	1.23E+01	1.24E+01	1.26E+01
686	1.32E+01	1.31E+01	1.30E+01	1.28E+01	1.26E+01	1.27E+01	1.30E+01
688	1.38E+01	1.37E+01	1.36E+01	1.35E+01	1.34E+01	1.34E+01	1.36E+01
689	1.31E+01	1.30E+01	1.28E+01	1.27E+01	1.25E+01	1.25E+01	1.28E+01
690	1.34E+01	1.32E+01	1.31E+01	1.29E+01	1.26E+01	1.27E+01	1.31E+01
691	1.34E+01	1.35E+01	1.34E+01	1.35E+01	1.35E+01	1.34E+01	1.35E+01
692	1.32E+01	1.32E+01	1.32E+01	1.32E+01	1.32E+01	1.33E+01	1.33E+01
Biased Statistics							
Average Biased	1.35E+01	1.32E+01	1.30E+01	1.28E+01	1.26E+01	1.26E+01	1.29E+01
Std Dev Biased	4.15E-01	4.21E-01	4.30E-01	4.54E-01	4.65E-01	4.58E-01	4.28E-01
Ps90%/90% (+KTL) Biased	1.46E+01	1.43E+01	1.42E+01	1.40E+01	1.39E+01	1.39E+01	1.41E+01
Ps90%/90% (-KTL) Biased	1.23E+01	1.20E+01	1.18E+01	1.15E+01	1.13E+01	1.14E+01	1.18E+01
Un-Biased Statistics							
Average Un-Biased	1.33E+01	1.32E+01	1.30E+01	1.29E+01	1.27E+01	1.27E+01	1.30E+01
Std Dev Un-Biased	3.30E-01	3.50E-01	3.56E-01	3.77E-01	4.07E-01	3.89E-01	3.49E-01
Ps90%/90% (+KTL) Un-Biased	1.42E+01	1.41E+01	1.40E+01	1.39E+01	1.38E+01	1.38E+01	1.40E+01
Ps90%/90% (-KTL) Un-Biased	1.24E+01	1.22E+01	1.21E+01	1.19E+01	1.15E+01	1.17E+01	1.20E+01
Specification MIN	6.80E+00	4.50E+00	4.50E+00	4.50E+00	4.50E+00	4.50E+00	4.50E+00
Status	PASS	PASS	PASS	PASS	PASS	PASS	PASS

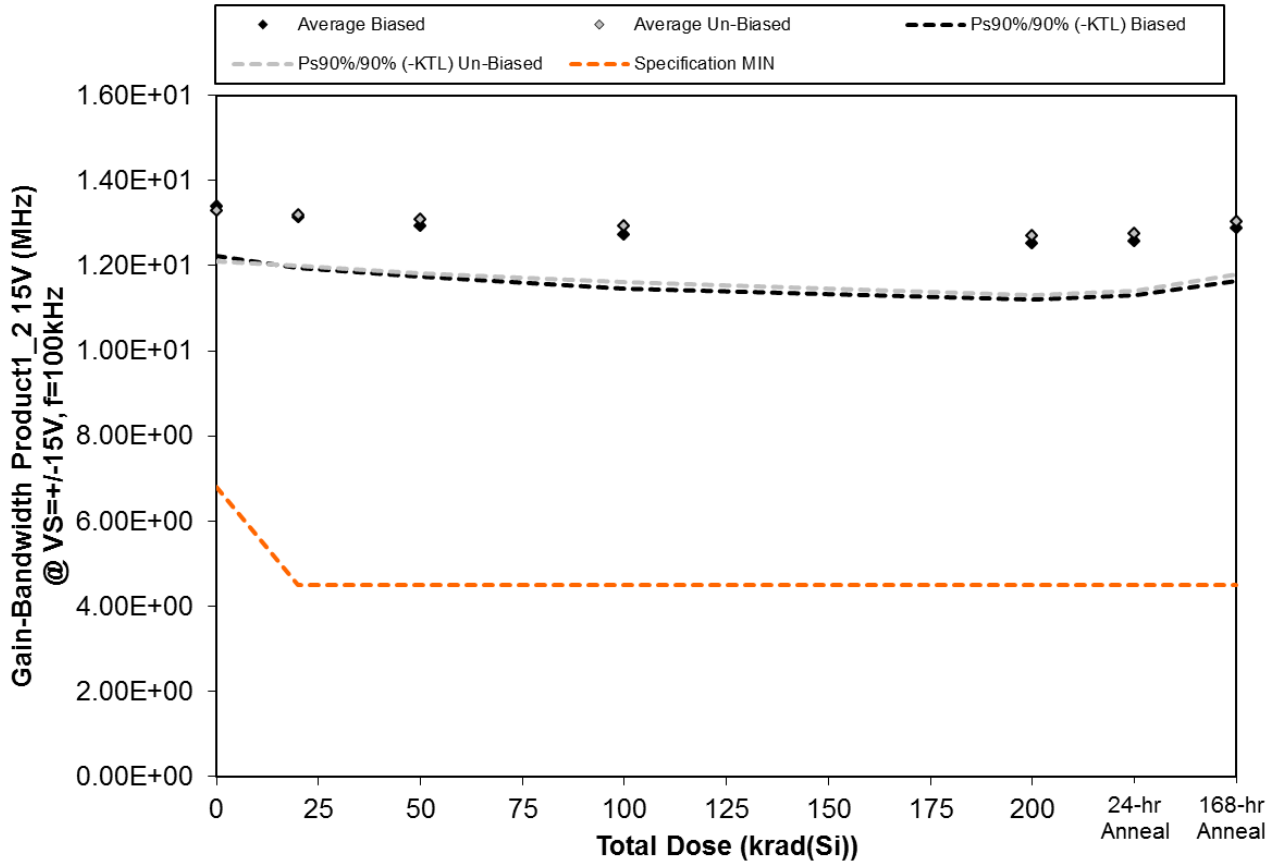

Figure 5.54. Plot of Gain-Bandwidth Product1_2 15V (MHz) @ VS=+/-15V, f=100kHz versus total dose. The solid diamonds are the average of the measured data points for the samples irradiated under electrical bias while the shaded diamonds are the average of the measured data points for the samples irradiated with all pins tied to ground. The black lines (solid and/or dashed) are the upper and/or lower confidence limits, as determined by KTL statistics, on the samples irradiated under electrical bias while the gray lines (solid and/or dashed) are the upper and/or lower confidence limits, as determined by KTL statistics, on the samples irradiated in the unbiased condition. The red dotted line(s) are the pre- and/or post-irradiation minimum and/or maximum specification value as defined in the datasheet and/or test plan.



TID Report
15-0091 03/20/15 R1.0

Aeroflex RAD
5030 Centennial Blvd.
Colorado Springs, CO 80919
(719) 531-0800

Table 5.54. Raw data for Gain-Bandwidth Product1_2 15V (MHz) @ VS=+/-15V, f=100kHz versus total dose, including the statistical analysis, specification and the status of the testing (pass/fail).

Gain-Bandwidth Product1_2 15V (MHz) @ VS=+/-15V, f=100kHz	Total Dose (krad(Si))					24-hr Anneal	168-hr Anneal
	0	20	50	100	200		
Device							
680	1.33E+01	1.31E+01	1.28E+01	1.26E+01	1.23E+01	1.24E+01	1.28E+01
681	1.33E+01	1.30E+01	1.28E+01	1.26E+01	1.24E+01	1.24E+01	1.27E+01
682	1.40E+01	1.37E+01	1.35E+01	1.34E+01	1.32E+01	1.32E+01	1.35E+01
683	1.28E+01	1.26E+01	1.24E+01	1.21E+01	1.19E+01	1.20E+01	1.23E+01
684	1.36E+01	1.33E+01	1.32E+01	1.30E+01	1.28E+01	1.28E+01	1.31E+01
685	1.29E+01	1.28E+01	1.27E+01	1.25E+01	1.23E+01	1.23E+01	1.26E+01
686	1.32E+01	1.31E+01	1.30E+01	1.28E+01	1.25E+01	1.26E+01	1.29E+01
688	1.40E+01	1.39E+01	1.38E+01	1.37E+01	1.36E+01	1.36E+01	1.38E+01
689	1.30E+01	1.29E+01	1.28E+01	1.27E+01	1.25E+01	1.25E+01	1.28E+01
690	1.34E+01	1.33E+01	1.31E+01	1.29E+01	1.27E+01	1.27E+01	1.31E+01
691	1.34E+01	1.34E+01	1.34E+01	1.34E+01	1.33E+01	1.34E+01	1.33E+01
692	1.33E+01	1.33E+01	1.33E+01	1.33E+01	1.33E+01	1.33E+01	1.33E+01
Biased Statistics							
Average Biased	1.34E+01	1.31E+01	1.29E+01	1.27E+01	1.25E+01	1.26E+01	1.29E+01
Std Dev Biased	4.24E-01	4.27E-01	4.38E-01	4.62E-01	4.86E-01	4.65E-01	4.49E-01
Ps90%/90% (+KTL) Biased	1.45E+01	1.43E+01	1.41E+01	1.40E+01	1.39E+01	1.39E+01	1.41E+01
Ps90%/90% (-KTL) Biased	1.22E+01	1.20E+01	1.17E+01	1.15E+01	1.12E+01	1.13E+01	1.16E+01
Un-Biased Statistics							
Average Un-Biased	1.33E+01	1.32E+01	1.31E+01	1.29E+01	1.27E+01	1.28E+01	1.30E+01
Std Dev Un-Biased	4.34E-01	4.36E-01	4.54E-01	4.71E-01	5.07E-01	4.96E-01	4.56E-01
Ps90%/90% (+KTL) Un-Biased	1.45E+01	1.44E+01	1.43E+01	1.42E+01	1.41E+01	1.41E+01	1.43E+01
Ps90%/90% (-KTL) Un-Biased	1.21E+01	1.20E+01	1.18E+01	1.16E+01	1.13E+01	1.14E+01	1.18E+01
Specification MIN	6.80E+00	4.50E+00	4.50E+00	4.50E+00	4.50E+00	4.50E+00	4.50E+00
Status	PASS	PASS	PASS	PASS	PASS	PASS	PASS

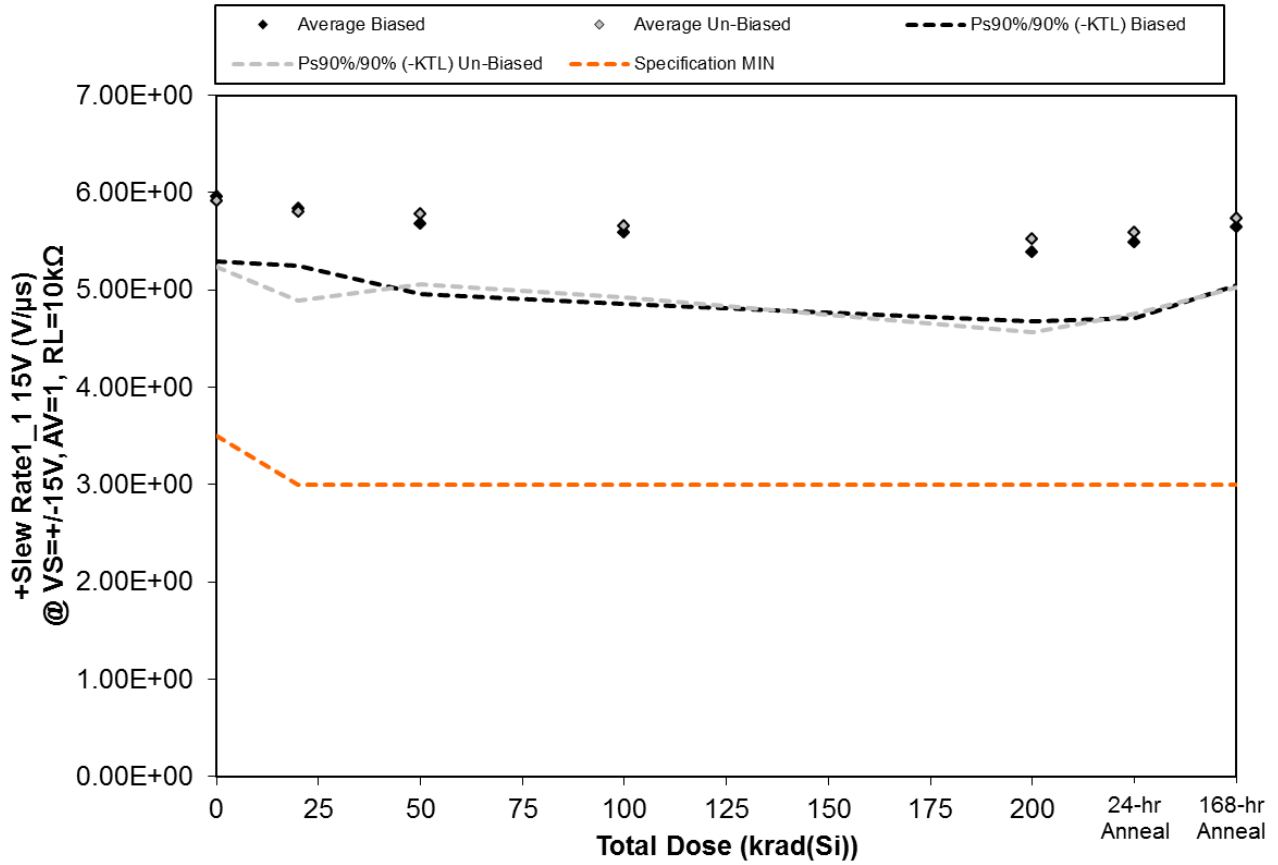

Figure 5.55. Plot of +Slew Rate1_1 15V (V/μs) @ VS=+-15V, AV=1, RL=10kΩ versus total dose. The solid diamonds are the average of the measured data points for the samples irradiated under electrical bias while the shaded diamonds are the average of the measured data points for the samples irradiated with all pins tied to ground. The black lines (solid and/or dashed) are the upper and/or lower confidence limits, as determined by KTL statistics, on the samples irradiated under electrical bias while the gray lines (solid and/or dashed) are the upper and/or lower confidence limits, as determined by KTL statistics, on the samples irradiated in the unbiased condition. The red dotted line(s) are the pre- and/or post-irradiation minimum and/or maximum specification value as defined in the datasheet and/or test plan.



TID Report
15-0091 03/20/15 R1.0

Aeroflex RAD
5030 Centennial Blvd.
Colorado Springs, CO 80919
(719) 531-0800

Table 5.55. Raw data for +Slew Rate1_1 15V (V/μs) @ VS=+/-15V, AV=1, RL=10kΩ versus total dose, including the statistical analysis, specification and the status of the testing (pass/fail).

+Slew Rate1_1 15V (V/μs) @ VS=+/-15V, AV=1, RL=10kΩ	Total Dose (krad(Si))					24-hr	168-hr
	0	20	50	100	200	Anneal	Anneal
Device							
680	5.88E+00	5.79E+00	5.65E+00	5.47E+00	5.26E+00	5.39E+00	5.63E+00
681	5.74E+00	5.73E+00	5.60E+00	5.54E+00	5.35E+00	5.37E+00	5.53E+00
682	6.32E+00	6.11E+00	6.11E+00	6.01E+00	5.75E+00	5.88E+00	5.85E+00
683	5.77E+00	5.56E+00	5.39E+00	5.29E+00	5.07E+00	5.15E+00	5.35E+00
684	6.07E+00	5.97E+00	5.67E+00	5.65E+00	5.53E+00	5.66E+00	5.86E+00
685	5.60E+00	5.60E+00	5.54E+00	5.44E+00	5.31E+00	5.35E+00	5.53E+00
686	5.81E+00	5.61E+00	5.74E+00	5.55E+00	5.33E+00	5.50E+00	5.62E+00
688	6.23E+00	6.30E+00	6.22E+00	6.12E+00	6.13E+00	6.12E+00	6.17E+00
689	5.86E+00	5.51E+00	5.62E+00	5.53E+00	5.36E+00	5.45E+00	5.59E+00
690	6.09E+00	5.98E+00	5.77E+00	5.67E+00	5.47E+00	5.54E+00	5.78E+00
691	5.91E+00	5.84E+00	5.89E+00	5.90E+00	6.01E+00	5.86E+00	6.00E+00
692	5.83E+00	5.87E+00	5.88E+00	5.87E+00	5.98E+00	5.89E+00	5.79E+00
Biased Statistics							
Average Biased	5.96E+00	5.83E+00	5.68E+00	5.59E+00	5.39E+00	5.49E+00	5.64E+00
Std Dev Biased	2.41E-01	2.14E-01	2.63E-01	2.68E-01	2.60E-01	2.83E-01	2.17E-01
Ps90%/90% (+KTL) Biased	6.62E+00	6.42E+00	6.40E+00	6.33E+00	6.10E+00	6.27E+00	6.24E+00
Ps90%/90% (-KTL) Biased	5.29E+00	5.25E+00	4.96E+00	4.86E+00	4.68E+00	4.71E+00	5.05E+00
Un-Biased Statistics							
Average Un-Biased	5.92E+00	5.80E+00	5.78E+00	5.66E+00	5.52E+00	5.59E+00	5.74E+00
Std Dev Un-Biased	2.47E-01	3.33E-01	2.64E-01	2.69E-01	3.47E-01	3.04E-01	2.59E-01
Ps90%/90% (+KTL) Un-Biased	6.59E+00	6.71E+00	6.50E+00	6.40E+00	6.47E+00	6.42E+00	6.45E+00
Ps90%/90% (-KTL) Un-Biased	5.24E+00	4.89E+00	5.05E+00	4.92E+00	4.57E+00	4.76E+00	5.03E+00
Specification MIN	3.50E+00	3.00E+00	3.00E+00	3.00E+00	3.00E+00	3.00E+00	3.00E+00
Status	PASS	PASS	PASS	PASS	PASS	PASS	PASS

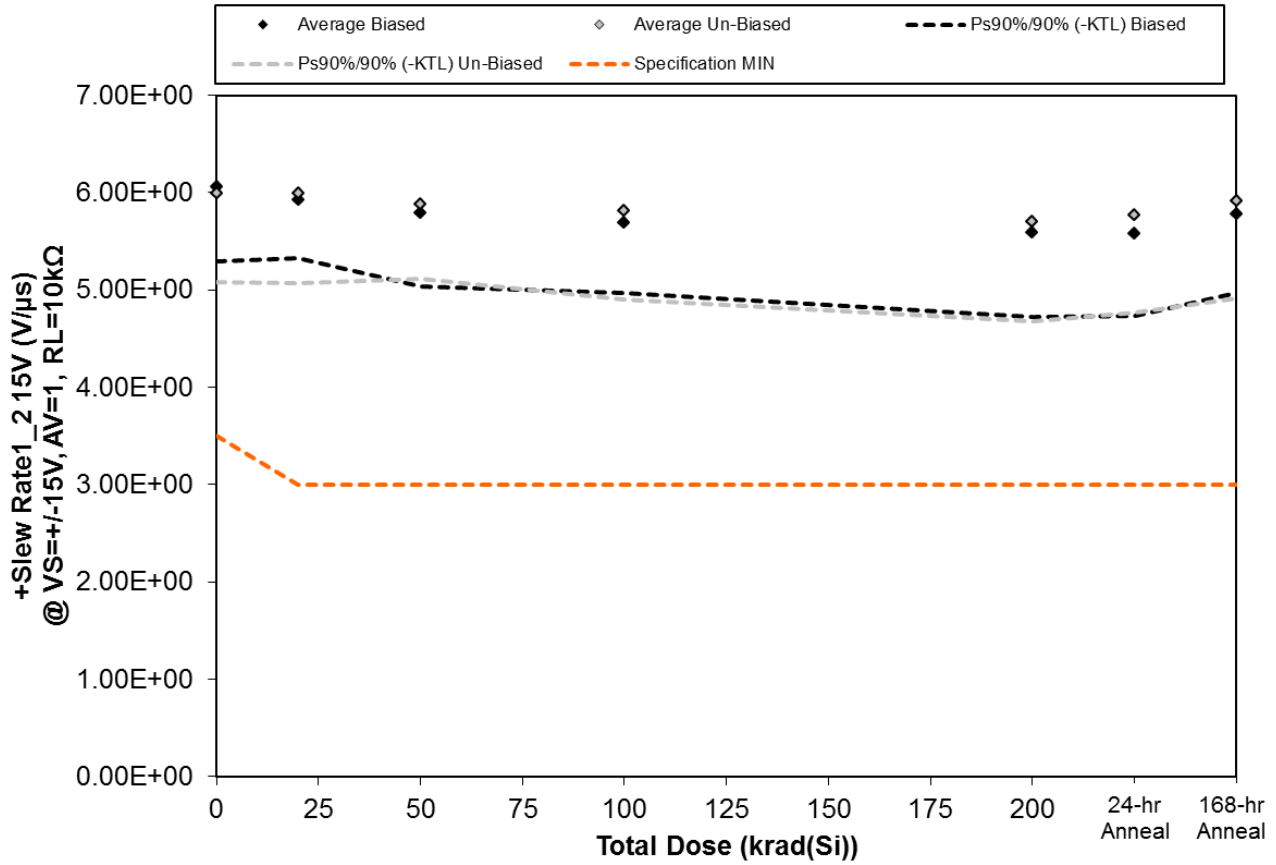

Figure 5.56. Plot of +Slew Rate1_2 15V (V/μs) @ VS=+-15V, AV=1, RL=10kΩ versus total dose. The solid diamonds are the average of the measured data points for the samples irradiated under electrical bias while the shaded diamonds are the average of the measured data points for the samples irradiated with all pins tied to ground. The black lines (solid and/or dashed) are the upper and/or lower confidence limits, as determined by KTL statistics, on the samples irradiated under electrical bias while the gray lines (solid and/or dashed) are the upper and/or lower confidence limits, as determined by KTL statistics, on the samples irradiated in the unbiased condition. The red dotted line(s) are the pre- and/or post-irradiation minimum and/or maximum specification value as defined in the datasheet and/or test plan.



TID Report
15-0091 03/20/15 R1.0

Aeroflex RAD
5030 Centennial Blvd.
Colorado Springs, CO 80919
(719) 531-0800

Table 5.56. Raw data for +Slew Rate1_2 15V (V/μs) @ VS=+/-15V, AV=1, RL=10kΩ versus total dose, including the statistical analysis, specification and the status of the testing (pass/fail).

+Slew Rate1_2 15V (V/μs) @ VS=+/-15V, AV=1, RL=10kΩ	Total Dose (krad(Si))					24-hr	168-hr
	0	20	50	100	200	Anneal	Anneal
Device							
680	6.07E+00	5.97E+00	5.73E+00	5.55E+00	5.47E+00	5.47E+00	5.72E+00
681	5.82E+00	5.79E+00	5.78E+00	5.62E+00	5.50E+00	5.44E+00	5.66E+00
682	6.38E+00	6.20E+00	6.21E+00	6.03E+00	6.00E+00	6.03E+00	6.13E+00
683	5.74E+00	5.64E+00	5.44E+00	5.38E+00	5.18E+00	5.23E+00	5.38E+00
684	6.28E+00	6.05E+00	5.80E+00	5.90E+00	5.78E+00	5.73E+00	6.01E+00
685	5.72E+00	5.79E+00	5.63E+00	5.55E+00	5.48E+00	5.47E+00	5.61E+00
686	5.86E+00	5.82E+00	5.76E+00	5.78E+00	5.64E+00	5.69E+00	5.89E+00
688	6.53E+00	6.58E+00	6.36E+00	6.38E+00	6.37E+00	6.40E+00	6.54E+00
689	5.77E+00	5.81E+00	5.83E+00	5.60E+00	5.53E+00	5.60E+00	5.75E+00
690	6.09E+00	5.95E+00	5.83E+00	5.74E+00	5.52E+00	5.69E+00	5.78E+00
691	5.91E+00	5.88E+00	6.00E+00	5.98E+00	5.95E+00	5.93E+00	6.04E+00
692	5.98E+00	6.08E+00	6.01E+00	5.93E+00	5.96E+00	5.99E+00	6.05E+00
Biased Statistics							
Average Biased	6.06E+00	5.93E+00	5.79E+00	5.70E+00	5.59E+00	5.58E+00	5.78E+00
Std Dev Biased	2.79E-01	2.19E-01	2.75E-01	2.65E-01	3.14E-01	3.08E-01	2.97E-01
Ps90%/90% (+KTL) Biased	6.82E+00	6.53E+00	6.55E+00	6.42E+00	6.45E+00	6.42E+00	6.60E+00
Ps90%/90% (-KTL) Biased	5.29E+00	5.33E+00	5.04E+00	4.97E+00	4.72E+00	4.74E+00	4.96E+00
Un-Biased Statistics							
Average Un-Biased	5.99E+00	5.99E+00	5.88E+00	5.81E+00	5.71E+00	5.77E+00	5.91E+00
Std Dev Un-Biased	3.32E-01	3.36E-01	2.79E-01	3.33E-01	3.75E-01	3.64E-01	3.64E-01
Ps90%/90% (+KTL) Un-Biased	6.90E+00	6.91E+00	6.65E+00	6.72E+00	6.74E+00	6.77E+00	6.91E+00
Ps90%/90% (-KTL) Un-Biased	5.08E+00	5.07E+00	5.12E+00	4.90E+00	4.68E+00	4.77E+00	4.92E+00
Specification MIN	3.50E+00	3.00E+00	3.00E+00	3.00E+00	3.00E+00	3.00E+00	3.00E+00
Status	PASS	PASS	PASS	PASS	PASS	PASS	PASS

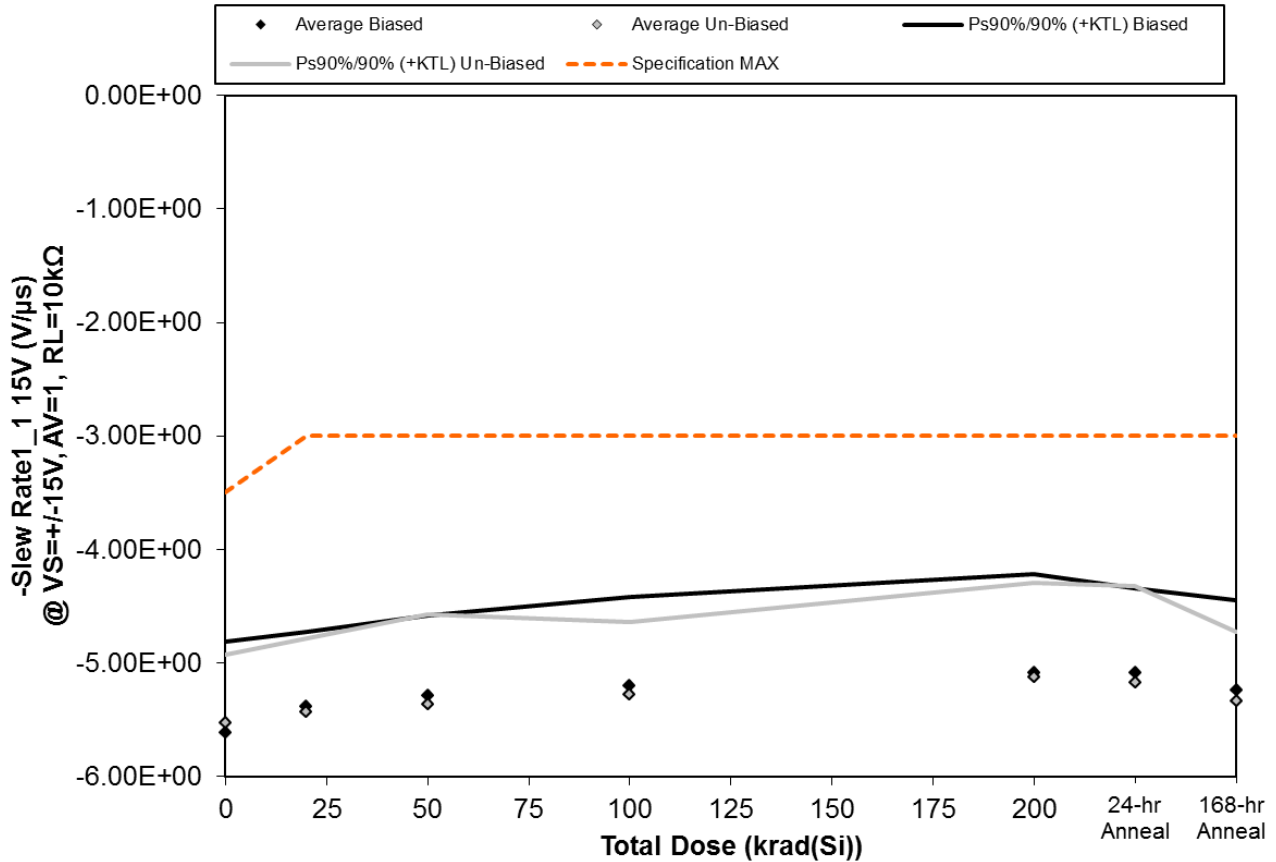

Figure 5.57. Plot of -Slew Rate1_1 15V (V/μs) @ VS=+-15V, AV=1, RL=10kΩ versus total dose. The solid diamonds are the average of the measured data points for the samples irradiated under electrical bias while the shaded diamonds are the average of the measured data points for the samples irradiated with all pins tied to ground. The black lines (solid and/or dashed) are the upper and/or lower confidence limits, as determined by KTL statistics, on the samples irradiated under electrical bias while the gray lines (solid and/or dashed) are the upper and/or lower confidence limits, as determined by KTL statistics, on the samples irradiated in the unbiased condition. The red dotted line(s) are the pre- and/or post-irradiation minimum and/or maximum specification value as defined in the datasheet and/or test plan.



**TID Report
15-0091 03/20/15 R1.0**

**Aeroflex RAD
5030 Centennial Blvd.
Colorado Springs, CO 80919
(719) 531-0800**

Table 5.57. Raw data for -Slew Rate1_1 15V (V/μs) @ VS=+/-15V, AV=1, RL=10kΩ versus total dose, including the statistical analysis, specification and the status of the testing (pass/fail).

-Slew Rate1_1 15V (V/μs) @ VS=+/-15V, AV=1, RL=10kΩ	Total Dose (krad(Si))					24-hr	168-hr
	0	20	50	100	200	Anneal	Anneal
Device							
680	-5.69E+00	-5.45E+00	-5.25E+00	-5.24E+00	-4.97E+00	-5.06E+00	-5.26E+00
681	-5.48E+00	-5.17E+00	-5.18E+00	-5.00E+00	-5.01E+00	-4.94E+00	-5.04E+00
682	-5.99E+00	-5.72E+00	-5.63E+00	-5.59E+00	-5.56E+00	-5.54E+00	-5.64E+00
683	-5.20E+00	-5.13E+00	-4.95E+00	-4.86E+00	-4.70E+00	-4.82E+00	-4.90E+00
684	-5.68E+00	-5.45E+00	-5.43E+00	-5.32E+00	-5.20E+00	-5.08E+00	-5.37E+00
685	-5.30E+00	-5.17E+00	-5.07E+00	-5.11E+00	-4.91E+00	-4.88E+00	-5.10E+00
686	-5.50E+00	-5.36E+00	-5.35E+00	-5.20E+00	-4.96E+00	-5.11E+00	-5.34E+00
688	-5.88E+00	-5.78E+00	-5.84E+00	-5.67E+00	-5.65E+00	-5.69E+00	-5.69E+00
689	-5.40E+00	-5.30E+00	-5.23E+00	-5.11E+00	-5.10E+00	-5.03E+00	-5.23E+00
690	-5.57E+00	-5.52E+00	-5.32E+00	-5.30E+00	-4.99E+00	-5.12E+00	-5.30E+00
691	-5.50E+00	-5.61E+00	-5.50E+00	-5.53E+00	-5.58E+00	-5.55E+00	-5.54E+00
692	-5.40E+00	-5.47E+00	-5.49E+00	-5.42E+00	-5.46E+00	-5.44E+00	-5.44E+00
Biased Statistics							
Average Biased	-5.61E+00	-5.38E+00	-5.29E+00	-5.20E+00	-5.09E+00	-5.09E+00	-5.24E+00
Std Dev Biased	2.92E-01	2.41E-01	2.57E-01	2.84E-01	3.19E-01	2.73E-01	2.88E-01
Ps90%/90% (+KTL) Biased	-4.81E+00	-4.72E+00	-4.58E+00	-4.42E+00	-4.21E+00	-4.34E+00	-4.45E+00
Ps90%/90% (-KTL) Biased	-6.41E+00	-6.04E+00	-5.99E+00	-5.98E+00	-5.96E+00	-5.84E+00	-6.03E+00
Un-Biased Statistics							
Average Un-Biased	-5.53E+00	-5.43E+00	-5.36E+00	-5.28E+00	-5.12E+00	-5.17E+00	-5.33E+00
Std Dev Un-Biased	2.21E-01	2.34E-01	2.89E-01	2.33E-01	3.03E-01	3.08E-01	2.20E-01
Ps90%/90% (+KTL) Un-Biased	-4.92E+00	-4.78E+00	-4.57E+00	-4.64E+00	-4.29E+00	-4.32E+00	-4.73E+00
Ps90%/90% (-KTL) Un-Biased	-6.14E+00	-6.07E+00	-6.15E+00	-5.92E+00	-5.95E+00	-6.01E+00	-5.94E+00
Specification MAX	-3.50E+00	-3.00E+00	-3.00E+00	-3.00E+00	-3.00E+00	-3.00E+00	-3.00E+00
Status	PASS	PASS	PASS	PASS	PASS	PASS	PASS

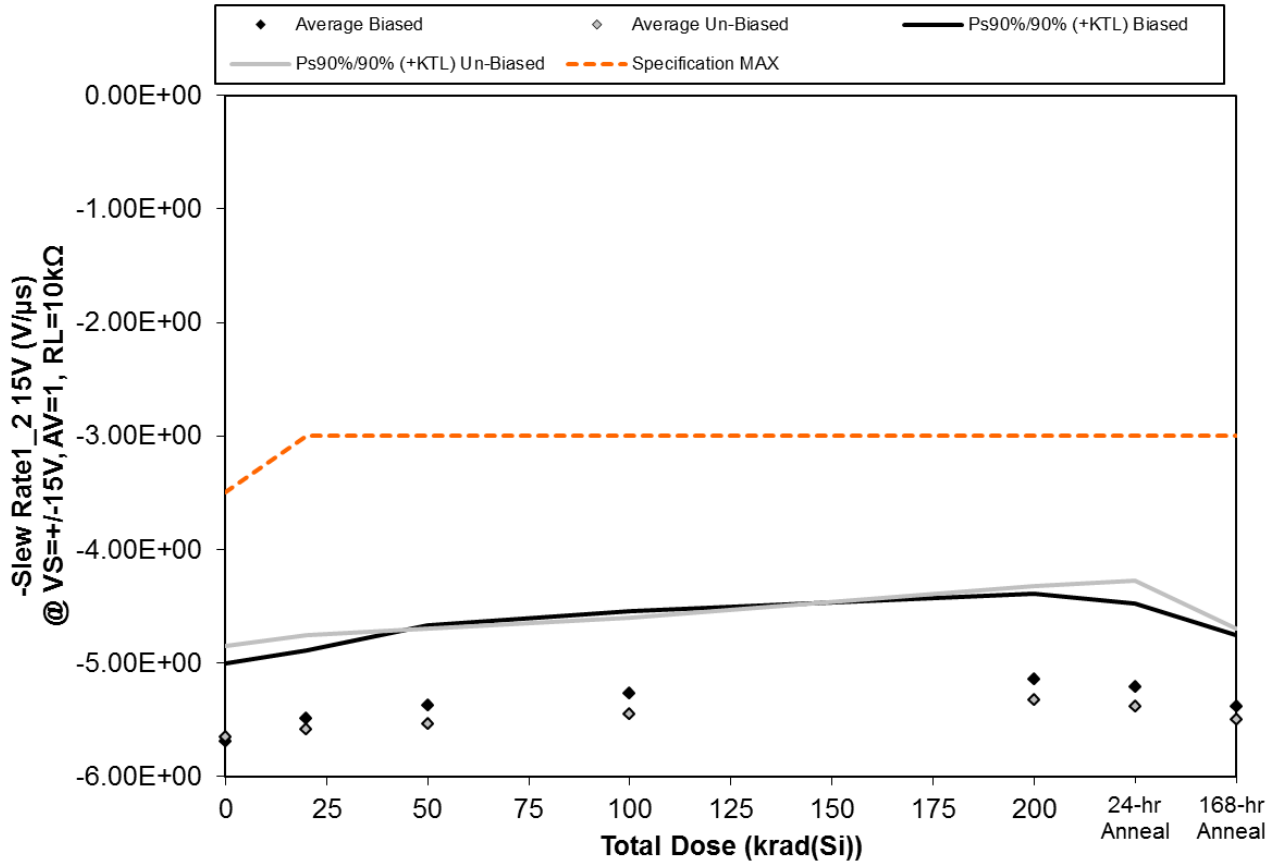

Figure 5.58. Plot of -Slew Rate1_2 15V (V/μs) @ VS=+-15V, AV=1, RL=10kΩ versus total dose. The solid diamonds are the average of the measured data points for the samples irradiated under electrical bias while the shaded diamonds are the average of the measured data points for the samples irradiated with all pins tied to ground. The black lines (solid and/or dashed) are the upper and/or lower confidence limits, as determined by KTL statistics, on the samples irradiated under electrical bias while the gray lines (solid and/or dashed) are the upper and/or lower confidence limits, as determined by KTL statistics, on the samples irradiated in the unbiased condition. The red dotted line(s) are the pre- and/or post-irradiation minimum and/or maximum specification value as defined in the datasheet and/or test plan.



TID Report
15-0091 03/20/15 R1.0

Aeroflex RAD
5030 Centennial Blvd.
Colorado Springs, CO 80919
(719) 531-0800

Table 5.58. Raw data for -Slew Rate1_2 15V (V/μs) @ VS=+/-15V, AV=1, RL=10kΩ versus total dose, including the statistical analysis, specification and the status of the testing (pass/fail).

-Slew Rate1_2 15V (V/μs) @ VS=+/-15V, AV=1, RL=10kΩ	Total Dose (krad(Si))					24-hr	168-hr
	0	20	50	100	200	Anneal	Anneal
Device							
680	-5.73E+00	-5.41E+00	-5.24E+00	-5.25E+00	-5.07E+00	-4.99E+00	-5.24E+00
681	-5.61E+00	-5.50E+00	-5.28E+00	-5.10E+00	-5.10E+00	-5.16E+00	-5.22E+00
682	-6.05E+00	-5.83E+00	-5.74E+00	-5.60E+00	-5.54E+00	-5.63E+00	-5.69E+00
683	-5.36E+00	-5.22E+00	-5.09E+00	-4.94E+00	-4.78E+00	-4.98E+00	-5.20E+00
684	-5.68E+00	-5.50E+00	-5.52E+00	-5.45E+00	-5.24E+00	-5.29E+00	-5.57E+00
685	-5.37E+00	-5.28E+00	-5.26E+00	-5.29E+00	-5.14E+00	-5.12E+00	-5.24E+00
686	-5.58E+00	-5.57E+00	-5.42E+00	-5.24E+00	-5.23E+00	-5.19E+00	-5.40E+00
688	-6.12E+00	-6.04E+00	-6.05E+00	-5.99E+00	-5.98E+00	-6.10E+00	-5.98E+00
689	-5.47E+00	-5.35E+00	-5.39E+00	-5.31E+00	-5.13E+00	-5.24E+00	-5.32E+00
690	-5.70E+00	-5.70E+00	-5.56E+00	-5.41E+00	-5.15E+00	-5.26E+00	-5.55E+00
691	-5.60E+00	-5.57E+00	-5.65E+00	-5.63E+00	-5.65E+00	-5.64E+00	-5.60E+00
692	-5.74E+00	-5.67E+00	-5.70E+00	-5.66E+00	-5.73E+00	-5.63E+00	-5.61E+00
Biased Statistics							
Average Biased	-5.69E+00	-5.49E+00	-5.37E+00	-5.27E+00	-5.15E+00	-5.21E+00	-5.38E+00
Std Dev Biased	2.48E-01	2.21E-01	2.56E-01	2.64E-01	2.77E-01	2.68E-01	2.29E-01
Ps90%/90% (+KTL) Biased	-5.01E+00	-4.89E+00	-4.67E+00	-4.54E+00	-4.39E+00	-4.48E+00	-4.76E+00
Ps90%/90% (-KTL) Biased	-6.37E+00	-6.10E+00	-6.08E+00	-5.99E+00	-5.90E+00	-5.94E+00	-6.01E+00
Un-Biased Statistics							
Average Un-Biased	-5.65E+00	-5.59E+00	-5.54E+00	-5.45E+00	-5.33E+00	-5.38E+00	-5.50E+00
Std Dev Un-Biased	2.91E-01	3.04E-01	3.06E-01	3.09E-01	3.68E-01	4.05E-01	2.93E-01
Ps90%/90% (+KTL) Un-Biased	-4.85E+00	-4.76E+00	-4.70E+00	-4.60E+00	-4.32E+00	-4.27E+00	-4.70E+00
Ps90%/90% (-KTL) Un-Biased	-6.45E+00	-6.42E+00	-6.38E+00	-6.30E+00	-6.33E+00	-6.49E+00	-6.30E+00
Specification MAX	-3.50E+00	-3.00E+00	-3.00E+00	-3.00E+00	-3.00E+00	-3.00E+00	-3.00E+00
Status	PASS	PASS	PASS	PASS	PASS	PASS	PASS

An ISO 9001:2008 and DLA Certified Company

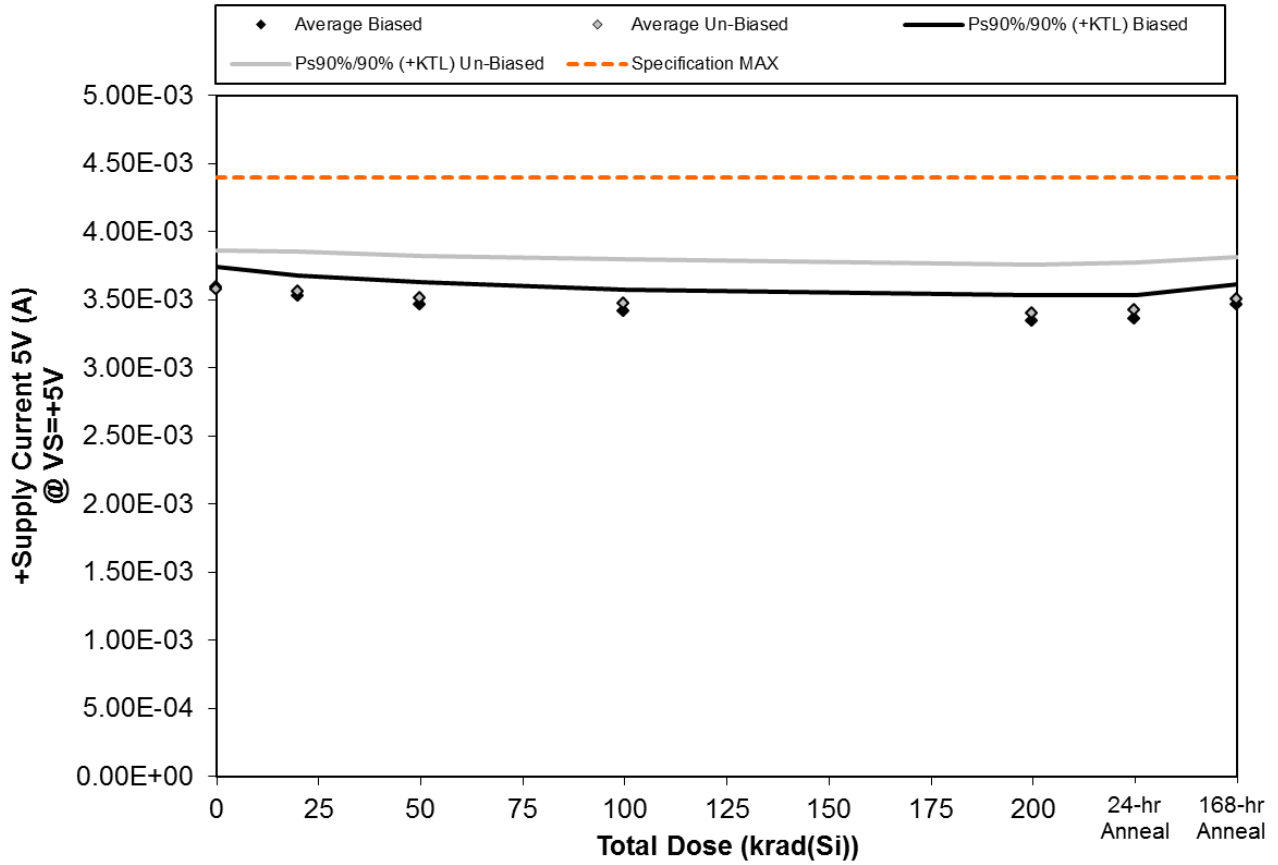

Figure 5.59. Plot of +Supply Current 5V (A) @ VS=+5V versus total dose. The solid diamonds are the average of the measured data points for the samples irradiated under electrical bias while the shaded diamonds are the average of the measured data points for the samples irradiated with all pins tied to ground. The black lines (solid and/or dashed) are the upper and/or lower confidence limits, as determined by KTL statistics, on the samples irradiated under electrical bias while the gray lines (solid and/or dashed) are the upper and/or lower confidence limits, as determined by KTL statistics, on the samples irradiated in the unbiased condition. The red dotted line(s) are the pre- and/or post-irradiation minimum and/or maximum specification value as defined in the datasheet and/or test plan.



TID Report
15-0091 03/20/15 R1.0

Aeroflex RAD
5030 Centennial Blvd.
Colorado Springs, CO 80919
(719) 531-0800

Table 5.59. Raw data for +Supply Current 5V (A) @ VS=+5V versus total dose, including the statistical analysis, specification and the status of the testing (pass/fail).

+Supply Current 5V (A) @ VS=+5V	Total Dose (krad(Si))					24-hr Anneal	168-hr Anneal
	0	20	50	100	200		
Device							
680	3.57E-03	3.50E-03	3.43E-03	3.40E-03	3.28E-03	3.31E-03	3.43E-03
681	3.54E-03	3.47E-03	3.41E-03	3.36E-03	3.28E-03	3.31E-03	3.41E-03
682	3.67E-03	3.61E-03	3.55E-03	3.50E-03	3.44E-03	3.45E-03	3.54E-03
683	3.56E-03	3.50E-03	3.45E-03	3.39E-03	3.34E-03	3.35E-03	3.44E-03
684	3.62E-03	3.56E-03	3.50E-03	3.45E-03	3.39E-03	3.40E-03	3.50E-03
685	3.50E-03	3.48E-03	3.44E-03	3.38E-03	3.32E-03	3.34E-03	3.42E-03
686	3.52E-03	3.49E-03	3.44E-03	3.40E-03	3.32E-03	3.35E-03	3.44E-03
688	3.76E-03	3.74E-03	3.71E-03	3.68E-03	3.63E-03	3.65E-03	3.70E-03
689	3.55E-03	3.53E-03	3.49E-03	3.45E-03	3.38E-03	3.41E-03	3.48E-03
690	3.57E-03	3.58E-03	3.49E-03	3.44E-03	3.35E-03	3.38E-03	3.49E-03
691	3.57E-03	3.57E-03	3.57E-03	3.57E-03	3.57E-03	3.57E-03	3.57E-03
692	3.55E-03	3.56E-03	3.55E-03	3.56E-03	3.56E-03	3.55E-03	3.56E-03
Biased Statistics							
Average Biased	3.59E-03	3.53E-03	3.47E-03	3.42E-03	3.34E-03	3.36E-03	3.46E-03
Std Dev Biased	5.39E-05	5.33E-05	5.85E-05	5.55E-05	6.82E-05	6.32E-05	5.52E-05
Ps90%/90% (+KTL) Biased	3.74E-03	3.67E-03	3.63E-03	3.57E-03	3.53E-03	3.54E-03	3.61E-03
Ps90%/90% (-KTL) Biased	3.44E-03	3.38E-03	3.31E-03	3.27E-03	3.16E-03	3.19E-03	3.31E-03
Un-Biased Statistics							
Average Un-Biased	3.58E-03	3.56E-03	3.51E-03	3.47E-03	3.40E-03	3.42E-03	3.51E-03
Std Dev Un-Biased	1.03E-04	1.07E-04	1.13E-04	1.20E-04	1.30E-04	1.29E-04	1.13E-04
Ps90%/90% (+KTL) Un-Biased	3.86E-03	3.85E-03	3.82E-03	3.80E-03	3.76E-03	3.78E-03	3.82E-03
Ps90%/90% (-KTL) Un-Biased	3.30E-03	3.27E-03	3.20E-03	3.14E-03	3.04E-03	3.07E-03	3.20E-03
Specification MAX	4.40E-03	4.40E-03	4.40E-03	4.40E-03	4.40E-03	4.40E-03	4.40E-03
Status	PASS	PASS	PASS	PASS	PASS	PASS	PASS

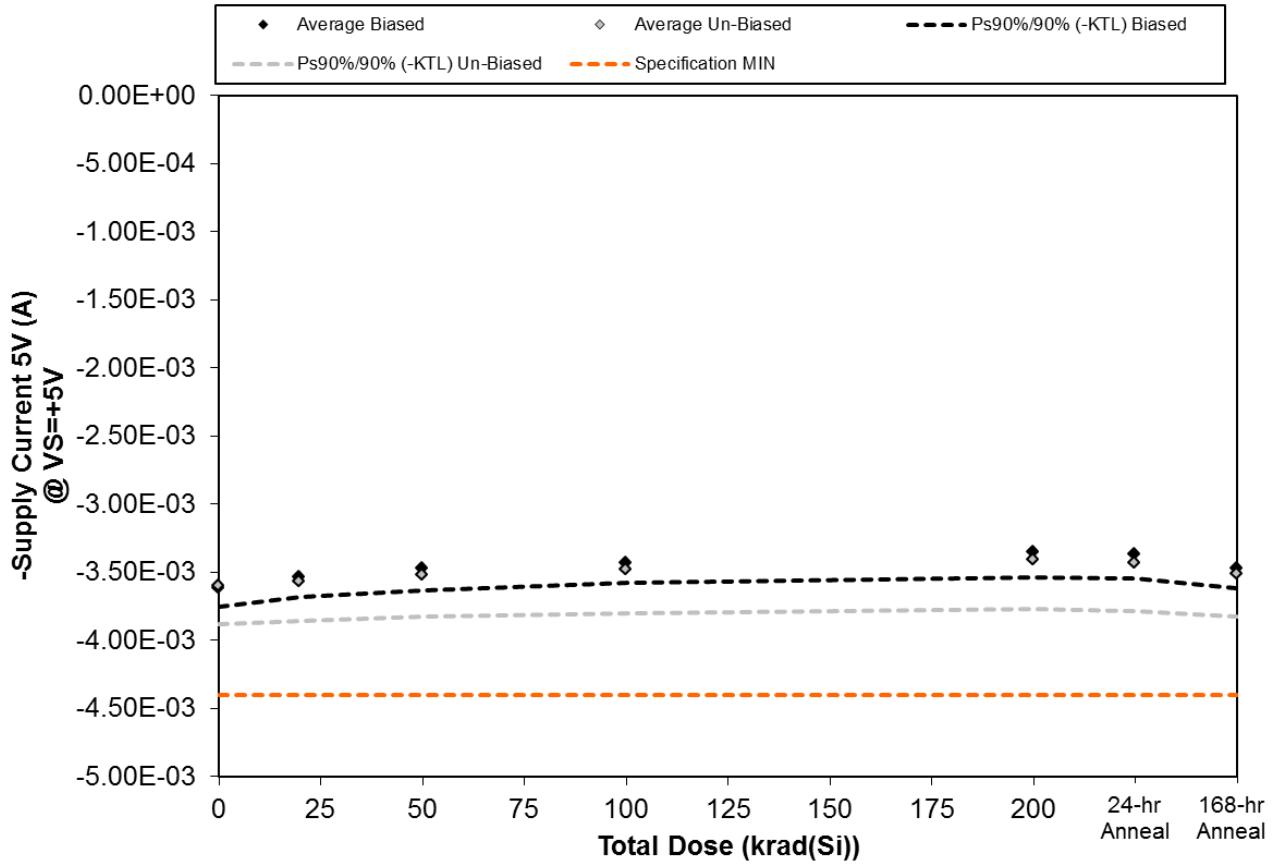

Figure 5.60. Plot of -Supply Current 5V (A) @ VS=+5V versus total dose. The solid diamonds are the average of the measured data points for the samples irradiated under electrical bias while the shaded diamonds are the average of the measured data points for the samples irradiated with all pins tied to ground. The black lines (solid and/or dashed) are the upper and/or lower confidence limits, as determined by KTL statistics, on the samples irradiated under electrical bias while the gray lines (solid and/or dashed) are the upper and/or lower confidence limits, as determined by KTL statistics, on the samples irradiated in the unbiased condition. The red dotted line(s) are the pre- and/or post-irradiation minimum and/or maximum specification value as defined in the datasheet and/or test plan.



TID Report
15-0091 03/20/15 R1.0

Aeroflex RAD
5030 Centennial Blvd.
Colorado Springs, CO 80919
(719) 531-0800

Table 5.60. Raw data for -Supply Current 5V (A) @ VS=+5V versus total dose, including the statistical analysis, specification and the status of the testing (pass/fail).

-Supply Current 5V (A) @ VS=+5V	Total Dose (krad(Si))					24-hr Anneal	168-hr Anneal
	0	20	50	100	200		
Device							
680	-3.59E-03	-3.51E-03	-3.43E-03	-3.41E-03	-3.28E-03	-3.31E-03	-3.43E-03
681	-3.56E-03	-3.48E-03	-3.42E-03	-3.37E-03	-3.29E-03	-3.31E-03	-3.41E-03
682	-3.69E-03	-3.61E-03	-3.56E-03	-3.51E-03	-3.45E-03	-3.46E-03	-3.55E-03
683	-3.58E-03	-3.51E-03	-3.45E-03	-3.40E-03	-3.34E-03	-3.35E-03	-3.45E-03
684	-3.64E-03	-3.57E-03	-3.51E-03	-3.45E-03	-3.39E-03	-3.41E-03	-3.50E-03
685	-3.52E-03	-3.48E-03	-3.44E-03	-3.39E-03	-3.33E-03	-3.34E-03	-3.43E-03
686	-3.54E-03	-3.49E-03	-3.45E-03	-3.40E-03	-3.33E-03	-3.35E-03	-3.45E-03
688	-3.77E-03	-3.74E-03	-3.71E-03	-3.69E-03	-3.64E-03	-3.65E-03	-3.71E-03
689	-3.57E-03	-3.53E-03	-3.49E-03	-3.46E-03	-3.39E-03	-3.41E-03	-3.49E-03
690	-3.59E-03	-3.58E-03	-3.50E-03	-3.45E-03	-3.35E-03	-3.38E-03	-3.49E-03
691	-3.58E-03	-3.58E-03	-3.57E-03	-3.58E-03	-3.58E-03	-3.57E-03	-3.58E-03
692	-3.57E-03	-3.56E-03	-3.56E-03	-3.56E-03	-3.56E-03	-3.56E-03	-3.56E-03
Biased Statistics							
Average Biased	-3.61E-03	-3.53E-03	-3.47E-03	-3.43E-03	-3.35E-03	-3.37E-03	-3.47E-03
Std Dev Biased	5.17E-05	5.36E-05	5.76E-05	5.54E-05	6.78E-05	6.49E-05	5.55E-05
Ps90%/90% (+KTL) Biased	-3.47E-03	-3.39E-03	-3.31E-03	-3.28E-03	-3.16E-03	-3.19E-03	-3.32E-03
Ps90%/90% (-KTL) Biased	-3.75E-03	-3.68E-03	-3.63E-03	-3.58E-03	-3.54E-03	-3.55E-03	-3.62E-03
Un-Biased Statistics							
Average Un-Biased	-3.60E-03	-3.57E-03	-3.52E-03	-3.48E-03	-3.41E-03	-3.43E-03	-3.51E-03
Std Dev Un-Biased	1.03E-04	1.06E-04	1.12E-04	1.20E-04	1.32E-04	1.29E-04	1.13E-04
Ps90%/90% (+KTL) Un-Biased	-3.32E-03	-3.28E-03	-3.21E-03	-3.15E-03	-3.05E-03	-3.08E-03	-3.20E-03
Ps90%/90% (-KTL) Un-Biased	-3.88E-03	-3.86E-03	-3.83E-03	-3.81E-03	-3.77E-03	-3.78E-03	-3.82E-03
Specification MIN	-4.40E-03	-4.40E-03	-4.40E-03	-4.40E-03	-4.40E-03	-4.40E-03	-4.40E-03
Status	PASS	PASS	PASS	PASS	PASS	PASS	PASS

An ISO 9001:2008 and DLA Certified Company

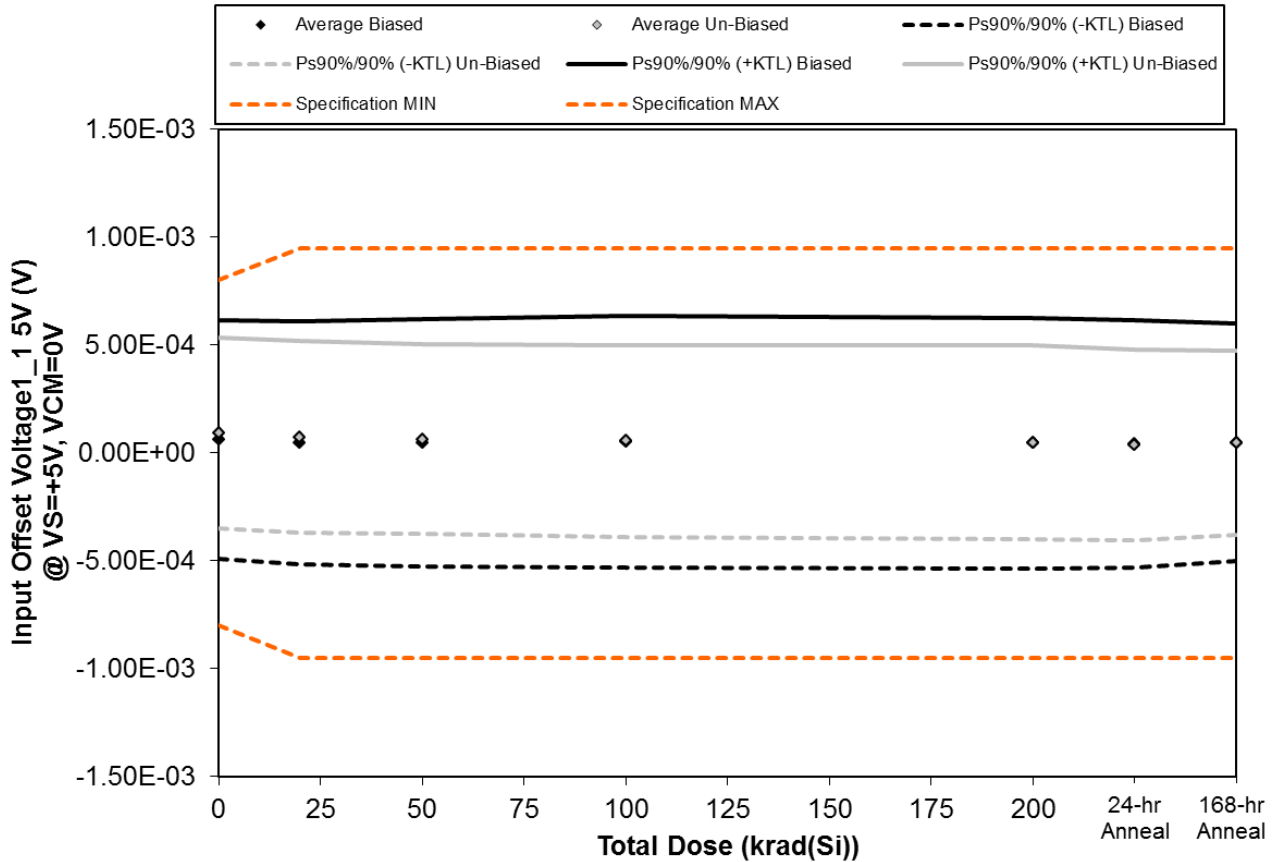

Figure 5.61. Plot of Input Offset Voltage1_1 5V (V) @ VS=+5V, VCM=0V versus total dose. The solid diamonds are the average of the measured data points for the samples irradiated under electrical bias while the shaded diamonds are the average of the measured data points for the samples irradiated with all pins tied to ground. The black lines (solid and/or dashed) are the upper and/or lower confidence limits, as determined by KTL statistics, on the samples irradiated under electrical bias while the gray lines (solid and/or dashed) are the upper and/or lower confidence limits, as determined by KTL statistics, on the samples irradiated in the unbiased condition. The red dotted line(s) are the pre- and/or post-irradiation minimum and/or maximum specification value as defined in the datasheet and/or test plan.



TID Report
15-0091 03/20/15 R1.0

Aeroflex RAD
5030 Centennial Blvd.
Colorado Springs, CO 80919
(719) 531-0800

Table 5.61. Raw data for Input Offset Voltage_{1_1} 5V (V) @ VS=+5V, VCM=0V versus total dose, including the statistical analysis, specification and the status of the testing (pass/fail).

Input Offset Voltage _{1_1} 5V (V) @ VS=+5V, VCM=0V	Total Dose (krad(Si))					24-hr	168-hr
	0	20	50	100	200	Anneal	Anneal
Device							
680	3.61E-04	3.46E-04	3.47E-04	3.54E-04	3.38E-04	3.36E-04	3.36E-04
681	-1.69E-04	-1.94E-04	-1.99E-04	-2.01E-04	-2.08E-04	-2.09E-04	-1.87E-04
682	-4.19E-05	-6.10E-05	-7.05E-05	-7.69E-05	-8.96E-05	-8.21E-05	-6.32E-05
683	1.61E-05	1.11E-05	1.66E-05	3.03E-05	3.24E-05	1.93E-05	1.70E-05
684	1.46E-04	1.38E-04	1.44E-04	1.49E-04	1.48E-04	1.41E-04	1.41E-04
685	4.21E-05	2.79E-05	1.22E-05	3.36E-06	-2.00E-07	-1.33E-05	-9.52E-06
686	1.29E-04	1.20E-04	1.13E-04	1.08E-04	1.05E-04	9.23E-05	8.85E-05
688	-1.57E-04	-1.82E-04	-1.90E-04	-1.99E-04	-2.13E-04	-2.17E-04	-1.92E-04
689	2.59E-04	2.36E-04	2.23E-04	2.13E-04	2.09E-04	1.94E-04	2.09E-04
690	1.91E-04	1.68E-04	1.53E-04	1.51E-04	1.40E-04	1.34E-04	1.36E-04
691	-1.49E-04	-1.48E-04	-1.50E-04	-1.48E-04	-1.50E-04	-1.50E-04	-1.49E-04
692	-2.60E-04	-2.58E-04	-2.59E-04	-2.60E-04	-2.60E-04	-2.60E-04	-2.61E-04
Biased Statistics							
Average Biased	6.25E-05	4.80E-05	4.77E-05	5.13E-05	4.41E-05	4.10E-05	4.85E-05
Std Dev Biased	2.01E-04	2.05E-04	2.09E-04	2.13E-04	2.11E-04	2.09E-04	2.00E-04
Ps90%/90% (+KTL) Biased	6.15E-04	6.10E-04	6.20E-04	6.36E-04	6.23E-04	6.15E-04	5.97E-04
Ps90%/90% (-KTL) Biased	-4.90E-04	-5.14E-04	-5.25E-04	-5.33E-04	-5.35E-04	-5.33E-04	-5.00E-04
Un-Biased Statistics							
Average Un-Biased	9.26E-05	7.38E-05	6.24E-05	5.53E-05	4.84E-05	3.78E-05	4.63E-05
Std Dev Un-Biased	1.61E-04	1.62E-04	1.60E-04	1.61E-04	1.64E-04	1.61E-04	1.55E-04
Ps90%/90% (+KTL) Un-Biased	5.34E-04	5.18E-04	5.02E-04	4.98E-04	4.99E-04	4.80E-04	4.72E-04
Ps90%/90% (-KTL) Un-Biased	-3.49E-04	-3.70E-04	-3.77E-04	-3.88E-04	-4.02E-04	-4.05E-04	-3.80E-04
Specification MIN	-8.00E-04	-9.50E-04	-9.50E-04	-9.50E-04	-9.50E-04	-9.50E-04	-9.50E-04
Status	PASS	PASS	PASS	PASS	PASS	PASS	PASS
Specification MAX	8.00E-04	9.50E-04	9.50E-04	9.50E-04	9.50E-04	9.50E-04	9.50E-04
Status	PASS	PASS	PASS	PASS	PASS	PASS	PASS

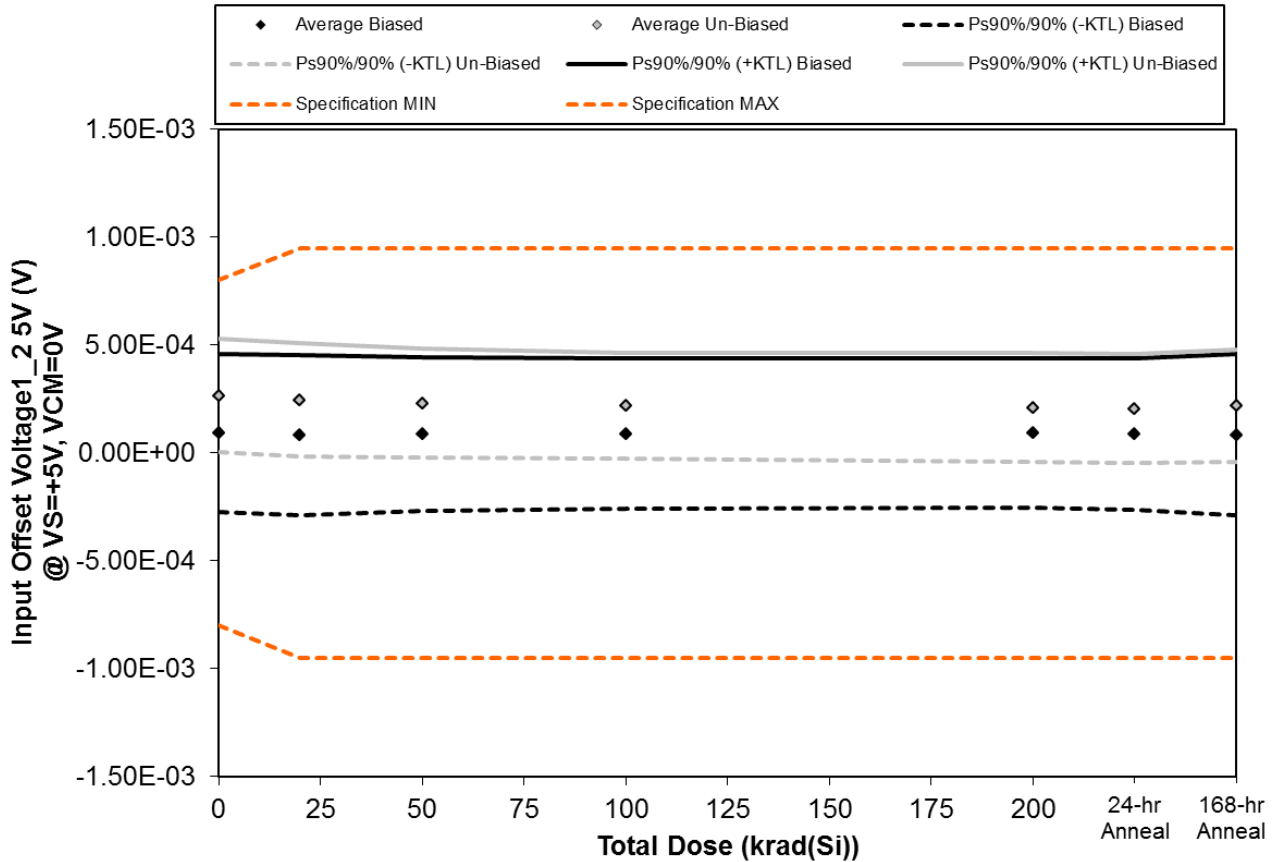

Figure 5.62. Plot of Input Offset Voltage1_2 5V (V) @ VS=+5V, VCM=0V versus total dose. The solid diamonds are the average of the measured data points for the samples irradiated under electrical bias while the shaded diamonds are the average of the measured data points for the samples irradiated with all pins tied to ground. The black lines (solid and/or dashed) are the upper and/or lower confidence limits, as determined by KTL statistics, on the samples irradiated under electrical bias while the gray lines (solid and/or dashed) are the upper and/or lower confidence limits, as determined by KTL statistics, on the samples irradiated in the unbiased condition. The red dotted line(s) are the pre- and/or post-irradiation minimum and/or maximum specification value as defined in the datasheet and/or test plan.



TID Report
15-0091 03/20/15 R1.0

Aeroflex RAD
5030 Centennial Blvd.
Colorado Springs, CO 80919
(719) 531-0800

Table 5.62. Raw data for Input Offset Voltage_{1_2} 5V (V) @ VS=+5V, VCM=0V versus total dose, including the statistical analysis, specification and the status of the testing (pass/fail).

Input Offset Voltage _{1_2} 5V (V) @ VS=+5V, VCM=0V	Total Dose (krad(Si))					24-hr	168-hr
	0	20	50	100	200	Anneal	Anneal
Device							
680	-1.23E-05	-1.84E-05	-6.76E-06	-8.32E-06	-1.98E-06	-1.44E-05	-1.97E-05
681	9.93E-05	8.95E-05	9.24E-05	9.26E-05	9.28E-05	9.55E-05	8.56E-05
682	-5.04E-05	-6.48E-05	-5.41E-05	-4.69E-05	-4.04E-05	-4.95E-05	-6.19E-05
683	1.38E-04	1.24E-04	1.25E-04	1.27E-04	1.31E-04	1.23E-04	1.31E-04
684	2.87E-04	2.79E-04	2.79E-04	2.76E-04	2.79E-04	2.75E-04	2.85E-04
685	4.03E-04	3.86E-04	3.64E-04	3.45E-04	3.41E-04	3.34E-04	3.54E-04
686	1.44E-04	1.26E-04	1.11E-04	9.70E-05	8.31E-05	7.88E-05	9.43E-05
688	2.87E-04	2.60E-04	2.50E-04	2.44E-04	2.31E-04	2.32E-04	2.38E-04
689	2.15E-04	1.99E-04	1.98E-04	1.86E-04	1.86E-04	1.79E-04	1.80E-04
690	2.75E-04	2.53E-04	2.29E-04	2.22E-04	2.10E-04	2.02E-04	2.22E-04
691	4.60E-05	4.57E-05	4.54E-05	4.75E-05	4.60E-05	4.63E-05	3.98E-05
692	1.94E-04	1.91E-04	1.91E-04	1.93E-04	1.92E-04	1.93E-04	1.96E-04
Biased Statistics							
Average Biased	9.23E-05	8.18E-05	8.69E-05	8.82E-05	9.20E-05	8.60E-05	8.41E-05
Std Dev Biased	1.34E-04	1.34E-04	1.29E-04	1.27E-04	1.25E-04	1.28E-04	1.37E-04
Ps90%/90% (+KTL) Biased	4.58E-04	4.51E-04	4.41E-04	4.36E-04	4.36E-04	4.37E-04	4.59E-04
Ps90%/90% (-KTL) Biased	-2.74E-04	-2.87E-04	-2.68E-04	-2.60E-04	-2.52E-04	-2.65E-04	-2.91E-04
Un-Biased Statistics							
Average Un-Biased	2.65E-04	2.45E-04	2.30E-04	2.19E-04	2.10E-04	2.05E-04	2.18E-04
Std Dev Un-Biased	9.60E-05	9.56E-05	9.18E-05	9.00E-05	9.27E-05	9.22E-05	9.44E-05
Ps90%/90% (+KTL) Un-Biased	5.28E-04	5.07E-04	4.82E-04	4.65E-04	4.64E-04	4.58E-04	4.77E-04
Ps90%/90% (-KTL) Un-Biased	1.53E-06	-1.72E-05	-2.12E-05	-2.82E-05	-4.39E-05	-4.75E-05	-4.10E-05
Specification MIN	-8.00E-04	-9.50E-04	-9.50E-04	-9.50E-04	-9.50E-04	-9.50E-04	-9.50E-04
Status	PASS	PASS	PASS	PASS	PASS	PASS	PASS
Specification MAX	8.00E-04	9.50E-04	9.50E-04	9.50E-04	9.50E-04	9.50E-04	9.50E-04
Status	PASS	PASS	PASS	PASS	PASS	PASS	PASS

An ISO 9001:2008 and DLA Certified Company

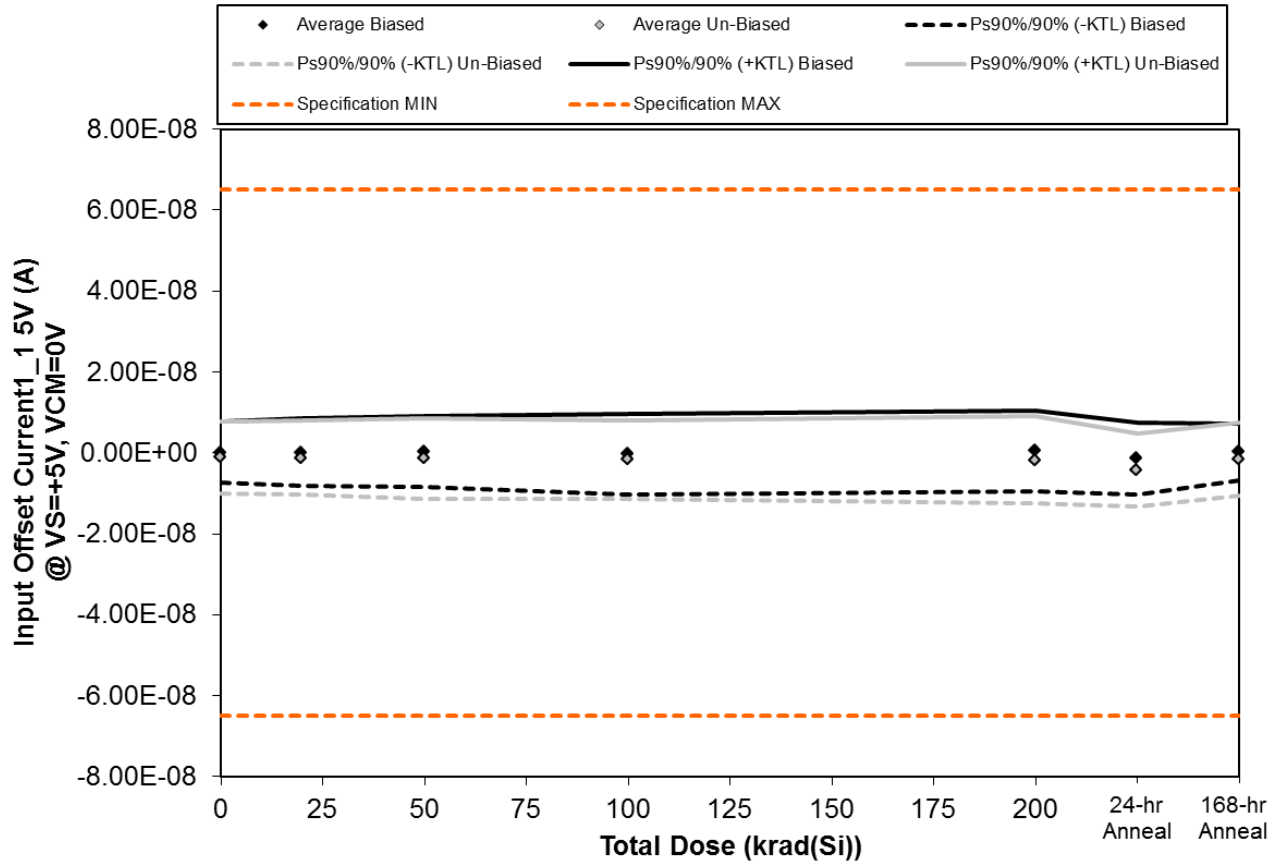

Figure 5.63. Plot of Input Offset Current1_1 5V (A) @ VS=+5V, VCM=0V versus total dose. The solid diamonds are the average of the measured data points for the samples irradiated under electrical bias while the shaded diamonds are the average of the measured data points for the samples irradiated with all pins tied to ground. The black lines (solid and/or dashed) are the upper and/or lower confidence limits, as determined by KTL statistics, on the samples irradiated under electrical bias while the gray lines (solid and/or dashed) are the upper and/or lower confidence limits, as determined by KTL statistics, on the samples irradiated in the unbiased condition. The red dotted line(s) are the pre- and/or post-irradiation minimum and/or maximum specification value as defined in the datasheet and/or test plan.



TID Report
15-0091 03/20/15 R1.0

Aeroflex RAD
5030 Centennial Blvd.
Colorado Springs, CO 80919
(719) 531-0800

Table 5.63. Raw data for Input Offset Current_{1_1} 5V (A) @ VS=+5V, VCM=0V versus total dose, including the statistical analysis, specification and the status of the testing (pass/fail).

Input Offset Current _{1_1} 5V (A) @ VS=+5V, VCM=0V	Total Dose (krad(Si))					24-hr Anneal	168-hr Anneal
	0	20	50	100	200		
Device							
680	3.10E-09	3.00E-09	2.19E-09	-2.14E-09	1.08E-09	8.40E-10	2.53E-09
681	-3.95E-09	-4.55E-09	-4.60E-09	-3.70E-09	-3.34E-09	-6.02E-09	-3.60E-09
682	2.00E-10	9.00E-11	-3.20E-10	-1.41E-09	-2.07E-09	-2.78E-09	-5.50E-10
683	2.00E-09	2.82E-09	3.81E-09	5.75E-09	6.17E-09	2.25E-09	2.39E-09
684	-4.00E-10	-4.50E-10	7.60E-10	7.00E-11	6.30E-10	-1.10E-09	2.90E-10
685	-3.82E-09	-3.63E-09	-4.68E-09	-5.66E-09	-6.24E-09	-7.36E-09	-4.00E-09
686	-1.53E-09	-1.30E-09	-1.59E-09	-1.66E-09	-3.30E-10	-4.34E-09	-1.69E-09
688	-2.40E-09	-2.60E-09	-2.38E-09	-4.00E-09	-5.02E-09	-6.45E-09	-3.31E-09
689	4.46E-09	4.61E-09	4.84E-09	3.61E-09	3.58E-09	1.12E-09	4.23E-09
690	-2.33E-09	-3.00E-09	-3.19E-09	-6.90E-10	-4.80E-10	-4.16E-09	-2.87E-09
691	-2.07E-09	-2.13E-09	-2.23E-09	-2.33E-09	-2.45E-09	-2.48E-09	-2.57E-09
692	-7.11E-09	-7.10E-09	-7.20E-09	-7.28E-09	-7.33E-09	-7.37E-09	-7.35E-09
Biased Statistics							
Average Biased	1.90E-10	1.82E-10	3.68E-10	-2.86E-10	4.94E-10	-1.36E-09	2.12E-10
Std Dev Biased	2.70E-09	3.07E-09	3.18E-09	3.64E-09	3.67E-09	3.23E-09	2.51E-09
Ps90%/90% (+KTL) Biased	7.60E-09	8.60E-09	9.09E-09	9.69E-09	1.06E-08	7.49E-09	7.10E-09
Ps90%/90% (-KTL) Biased	-7.22E-09	-8.24E-09	-8.35E-09	-1.03E-08	-9.57E-09	-1.02E-08	-6.68E-09
Un-Biased Statistics							
Average Un-Biased	-1.12E-09	-1.18E-09	-1.40E-09	-1.68E-09	-1.70E-09	-4.24E-09	-1.53E-09
Std Dev Un-Biased	3.23E-09	3.35E-09	3.67E-09	3.54E-09	3.96E-09	3.29E-09	3.33E-09
Ps90%/90% (+KTL) Un-Biased	7.73E-09	8.00E-09	8.67E-09	8.03E-09	9.17E-09	4.79E-09	7.59E-09
Ps90%/90% (-KTL) Un-Biased	-9.98E-09	-1.04E-08	-1.15E-08	-1.14E-08	-1.26E-08	-1.33E-08	-1.06E-08
Specification MIN	-6.50E-08	-6.50E-08	-6.50E-08	-6.50E-08	-6.50E-08	-6.50E-08	-6.50E-08
Status	PASS	PASS	PASS	PASS	PASS	PASS	PASS
Specification MAX	6.50E-08	6.50E-08	6.50E-08	6.50E-08	6.50E-08	6.50E-08	6.50E-08
Status	PASS	PASS	PASS	PASS	PASS	PASS	PASS

An ISO 9001:2008 and DLA Certified Company

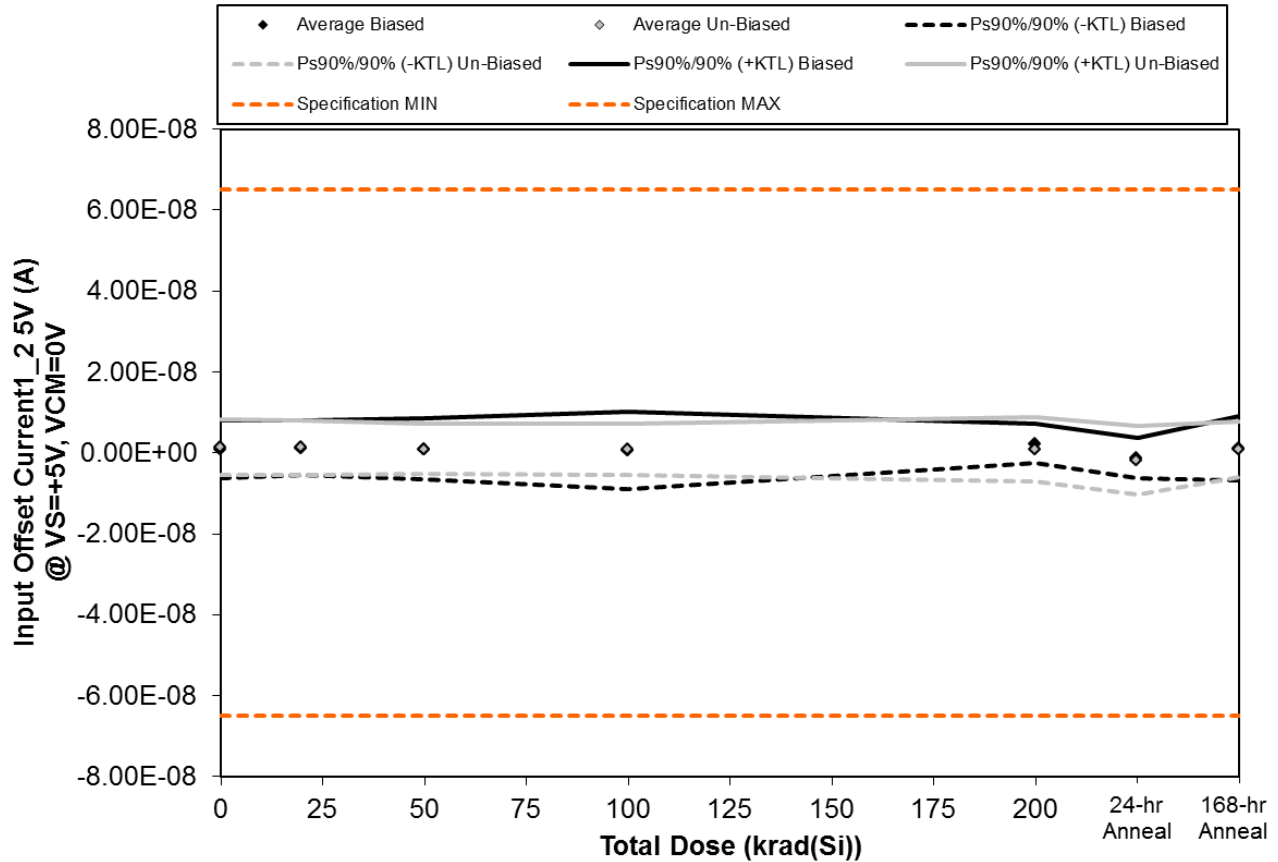

Figure 5.64. Plot of Input Offset Current1_2 5V (A) @ VS=+5V, VCM=0V versus total dose. The solid diamonds are the average of the measured data points for the samples irradiated under electrical bias while the shaded diamonds are the average of the measured data points for the samples irradiated with all pins tied to ground. The black lines (solid and/or dashed) are the upper and/or lower confidence limits, as determined by KTL statistics, on the samples irradiated under electrical bias while the gray lines (solid and/or dashed) are the upper and/or lower confidence limits, as determined by KTL statistics, on the samples irradiated in the unbiased condition. The red dotted line(s) are the pre- and/or post-irradiation minimum and/or maximum specification value as defined in the datasheet and/or test plan.



TID Report
15-0091 03/20/15 R1.0

Aeroflex RAD
5030 Centennial Blvd.
Colorado Springs, CO 80919
(719) 531-0800

Table 5.64. Raw data for Input Offset Current_{1_2 5V (A)} @ VS=+5V, VCM=0V versus total dose, including the statistical analysis, specification and the status of the testing (pass/fail).

Input Offset Current _{1_2 5V (A)} @ VS=+5V, VCM=0V	Total Dose (krad(Si))					24-hr Anneal	168-hr Anneal
	0	20	50	100	200		
Device							
680	-7.00E-11	1.33E-09	1.24E-09	-2.95E-09	1.71E-09	-2.36E-09	0.00E+00
681	8.40E-10	4.00E-10	-8.20E-10	-8.30E-10	1.17E-09	-2.30E-09	-6.10E-10
682	-3.00E-10	-1.10E-10	-1.10E-10	-1.90E-10	1.98E-09	-1.70E-09	-9.80E-10
683	-1.56E-09	-9.70E-10	-1.17E-09	3.40E-10	1.31E-09	-2.07E-09	6.50E-10
684	5.26E-09	5.30E-09	5.61E-09	6.40E-09	5.42E-09	2.00E-09	6.10E-09
685	4.68E-09	4.57E-09	3.20E-09	3.08E-09	3.49E-09	4.80E-10	3.97E-09
686	-1.80E-09	-1.47E-09	-3.10E-10	-1.05E-09	-1.26E-09	-4.80E-09	-1.76E-09
688	2.05E-09	2.19E-09	2.10E-09	3.09E-09	1.90E-09	2.40E-10	1.60E-09
689	2.30E-09	2.33E-09	2.00E-09	1.67E-09	3.35E-09	5.80E-10	2.00E-09
690	-4.50E-10	-7.00E-10	-2.40E-09	-1.83E-09	-3.04E-09	-5.62E-09	-1.77E-09
691	-4.67E-09	-4.73E-09	-4.82E-09	-4.88E-09	-4.94E-09	-5.01E-09	-5.11E-09
692	-1.50E-09	-1.53E-09	-1.62E-09	-1.66E-09	-1.69E-09	-1.69E-09	-1.73E-09
Biased Statistics							
Average Biased	8.34E-10	1.19E-09	9.50E-10	5.54E-10	2.32E-09	-1.29E-09	1.03E-09
Std Dev Biased	2.62E-09	2.44E-09	2.76E-09	3.50E-09	1.76E-09	1.86E-09	2.90E-09
Ps90%/90% (+KTL) Biased	8.01E-09	7.89E-09	8.53E-09	1.01E-08	7.15E-09	3.80E-09	8.98E-09
Ps90%/90% (-KTL) Biased	-6.35E-09	-5.51E-09	-6.63E-09	-9.04E-09	-2.52E-09	-6.37E-09	-6.92E-09
Un-Biased Statistics							
Average Un-Biased	1.36E-09	1.38E-09	9.18E-10	9.92E-10	8.88E-10	-1.82E-09	8.08E-10
Std Dev Un-Biased	2.53E-09	2.46E-09	2.25E-09	2.31E-09	2.91E-09	3.11E-09	2.51E-09
Ps90%/90% (+KTL) Un-Biased	8.30E-09	8.13E-09	7.09E-09	7.33E-09	8.87E-09	6.70E-09	7.70E-09
Ps90%/90% (-KTL) Un-Biased	-5.59E-09	-5.36E-09	-5.26E-09	-5.34E-09	-7.09E-09	-1.03E-08	-6.09E-09
Specification MIN	-6.50E-08	-6.50E-08	-6.50E-08	-6.50E-08	-6.50E-08	-6.50E-08	-6.50E-08
Status	PASS	PASS	PASS	PASS	PASS	PASS	PASS
Specification MAX	6.50E-08	6.50E-08	6.50E-08	6.50E-08	6.50E-08	6.50E-08	6.50E-08
Status	PASS	PASS	PASS	PASS	PASS	PASS	PASS

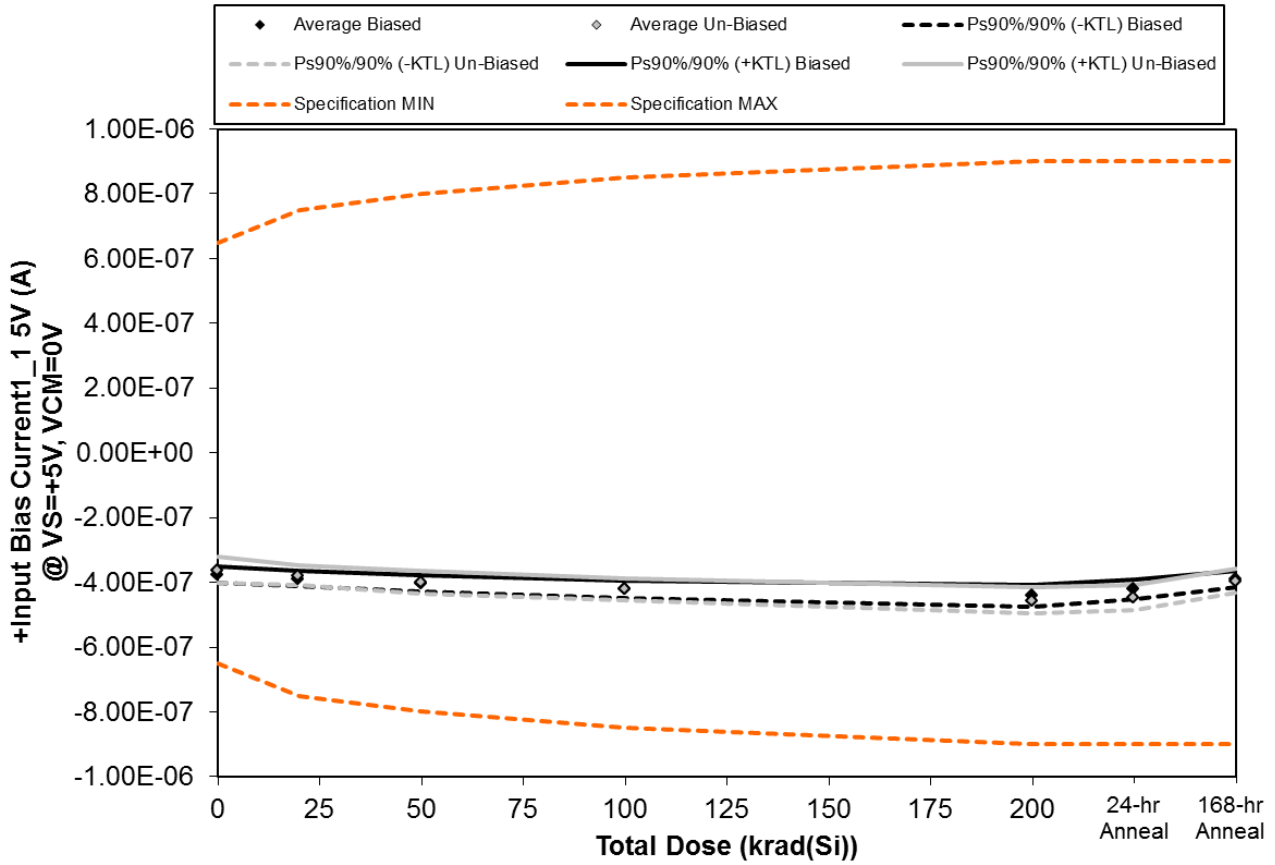

Figure 5.65. Plot of +Input Bias Current1_1 5V (A) @ VS=+5V, VCM=0V versus total dose. The solid diamonds are the average of the measured data points for the samples irradiated under electrical bias while the shaded diamonds are the average of the measured data points for the samples irradiated with all pins tied to ground. The black lines (solid and/or dashed) are the upper and/or lower confidence limits, as determined by KTL statistics, on the samples irradiated under electrical bias while the gray lines (solid and/or dashed) are the upper and/or lower confidence limits, as determined by KTL statistics, on the samples irradiated in the unbiased condition. The red dotted line(s) are the pre- and/or post-irradiation minimum and/or maximum specification value as defined in the datasheet and/or test plan.



TID Report
15-0091 03/20/15 R1.0

Aeroflex RAD
5030 Centennial Blvd.
Colorado Springs, CO 80919
(719) 531-0800

Table 5.65. Raw data for +Input Bias Current1_1 5V (A) @ VS=+5V, VCM=0V versus total dose, including the statistical analysis, specification and the status of the testing (pass/fail).

+Input Bias Current1_1 5V (A) @ VS=+5V, VCM=0V	Total Dose (krad(Si))					24-hr Anneal	168-hr Anneal
	0	20	50	100	200		
Device							
680	-3.75E-07	-3.86E-07	-4.01E-07	-4.14E-07	-4.31E-07	-4.13E-07	-3.88E-07
681	-3.72E-07	-3.83E-07	-3.98E-07	-4.14E-07	-4.36E-07	-4.15E-07	-3.84E-07
682	-3.91E-07	-4.03E-07	-4.19E-07	-4.36E-07	-4.62E-07	-4.38E-07	-4.06E-07
683	-3.66E-07	-3.80E-07	-3.96E-07	-4.14E-07	-4.33E-07	-4.14E-07	-3.84E-07
684	-3.75E-07	-3.90E-07	-4.07E-07	-4.25E-07	-4.45E-07	-4.26E-07	-3.92E-07
685	-3.60E-07	-3.73E-07	-3.93E-07	-4.16E-07	-4.47E-07	-4.38E-07	-3.89E-07
686	-3.72E-07	-3.86E-07	-4.05E-07	-4.25E-07	-4.56E-07	-4.48E-07	-4.00E-07
688	-3.67E-07	-3.85E-07	-4.06E-07	-4.33E-07	-4.72E-07	-4.63E-07	-4.04E-07
689	-3.38E-07	-3.61E-07	-3.80E-07	-4.02E-07	-4.36E-07	-4.28E-07	-3.75E-07
690	-3.74E-07	-3.86E-07	-4.11E-07	-4.29E-07	-4.66E-07	-4.58E-07	-4.08E-07
691	-3.71E-07	-3.70E-07	-3.72E-07	-3.70E-07	-3.72E-07	-3.71E-07	-3.72E-07
692	-3.70E-07	-3.69E-07	-3.70E-07	-3.70E-07	-3.70E-07	-3.70E-07	-3.69E-07
Biased Statistics							
Average Biased	-3.76E-07	-3.88E-07	-4.04E-07	-4.21E-07	-4.41E-07	-4.21E-07	-3.91E-07
Std Dev Biased	9.12E-09	8.90E-09	9.18E-09	9.88E-09	1.25E-08	1.06E-08	9.19E-09
Ps90%/90% (+KTL) Biased	-3.51E-07	-3.64E-07	-3.79E-07	-3.94E-07	-4.07E-07	-3.92E-07	-3.65E-07
Ps90%/90% (-KTL) Biased	-4.01E-07	-4.13E-07	-4.29E-07	-4.48E-07	-4.76E-07	-4.50E-07	-4.16E-07
Un-Biased Statistics							
Average Un-Biased	-3.62E-07	-3.78E-07	-3.99E-07	-4.21E-07	-4.55E-07	-4.47E-07	-3.95E-07
Std Dev Un-Biased	1.46E-08	1.10E-08	1.25E-08	1.22E-08	1.46E-08	1.41E-08	1.32E-08
Ps90%/90% (+KTL) Un-Biased	-3.22E-07	-3.48E-07	-3.65E-07	-3.88E-07	-4.15E-07	-4.08E-07	-3.59E-07
Ps90%/90% (-KTL) Un-Biased	-4.02E-07	-4.08E-07	-4.33E-07	-4.54E-07	-4.95E-07	-4.86E-07	-4.31E-07
Specification MIN	-6.50E-07	-7.50E-07	-8.00E-07	-8.50E-07	-9.00E-07	-9.00E-07	-9.00E-07
Status	PASS	PASS	PASS	PASS	PASS	PASS	PASS
Specification MAX	6.50E-07	7.50E-07	8.00E-07	8.50E-07	9.00E-07	9.00E-07	9.00E-07
Status	PASS	PASS	PASS	PASS	PASS	PASS	PASS

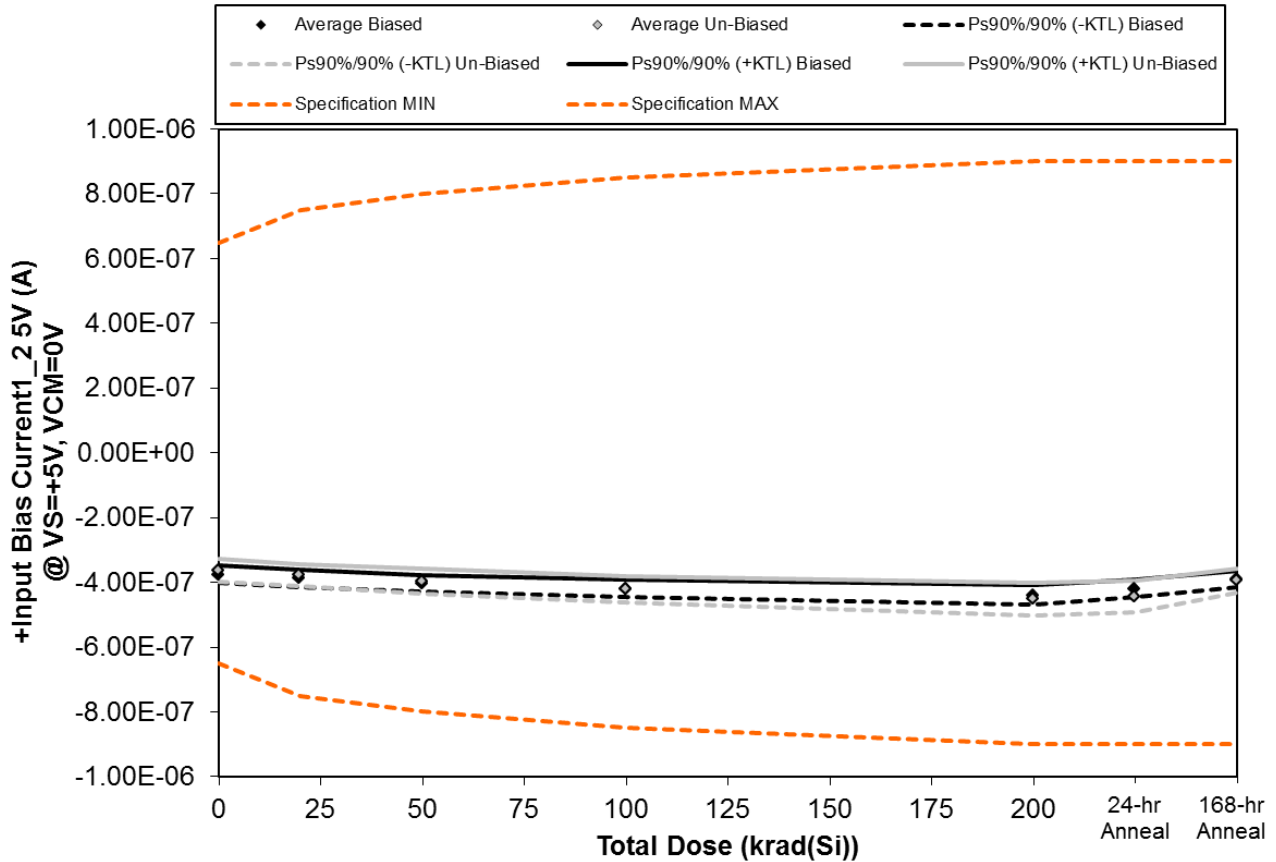

Figure 5.66. Plot of +Input Bias Current1_2 5V (A) @ VS=+5V, VCM=0V versus total dose. The solid diamonds are the average of the measured data points for the samples irradiated under electrical bias while the shaded diamonds are the average of the measured data points for the samples irradiated with all pins tied to ground. The black lines (solid and/or dashed) are the upper and/or lower confidence limits, as determined by KTL statistics, on the samples irradiated under electrical bias while the gray lines (solid and/or dashed) are the upper and/or lower confidence limits, as determined by KTL statistics, on the samples irradiated in the unbiased condition. The red dotted line(s) are the pre- and/or post-irradiation minimum and/or maximum specification value as defined in the datasheet and/or test plan.



TID Report
15-0091 03/20/15 R1.0

Aeroflex RAD
5030 Centennial Blvd.
Colorado Springs, CO 80919
(719) 531-0800

Table 5.66. Raw data for +Input Bias Current1_2 5V (A) @ VS=+5V, VCM=0V versus total dose, including the statistical analysis, specification and the status of the testing (pass/fail).

+Input Bias Current1_2 5V (A) @ VS=+5V, VCM=0V	Total Dose (krad(Si))					24-hr	168-hr
	0	20	50	100	200	Anneal	Anneal
Device							
680	-3.75E-07	-3.85E-07	-4.01E-07	-4.15E-07	-4.34E-07	-4.15E-07	-3.87E-07
681	-3.70E-07	-3.82E-07	-3.99E-07	-4.13E-07	-4.33E-07	-4.13E-07	-3.84E-07
682	-3.93E-07	-4.04E-07	-4.20E-07	-4.37E-07	-4.58E-07	-4.37E-07	-4.06E-07
683	-3.70E-07	-3.82E-07	-3.99E-07	-4.16E-07	-4.34E-07	-4.15E-07	-3.83E-07
684	-3.69E-07	-3.81E-07	-3.96E-07	-4.14E-07	-4.34E-07	-4.15E-07	-3.84E-07
685	-3.53E-07	-3.67E-07	-3.84E-07	-4.05E-07	-4.33E-07	-4.27E-07	-3.81E-07
686	-3.74E-07	-3.88E-07	-4.05E-07	-4.26E-07	-4.57E-07	-4.50E-07	-4.02E-07
688	-3.72E-07	-3.88E-07	-4.10E-07	-4.36E-07	-4.74E-07	-4.66E-07	-4.08E-07
689	-3.46E-07	-3.61E-07	-3.80E-07	-4.04E-07	-4.32E-07	-4.25E-07	-3.78E-07
690	-3.70E-07	-3.81E-07	-4.08E-07	-4.30E-07	-4.63E-07	-4.55E-07	-4.03E-07
691	-3.75E-07	-3.74E-07	-3.75E-07	-3.76E-07	-3.75E-07	-3.76E-07	-3.76E-07
692	-3.63E-07	-3.64E-07	-3.62E-07	-3.63E-07	-3.62E-07	-3.63E-07	-3.61E-07
Biased Statistics							
Average Biased	-3.75E-07	-3.87E-07	-4.03E-07	-4.19E-07	-4.38E-07	-4.19E-07	-3.89E-07
Std Dev Biased	9.93E-09	9.80E-09	9.70E-09	1.00E-08	1.08E-08	9.98E-09	9.57E-09
Ps90%/90% (+KTL) Biased	-3.48E-07	-3.60E-07	-3.76E-07	-3.92E-07	-4.09E-07	-3.92E-07	-3.63E-07
Ps90%/90% (-KTL) Biased	-4.03E-07	-4.14E-07	-4.29E-07	-4.47E-07	-4.68E-07	-4.46E-07	-4.15E-07
Un-Biased Statistics							
Average Un-Biased	-3.63E-07	-3.77E-07	-3.98E-07	-4.20E-07	-4.52E-07	-4.45E-07	-3.94E-07
Std Dev Un-Biased	1.25E-08	1.23E-08	1.42E-08	1.48E-08	1.88E-08	1.79E-08	1.37E-08
Ps90%/90% (+KTL) Un-Biased	-3.29E-07	-3.43E-07	-3.59E-07	-3.80E-07	-4.00E-07	-3.96E-07	-3.57E-07
Ps90%/90% (-KTL) Un-Biased	-3.97E-07	-4.11E-07	-4.37E-07	-4.61E-07	-5.03E-07	-4.94E-07	-4.32E-07
Specification MIN	-6.50E-07	-7.50E-07	-8.00E-07	-8.50E-07	-9.00E-07	-9.00E-07	-9.00E-07
Status	PASS	PASS	PASS	PASS	PASS	PASS	PASS
Specification MAX	6.50E-07	7.50E-07	8.00E-07	8.50E-07	9.00E-07	9.00E-07	9.00E-07
Status	PASS	PASS	PASS	PASS	PASS	PASS	PASS

An ISO 9001:2008 and DLA Certified Company

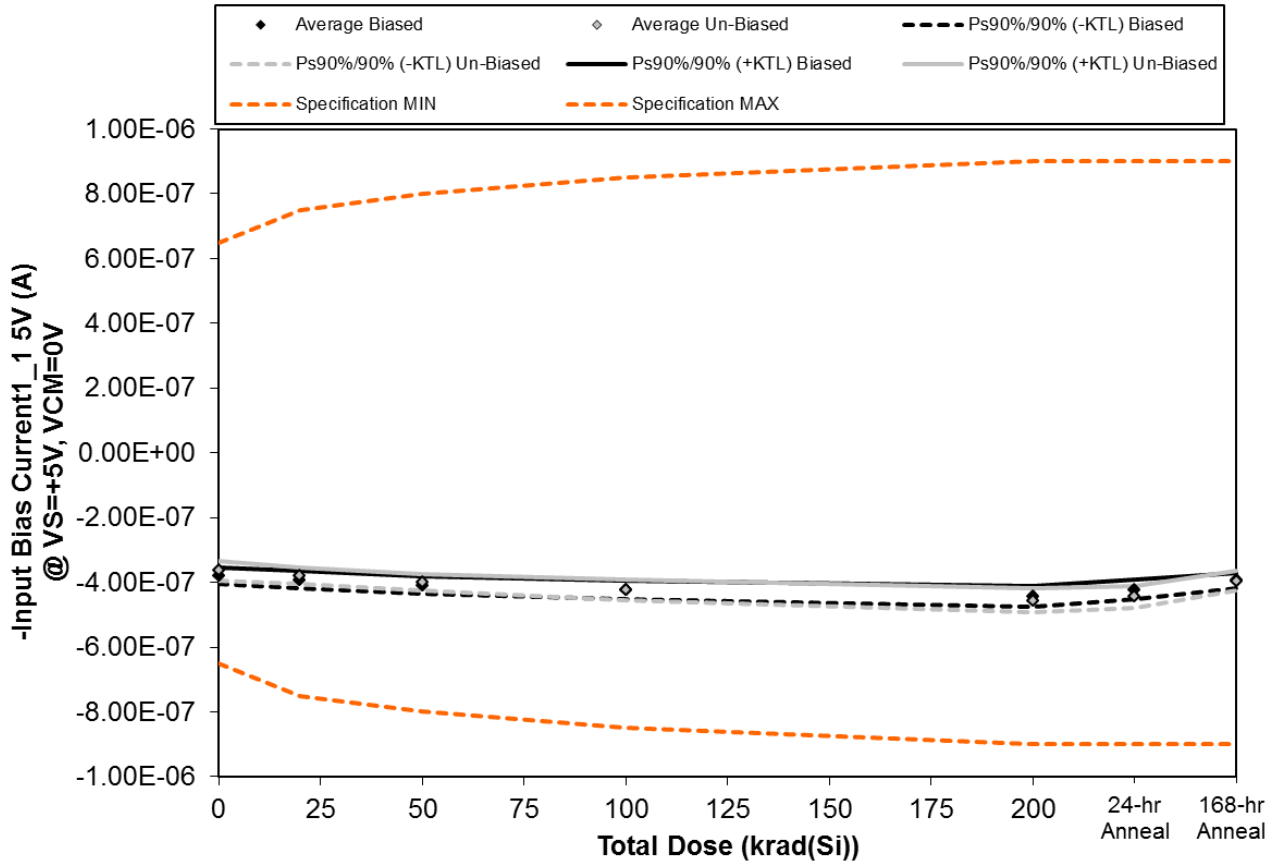

Figure 5.67. Plot of -Input Bias Current1_1 5V (A) @ VS=+5V, VCM=0V versus total dose. The solid diamonds are the average of the measured data points for the samples irradiated under electrical bias while the shaded diamonds are the average of the measured data points for the samples irradiated with all pins tied to ground. The black lines (solid and/or dashed) are the upper and/or lower confidence limits, as determined by KTL statistics, on the samples irradiated under electrical bias while the gray lines (solid and/or dashed) are the upper and/or lower confidence limits, as determined by KTL statistics, on the samples irradiated in the unbiased condition. The red dotted line(s) are the pre- and/or post-irradiation minimum and/or maximum specification value as defined in the datasheet and/or test plan.



TID Report
15-0091 03/20/15 R1.0

Aeroflex RAD
5030 Centennial Blvd.
Colorado Springs, CO 80919
(719) 531-0800

Table 5.67. Raw data for -Input Bias Current1_1 5V (A) @ VS=+5V, VCM=0V versus total dose, including the statistical analysis, specification and the status of the testing (pass/fail).

-Input Bias Current1_1 5V (A) @ VS=+5V, VCM=0V	Total Dose (krad(Si))					24-hr Anneal	168-hr Anneal
	0	20	50	100	200		
Device							
680	-3.80E-07	-3.92E-07	-4.07E-07	-4.13E-07	-4.33E-07	-4.15E-07	-3.93E-07
681	-3.69E-07	-3.81E-07	-3.98E-07	-4.15E-07	-4.35E-07	-4.11E-07	-3.85E-07
682	-3.92E-07	-4.07E-07	-4.23E-07	-4.40E-07	-4.62E-07	-4.38E-07	-4.08E-07
683	-3.72E-07	-3.87E-07	-4.03E-07	-4.24E-07	-4.42E-07	-4.19E-07	-3.89E-07
684	-3.77E-07	-3.94E-07	-4.11E-07	-4.27E-07	-4.49E-07	-4.26E-07	-3.94E-07
685	-3.58E-07	-3.73E-07	-3.92E-07	-4.12E-07	-4.43E-07	-4.32E-07	-3.84E-07
686	-3.73E-07	-3.89E-07	-4.06E-07	-4.26E-07	-4.59E-07	-4.47E-07	-4.01E-07
688	-3.66E-07	-3.85E-07	-4.04E-07	-4.33E-07	-4.70E-07	-4.58E-07	-4.03E-07
689	-3.50E-07	-3.67E-07	-3.88E-07	-4.10E-07	-4.42E-07	-4.31E-07	-3.83E-07
690	-3.75E-07	-3.85E-07	-4.09E-07	-4.34E-07	-4.66E-07	-4.56E-07	-4.07E-07
691	-3.71E-07	-3.71E-07	-3.72E-07	-3.71E-07	-3.72E-07	-3.71E-07	-3.73E-07
692	-3.65E-07	-3.66E-07	-3.67E-07	-3.66E-07	-3.66E-07	-3.65E-07	-3.66E-07
Biased Statistics							
Average Biased	-3.78E-07	-3.92E-07	-4.08E-07	-4.24E-07	-4.44E-07	-4.22E-07	-3.94E-07
Std Dev Biased	9.18E-09	9.74E-09	9.50E-09	1.06E-08	1.19E-08	1.06E-08	8.91E-09
Ps90%/90% (+KTL) Biased	-3.53E-07	-3.66E-07	-3.82E-07	-3.95E-07	-4.12E-07	-3.93E-07	-3.69E-07
Ps90%/90% (-KTL) Biased	-4.03E-07	-4.19E-07	-4.34E-07	-4.53E-07	-4.77E-07	-4.51E-07	-4.18E-07
Un-Biased Statistics							
Average Un-Biased	-3.64E-07	-3.80E-07	-4.00E-07	-4.23E-07	-4.56E-07	-4.45E-07	-3.96E-07
Std Dev Un-Biased	1.06E-08	9.23E-09	9.36E-09	1.13E-08	1.32E-08	1.27E-08	1.12E-08
Ps90%/90% (+KTL) Un-Biased	-3.35E-07	-3.54E-07	-3.74E-07	-3.92E-07	-4.20E-07	-4.10E-07	-3.65E-07
Ps90%/90% (-KTL) Un-Biased	-3.93E-07	-4.05E-07	-4.26E-07	-4.54E-07	-4.92E-07	-4.79E-07	-4.26E-07
Specification MIN	-6.50E-07	-7.50E-07	-8.00E-07	-8.50E-07	-9.00E-07	-9.00E-07	-9.00E-07
Status	PASS	PASS	PASS	PASS	PASS	PASS	PASS
Specification MAX	6.50E-07	7.50E-07	8.00E-07	8.50E-07	9.00E-07	9.00E-07	9.00E-07
Status	PASS	PASS	PASS	PASS	PASS	PASS	PASS

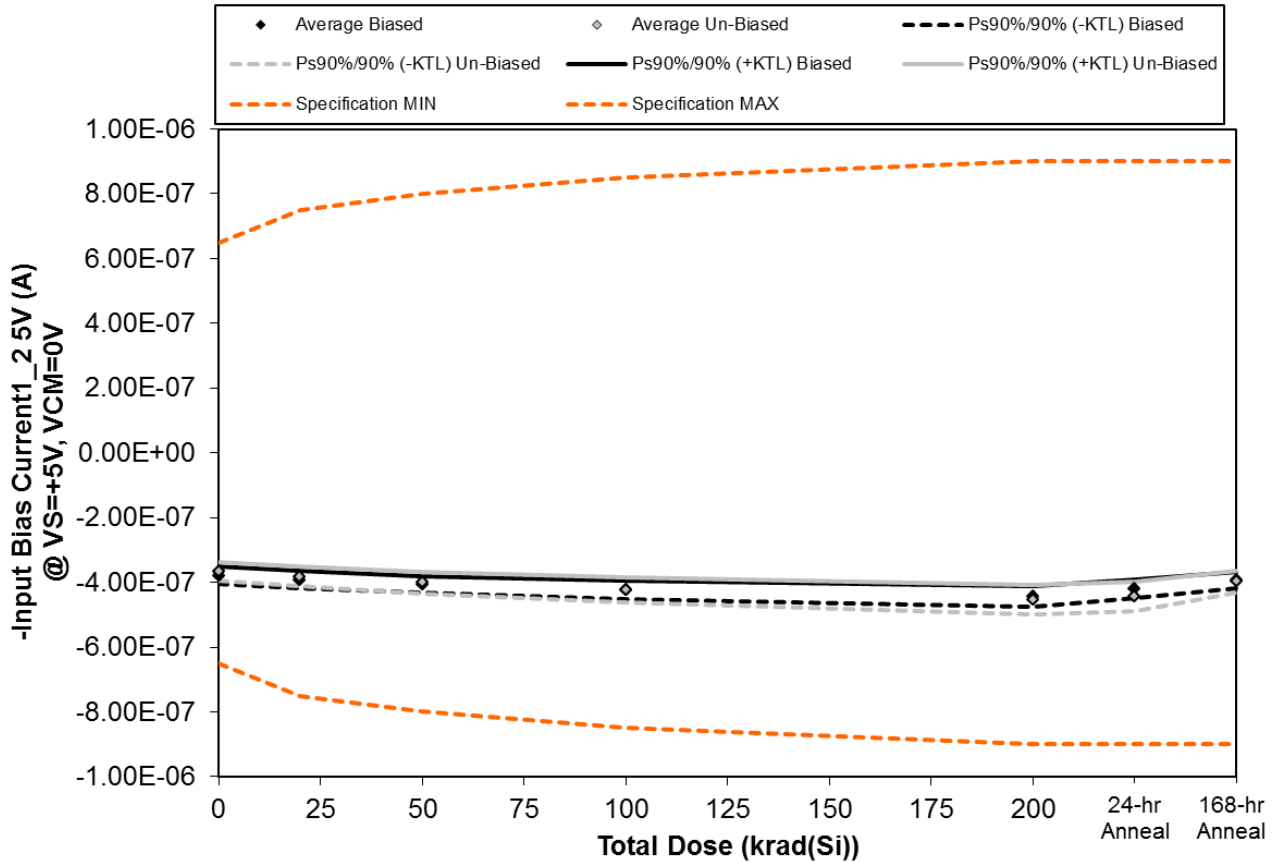

Figure 5.68. Plot of -Input Bias Current1_2 5V (A) @ VS=+5V, VCM=0V versus total dose. The solid diamonds are the average of the measured data points for the samples irradiated under electrical bias while the shaded diamonds are the average of the measured data points for the samples irradiated with all pins tied to ground. The black lines (solid and/or dashed) are the upper and/or lower confidence limits, as determined by KTL statistics, on the samples irradiated under electrical bias while the gray lines (solid and/or dashed) are the upper and/or lower confidence limits, as determined by KTL statistics, on the samples irradiated in the unbiased condition. The red dotted line(s) are the pre- and/or post-irradiation minimum and/or maximum specification value as defined in the datasheet and/or test plan.



TID Report
15-0091 03/20/15 R1.0

Aeroflex RAD
5030 Centennial Blvd.
Colorado Springs, CO 80919
(719) 531-0800

Table 5.68. Raw data for -Input Bias Current1_2 5V (A) @ VS=+5V, VCM=0V versus total dose, including the statistical analysis, specification and the status of the testing (pass/fail).

-Input Bias Current1_2 5V (A) @ VS=+5V, VCM=0V	Total Dose (krad(Si))					24-hr Anneal	168-hr Anneal
	0	20	50	100	200		
Device							
680	-3.77E-07	-3.90E-07	-4.06E-07	-4.16E-07	-4.38E-07	-4.15E-07	-3.90E-07
681	-3.72E-07	-3.86E-07	-4.00E-07	-4.15E-07	-4.38E-07	-4.13E-07	-3.86E-07
682	-3.95E-07	-4.08E-07	-4.22E-07	-4.40E-07	-4.64E-07	-4.39E-07	-4.08E-07
683	-3.71E-07	-3.84E-07	-3.99E-07	-4.18E-07	-4.36E-07	-4.15E-07	-3.86E-07
684	-3.77E-07	-3.90E-07	-4.05E-07	-4.22E-07	-4.43E-07	-4.20E-07	-3.93E-07
685	-3.60E-07	-3.74E-07	-3.90E-07	-4.10E-07	-4.37E-07	-4.28E-07	-3.87E-07
686	-3.75E-07	-3.90E-07	-4.08E-07	-4.29E-07	-4.57E-07	-4.46E-07	-4.01E-07
688	-3.77E-07	-3.93E-07	-4.15E-07	-4.41E-07	-4.78E-07	-4.66E-07	-4.11E-07
689	-3.53E-07	-3.68E-07	-3.86E-07	-4.06E-07	-4.38E-07	-4.27E-07	-3.82E-07
690	-3.73E-07	-3.83E-07	-4.07E-07	-4.26E-07	-4.59E-07	-4.53E-07	-4.04E-07
691	-3.74E-07	-3.74E-07	-3.74E-07	-3.73E-07	-3.75E-07	-3.74E-07	-3.73E-07
692	-3.64E-07	-3.62E-07	-3.64E-07	-3.63E-07	-3.62E-07	-3.62E-07	-3.63E-07
Biased Statistics							
Average Biased	-3.78E-07	-3.92E-07	-4.07E-07	-4.22E-07	-4.44E-07	-4.21E-07	-3.93E-07
Std Dev Biased	9.58E-09	9.48E-09	9.21E-09	1.02E-08	1.13E-08	1.04E-08	9.17E-09
Ps90%/90% (+KTL) Biased	-3.52E-07	-3.66E-07	-3.81E-07	-3.94E-07	-4.13E-07	-3.92E-07	-3.68E-07
Ps90%/90% (-KTL) Biased	-4.05E-07	-4.18E-07	-4.32E-07	-4.50E-07	-4.75E-07	-4.49E-07	-4.18E-07
Un-Biased Statistics							
Average Un-Biased	-3.68E-07	-3.81E-07	-4.01E-07	-4.22E-07	-4.54E-07	-4.44E-07	-3.97E-07
Std Dev Un-Biased	1.05E-08	1.06E-08	1.23E-08	1.42E-08	1.69E-08	1.65E-08	1.20E-08
Ps90%/90% (+KTL) Un-Biased	-3.39E-07	-3.52E-07	-3.67E-07	-3.84E-07	-4.07E-07	-3.99E-07	-3.64E-07
Ps90%/90% (-KTL) Un-Biased	-3.96E-07	-4.11E-07	-4.35E-07	-4.61E-07	-5.00E-07	-4.89E-07	-4.30E-07
Specification MIN	-6.50E-07	-7.50E-07	-8.00E-07	-8.50E-07	-9.00E-07	-9.00E-07	-9.00E-07
Status	PASS	PASS	PASS	PASS	PASS	PASS	PASS
Specification MAX	6.50E-07	7.50E-07	8.00E-07	8.50E-07	9.00E-07	9.00E-07	9.00E-07
Status	PASS	PASS	PASS	PASS	PASS	PASS	PASS

An ISO 9001:2008 and DLA Certified Company

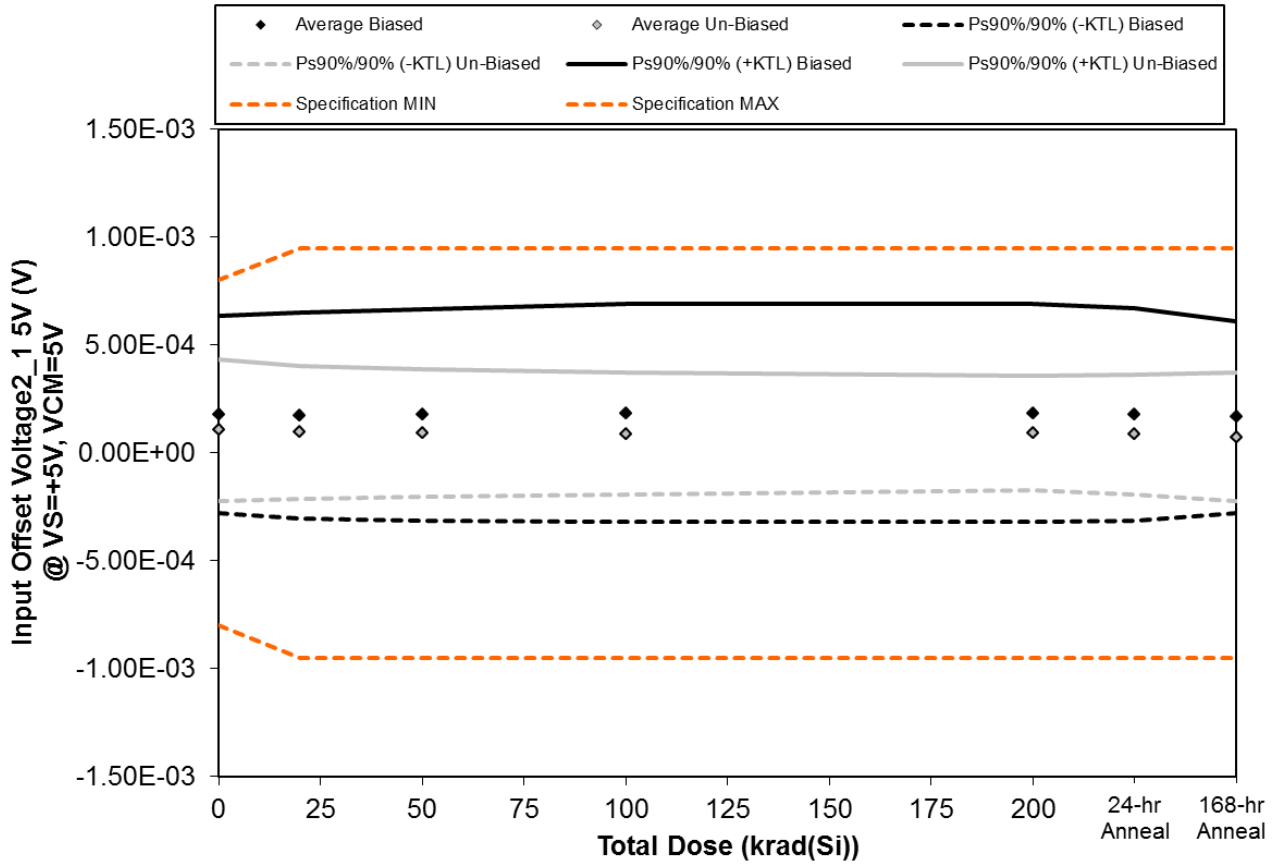

Figure 5.69. Plot of Input Offset Voltage2_1 5V (V) @ VS=+5V, VCM=5V versus total dose. The solid diamonds are the average of the measured data points for the samples irradiated under electrical bias while the shaded diamonds are the average of the measured data points for the samples irradiated with all pins tied to ground. The black lines (solid and/or dashed) are the upper and/or lower confidence limits, as determined by KTL statistics, on the samples irradiated under electrical bias while the gray lines (solid and/or dashed) are the upper and/or lower confidence limits, as determined by KTL statistics, on the samples irradiated in the unbiased condition. The red dotted line(s) are the pre- and/or post-irradiation minimum and/or maximum specification value as defined in the datasheet and/or test plan.



TID Report
15-0091 03/20/15 R1.0

Aeroflex RAD
5030 Centennial Blvd.
Colorado Springs, CO 80919
(719) 531-0800

Table 5.69. Raw data for Input Offset Voltage_{2_1} 5V (V) @ VS=+5V, VCM=5V versus total dose, including the statistical analysis, specification and the status of the testing (pass/fail).

Input Offset Voltage _{2_1} 5V (V) @ VS=+5V, VCM=5V	Total Dose (krad(Si))					24-hr	168-hr
	0	20	50	100	200	Anneal	Anneal
Device							
680	4.15E-04	4.21E-04	4.30E-04	4.47E-04	4.40E-04	4.33E-04	3.94E-04
681	-1.18E-05	-3.03E-05	-3.44E-05	-3.22E-05	-3.72E-05	-3.69E-05	-1.73E-05
682	9.66E-05	8.48E-05	8.73E-05	8.93E-05	8.69E-05	9.15E-05	6.49E-05
683	2.68E-04	2.60E-04	2.66E-04	2.74E-04	2.84E-04	2.71E-04	2.56E-04
684	1.23E-04	1.20E-04	1.29E-04	1.38E-04	1.45E-04	1.40E-04	1.29E-04
685	1.42E-05	1.03E-05	7.07E-06	6.92E-06	1.46E-05	3.48E-06	-3.70E-06
686	-2.53E-05	-2.59E-05	-2.63E-05	-2.22E-05	-1.20E-05	-2.42E-05	-5.11E-05
688	9.46E-05	8.39E-05	8.18E-05	8.19E-05	8.05E-05	8.02E-05	6.98E-05
689	2.72E-04	2.54E-04	2.41E-04	2.32E-04	2.25E-04	2.21E-04	2.20E-04
690	1.70E-04	1.52E-04	1.47E-04	1.48E-04	1.48E-04	1.44E-04	1.35E-04
691	-1.48E-04	-1.47E-04	-1.47E-04	-1.46E-04	-1.46E-04	-1.45E-04	-1.45E-04
692	-9.36E-05	-9.35E-05	-9.29E-05	-9.22E-05	-9.26E-05	-9.27E-05	-9.22E-05
Biased Statistics							
Average Biased	1.78E-04	1.71E-04	1.76E-04	1.83E-04	1.84E-04	1.80E-04	1.65E-04
Std Dev Biased	1.66E-04	1.74E-04	1.78E-04	1.84E-04	1.84E-04	1.79E-04	1.62E-04
Ps90%/90% (+KTL) Biased	6.33E-04	6.48E-04	6.64E-04	6.88E-04	6.88E-04	6.72E-04	6.10E-04
Ps90%/90% (-KTL) Biased	-2.77E-04	-3.06E-04	-3.13E-04	-3.21E-04	-3.21E-04	-3.12E-04	-2.80E-04
Un-Biased Statistics							
Average Un-Biased	1.05E-04	9.48E-05	9.01E-05	8.93E-05	9.12E-05	8.50E-05	7.40E-05
Std Dev Un-Biased	1.20E-04	1.12E-04	1.08E-04	1.04E-04	9.71E-05	1.01E-04	1.08E-04
Ps90%/90% (+KTL) Un-Biased	4.33E-04	4.03E-04	3.86E-04	3.74E-04	3.57E-04	3.62E-04	3.70E-04
Ps90%/90% (-KTL) Un-Biased	-2.23E-04	-2.13E-04	-2.05E-04	-1.95E-04	-1.75E-04	-1.91E-04	-2.22E-04
Specification MIN	-8.00E-04	-9.50E-04	-9.50E-04	-9.50E-04	-9.50E-04	-9.50E-04	-9.50E-04
Status	PASS	PASS	PASS	PASS	PASS	PASS	PASS
Specification MAX	8.00E-04	9.50E-04	9.50E-04	9.50E-04	9.50E-04	9.50E-04	9.50E-04
Status	PASS	PASS	PASS	PASS	PASS	PASS	PASS

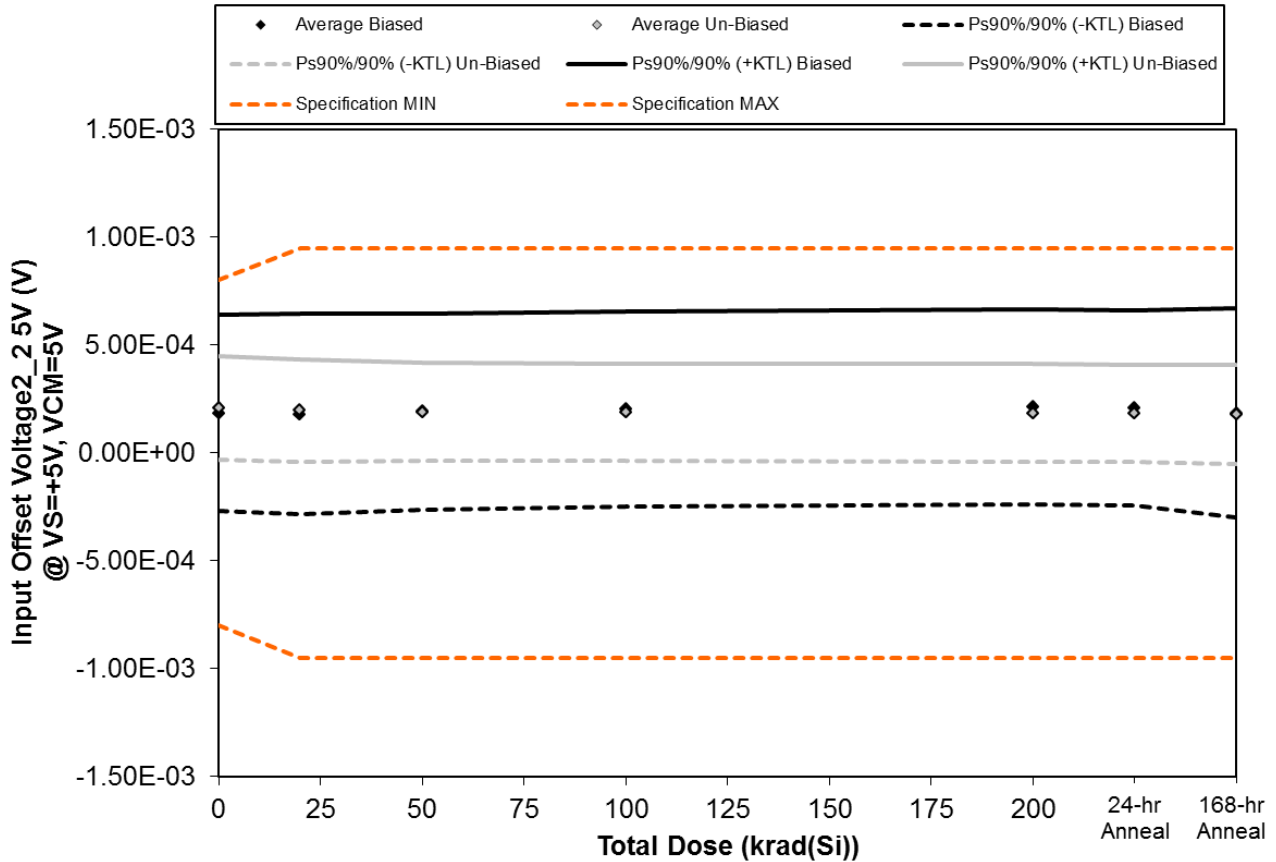

Figure 5.70. Plot of Input Offset Voltage2_2 5V (V) @ VS=+5V, VCM=5V versus total dose. The solid diamonds are the average of the measured data points for the samples irradiated under electrical bias while the shaded diamonds are the average of the measured data points for the samples irradiated with all pins tied to ground. The black lines (solid and/or dashed) are the upper and/or lower confidence limits, as determined by KTL statistics, on the samples irradiated under electrical bias while the gray lines (solid and/or dashed) are the upper and/or lower confidence limits, as determined by KTL statistics, on the samples irradiated in the unbiased condition. The red dotted line(s) are the pre- and/or post-irradiation minimum and/or maximum specification value as defined in the datasheet and/or test plan.



TID Report
15-0091 03/20/15 R1.0

Aeroflex RAD
5030 Centennial Blvd.
Colorado Springs, CO 80919
(719) 531-0800

Table 5.70. Raw data for Input Offset Voltage_{2_2} 5V (V) @ VS=+5V, VCM=5V versus total dose, including the statistical analysis, specification and the status of the testing (pass/fail).

Input Offset Voltage _{2_2} 5V (V) @ VS=+5V, VCM=5V	Total Dose (krad(Si))					24-hr	168-hr
	0	20	50	100	200	Anneal	Anneal
Device							
680	4.81E-05	4.14E-05	5.51E-05	6.98E-05	7.37E-05	6.48E-05	4.19E-05
681	1.50E-04	1.45E-04	1.57E-04	1.66E-04	1.74E-04	1.77E-04	1.41E-04
682	1.22E-04	1.10E-04	1.23E-04	1.34E-04	1.47E-04	1.41E-04	1.07E-04
683	1.31E-04	1.28E-04	1.41E-04	1.58E-04	1.71E-04	1.63E-04	1.42E-04
684	4.72E-04	4.74E-04	4.79E-04	4.89E-04	4.99E-04	4.93E-04	4.93E-04
685	3.38E-04	3.28E-04	3.17E-04	3.14E-04	3.13E-04	3.11E-04	3.02E-04
686	1.39E-04	1.32E-04	1.24E-04	1.23E-04	1.16E-04	1.16E-04	1.10E-04
688	1.86E-04	1.70E-04	1.65E-04	1.62E-04	1.56E-04	1.58E-04	1.58E-04
689	1.23E-04	1.14E-04	1.19E-04	1.17E-04	1.18E-04	1.17E-04	1.02E-04
690	2.48E-04	2.35E-04	2.22E-04	2.23E-04	2.16E-04	2.15E-04	2.23E-04
691	-3.82E-05	-3.93E-05	-3.90E-05	-3.66E-05	-3.75E-05	-3.46E-05	-3.96E-05
692	3.08E-04	3.09E-04	3.09E-04	3.11E-04	3.11E-04	3.11E-04	3.14E-04
Biased Statistics							
Average Biased	1.85E-04	1.80E-04	1.91E-04	2.04E-04	2.13E-04	2.08E-04	1.85E-04
Std Dev Biased	1.65E-04	1.69E-04	1.66E-04	1.64E-04	1.65E-04	1.65E-04	1.77E-04
Ps90%/90% (+KTL) Biased	6.38E-04	6.44E-04	6.46E-04	6.54E-04	6.65E-04	6.61E-04	6.70E-04
Ps90%/90% (-KTL) Biased	-2.68E-04	-2.84E-04	-2.63E-04	-2.47E-04	-2.39E-04	-2.45E-04	-3.00E-04
Un-Biased Statistics							
Average Un-Biased	2.07E-04	1.96E-04	1.89E-04	1.88E-04	1.84E-04	1.83E-04	1.79E-04
Std Dev Un-Biased	8.77E-05	8.72E-05	8.24E-05	8.22E-05	8.27E-05	8.18E-05	8.41E-05
Ps90%/90% (+KTL) Un-Biased	4.47E-04	4.35E-04	4.15E-04	4.13E-04	4.11E-04	4.08E-04	4.10E-04
Ps90%/90% (-KTL) Un-Biased	-3.36E-05	-4.35E-05	-3.67E-05	-3.76E-05	-4.31E-05	-4.09E-05	-5.15E-05
Specification MIN	-8.00E-04	-9.50E-04	-9.50E-04	-9.50E-04	-9.50E-04	-9.50E-04	-9.50E-04
Status	PASS	PASS	PASS	PASS	PASS	PASS	PASS
Specification MAX	8.00E-04	9.50E-04	9.50E-04	9.50E-04	9.50E-04	9.50E-04	9.50E-04
Status	PASS	PASS	PASS	PASS	PASS	PASS	PASS

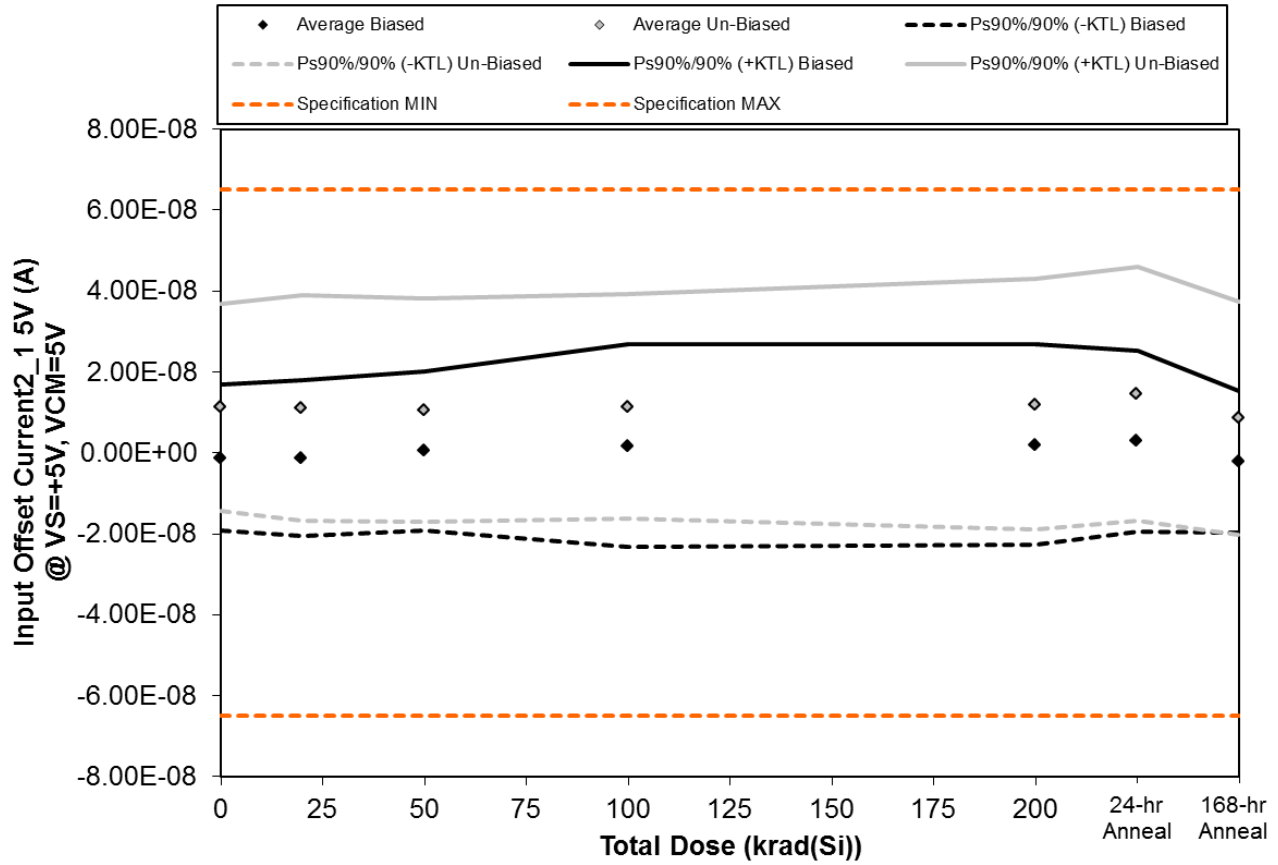

Figure 5.71. Plot of Input Offset Current_{2_1} 5V (A) @ VS=+5V, VCM=5V versus total dose. The solid diamonds are the average of the measured data points for the samples irradiated under electrical bias while the shaded diamonds are the average of the measured data points for the samples irradiated with all pins tied to ground. The black lines (solid and/or dashed) are the upper and/or lower confidence limits, as determined by KTL statistics, on the samples irradiated under electrical bias while the gray lines (solid and/or dashed) are the upper and/or lower confidence limits, as determined by KTL statistics, on the samples irradiated in the unbiased condition. The red dotted line(s) are the pre- and/or post-irradiation minimum and/or maximum specification value as defined in the datasheet and/or test plan.



TID Report
15-0091 03/20/15 R1.0

Aeroflex RAD
5030 Centennial Blvd.
Colorado Springs, CO 80919
(719) 531-0800

Table 5.71. Raw data for Input Offset Current_{2_1} 5V (A) @ VS=+5V, VCM=5V versus total dose, including the statistical analysis, specification and the status of the testing (pass/fail).

Input Offset Current _{2_1} 5V (A) @ VS=+5V, VCM=5V	Total Dose (krad(Si))					24-hr Anneal	168-hr Anneal
	0	20	50	100	200		
Device							
680	2.30E-09	4.38E-09	7.01E-09	1.28E-08	1.09E-08	1.22E-08	2.89E-09
681	-2.44E-09	-1.70E-09	-1.50E-09	1.58E-09	2.16E-09	1.81E-09	-2.94E-09
682	-1.02E-08	-1.10E-08	-9.37E-09	-1.07E-08	-1.23E-08	-7.84E-09	-1.09E-08
683	-2.92E-09	-4.23E-09	-1.87E-09	-2.51E-09	7.00E-10	-1.10E-09	-5.01E-09
684	7.50E-09	6.54E-09	8.10E-09	7.85E-09	8.51E-09	9.75E-09	5.07E-09
685	1.00E-08	7.85E-09	8.42E-09	1.01E-08	1.06E-08	1.32E-08	7.54E-09
686	7.43E-09	6.29E-09	5.43E-09	5.72E-09	6.65E-09	8.24E-09	1.91E-09
688	1.35E-08	1.58E-08	1.71E-08	1.74E-08	1.97E-08	2.24E-08	1.28E-08
689	9.00E-11	-5.00E-10	-1.71E-09	-9.60E-10	-2.89E-09	-1.80E-10	-3.27E-09
690	2.54E-08	2.60E-08	2.40E-08	2.50E-08	2.61E-08	2.88E-08	2.39E-08
691	2.14E-09	2.88E-09	3.17E-09	3.41E-09	3.64E-09	3.79E-09	4.25E-09
692	1.38E-08	1.47E-08	1.49E-08	1.51E-08	1.52E-08	1.53E-08	1.56E-08
Biased Statistics							
Average Biased	-1.15E-09	-1.20E-09	4.74E-10	1.80E-09	2.00E-09	2.96E-09	-2.18E-09
Std Dev Biased	6.58E-09	7.00E-09	7.20E-09	9.11E-09	9.05E-09	8.14E-09	6.38E-09
Ps90%/90% (+KTL) Biased	1.69E-08	1.80E-08	2.02E-08	2.68E-08	2.68E-08	2.53E-08	1.53E-08
Ps90%/90% (-KTL) Biased	-1.92E-08	-2.04E-08	-1.93E-08	-2.32E-08	-2.28E-08	-1.94E-08	-1.97E-08
Un-Biased Statistics							
Average Un-Biased	1.13E-08	1.11E-08	1.07E-08	1.15E-08	1.20E-08	1.45E-08	8.58E-09
Std Dev Un-Biased	9.31E-09	1.01E-08	1.01E-08	1.01E-08	1.13E-08	1.14E-08	1.05E-08
Ps90%/90% (+KTL) Un-Biased	3.68E-08	3.89E-08	3.83E-08	3.92E-08	4.30E-08	4.59E-08	3.73E-08
Ps90%/90% (-KTL) Un-Biased	-1.42E-08	-1.67E-08	-1.70E-08	-1.62E-08	-1.90E-08	-1.69E-08	-2.01E-08
Specification MIN	-6.50E-08	-6.50E-08	-6.50E-08	-6.50E-08	-6.50E-08	-6.50E-08	-6.50E-08
Status	PASS	PASS	PASS	PASS	PASS	PASS	PASS
Specification MAX	6.50E-08	6.50E-08	6.50E-08	6.50E-08	6.50E-08	6.50E-08	6.50E-08
Status	PASS	PASS	PASS	PASS	PASS	PASS	PASS

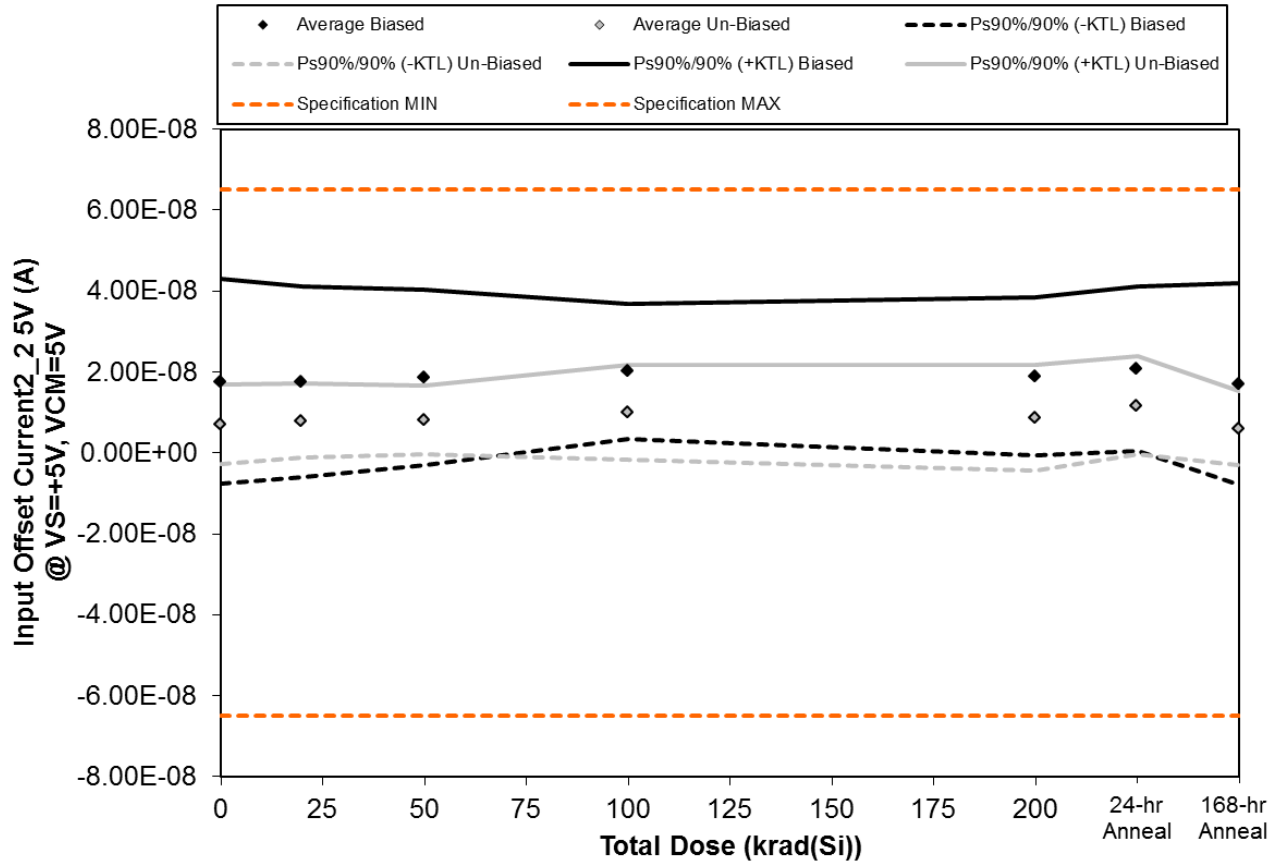

Figure 5.72. Plot of Input Offset Current_{2_2} 5V (A) @ VS=+5V, VCM=5V versus total dose. The solid diamonds are the average of the measured data points for the samples irradiated under electrical bias while the shaded diamonds are the average of the measured data points for the samples irradiated with all pins tied to ground. The black lines (solid and/or dashed) are the upper and/or lower confidence limits, as determined by KTL statistics, on the samples irradiated under electrical bias while the gray lines (solid and/or dashed) are the upper and/or lower confidence limits, as determined by KTL statistics, on the samples irradiated in the unbiased condition. The red dotted line(s) are the pre- and/or post-irradiation minimum and/or maximum specification value as defined in the datasheet and/or test plan.



TID Report
15-0091 03/20/15 R1.0

Aeroflex RAD
5030 Centennial Blvd.
Colorado Springs, CO 80919
(719) 531-0800

Table 5.72. Raw data for Input Offset Current_{2_2 5V (A)} @ VS=+5V, VCM=5V versus total dose, including the statistical analysis, specification and the status of the testing (pass/fail).

Input Offset Current _{2_2 5V (A)} @ VS=+5V, VCM=5V	Total Dose (krad(Si))					24-hr Anneal	168-hr Anneal
	0	20	50	100	200		
Device							
680	1.51E-09	2.59E-09	4.98E-09	1.04E-08	7.40E-09	8.80E-09	1.39E-09
681	2.33E-08	2.27E-08	2.32E-08	2.19E-08	1.89E-08	2.20E-08	2.06E-08
682	2.29E-08	2.17E-08	2.26E-08	2.52E-08	2.53E-08	2.76E-08	2.28E-08
683	1.81E-08	1.79E-08	1.86E-08	1.88E-08	1.86E-08	1.95E-08	1.66E-08
684	2.23E-08	2.30E-08	2.40E-08	2.48E-08	2.43E-08	2.59E-08	2.33E-08
685	1.02E-08	1.09E-08	1.19E-08	1.48E-08	1.39E-08	1.64E-08	9.47E-09
686	1.02E-08	1.12E-08	1.00E-08	1.26E-08	1.19E-08	1.53E-08	7.01E-09
688	3.29E-09	3.75E-09	4.75E-09	4.63E-09	2.28E-09	6.02E-09	2.44E-09
689	8.64E-09	8.65E-09	9.25E-09	1.12E-08	1.01E-08	1.24E-08	8.80E-09
690	3.20E-09	5.42E-09	5.19E-09	6.46E-09	5.55E-09	8.44E-09	2.69E-09
691	1.77E-08	1.78E-08	1.81E-08	1.83E-08	1.85E-08	1.88E-08	1.90E-08
692	2.71E-08	2.72E-08	2.72E-08	2.74E-08	2.76E-08	2.77E-08	2.77E-08
Biased Statistics							
Average Biased	1.76E-08	1.76E-08	1.87E-08	2.02E-08	1.89E-08	2.08E-08	1.70E-08
Std Dev Biased	9.25E-09	8.61E-09	7.93E-09	6.08E-09	7.13E-09	7.40E-09	9.10E-09
Ps90%/90% (+KTL) Biased	4.30E-08	4.12E-08	4.04E-08	3.69E-08	3.85E-08	4.11E-08	4.19E-08
Ps90%/90% (-KTL) Biased	-7.72E-09	-6.06E-09	-3.08E-09	3.55E-09	-6.29E-10	4.49E-10	-7.98E-09
Un-Biased Statistics							
Average Un-Biased	7.11E-09	7.98E-09	8.21E-09	9.94E-09	8.75E-09	1.17E-08	6.08E-09
Std Dev Un-Biased	3.59E-09	3.30E-09	3.11E-09	4.26E-09	4.76E-09	4.43E-09	3.34E-09
Ps90%/90% (+KTL) Un-Biased	1.70E-08	1.70E-08	1.67E-08	2.16E-08	2.18E-08	2.39E-08	1.52E-08
Ps90%/90% (-KTL) Un-Biased	-2.73E-09	-1.07E-09	-3.19E-10	-1.74E-09	-4.30E-09	-4.34E-10	-3.06E-09
Specification MIN	-6.50E-08	-6.50E-08	-6.50E-08	-6.50E-08	-6.50E-08	-6.50E-08	-6.50E-08
Status	PASS	PASS	PASS	PASS	PASS	PASS	PASS
Specification MAX	6.50E-08	6.50E-08	6.50E-08	6.50E-08	6.50E-08	6.50E-08	6.50E-08
Status	PASS	PASS	PASS	PASS	PASS	PASS	PASS

An ISO 9001:2008 and DLA Certified Company

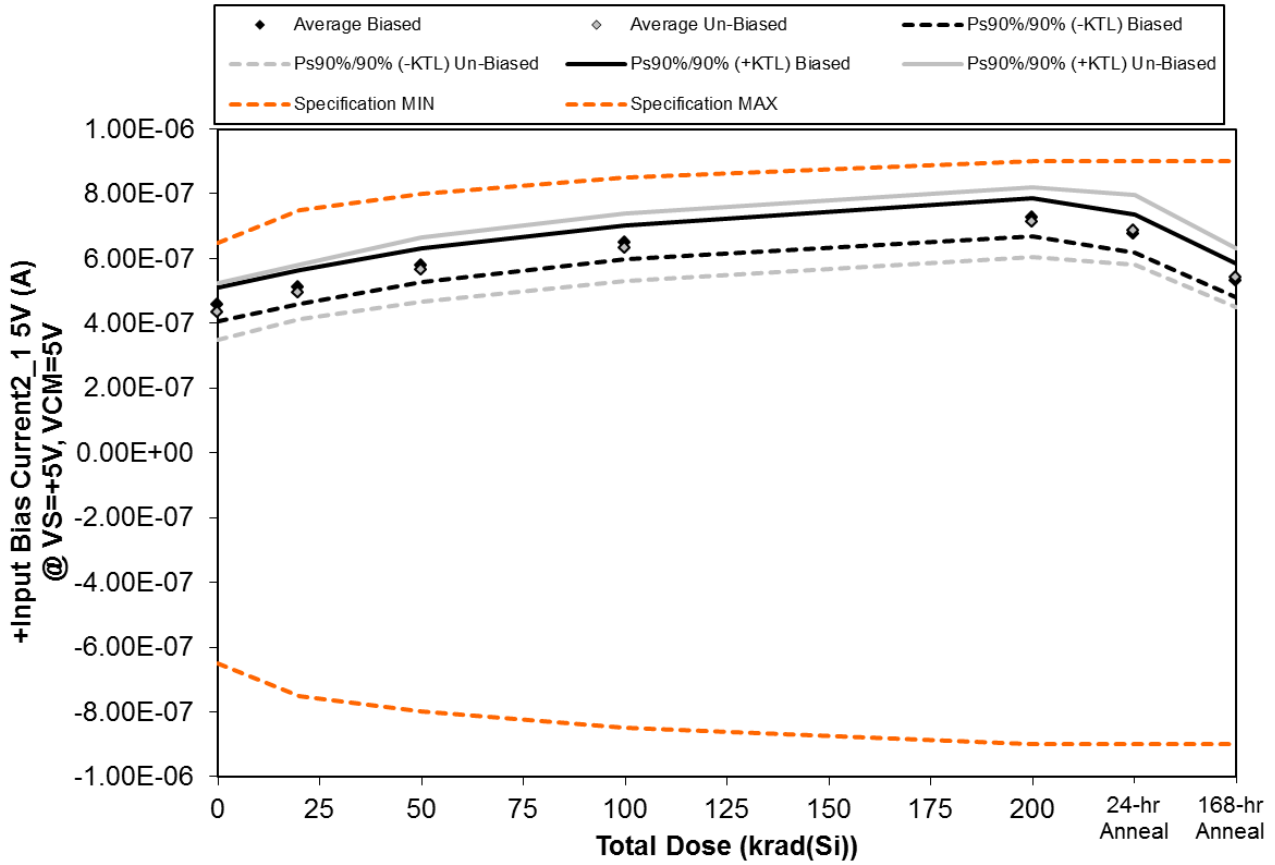

Figure 5.73. Plot of +Input Bias Current2_1 5V (A) @ VS=+5V, VCM=5V versus total dose. The solid diamonds are the average of the measured data points for the samples irradiated under electrical bias while the shaded diamonds are the average of the measured data points for the samples irradiated with all pins tied to ground. The black lines (solid and/or dashed) are the upper and/or lower confidence limits, as determined by KTL statistics, on the samples irradiated under electrical bias while the gray lines (solid and/or dashed) are the upper and/or lower confidence limits, as determined by KTL statistics, on the samples irradiated in the unbiased condition. The red dotted line(s) are the pre- and/or post-irradiation minimum and/or maximum specification value as defined in the datasheet and/or test plan.



TID Report
15-0091 03/20/15 R1.0

Aeroflex RAD
5030 Centennial Blvd.
Colorado Springs, CO 80919
(719) 531-0800

Table 5.73. Raw data for +Input Bias Current2_1 5V (A) @ VS=+5V, VCM=5V versus total dose, including the statistical analysis, specification and the status of the testing (pass/fail).

+Input Bias Current2_1 5V (A) @ VS=+5V, VCM=5V	Total Dose (krad(Si))					24-hr	168-hr
	0	20	50	100	200	Anneal	Anneal
Device							
680	4.64E-07	5.18E-07	5.93E-07	6.61E-07	7.40E-07	6.91E-07	5.39E-07
681	4.51E-07	5.04E-07	5.68E-07	6.38E-07	7.14E-07	6.64E-07	5.24E-07
682	4.81E-07	5.36E-07	6.03E-07	6.72E-07	7.55E-07	7.00E-07	5.57E-07
683	4.29E-07	4.84E-07	5.55E-07	6.23E-07	6.99E-07	6.47E-07	5.05E-07
684	4.61E-07	5.14E-07	5.85E-07	6.50E-07	7.28E-07	6.79E-07	5.38E-07
685	4.51E-07	5.07E-07	5.79E-07	6.47E-07	7.26E-07	7.00E-07	5.55E-07
686	4.53E-07	5.13E-07	5.81E-07	6.51E-07	7.30E-07	7.05E-07	5.51E-07
688	3.91E-07	4.53E-07	5.16E-07	5.81E-07	6.64E-07	6.38E-07	4.94E-07
689	4.18E-07	4.79E-07	5.48E-07	6.14E-07	6.83E-07	6.61E-07	5.24E-07
690	4.70E-07	5.31E-07	6.11E-07	6.81E-07	7.60E-07	7.37E-07	5.82E-07
691	4.53E-07	4.53E-07	4.54E-07	4.54E-07	4.55E-07	4.56E-07	4.57E-07
692	4.55E-07	4.54E-07	4.54E-07	4.54E-07	4.55E-07	4.55E-07	4.56E-07
Biased Statistics							
Average Biased	4.57E-07	5.11E-07	5.81E-07	6.49E-07	7.27E-07	6.76E-07	5.33E-07
Std Dev Biased	1.90E-08	1.91E-08	1.92E-08	1.91E-08	2.18E-08	2.14E-08	1.94E-08
Ps90%/90% (+KTL) Biased	5.10E-07	5.64E-07	6.33E-07	7.01E-07	7.87E-07	7.35E-07	5.86E-07
Ps90%/90% (-KTL) Biased	4.05E-07	4.59E-07	5.28E-07	5.96E-07	6.67E-07	6.17E-07	4.80E-07
Un-Biased Statistics							
Average Un-Biased	4.37E-07	4.97E-07	5.67E-07	6.35E-07	7.12E-07	6.88E-07	5.41E-07
Std Dev Un-Biased	3.17E-08	3.08E-08	3.62E-08	3.84E-08	3.87E-08	3.91E-08	3.33E-08
Ps90%/90% (+KTL) Un-Biased	5.24E-07	5.81E-07	6.66E-07	7.40E-07	8.19E-07	7.96E-07	6.33E-07
Ps90%/90% (-KTL) Un-Biased	3.49E-07	4.12E-07	4.68E-07	5.29E-07	6.06E-07	5.81E-07	4.50E-07
Specification MIN	-6.50E-07	-7.50E-07	-8.00E-07	-8.50E-07	-9.00E-07	-9.00E-07	-9.00E-07
Status	PASS	PASS	PASS	PASS	PASS	PASS	PASS
Specification MAX	6.50E-07	7.50E-07	8.00E-07	8.50E-07	9.00E-07	9.00E-07	9.00E-07
Status	PASS	PASS	PASS	PASS	PASS	PASS	PASS

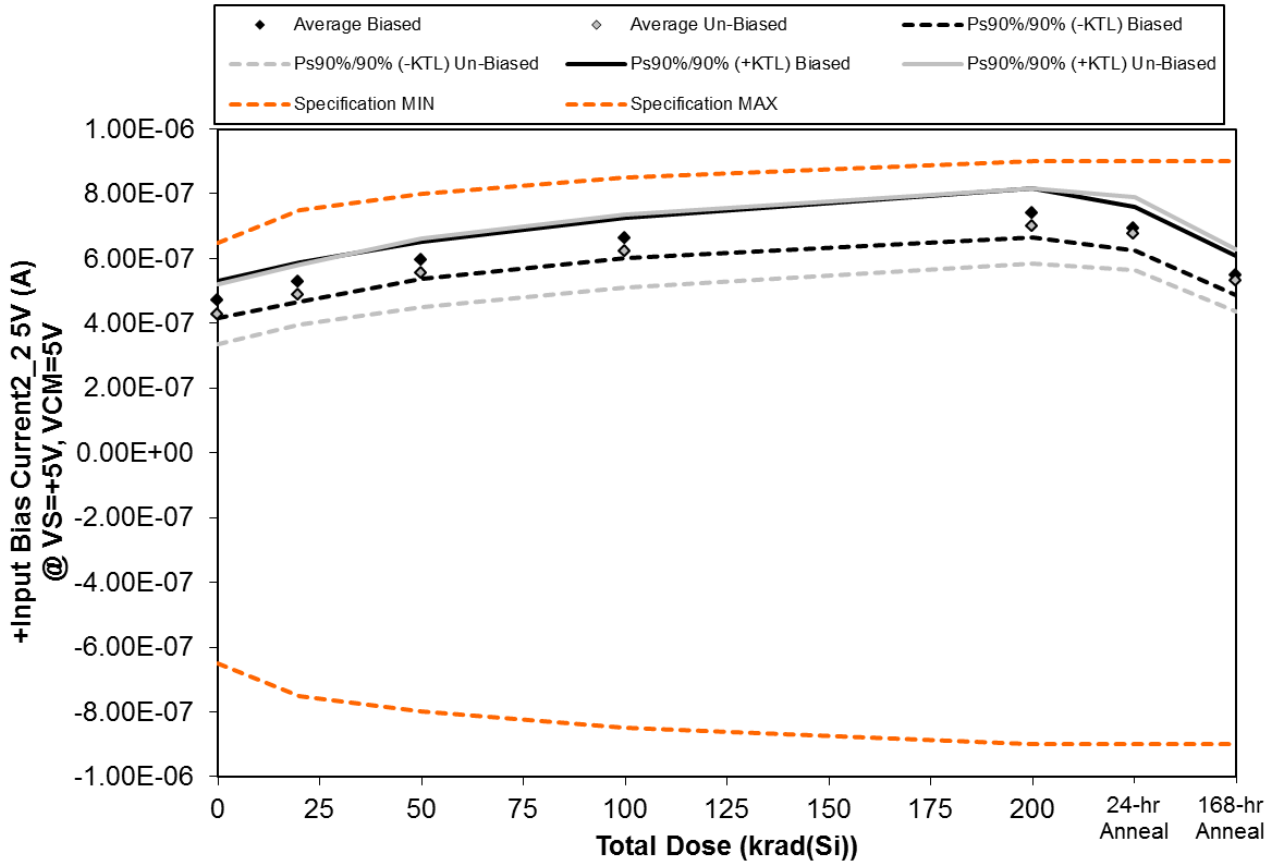

Figure 5.74. Plot of +Input Bias Current2_2 5V (A) @ VS=+5V, VCM=5V versus total dose. The solid diamonds are the average of the measured data points for the samples irradiated under electrical bias while the shaded diamonds are the average of the measured data points for the samples irradiated with all pins tied to ground. The black lines (solid and/or dashed) are the upper and/or lower confidence limits, as determined by KTL statistics, on the samples irradiated under electrical bias while the gray lines (solid and/or dashed) are the upper and/or lower confidence limits, as determined by KTL statistics, on the samples irradiated in the unbiased condition. The red dotted line(s) are the pre- and/or post-irradiation minimum and/or maximum specification value as defined in the datasheet and/or test plan.



TID Report
15-0091 03/20/15 R1.0

Aeroflex RAD
5030 Centennial Blvd.
Colorado Springs, CO 80919
(719) 531-0800

Table 5.74. Raw data for +Input Bias Current_{2_2 5V (A)} @ VS=+5V, VCM=5V versus total dose, including the statistical analysis, specification and the status of the testing (pass/fail).

+Input Bias Current _{2_2 5V (A)} @ VS=+5V, VCM=5V	Total Dose (krad(Si))					24-hr	168-hr
	0	20	50	100	200	Anneal	Anneal
Device							
680	4.65E-07	5.22E-07	5.95E-07	6.64E-07	7.44E-07	6.96E-07	5.41E-07
681	4.75E-07	5.28E-07	5.94E-07	6.58E-07	7.33E-07	6.87E-07	5.50E-07
682	5.00E-07	5.56E-07	6.22E-07	6.95E-07	7.80E-07	7.24E-07	5.77E-07
683	4.43E-07	4.96E-07	5.63E-07	6.33E-07	7.04E-07	6.57E-07	5.17E-07
684	4.81E-07	5.38E-07	6.02E-07	6.72E-07	7.48E-07	6.99E-07	5.54E-07
685	4.49E-07	5.06E-07	5.76E-07	6.45E-07	7.22E-07	6.97E-07	5.52E-07
686	4.55E-07	5.14E-07	5.83E-07	6.51E-07	7.33E-07	7.07E-07	5.55E-07
688	3.73E-07	4.31E-07	4.94E-07	5.57E-07	6.36E-07	6.14E-07	4.76E-07
689	4.21E-07	4.79E-07	5.44E-07	6.09E-07	6.77E-07	6.59E-07	5.25E-07
690	4.45E-07	5.05E-07	5.85E-07	6.53E-07	7.33E-07	7.09E-07	5.57E-07
691	4.69E-07	4.68E-07	4.69E-07	4.69E-07	4.70E-07	4.71E-07	4.71E-07
692	4.64E-07	4.63E-07	4.64E-07	4.64E-07	4.64E-07	4.64E-07	4.65E-07
Biased Statistics							
Average Biased	4.73E-07	5.28E-07	5.95E-07	6.64E-07	7.42E-07	6.93E-07	5.48E-07
Std Dev Biased	2.11E-08	2.21E-08	2.10E-08	2.24E-08	2.76E-08	2.42E-08	2.18E-08
Ps90%/90% (+KTL) Biased	5.31E-07	5.89E-07	6.53E-07	7.26E-07	8.18E-07	7.59E-07	6.08E-07
Ps90%/90% (-KTL) Biased	4.15E-07	4.67E-07	5.38E-07	6.03E-07	6.66E-07	6.26E-07	4.88E-07
Un-Biased Statistics							
Average Un-Biased	4.29E-07	4.87E-07	5.56E-07	6.23E-07	7.00E-07	6.77E-07	5.33E-07
Std Dev Un-Biased	3.37E-08	3.37E-08	3.87E-08	4.09E-08	4.26E-08	4.06E-08	3.46E-08
Ps90%/90% (+KTL) Un-Biased	5.21E-07	5.80E-07	6.62E-07	7.35E-07	8.17E-07	7.88E-07	6.28E-07
Ps90%/90% (-KTL) Un-Biased	3.36E-07	3.95E-07	4.50E-07	5.11E-07	5.83E-07	5.66E-07	4.38E-07
Specification MIN	-6.50E-07	-7.50E-07	-8.00E-07	-8.50E-07	-9.00E-07	-9.00E-07	-9.00E-07
Status	PASS	PASS	PASS	PASS	PASS	PASS	PASS
Specification MAX	6.50E-07	7.50E-07	8.00E-07	8.50E-07	9.00E-07	9.00E-07	9.00E-07
Status	PASS	PASS	PASS	PASS	PASS	PASS	PASS

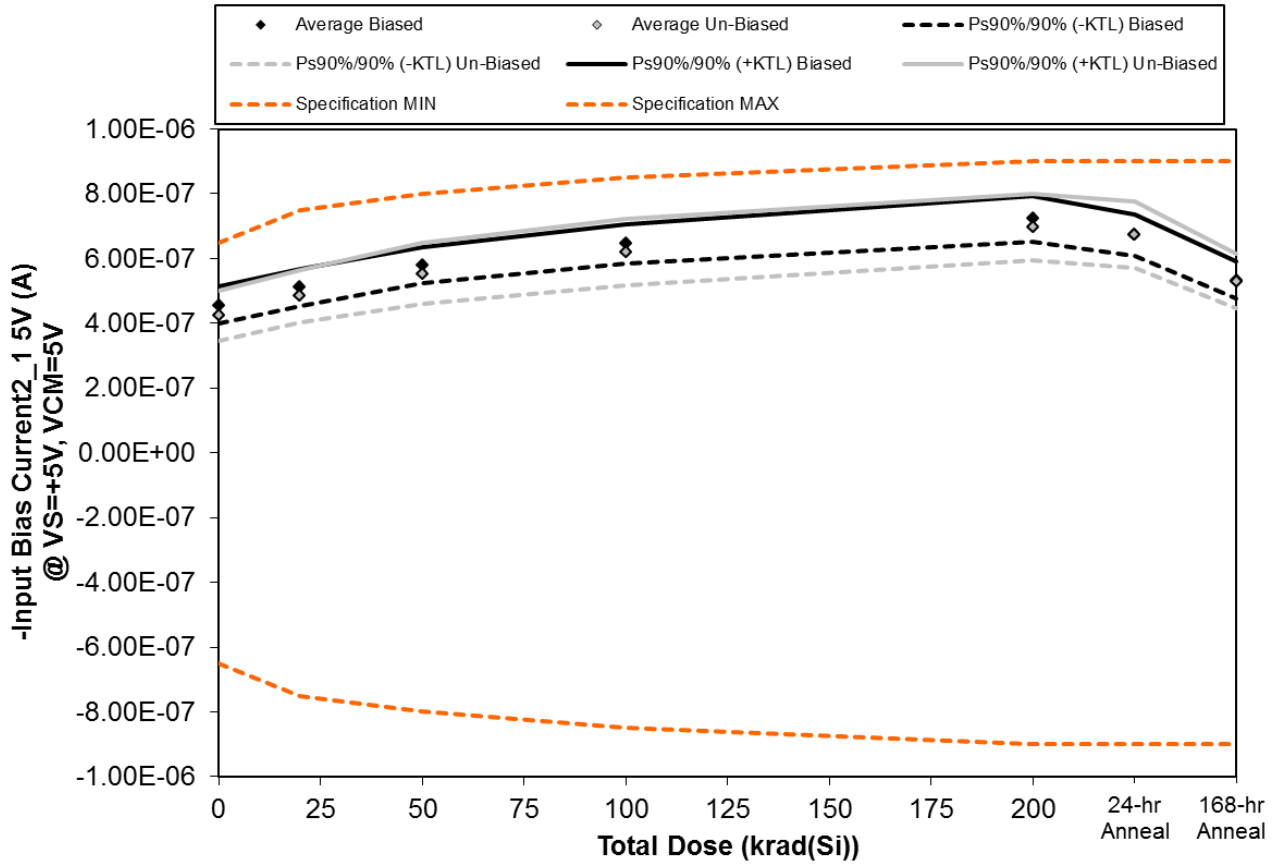

Figure 5.75. Plot of -Input Bias Current2_1 5V (A) @ VS=+5V, VCM=5V versus total dose. The solid diamonds are the average of the measured data points for the samples irradiated under electrical bias while the shaded diamonds are the average of the measured data points for the samples irradiated with all pins tied to ground. The black lines (solid and/or dashed) are the upper and/or lower confidence limits, as determined by KTL statistics, on the samples irradiated under electrical bias while the gray lines (solid and/or dashed) are the upper and/or lower confidence limits, as determined by KTL statistics, on the samples irradiated in the unbiased condition. The red dotted line(s) are the pre- and/or post-irradiation minimum and/or maximum specification value as defined in the datasheet and/or test plan.



TID Report
15-0091 03/20/15 R1.0

Aeroflex RAD
5030 Centennial Blvd.
Colorado Springs, CO 80919
(719) 531-0800

Table 5.75. Raw data for -Input Bias Current2_1 5V (A) @ VS=+5V, VCM=5V versus total dose, including the statistical analysis, specification and the status of the testing (pass/fail).

-Input Bias Current2_1 5V (A) @ VS=+5V, VCM=5V	Total Dose (krad(Si))					24-hr Anneal	168-hr Anneal
	0	20	50	100	200		
Device							
680	4.59E-07	5.13E-07	5.86E-07	6.47E-07	7.28E-07	6.79E-07	5.35E-07
681	4.49E-07	5.04E-07	5.69E-07	6.34E-07	7.11E-07	6.62E-07	5.26E-07
682	4.89E-07	5.45E-07	6.09E-07	6.81E-07	7.64E-07	7.09E-07	5.66E-07
683	4.31E-07	4.88E-07	5.56E-07	6.23E-07	6.96E-07	6.46E-07	5.10E-07
684	4.52E-07	5.06E-07	5.75E-07	6.41E-07	7.18E-07	6.69E-07	5.32E-07
685	4.39E-07	4.99E-07	5.67E-07	6.35E-07	7.12E-07	6.86E-07	5.45E-07
686	4.43E-07	5.05E-07	5.75E-07	6.43E-07	7.22E-07	6.95E-07	5.48E-07
688	3.77E-07	4.35E-07	4.98E-07	5.60E-07	6.40E-07	6.14E-07	4.80E-07
689	4.17E-07	4.78E-07	5.47E-07	6.11E-07	6.84E-07	6.59E-07	5.26E-07
690	4.43E-07	5.03E-07	5.84E-07	6.54E-07	7.33E-07	7.09E-07	5.54E-07
691	4.50E-07	4.49E-07	4.50E-07	4.49E-07	4.49E-07	4.50E-07	4.50E-07
692	4.38E-07	4.37E-07	4.37E-07	4.37E-07	4.37E-07	4.38E-07	4.38E-07
Biased Statistics							
Average Biased	4.56E-07	5.11E-07	5.79E-07	6.45E-07	7.23E-07	6.73E-07	5.34E-07
Std Dev Biased	2.11E-08	2.12E-08	2.00E-08	2.19E-08	2.56E-08	2.33E-08	2.08E-08
Ps90%/90% (+KTL) Biased	5.14E-07	5.69E-07	6.34E-07	7.05E-07	7.94E-07	7.37E-07	5.91E-07
Ps90%/90% (-KTL) Biased	3.98E-07	4.53E-07	5.24E-07	5.85E-07	6.53E-07	6.09E-07	4.77E-07
Un-Biased Statistics							
Average Un-Biased	4.24E-07	4.84E-07	5.54E-07	6.20E-07	6.98E-07	6.73E-07	5.31E-07
Std Dev Un-Biased	2.85E-08	2.94E-08	3.44E-08	3.73E-08	3.76E-08	3.73E-08	3.04E-08
Ps90%/90% (+KTL) Un-Biased	5.02E-07	5.65E-07	6.48E-07	7.22E-07	8.01E-07	7.75E-07	6.14E-07
Ps90%/90% (-KTL) Un-Biased	3.46E-07	4.03E-07	4.60E-07	5.18E-07	5.95E-07	5.70E-07	4.47E-07
Specification MIN	-6.50E-07	-7.50E-07	-8.00E-07	-8.50E-07	-9.00E-07	-9.00E-07	-9.00E-07
Status	PASS	PASS	PASS	PASS	PASS	PASS	PASS
Specification MAX	6.50E-07	7.50E-07	8.00E-07	8.50E-07	9.00E-07	9.00E-07	9.00E-07
Status	PASS	PASS	PASS	PASS	PASS	PASS	PASS

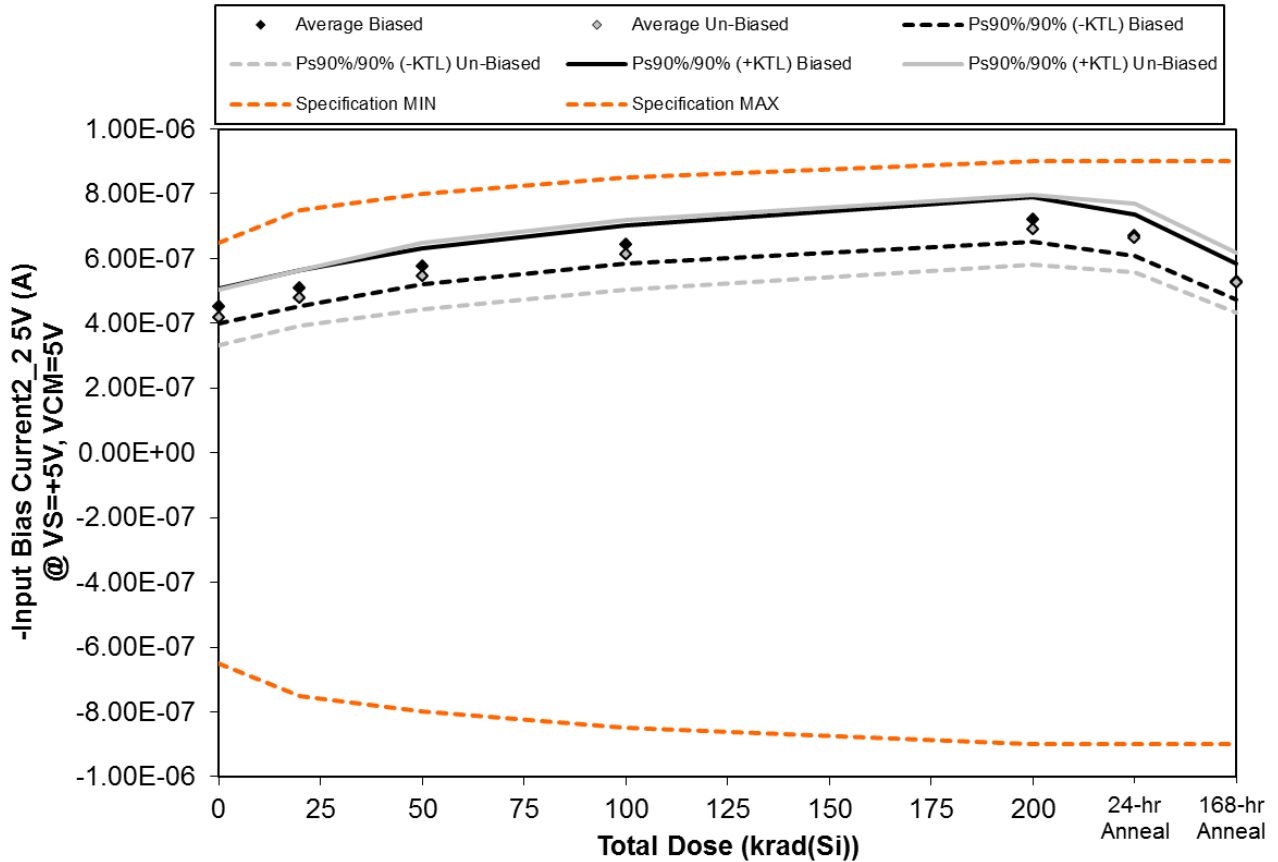

Figure 5.76. Plot of -Input Bias Current2_2 5V (A) @ VS=+5V, VCM=5V versus total dose. The solid diamonds are the average of the measured data points for the samples irradiated under electrical bias while the shaded diamonds are the average of the measured data points for the samples irradiated with all pins tied to ground. The black lines (solid and/or dashed) are the upper and/or lower confidence limits, as determined by KTL statistics, on the samples irradiated under electrical bias while the gray lines (solid and/or dashed) are the upper and/or lower confidence limits, as determined by KTL statistics, on the samples irradiated in the unbiased condition. The red dotted line(s) are the pre- and/or post-irradiation minimum and/or maximum specification value as defined in the datasheet and/or test plan.



TID Report
15-0091 03/20/15 R1.0

Aeroflex RAD
5030 Centennial Blvd.
Colorado Springs, CO 80919
(719) 531-0800

Table 5.76. Raw data for -Input Bias Current2_2 5V (A) @ VS=+5V, VCM=5V versus total dose, including the statistical analysis, specification and the status of the testing (pass/fail).

-Input Bias Current2_2 5V (A) @ VS=+5V, VCM=5V	Total Dose (krad(Si))					24-hr	168-hr
	0	20	50	100	200	Anneal	Anneal
Device							
680	4.61E-07	5.18E-07	5.88E-07	6.54E-07	7.34E-07	6.85E-07	5.38E-07
681	4.49E-07	5.05E-07	5.71E-07	6.35E-07	7.14E-07	6.63E-07	5.27E-07
682	4.75E-07	5.32E-07	5.97E-07	6.68E-07	7.52E-07	6.96E-07	5.54E-07
683	4.22E-07	4.77E-07	5.44E-07	6.12E-07	6.84E-07	6.36E-07	4.99E-07
684	4.55E-07	5.10E-07	5.80E-07	6.46E-07	7.24E-07	6.75E-07	5.35E-07
685	4.37E-07	4.94E-07	5.62E-07	6.30E-07	7.05E-07	6.81E-07	5.42E-07
686	4.42E-07	5.01E-07	5.71E-07	6.38E-07	7.18E-07	6.90E-07	5.47E-07
688	3.68E-07	4.26E-07	4.88E-07	5.51E-07	6.31E-07	6.06E-07	4.71E-07
689	4.11E-07	4.69E-07	5.32E-07	5.95E-07	6.68E-07	6.45E-07	5.14E-07
690	4.40E-07	5.00E-07	5.79E-07	6.47E-07	7.24E-07	6.99E-07	5.52E-07
691	4.49E-07	4.49E-07	4.50E-07	4.49E-07	4.50E-07	4.50E-07	4.49E-07
692	4.36E-07	4.37E-07	4.36E-07	4.36E-07	4.35E-07	4.37E-07	4.36E-07
Biased Statistics							
Average Biased	4.52E-07	5.09E-07	5.76E-07	6.43E-07	7.21E-07	6.71E-07	5.30E-07
Std Dev Biased	1.96E-08	2.04E-08	2.05E-08	2.11E-08	2.51E-08	2.32E-08	2.02E-08
Ps90%/90% (+KTL) Biased	5.06E-07	5.64E-07	6.32E-07	7.01E-07	7.90E-07	7.35E-07	5.86E-07
Ps90%/90% (-KTL) Biased	3.99E-07	4.53E-07	5.20E-07	5.85E-07	6.53E-07	6.07E-07	4.75E-07
Un-Biased Statistics							
Average Un-Biased	4.20E-07	4.78E-07	5.46E-07	6.12E-07	6.89E-07	6.64E-07	5.25E-07
Std Dev Un-Biased	3.13E-08	3.16E-08	3.73E-08	3.93E-08	3.90E-08	3.84E-08	3.34E-08
Ps90%/90% (+KTL) Un-Biased	5.05E-07	5.65E-07	6.49E-07	7.20E-07	7.96E-07	7.69E-07	6.17E-07
Ps90%/90% (-KTL) Un-Biased	3.34E-07	3.92E-07	4.44E-07	5.04E-07	5.82E-07	5.59E-07	4.34E-07
Specification MIN	-6.50E-07	-7.50E-07	-8.00E-07	-8.50E-07	-9.00E-07	-9.00E-07	-9.00E-07
Status	PASS	PASS	PASS	PASS	PASS	PASS	PASS
Specification MAX	6.50E-07	7.50E-07	8.00E-07	8.50E-07	9.00E-07	9.00E-07	9.00E-07
Status	PASS	PASS	PASS	PASS	PASS	PASS	PASS

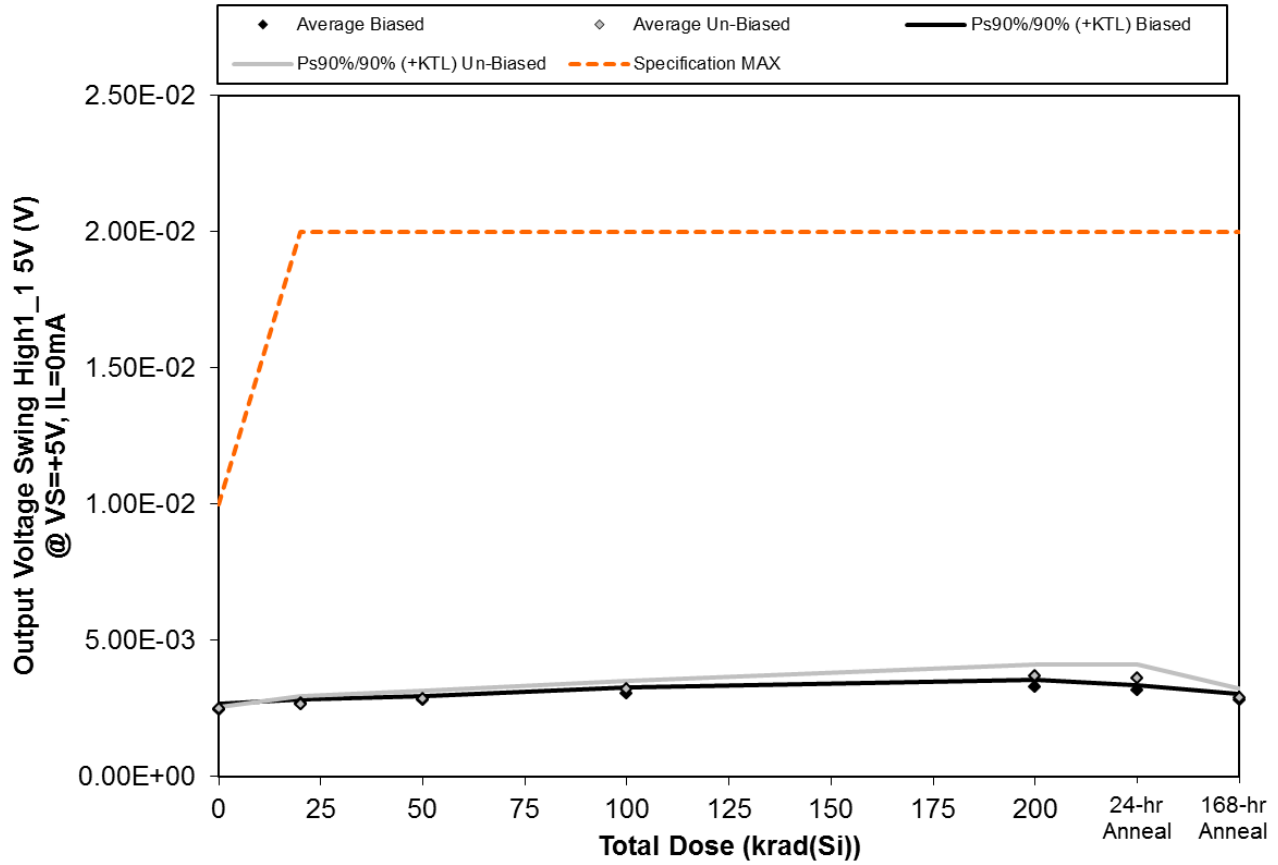

Figure 5.77. Plot of Output Voltage Swing High1_1 5V (V) @ VS=+5V, IL=0mA versus total dose. The solid diamonds are the average of the measured data points for the samples irradiated under electrical bias while the shaded diamonds are the average of the measured data points for the samples irradiated with all pins tied to ground. The black lines (solid and/or dashed) are the upper and/or lower confidence limits, as determined by KTL statistics, on the samples irradiated under electrical bias while the gray lines (solid and/or dashed) are the upper and/or lower confidence limits, as determined by KTL statistics, on the samples irradiated in the unbiased condition. The red dotted line(s) are the pre- and/or post-irradiation minimum and/or maximum specification value as defined in the datasheet and/or test plan.



TID Report
15-0091 03/20/15 R1.0

Aeroflex RAD
5030 Centennial Blvd.
Colorado Springs, CO 80919
(719) 531-0800

Table 5.77. Raw data for Output Voltage Swing High1_1 5V (V) @ VS=+5V, IL=0mA versus total dose, including the statistical analysis, specification and the status of the testing (pass/fail).

Output Voltage Swing High1_1 5V (V) @ VS=+5V, IL=0mA	Total Dose (krad(Si))					24-hr Anneal	168-hr Anneal
	0	20	50	100	200		
Device							
680	2.54E-03	2.70E-03	2.90E-03	3.10E-03	3.39E-03	3.22E-03	2.83E-03
681	2.54E-03	2.69E-03	2.85E-03	3.10E-03	3.39E-03	3.27E-03	2.90E-03
682	2.37E-03	2.60E-03	2.77E-03	2.93E-03	3.17E-03	3.12E-03	2.70E-03
683	2.41E-03	2.70E-03	2.85E-03	3.14E-03	3.23E-03	3.13E-03	2.89E-03
684	2.39E-03	2.75E-03	2.80E-03	3.00E-03	3.23E-03	3.15E-03	2.81E-03
685	2.48E-03	2.75E-03	2.81E-03	3.22E-03	3.66E-03	3.52E-03	2.87E-03
686	2.48E-03	2.76E-03	2.95E-03	3.24E-03	3.77E-03	3.70E-03	2.91E-03
688	2.47E-03	2.50E-03	2.70E-03	3.03E-03	3.54E-03	3.37E-03	2.79E-03
689	2.50E-03	2.64E-03	2.83E-03	3.30E-03	3.51E-03	3.56E-03	2.82E-03
690	2.54E-03	2.62E-03	2.95E-03	3.30E-03	3.90E-03	3.86E-03	3.10E-03
691	2.40E-03	2.48E-03	2.53E-03	2.52E-03	2.53E-03	2.52E-03	2.55E-03
692	2.75E-03	2.71E-03	2.80E-03	2.75E-03	2.78E-03	2.80E-03	2.86E-03
Biased Statistics							
Average Biased	2.45E-03	2.69E-03	2.83E-03	3.05E-03	3.28E-03	3.18E-03	2.83E-03
Std Dev Biased	8.34E-05	5.45E-05	5.03E-05	8.65E-05	1.02E-04	6.46E-05	8.02E-05
Ps90%/90% (+KTL) Biased	2.68E-03	2.84E-03	2.97E-03	3.29E-03	3.56E-03	3.36E-03	3.05E-03
Ps90%/90% (-KTL) Biased	2.22E-03	2.54E-03	2.70E-03	2.82E-03	3.00E-03	3.00E-03	2.61E-03
Un-Biased Statistics							
Average Un-Biased	2.49E-03	2.65E-03	2.85E-03	3.22E-03	3.68E-03	3.60E-03	2.90E-03
Std Dev Un-Biased	2.79E-05	1.07E-04	1.05E-04	1.11E-04	1.62E-04	1.86E-04	1.22E-04
Ps90%/90% (+KTL) Un-Biased	2.57E-03	2.95E-03	3.14E-03	3.52E-03	4.12E-03	4.11E-03	3.23E-03
Ps90%/90% (-KTL) Un-Biased	2.42E-03	2.36E-03	2.56E-03	2.91E-03	3.23E-03	3.09E-03	2.56E-03
Specification MAX	1.00E-02	2.00E-02	2.00E-02	2.00E-02	2.00E-02	2.00E-02	2.00E-02
Status	PASS	PASS	PASS	PASS	PASS	PASS	PASS

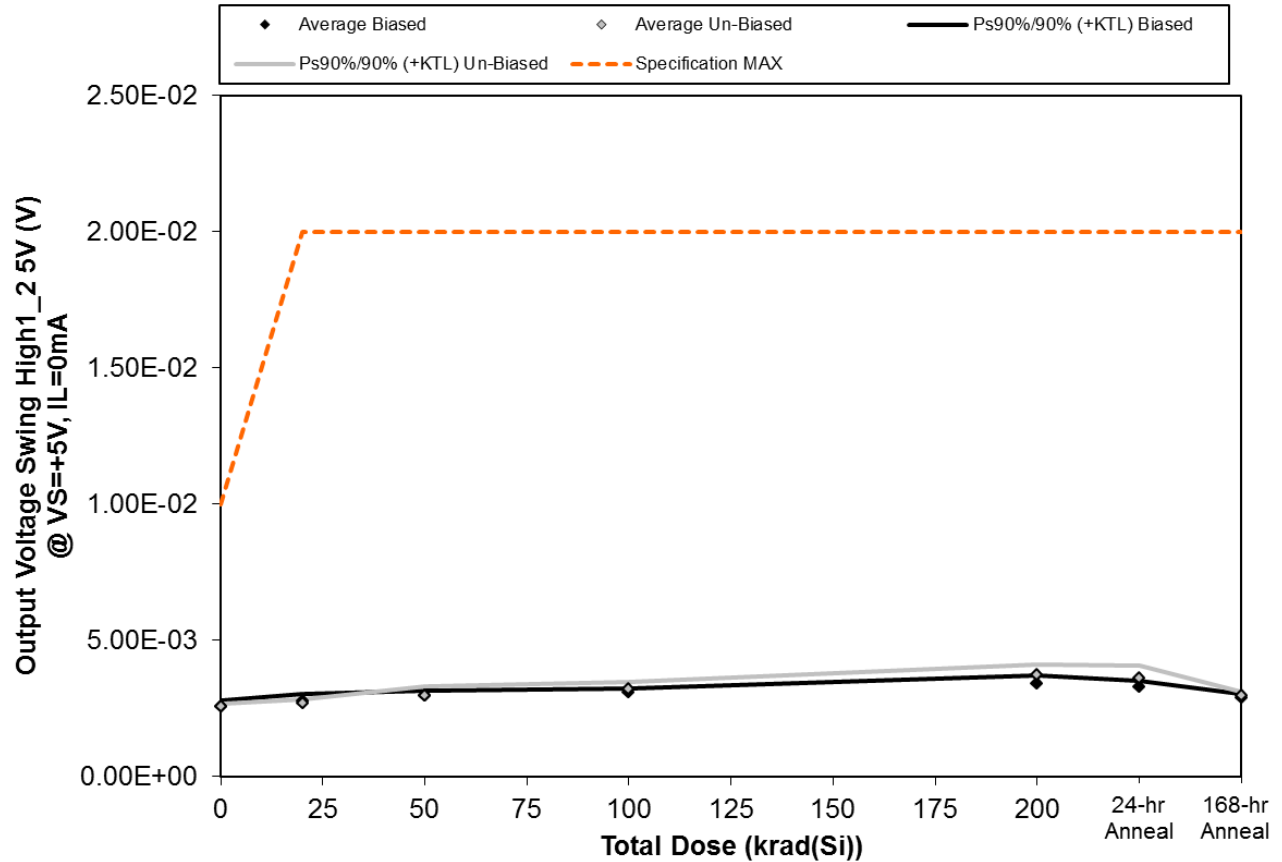

Figure 5.78. Plot of Output Voltage Swing High1_2 5V (V) @ VS=+5V, IL=0mA versus total dose. The solid diamonds are the average of the measured data points for the samples irradiated under electrical bias while the shaded diamonds are the average of the measured data points for the samples irradiated with all pins tied to ground. The black lines (solid and/or dashed) are the upper and/or lower confidence limits, as determined by KTL statistics, on the samples irradiated under electrical bias while the gray lines (solid and/or dashed) are the upper and/or lower confidence limits, as determined by KTL statistics, on the samples irradiated in the unbiased condition. The red dotted line(s) are the pre- and/or post-irradiation minimum and/or maximum specification value as defined in the datasheet and/or test plan.



TID Report
15-0091 03/20/15 R1.0

Aeroflex RAD
5030 Centennial Blvd.
Colorado Springs, CO 80919
(719) 531-0800

Table 5.78. Raw data for Output Voltage Swing High1_2 5V (V) @ VS=+5V, IL=0mA versus total dose, including the statistical analysis, specification and the status of the testing (pass/fail).

Output Voltage Swing High1_2 5V (V) @ VS=+5V, IL=0mA	Total Dose (krad(Si))					24-hr Anneal	168-hr Anneal
	0	20	50	100	200		
Device							
680	2.71E-03	2.85E-03	3.05E-03	3.13E-03	3.51E-03	3.35E-03	2.91E-03
681	2.57E-03	2.77E-03	3.02E-03	3.13E-03	3.48E-03	3.39E-03	2.92E-03
682	2.54E-03	2.60E-03	2.96E-03	3.00E-03	3.23E-03	3.23E-03	2.97E-03
683	2.55E-03	2.76E-03	2.92E-03	3.08E-03	3.40E-03	3.23E-03	2.85E-03
684	2.53E-03	2.82E-03	2.88E-03	3.10E-03	3.42E-03	3.34E-03	2.87E-03
685	2.59E-03	2.67E-03	2.92E-03	3.24E-03	3.75E-03	3.68E-03	2.98E-03
686	2.58E-03	2.77E-03	3.11E-03	3.25E-03	3.86E-03	3.70E-03	3.02E-03
688	2.58E-03	2.60E-03	2.75E-03	3.08E-03	3.53E-03	3.35E-03	2.90E-03
689	2.50E-03	2.69E-03	2.95E-03	3.17E-03	3.68E-03	3.55E-03	2.94E-03
690	2.54E-03	2.70E-03	3.05E-03	3.32E-03	3.88E-03	3.79E-03	3.01E-03
691	2.56E-03	2.60E-03	2.63E-03	2.65E-03	2.62E-03	2.63E-03	2.65E-03
692	2.69E-03	2.69E-03	2.73E-03	2.79E-03	2.77E-03	2.75E-03	2.79E-03
Biased Statistics							
Average Biased	2.58E-03	2.76E-03	2.97E-03	3.09E-03	3.41E-03	3.31E-03	2.90E-03
Std Dev Biased	7.42E-05	9.67E-05	6.99E-05	5.36E-05	1.09E-04	7.36E-05	4.67E-05
Ps90%/90% (+KTL) Biased	2.78E-03	3.03E-03	3.16E-03	3.23E-03	3.71E-03	3.51E-03	3.03E-03
Ps90%/90% (-KTL) Biased	2.38E-03	2.49E-03	2.77E-03	2.94E-03	3.11E-03	3.11E-03	2.78E-03
Un-Biased Statistics							
Average Un-Biased	2.56E-03	2.69E-03	2.96E-03	3.21E-03	3.74E-03	3.61E-03	2.97E-03
Std Dev Un-Biased	3.77E-05	6.11E-05	1.38E-04	9.09E-05	1.43E-04	1.71E-04	5.00E-05
Ps90%/90% (+KTL) Un-Biased	2.66E-03	2.85E-03	3.33E-03	3.46E-03	4.13E-03	4.08E-03	3.11E-03
Ps90%/90% (-KTL) Un-Biased	2.45E-03	2.52E-03	2.58E-03	2.96E-03	3.35E-03	3.15E-03	2.83E-03
Specification MAX	1.00E-02	2.00E-02	2.00E-02	2.00E-02	2.00E-02	2.00E-02	2.00E-02
Status	PASS	PASS	PASS	PASS	PASS	PASS	PASS

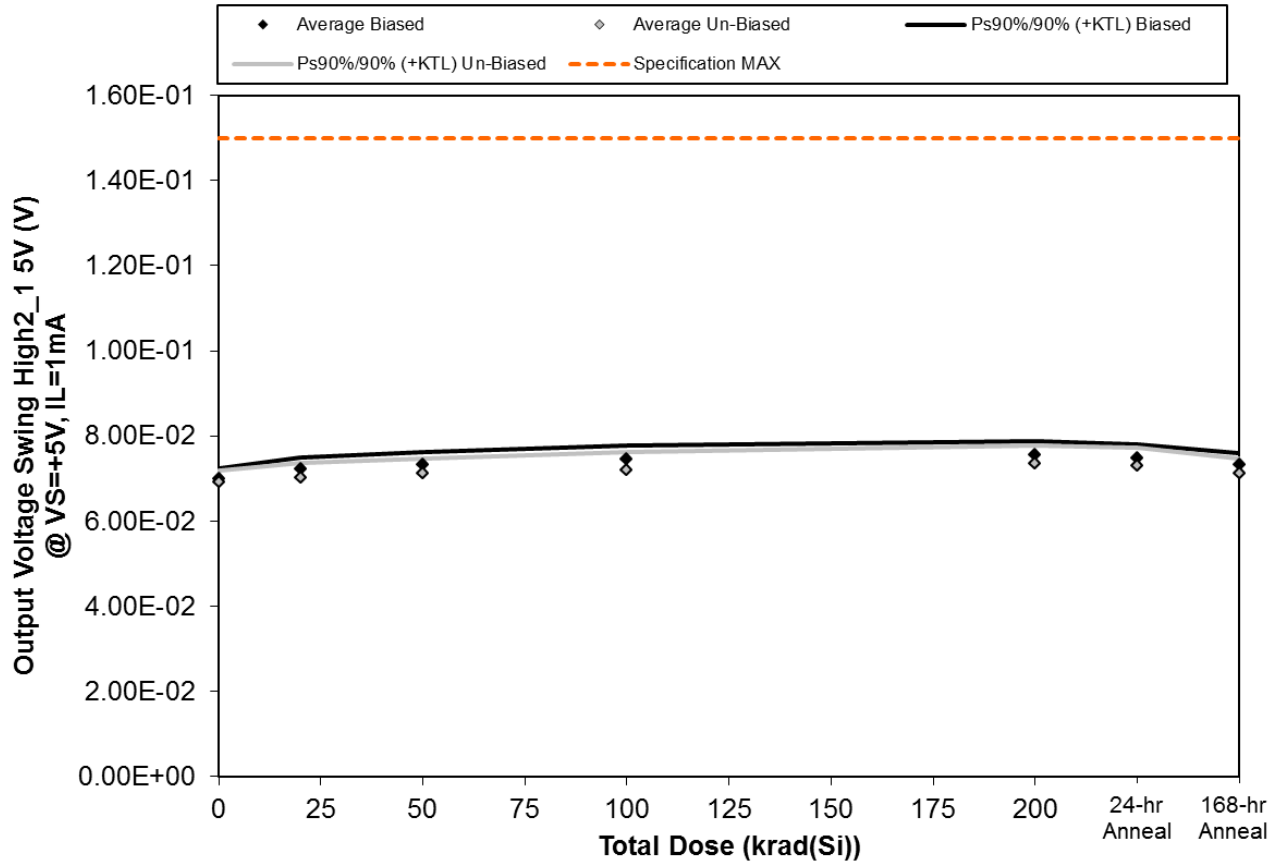

Figure 5.79. Plot of Output Voltage Swing High2_1 5V (V) @ VS=+5V, IL=1mA versus total dose. The solid diamonds are the average of the measured data points for the samples irradiated under electrical bias while the shaded diamonds are the average of the measured data points for the samples irradiated with all pins tied to ground. The black lines (solid and/or dashed) are the upper and/or lower confidence limits, as determined by KTL statistics, on the samples irradiated under electrical bias while the gray lines (solid and/or dashed) are the upper and/or lower confidence limits, as determined by KTL statistics, on the samples irradiated in the unbiased condition. The red dotted line(s) are the pre- and/or post-irradiation minimum and/or maximum specification value as defined in the datasheet and/or test plan.



TID Report
15-0091 03/20/15 R1.0

Aeroflex RAD
5030 Centennial Blvd.
Colorado Springs, CO 80919
(719) 531-0800

Table 5.79. Raw data for Output Voltage Swing High2_1 5V (V) @ VS=+5V, IL=1mA versus total dose, including the statistical analysis, specification and the status of the testing (pass/fail).

Output Voltage Swing High2_1 5V (V) @ VS=+5V, IL=1mA	Total Dose (krad(Si))					24-hr Anneal	168-hr Anneal
	0	20	50	100	200		
Device							
680	6.98E-02	7.20E-02	7.33E-02	7.51E-02	7.59E-02	7.50E-02	7.31E-02
681	7.08E-02	7.33E-02	7.45E-02	7.58E-02	7.68E-02	7.63E-02	7.46E-02
682	6.85E-02	7.08E-02	7.18E-02	7.29E-02	7.37E-02	7.33E-02	7.19E-02
683	7.07E-02	7.31E-02	7.41E-02	7.52E-02	7.63E-02	7.54E-02	7.39E-02
684	6.95E-02	7.18E-02	7.32E-02	7.40E-02	7.51E-02	7.45E-02	7.29E-02
685	6.92E-02	7.02E-02	7.11E-02	7.22E-02	7.36E-02	7.31E-02	7.12E-02
686	6.92E-02	7.00E-02	7.10E-02	7.21E-02	7.39E-02	7.32E-02	7.11E-02
688	6.77E-02	6.85E-02	6.92E-02	7.00E-02	7.13E-02	7.09E-02	6.93E-02
689	6.92E-02	7.02E-02	7.13E-02	7.23E-02	7.35E-02	7.33E-02	7.15E-02
690	7.05E-02	7.21E-02	7.29E-02	7.41E-02	7.57E-02	7.51E-02	7.27E-02
691	6.68E-02	6.68E-02	6.69E-02	6.69E-02	6.68E-02	6.67E-02	6.69E-02
692	7.06E-02	7.06E-02	7.06E-02	7.07E-02	7.05E-02	7.05E-02	7.05E-02
Biased Statistics							
Average Biased	6.99E-02	7.22E-02	7.34E-02	7.46E-02	7.56E-02	7.49E-02	7.33E-02
Std Dev Biased	9.41E-04	1.00E-03	1.03E-03	1.13E-03	1.20E-03	1.09E-03	1.03E-03
Ps90%/90% (+KTL) Biased	7.24E-02	7.49E-02	7.62E-02	7.77E-02	7.88E-02	7.79E-02	7.61E-02
Ps90%/90% (-KTL) Biased	6.73E-02	6.95E-02	7.06E-02	7.15E-02	7.23E-02	7.19E-02	7.04E-02
Un-Biased Statistics							
Average Un-Biased	6.92E-02	7.02E-02	7.11E-02	7.21E-02	7.36E-02	7.31E-02	7.12E-02
Std Dev Un-Biased	1.01E-03	1.30E-03	1.32E-03	1.46E-03	1.55E-03	1.48E-03	1.24E-03
Ps90%/90% (+KTL) Un-Biased	7.19E-02	7.38E-02	7.47E-02	7.61E-02	7.79E-02	7.72E-02	7.46E-02
Ps90%/90% (-KTL) Un-Biased	6.64E-02	6.66E-02	6.75E-02	6.81E-02	6.93E-02	6.90E-02	6.78E-02
Specification MAX	1.50E-01	1.50E-01	1.50E-01	1.50E-01	1.50E-01	1.50E-01	1.50E-01
Status	PASS	PASS	PASS	PASS	PASS	PASS	PASS

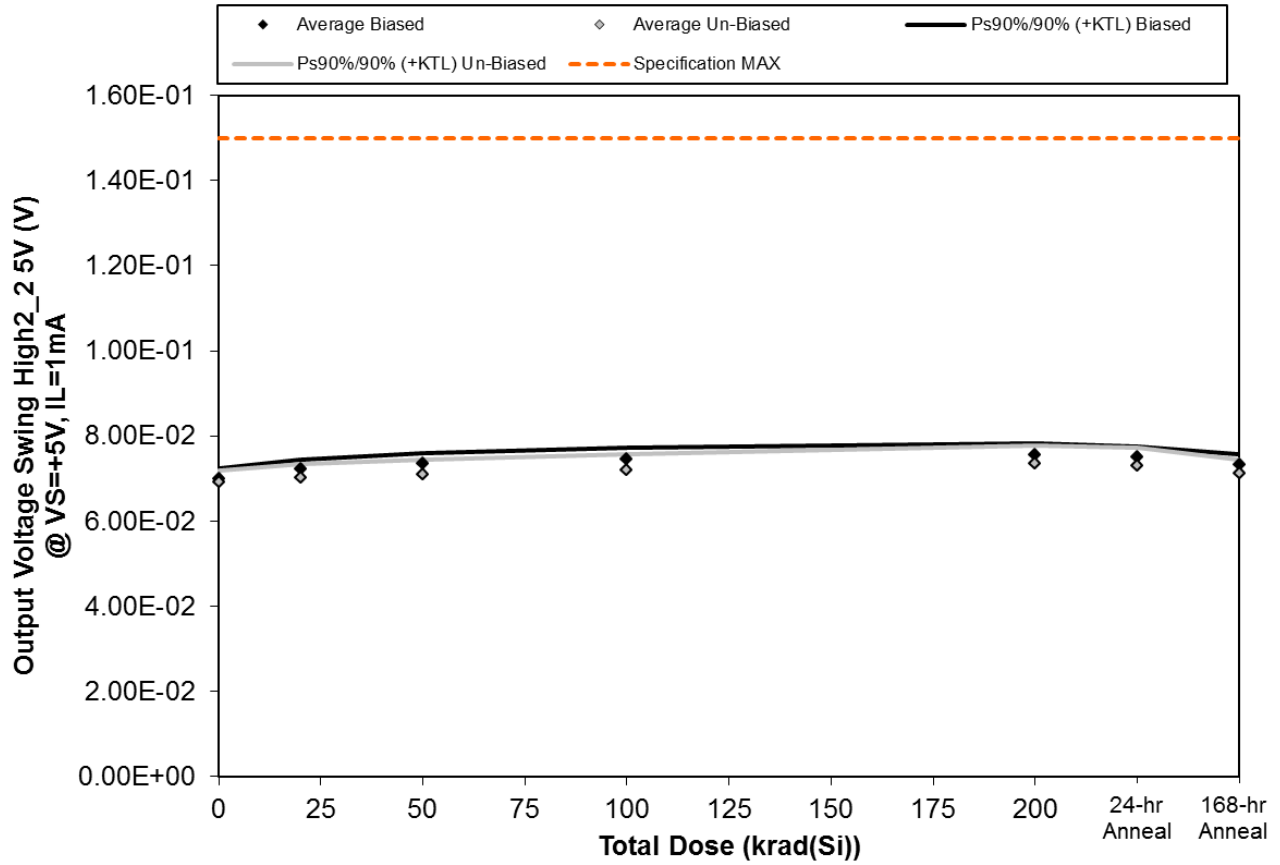

Figure 5.80. Plot of Output Voltage Swing High2_2 5V (V) @ VS=+5V, IL=1mA versus total dose. The solid diamonds are the average of the measured data points for the samples irradiated under electrical bias while the shaded diamonds are the average of the measured data points for the samples irradiated with all pins tied to ground. The black lines (solid and/or dashed) are the upper and/or lower confidence limits, as determined by KTL statistics, on the samples irradiated under electrical bias while the gray lines (solid and/or dashed) are the upper and/or lower confidence limits, as determined by KTL statistics, on the samples irradiated in the unbiased condition. The red dotted line(s) are the pre- and/or post-irradiation minimum and/or maximum specification value as defined in the datasheet and/or test plan.



TID Report
15-0091 03/20/15 R1.0

Aeroflex RAD
5030 Centennial Blvd.
Colorado Springs, CO 80919
(719) 531-0800

Table 5.80. Raw data for Output Voltage Swing High2_2 5V (V) @ VS=+5V, IL=1mA versus total dose, including the statistical analysis, specification and the status of the testing (pass/fail).

Output Voltage Swing High2_2 5V (V) @ VS=+5V, IL=1mA	Total Dose (krad(Si))					24-hr Anneal	168-hr Anneal
	0	20	50	100	200		
Device							
680	6.99E-02	7.21E-02	7.35E-02	7.52E-02	7.61E-02	7.52E-02	7.33E-02
681	7.10E-02	7.31E-02	7.43E-02	7.54E-02	7.65E-02	7.59E-02	7.41E-02
682	6.87E-02	7.10E-02	7.19E-02	7.30E-02	7.40E-02	7.34E-02	7.17E-02
683	7.05E-02	7.28E-02	7.39E-02	7.49E-02	7.60E-02	7.54E-02	7.38E-02
684	7.01E-02	7.22E-02	7.35E-02	7.43E-02	7.55E-02	7.49E-02	7.32E-02
685	6.90E-02	6.99E-02	7.10E-02	7.19E-02	7.35E-02	7.27E-02	7.10E-02
686	6.94E-02	7.04E-02	7.13E-02	7.23E-02	7.40E-02	7.35E-02	7.12E-02
688	6.78E-02	6.87E-02	6.92E-02	7.01E-02	7.13E-02	7.08E-02	6.95E-02
689	6.92E-02	7.02E-02	7.10E-02	7.20E-02	7.34E-02	7.30E-02	7.12E-02
690	7.05E-02	7.19E-02	7.27E-02	7.38E-02	7.56E-02	7.50E-02	7.28E-02
691	6.72E-02	6.72E-02	6.71E-02	6.73E-02	6.72E-02	6.71E-02	6.71E-02
692	7.04E-02	7.03E-02	7.03E-02	7.02E-02	7.04E-02	7.03E-02	7.03E-02
Biased Statistics							
Average Biased	7.00E-02	7.22E-02	7.34E-02	7.46E-02	7.56E-02	7.50E-02	7.32E-02
Std Dev Biased	8.58E-04	8.02E-04	9.04E-04	9.61E-04	9.84E-04	9.60E-04	9.28E-04
Ps90%/90% (+KTL) Biased	7.24E-02	7.44E-02	7.59E-02	7.72E-02	7.83E-02	7.76E-02	7.57E-02
Ps90%/90% (-KTL) Biased	6.77E-02	7.00E-02	7.09E-02	7.19E-02	7.29E-02	7.23E-02	7.07E-02
Un-Biased Statistics							
Average Un-Biased	6.92E-02	7.02E-02	7.10E-02	7.20E-02	7.36E-02	7.30E-02	7.11E-02
Std Dev Un-Biased	9.62E-04	1.15E-03	1.26E-03	1.33E-03	1.55E-03	1.52E-03	1.16E-03
Ps90%/90% (+KTL) Un-Biased	7.18E-02	7.34E-02	7.45E-02	7.56E-02	7.78E-02	7.72E-02	7.43E-02
Ps90%/90% (-KTL) Un-Biased	6.66E-02	6.70E-02	6.76E-02	6.84E-02	6.93E-02	6.88E-02	6.80E-02
Specification MAX	1.50E-01	1.50E-01	1.50E-01	1.50E-01	1.50E-01	1.50E-01	1.50E-01
Status	PASS	PASS	PASS	PASS	PASS	PASS	PASS

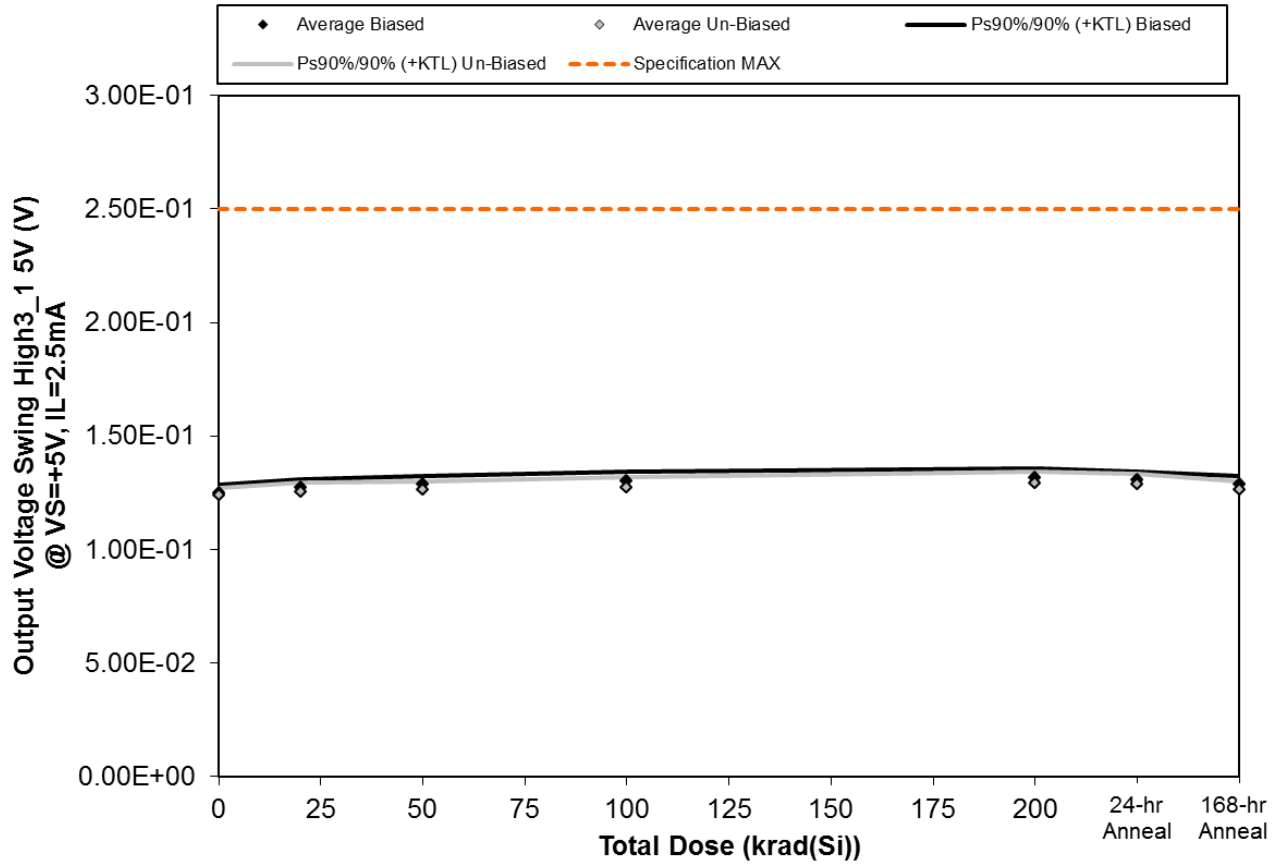

Figure 5.81. Plot of Output Voltage Swing High3_1 5V (V) @ VS=+5V, IL=2.5mA versus total dose. The solid diamonds are the average of the measured data points for the samples irradiated under electrical bias while the shaded diamonds are the average of the measured data points for the samples irradiated with all pins tied to ground. The black lines (solid and/or dashed) are the upper and/or lower confidence limits, as determined by KTL statistics, on the samples irradiated under electrical bias while the gray lines (solid and/or dashed) are the upper and/or lower confidence limits, as determined by KTL statistics, on the samples irradiated in the unbiased condition. The red dotted line(s) are the pre- and/or post-irradiation minimum and/or maximum specification value as defined in the datasheet and/or test plan.



TID Report
15-0091 03/20/15 R1.0

Aeroflex RAD
5030 Centennial Blvd.
Colorado Springs, CO 80919
(719) 531-0800

Table 5.81. Raw data for Output Voltage Swing High3_1 5V (V) @ VS=+5V, IL=2.5mA versus total dose, including the statistical analysis, specification and the status of the testing (pass/fail).

Output Voltage Swing High3_1 5V (V) @ VS=+5V, IL=2.5mA	Total Dose (krad(Si))					24-hr Anneal	168-hr Anneal
	0	20	50	100	200		
Device							
680	1.24E-01	1.27E-01	1.28E-01	1.31E-01	1.32E-01	1.30E-01	1.28E-01
681	1.26E-01	1.29E-01	1.30E-01	1.32E-01	1.33E-01	1.32E-01	1.30E-01
682	1.23E-01	1.26E-01	1.27E-01	1.28E-01	1.29E-01	1.29E-01	1.27E-01
683	1.26E-01	1.29E-01	1.30E-01	1.31E-01	1.33E-01	1.32E-01	1.30E-01
684	1.25E-01	1.27E-01	1.28E-01	1.30E-01	1.31E-01	1.30E-01	1.28E-01
685	1.24E-01	1.25E-01	1.26E-01	1.27E-01	1.29E-01	1.28E-01	1.26E-01
686	1.24E-01	1.25E-01	1.26E-01	1.27E-01	1.29E-01	1.28E-01	1.26E-01
688	1.23E-01	1.24E-01	1.25E-01	1.25E-01	1.27E-01	1.26E-01	1.25E-01
689	1.24E-01	1.25E-01	1.26E-01	1.28E-01	1.29E-01	1.29E-01	1.27E-01
690	1.26E-01	1.28E-01	1.28E-01	1.30E-01	1.32E-01	1.31E-01	1.28E-01
691	1.20E-01	1.20E-01	1.20E-01	1.20E-01	1.20E-01	1.20E-01	1.20E-01
692	1.26E-01	1.26E-01	1.26E-01	1.26E-01	1.26E-01	1.25E-01	1.26E-01
Biased Statistics							
Average Biased	1.25E-01	1.27E-01	1.29E-01	1.30E-01	1.32E-01	1.31E-01	1.29E-01
Std Dev Biased	1.32E-03	1.39E-03	1.34E-03	1.44E-03	1.45E-03	1.42E-03	1.42E-03
Ps90%/90% (+KTL) Biased	1.29E-01	1.31E-01	1.32E-01	1.34E-01	1.36E-01	1.35E-01	1.33E-01
Ps90%/90% (-KTL) Biased	1.21E-01	1.24E-01	1.25E-01	1.26E-01	1.28E-01	1.27E-01	1.25E-01
Un-Biased Statistics							
Average Un-Biased	1.24E-01	1.25E-01	1.26E-01	1.27E-01	1.29E-01	1.29E-01	1.26E-01
Std Dev Un-Biased	1.11E-03	1.57E-03	1.36E-03	1.57E-03	1.82E-03	1.69E-03	1.33E-03
Ps90%/90% (+KTL) Un-Biased	1.27E-01	1.30E-01	1.30E-01	1.32E-01	1.34E-01	1.33E-01	1.30E-01
Ps90%/90% (-KTL) Un-Biased	1.21E-01	1.21E-01	1.22E-01	1.23E-01	1.24E-01	1.24E-01	1.23E-01
Specification MAX	2.50E-01	2.50E-01	2.50E-01	2.50E-01	2.50E-01	2.50E-01	2.50E-01
Status	PASS	PASS	PASS	PASS	PASS	PASS	PASS

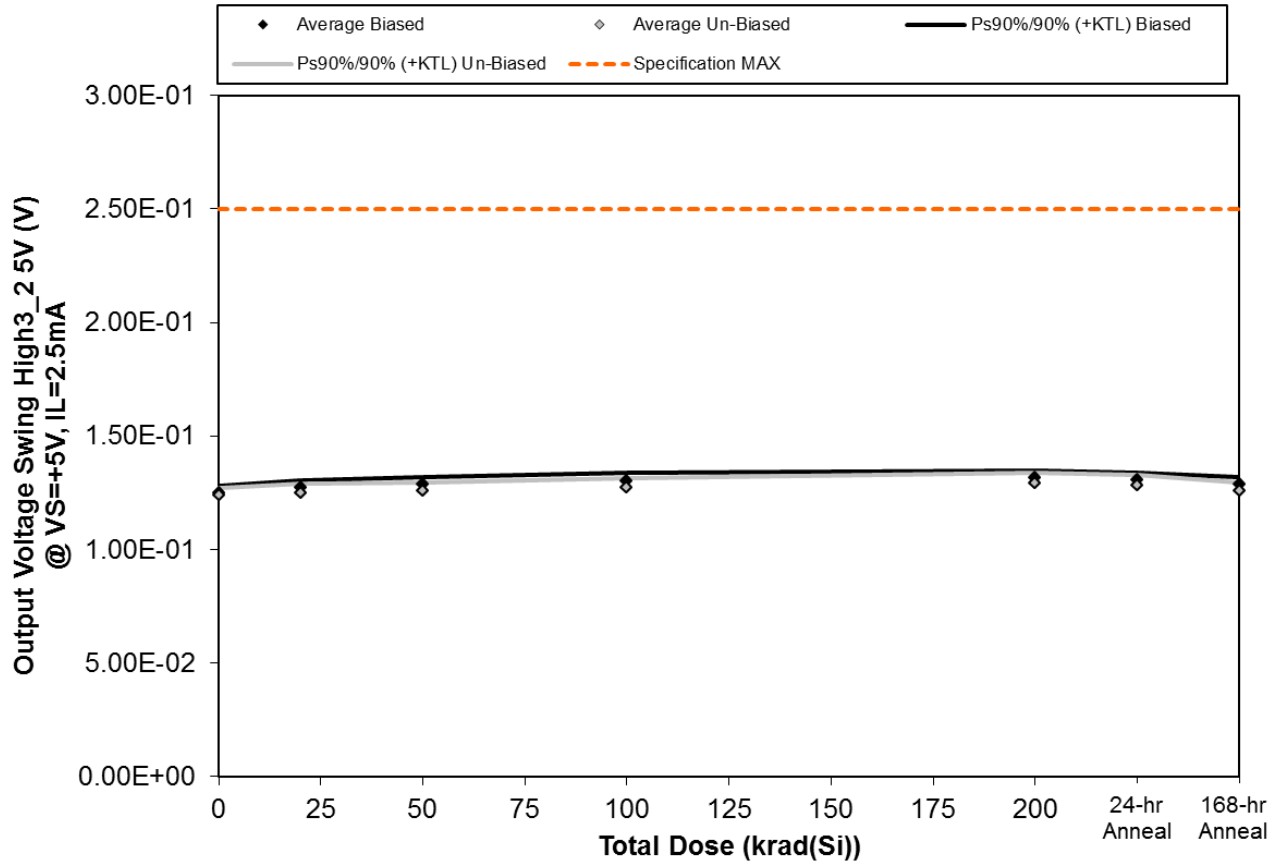

Figure 5.82. Plot of Output Voltage Swing High3_2 5V (V) @ VS=+5V, IL=2.5mA versus total dose. The solid diamonds are the average of the measured data points for the samples irradiated under electrical bias while the shaded diamonds are the average of the measured data points for the samples irradiated with all pins tied to ground. The black lines (solid and/or dashed) are the upper and/or lower confidence limits, as determined by KTL statistics, on the samples irradiated under electrical bias while the gray lines (solid and/or dashed) are the upper and/or lower confidence limits, as determined by KTL statistics, on the samples irradiated in the unbiased condition. The red dotted line(s) are the pre- and/or post-irradiation minimum and/or maximum specification value as defined in the datasheet and/or test plan.



TID Report
15-0091 03/20/15 R1.0

Aeroflex RAD
5030 Centennial Blvd.
Colorado Springs, CO 80919
(719) 531-0800

Table 5.82. Raw data for Output Voltage Swing High3_2 5V (V) @ VS=+5V, IL=2.5mA versus total dose, including the statistical analysis, specification and the status of the testing (pass/fail).

Output Voltage Swing High3_2 5V (V) @ VS=+5V, IL=2.5mA	Total Dose (krad(Si))					24-hr Anneal	168-hr Anneal
	0	20	50	100	200		
Device							
680	1.25E-01	1.27E-01	1.28E-01	1.31E-01	1.32E-01	1.31E-01	1.28E-01
681	1.26E-01	1.29E-01	1.30E-01	1.31E-01	1.32E-01	1.32E-01	1.30E-01
682	1.23E-01	1.26E-01	1.27E-01	1.28E-01	1.29E-01	1.29E-01	1.27E-01
683	1.26E-01	1.28E-01	1.30E-01	1.31E-01	1.32E-01	1.31E-01	1.30E-01
684	1.25E-01	1.28E-01	1.29E-01	1.30E-01	1.32E-01	1.31E-01	1.29E-01
685	1.23E-01	1.25E-01	1.26E-01	1.27E-01	1.29E-01	1.28E-01	1.26E-01
686	1.24E-01	1.25E-01	1.26E-01	1.27E-01	1.29E-01	1.29E-01	1.26E-01
688	1.23E-01	1.24E-01	1.25E-01	1.26E-01	1.27E-01	1.27E-01	1.25E-01
689	1.24E-01	1.25E-01	1.26E-01	1.27E-01	1.29E-01	1.29E-01	1.26E-01
690	1.26E-01	1.27E-01	1.28E-01	1.30E-01	1.32E-01	1.31E-01	1.28E-01
691	1.21E-01	1.21E-01	1.20E-01	1.21E-01	1.20E-01	1.20E-01	1.21E-01
692	1.25E-01	1.25E-01	1.25E-01	1.25E-01	1.25E-01	1.25E-01	1.25E-01
Biased Statistics							
Average Biased	1.25E-01	1.27E-01	1.29E-01	1.30E-01	1.32E-01	1.31E-01	1.29E-01
Std Dev Biased	1.07E-03	1.15E-03	1.21E-03	1.20E-03	1.21E-03	1.10E-03	1.21E-03
Ps90%/90% (+KTL) Biased	1.28E-01	1.31E-01	1.32E-01	1.34E-01	1.35E-01	1.34E-01	1.32E-01
Ps90%/90% (-KTL) Biased	1.22E-01	1.24E-01	1.25E-01	1.27E-01	1.28E-01	1.28E-01	1.25E-01
Un-Biased Statistics							
Average Un-Biased	1.24E-01	1.25E-01	1.26E-01	1.27E-01	1.29E-01	1.29E-01	1.26E-01
Std Dev Un-Biased	1.09E-03	1.36E-03	1.25E-03	1.55E-03	1.65E-03	1.51E-03	1.18E-03
Ps90%/90% (+KTL) Un-Biased	1.27E-01	1.29E-01	1.29E-01	1.32E-01	1.34E-01	1.33E-01	1.29E-01
Ps90%/90% (-KTL) Un-Biased	1.21E-01	1.21E-01	1.23E-01	1.23E-01	1.25E-01	1.24E-01	1.23E-01
Specification MAX	2.50E-01	2.50E-01	2.50E-01	2.50E-01	2.50E-01	2.50E-01	2.50E-01
Status	PASS	PASS	PASS	PASS	PASS	PASS	PASS

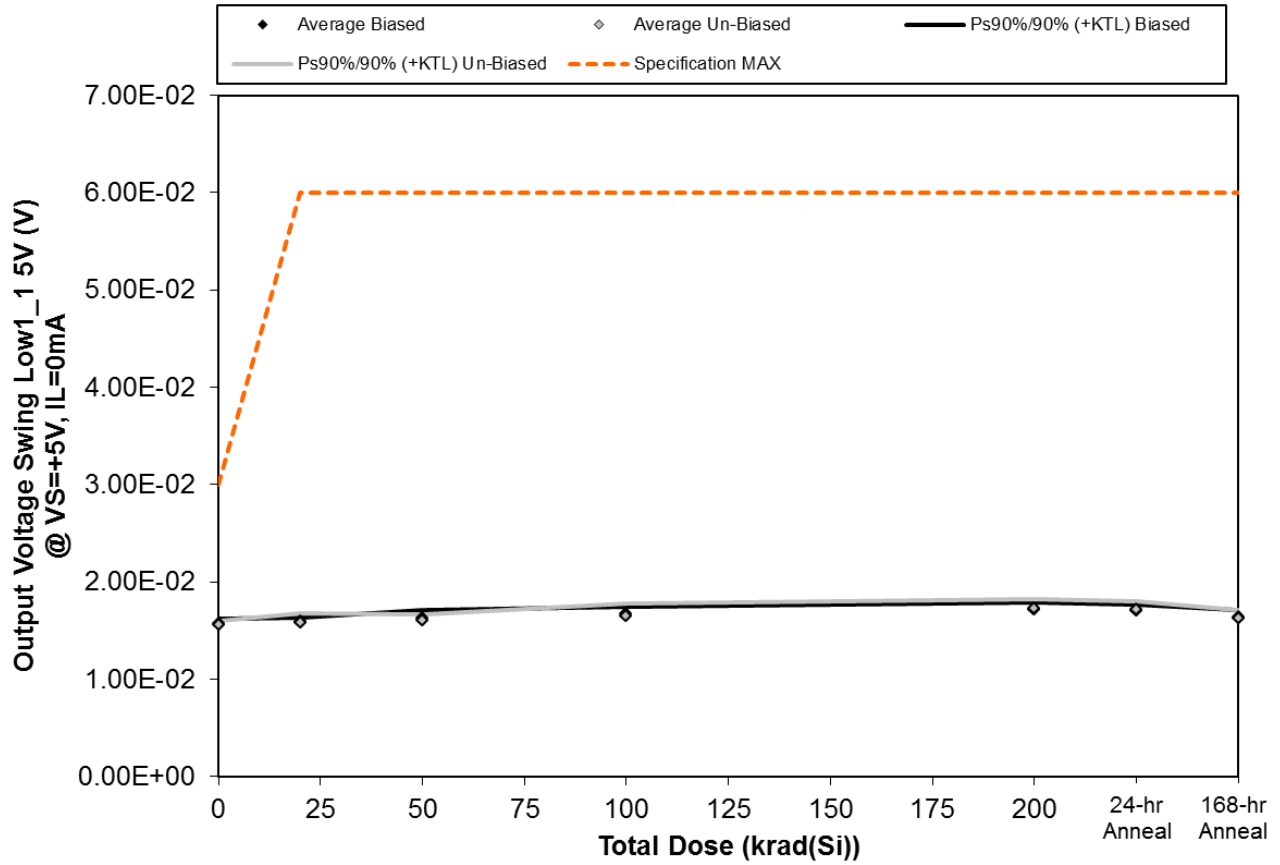

Figure 5.83. Plot of Output Voltage Swing Low1_1 5V (V) @ VS=+5V, IL=0mA versus total dose. The solid diamonds are the average of the measured data points for the samples irradiated under electrical bias while the shaded diamonds are the average of the measured data points for the samples irradiated with all pins tied to ground. The black lines (solid and/or dashed) are the upper and/or lower confidence limits, as determined by KTL statistics, on the samples irradiated under electrical bias while the gray lines (solid and/or dashed) are the upper and/or lower confidence limits, as determined by KTL statistics, on the samples irradiated in the unbiased condition. The red dotted line(s) are the pre- and/or post-irradiation minimum and/or maximum specification value as defined in the datasheet and/or test plan.



TID Report
15-0091 03/20/15 R1.0

Aeroflex RAD
5030 Centennial Blvd.
Colorado Springs, CO 80919
(719) 531-0800

Table 5.83. Raw data for Output Voltage Swing Low1_1 5V (V) @ VS=+5V, IL=0mA versus total dose, including the statistical analysis, specification and the status of the testing (pass/fail).

Output Voltage Swing Low1_1 5V (V) @ VS=+5V, IL=0mA	Total Dose (krad(Si))					24-hr Anneal	168-hr Anneal
	0	20	50	100	200		
Device							
680	1.57E-02	1.60E-02	1.65E-02	1.70E-02	1.75E-02	1.70E-02	1.62E-02
681	1.58E-02	1.61E-02	1.65E-02	1.67E-02	1.73E-02	1.72E-02	1.68E-02
682	1.53E-02	1.58E-02	1.58E-02	1.62E-02	1.67E-02	1.67E-02	1.60E-02
683	1.57E-02	1.59E-02	1.64E-02	1.67E-02	1.72E-02	1.73E-02	1.64E-02
684	1.58E-02	1.60E-02	1.62E-02	1.67E-02	1.72E-02	1.70E-02	1.64E-02
685	1.56E-02	1.60E-02	1.62E-02	1.68E-02	1.75E-02	1.74E-02	1.64E-02
686	1.56E-02	1.58E-02	1.62E-02	1.67E-02	1.76E-02	1.73E-02	1.63E-02
688	1.53E-02	1.53E-02	1.57E-02	1.58E-02	1.68E-02	1.66E-02	1.57E-02
689	1.57E-02	1.62E-02	1.63E-02	1.68E-02	1.73E-02	1.72E-02	1.66E-02
690	1.57E-02	1.58E-02	1.61E-02	1.67E-02	1.76E-02	1.73E-02	1.64E-02
691	1.56E-02	1.55E-02	1.54E-02	1.56E-02	1.57E-02	1.56E-02	1.56E-02
692	1.59E-02	1.59E-02	1.58E-02	1.58E-02	1.57E-02	1.57E-02	1.57E-02
Biased Statistics							
Average Biased	1.57E-02	1.60E-02	1.63E-02	1.67E-02	1.72E-02	1.70E-02	1.64E-02
Std Dev Biased	1.97E-04	1.22E-04	2.90E-04	2.86E-04	2.75E-04	2.35E-04	2.86E-04
Ps90%/90% (+KTL) Biased	1.62E-02	1.63E-02	1.71E-02	1.75E-02	1.79E-02	1.77E-02	1.71E-02
Ps90%/90% (-KTL) Biased	1.51E-02	1.56E-02	1.55E-02	1.59E-02	1.64E-02	1.64E-02	1.56E-02
Un-Biased Statistics							
Average Un-Biased	1.56E-02	1.58E-02	1.61E-02	1.65E-02	1.73E-02	1.71E-02	1.63E-02
Std Dev Un-Biased	1.55E-04	3.34E-04	2.15E-04	4.45E-04	3.32E-04	3.24E-04	3.26E-04
Ps90%/90% (+KTL) Un-Biased	1.60E-02	1.67E-02	1.67E-02	1.78E-02	1.82E-02	1.80E-02	1.72E-02
Ps90%/90% (-KTL) Un-Biased	1.51E-02	1.49E-02	1.55E-02	1.53E-02	1.64E-02	1.62E-02	1.54E-02
Specification MAX	3.00E-02	6.00E-02	6.00E-02	6.00E-02	6.00E-02	6.00E-02	6.00E-02
Status	PASS	PASS	PASS	PASS	PASS	PASS	PASS

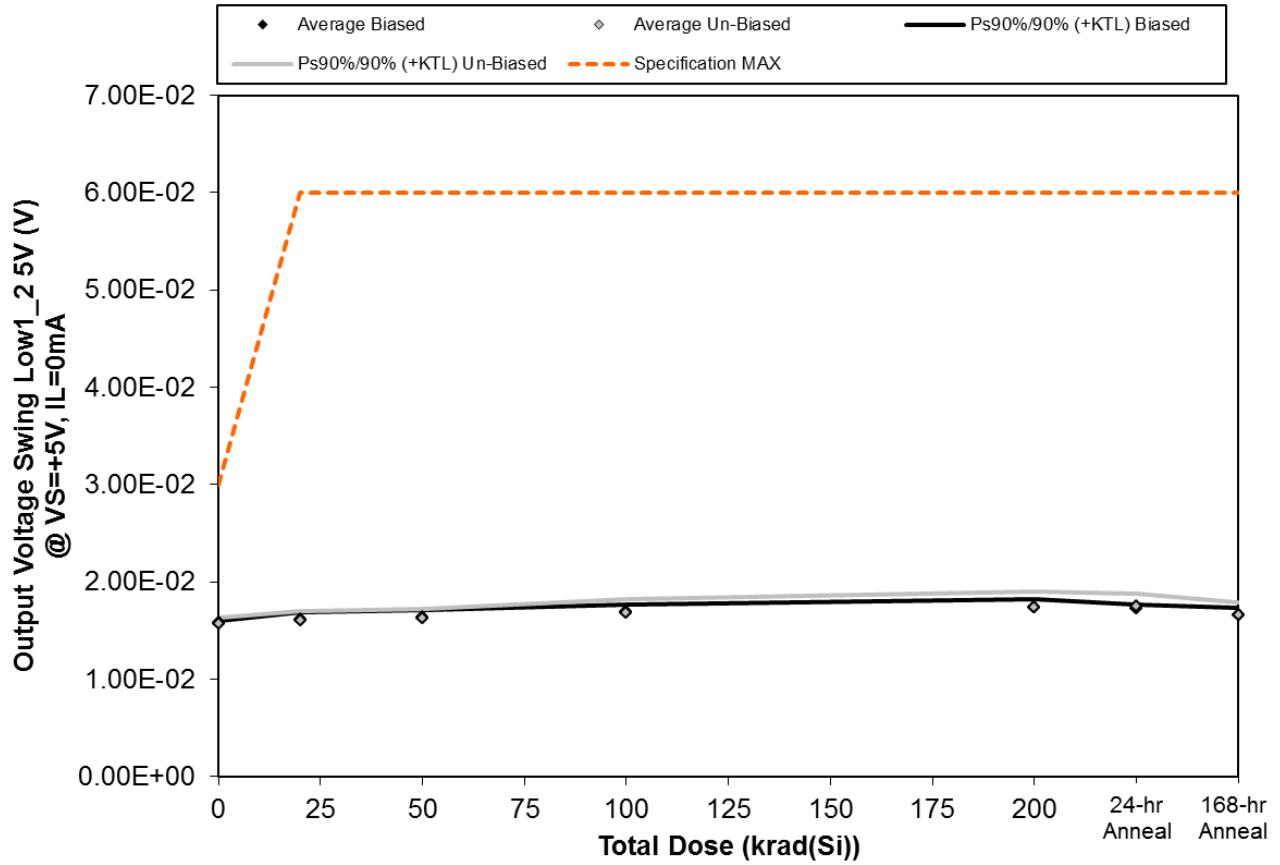

Figure 5.84. Plot of Output Voltage Swing Low1_2 5V (V) @ VS=+5V, IL=0mA versus total dose. The solid diamonds are the average of the measured data points for the samples irradiated under electrical bias while the shaded diamonds are the average of the measured data points for the samples irradiated with all pins tied to ground. The black lines (solid and/or dashed) are the upper and/or lower confidence limits, as determined by KTL statistics, on the samples irradiated under electrical bias while the gray lines (solid and/or dashed) are the upper and/or lower confidence limits, as determined by KTL statistics, on the samples irradiated in the unbiased condition. The red dotted line(s) are the pre- and/or post-irradiation minimum and/or maximum specification value as defined in the datasheet and/or test plan.



TID Report
15-0091 03/20/15 R1.0

Aeroflex RAD
5030 Centennial Blvd.
Colorado Springs, CO 80919
(719) 531-0800

Table 5.84. Raw data for Output Voltage Swing Low1_2 5V (V) @ VS=+5V, IL=0mA versus total dose, including the statistical analysis, specification and the status of the testing (pass/fail).

Output Voltage Swing Low1_2 5V (V) @ VS=+5V, IL=0mA	Total Dose (krad(Si))					24-hr Anneal	168-hr Anneal
	0	20	50	100	200		
Device							
680	1.58E-02	1.62E-02	1.67E-02	1.72E-02	1.79E-02	1.73E-02	1.65E-02
681	1.59E-02	1.63E-02	1.65E-02	1.71E-02	1.75E-02	1.74E-02	1.69E-02
682	1.57E-02	1.59E-02	1.61E-02	1.65E-02	1.70E-02	1.70E-02	1.64E-02
683	1.57E-02	1.60E-02	1.63E-02	1.67E-02	1.73E-02	1.71E-02	1.63E-02
684	1.59E-02	1.65E-02	1.66E-02	1.70E-02	1.73E-02	1.74E-02	1.69E-02
685	1.60E-02	1.62E-02	1.67E-02	1.69E-02	1.75E-02	1.76E-02	1.70E-02
686	1.57E-02	1.61E-02	1.65E-02	1.71E-02	1.79E-02	1.78E-02	1.66E-02
688	1.55E-02	1.55E-02	1.58E-02	1.59E-02	1.65E-02	1.66E-02	1.58E-02
689	1.58E-02	1.63E-02	1.63E-02	1.69E-02	1.76E-02	1.76E-02	1.67E-02
690	1.58E-02	1.64E-02	1.64E-02	1.72E-02	1.77E-02	1.77E-02	1.70E-02
691	1.58E-02	1.56E-02	1.59E-02	1.59E-02	1.57E-02	1.58E-02	1.59E-02
692	1.59E-02	1.59E-02	1.61E-02	1.60E-02	1.60E-02	1.60E-02	1.60E-02
Biased Statistics							
Average Biased	1.58E-02	1.62E-02	1.64E-02	1.69E-02	1.74E-02	1.72E-02	1.66E-02
Std Dev Biased	9.15E-05	2.40E-04	2.53E-04	2.86E-04	3.06E-04	1.81E-04	2.70E-04
Ps90%/90% (+KTL) Biased	1.61E-02	1.68E-02	1.71E-02	1.77E-02	1.82E-02	1.77E-02	1.73E-02
Ps90%/90% (-KTL) Biased	1.56E-02	1.55E-02	1.58E-02	1.61E-02	1.66E-02	1.67E-02	1.58E-02
Un-Biased Statistics							
Average Un-Biased	1.58E-02	1.61E-02	1.63E-02	1.68E-02	1.74E-02	1.75E-02	1.66E-02
Std Dev Un-Biased	1.90E-04	3.40E-04	3.38E-04	5.26E-04	5.64E-04	4.76E-04	4.79E-04
Ps90%/90% (+KTL) Un-Biased	1.63E-02	1.70E-02	1.72E-02	1.83E-02	1.90E-02	1.88E-02	1.79E-02
Ps90%/90% (-KTL) Un-Biased	1.52E-02	1.52E-02	1.54E-02	1.54E-02	1.59E-02	1.62E-02	1.53E-02
Specification MAX	3.00E-02	6.00E-02	6.00E-02	6.00E-02	6.00E-02	6.00E-02	6.00E-02
Status	PASS	PASS	PASS	PASS	PASS	PASS	PASS

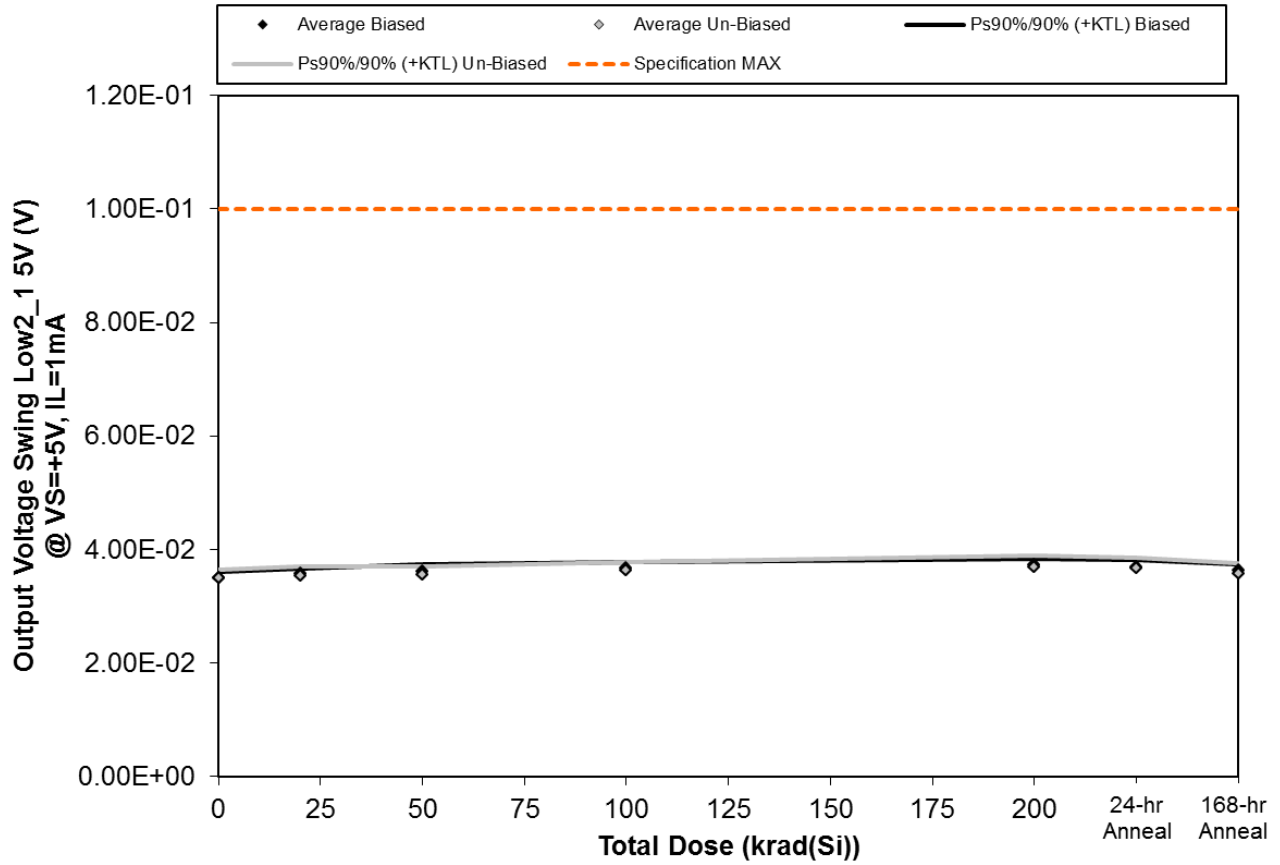

Figure 5.85. Plot of Output Voltage Swing Low2_1 5V (V) @ VS=+5V, IL=1mA versus total dose. The solid diamonds are the average of the measured data points for the samples irradiated under electrical bias while the shaded diamonds are the average of the measured data points for the samples irradiated with all pins tied to ground. The black lines (solid and/or dashed) are the upper and/or lower confidence limits, as determined by KTL statistics, on the samples irradiated under electrical bias while the gray lines (solid and/or dashed) are the upper and/or lower confidence limits, as determined by KTL statistics, on the samples irradiated in the unbiased condition. The red dotted line(s) are the pre- and/or post-irradiation minimum and/or maximum specification value as defined in the datasheet and/or test plan.



TID Report
15-0091 03/20/15 R1.0

Aeroflex RAD
5030 Centennial Blvd.
Colorado Springs, CO 80919
(719) 531-0800

Table 5.85. Raw data for Output Voltage Swing Low2_1 5V (V) @ VS=+5V, IL=1mA versus total dose, including the statistical analysis, specification and the status of the testing (pass/fail).

Output Voltage Swing Low2_1 5V (V) @ VS=+5V, IL=1mA	Total Dose (krad(Si))					24-hr Anneal	168-hr Anneal
	0	20	50	100	200		
Device							
680	3.48E-02	3.57E-02	3.59E-02	3.68E-02	3.74E-02	3.71E-02	3.63E-02
681	3.53E-02	3.60E-02	3.66E-02	3.70E-02	3.77E-02	3.73E-02	3.67E-02
682	3.45E-02	3.52E-02	3.54E-02	3.59E-02	3.66E-02	3.63E-02	3.57E-02
683	3.53E-02	3.60E-02	3.64E-02	3.68E-02	3.74E-02	3.72E-02	3.64E-02
684	3.51E-02	3.57E-02	3.61E-02	3.68E-02	3.71E-02	3.71E-02	3.64E-02
685	3.53E-02	3.59E-02	3.59E-02	3.65E-02	3.74E-02	3.69E-02	3.62E-02
686	3.51E-02	3.57E-02	3.59E-02	3.65E-02	3.74E-02	3.71E-02	3.60E-02
688	3.40E-02	3.44E-02	3.47E-02	3.52E-02	3.58E-02	3.54E-02	3.45E-02
689	3.53E-02	3.56E-02	3.58E-02	3.66E-02	3.70E-02	3.70E-02	3.62E-02
690	3.51E-02	3.55E-02	3.58E-02	3.65E-02	3.73E-02	3.70E-02	3.58E-02
691	3.47E-02	3.48E-02	3.45E-02	3.48E-02	3.47E-02	3.47E-02	3.46E-02
692	3.57E-02	3.54E-02	3.56E-02	3.55E-02	3.53E-02	3.56E-02	3.54E-02
Biased Statistics							
Average Biased	3.50E-02	3.57E-02	3.61E-02	3.67E-02	3.72E-02	3.70E-02	3.63E-02
Std Dev Biased	3.61E-04	3.29E-04	4.68E-04	4.12E-04	4.15E-04	3.98E-04	3.84E-04
Ps90%/90% (+KTL) Biased	3.60E-02	3.66E-02	3.74E-02	3.78E-02	3.84E-02	3.81E-02	3.74E-02
Ps90%/90% (-KTL) Biased	3.40E-02	3.48E-02	3.48E-02	3.55E-02	3.61E-02	3.59E-02	3.53E-02
Un-Biased Statistics							
Average Un-Biased	3.49E-02	3.54E-02	3.56E-02	3.63E-02	3.70E-02	3.67E-02	3.57E-02
Std Dev Un-Biased	5.49E-04	5.66E-04	5.35E-04	5.84E-04	6.82E-04	7.12E-04	7.20E-04
Ps90%/90% (+KTL) Un-Biased	3.65E-02	3.70E-02	3.71E-02	3.79E-02	3.89E-02	3.86E-02	3.77E-02
Ps90%/90% (-KTL) Un-Biased	3.34E-02	3.39E-02	3.42E-02	3.47E-02	3.51E-02	3.47E-02	3.37E-02
Specification MAX	1.00E-01	1.00E-01	1.00E-01	1.00E-01	1.00E-01	1.00E-01	1.00E-01
Status	PASS	PASS	PASS	PASS	PASS	PASS	PASS

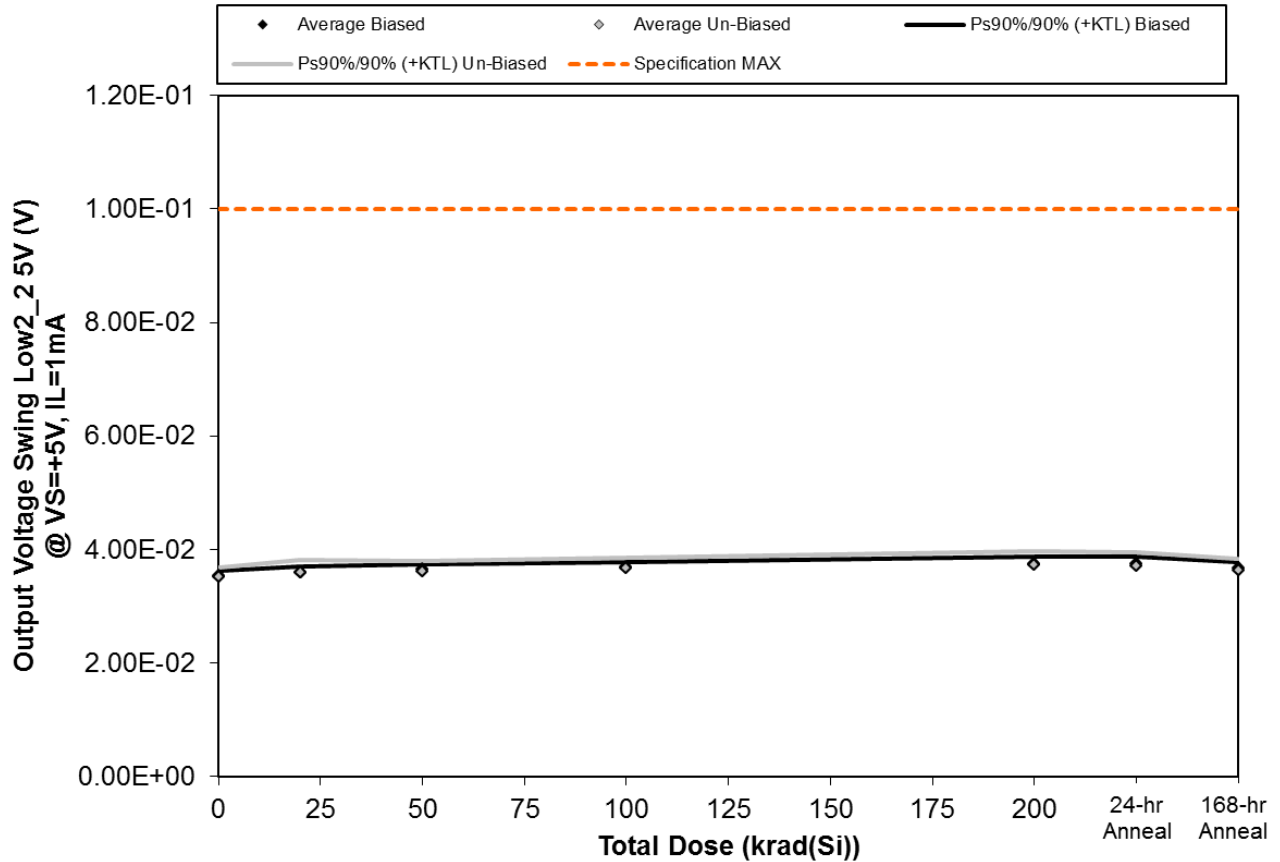

Figure 5.86. Plot of Output Voltage Swing Low2_2 5V (V) @ VS=+5V, IL=1mA versus total dose. The solid diamonds are the average of the measured data points for the samples irradiated under electrical bias while the shaded diamonds are the average of the measured data points for the samples irradiated with all pins tied to ground. The black lines (solid and/or dashed) are the upper and/or lower confidence limits, as determined by KTL statistics, on the samples irradiated under electrical bias while the gray lines (solid and/or dashed) are the upper and/or lower confidence limits, as determined by KTL statistics, on the samples irradiated in the unbiased condition. The red dotted line(s) are the pre- and/or post-irradiation minimum and/or maximum specification value as defined in the datasheet and/or test plan.



TID Report
15-0091 03/20/15 R1.0

Aeroflex RAD
5030 Centennial Blvd.
Colorado Springs, CO 80919
(719) 531-0800

Table 5.86. Raw data for Output Voltage Swing Low2_2 5V (V) @ VS=+5V, IL=1mA versus total dose, including the statistical analysis, specification and the status of the testing (pass/fail).

Output Voltage Swing Low2_2 5V (V) @ VS=+5V, IL=1mA	Total Dose (krad(Si))					24-hr Anneal	168-hr Anneal
	0	20	50	100	200		
Device							
680	3.54E-02	3.61E-02	3.67E-02	3.73E-02	3.81E-02	3.77E-02	3.68E-02
681	3.57E-02	3.65E-02	3.68E-02	3.71E-02	3.78E-02	3.81E-02	3.72E-02
682	3.51E-02	3.55E-02	3.60E-02	3.65E-02	3.69E-02	3.71E-02	3.62E-02
683	3.56E-02	3.60E-02	3.63E-02	3.68E-02	3.74E-02	3.73E-02	3.66E-02
684	3.55E-02	3.61E-02	3.67E-02	3.69E-02	3.73E-02	3.79E-02	3.70E-02
685	3.57E-02	3.63E-02	3.67E-02	3.69E-02	3.78E-02	3.75E-02	3.67E-02
686	3.56E-02	3.64E-02	3.63E-02	3.70E-02	3.80E-02	3.78E-02	3.67E-02
688	3.43E-02	3.44E-02	3.49E-02	3.54E-02	3.59E-02	3.57E-02	3.51E-02
689	3.54E-02	3.61E-02	3.63E-02	3.68E-02	3.74E-02	3.73E-02	3.66E-02
690	3.53E-02	3.63E-02	3.63E-02	3.71E-02	3.78E-02	3.76E-02	3.68E-02
691	3.52E-02	3.54E-02	3.55E-02	3.54E-02	3.52E-02	3.52E-02	3.53E-02
692	3.60E-02	3.57E-02	3.58E-02	3.57E-02	3.60E-02	3.60E-02	3.57E-02
Biased Statistics							
Average Biased	3.55E-02	3.60E-02	3.65E-02	3.69E-02	3.75E-02	3.76E-02	3.67E-02
Std Dev Biased	2.62E-04	3.78E-04	3.31E-04	2.88E-04	4.49E-04	3.99E-04	3.72E-04
Ps90%/90% (+KTL) Biased	3.62E-02	3.71E-02	3.74E-02	3.77E-02	3.87E-02	3.87E-02	3.78E-02
Ps90%/90% (-KTL) Biased	3.47E-02	3.50E-02	3.56E-02	3.61E-02	3.63E-02	3.65E-02	3.57E-02
Un-Biased Statistics							
Average Un-Biased	3.53E-02	3.59E-02	3.61E-02	3.67E-02	3.74E-02	3.72E-02	3.64E-02
Std Dev Un-Biased	5.47E-04	8.34E-04	6.98E-04	6.98E-04	8.51E-04	8.44E-04	7.35E-04
Ps90%/90% (+KTL) Un-Biased	3.68E-02	3.82E-02	3.80E-02	3.86E-02	3.97E-02	3.95E-02	3.84E-02
Ps90%/90% (-KTL) Un-Biased	3.38E-02	3.36E-02	3.42E-02	3.47E-02	3.50E-02	3.49E-02	3.43E-02
Specification MAX	1.00E-01	1.00E-01	1.00E-01	1.00E-01	1.00E-01	1.00E-01	1.00E-01
Status	PASS	PASS	PASS	PASS	PASS	PASS	PASS

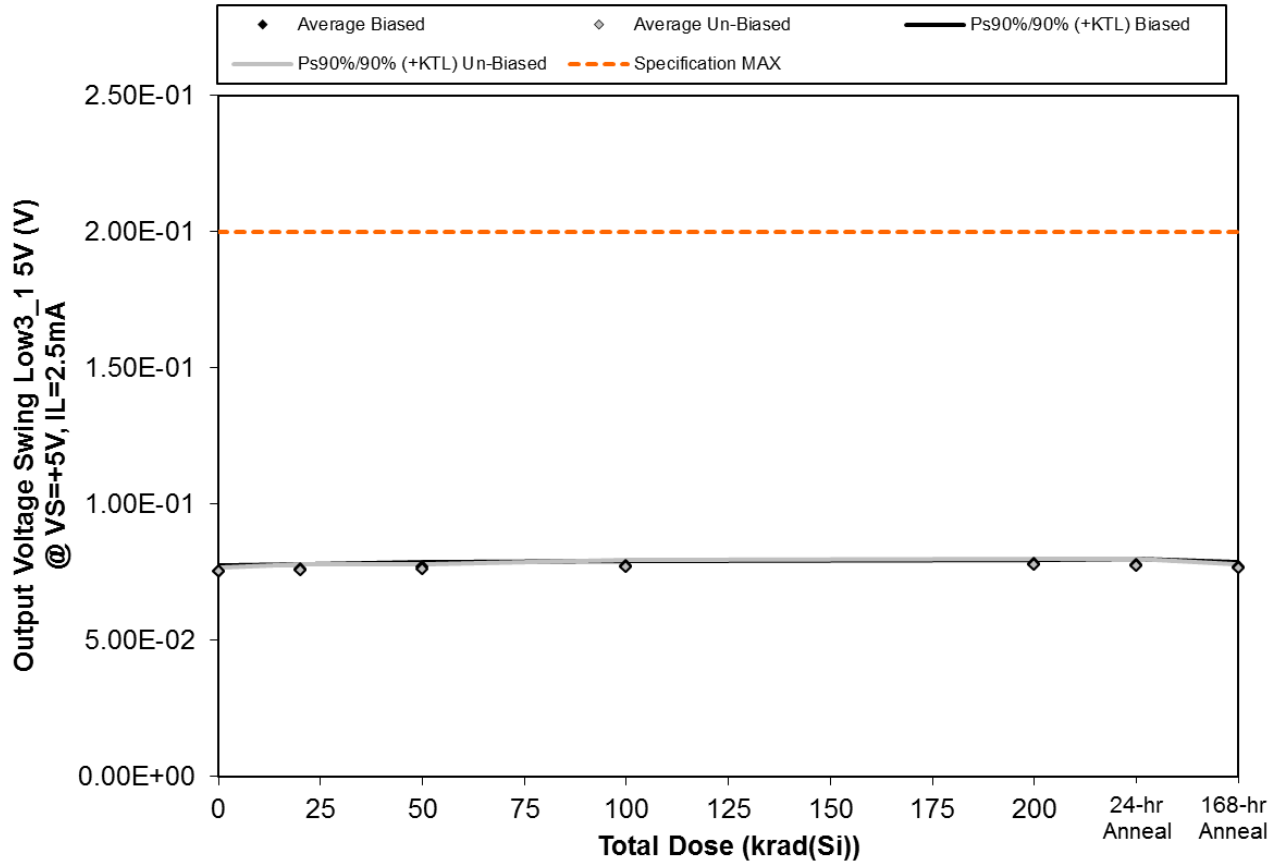

Figure 5.87. Plot of Output Voltage Swing Low3_1 5V (V) @ VS=+5V, IL=2.5mA versus total dose. The solid diamonds are the average of the measured data points for the samples irradiated under electrical bias while the shaded diamonds are the average of the measured data points for the samples irradiated with all pins tied to ground. The black lines (solid and/or dashed) are the upper and/or lower confidence limits, as determined by KTL statistics, on the samples irradiated under electrical bias while the gray lines (solid and/or dashed) are the upper and/or lower confidence limits, as determined by KTL statistics, on the samples irradiated in the unbiased condition. The red dotted line(s) are the pre- and/or post-irradiation minimum and/or maximum specification value as defined in the datasheet and/or test plan.



**TID Report
15-0091 03/20/15 R1.0**

**Aeroflex RAD
5030 Centennial Blvd.
Colorado Springs, CO 80919
(719) 531-0800**

Table 5.87. Raw data for Output Voltage Swing Low3_1 5V (V) @ VS=+5V, IL=2.5mA versus total dose, including the statistical analysis, specification and the status of the testing (pass/fail).

Output Voltage Swing Low3_1 5V (V) @ VS=+5V, IL=2.5mA	Total Dose (krad(Si))					24-hr Anneal	168-hr Anneal
	0	20	50	100	200		
Device							
680	7.46E-02	7.58E-02	7.64E-02	7.78E-02	7.82E-02	7.77E-02	7.67E-02
681	7.60E-02	7.67E-02	7.74E-02	7.80E-02	7.84E-02	7.88E-02	7.77E-02
682	7.41E-02	7.57E-02	7.57E-02	7.65E-02	7.74E-02	7.67E-02	7.59E-02
683	7.57E-02	7.66E-02	7.74E-02	7.77E-02	7.86E-02	7.80E-02	7.75E-02
684	7.55E-02	7.67E-02	7.68E-02	7.76E-02	7.83E-02	7.82E-02	7.73E-02
685	7.54E-02	7.61E-02	7.64E-02	7.71E-02	7.80E-02	7.77E-02	7.68E-02
686	7.54E-02	7.58E-02	7.62E-02	7.72E-02	7.80E-02	7.78E-02	7.62E-02
688	7.44E-02	7.46E-02	7.51E-02	7.53E-02	7.60E-02	7.59E-02	7.53E-02
689	7.58E-02	7.61E-02	7.66E-02	7.75E-02	7.80E-02	7.79E-02	7.69E-02
690	7.56E-02	7.64E-02	7.63E-02	7.74E-02	7.79E-02	7.79E-02	7.65E-02
691	7.43E-02	7.45E-02	7.45E-02	7.43E-02	7.46E-02	7.44E-02	7.44E-02
692	7.61E-02	7.62E-02	7.63E-02	7.63E-02	7.62E-02	7.61E-02	7.64E-02
Biased Statistics							
Average Biased	7.52E-02	7.63E-02	7.67E-02	7.75E-02	7.82E-02	7.78E-02	7.70E-02
Std Dev Biased	8.03E-04	5.19E-04	6.97E-04	5.91E-04	4.87E-04	7.66E-04	7.04E-04
Ps90%/90% (+KTL) Biased	7.74E-02	7.77E-02	7.87E-02	7.91E-02	7.95E-02	7.99E-02	7.89E-02
Ps90%/90% (-KTL) Biased	7.30E-02	7.49E-02	7.48E-02	7.59E-02	7.68E-02	7.57E-02	7.51E-02
Un-Biased Statistics							
Average Un-Biased	7.53E-02	7.58E-02	7.61E-02	7.69E-02	7.76E-02	7.74E-02	7.64E-02
Std Dev Un-Biased	5.38E-04	7.27E-04	6.06E-04	8.96E-04	8.67E-04	8.72E-04	6.27E-04
Ps90%/90% (+KTL) Un-Biased	7.68E-02	7.78E-02	7.78E-02	7.94E-02	8.00E-02	7.98E-02	7.81E-02
Ps90%/90% (-KTL) Un-Biased	7.38E-02	7.38E-02	7.44E-02	7.44E-02	7.52E-02	7.51E-02	7.46E-02
Specification MAX	2.00E-01	2.00E-01	2.00E-01	2.00E-01	2.00E-01	2.00E-01	2.00E-01
Status	PASS	PASS	PASS	PASS	PASS	PASS	PASS

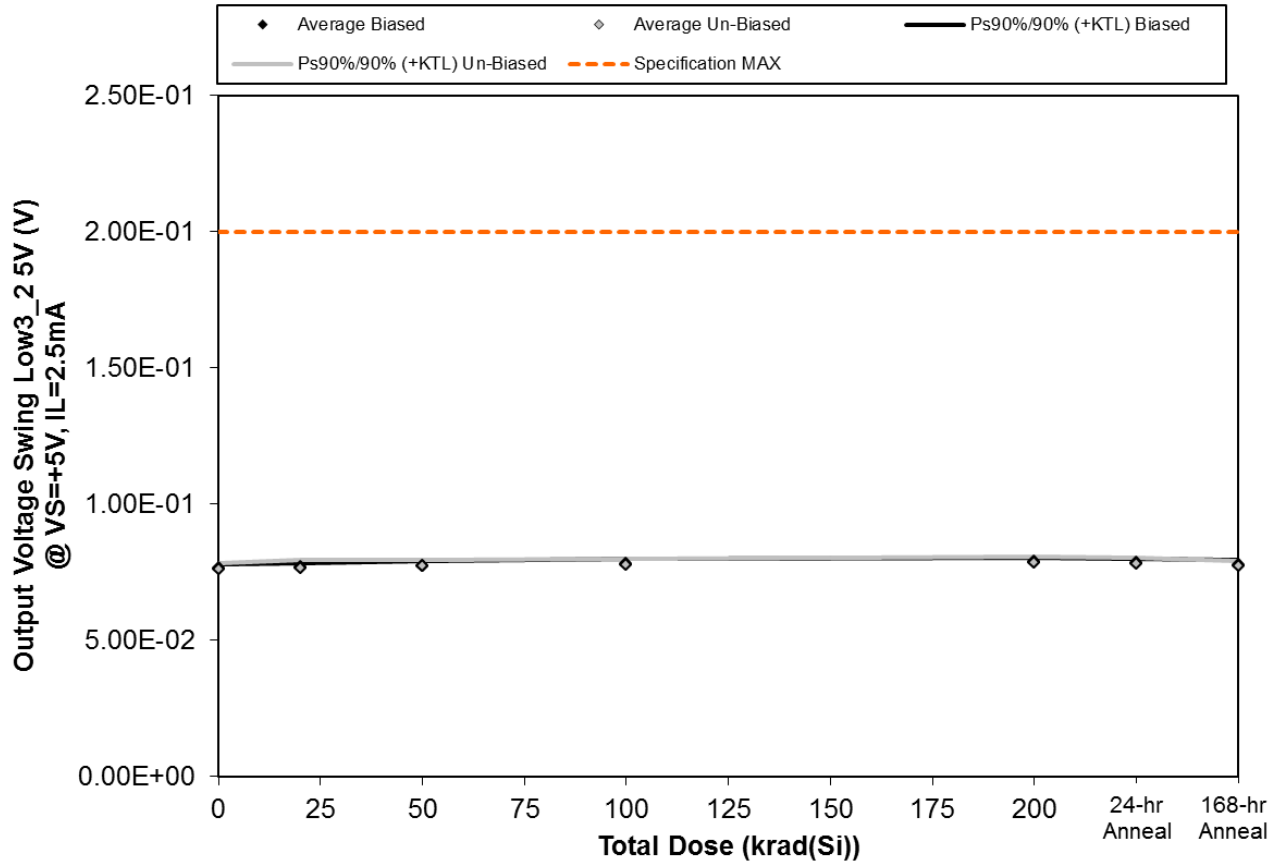

Figure 5.88. Plot of Output Voltage Swing Low3_2 5V (V) @ VS=+5V, IL=2.5mA versus total dose. The solid diamonds are the average of the measured data points for the samples irradiated under electrical bias while the shaded diamonds are the average of the measured data points for the samples irradiated with all pins tied to ground. The black lines (solid and/or dashed) are the upper and/or lower confidence limits, as determined by KTL statistics, on the samples irradiated under electrical bias while the gray lines (solid and/or dashed) are the upper and/or lower confidence limits, as determined by KTL statistics, on the samples irradiated in the unbiased condition. The red dotted line(s) are the pre- and/or post-irradiation minimum and/or maximum specification value as defined in the datasheet and/or test plan.



TID Report
15-0091 03/20/15 R1.0

Aeroflex RAD
5030 Centennial Blvd.
Colorado Springs, CO 80919
(719) 531-0800

Table 5.88. Raw data for Output Voltage Swing Low3_2 5V (V) @ VS=+5V, IL=2.5mA versus total dose, including the statistical analysis, specification and the status of the testing (pass/fail).

Output Voltage Swing Low3_2 5V (V) @ VS=+5V, IL=2.5mA	Total Dose (krad(Si))					24-hr Anneal	168-hr Anneal
	0	20	50	100	200		
Device							
680	7.62E-02	7.71E-02	7.76E-02	7.87E-02	7.90E-02	7.89E-02	7.76E-02
681	7.70E-02	7.76E-02	7.82E-02	7.86E-02	7.95E-02	7.90E-02	7.83E-02
682	7.54E-02	7.63E-02	7.65E-02	7.71E-02	7.82E-02	7.78E-02	7.68E-02
683	7.66E-02	7.72E-02	7.76E-02	7.81E-02	7.92E-02	7.86E-02	7.79E-02
684	7.67E-02	7.74E-02	7.78E-02	7.83E-02	7.93E-02	7.90E-02	7.82E-02
685	7.65E-02	7.67E-02	7.75E-02	7.78E-02	7.88E-02	7.83E-02	7.73E-02
686	7.65E-02	7.69E-02	7.72E-02	7.78E-02	7.86E-02	7.84E-02	7.72E-02
688	7.48E-02	7.49E-02	7.55E-02	7.60E-02	7.69E-02	7.66E-02	7.59E-02
689	7.66E-02	7.73E-02	7.75E-02	7.80E-02	7.85E-02	7.84E-02	7.77E-02
690	7.66E-02	7.75E-02	7.79E-02	7.82E-02	7.90E-02	7.87E-02	7.75E-02
691	7.55E-02	7.56E-02	7.56E-02	7.55E-02	7.55E-02	7.54E-02	7.54E-02
692	7.70E-02	7.71E-02	7.71E-02	7.73E-02	7.73E-02	7.70E-02	7.70E-02
Biased Statistics							
Average Biased	7.64E-02	7.71E-02	7.75E-02	7.82E-02	7.90E-02	7.87E-02	7.78E-02
Std Dev Biased	6.05E-04	5.08E-04	6.18E-04	6.63E-04	5.29E-04	5.11E-04	5.89E-04
Ps90%/90% (+KTL) Biased	7.80E-02	7.85E-02	7.92E-02	8.00E-02	8.05E-02	8.01E-02	7.94E-02
Ps90%/90% (-KTL) Biased	7.47E-02	7.57E-02	7.58E-02	7.63E-02	7.76E-02	7.73E-02	7.62E-02
Un-Biased Statistics							
Average Un-Biased	7.62E-02	7.66E-02	7.72E-02	7.76E-02	7.84E-02	7.81E-02	7.71E-02
Std Dev Un-Biased	8.04E-04	1.03E-03	9.32E-04	9.01E-04	8.57E-04	8.36E-04	7.42E-04
Ps90%/90% (+KTL) Un-Biased	7.84E-02	7.95E-02	7.97E-02	8.00E-02	8.07E-02	8.04E-02	7.92E-02
Ps90%/90% (-KTL) Un-Biased	7.40E-02	7.38E-02	7.46E-02	7.51E-02	7.60E-02	7.58E-02	7.51E-02
Specification MAX	2.00E-01	2.00E-01	2.00E-01	2.00E-01	2.00E-01	2.00E-01	2.00E-01
Status	PASS	PASS	PASS	PASS	PASS	PASS	PASS

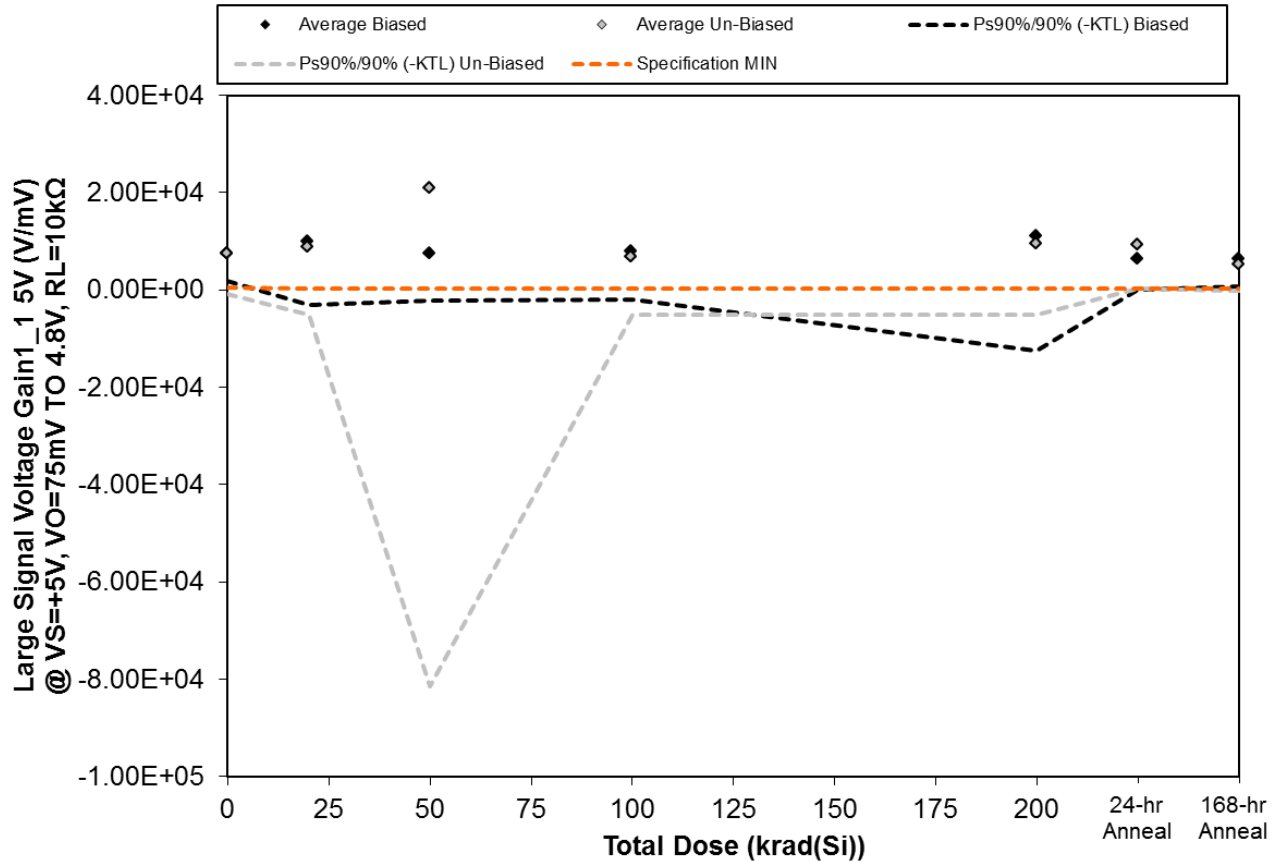

Figure 5.89. Plot of Large Signal Voltage Gain1_1 5V (V/mV) @ VS=+5V, VO=75mV TO 4.8V, RL=10kΩ versus total dose. The solid diamonds are the average of the measured data points for the samples irradiated under electrical bias while the shaded diamonds are the average of the measured data points for the samples irradiated with all pins tied to ground. The black lines (solid and/or dashed) are the upper and/or lower confidence limits, as determined by KTL statistics, on the samples irradiated under electrical bias while the gray lines (solid and/or dashed) are the upper and/or lower confidence limits, as determined by KTL statistics, on the samples irradiated in the unbiased condition. The red dotted line(s) are the pre- and/or post-irradiation minimum and/or maximum specification value as defined in the datasheet and/or test plan.



TID Report
15-0091 03/20/15 R1.0

Aeroflex RAD
5030 Centennial Blvd.
Colorado Springs, CO 80919
(719) 531-0800

Table 5.89. Raw data for Large Signal Voltage Gain1_1 5V (V/mV) @ VS=+5V, VO=75mV TO 4.8V, RL=10kΩ versus total dose, including the statistical analysis, specification and the status of the testing (pass/fail).

Large Signal Voltage Gain1_1 5V (V/mV) @ VS=+5V, VO=75mV TO 4.8V, RL=10kΩ	Total Dose (krad(Si))					24-hr	168-hr
	0	20	50	100	200	Anneal	Anneal
Device							
680	8.02E+03	1.58E+04	9.82E+03	8.26E+03	5.97E+03	8.22E+03	4.82E+03
681	1.02E+04	8.83E+03	1.25E+04	1.18E+04	2.59E+04	5.23E+03	9.53E+03
682	5.49E+03	5.56E+03	6.89E+03	4.38E+03	5.03E+03	4.53E+03	7.68E+03
683	5.49E+03	5.83E+03	4.51E+03	4.07E+03	8.72E+03	4.50E+03	4.54E+03
684	8.63E+03	1.44E+04	4.23E+03	1.12E+04	9.52E+03	9.61E+03	5.95E+03
685	7.19E+03	1.40E+04	3.53E+03	1.32E+04	6.50E+03	5.33E+03	5.44E+03
686	8.53E+03	3.99E+03	3.98E+03	3.45E+03	3.65E+03	1.32E+04	8.71E+03
688	4.68E+03	5.22E+03	4.94E+03	3.43E+03	7.90E+03	1.17E+04	3.31E+03
689	5.22E+03	6.20E+03	4.29E+03	4.60E+03	1.35E+04	6.93E+03	4.49E+03
690	1.24E+04	1.46E+04	8.77E+04	9.54E+03	1.69E+04	9.18E+03	4.97E+03
691	1.05E+04	1.00E+04	1.02E+04	1.07E+04	9.75E+03	9.96E+03	1.14E+04
692	4.35E+03	4.50E+03	4.62E+03	4.39E+03	4.37E+03	4.22E+03	4.52E+03
Biased Statistics							
Average Biased	7.56E+03	1.01E+04	7.58E+03	7.93E+03	1.10E+04	6.42E+03	6.50E+03
Std Dev Biased	2.06E+03	4.80E+03	3.54E+03	3.63E+03	8.54E+03	2.35E+03	2.10E+03
Ps90%/90% (+KTL) Biased	1.32E+04	2.32E+04	1.73E+04	1.79E+04	3.44E+04	1.29E+04	1.23E+04
Ps90%/90% (-KTL) Biased	1.93E+03	-3.06E+03	-2.12E+03	-2.04E+03	-1.24E+04	-3.08E+01	7.52E+02
Un-Biased Statistics							
Average Un-Biased	7.60E+03	8.81E+03	2.09E+04	6.84E+03	9.67E+03	9.26E+03	5.38E+03
Std Dev Un-Biased	3.08E+03	5.10E+03	3.74E+04	4.35E+03	5.37E+03	3.25E+03	2.02E+03
Ps90%/90% (+KTL) Un-Biased	1.60E+04	2.28E+04	1.23E+05	1.88E+04	2.44E+04	1.82E+04	1.09E+04
Ps90%/90% (-KTL) Un-Biased	-8.51E+02	-5.16E+03	-8.15E+04	-5.09E+03	-5.06E+03	3.47E+02	-1.61E+02
Specification MIN	6.00E+02	3.00E+02	3.00E+02	3.00E+02	3.00E+02	3.00E+02	3.00E+02
Status	PASS	PASS	PASS	PASS	PASS	PASS	PASS

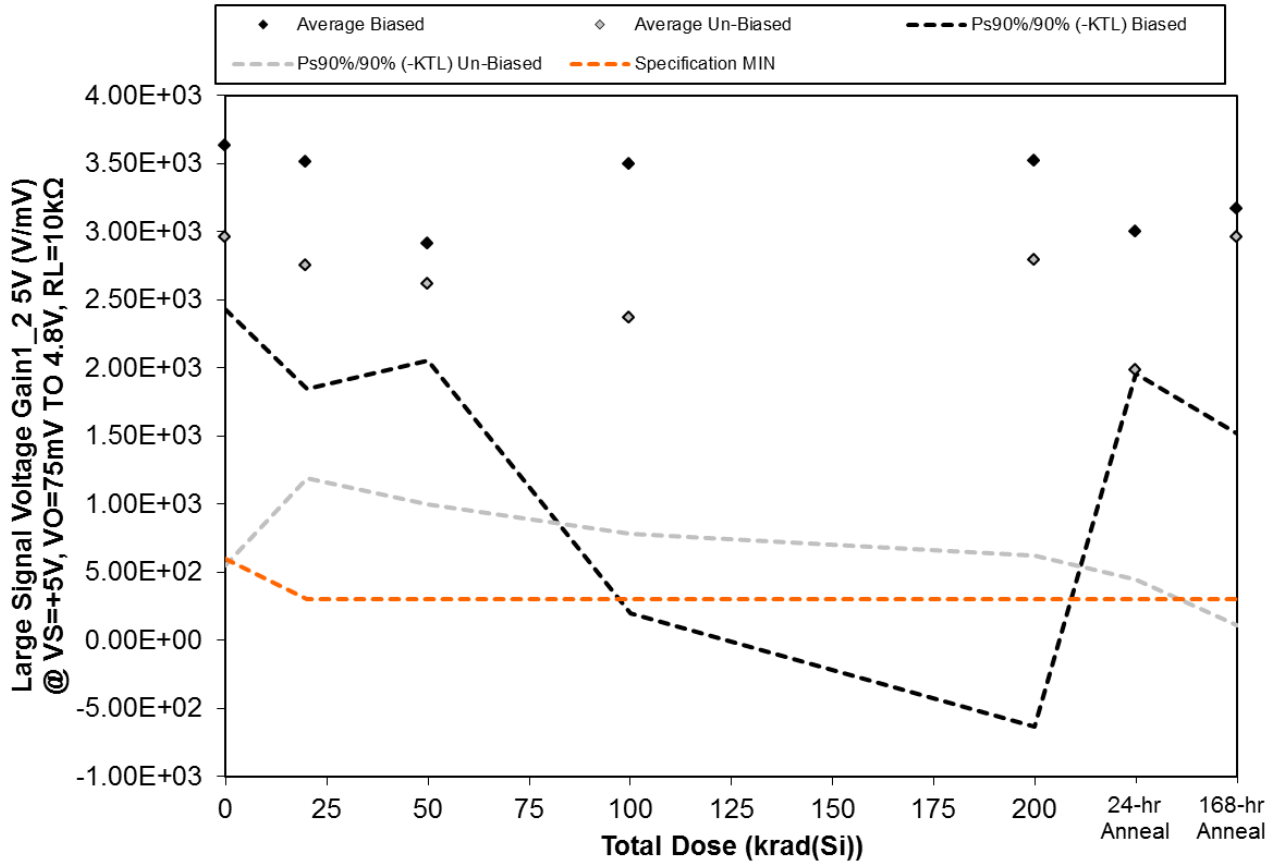

Figure 5.90. Plot of Large Signal Voltage Gain1_2 5V (V/mV) @ VS=+5V, VO=75mV TO 4.8V, RL=10kΩ versus total dose. The solid diamonds are the average of the measured data points for the samples irradiated under electrical bias while the shaded diamonds are the average of the measured data points for the samples irradiated with all pins tied to ground. The black lines (solid and/or dashed) are the upper and/or lower confidence limits, as determined by KTL statistics, on the samples irradiated under electrical bias while the gray lines (solid and/or dashed) are the upper and/or lower confidence limits, as determined by KTL statistics, on the samples irradiated in the unbiased condition. The red dotted line(s) are the pre- and/or post-irradiation minimum and/or maximum specification value as defined in the datasheet and/or test plan.



TID Report
15-0091 03/20/15 R1.0

Aeroflex RAD
5030 Centennial Blvd.
Colorado Springs, CO 80919
(719) 531-0800

Table 5.90. Raw data for Large Signal Voltage Gain1_2 5V (V/mV) @ VS=+5V, VO=75mV TO 4.8V, RL=10kΩ versus total dose, including the statistical analysis, specification and the status of the testing (pass/fail).

Large Signal Voltage Gain1_2 5V (V/mV) @ VS=+5V, VO=75mV TO 4.8V, RL=10kΩ	Total Dose (krad(Si))					24-hr	168-hr
	0	20	50	100	200	Anneal	Anneal
Device							
680	3.69E+03	3.92E+03	2.54E+03	2.88E+03	5.45E+03	3.25E+03	2.99E+03
681	3.58E+03	2.67E+03	2.90E+03	2.74E+03	4.48E+03	2.94E+03	2.65E+03
682	4.29E+03	4.25E+03	2.68E+03	2.30E+03	3.66E+03	3.48E+03	3.77E+03
683	3.52E+03	3.50E+03	3.22E+03	4.51E+03	2.10E+03	2.51E+03	3.84E+03
684	3.07E+03	3.24E+03	3.24E+03	5.04E+03	1.94E+03	2.82E+03	2.59E+03
685	2.62E+03	2.55E+03	3.14E+03	2.47E+03	3.18E+03	1.61E+03	2.46E+03
686	2.60E+03	3.41E+03	3.08E+03	2.87E+03	3.23E+03	2.55E+03	2.42E+03
688	2.99E+03	2.26E+03	1.86E+03	2.21E+03	3.66E+03	1.74E+03	4.57E+03
689	4.44E+03	3.33E+03	2.88E+03	2.83E+03	2.03E+03	2.63E+03	3.40E+03
690	2.15E+03	2.24E+03	2.11E+03	1.45E+03	1.88E+03	1.41E+03	1.97E+03
691	2.73E+03	2.81E+03	2.65E+03	2.67E+03	2.72E+03	2.62E+03	1.96E+03
692	3.77E+03	2.36E+03	3.06E+03	2.67E+03	3.57E+03	2.56E+03	2.73E+03
Biased Statistics							
Average Biased	3.63E+03	3.52E+03	2.92E+03	3.49E+03	3.52E+03	3.00E+03	3.17E+03
Std Dev Biased	4.38E+02	6.11E+02	3.14E+02	1.20E+03	1.51E+03	3.78E+02	6.02E+02
Ps90%/90% (+KTL) Biased	4.83E+03	5.19E+03	3.78E+03	6.79E+03	7.68E+03	4.04E+03	4.82E+03
Ps90%/90% (-KTL) Biased	2.43E+03	1.84E+03	2.06E+03	1.99E+02	-6.29E+02	1.96E+03	1.52E+03
Un-Biased Statistics							
Average Un-Biased	2.96E+03	2.76E+03	2.61E+03	2.37E+03	2.79E+03	1.99E+03	2.96E+03
Std Dev Un-Biased	8.78E+02	5.72E+02	5.89E+02	5.77E+02	7.92E+02	5.63E+02	1.04E+03
Ps90%/90% (+KTL) Un-Biased	5.37E+03	4.32E+03	4.23E+03	3.95E+03	4.96E+03	3.53E+03	5.81E+03
Ps90%/90% (-KTL) Un-Biased	5.50E+02	1.19E+03	1.00E+03	7.86E+02	6.21E+02	4.44E+02	1.14E+02
Specification MIN	6.00E+02	3.00E+02	3.00E+02	3.00E+02	3.00E+02	3.00E+02	3.00E+02
Status	PASS	PASS	PASS	PASS	PASS	PASS	PASS

An ISO 9001:2008 and DLA Certified Company

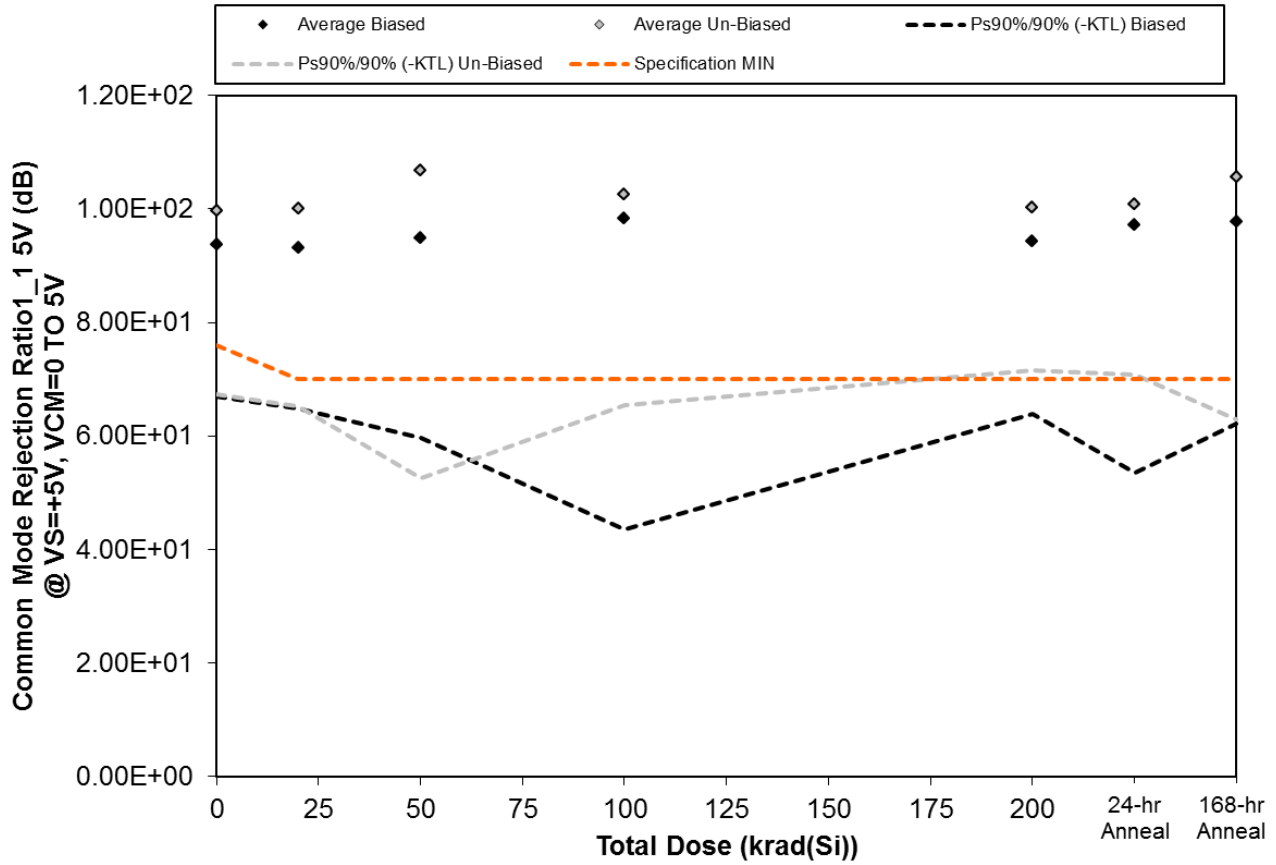

Figure 5.91. Plot of Common Mode Rejection Ratio1_1 5V (dB) @ VS=+5V, VCM=0 TO 5V versus total dose. The solid diamonds are the average of the measured data points for the samples irradiated under electrical bias while the shaded diamonds are the average of the measured data points for the samples irradiated with all pins tied to ground. The black lines (solid and/or dashed) are the upper and/or lower confidence limits, as determined by KTL statistics, on the samples irradiated under electrical bias while the gray lines (solid and/or dashed) are the upper and/or lower confidence limits, as determined by KTL statistics, on the samples irradiated in the unbiased condition. The red dotted line(s) are the pre- and/or post-irradiation minimum and/or maximum specification value as defined in the datasheet and/or test plan.



TID Report
15-0091 03/20/15 R1.0

Aeroflex RAD
5030 Centennial Blvd.
Colorado Springs, CO 80919
(719) 531-0800

Table 5.91. Raw data for Common Mode Rejection Ratio1_1 5V (dB) @ VS=+5V, VCM=0 TO 5V versus total dose, including the statistical analysis, specification and the status of the testing (pass/fail).

Common Mode Rejection Ratio1_1 5V (dB) @ VS=+5V, VCM=0 TO 5V		Total Dose (krad(Si))					24-hr	168-hr
		0	20	50	100	200	Anneal	Anneal
Device								
680	9.59E+01	9.42E+01	9.40E+01	9.39E+01	9.32E+01	9.43E+01	9.87E+01	
681	8.87E+01	8.81E+01	8.88E+01	8.90E+01	8.92E+01	8.98E+01	9.03E+01	
682	8.96E+01	8.88E+01	8.91E+01	8.90E+01	8.90E+01	8.98E+01	9.25E+01	
683	8.47E+01	8.44E+01	8.52E+01	8.62E+01	8.62E+01	8.67E+01	8.73E+01	
684	1.10E+02	1.11E+02	1.17E+02	1.34E+02	1.14E+02	1.25E+02	1.20E+02	
685	1.06E+02	1.08E+02	1.25E+02	1.14E+02	1.07E+02	1.09E+02	1.15E+02	
686	8.94E+01	8.93E+01	9.08E+01	9.24E+01	9.38E+01	9.38E+01	9.23E+01	
688	8.47E+01	8.40E+01	8.46E+01	8.50E+01	8.50E+01	8.53E+01	8.65E+01	
689	1.09E+02	1.06E+02	1.05E+02	1.05E+02	1.06E+02	1.05E+02	1.11E+02	
690	1.10E+02	1.14E+02	1.29E+02	1.16E+02	1.10E+02	1.11E+02	1.23E+02	
691	1.17E+02	1.17E+02	1.17E+02	1.17E+02	1.17E+02	1.17E+02	1.17E+02	
692	8.94E+01	8.94E+01	8.94E+01	8.94E+01	8.94E+01	8.94E+01	8.94E+01	
Biased Statistics								
Average Biased	9.37E+01	9.32E+01	9.48E+01	9.84E+01	9.42E+01	9.72E+01	9.77E+01	
Std Dev Biased	9.75E+00	1.04E+01	1.28E+01	2.00E+01	1.11E+01	1.59E+01	1.30E+01	
Ps90%/90% (+KTL) Biased	1.20E+02	1.22E+02	1.30E+02	1.53E+02	1.25E+02	1.41E+02	1.33E+02	
Ps90%/90% (-KTL) Biased	6.70E+01	6.48E+01	5.97E+01	4.35E+01	6.39E+01	5.35E+01	6.21E+01	
Un-Biased Statistics								
Average Un-Biased	9.97E+01	1.00E+02	1.07E+02	1.03E+02	1.00E+02	1.01E+02	1.06E+02	
Std Dev Un-Biased	1.18E+01	1.27E+01	1.98E+01	1.35E+01	1.04E+01	1.10E+01	1.56E+01	
Ps90%/90% (+KTL) Un-Biased	1.32E+02	1.35E+02	1.61E+02	1.40E+02	1.29E+02	1.31E+02	1.49E+02	
Ps90%/90% (-KTL) Un-Biased	6.74E+01	6.52E+01	5.26E+01	6.54E+01	7.16E+01	7.08E+01	6.28E+01	
Specification MIN	7.60E+01	7.00E+01	7.00E+01	7.00E+01	7.00E+01	7.00E+01	7.00E+01	
Status	PASS	PASS	PASS	PASS	PASS	PASS	PASS	

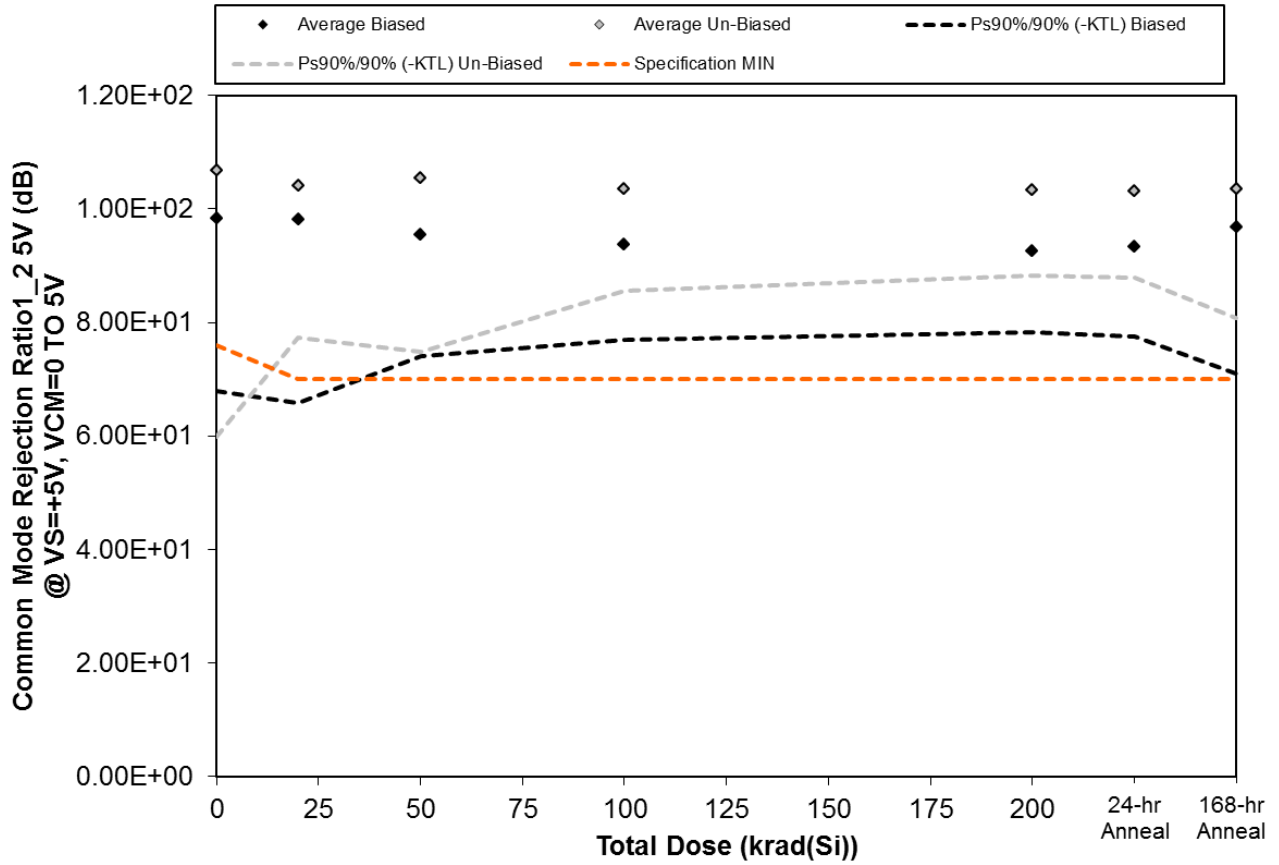

Figure 5.92. Plot of Common Mode Rejection Ratio_{1_2 5V} (dB) @ VS=+5V, VCM=0 TO 5V versus total dose. The solid diamonds are the average of the measured data points for the samples irradiated under electrical bias while the shaded diamonds are the average of the measured data points for the samples irradiated with all pins tied to ground. The black lines (solid and/or dashed) are the upper and/or lower confidence limits, as determined by KTL statistics, on the samples irradiated under electrical bias while the gray lines (solid and/or dashed) are the upper and/or lower confidence limits, as determined by KTL statistics, on the samples irradiated in the unbiased condition. The red dotted line(s) are the pre- and/or post-irradiation minimum and/or maximum specification value as defined in the datasheet and/or test plan.



TID Report
15-0091 03/20/15 R1.0

Aeroflex RAD
5030 Centennial Blvd.
Colorado Springs, CO 80919
(719) 531-0800

Table 5.92. Raw data for Common Mode Rejection Ratio1_2 5V (dB) @ VS=+5V, VCM=0 TO 5V versus total dose, including the statistical analysis, specification and the status of the testing (pass/fail).

Common Mode Rejection Ratio1_2 5V (dB) @ VS=+5V, VCM=0 TO 5V		Total Dose (krad(Si))					24-hr	168-hr
		0	20	50	100	200	Anneal	Anneal
Device								
680	9.83E+01	9.78E+01	9.73E+01	9.58E+01	9.48E+01	9.56E+01	9.74E+01	
681	9.93E+01	9.85E+01	9.70E+01	9.57E+01	9.45E+01	9.53E+01	9.87E+01	
682	8.92E+01	8.90E+01	8.88E+01	8.83E+01	8.79E+01	8.82E+01	8.92E+01	
683	1.16E+02	1.17E+02	1.07E+02	1.02E+02	9.91E+01	1.01E+02	1.11E+02	
684	8.88E+01	8.80E+01	8.76E+01	8.71E+01	8.66E+01	8.70E+01	8.74E+01	
685	9.88E+01	9.98E+01	1.02E+02	1.06E+02	1.11E+02	1.10E+02	1.01E+02	
686	1.35E+02	1.14E+02	1.09E+02	1.04E+02	1.01E+02	1.02E+02	1.09E+02	
688	9.47E+01	9.56E+01	9.63E+01	9.68E+01	9.81E+01	9.75E+01	9.64E+01	
689	9.49E+01	9.57E+01	9.65E+01	9.79E+01	9.91E+01	9.83E+01	9.64E+01	
690	1.10E+02	1.15E+02	1.23E+02	1.13E+02	1.08E+02	1.08E+02	1.15E+02	
691	9.58E+01	9.58E+01	9.58E+01	9.59E+01	9.59E+01	9.59E+01	9.59E+01	
692	9.22E+01	9.22E+01	9.22E+01	9.22E+01	9.22E+01	9.22E+01	9.22E+01	
Biased Statistics								
Average Biased	9.84E+01	9.81E+01	9.55E+01	9.38E+01	9.26E+01	9.34E+01	9.68E+01	
Std Dev Biased	1.11E+01	1.18E+01	7.83E+00	6.19E+00	5.22E+00	5.79E+00	9.42E+00	
Ps90%/90% (+KTL) Biased	1.29E+02	1.31E+02	1.17E+02	1.11E+02	1.07E+02	1.09E+02	1.23E+02	
Ps90%/90% (-KTL) Biased	6.79E+01	6.58E+01	7.41E+01	7.68E+01	7.83E+01	7.75E+01	7.09E+01	
Un-Biased Statistics								
Average Un-Biased	1.07E+02	1.04E+02	1.05E+02	1.04E+02	1.03E+02	1.03E+02	1.03E+02	
Std Dev Un-Biased	1.72E+01	9.74E+00	1.12E+01	6.53E+00	5.54E+00	5.56E+00	8.25E+00	
Ps90%/90% (+KTL) Un-Biased	1.54E+02	1.31E+02	1.36E+02	1.21E+02	1.19E+02	1.18E+02	1.26E+02	
Ps90%/90% (-KTL) Un-Biased	5.98E+01	7.73E+01	7.48E+01	8.56E+01	8.82E+01	8.78E+01	8.09E+01	
Specification MIN	7.60E+01	7.00E+01	7.00E+01	7.00E+01	7.00E+01	7.00E+01	7.00E+01	
Status	PASS	PASS	PASS	PASS	PASS	PASS	PASS	

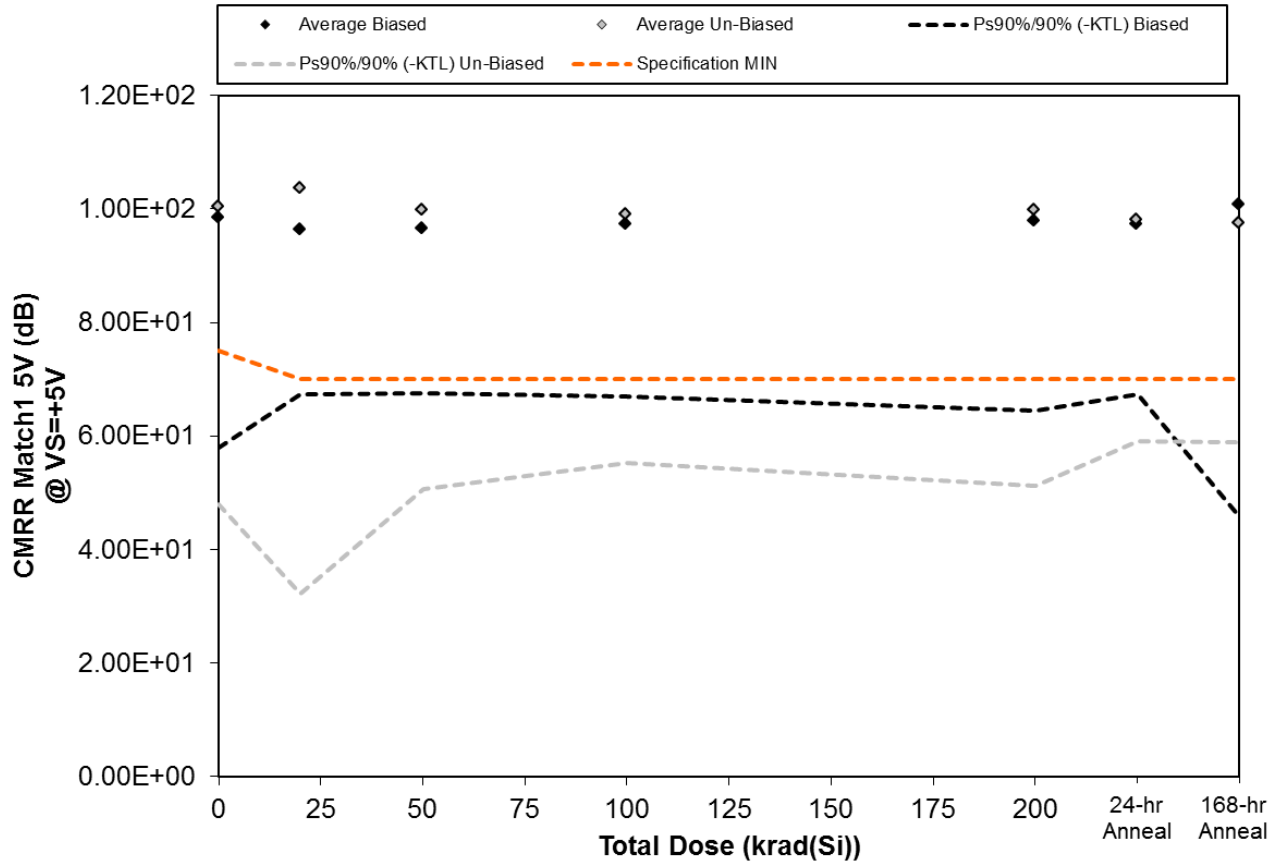

Figure 5.93. Plot of CMRR Match1 5V (dB) @ VS=+5V versus total dose. The solid diamonds are the average of the measured data points for the samples irradiated under electrical bias while the shaded diamonds are the average of the measured data points for the samples irradiated with all pins tied to ground. The black lines (solid and/or dashed) are the upper and/or lower confidence limits, as determined by KTL statistics, on the samples irradiated under electrical bias while the gray lines (solid and/or dashed) are the upper and/or lower confidence limits, as determined by KTL statistics, on the samples irradiated in the unbiased condition. The red dotted line(s) are the pre- and/or post-irradiation minimum and/or maximum specification value as defined in the datasheet and/or test plan.



TID Report
15-0091 03/20/15 R1.0

Aeroflex RAD
5030 Centennial Blvd.
Colorado Springs, CO 80919
(719) 531-0800

Table 5.93. Raw data for CMRR Match1 5V (dB) @ VS=+5V versus total dose, including the statistical analysis, specification and the status of the testing (pass/fail).

CMRR Match1 5V (dB) @ VS=+5V	Total Dose (krad(Si))					24-hr Anneal	168-hr Anneal
	0	20	50	100	200		
Device							
680	1.21E+02	1.09E+02	1.06E+02	1.07E+02	1.05E+02	1.07E+02	1.35E+02
681	9.28E+01	9.33E+01	9.39E+01	9.43E+01	9.45E+01	9.46E+01	9.27E+01
682	1.05E+02	1.06E+02	1.10E+02	1.11E+02	1.15E+02	1.11E+02	1.03E+02
683	8.54E+01	8.60E+01	8.65E+01	8.73E+01	8.75E+01	8.74E+01	8.67E+01
684	8.79E+01	8.75E+01	8.73E+01	8.71E+01	8.70E+01	8.72E+01	8.73E+01
685	1.03E+02	1.03E+02	1.03E+02	1.03E+02	1.02E+02	1.03E+02	9.92E+01
686	9.03E+01	9.01E+01	9.02E+01	9.01E+01	9.03E+01	9.02E+01	9.01E+01
688	8.31E+01	8.30E+01	8.30E+01	8.28E+01	8.27E+01	8.27E+01	8.33E+01
689	9.33E+01	9.36E+01	9.40E+01	9.47E+01	9.55E+01	9.47E+01	9.49E+01
690	1.32E+02	1.48E+02	1.29E+02	1.24E+02	1.29E+02	1.20E+02	1.21E+02
691	9.49E+01	9.52E+01	9.51E+01	9.51E+01	9.49E+01	9.51E+01	9.52E+01
692	1.01E+02	1.01E+02	1.01E+02	1.00E+02	1.01E+02	1.01E+02	1.01E+02
Biased Statistics							
Average Biased	9.84E+01	9.64E+01	9.66E+01	9.73E+01	9.79E+01	9.74E+01	1.01E+02
Std Dev Biased	1.47E+01	1.06E+01	1.06E+01	1.11E+01	1.22E+01	1.10E+01	2.01E+01
Ps90%/90% (+KTL) Biased	1.39E+02	1.26E+02	1.26E+02	1.28E+02	1.31E+02	1.27E+02	1.56E+02
Ps90%/90% (-KTL) Biased	5.80E+01	6.73E+01	6.75E+01	6.69E+01	6.45E+01	6.72E+01	4.58E+01
Un-Biased Statistics							
Average Un-Biased	1.00E+02	1.04E+02	9.99E+01	9.91E+01	9.99E+01	9.81E+01	9.76E+01
Std Dev Un-Biased	1.91E+01	2.60E+01	1.79E+01	1.60E+01	1.78E+01	1.42E+01	1.41E+01
Ps90%/90% (+KTL) Un-Biased	1.53E+02	1.75E+02	1.49E+02	1.43E+02	1.49E+02	1.37E+02	1.36E+02
Ps90%/90% (-KTL) Un-Biased	4.80E+01	3.22E+01	5.07E+01	5.53E+01	5.12E+01	5.91E+01	5.89E+01
Specification MIN	7.50E+01	7.00E+01	7.00E+01	7.00E+01	7.00E+01	7.00E+01	7.00E+01
Status	PASS	PASS	PASS	PASS	PASS	PASS	PASS

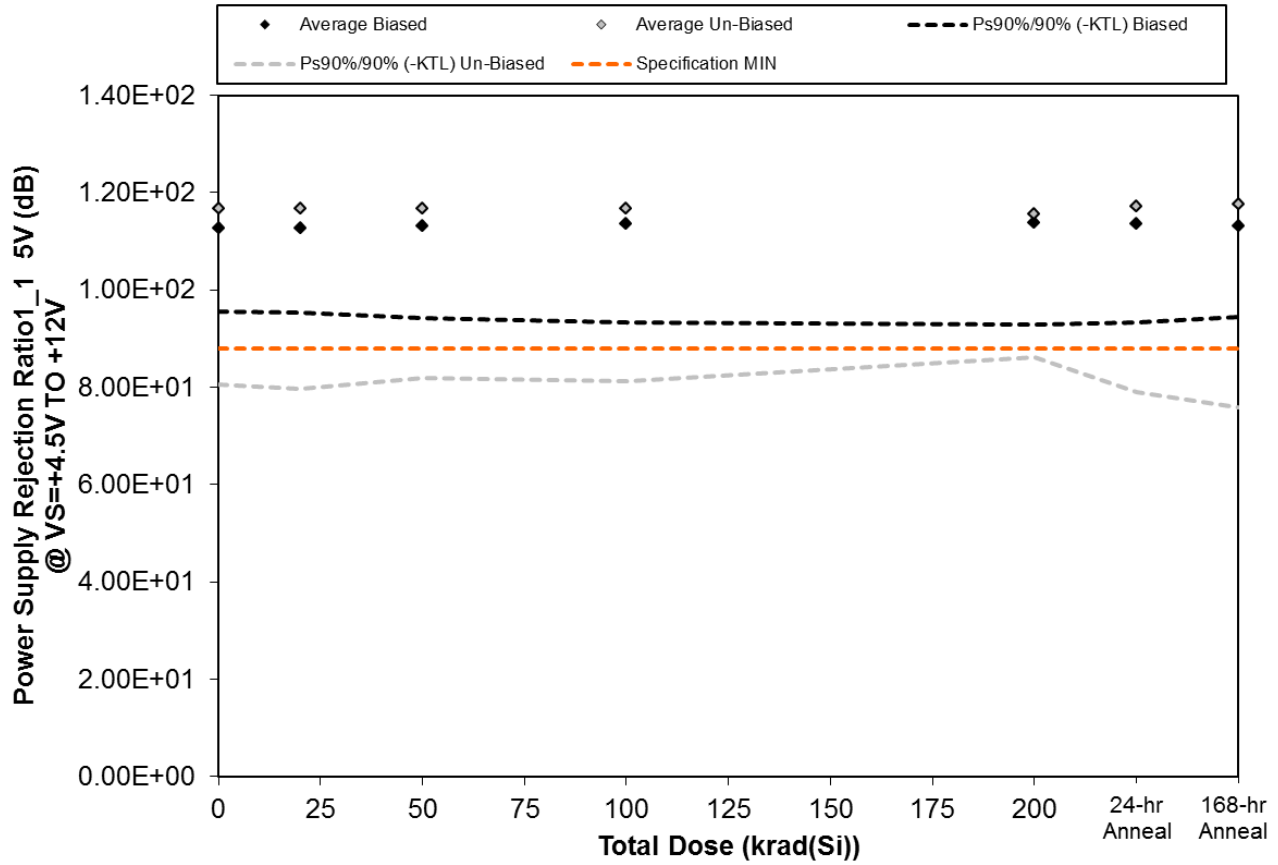

Figure 5.94. Plot of Power Supply Rejection Ratio1_1 5V (dB) @ VS=+4.5V TO +12V versus total dose. The solid diamonds are the average of the measured data points for the samples irradiated under electrical bias while the shaded diamonds are the average of the measured data points for the samples irradiated with all pins tied to ground. The black lines (solid and/or dashed) are the upper and/or lower confidence limits, as determined by KTL statistics, on the samples irradiated under electrical bias while the gray lines (solid and/or dashed) are the upper and/or lower confidence limits, as determined by KTL statistics, on the samples irradiated in the unbiased condition. The red dotted line(s) are the pre- and/or post-irradiation minimum and/or maximum specification value as defined in the datasheet and/or test plan.



TID Report
15-0091 03/20/15 R1.0

Aeroflex RAD
5030 Centennial Blvd.
Colorado Springs, CO 80919
(719) 531-0800

Table 5.94. Raw data for Power Supply Rejection Ratio1_1 5V (dB) @ VS=+4.5V TO +12V versus total dose, including the statistical analysis, specification and the status of the testing (pass/fail).

Power Supply Rejection Ratio1_1 5V (dB) @ VS=+4.5V TO +12V	Total Dose (krad(Si))					24-hr Anneal	168-hr Anneal
	0	20	50	100	200		
Device							
680	1.20E+02	1.20E+02	1.22E+02	1.23E+02	1.25E+02	1.24E+02	1.22E+02
681	1.06E+02	1.05E+02	1.06E+02	1.05E+02	1.06E+02	1.06E+02	1.06E+02
682	1.08E+02	1.08E+02	1.08E+02	1.08E+02	1.08E+02	1.08E+02	1.08E+02
683	1.19E+02	1.18E+02	1.19E+02	1.18E+02	1.18E+02	1.18E+02	1.18E+02
684	1.12E+02	1.13E+02	1.12E+02	1.12E+02	1.12E+02	1.13E+02	1.13E+02
685	1.11E+02	1.11E+02	1.11E+02	1.11E+02	1.11E+02	1.11E+02	1.11E+02
686	1.40E+02	1.41E+02	1.39E+02	1.40E+02	1.35E+02	1.42E+02	1.45E+02
688	1.12E+02	1.12E+02	1.12E+02	1.12E+02	1.12E+02	1.12E+02	1.12E+02
689	1.11E+02	1.10E+02	1.11E+02	1.11E+02	1.11E+02	1.10E+02	1.11E+02
690	1.10E+02	1.10E+02	1.10E+02	1.10E+02	1.10E+02	1.10E+02	1.10E+02
691	1.26E+02	1.26E+02	1.26E+02	1.26E+02	1.26E+02	1.26E+02	1.25E+02
692	1.22E+02	1.23E+02	1.22E+02	1.22E+02	1.22E+02	1.23E+02	1.22E+02
Biased Statistics							
Average Biased	1.13E+02	1.13E+02	1.13E+02	1.14E+02	1.14E+02	1.14E+02	1.13E+02
Std Dev Biased	6.26E+00	6.35E+00	6.86E+00	7.38E+00	7.66E+00	7.41E+00	6.81E+00
Ps90%/90% (+KTL) Biased	1.30E+02	1.30E+02	1.32E+02	1.34E+02	1.35E+02	1.34E+02	1.32E+02
Ps90%/90% (-KTL) Biased	9.55E+01	9.54E+01	9.43E+01	9.33E+01	9.29E+01	9.33E+01	9.46E+01
Un-Biased Statistics							
Average Un-Biased	1.17E+02	1.17E+02	1.17E+02	1.17E+02	1.16E+02	1.17E+02	1.18E+02
Std Dev Un-Biased	1.32E+01	1.36E+01	1.26E+01	1.30E+01	1.08E+01	1.39E+01	1.52E+01
Ps90%/90% (+KTL) Un-Biased	1.53E+02	1.54E+02	1.51E+02	1.52E+02	1.45E+02	1.55E+02	1.59E+02
Ps90%/90% (-KTL) Un-Biased	8.06E+01	7.96E+01	8.20E+01	8.12E+01	8.61E+01	7.89E+01	7.59E+01
Specification MIN	8.80E+01	8.80E+01	8.80E+01	8.80E+01	8.80E+01	8.80E+01	8.80E+01
Status	PASS	PASS	PASS	PASS	PASS	PASS	PASS

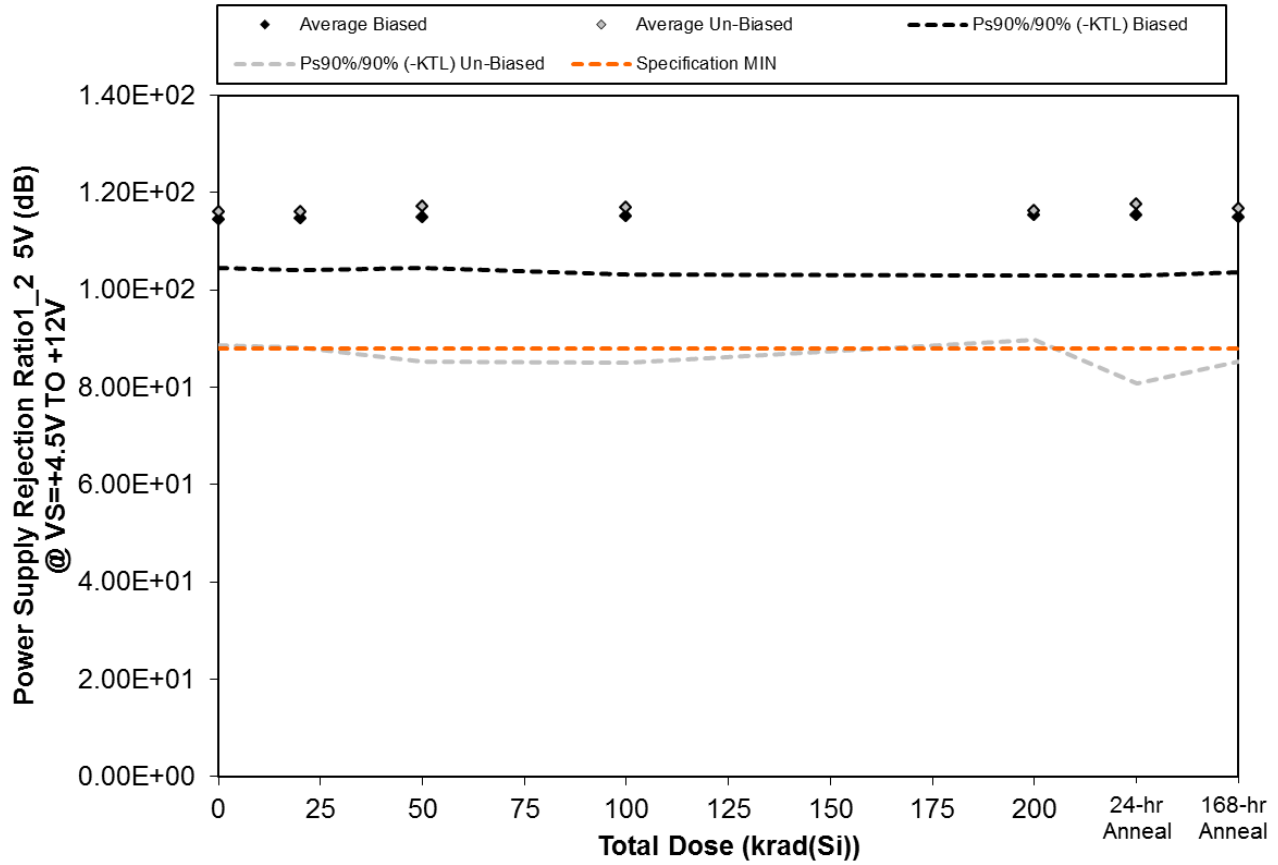

Figure 5.95. Plot of Power Supply Rejection Ratio1_2 5V (dB) @ VS=+4.5V TO +12V versus total dose. The solid diamonds are the average of the measured data points for the samples irradiated under electrical bias while the shaded diamonds are the average of the measured data points for the samples irradiated with all pins tied to ground. The black lines (solid and/or dashed) are the upper and/or lower confidence limits, as determined by KTL statistics, on the samples irradiated under electrical bias while the gray lines (solid and/or dashed) are the upper and/or lower confidence limits, as determined by KTL statistics, on the samples irradiated in the unbiased condition. The red dotted line(s) are the pre- and/or post-irradiation minimum and/or maximum specification value as defined in the datasheet and/or test plan.



TID Report
15-0091 03/20/15 R1.0

Aeroflex RAD
5030 Centennial Blvd.
Colorado Springs, CO 80919
(719) 531-0800

Table 5.95. Raw data for Power Supply Rejection Ratio1_2 5V (dB) @ VS=+4.5V TO +12V versus total dose, including the statistical analysis, specification and the status of the testing (pass/fail).

Power Supply Rejection Ratio1_2 5V (dB) @ VS=+4.5V TO +12V	Total Dose (krad(Si))					24-hr Anneal	168-hr Anneal
	0	20	50	100	200		
Device							
680	1.14E+02	1.14E+02	1.15E+02	1.14E+02	1.14E+02	1.14E+02	1.13E+02
681	1.17E+02	1.17E+02	1.17E+02	1.18E+02	1.17E+02	1.17E+02	1.17E+02
682	1.10E+02	1.10E+02	1.10E+02	1.10E+02	1.10E+02	1.10E+02	1.10E+02
683	1.20E+02	1.20E+02	1.20E+02	1.21E+02	1.22E+02	1.22E+02	1.21E+02
684	1.13E+02	1.13E+02	1.14E+02	1.14E+02	1.14E+02	1.14E+02	1.14E+02
685	1.12E+02	1.12E+02	1.12E+02	1.12E+02	1.13E+02	1.12E+02	1.12E+02
686	1.34E+02	1.34E+02	1.38E+02	1.38E+02	1.33E+02	1.42E+02	1.37E+02
688	1.09E+02	1.09E+02	1.09E+02	1.09E+02	1.09E+02	1.09E+02	1.09E+02
689	1.15E+02	1.15E+02	1.15E+02	1.15E+02	1.15E+02	1.14E+02	1.15E+02
690	1.11E+02	1.12E+02	1.13E+02	1.12E+02	1.12E+02	1.12E+02	1.12E+02
691	1.19E+02	1.19E+02	1.19E+02	1.19E+02	1.19E+02	1.19E+02	1.19E+02
692	1.52E+02	1.53E+02	1.55E+02	1.53E+02	1.50E+02	1.58E+02	1.58E+02
Biased Statistics							
Average Biased	1.15E+02	1.15E+02	1.15E+02	1.15E+02	1.15E+02	1.15E+02	1.15E+02
Std Dev Biased	3.66E+00	3.81E+00	3.86E+00	4.38E+00	4.51E+00	4.51E+00	4.14E+00
Ps90%/90% (+KTL) Biased	1.25E+02	1.25E+02	1.26E+02	1.27E+02	1.28E+02	1.28E+02	1.26E+02
Ps90%/90% (-KTL) Biased	1.04E+02	1.04E+02	1.04E+02	1.03E+02	1.03E+02	1.03E+02	1.04E+02
Un-Biased Statistics							
Average Un-Biased	1.16E+02	1.16E+02	1.17E+02	1.17E+02	1.16E+02	1.18E+02	1.17E+02
Std Dev Un-Biased	1.00E+01	1.01E+01	1.16E+01	1.17E+01	9.67E+00	1.35E+01	1.15E+01
Ps90%/90% (+KTL) Un-Biased	1.44E+02	1.44E+02	1.49E+02	1.49E+02	1.43E+02	1.55E+02	1.48E+02
Ps90%/90% (-KTL) Un-Biased	8.86E+01	8.83E+01	8.53E+01	8.51E+01	8.98E+01	8.07E+01	8.52E+01
Specification MIN	8.80E+01	8.80E+01	8.80E+01	8.80E+01	8.80E+01	8.80E+01	8.80E+01
Status	PASS	PASS	PASS	PASS	PASS	PASS	PASS

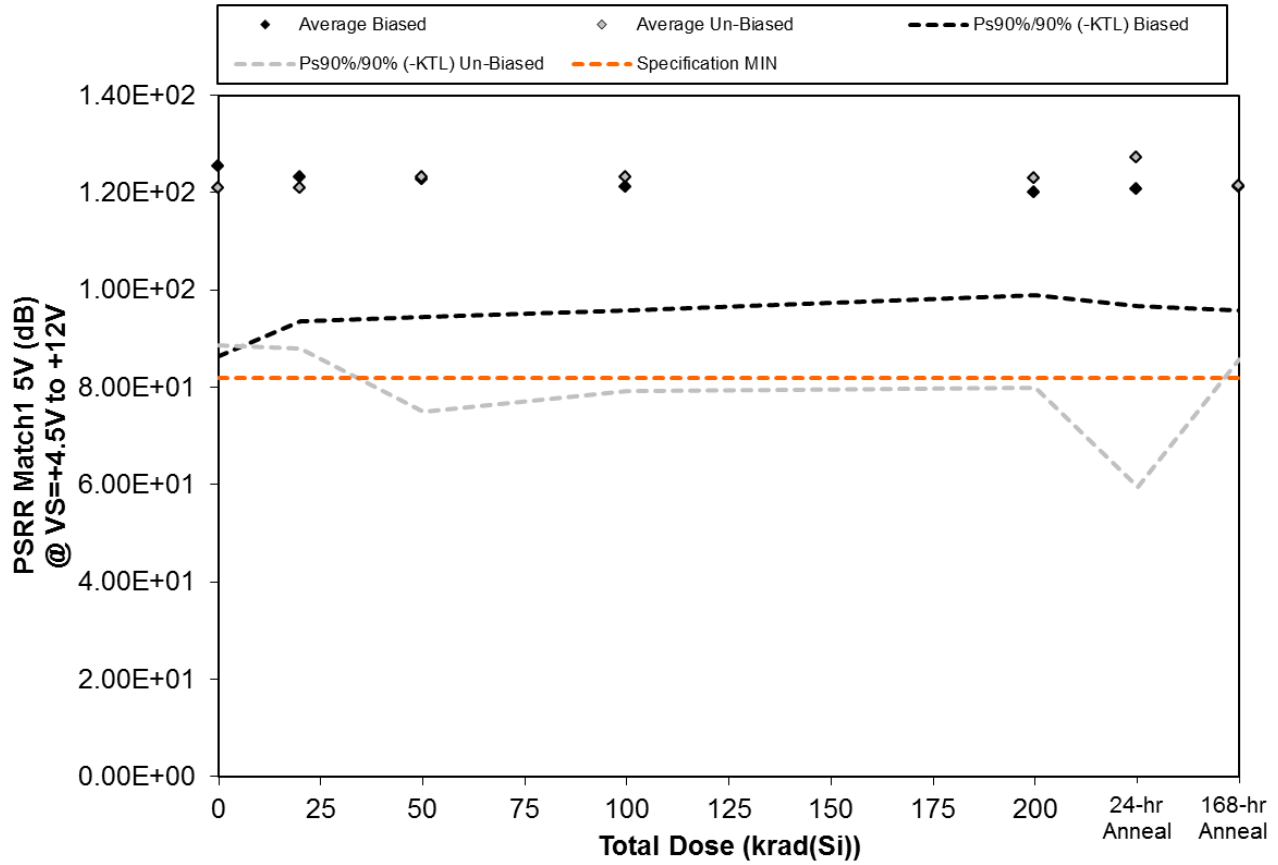

Figure 5.96. Plot of PSRR Match1 5V (dB) @ VS=+4.5V to +12V versus total dose. The solid diamonds are the average of the measured data points for the samples irradiated under electrical bias while the shaded diamonds are the average of the measured data points for the samples irradiated with all pins tied to ground. The black lines (solid and/or dashed) are the upper and/or lower confidence limits, as determined by KTL statistics, on the samples irradiated under electrical bias while the gray lines (solid and/or dashed) are the upper and/or lower confidence limits, as determined by KTL statistics, on the samples irradiated in the unbiased condition. The red dotted line(s) are the pre- and/or post-irradiation minimum and/or maximum specification value as defined in the datasheet and/or test plan.



TID Report
15-0091 03/20/15 R1.0

Aeroflex RAD
5030 Centennial Blvd.
Colorado Springs, CO 80919
(719) 531-0800

Table 5.96. Raw data for PSRR Match1 5V (dB) @ VS=+4.5V to +12V versus total dose, including the statistical analysis, specification and the status of the testing (pass/fail).

PSRR Match1 5V (dB) @ VS=+4.5V to +12V	Total Dose (krad(Si))					24-hr Anneal	168-hr Anneal
	0	20	50	100	200		
Device							
680	1.19E+02	1.19E+02	1.20E+02	1.17E+02	1.16E+02	1.17E+02	1.18E+02
681	1.08E+02	1.08E+02	1.08E+02	1.08E+02	1.09E+02	1.08E+02	1.08E+02
682	1.20E+02	1.21E+02	1.21E+02	1.22E+02	1.23E+02	1.22E+02	1.20E+02
683	1.38E+02	1.33E+02	1.34E+02	1.29E+02	1.26E+02	1.27E+02	1.29E+02
684	1.43E+02	1.35E+02	1.31E+02	1.31E+02	1.27E+02	1.31E+02	1.31E+02
685	1.06E+02	1.05E+02	1.06E+02	1.06E+02	1.06E+02	1.06E+02	1.06E+02
686	1.38E+02	1.39E+02	1.53E+02	1.49E+02	1.49E+02	1.70E+02	1.42E+02
688	1.18E+02	1.19E+02	1.18E+02	1.18E+02	1.20E+02	1.18E+02	1.18E+02
689	1.19E+02	1.18E+02	1.19E+02	1.18E+02	1.18E+02	1.19E+02	1.19E+02
690	1.25E+02	1.24E+02	1.22E+02	1.25E+02	1.23E+02	1.24E+02	1.23E+02
691	1.16E+02	1.16E+02	1.16E+02	1.16E+02	1.16E+02	1.16E+02	1.16E+02
692	1.22E+02	1.23E+02	1.22E+02	1.23E+02	1.22E+02	1.23E+02	1.22E+02
Biased Statistics							
Average Biased	1.26E+02	1.23E+02	1.23E+02	1.21E+02	1.20E+02	1.21E+02	1.21E+02
Std Dev Biased	1.43E+01	1.08E+01	1.03E+01	9.32E+00	7.72E+00	8.77E+00	9.23E+00
Ps90%/90% (+KTL) Biased	1.65E+02	1.53E+02	1.51E+02	1.47E+02	1.41E+02	1.45E+02	1.47E+02
Ps90%/90% (-KTL) Biased	8.65E+01	9.35E+01	9.44E+01	9.57E+01	9.90E+01	9.68E+01	9.59E+01
Un-Biased Statistics							
Average Un-Biased	1.21E+02	1.21E+02	1.23E+02	1.23E+02	1.23E+02	1.27E+02	1.22E+02
Std Dev Un-Biased	1.18E+01	1.20E+01	1.76E+01	1.61E+01	1.58E+01	2.47E+01	1.30E+01
Ps90%/90% (+KTL) Un-Biased	1.53E+02	1.54E+02	1.72E+02	1.67E+02	1.66E+02	1.95E+02	1.57E+02
Ps90%/90% (-KTL) Un-Biased	8.87E+01	8.80E+01	7.50E+01	7.92E+01	7.98E+01	5.95E+01	8.58E+01
Specification MIN	8.20E+01	8.20E+01	8.20E+01	8.20E+01	8.20E+01	8.20E+01	8.20E+01
Status	PASS	PASS	PASS	PASS	PASS	PASS	PASS

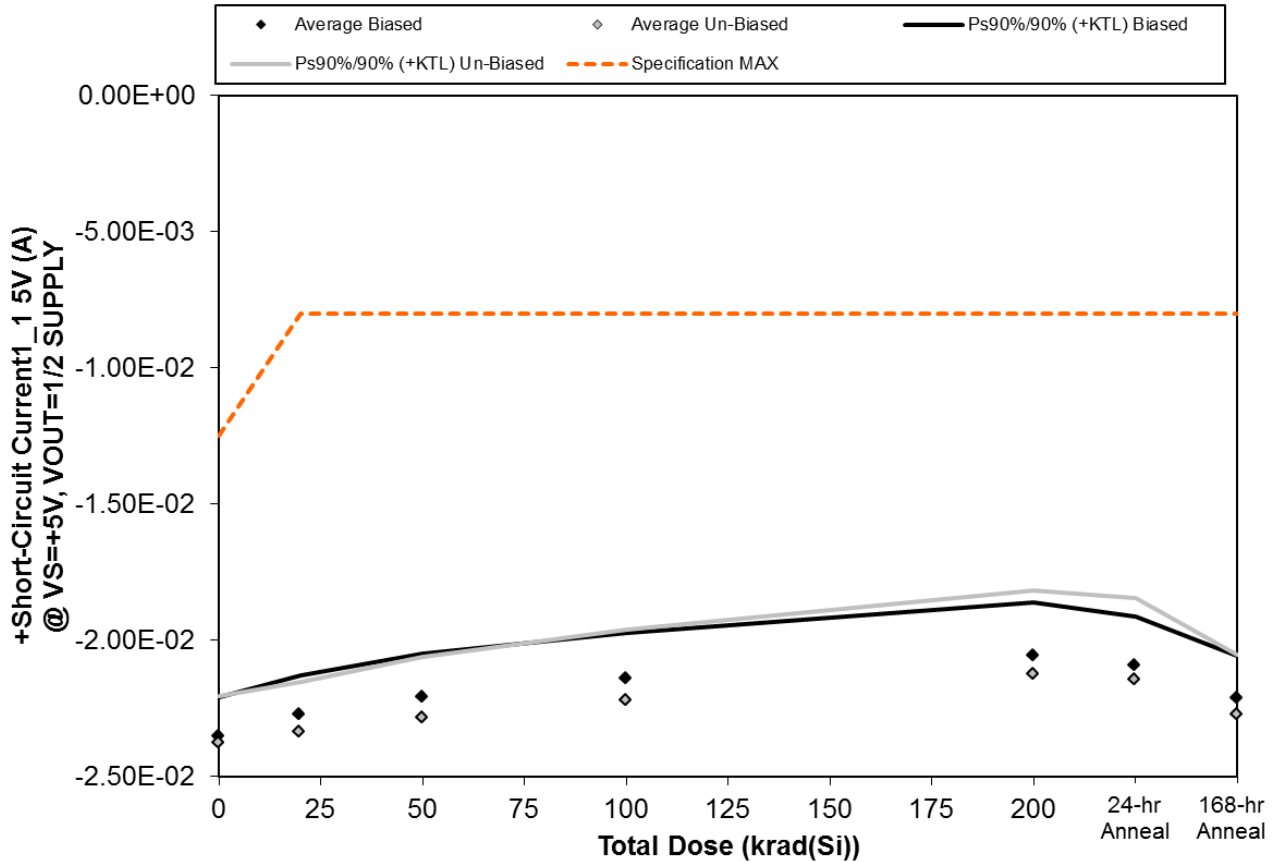

Figure 5.97. Plot of +Short-Circuit Current1_1 5V (A) @ VS=+5V, VOUT=1/2 SUPPLY versus total dose. The solid diamonds are the average of the measured data points for the samples irradiated under electrical bias while the shaded diamonds are the average of the measured data points for the samples irradiated with all pins tied to ground. The black lines (solid and/or dashed) are the upper and/or lower confidence limits, as determined by KTL statistics, on the samples irradiated under electrical bias while the gray lines (solid and/or dashed) are the upper and/or lower confidence limits, as determined by KTL statistics, on the samples irradiated in the unbiased condition. The red dotted line(s) are the pre- and/or post-irradiation minimum and/or maximum specification value as defined in the datasheet and/or test plan.



TID Report
15-0091 03/20/15 R1.0

Aeroflex RAD
5030 Centennial Blvd.
Colorado Springs, CO 80919
(719) 531-0800

Table 5.97. Raw data for +Short-Circuit Current1_1 5V (A) @ VS=+5V, VOUT=1/2 SUPPLY versus total dose, including the statistical analysis, specification and the status of the testing (pass/fail).

+Short-Circuit Current1_1 5V (A) @ VS=+5V, VOUT=1/2 SUPPLY	Total Dose (krad(Si))					24-hr Anneal	168-hr Anneal
	0	20	50	100	200		
Device							
680	-2.34E-02	-2.25E-02	-2.17E-02	-2.10E-02	-1.98E-02	-2.03E-02	-2.18E-02
681	-2.29E-02	-2.21E-02	-2.14E-02	-2.07E-02	-1.98E-02	-2.02E-02	-2.14E-02
682	-2.42E-02	-2.34E-02	-2.28E-02	-2.22E-02	-2.14E-02	-2.17E-02	-2.28E-02
683	-2.32E-02	-2.25E-02	-2.19E-02	-2.12E-02	-2.06E-02	-2.09E-02	-2.19E-02
684	-2.38E-02	-2.31E-02	-2.25E-02	-2.19E-02	-2.11E-02	-2.14E-02	-2.26E-02
685	-2.35E-02	-2.31E-02	-2.25E-02	-2.17E-02	-2.07E-02	-2.09E-02	-2.23E-02
686	-2.35E-02	-2.30E-02	-2.24E-02	-2.17E-02	-2.06E-02	-2.08E-02	-2.24E-02
688	-2.48E-02	-2.45E-02	-2.42E-02	-2.38E-02	-2.31E-02	-2.33E-02	-2.41E-02
689	-2.38E-02	-2.33E-02	-2.28E-02	-2.22E-02	-2.14E-02	-2.16E-02	-2.28E-02
690	-2.32E-02	-2.28E-02	-2.22E-02	-2.15E-02	-2.04E-02	-2.06E-02	-2.21E-02
691	-2.42E-02	-2.43E-02	-2.42E-02	-2.43E-02	-2.43E-02	-2.42E-02	-2.42E-02
692	-2.33E-02	-2.33E-02	-2.33E-02	-2.33E-02	-2.33E-02	-2.33E-02	-2.33E-02
Biased Statistics							
Average Biased	-2.35E-02	-2.27E-02	-2.21E-02	-2.14E-02	-2.05E-02	-2.09E-02	-2.21E-02
Std Dev Biased	5.12E-04	5.23E-04	5.73E-04	6.13E-04	7.09E-04	6.55E-04	5.60E-04
Ps90%/90% (+KTL) Biased	-2.21E-02	-2.13E-02	-2.05E-02	-1.97E-02	-1.86E-02	-1.91E-02	-2.06E-02
Ps90%/90% (-KTL) Biased	-2.49E-02	-2.41E-02	-2.36E-02	-2.31E-02	-2.25E-02	-2.27E-02	-2.36E-02
Un-Biased Statistics							
Average Un-Biased	-2.38E-02	-2.33E-02	-2.28E-02	-2.22E-02	-2.12E-02	-2.14E-02	-2.27E-02
Std Dev Un-Biased	6.29E-04	6.69E-04	8.04E-04	9.30E-04	1.12E-03	1.09E-03	7.98E-04
Ps90%/90% (+KTL) Un-Biased	-2.20E-02	-2.15E-02	-2.06E-02	-1.96E-02	-1.82E-02	-1.84E-02	-2.05E-02
Ps90%/90% (-KTL) Un-Biased	-2.55E-02	-2.52E-02	-2.50E-02	-2.47E-02	-2.43E-02	-2.44E-02	-2.49E-02
Specification MAX	-1.25E-02	-8.00E-03	-8.00E-03	-8.00E-03	-8.00E-03	-8.00E-03	-8.00E-03
Status	PASS	PASS	PASS	PASS	PASS	PASS	PASS

An ISO 9001:2008 and DLA Certified Company

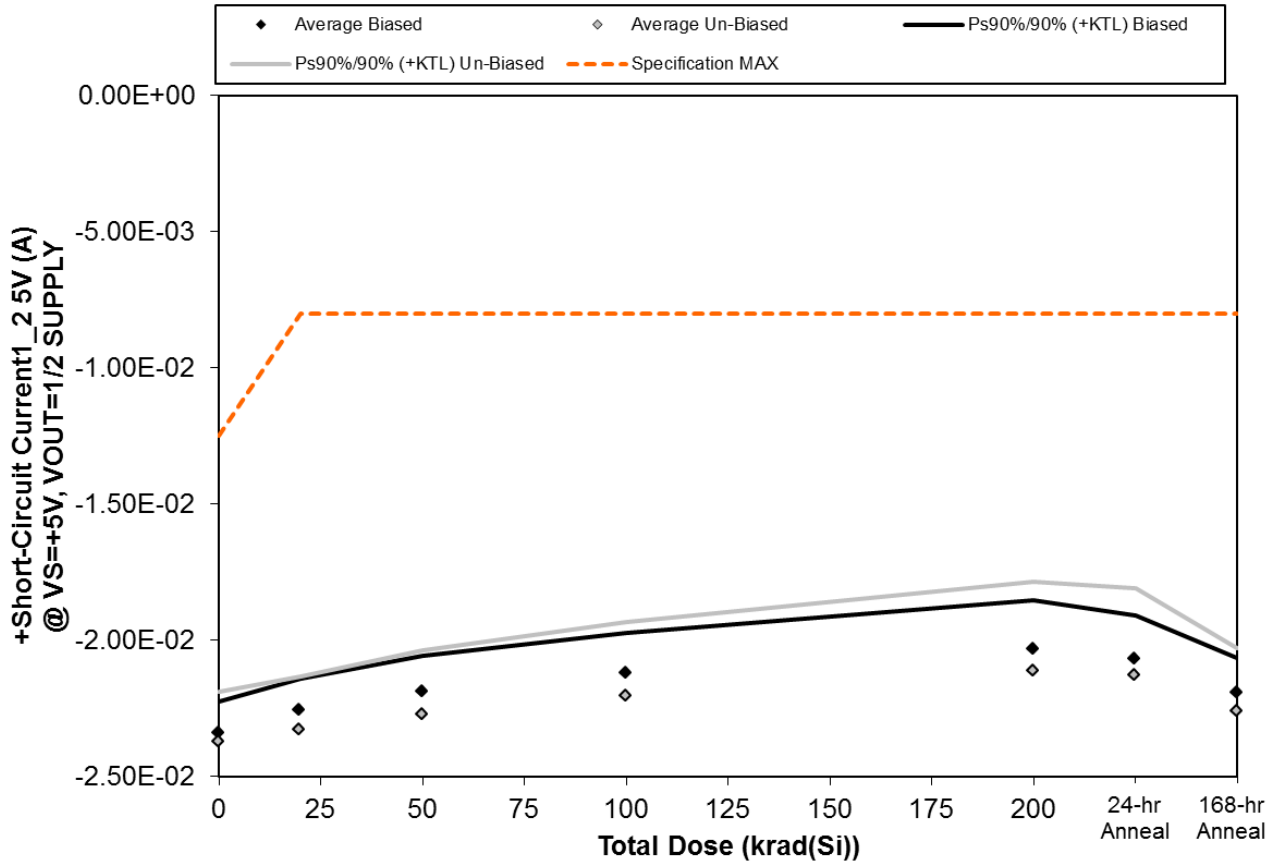

Figure 5.98. Plot of +Short-Circuit Current1_2 5V (A) @ VS=+5V, VOUT=1/2 SUPPLY versus total dose. The solid diamonds are the average of the measured data points for the samples irradiated under electrical bias while the shaded diamonds are the average of the measured data points for the samples irradiated with all pins tied to ground. The black lines (solid and/or dashed) are the upper and/or lower confidence limits, as determined by KTL statistics, on the samples irradiated under electrical bias while the gray lines (solid and/or dashed) are the upper and/or lower confidence limits, as determined by KTL statistics, on the samples irradiated in the unbiased condition. The red dotted line(s) are the pre- and/or post-irradiation minimum and/or maximum specification value as defined in the datasheet and/or test plan.



TID Report
15-0091 03/20/15 R1.0

Aeroflex RAD
5030 Centennial Blvd.
Colorado Springs, CO 80919
(719) 531-0800

Table 5.98. Raw data for +Short-Circuit Current1_2 5V (A) @ VS=+5V, VOUT=1/2 SUPPLY versus total dose, including the statistical analysis, specification and the status of the testing (pass/fail).

+Short-Circuit Current1_2 5V (A) @ VS=+5V, VOUT=1/2 SUPPLY	Total Dose (krad(Si))					24-hr Anneal	168-hr Anneal
	0	20	50	100	200		
Device							
680	-2.31E-02	-2.22E-02	-2.14E-02	-2.06E-02	-1.95E-02	-1.99E-02	-2.15E-02
681	-2.30E-02	-2.22E-02	-2.15E-02	-2.08E-02	-1.99E-02	-2.03E-02	-2.15E-02
682	-2.40E-02	-2.32E-02	-2.26E-02	-2.19E-02	-2.11E-02	-2.14E-02	-2.26E-02
683	-2.32E-02	-2.24E-02	-2.18E-02	-2.11E-02	-2.05E-02	-2.08E-02	-2.18E-02
684	-2.36E-02	-2.28E-02	-2.21E-02	-2.15E-02	-2.07E-02	-2.10E-02	-2.22E-02
685	-2.35E-02	-2.31E-02	-2.25E-02	-2.17E-02	-2.07E-02	-2.09E-02	-2.23E-02
686	-2.32E-02	-2.27E-02	-2.20E-02	-2.12E-02	-2.02E-02	-2.04E-02	-2.19E-02
688	-2.48E-02	-2.44E-02	-2.41E-02	-2.37E-02	-2.30E-02	-2.32E-02	-2.40E-02
689	-2.38E-02	-2.33E-02	-2.28E-02	-2.22E-02	-2.13E-02	-2.15E-02	-2.27E-02
690	-2.32E-02	-2.28E-02	-2.21E-02	-2.14E-02	-2.02E-02	-2.05E-02	-2.20E-02
691	-2.38E-02	-2.38E-02	-2.38E-02	-2.38E-02	-2.38E-02	-2.38E-02	-2.38E-02
692	-2.33E-02	-2.33E-02	-2.33E-02	-2.33E-02	-2.33E-02	-2.33E-02	-2.33E-02
Biased Statistics							
Average Biased	-2.34E-02	-2.25E-02	-2.19E-02	-2.12E-02	-2.03E-02	-2.07E-02	-2.19E-02
Std Dev Biased	4.15E-04	4.20E-04	4.79E-04	5.31E-04	6.46E-04	5.79E-04	4.66E-04
Ps90%/90% (+KTL) Biased	-2.22E-02	-2.14E-02	-2.06E-02	-1.97E-02	-1.85E-02	-1.91E-02	-2.06E-02
Ps90%/90% (-KTL) Biased	-2.45E-02	-2.37E-02	-2.32E-02	-2.26E-02	-2.21E-02	-2.23E-02	-2.32E-02
Un-Biased Statistics							
Average Un-Biased	-2.37E-02	-2.33E-02	-2.27E-02	-2.20E-02	-2.11E-02	-2.13E-02	-2.26E-02
Std Dev Un-Biased	6.63E-04	7.09E-04	8.45E-04	9.82E-04	1.18E-03	1.16E-03	8.38E-04
Ps90%/90% (+KTL) Un-Biased	-2.19E-02	-2.13E-02	-2.04E-02	-1.93E-02	-1.78E-02	-1.81E-02	-2.03E-02
Ps90%/90% (-KTL) Un-Biased	-2.55E-02	-2.52E-02	-2.50E-02	-2.47E-02	-2.43E-02	-2.45E-02	-2.49E-02
Specification MAX	-1.25E-02	-8.00E-03	-8.00E-03	-8.00E-03	-8.00E-03	-8.00E-03	-8.00E-03
Status	PASS	PASS	PASS	PASS	PASS	PASS	PASS

An ISO 9001:2008 and DLA Certified Company

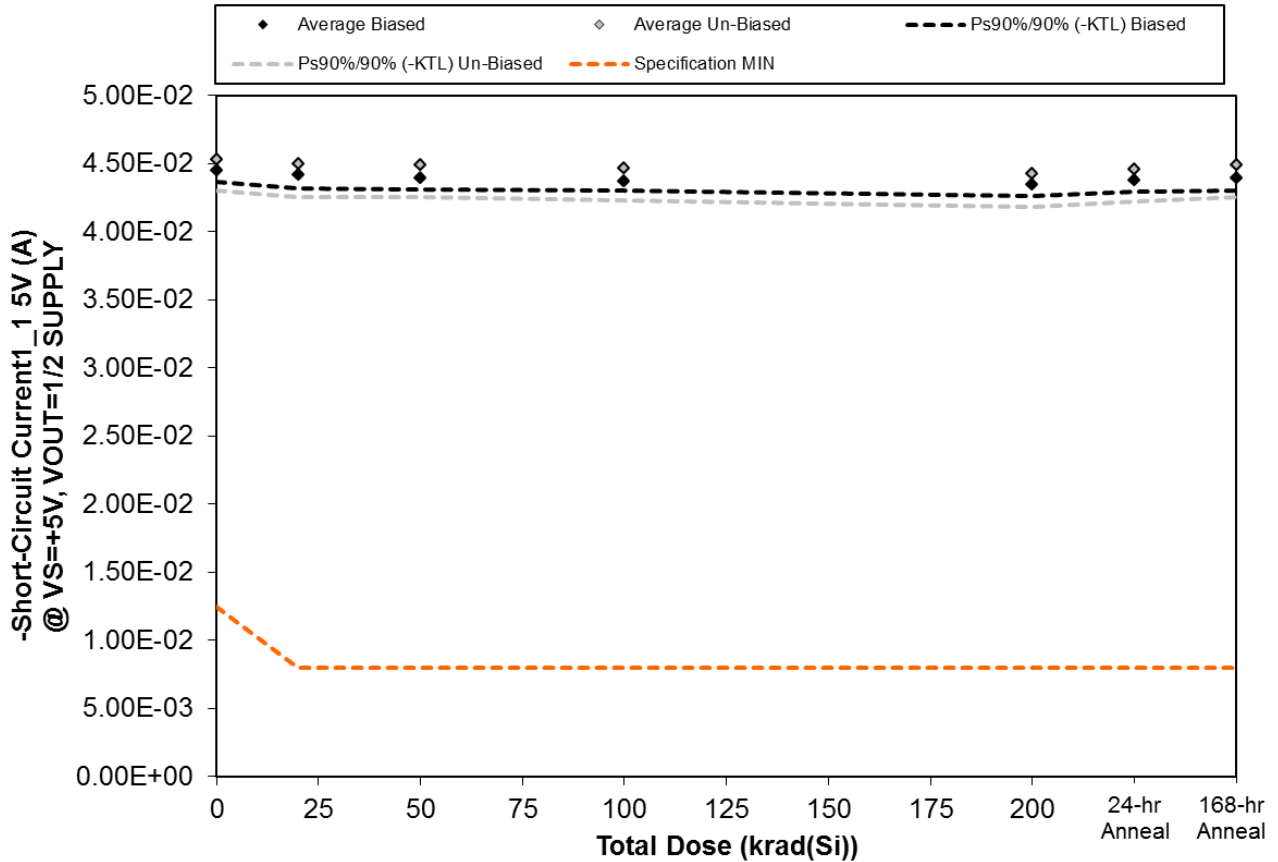

Figure 5.99. Plot of -Short-Circuit Current1_1 5V (A) @ VS=+5V, VOUT=1/2 SUPPLY versus total dose. The solid diamonds are the average of the measured data points for the samples irradiated under electrical bias while the shaded diamonds are the average of the measured data points for the samples irradiated with all pins tied to ground. The black lines (solid and/or dashed) are the upper and/or lower confidence limits, as determined by KTL statistics, on the samples irradiated under electrical bias while the gray lines (solid and/or dashed) are the upper and/or lower confidence limits, as determined by KTL statistics, on the samples irradiated in the unbiased condition. The red dotted line(s) are the pre- and/or post-irradiation minimum and/or maximum specification value as defined in the datasheet and/or test plan.



TID Report
15-0091 03/20/15 R1.0

Aeroflex RAD
5030 Centennial Blvd.
Colorado Springs, CO 80919
(719) 531-0800

Table 5.99. Raw data for -Short-Circuit Current1_1 5V (A) @ VS=+5V, VOUT=1/2 SUPPLY versus total dose, including the statistical analysis, specification and the status of the testing (pass/fail).

-Short-Circuit Current1_1 5V (A) @ VS=+5V, VOUT=1/2 SUPPLY	Total Dose (krad(Si))					24-hr	168-hr
	0	20	50	100	200	Anneal	Anneal
Device							
680	4.47E-02	4.44E-02	4.42E-02	4.38E-02	4.36E-02	4.40E-02	4.42E-02
681	4.43E-02	4.39E-02	4.38E-02	4.36E-02	4.34E-02	4.36E-02	4.37E-02
682	4.49E-02	4.45E-02	4.43E-02	4.41E-02	4.38E-02	4.41E-02	4.43E-02
683	4.45E-02	4.42E-02	4.40E-02	4.38E-02	4.35E-02	4.38E-02	4.40E-02
684	4.41E-02	4.37E-02	4.35E-02	4.34E-02	4.30E-02	4.34E-02	4.35E-02
685	4.49E-02	4.46E-02	4.45E-02	4.43E-02	4.39E-02	4.43E-02	4.46E-02
686	4.50E-02	4.49E-02	4.47E-02	4.45E-02	4.40E-02	4.43E-02	4.47E-02
688	4.67E-02	4.65E-02	4.64E-02	4.61E-02	4.58E-02	4.60E-02	4.64E-02
689	4.51E-02	4.49E-02	4.48E-02	4.45E-02	4.42E-02	4.44E-02	4.47E-02
690	4.46E-02	4.41E-02	4.41E-02	4.38E-02	4.35E-02	4.37E-02	4.42E-02
691	4.63E-02	4.62E-02	4.63E-02	4.62E-02	4.63E-02	4.64E-02	4.63E-02
692	4.41E-02	4.41E-02	4.42E-02	4.41E-02	4.41E-02	4.43E-02	4.41E-02
Biased Statistics							
Average Biased	4.45E-02	4.41E-02	4.40E-02	4.37E-02	4.34E-02	4.38E-02	4.39E-02
Std Dev Biased	3.06E-04	3.40E-04	3.24E-04	2.70E-04	3.10E-04	3.09E-04	3.27E-04
Ps90%/90% (+KTL) Biased	4.54E-02	4.51E-02	4.49E-02	4.45E-02	4.43E-02	4.46E-02	4.48E-02
Ps90%/90% (-KTL) Biased	4.37E-02	4.32E-02	4.31E-02	4.30E-02	4.26E-02	4.29E-02	4.30E-02
Un-Biased Statistics							
Average Un-Biased	4.53E-02	4.50E-02	4.49E-02	4.46E-02	4.43E-02	4.46E-02	4.49E-02
Std Dev Un-Biased	8.17E-04	9.06E-04	8.75E-04	8.69E-04	8.97E-04	8.49E-04	8.51E-04
Ps90%/90% (+KTL) Un-Biased	4.75E-02	4.75E-02	4.73E-02	4.70E-02	4.67E-02	4.69E-02	4.72E-02
Ps90%/90% (-KTL) Un-Biased	4.30E-02	4.25E-02	4.25E-02	4.23E-02	4.18E-02	4.22E-02	4.26E-02
Specification MIN	1.25E-02	8.00E-03	8.00E-03	8.00E-03	8.00E-03	8.00E-03	8.00E-03
Status	PASS	PASS	PASS	PASS	PASS	PASS	PASS

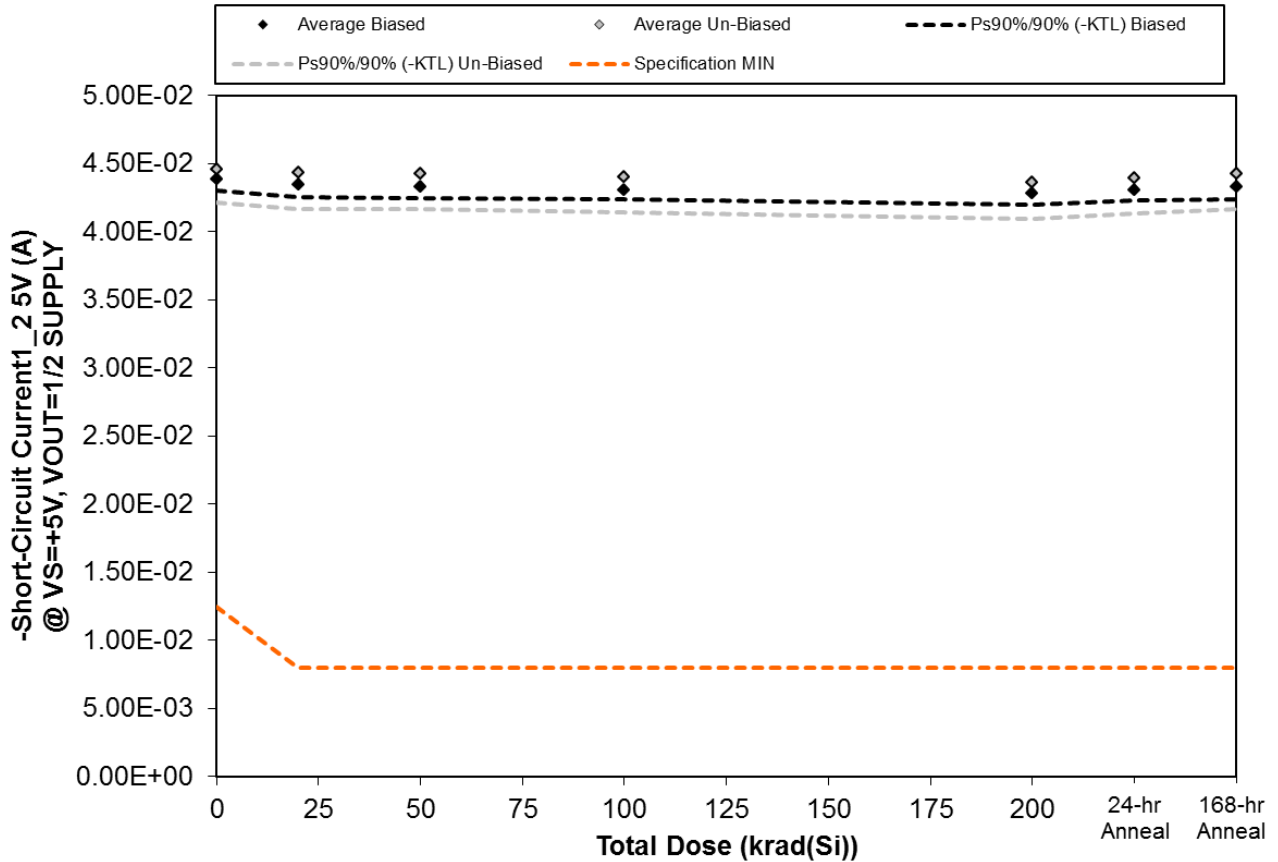

Figure 5.100. Plot of -Short-Circuit Current1_2 5V (A) @ VS=+5V, VOUT=1/2 SUPPLY versus total dose. The solid diamonds are the average of the measured data points for the samples irradiated under electrical bias while the shaded diamonds are the average of the measured data points for the samples irradiated with all pins tied to ground. The black lines (solid and/or dashed) are the upper and/or lower confidence limits, as determined by KTL statistics, on the samples irradiated under electrical bias while the gray lines (solid and/or dashed) are the upper and/or lower confidence limits, as determined by KTL statistics, on the samples irradiated in the unbiased condition. The red dotted line(s) are the pre- and/or post-irradiation minimum and/or maximum specification value as defined in the datasheet and/or test plan.



TID Report
15-0091 03/20/15 R1.0

Aeroflex RAD
5030 Centennial Blvd.
Colorado Springs, CO 80919
(719) 531-0800

Table 5.100. Raw data for -Short-Circuit Current1_2 5V (A) @ VS=+5V, VOUT=1/2 SUPPLY versus total dose, including the statistical analysis, specification and the status of the testing (pass/fail).

-Short-Circuit Current1_2 5V (A) @ VS=+5V, VOUT=1/2 SUPPLY	Total Dose (krad(Si))					24-hr	168-hr
	0	20	50	100	200	Anneal	Anneal
Device							
680	4.41E-02	4.38E-02	4.36E-02	4.32E-02	4.30E-02	4.34E-02	4.36E-02
681	4.36E-02	4.32E-02	4.31E-02	4.29E-02	4.27E-02	4.29E-02	4.30E-02
682	4.42E-02	4.38E-02	4.36E-02	4.34E-02	4.31E-02	4.34E-02	4.36E-02
683	4.38E-02	4.35E-02	4.33E-02	4.31E-02	4.28E-02	4.31E-02	4.33E-02
684	4.35E-02	4.31E-02	4.29E-02	4.27E-02	4.24E-02	4.27E-02	4.29E-02
685	4.42E-02	4.39E-02	4.38E-02	4.36E-02	4.32E-02	4.36E-02	4.38E-02
686	4.45E-02	4.44E-02	4.42E-02	4.40E-02	4.35E-02	4.38E-02	4.42E-02
688	4.61E-02	4.60E-02	4.59E-02	4.56E-02	4.53E-02	4.54E-02	4.58E-02
689	4.44E-02	4.43E-02	4.41E-02	4.38E-02	4.36E-02	4.37E-02	4.40E-02
690	4.38E-02	4.33E-02	4.33E-02	4.30E-02	4.27E-02	4.29E-02	4.33E-02
691	4.58E-02	4.57E-02	4.58E-02	4.57E-02	4.57E-02	4.59E-02	4.58E-02
692	4.36E-02	4.36E-02	4.36E-02	4.36E-02	4.36E-02	4.37E-02	4.36E-02
Biased Statistics							
Average Biased	4.38E-02	4.35E-02	4.33E-02	4.31E-02	4.28E-02	4.31E-02	4.33E-02
Std Dev Biased	3.05E-04	3.41E-04	3.21E-04	2.56E-04	2.91E-04	3.03E-04	3.31E-04
Ps90%/90% (+KTL) Biased	4.47E-02	4.44E-02	4.42E-02	4.38E-02	4.36E-02	4.39E-02	4.42E-02
Ps90%/90% (-KTL) Biased	4.30E-02	4.25E-02	4.24E-02	4.24E-02	4.20E-02	4.23E-02	4.24E-02
Un-Biased Statistics							
Average Un-Biased	4.46E-02	4.44E-02	4.43E-02	4.40E-02	4.36E-02	4.39E-02	4.42E-02
Std Dev Un-Biased	8.91E-04	9.94E-04	9.62E-04	9.55E-04	9.70E-04	9.27E-04	9.32E-04
Ps90%/90% (+KTL) Un-Biased	4.70E-02	4.71E-02	4.69E-02	4.66E-02	4.63E-02	4.64E-02	4.68E-02
Ps90%/90% (-KTL) Un-Biased	4.22E-02	4.16E-02	4.16E-02	4.14E-02	4.10E-02	4.14E-02	4.17E-02
Specification MIN	1.25E-02	8.00E-03	8.00E-03	8.00E-03	8.00E-03	8.00E-03	8.00E-03
Status	PASS	PASS	PASS	PASS	PASS	PASS	PASS

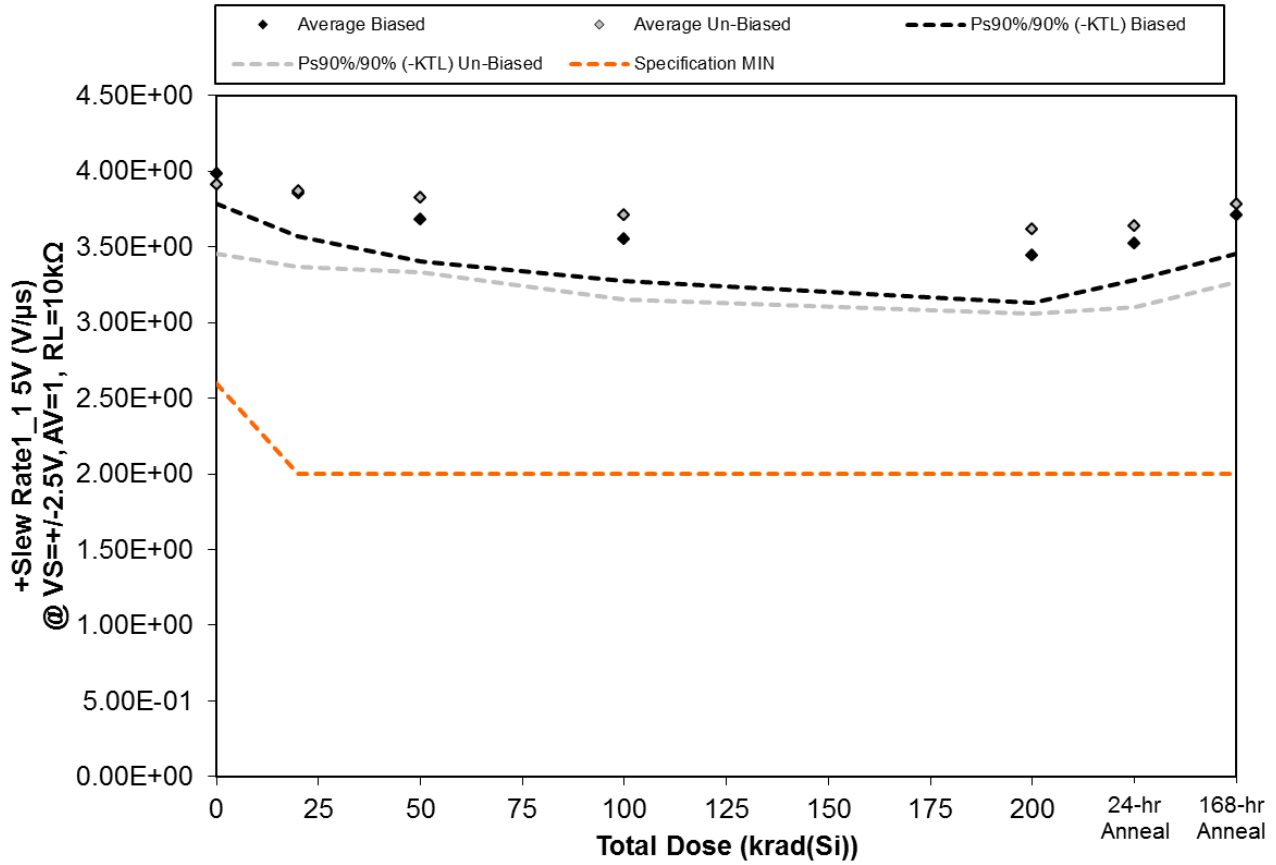

Figure 5.101. Plot of +Slew Rate1_1 5V (V/μs) @ VS=+/-2.5V, AV=1, RL=10kΩ versus total dose. The solid diamonds are the average of the measured data points for the samples irradiated under electrical bias while the shaded diamonds are the average of the measured data points for the samples irradiated with all pins tied to ground. The black lines (solid and/or dashed) are the upper and/or lower confidence limits, as determined by KTL statistics, on the samples irradiated under electrical bias while the gray lines (solid and/or dashed) are the upper and/or lower confidence limits, as determined by KTL statistics, on the samples irradiated in the unbiased condition. The red dotted line(s) are the pre- and/or post-irradiation minimum and/or maximum specification value as defined in the datasheet and/or test plan.



TID Report
15-0091 03/20/15 R1.0

Aeroflex RAD
5030 Centennial Blvd.
Colorado Springs, CO 80919
(719) 531-0800

Table 5.101. Raw data for +Slew Rate1_1 5V (V/μs) @ VS=+/-2.5V, AV=1, RL=10kΩ versus total dose, including the statistical analysis, specification and the status of the testing (pass/fail).

+Slew Rate1_1 5V (V/μs) @ VS=+/-2.5V, AV=1, RL=10kΩ	Total Dose (krad(Si))					24-hr	168-hr
	0	20	50	100	200	Anneal	Anneal
Device							
680	3.95E+00	3.79E+00	3.59E+00	3.46E+00	3.32E+00	3.43E+00	3.65E+00
681	3.92E+00	3.74E+00	3.57E+00	3.48E+00	3.37E+00	3.46E+00	3.60E+00
682	4.10E+00	4.00E+00	3.81E+00	3.70E+00	3.62E+00	3.63E+00	3.83E+00
683	3.95E+00	3.82E+00	3.69E+00	3.51E+00	3.43E+00	3.49E+00	3.69E+00
684	3.98E+00	3.90E+00	3.74E+00	3.60E+00	3.49E+00	3.60E+00	3.77E+00
685	3.79E+00	3.77E+00	3.71E+00	3.54E+00	3.47E+00	3.46E+00	3.62E+00
686	3.79E+00	3.74E+00	3.73E+00	3.60E+00	3.49E+00	3.57E+00	3.65E+00
688	4.20E+00	4.18E+00	4.14E+00	4.06E+00	3.97E+00	3.97E+00	4.09E+00
689	3.89E+00	3.79E+00	3.77E+00	3.67E+00	3.56E+00	3.57E+00	3.75E+00
690	3.90E+00	3.84E+00	3.76E+00	3.69E+00	3.60E+00	3.60E+00	3.78E+00
691	3.90E+00	3.94E+00	3.91E+00	3.87E+00	3.90E+00	3.90E+00	3.88E+00
692	3.87E+00	3.86E+00	3.90E+00	3.88E+00	3.88E+00	3.85E+00	3.89E+00
Biased Statistics							
Average Biased	3.98E+00	3.85E+00	3.68E+00	3.55E+00	3.45E+00	3.52E+00	3.71E+00
Std Dev Biased	7.04E-02	1.02E-01	1.01E-01	9.95E-02	1.16E-01	8.81E-02	9.23E-02
Ps90%/90% (+KTL) Biased	4.17E+00	4.13E+00	3.96E+00	3.82E+00	3.76E+00	3.76E+00	3.96E+00
Ps90%/90% (-KTL) Biased	3.79E+00	3.57E+00	3.40E+00	3.28E+00	3.13E+00	3.28E+00	3.45E+00
Un-Biased Statistics							
Average Un-Biased	3.91E+00	3.86E+00	3.82E+00	3.71E+00	3.62E+00	3.63E+00	3.78E+00
Std Dev Un-Biased	1.68E-01	1.80E-01	1.79E-01	2.03E-01	2.04E-01	1.95E-01	1.87E-01
Ps90%/90% (+KTL) Un-Biased	4.38E+00	4.36E+00	4.31E+00	4.27E+00	4.18E+00	4.17E+00	4.29E+00
Ps90%/90% (-KTL) Un-Biased	3.45E+00	3.37E+00	3.33E+00	3.15E+00	3.06E+00	3.10E+00	3.27E+00
Specification MIN	2.60E+00	2.00E+00	2.00E+00	2.00E+00	2.00E+00	2.00E+00	2.00E+00
Status	PASS	PASS	PASS	PASS	PASS	PASS	PASS

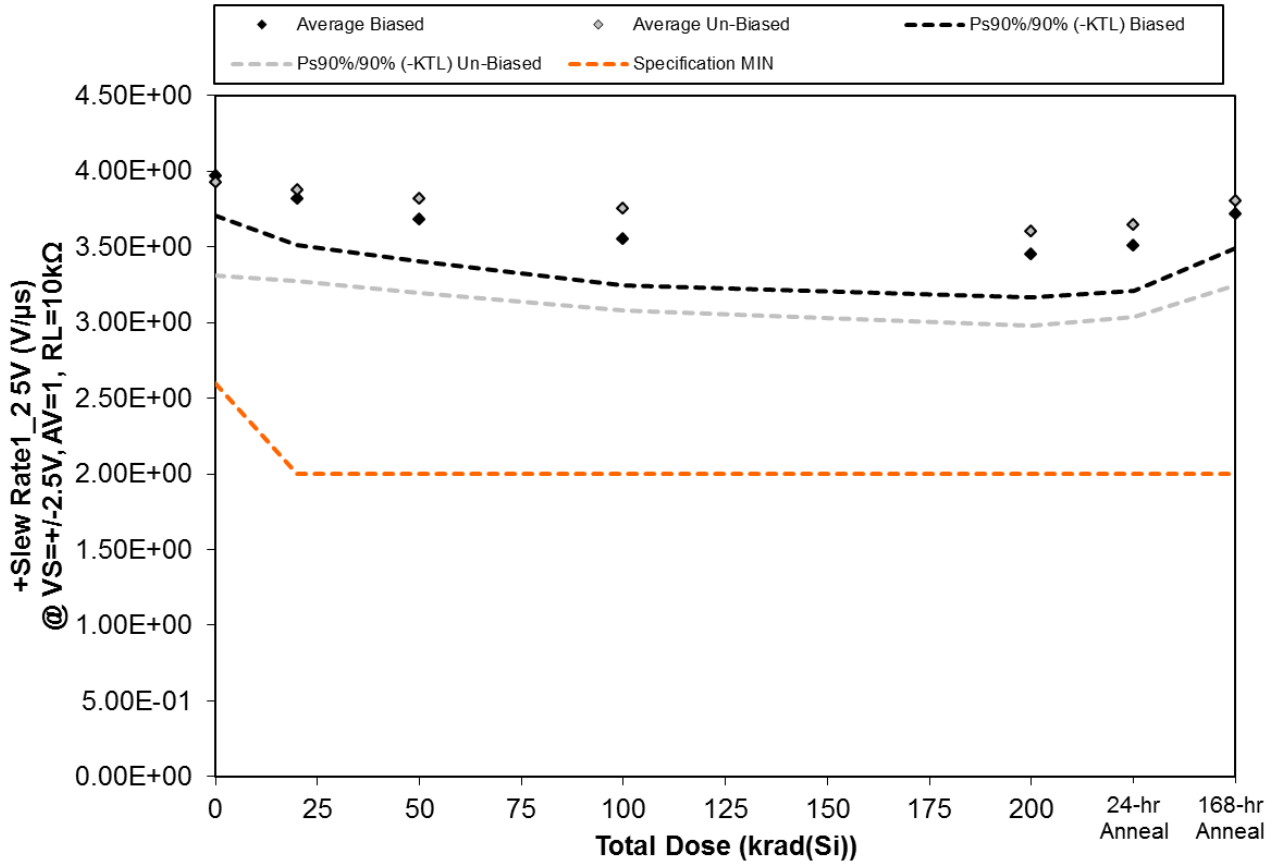

Figure 5.102. Plot of +Slew Rate1_2 5V (V/μs) @ VS=+/-2.5V, AV=1, RL=10kΩ versus total dose. The solid diamonds are the average of the measured data points for the samples irradiated under electrical bias while the shaded diamonds are the average of the measured data points for the samples irradiated with all pins tied to ground. The black lines (solid and/or dashed) are the upper and/or lower confidence limits, as determined by KTL statistics, on the samples irradiated under electrical bias while the gray lines (solid and/or dashed) are the upper and/or lower confidence limits, as determined by KTL statistics, on the samples irradiated in the unbiased condition. The red dotted line(s) are the pre- and/or post-irradiation minimum and/or maximum specification value as defined in the datasheet and/or test plan.



TID Report
15-0091 03/20/15 R1.0

Aeroflex RAD
5030 Centennial Blvd.
Colorado Springs, CO 80919
(719) 531-0800

Table 5.102. Raw data for +Slew Rate1_2 5V (V/μs) @ VS=+/-2.5V, AV=1, RL=10kΩ versus total dose, including the statistical analysis, specification and the status of the testing (pass/fail).

+Slew Rate1_2 5V (V/μs) @ VS=+/-2.5V, AV=1, RL=10kΩ	Total Dose (krad(Si))					24-hr Anneal	168-hr Anneal
	0	20	50	100	200		
Device							
680	3.92E+00	3.75E+00	3.56E+00	3.45E+00	3.38E+00	3.41E+00	3.69E+00
681	3.87E+00	3.73E+00	3.62E+00	3.48E+00	3.37E+00	3.45E+00	3.60E+00
682	4.10E+00	3.98E+00	3.82E+00	3.72E+00	3.58E+00	3.68E+00	3.82E+00
683	3.91E+00	3.74E+00	3.66E+00	3.50E+00	3.38E+00	3.45E+00	3.71E+00
684	4.03E+00	3.90E+00	3.74E+00	3.60E+00	3.55E+00	3.54E+00	3.77E+00
685	3.76E+00	3.66E+00	3.66E+00	3.57E+00	3.46E+00	3.52E+00	3.66E+00
686	3.81E+00	3.81E+00	3.73E+00	3.63E+00	3.49E+00	3.55E+00	3.72E+00
688	4.32E+00	4.24E+00	4.22E+00	4.18E+00	4.01E+00	4.04E+00	4.16E+00
689	3.84E+00	3.81E+00	3.72E+00	3.67E+00	3.54E+00	3.58E+00	3.74E+00
690	3.90E+00	3.84E+00	3.77E+00	3.71E+00	3.52E+00	3.54E+00	3.73E+00
691	3.89E+00	3.88E+00	3.86E+00	3.85E+00	3.87E+00	3.88E+00	3.85E+00
692	3.88E+00	3.90E+00	3.90E+00	3.90E+00	3.89E+00	3.93E+00	3.88E+00
Biased Statistics							
Average Biased	3.97E+00	3.82E+00	3.68E+00	3.55E+00	3.45E+00	3.51E+00	3.72E+00
Std Dev Biased	9.56E-02	1.13E-01	1.02E-01	1.10E-01	1.04E-01	1.08E-01	8.35E-02
Ps90%/90% (+KTL) Biased	4.23E+00	4.13E+00	3.96E+00	3.85E+00	3.74E+00	3.80E+00	3.95E+00
Ps90%/90% (-KTL) Biased	3.70E+00	3.51E+00	3.40E+00	3.25E+00	3.17E+00	3.21E+00	3.49E+00
Un-Biased Statistics							
Average Un-Biased	3.93E+00	3.87E+00	3.82E+00	3.75E+00	3.60E+00	3.65E+00	3.80E+00
Std Dev Un-Biased	2.26E-01	2.17E-01	2.27E-01	2.45E-01	2.29E-01	2.21E-01	2.03E-01
Ps90%/90% (+KTL) Un-Biased	4.55E+00	4.47E+00	4.44E+00	4.42E+00	4.23E+00	4.25E+00	4.36E+00
Ps90%/90% (-KTL) Un-Biased	3.31E+00	3.28E+00	3.20E+00	3.08E+00	2.98E+00	3.04E+00	3.25E+00
Specification MIN	2.60E+00	2.00E+00	2.00E+00	2.00E+00	2.00E+00	2.00E+00	2.00E+00
Status	PASS	PASS	PASS	PASS	PASS	PASS	PASS

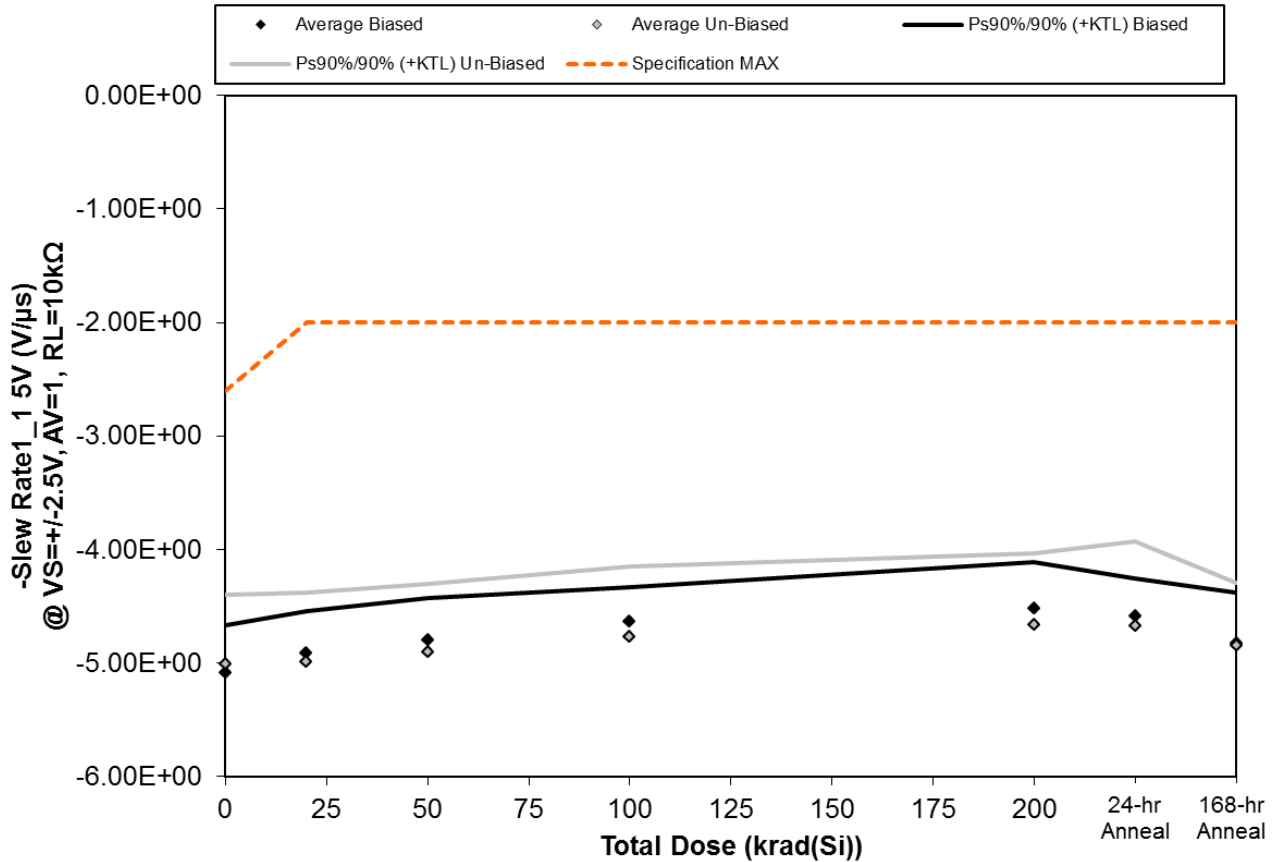

Figure 5.103. Plot of -Slew Rate1_1 5V (V/μs) @ VS=+/-2.5V, AV=1, RL=10kΩ versus total dose. The solid diamonds are the average of the measured data points for the samples irradiated under electrical bias while the shaded diamonds are the average of the measured data points for the samples irradiated with all pins tied to ground. The black lines (solid and/or dashed) are the upper and/or lower confidence limits, as determined by KTL statistics, on the samples irradiated under electrical bias while the gray lines (solid and/or dashed) are the upper and/or lower confidence limits, as determined by KTL statistics, on the samples irradiated in the unbiased condition. The red dotted line(s) are the pre- and/or post-irradiation minimum and/or maximum specification value as defined in the datasheet and/or test plan.



TID Report
15-0091 03/20/15 R1.0

Aeroflex RAD
5030 Centennial Blvd.
Colorado Springs, CO 80919
(719) 531-0800

Table 5.103. Raw data for -Slew Rate1_1 5V (V/μs) @ VS=+/-2.5V, AV=1, RL=10kΩ versus total dose, including the statistical analysis, specification and the status of the testing (pass/fail).

-Slew Rate1_1 5V (V/μs) @ VS=+/-2.5V, AV=1, RL=10kΩ	Total Dose (krad(Si))					24-hr	168-hr
	0	20	50	100	200	Anneal	Anneal
Device							
680	-5.06E+00	-4.91E+00	-4.77E+00	-4.57E+00	-4.39E+00	-4.49E+00	-4.69E+00
681	-4.94E+00	-4.75E+00	-4.68E+00	-4.56E+00	-4.39E+00	-4.45E+00	-4.71E+00
682	-5.33E+00	-5.12E+00	-5.02E+00	-4.81E+00	-4.75E+00	-4.75E+00	-5.08E+00
683	-4.99E+00	-4.87E+00	-4.80E+00	-4.55E+00	-4.50E+00	-4.59E+00	-4.75E+00
684	-5.08E+00	-4.91E+00	-4.71E+00	-4.69E+00	-4.56E+00	-4.63E+00	-4.88E+00
685	-4.80E+00	-4.81E+00	-4.69E+00	-4.56E+00	-4.54E+00	-4.42E+00	-4.67E+00
686	-4.87E+00	-4.84E+00	-4.77E+00	-4.67E+00	-4.48E+00	-4.53E+00	-4.76E+00
688	-5.34E+00	-5.36E+00	-5.25E+00	-5.15E+00	-5.05E+00	-5.12E+00	-5.18E+00
689	-4.90E+00	-4.93E+00	-4.83E+00	-4.70E+00	-4.63E+00	-4.59E+00	-4.75E+00
690	-5.12E+00	-5.00E+00	-4.96E+00	-4.78E+00	-4.59E+00	-4.68E+00	-4.86E+00
691	-5.06E+00	-5.05E+00	-5.04E+00	-5.04E+00	-5.06E+00	-5.10E+00	-5.10E+00
692	-4.99E+00	-5.08E+00	-5.06E+00	-5.03E+00	-5.03E+00	-4.97E+00	-5.04E+00
Biased Statistics							
Average Biased	-5.08E+00	-4.91E+00	-4.80E+00	-4.64E+00	-4.52E+00	-4.58E+00	-4.82E+00
Std Dev Biased	1.50E-01	1.33E-01	1.34E-01	1.13E-01	1.49E-01	1.19E-01	1.62E-01
Ps90%/90% (+KTL) Biased	-4.67E+00	-4.55E+00	-4.43E+00	-4.33E+00	-4.11E+00	-4.26E+00	-4.38E+00
Ps90%/90% (-KTL) Biased	-5.49E+00	-5.28E+00	-5.16E+00	-4.94E+00	-4.93E+00	-4.91E+00	-5.27E+00
Un-Biased Statistics							
Average Un-Biased	-5.01E+00	-4.99E+00	-4.90E+00	-4.77E+00	-4.66E+00	-4.67E+00	-4.84E+00
Std Dev Un-Biased	2.22E-01	2.21E-01	2.19E-01	2.26E-01	2.26E-01	2.70E-01	2.00E-01
Ps90%/90% (+KTL) Un-Biased	-4.40E+00	-4.38E+00	-4.30E+00	-4.15E+00	-4.04E+00	-3.93E+00	-4.30E+00
Ps90%/90% (-KTL) Un-Biased	-5.61E+00	-5.59E+00	-5.50E+00	-5.39E+00	-5.28E+00	-5.41E+00	-5.39E+00
Specification MAX	-2.60E+00	-2.00E+00	-2.00E+00	-2.00E+00	-2.00E+00	-2.00E+00	-2.00E+00
Status	PASS	PASS	PASS	PASS	PASS	PASS	PASS

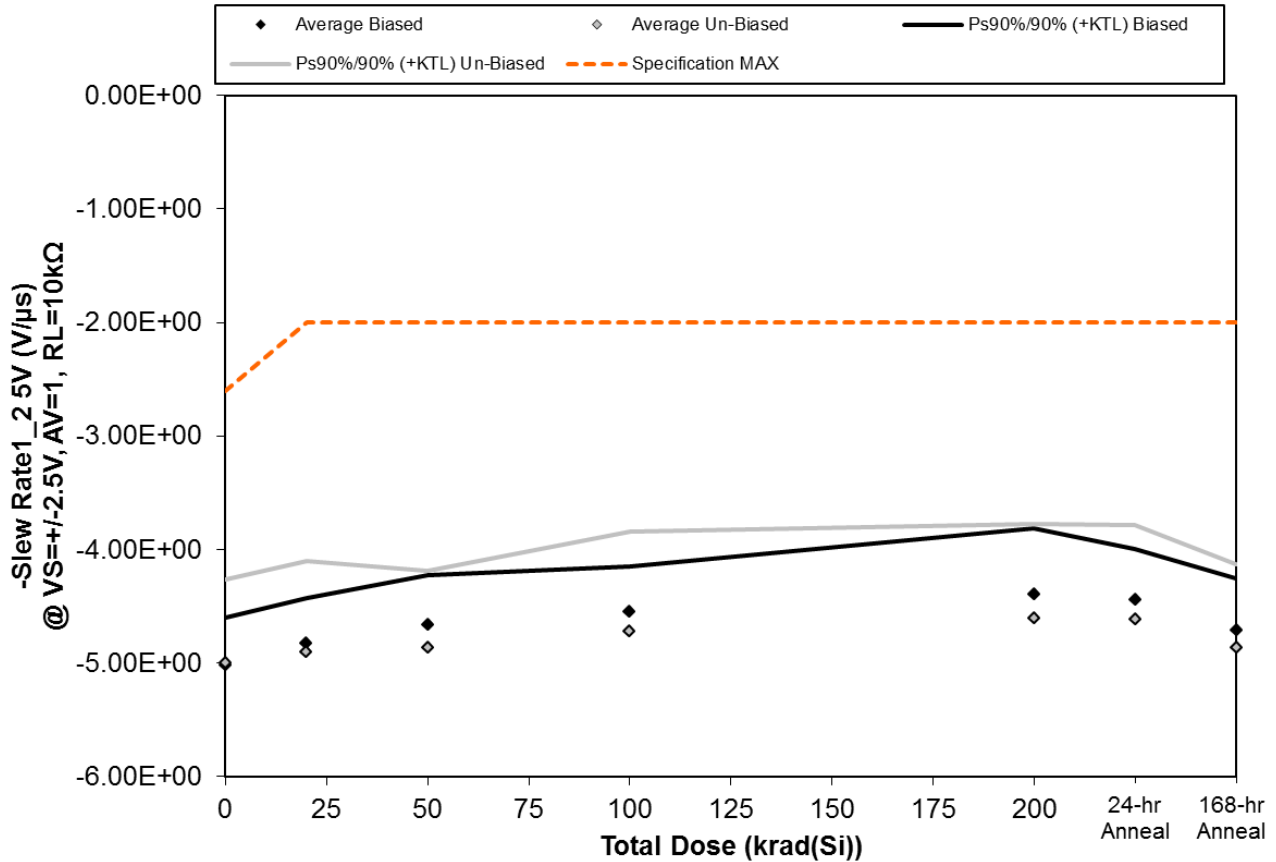

Figure 5.104. Plot of -Slew Rate1_2 5V (V/μs) @ VS=+/-2.5V, AV=1, RL=10kΩ versus total dose. The solid diamonds are the average of the measured data points for the samples irradiated under electrical bias while the shaded diamonds are the average of the measured data points for the samples irradiated with all pins tied to ground. The black lines (solid and/or dashed) are the upper and/or lower confidence limits, as determined by KTL statistics, on the samples irradiated under electrical bias while the gray lines (solid and/or dashed) are the upper and/or lower confidence limits, as determined by KTL statistics, on the samples irradiated in the unbiased condition. The red dotted line(s) are the pre- and/or post-irradiation minimum and/or maximum specification value as defined in the datasheet and/or test plan.



TID Report
15-0091 03/20/15 R1.0

Aeroflex RAD
5030 Centennial Blvd.
Colorado Springs, CO 80919
(719) 531-0800

Table 5.104. Raw data for -Slew Rate1_2 5V (V/μs) @ VS=+/-2.5V, AV=1, RL=10kΩ versus total dose, including the statistical analysis, specification and the status of the testing (pass/fail).

-Slew Rate1_2 5V (V/μs) @ VS=+/-2.5V, AV=1, RL=10kΩ	Total Dose (krad(Si))					24-hr	168-hr
	0	20	50	100	200	Anneal	Anneal
Device							
680	-4.90E+00	-4.70E+00	-4.55E+00	-4.37E+00	-4.15E+00	-4.26E+00	-4.57E+00
681	-4.88E+00	-4.74E+00	-4.54E+00	-4.44E+00	-4.27E+00	-4.32E+00	-4.62E+00
682	-5.24E+00	-5.01E+00	-4.93E+00	-4.72E+00	-4.66E+00	-4.66E+00	-4.98E+00
683	-4.96E+00	-4.72E+00	-4.60E+00	-4.55E+00	-4.34E+00	-4.42E+00	-4.62E+00
684	-5.10E+00	-4.94E+00	-4.71E+00	-4.66E+00	-4.57E+00	-4.54E+00	-4.75E+00
685	-4.77E+00	-4.71E+00	-4.69E+00	-4.46E+00	-4.49E+00	-4.40E+00	-4.67E+00
686	-4.87E+00	-4.72E+00	-4.68E+00	-4.64E+00	-4.46E+00	-4.45E+00	-4.71E+00
688	-5.46E+00	-5.40E+00	-5.29E+00	-5.28E+00	-5.14E+00	-5.14E+00	-5.32E+00
689	-4.93E+00	-4.75E+00	-4.81E+00	-4.55E+00	-4.44E+00	-4.54E+00	-4.75E+00
690	-4.98E+00	-4.92E+00	-4.86E+00	-4.69E+00	-4.47E+00	-4.52E+00	-4.86E+00
691	-4.89E+00	-4.95E+00	-4.95E+00	-4.94E+00	-4.91E+00	-4.92E+00	-4.95E+00
692	-4.95E+00	-4.98E+00	-4.91E+00	-4.95E+00	-4.96E+00	-5.00E+00	-4.95E+00
Biased Statistics							
Average Biased	-5.02E+00	-4.82E+00	-4.67E+00	-4.55E+00	-4.40E+00	-4.44E+00	-4.71E+00
Std Dev Biased	1.52E-01	1.43E-01	1.62E-01	1.46E-01	2.12E-01	1.62E-01	1.66E-01
Ps90%/90% (+KTL) Biased	-4.60E+00	-4.43E+00	-4.22E+00	-4.15E+00	-3.82E+00	-3.99E+00	-4.25E+00
Ps90%/90% (-KTL) Biased	-5.43E+00	-5.21E+00	-5.11E+00	-4.95E+00	-4.98E+00	-4.89E+00	-5.16E+00
Un-Biased Statistics							
Average Un-Biased	-5.00E+00	-4.90E+00	-4.87E+00	-4.72E+00	-4.60E+00	-4.61E+00	-4.86E+00
Std Dev Un-Biased	2.68E-01	2.92E-01	2.49E-01	3.23E-01	3.02E-01	3.01E-01	2.66E-01
Ps90%/90% (+KTL) Un-Biased	-4.27E+00	-4.10E+00	-4.18E+00	-3.84E+00	-3.77E+00	-3.78E+00	-4.13E+00
Ps90%/90% (-KTL) Un-Biased	-5.74E+00	-5.70E+00	-5.55E+00	-5.61E+00	-5.43E+00	-5.44E+00	-5.59E+00
Specification MAX	-2.60E+00	-2.00E+00	-2.00E+00	-2.00E+00	-2.00E+00	-2.00E+00	-2.00E+00
Status	PASS	PASS	PASS	PASS	PASS	PASS	PASS



6.0. Summary / Conclusions

The total ionizing dose testing described in this final report was performed using the facilities at Aeroflex RAD's Longmire Laboratories in Colorado Springs, CO. The high dose rate total ionizing dose (TID) source is a JLSA 81-24 irradiator modified to provide a panoramic exposure. The Co-60 rods are held in the base of the irradiator heavily shielded by lead, during the radiation exposures the rod is raised by an electronic timer/controller and the exposure is performed in air. The dose rate for this irradiator in this configuration ranges from <math><1\text{rad(Si)/s}</math> to a maximum of approximately

The parametric data was obtained as "read and record" and all the raw data plus an attributes summary are contained in this report as well as in a separate Excel file. The attributes data contains the average, standard deviation and the average with the KTL values applied. The KTL value used in this work is 2.742 per MIL-HDBK-814 using one sided tolerance limits of 90/90 and a 5-piece sample size. The 90/90 KTL values were selected to match the statistical levels specified in the MIL-PRF-38535 sampling plan for the qualification of a radiation hardness assured (RHA) component. Note that the following criteria must be met for a device to pass the total ionizing dose test: following the radiation exposure each of the 5 pieces irradiated under electrical bias shall pass the specification value. The units irradiated without electrical bias and the KTL statistics are included in this report for reference only. If any of the 5 pieces irradiated under electrical bias exceed the device post radiation data sheet specification limits, then the lot could be logged as a failure.

Based on this criterion the RH1498MW Dual Rail-to-Rail Input and Output Precision C-Load Op Amp (from the lot traceability information provided on the first page of this test report) the units-under-test:

- PASSED the total ionizing dose test to the - PASSED following 24-hour room temperature anneal
- PASSED following 168-hour



Appendix A: Photograph of Packing Label and a Sample Unit-Under-Test to Show Part Traceability

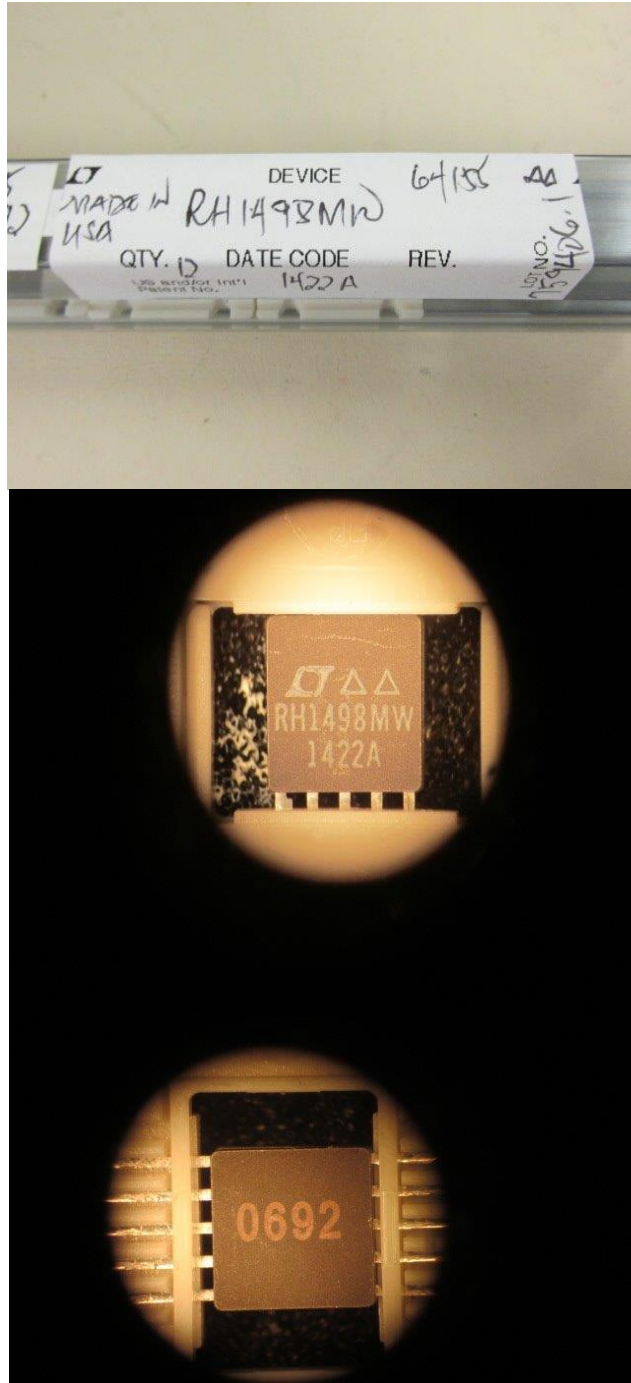

An ISO 9001:2008 and DLA Certified Company



Appendix B: Radiation Bias Connections and Absolute Maximum Ratings

TID Radiation Biased Conditions: Extracted from Linear Technology RH1498M Datasheet Revision F.

Pin	Function	Connection / Bias
1	OUTPUT A	To Pin 2 via 5kΩ & 40pF, in Parallel
2	-INPUT A	To Pin 1 via 5kΩ & 40pF, in Parallel
3	+INPUT A	To 8V via 5kΩ Resistor
4	NC	NC
5	V-	To -15V Decoupled to GND W/0.1μF
6	NC	NC
7	+INPUT B	To 8V via 5kΩ Resistor
8	-INPUT B	To Pin 9 via 5kΩ & 40pF, in Parallel
9	OUTPUT B	To Pin 8 via 5kΩ & 40pF, in Parallel
10	V+	To +15V Decoupled to GND W/0.1μF

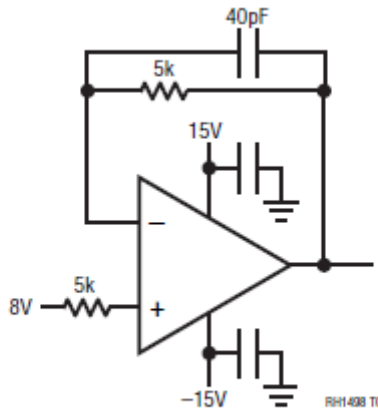

Figure B.1. Irradiation bias circuit. This figure was extracted from Linear Technology RH1498M Datasheet Revision F.



TID Radiation Unbiased Conditions: All pins grounded.

Pin	Function	Connection / Bias
1	OUTPUT A	GND
2	-INPUT A	GND
3	+INPUT A	GND
4	NC	GND
5	V-	GND
6	NC	GND
7	+INPUT B	GND
8	-INPUT B	GND
9	OUTPUT B	GND
10	V+	GND

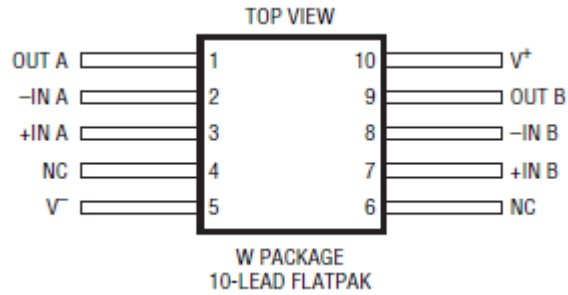

Figure B.2. W package drawing (for reference only). This figure was extracted from Linear Technology RH1498M Datasheet Revision F.

Absolute Maximum Ratings:

Parameter	Max Rating
Total Supply Voltage (V+ to V-)	36V
Input Current	±10mA
Output Short-Circuit Duration	Continuous



Appendix C: Electrical Test Parameters and Conditions

The expected ranges of values as well as the measurement conditions are taken from Linear Technology RH1498M Datasheet Revision F. All electrical tests for this device are performed on one of Aeroflex RAD's LTS2020 Test Systems. The LTS2020 Test System is a programmable parametric tester that provides parameter measurements for a variety of digital, analog and mixed signal products including voltage regulators, voltage comparators, D to A and A to D converters. The LTS2020 Test System achieves accuracy and sensitivity through the use of software self-calibration and an internal relay matrix with separate family boards and custom personality adapter boards. The tester uses this relay matrix to connect the required test circuits, select the appropriate voltage / current sources and establish the needed measurement loops for all the tests performed. The measured parameters and test conditions are shown in Table C.1.

A listing of the measurement precision/resolution for each parameter is shown in Table C.2. The precision/resolution values were obtained from test data or from the DAC resolution of the LTS-2020 for the particular test shown, whichever is greater. To generate the precision/resolution shown in Table C.2, one of the units-under-test was tested repetitively (a total of 10-times with re-insertion between tests) to obtain the average test value and standard deviation. Using this test data MIL-HDBK-814 90/90 KTL statistics were applied to the measured standard deviation to generate the final measurement range. This value encompasses the precision/resolution of all aspects of the test system, including the LTS2020 mainframe, family board, socket assembly and DUT board as well as insertion error. In some cases, the measurement resolution is limited by the internal DACs, which results in a measured standard deviation of zero. In these instances the precision/resolution will be reported back as the LSB of the DAC.

Note that the testing and statistics used in this document are based on an “analysis of variables” technique, which relies on small sample sizes to qualify much larger lot sizes (see MIL-HDBK-814, p. 91 for a discussion of statistical treatments). Not all measured parameters are well suited to this approach due to inherent large variations. If necessary, larger samples sizes could be used to qualify these parameters using an “attributes” approach.



Table C.1. Measured parameters and test conditions for the RH1498MW Dual Rail-to-Rail Input and Output Precision C-Load Op Amp.

Parameter	Symbol	Test Conditions
+Supply Current 15V (A)	+ICC_15V	VS=+/-15V
-Supply Current 15V (A)	-IEE_15V	VS=+/-15V
Input Offset Voltage1 15V (V)	VOS1 15V	VS=+/-15V, VCM=0V
Input Offset Current1 15V (A)	IOS1 15V	VS=+/-15V, VCM=0V
+Input Bias Current BIAS1 15V (A)	+IBIAS1 15V	VS=+/-15V, VCM=0V
-Input Bias Current BIAS1 15V (A)	-IBIAS1 15V	VS=+/-15V, VCM=0V
Input Offset Voltage2 15V (V)	VOS2 15V	VS=+/-15V, VCM=15V
Input Offset Current2 15V (A)	IOS2 15V	VS=+/-15V, VCM=15V
+Input Bias Current BIAS2 15V (A)	+IBIAS2 15V	VS=+/-15V, VCM=15V
-Input Bias Current BIAS2 15V (A)	-IBIAS2 15V	VS=+/-15V, VCM=15V
Input Offset Voltage3 15V (V)	VOS3 15V	VS=+/-15V, VCM=-15V
Input Offset Current3 15V (A)	IOS3 15V	VS=+/-15V, VCM=-15V
+Input Bias Current BIAS3 15V (A)	+IBIAS3 15V	VS=+/-15V, VCM=-15V
-Input Bias Current BIAS3 15V (A)	-IBIAS3 15V	VS=+/-15V, VCM=-15V
Output Voltage Swing High1 15V (V)	+VOUT1 15V	VS=+/-15V, IL=0mA
Output Voltage Swing High2 15V (V)	+VOUT2 15V	VS=+/-15V, IL=1mA
Output Voltage Swing High3 15V (V)	+VOUT3 15V	VS=+/-15V, IL=10mA
Output Voltage Swing Low1 15V (V)	-VOUT1 15V	VS=+/-15V, IL=0mA
Output Voltage Swing Low2 15V (V)	-VOUT2 15V	VS=+/-15V, IL=1mA
Output Voltage Swing Low3 15V (V)	-VOUT3 15V	VS=+/-15V, IL=10mA
Large Signal Voltage Gain1 15V (V/mV)	AVOL1 15V	VS=+/-15V, VO=+/-14.5V, RL=10kΩ
Large Signal Voltage Gain2 15V (V/mV)	AVOL2 15V	VS=+/-15V, VO=+/-10V, RL=2kΩ
Common Mode Rejection Ratio1 15V (dB)	CMRR1 15V	VS=+/-15V, VCM=+/-15V
CMRR Match1 15V (dB)	CMRR1 MATCH 15V	VS=+/-15V, VCM=+/-15V
Power Supply Rejection Ratio1 (dB)	PSRR1 15V	VS=+/-2V to +/-16V
PSRR Match1 15V (dB)	PSRR1 MATCH 15V	VS=+/-2V to +/-16V
+Short-Circuit Current1 15V (A)	+ISC1 15V	VS=+/-15V, VOUT=0V
-Short-Circuit Current1 15V (A)	-ISC1 15V	VS=+/-15V, VOUT=0V



TID Report
15-0091 03/20/15 R1.0

Aeroflex RAD
5030 Centennial Blvd.
Colorado Springs, CO 80919
(719) 531-0800

Gain-Bandwidth Product1 15V (MHz)	GBWP1 15V	VS=+/-15V, f=100kHz
+Slew Rate1 15V (V/μs)	+SR1 15V	VS=+/-15V, AV=1, RL=10kΩ
-Slew Rate1 15V (V/μs)	-SR1 15V	VS=+/-15V, AV=1, RL=10kΩ
+Supply Current 5V (A)	+ICC_5V	VS=+5V
-Supply Current 5V (A)	-IEE_5V	VS=+5V
Input Offset Voltage1 5V (V)	VOS1 5V	VS=+5V, VCM=0V
Input Offset Current1 5V (A)	IOS1 5V	VS=+5V, VCM=0V
+Input Bias Current BIAS1 5V (A)	+IBIAS1 5V	VS=+5V, VCM=0V
-Input Bias Current BIAS1 5V (A)	-IBIAS1 5V	VS=+5V, VCM=0V
Input Offset Voltage2 5V (V)	VOS2 5V	VS=+5V, VCM=5V
Input Offset Current2 5V (A)	IOS2 5V	VS=+5V, VCM=5V
+Input Bias Current BIAS2 5V (A)	+IBIAS2 5V	VS=+5V, VCM=5V
-Input Bias Current BIAS2 5V (A)	-IBIAS2 5V	VS=+5V, VCM=5V
Output Voltage Swing High1 5V (V)	+VOUT1 5V	VS=+5V, IL=0mA
Output Voltage Swing High2 5V (V)	+VOUT2 5V	VS=+5V, IL=1mA
Output Voltage Swing High3 5V (V)	+VOUT3 5V	VS=+5V, IL=2.5mA
Output Voltage Swing Low1 5V (V)	-VOUT1 5V	VS=+5V, IL=0mA
Output Voltage Swing Low2 5V (V)	-VOUT2 5V	VS=+5V, IL=1mA
Output Voltage Swing Low3 5V (V)	-VOUT3 5V	VS=+5V, IL=2.5mA
Large Signal Voltage Gain1 5V (V/mV)	AVOL1 5V	VS=+5V, VO=75mV TO 4.8V, RL=10kΩ
Common Mode Rejection Ratio1 5V (dB)	CMRR1 5V	VS=+5V, VCM=0 TO 5V
CMRR Match1 5V (dB)	CMRR1 MATCH 5V	VS=+5V
Power Supply Rejection Ratio1 5V (dB)	PSRR1 5V	VS=+4.5V TO +12V
PSRR Match1 5V (dB)	PSRR1 MATCH 5V	VS=+4.5V to +12V
+Short-Circuit Current1 5V (A)	+ISC1 5V	VS=+5V, VOUT=1/2 SUPPLY
-Short-Circuit Current1 5V (A)	-ISC1 5V	VS=+5V, VOUT=1/2 SUPPLY
+Slew Rate1 5V (V/μs)	+SR1 5V	VS=+/-2.5V, AV=1, RL=10kΩ
-Slew Rate1 5V (V/μs)	-SR1 5V	VS=+/-2.5V, AV=1, RL=10kΩ



Table C.2. Measured parameters, pre-irradiation specifications and measurement precision for the RH1498MW Dual Rail-to-Rail Input and Output Precision C-Load Op Amp.

Parameter	Pre-Irradiation Specification		Measurement Precision/Resolution
	MIN	MAX	
+Supply Current 15V (A)		5.00E-03	±5.05E-05
-Supply Current 15V (A)	-5.00E-03		±4.92E-05
Input Offset Voltage1 15V (V)	-8.00E-04	8.00E-04	±1.08E-05
Input Offset Current1 15V (A)	-7.00E-08	7.00E-08	±3.78E-10
+Input Bias Current1 15V (A)	-7.15E-07	7.15E-07	±4.85E-09
-Input Bias Current1 15V (A)	-7.15E-07	7.15E-07	±4.93E-09
Input Offset Voltage2 15V (V)	-8.00E-04	8.00E-04	±9.55E-06
Input Offset Current2 15V (A)	-7.00E-08	7.00E-08	±1.36E-09
+Input Bias Current2 15V (A)	-7.15E-07	7.15E-07	±4.01E-09
-Input Bias Current2 15V (A)	-7.15E-07	7.15E-07	±3.41E-09
Input Offset Voltage3 15V (V)	-8.00E-04	8.00E-04	±7.87E-06
Input Offset Current3 15V (A)	-7.00E-08	7.00E-08	±3.66E-10
+Input Bias Current3 15V (A)	-7.15E-07	7.15E-07	±3.60E-09
-Input Bias Current3 15V (A)	-7.15E-07	7.15E-07	±3.65E-09
Output Voltage Swing High1 15V (V)		1.00E-02	±1.38E-04
Output Voltage Swing High2 15V (V)		1.50E-01	±5.50E-04
Output Voltage Swing High3 15V (V)		8.00E-01	±1.89E-03
Output Voltage Swing Low1 15V (V)		3.00E-02	±3.92E-04
Output Voltage Swing Low2 15V (V)		1.00E-01	±5.38E-04
Output Voltage Swing Low3 15V (V)		5.00E-01	±1.65E-03
Large Signal Voltage Gain1 15V (V/mV)	1.00E+03		±2.19E+01%
Large Signal Voltage Gain2 15V (V/mV)	5.00E+02		±8.58E+00%
Common Mode Rejection Ratio1 15V (dB)	9.00E+01		±1.44E-01
CMRR Match1 15V (dB)	8.40E+01		±6.76E-01
Power Supply Rejection Ratio1 (dB)	9.00E+01		±3.29E-01
PSRR Match1 15V (dB)	8.30E+01		±1.74E-01
+Short-Circuit Current1 15V (A)		-1.50E-02	±1.31E-04



TID Report
15-0091 03/20/15 R1.0

Aeroflex RAD
5030 Centennial Blvd.
Colorado Springs, CO 80919
(719) 531-0800

-Short-Circuit Current1 15V (A)	1.50E-02		±1.81E-04
Gain-Bandwidth Product1 15V (MHz)	6.80E+00		±3.11E-02
+Slew Rate1 15V (V/μs)	3.50E+00		±1.34E-01
-Slew Rate1 15V (V/μs)		-3.50E+00	±1.01E-01
+Supply Current 5V (A)		4.40E-03	±2.59E-05
-Supply Current 5V (A)	-4.40E-03		±2.53E-05
Input Offset Voltage1 5V (V)	-8.00E-04	8.00E-04	±8.15E-06
Input Offset Current1 5V (A)	-6.50E-08	6.50E-08	±3.89E-10
+Input Bias Current1 5V (A)	-6.50E-07	6.50E-07	±3.03E-09
-Input Bias Current1 5V (A)	-6.50E-07	6.50E-07	±3.38E-09
Input Offset Voltage2 5V (V)	-8.00E-04	8.00E-04	±5.82E-06
Input Offset Current2 5V (A)	-6.50E-08	6.50E-08	±1.42E-09
+Input Bias Current2 5V (A)	-6.50E-07	6.50E-07	±2.92E-09
-Input Bias Current2 5V (A)	-6.50E-07	6.50E-07	±1.84E-09
Output Voltage Swing High1 5V (V)		1.00E-02	±1.05E-04
Output Voltage Swing High2 5V (V)		1.50E-01	±3.18E-04
Output Voltage Swing High3 5V (V)		2.50E-01	±7.39E-04
Output Voltage Swing Low1 5V (V)		3.00E-02	±2.74E-04
Output Voltage Swing Low2 5V (V)		1.00E-01	±5.19E-04
Output Voltage Swing Low3 5V (V)		2.00E-01	±4.21E-04
Large Signal Voltage Gain1 5V (V/mV)	6.00E+02		±7.28E+01%
Common Mode Rejection Ratio1 5V (dB)	7.60E+01		±1.96E-01
CMRR Match1 5V (dB)	7.50E+01		±7.17E-01
Power Supply Rejection Ratio1 5V (dB)	8.80E+01		±9.96E+00
PSRR Match1 5V (dB)	8.20E+01		±7.10E-01
+Short-Circuit Current1 5V (A)		-1.25E-02	±3.74E-05
-Short-Circuit Current1 5V (A)	1.25E-02		±1.32E-04
+Slew Rate1 5V(V/μs)	2.60E+00		±5.40E-02
-Slew Rate1 5V (V/μs)		-2.60E+00	±7.73E-02

An ISO 9001:2008 and DLA Certified Company



Appendix D: List of Figures Used in the Results Section (Section 5)

- 5.1. +Supply Current 15V (A) @ $V_S = \pm 15V$
- 5.2. -Supply Current 15V (A) @ $V_S = \pm 15V$
- 5.3. Input Offset Voltage1_1 15V (V) @ $V_S = \pm 15V$, $V_{CM} = 0V$
- 5.4. Input Offset Voltage1_2 15V (V) @ $V_S = \pm 15V$, $V_{CM} = 0V$
- 5.5. Input Offset Current1_1 15V (A) @ $V_S = \pm 15V$, $V_{CM} = 0V$
- 5.6. Input Offset Current1_2 15V (A) @ $V_S = \pm 15V$, $V_{CM} = 0V$
- 5.7. +Input Bias Current1_1 15V (A) @ $V_S = \pm 15V$, $V_{CM} = 0V$
- 5.8. +Input Bias Current1_2 15V (A) @ $V_S = \pm 15V$, $V_{CM} = 0V$
- 5.9. -Input Bias Current1_1 15V (A) @ $V_S = \pm 15V$, $V_{CM} = 0V$
- 5.10. -Input Bias Current1_2 15V (A) @ $V_S = \pm 15V$, $V_{CM} = 0V$
- 5.11. Input Offset Voltage2_1 15V (V) @ $V_S = \pm 15V$, $V_{CM} = 15V$
- 5.12. Input Offset Voltage2_2 15V (V) @ $V_S = \pm 15V$, $V_{CM} = 15V$
- 5.13. Input Offset Current2_1 15V (A) @ $V_S = \pm 15V$, $V_{CM} = 15V$
- 5.14. Input Offset Current2_2 15V (A) @ $V_S = \pm 15V$, $V_{CM} = 15V$
- 5.15. +Input Bias Current2_1 15V (A) @ $V_S = \pm 15V$, $V_{CM} = 15V$
- 5.16. +Input Bias Current2_2 15V (A) @ $V_S = \pm 15V$, $V_{CM} = 15V$
- 5.17. -Input Bias Current2_1 15V (A) @ $V_S = \pm 15V$, $V_{CM} = 15V$
- 5.18. -Input Bias Current2_2 15V (A) @ $V_S = \pm 15V$, $V_{CM} = 15V$
- 5.19. Input Offset Voltage3_1 15V (V) @ $V_S = \pm 15V$, $V_{CM} = -15V$
- 5.20. Input Offset Voltage3_2 15V (V) @ $V_S = \pm 15V$, $V_{CM} = -15V$
- 5.21. Input Offset Current3_1 15V (A) @ $V_S = \pm 15V$, $V_{CM} = -15V$
- 5.22. Input Offset Current3_2 15V (A) @ $V_S = \pm 15V$, $V_{CM} = -15V$
- 5.23. +Input Bias Current3_1 15V (A) @ $V_S = \pm 15V$, $V_{CM} = -15V$
- 5.24. +Input Bias Current3_2 15V (A) @ $V_S = \pm 15V$, $V_{CM} = -15V$
- 5.25. -Input Bias Current3_1 15V (A) @ $V_S = \pm 15V$, $V_{CM} = -15V$
- 5.26. -Input Bias Current3_2 15V (A) @ $V_S = \pm 15V$, $V_{CM} = -15V$
- 5.27. Output Voltage Swing High1_1 15V (V) @ $V_S = \pm 15V$, $I_L = 0mA$
- 5.28. Output Voltage Swing High1_2 15V (V) @ $V_S = \pm 15V$, $I_L = 0mA$
- 5.29. Output Voltage Swing High2_1 15V (V) @ $V_S = \pm 15V$, $I_L = 1mA$
- 5.30. Output Voltage Swing High2_2 15V (V) @ $V_S = \pm 15V$, $I_L = 1mA$
- 5.31. Output Voltage Swing High3_1 15V (V) @ $V_S = \pm 15V$, $I_L = 10mA$
- 5.32. Output Voltage Swing High3_2 15V (V) @ $V_S = \pm 15V$, $I_L = 10mA$
- 5.33. Output Voltage Swing Low1_1 15V (V) @ $V_S = \pm 15V$, $I_L = 0mA$
- 5.34. Output Voltage Swing Low1_2 15V (V) @ $V_S = \pm 15V$, $I_L = 0mA$
- 5.35. Output Voltage Swing Low2_1 15V (V) @ $V_S = \pm 15V$, $I_L = 1mA$
- 5.36. Output Voltage Swing Low2_2 15V (V) @ $V_S = \pm 15V$, $I_L = 1mA$
- 5.37. Output Voltage Swing Low3_1 15V (V) @ $V_S = \pm 15V$, $I_L = 10mA$
- 5.38. Output Voltage Swing Low3_2 15V (V) @ $V_S = \pm 15V$, $I_L = 10mA$
- 5.39. Large Signal Voltage Gain1_1 15V (V/mV) @ $V_S = \pm 15V$, $V_O = \pm 14.5V$, $R_L = 10k\Omega$
- 5.40. Large Signal Voltage Gain1_2 15V (V/mV) @ $V_S = \pm 15V$, $V_O = \pm 14.5V$, $R_L = 10k\Omega$



- 5.41. Large Signal Voltage Gain2_1 15V (V/mV) @ $V_S=+/-15V$, $V_O=+/-10V$, $R_L=2k\Omega$
- 5.42. Large Signal Voltage Gain2_2 15V (V/mV) @ $V_S=+/-15V$, $V_O=+/-10V$, $R_L=2k\Omega$
- 5.43. Common Mode Rejection Ratio1_1 15V (dB) @ $V_S=+/-15V$, $V_{CM}=+/-15V$
- 5.44. Common Mode Rejection Ratio1_2 15V (dB) @ $V_S=+/-15V$, $V_{CM}=+/-15V$
- 5.45. CMRR Match1 15V (dB) @ $V_S=+/-15V$, $V_{CM}=+/-15V$
- 5.46. Power Supply Rejection Ratio1_1 (dB) @ $V_S=+/-2V$ to $+/-16V$
- 5.47. Power Supply Rejection Ratio1_2 (dB) @ $V_S=+/-2V$ to $+/-16V$
- 5.48. PSRR Match1 15V (dB) @ $V_S=+/-2V$ to $+/-16V$
- 5.49. +Short-Circuit Current1_1 15V (A) @ $V_S=+/-15V$, $V_{OUT}=0V$
- 5.50. +Short-Circuit Current1_2 15V (A) @ $V_S=+/-15V$, $V_{OUT}=0V$
- 5.51. -Short-Circuit Current1_1 15V (A) @ $V_S=+/-15V$, $V_{OUT}=0V$
- 5.52. -Short-Circuit Current1_2 15V (A) @ $V_S=+/-15V$, $V_{OUT}=0V$
- 5.53. Gain-Bandwidth Product1_1 15V (MHz) @ $V_S=+/-15V$, $f=100kHz$
- 5.54. Gain-Bandwidth Product1_2 15V (MHz) @ $V_S=+/-15V$, $f=100kHz$
- 5.55. +Slew Rate1_1 15V (V/ μs) @ $V_S=+/-15V$, $A_V=1$, $R_L=10k\Omega$
- 5.56. +Slew Rate1_2 15V (V/ μs) @ $V_S=+/-15V$, $A_V=1$, $R_L=10k\Omega$
- 5.57. -Slew Rate1_1 15V (V/ μs) @ $V_S=+/-15V$, $A_V=1$, $R_L=10k\Omega$
- 5.58. -Slew Rate1_2 15V (V/ μs) @ $V_S=+/-15V$, $A_V=1$, $R_L=10k\Omega$
- 5.59. +Supply Current 5V (A) @ $V_S=+5V$
- 5.60. -Supply Current 5V (A) @ $V_S=+5V$
- 5.61. Input Offset Voltage1_1 5V (V) @ $V_S=+5V$, $V_{CM}=0V$
- 5.62. Input Offset Voltage1_2 5V (V) @ $V_S=+5V$, $V_{CM}=0V$
- 5.63. Input Offset Current1_1 5V (A) @ $V_S=+5V$, $V_{CM}=0V$
- 5.64. Input Offset Current1_2 5V (A) @ $V_S=+5V$, $V_{CM}=0V$
- 5.65. +Input Bias Current1_1 5V (A) @ $V_S=+5V$, $V_{CM}=0V$
- 5.66. +Input Bias Current1_2 5V (A) @ $V_S=+5V$, $V_{CM}=0V$
- 5.67. -Input Bias Current1_1 5V (A) @ $V_S=+5V$, $V_{CM}=0V$
- 5.68. -Input Bias Current1_2 5V (A) @ $V_S=+5V$, $V_{CM}=0V$
- 5.69. Input Offset Voltage2_1 5V (V) @ $V_S=+5V$, $V_{CM}=5V$
- 5.70. Input Offset Voltage2_2 5V (V) @ $V_S=+5V$, $V_{CM}=5V$
- 5.71. Input Offset Current2_1 5V (A) @ $V_S=+5V$, $V_{CM}=5V$
- 5.72. Input Offset Current2_2 5V (A) @ $V_S=+5V$, $V_{CM}=5V$
- 5.73. +Input Bias Current2_1 5V (A) @ $V_S=+5V$, $V_{CM}=5V$
- 5.74. +Input Bias Current2_2 5V (A) @ $V_S=+5V$, $V_{CM}=5V$
- 5.75. -Input Bias Current2_1 5V (A) @ $V_S=+5V$, $V_{CM}=5V$
- 5.76. -Input Bias Current2_2 5V (A) @ $V_S=+5V$, $V_{CM}=5V$
- 5.77. Output Voltage Swing High1_1 5V (V) @ $V_S=+5V$, $I_L=0mA$
- 5.78. Output Voltage Swing High1_2 5V (V) @ $V_S=+5V$, $I_L=0mA$
- 5.79. Output Voltage Swing High2_1 5V (V) @ $V_S=+5V$, $I_L=1mA$
- 5.80. Output Voltage Swing High2_2 5V (V) @ $V_S=+5V$, $I_L=1mA$
- 5.81. Output Voltage Swing High3_1 5V (V) @ $V_S=+5V$, $I_L=2.5mA$
- 5.82. Output Voltage Swing High3_2 5V (V) @ $V_S=+5V$, $I_L=2.5mA$



TID Report
15-0091 03/20/15 R1.0

Aeroflex RAD
5030 Centennial Blvd.
Colorado Springs, CO 80919
(719) 531-0800

- 5.83. Output Voltage Swing Low1_1 5V (V) @ VS=+5V, IL=0mA
- 5.84. Output Voltage Swing Low1_2 5V (V) @ VS=+5V, IL=0mA
- 5.85. Output Voltage Swing Low2_1 5V (V) @ VS=+5V, IL=1mA
- 5.86. Output Voltage Swing Low2_2 5V (V) @ VS=+5V, IL=1mA
- 5.87. Output Voltage Swing Low3_1 5V (V) @ VS=+5V, IL=2.5mA
- 5.88. Output Voltage Swing Low3_2 5V (V) @ VS=+5V, IL=2.5mA
- 5.89. Large Signal Voltage Gain1_1 5V (V/mV) @ VS=+5V, VO=75mV TO 4.8V, RL=10kΩ
- 5.90. Large Signal Voltage Gain1_2 5V (V/mV) @ VS=+5V, VO=75mV TO 4.8V, RL=10kΩ
- 5.91. Common Mode Rejection Ratio1_1 5V (dB) @ VS=+5V, VCM=0 TO 5V
- 5.92. Common Mode Rejection Ratio1_2 5V (dB) @ VS=+5V, VCM=0 TO 5V
- 5.93. CMRR Match1 5V (dB) @ VS=+5V
- 5.94. Power Supply Rejection Ratio1_1 5V (dB) @ VS=+4.5V TO +12V
- 5.95. Power Supply Rejection Ratio1_2 5V (dB) @ VS=+4.5V TO +12V
- 5.96. PSRR Match1 5V (dB) @ VS=+4.5V to +12V
- 5.97. +Short-Circuit Current1_1 5V (A) @ VS=+5V, VOUT=1/2 SUPPLY
- 5.98. +Short-Circuit Current1_2 5V (A) @ VS=+5V, VOUT=1/2 SUPPLY
- 5.99. -Short-Circuit Current1_1 5V (A) @ VS=+5V, VOUT=1/2 SUPPLY
- 5.100. -Short-Circuit Current1_2 5V (A) @ VS=+5V, VOUT=1/2 SUPPLY
- 5.101. +Slew Rate1_1 5V (V/μs) @ VS=+/-2.5V, AV=1, RL=10kΩ
- 5.102. +Slew Rate1_2 5V (V/μs) @ VS=+/-2.5V, AV=1, RL=10kΩ
- 5.103. -Slew Rate1_1 5V (V/μs) @ VS=+/-2.5V, AV=1, RL=10kΩ
- 5.104. -Slew Rate1_2 5V (V/μs) @ VS=+/-2.5V, AV=1, RL=10kΩ