



Radiation Lot Acceptance Testing (RLAT) of the RH1814MW Quad Op Amp for Linear Technology

Customer: Linear Technology (PO 56741L)

RAD Job Number: 10-326

Part Type Tested: Linear Technology RH1814MW Quad Op Amp

Commercial Part Number: RH1814MW

Traceability Information: Fab Lot# WF001929, Wafer 6, Assembly Lot# 558858.1. Information obtained from Linear Technology PO#56741L. Date code marking on the package is 1004A, see Appendix A for a photograph of the device and part markings.

Quantity of Units: 12 units total, 10 units for biased irradiation and 2 control units. Serial numbers 1245 to 1251, 1261 to 1263 were biased during irradiation. Serial numbers 1264 and 1265 were used as controls. See Appendix B for the radiation bias connection table.

Pre-Irradiation Burn-In: Burn-In performed by Linear Technology prior to receipt by RAD.

TID Dose Rate and Test Increments: 50-300rad(Si)/s with readings at pre-irradiation, 10, 20, 30, 40, 50, 60, 70, 75, 100, and 200krad(Si).

TID Overtest and Post-Irradiation Anneal: No overttest or anneal.

TID Test Standard: MIL-STD-883G, Method 1019.7, Condition A

TID Electrical Test Conditions: Pre-irradiation, and within one hour following each radiation exposure.

Test Programs: RH1814W.SRC

Test Hardware: LTS2020 Tester, 2101 Family Board, 0600 Fixture, and RH1814W BGSS-080826 DUT Board.

Facility and Radiation Source: Radiation Assured Devices Longmire Laboratories, Colorado Springs, CO using the JLSA 81-24 high dose rate Co60 source. Dosimetry performed by CaF₂ TLDs traceable to NIST. RAD's dosimetry has been audited by DSCC and RAD has been awarded Laboratory Suitability for MIL-STD-750 TM 1019.5.

Irradiation and Test Temperature: Ambient room temperature for irradiation and test controlled to 24°C±6°C per MIL-STD-883.

RLAT Result: PASSED. The units showed no significant degradation with total dose. All parameters remained within their datasheet specifications to the maximum dose level tested of 200krad(Si)



1.0. Overview and Background

It is well known that total dose ionizing radiation can cause parametric degradation and ultimately functional failure in electronic devices. The damage occurs via electron-hole pair production, transport and trapping in the dielectric and interface regions. In discrete devices the bulk of the damage is frequently manifested as a reduction in the gain and/or breakdown voltage of the device. The damage will usually anneal with time following the end of the radiation exposure. Due to this annealing, and to ensure a worst-case test condition MIL-STD-883 TM1019.7 calls out a dose rate of 50 to 300rad(Si)/s as Condition A and further specifies that the time from the end of an incremental radiation exposure and electrical testing shall be 1-hour or less and the total time from the end of one incremental irradiation to the beginning of the next incremental radiation step should be 2-hours or less. The work described in this report was performed to meet MIL-STD-883 TM1019.7 Condition A.

2.0. Radiation Test Apparatus

The total ionizing dose testing described in this final report was performed using the facilities at Radiation Assured Devices' Longmire Laboratories in Colorado Springs, CO. The high dose rate total ionizing dose (TID) source is a JLSA 84-21 irradiator modified to provide a panoramic exposure. The Co-60 rods are held in the base of the irradiator heavily shielded by lead, during the radiation exposures the rod is raised by an electronic timer/controller and the exposure is performed in air. The dose rate for this irradiator in this configuration ranges from <1rad(Si)/s to a maximum of approximately 120rad(Si)/s, determined by the distance from the source. For high-dose rate experiments the bias boards are placed in a radial fashion equidistant from the raised Co-60 rods with the distance adjusted to provide the required dose rate. The irradiator calibration is maintained by Radiation Assured Devices Longmire Laboratories using thermoluminescent dosimeters (TLDs) traceable to the National Institute of Standards and Technology (NIST). Figure 2.1 shows a photograph of the JLSA 81-24 Co-60 irradiator at RAD's Longmire Laboratory facility.

RAD is currently certified by the Defense Supply Center Columbus (DSCC) for Laboratory Suitability under MIL STD 750. Additional details regarding Radiation Assured Devices dosimetry for TM1019 Condition A testing are available in RAD's report to DSCC entitled: "Dose Rate Mapping of the J.L. Shepherd and Associates Model 81 Irradiator Installed by Radiation Assured Devices"



Figure 2.1. Radiation Assured Devices' high dose rate Co-60 irradiator. The dose rate is obtained by positioning the device-under-test at a fixed distance from the gamma cell. The dose rate for this irradiator varies from approximately 120rad(Si)/s close to the rods down to 1rad(Si)/s at a distance of approximately 2-feet.



3.0. Radiation Test Conditions

The RH1814MW Quad Op Amp described in this final report were irradiated using a split 5V supply that is biased, which has been shown to be the worst-case bias condition for these units. See the TID Bias Table in Appendix B for the full bias circuits. In our opinion, this bias circuit satisfies the requirements of MIL-STD-883G TM1019.7 Section 3.9.3 Bias and Loading Conditions which states “The bias applied to the test devices shall be selected to produce the greatest radiation induced damage or the worst-case damage for the intended application, if known. While maximum voltage is often worst case some bipolar linear device parameters (e.g. input bias current or maximum output load current) exhibit more degradation with 0 V bias.” Note that the determination of pass / fail for this lot is based on the response of the biased units only.

The devices were irradiated to a maximum total ionizing dose level of 200krad(Si) with incremental readings at 10, 20, 30, 40, 50, 60, 70, 75 and 100krad(Si). Electrical testing occurred within one hour following the end of each irradiation segment. For intermediate irradiations, the parts were tested and returned to total dose exposure within two hours from the end of the previous radiation increment.

The TID bias board was positioned in the Co-60 cell to provide the required minimum of 50rad(Si)/s and was located inside a lead-aluminum enclosure. The lead-aluminum enclosure is required under MIL-STD-883G TM1019.7 Section 3.4 that reads as follows: “Lead/Aluminum (Pb/Al) container. Test specimens shall be enclosed in a Pb/Al container to minimize dose enhancement effects caused by low-energy, scattered radiation. A minimum of 1.5 mm Pb, surrounding an inner shield of at least 0.7 mm Al, is required. This Pb/Al container produces an approximate charged particle equilibrium for Si and for TLDs such as CaF₂. The radiation field intensity shall be measured inside the Pb/Al container (1) initially, (2) when the source is changed, or (3) when the orientation or configuration of the source, container, or test-fixture is changed. This measurement shall be performed by placing a dosimeter (e.g., a TLD) in the device-irradiation container at the approximate test-device position. If it can be demonstrated that low energy scattered radiation is small enough that it will not cause dosimetry errors due to dose enhancement, the Pb/Al container may be omitted”.

The final dose rate within the high dose rate lead-aluminum enclosure was determined based on TLD dosimetry measurements (see previous section). The final dose rate for this work was 50.5rad(Si)/s with a precision of $\pm 5\%$.



4.0. Tested Parameters

During the radiation lot acceptance testing the following pre- and post-irradiation electrical parameters were measured:

1. Positive Supply Current
2. Negative Supply Current
3. Input Offset Voltage (Op Amp 1-4)
4. Input Offset Current (Op Amp 1-4)
5. + Input Bias Current (Op Amp 1-4)
6. - Input Bias Current (Op Amp 1-4)
7. CMRR (Op Amp 1-4)
8. PSRR (Op Amp 1-4)
9. Large Signal Voltage Gain RL=500 (Op Amp 1-4)
10. Large Signal Voltage Gain RL=100 (Op Amp 1-4)
11. Channel Separation (Op Amp 1-4, all permutations)
12. Output Voltage Swing High RL=500 (Op Amp 1-4)
13. Output Voltage Swing High RL=100 (Op Amp 1-4)
14. Output Voltage Swing Low RL=500 (Op Amp 1-4)
15. Output Voltage Swing Low RL=100 (Op Amp 1-4)
16. Maximum Output Source Current (Op Amp 1-4)
17. Maximum Output Sink Current (Op Amp 1-4)
18. Positive Short-Circuit Current (Op Amp 1-4)
19. Negative Short-Circuit Current (Op Amp 1-4)

The parametric data was obtained as read and record and all the raw data plus an attributes summary are contained in a separate Excel file. The attributes data contains the average, standard deviation and the average with the KTL values applied. The KTL value used in this work is 2.065 per MIL-HDBK-814 using one sided tolerance limits of 90/90 and a 10-piece sample size. The 90/90 KTL values were selected to match the statistical levels specified in the MIL-PRF-38535 sampling plan for the qualification of a radiation hardness assured (RHA) component. Note that the following criteria must be met for a device to pass the RLAT: following the radiation exposure each of the 10 pieces irradiated under electrical bias shall pass the specification value. If any of the 10 pieces irradiated under electrical bias exceed the datasheet specifications, then the lot could be logged as a failure.



5.0. Total Ionizing Dose Test Results

Based on this criterion the RH1814MW QUAD OP AMP (from the lot date code identified on the first page of this test report) PASSED the RLAT to the maximum tested dose level of 200krad(Si) with all parameters remaining within their datasheet specifications. The data shown in this report uses much finer dose increments at the low dose levels to better understand the low total dose performance. In previous tests (with larger dose increments) we have observed degradation of selected V_{OS} , CMRR and PSRR parameters with the units improving with total dose, passing at the 100krad(Si) and 200krad(Si) dose levels. It appears that using relatively large dose increments can cause a low total dose “failure” possible due to a slightly different radiation response of matching of OpAmp input transistors. The LT1814 datasheet p.12 "Circuit Operation" discussion describes complementary NPN and PNP emitter followers buffering input transistors. Uneven gamma-induced degradation of the various input transistors could produce large voltage offsets, possibly recovering after significant charge saturation in the oxides. Figures 5.1 through 5.152 show plots of all the measured parameters versus total ionizing dose while Tables 5.1 – 5.152 show the corresponding raw data for each of these parameters.

In the data plots the solid diamonds are the average of the measured data points for the sample irradiated under electrical bias while the shaded diamonds are the average of the measured data points for the units irradiated with all pins tied to ground. The black lines (solid or dashed) are the average of the data points after application of the KTL statistics on the sample irradiated in the biased condition while the shaded lines (solid or dashed) are the average of the data points after application of the KTL statistics on the sample irradiated in the unbiased condition. The red dotted line(s) are the pre- and/or post-irradiation minimum and/or maximum specification value as defined in the datasheet and/or test plan.

The control units, as expected, show no significant changes to any of the parameters. Therefore we can conclude that the electrical testing remained in control throughout the duration of the tests and the observed degradation was due to the radiation exposure.

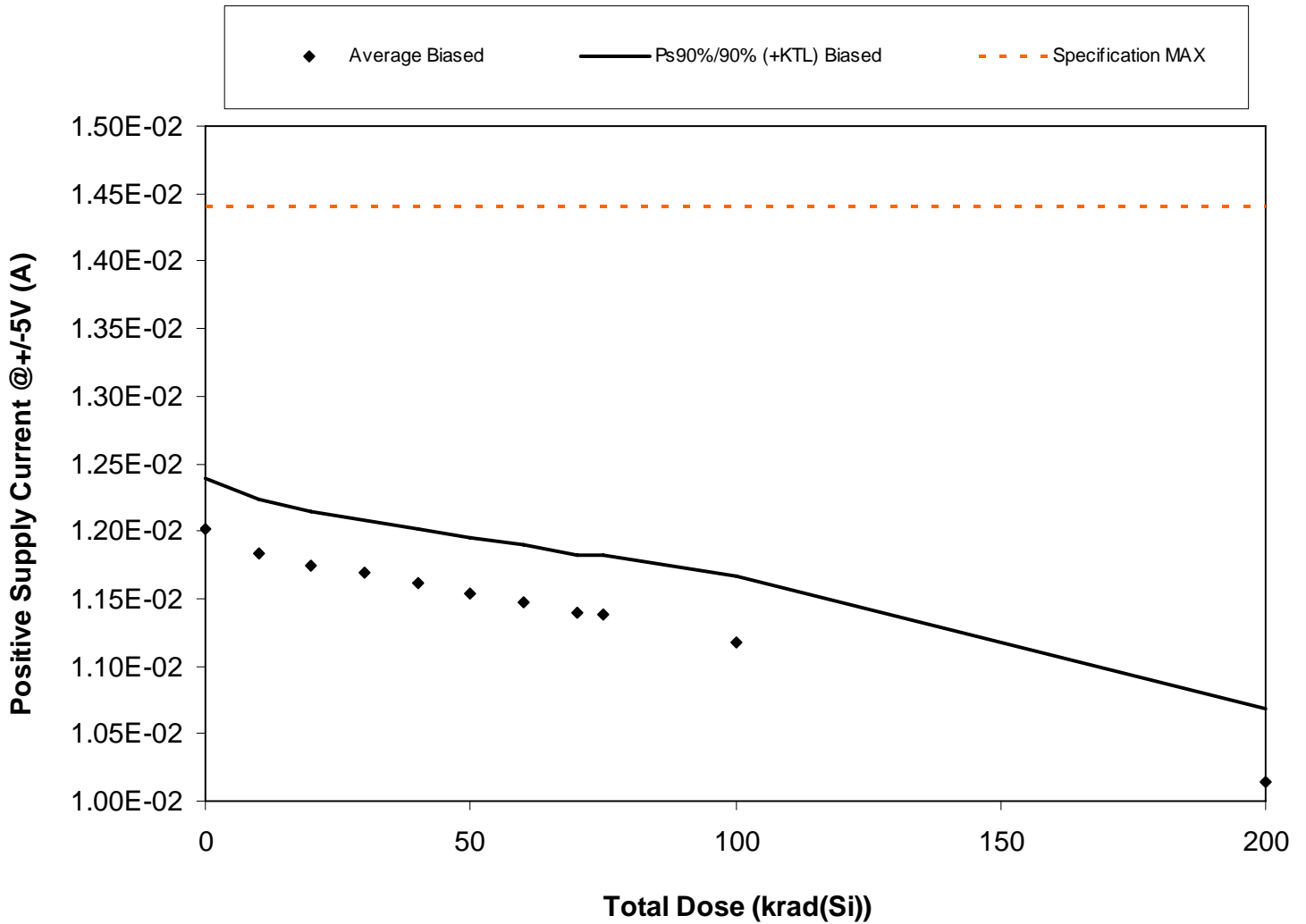

Figure 5.1. Plot of Positive Supply Current @ +/-5V (A) versus total dose. The solid diamonds are the average of the measured data points for the samples irradiated under electrical bias and the black lines (solid and/or dashed) are the average of the data points after application of the KTL statistics on the samples irradiated under electrical bias. The red dotted line(s) are the pre- and/or post-irradiation minimum and/or maximum specification value as defined in the datasheet and/or test plan.



**RLAT Report
10-326 100808 R1.0**

**Radiation Assured Devices
5017 N. 30th Street
Colorado Springs, CO 80919
(719) 531-0800**

Table 5.1. Raw data for Positive Supply Current @+/-5V (A) versus total dose, including the statistical analysis, specification and the status of the testing (pass/fail).

Positive Supply Current @+/-5V (A)	Total Dose (krad(Si))											
	0	10	20	30	40	50	60	70	75	100	200	
Device												
1245	1.21E-02	1.20E-02	1.19E-02	1.18E-02	1.18E-02	1.17E-02	1.16E-02	1.16E-02	1.16E-02	1.14E-02	1.04E-02	
1246	1.19E-02	1.18E-02	1.17E-02	1.16E-02	1.16E-02	1.15E-02	1.14E-02	1.13E-02	1.13E-02	1.11E-02	1.01E-02	
1247	1.21E-02	1.19E-02	1.18E-02	1.18E-02	1.17E-02	1.17E-02	1.16E-02	1.15E-02	1.15E-02	1.13E-02	1.03E-02	
1248	1.18E-02	1.17E-02	1.15E-02	1.15E-02	1.14E-02	1.13E-02	1.11E-02	1.10E-02	1.10E-02	1.07E-02	9.54E-03	
1249	1.21E-02	1.19E-02	1.18E-02	1.18E-02	1.17E-02	1.16E-02	1.16E-02	1.15E-02	1.15E-02	1.13E-02	1.03E-02	
1250	1.23E-02	1.22E-02	1.21E-02	1.20E-02	1.19E-02	1.19E-02	1.18E-02	1.17E-02	1.17E-02	1.15E-02	1.04E-02	
1251	1.18E-02	1.16E-02	1.15E-02	1.15E-02	1.14E-02	1.13E-02	1.12E-02	1.12E-02	1.12E-02	1.10E-02	9.98E-03	
1261	1.20E-02	1.17E-02	1.17E-02	1.16E-02	1.16E-02	1.15E-02	1.14E-02	1.14E-02	1.13E-02	1.12E-02	1.02E-02	
1262	1.18E-02	1.16E-02	1.15E-02	1.15E-02	1.14E-02	1.13E-02	1.13E-02	1.12E-02	1.12E-02	1.10E-02	1.00E-02	
1263	1.22E-02	1.20E-02	1.19E-02	1.18E-02	1.17E-02	1.17E-02	1.16E-02	1.15E-02	1.15E-02	1.13E-02	1.02E-02	
1264	1.20E-02	1.19E-02	1.18E-02	1.19E-02	1.19E-02	1.19E-02	1.19E-02	1.19E-02	1.19E-02	1.19E-02	1.19E-02	
1265	1.22E-02	1.20E-02	1.20E-02	1.20E-02	1.21E-02	1.21E-02	1.21E-02	1.21E-02	1.21E-02	1.21E-02	1.21E-02	
Biased Statistics												
Average Biased	1.20E-02	1.18E-02	1.17E-02	1.17E-02	1.16E-02	1.15E-02	1.15E-02	1.14E-02	1.14E-02	1.12E-02	1.01E-02	
Std Dev Biased	1.81E-04	1.91E-04	1.94E-04	1.90E-04	1.93E-04	1.97E-04	2.06E-04	2.09E-04	2.13E-04	2.38E-04	2.59E-04	
Ps90%/90% (+KTL) Biased	1.24E-02	1.22E-02	1.21E-02	1.21E-02	1.20E-02	1.19E-02	1.19E-02	1.18E-02	1.18E-02	1.17E-02	1.07E-02	
Ps90%/90% (-KTL) Biased	1.16E-02	1.14E-02	1.13E-02	1.13E-02	1.12E-02	1.11E-02	1.10E-02	1.10E-02	1.09E-02	1.07E-02	9.61E-03	
Specification MAX	1.44E-02	1.44E-02	1.44E-02	1.44E-02	1.44E-02	1.44E-02	1.44E-02	1.44E-02	1.44E-02	1.44E-02	1.44E-02	
Status	PASS	PASS	PASS	PASS	PASS	PASS	PASS	PASS	PASS	PASS	PASS	

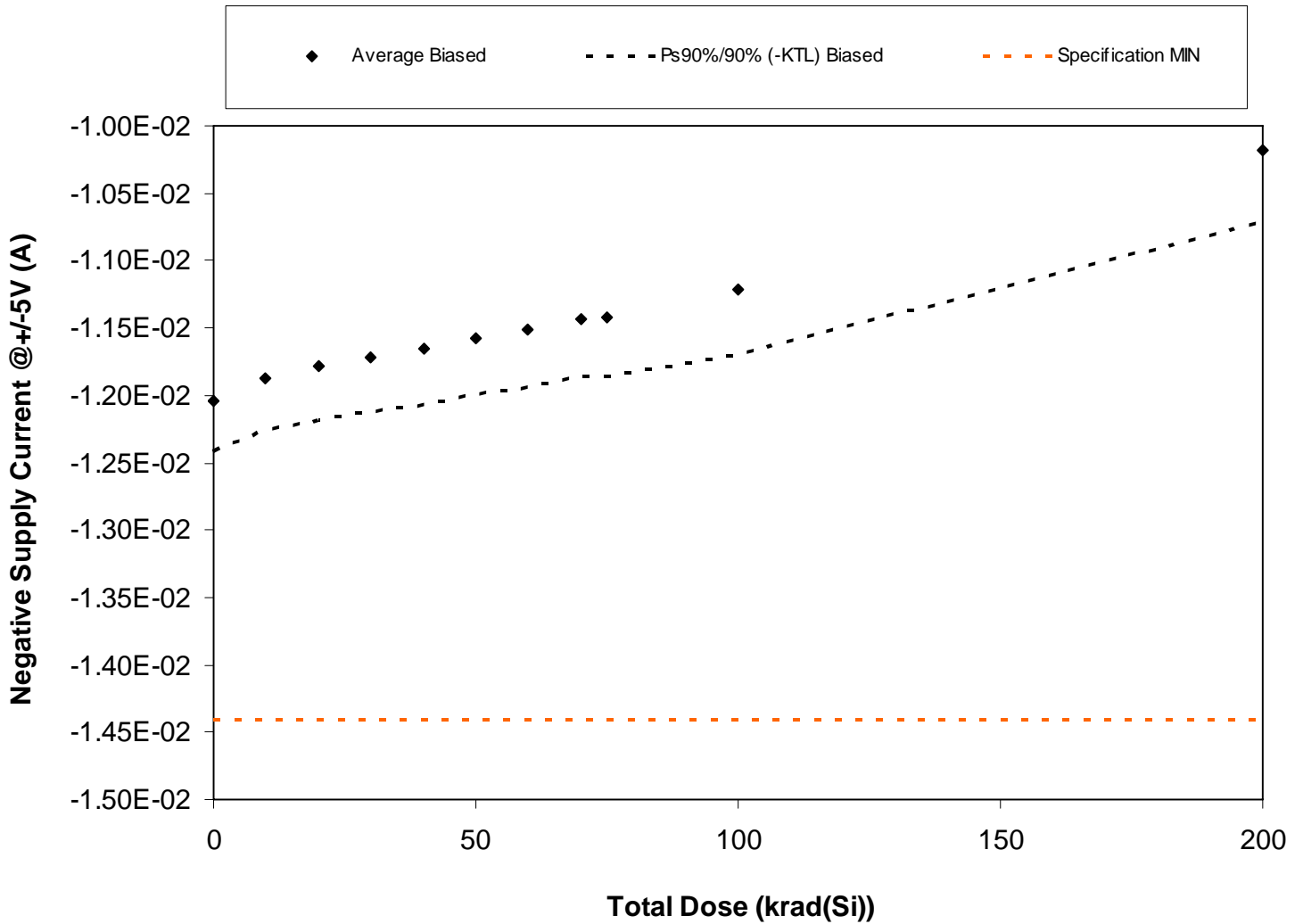

Figure 5.2. Plot of Negative Supply Current @ +/-5V (A) versus total dose. The solid diamonds are the average of the measured data points for the samples irradiated under electrical bias and the black lines (solid and/or dashed) are the average of the data points after application of the KTL statistics on the samples irradiated under electrical bias. The red dotted line(s) are the pre- and/or post-irradiation minimum and/or maximum specification value as defined in the datasheet and/or test plan.



Table 5.2. Raw data for Negative Supply Current @+/-5V (A) versus total dose, including the statistical analysis, specification and the status of the testing (pass/fail).

Negative Supply Current @+/-5V (A)	Total Dose (krad(Si))											
	0	10	20	30	40	50	60	70	75	100	200	
Device												
1245	-1.21E-02	-1.20E-02	-1.19E-02	-1.19E-02	-1.18E-02	-1.17E-02	-1.17E-02	-1.16E-02	-1.16E-02	-1.14E-02	-1.04E-02	
1246	-1.19E-02	-1.18E-02	-1.17E-02	-1.16E-02	-1.16E-02	-1.15E-02	-1.14E-02	-1.14E-02	-1.13E-02	-1.12E-02	-1.02E-02	
1247	-1.21E-02	-1.20E-02	-1.19E-02	-1.18E-02	-1.18E-02	-1.17E-02	-1.16E-02	-1.16E-02	-1.16E-02	-1.14E-02	-1.04E-02	
1248	-1.19E-02	-1.17E-02	-1.16E-02	-1.15E-02	-1.14E-02	-1.13E-02	-1.12E-02	-1.11E-02	-1.10E-02	-1.07E-02	-9.59E-03	
1249	-1.21E-02	-1.19E-02	-1.19E-02	-1.18E-02	-1.17E-02	-1.17E-02	-1.16E-02	-1.15E-02	-1.15E-02	-1.13E-02	-1.03E-02	
1250	-1.24E-02	-1.22E-02	-1.21E-02	-1.21E-02	-1.20E-02	-1.19E-02	-1.18E-02	-1.18E-02	-1.17E-02	-1.15E-02	-1.05E-02	
1251	-1.18E-02	-1.16E-02	-1.15E-02	-1.15E-02	-1.14E-02	-1.14E-02	-1.13E-02	-1.12E-02	-1.12E-02	-1.10E-02	-1.00E-02	
1261	-1.21E-02	-1.18E-02	-1.17E-02	-1.17E-02	-1.16E-02	-1.15E-02	-1.15E-02	-1.14E-02	-1.14E-02	-1.12E-02	-1.02E-02	
1262	-1.18E-02	-1.16E-02	-1.16E-02	-1.15E-02	-1.14E-02	-1.14E-02	-1.13E-02	-1.12E-02	-1.13E-02	-1.10E-02	-1.00E-02	
1263	-1.22E-02	-1.20E-02	-1.19E-02	-1.18E-02	-1.18E-02	-1.17E-02	-1.16E-02	-1.16E-02	-1.16E-02	-1.13E-02	-1.03E-02	
1264	-1.20E-02	-1.19E-02	-1.19E-02	-1.19E-02	-1.19E-02	-1.19E-02	-1.19E-02	-1.19E-02	-1.19E-02	-1.19E-02	-1.19E-02	
1265	-1.22E-02	-1.21E-02	-1.21E-02	-1.21E-02	-1.21E-02	-1.21E-02	-1.21E-02	-1.21E-02	-1.21E-02	-1.21E-02	-1.21E-02	
Biased Statistics												
Average Biased	-1.20E-02	-1.19E-02	-1.18E-02	-1.17E-02	-1.17E-02	-1.16E-02	-1.15E-02	-1.14E-02	-1.14E-02	-1.12E-02	-1.02E-02	
Std Dev Biased	1.83E-04	1.92E-04	1.92E-04	1.90E-04	1.96E-04	2.01E-04	2.09E-04	2.10E-04	2.14E-04	2.36E-04	2.56E-04	
Ps90%/90% (+KTL) Biased	-1.17E-02	-1.15E-02	-1.14E-02	-1.13E-02	-1.13E-02	-1.12E-02	-1.11E-02	-1.10E-02	-1.10E-02	-1.07E-02	-9.65E-03	
Ps90%/90% (-KTL) Biased	-1.24E-02	-1.23E-02	-1.22E-02	-1.21E-02	-1.21E-02	-1.20E-02	-1.19E-02	-1.19E-02	-1.19E-02	-1.17E-02	-1.07E-02	
Specification MIN	-1.44E-02	-1.44E-02	-1.44E-02	-1.44E-02	-1.44E-02	-1.44E-02	-1.44E-02	-1.44E-02	-1.44E-02	-1.44E-02	-1.44E-02	
Status	PASS	PASS	PASS	PASS	PASS	PASS	PASS	PASS	PASS	PASS	PASS	

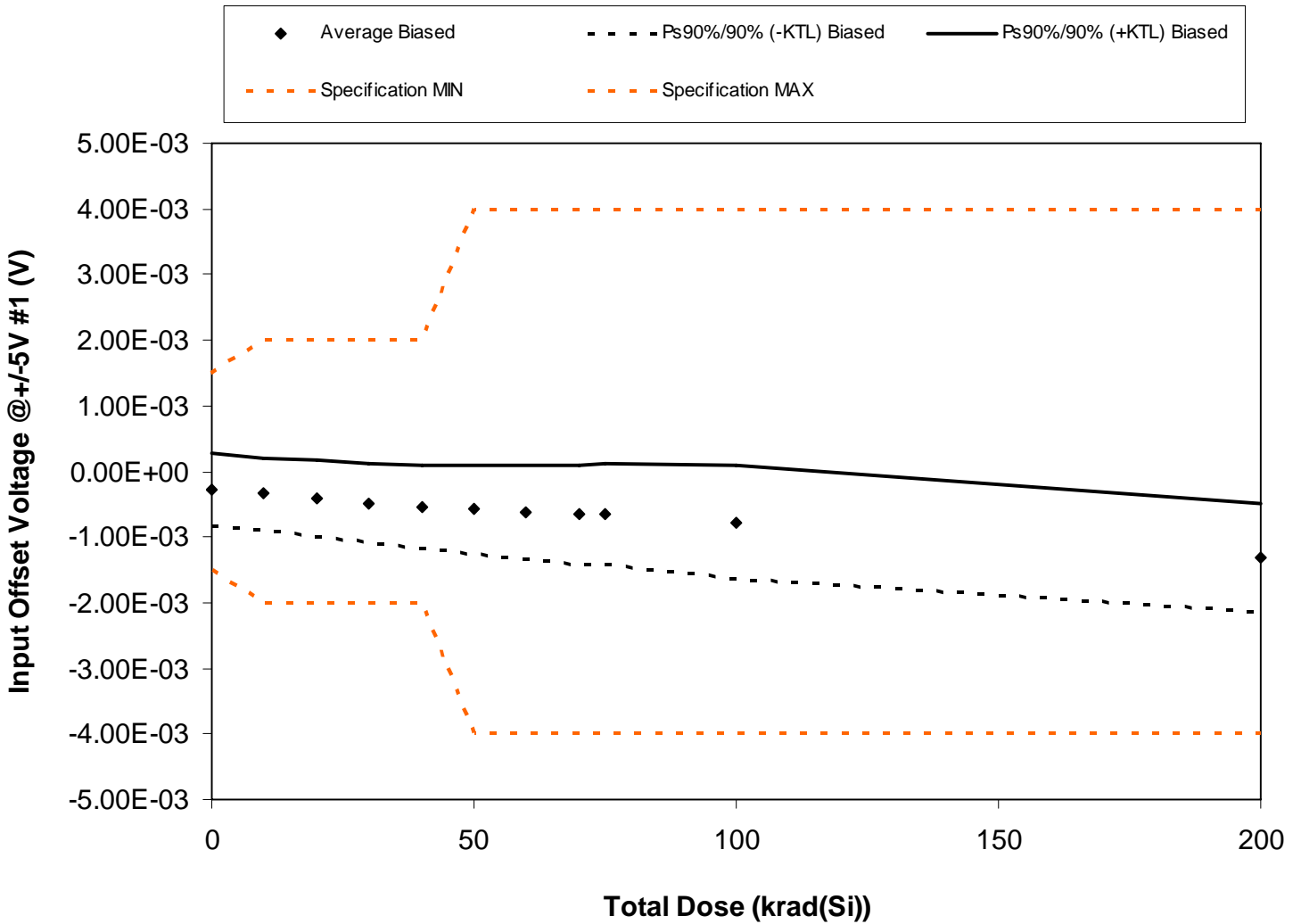

Figure 5.3. Plot of Input Offset Voltage @ +/-5V #1 (V) versus total dose. The solid diamonds are the average of the measured data points for the samples irradiated under electrical bias and the black lines (solid and/or dashed) are the average of the data points after application of the KTL statistics on the samples irradiated under electrical bias. The red dotted line(s) are the pre- and/or post-irradiation minimum and/or maximum specification value as defined in the datasheet and/or test plan.



**RLAT Report
10-326 100808 R1.0**

**Radiation Assured Devices
5017 N. 30th Street
Colorado Springs, CO 80919
(719) 531-0800**

Table 5.3. Raw data for Input Offset Voltage @+/-5V #1 (V) versus total dose, including the statistical analysis, specification and the status of the testing (pass/fail).

Input Offset Voltage @+/-5V #1 (V)	Total Dose (krad(Si))											
	0	10	20	30	40	50	60	70	75	100	200	
Device												
1245	-9.80E-05	-1.68E-04	-2.41E-04	-2.84E-04	-3.43E-04	-3.87E-04	-4.23E-04	-4.60E-04	-4.48E-04	-5.72E-04	-1.16E-03	
1246	-1.40E-05	-6.60E-05	-1.40E-04	-1.85E-04	-2.34E-04	-2.70E-04	-2.94E-04	-3.07E-04	-2.90E-04	-4.04E-04	-8.04E-04	
1247	-3.90E-05	-1.09E-04	-1.77E-04	-2.48E-04	-3.00E-04	-3.54E-04	-3.95E-04	-4.40E-04	-4.32E-04	-5.58E-04	-1.21E-03	
1248	-8.52E-04	-9.12E-04	-1.04E-03	-1.13E-03	-1.25E-03	-1.36E-03	-1.48E-03	-1.57E-03	-1.58E-03	-1.86E-03	-2.28E-03	
1249	-1.31E-04	-2.01E-04	-2.56E-04	-3.18E-04	-3.63E-04	-4.13E-04	-4.50E-04	-4.99E-04	-4.87E-04	-6.21E-04	-1.25E-03	
1250	-6.33E-04	-6.83E-04	-7.61E-04	-8.09E-04	-8.62E-04	-8.93E-04	-9.18E-04	-9.37E-04	-9.05E-04	-1.02E-03	-1.50E-03	
1251	-2.91E-04	-3.60E-04	-4.30E-04	-4.88E-04	-5.21E-04	-5.55E-04	-5.93E-04	-6.08E-04	-6.02E-04	-6.95E-04	-1.24E-03	
1261	-2.49E-04	-3.32E-04	-4.10E-04	-4.68E-04	-5.30E-04	-5.67E-04	-6.18E-04	-6.36E-04	-6.27E-04	-7.43E-04	-1.34E-03	
1262	-3.04E-04	-3.86E-04	-4.60E-04	-5.25E-04	-5.82E-04	-6.13E-04	-6.53E-04	-6.77E-04	-6.75E-04	-7.96E-04	-1.33E-03	
1263	-1.26E-04	-2.02E-04	-2.76E-04	-3.30E-04	-3.63E-04	-3.80E-04	-4.13E-04	-4.22E-04	-4.02E-04	-4.88E-04	-9.44E-04	
1264	-3.50E-04	-3.53E-04	-3.55E-04	-3.55E-04	-3.55E-04	-3.55E-04	-3.55E-04	-3.55E-04	-3.56E-04	-3.55E-04	-3.55E-04	
1265	-4.23E-04	-4.25E-04	-4.24E-04	-4.26E-04	-4.25E-04	-4.28E-04	-4.27E-04	-4.27E-04	-4.25E-04	-4.26E-04	-4.27E-04	
Biased Statistics												
Average Biased	-2.74E-04	-3.42E-04	-4.19E-04	-4.79E-04	-5.35E-04	-5.79E-04	-6.23E-04	-6.55E-04	-6.45E-04	-7.75E-04	-1.31E-03	
Std Dev Biased	2.71E-04	2.67E-04	2.82E-04	2.91E-04	3.10E-04	3.27E-04	3.48E-04	3.64E-04	3.72E-04	4.17E-04	3.96E-04	
Ps90%/90% (+KTL) Biased	2.86E-04	2.10E-04	1.63E-04	1.23E-04	1.06E-04	9.63E-05	9.60E-05	9.73E-05	1.23E-04	8.71E-05	-4.88E-04	
Ps90%/90% (-KTL) Biased	-8.33E-04	-8.94E-04	-1.00E-03	-1.08E-03	-1.18E-03	-1.26E-03	-1.34E-03	-1.41E-03	-1.41E-03	-1.64E-03	-2.12E-03	
Specification MIN	-1.50E-03	-2.00E-03	-2.00E-03	-2.00E-03	-2.00E-03	-4.00E-03	-4.00E-03	-4.00E-03	-4.00E-03	-4.00E-03	-4.00E-03	
Status	PASS	PASS	PASS	PASS	PASS	PASS	PASS	PASS	PASS	PASS	PASS	
Specification MAX	1.50E-03	2.00E-03	2.00E-03	2.00E-03	2.00E-03	4.00E-03	4.00E-03	4.00E-03	4.00E-03	4.00E-03	4.00E-03	
Status	PASS	PASS	PASS	PASS	PASS	PASS	PASS	PASS	PASS	PASS	PASS	

An ISO 9001:2008 and DSCC Certified Company

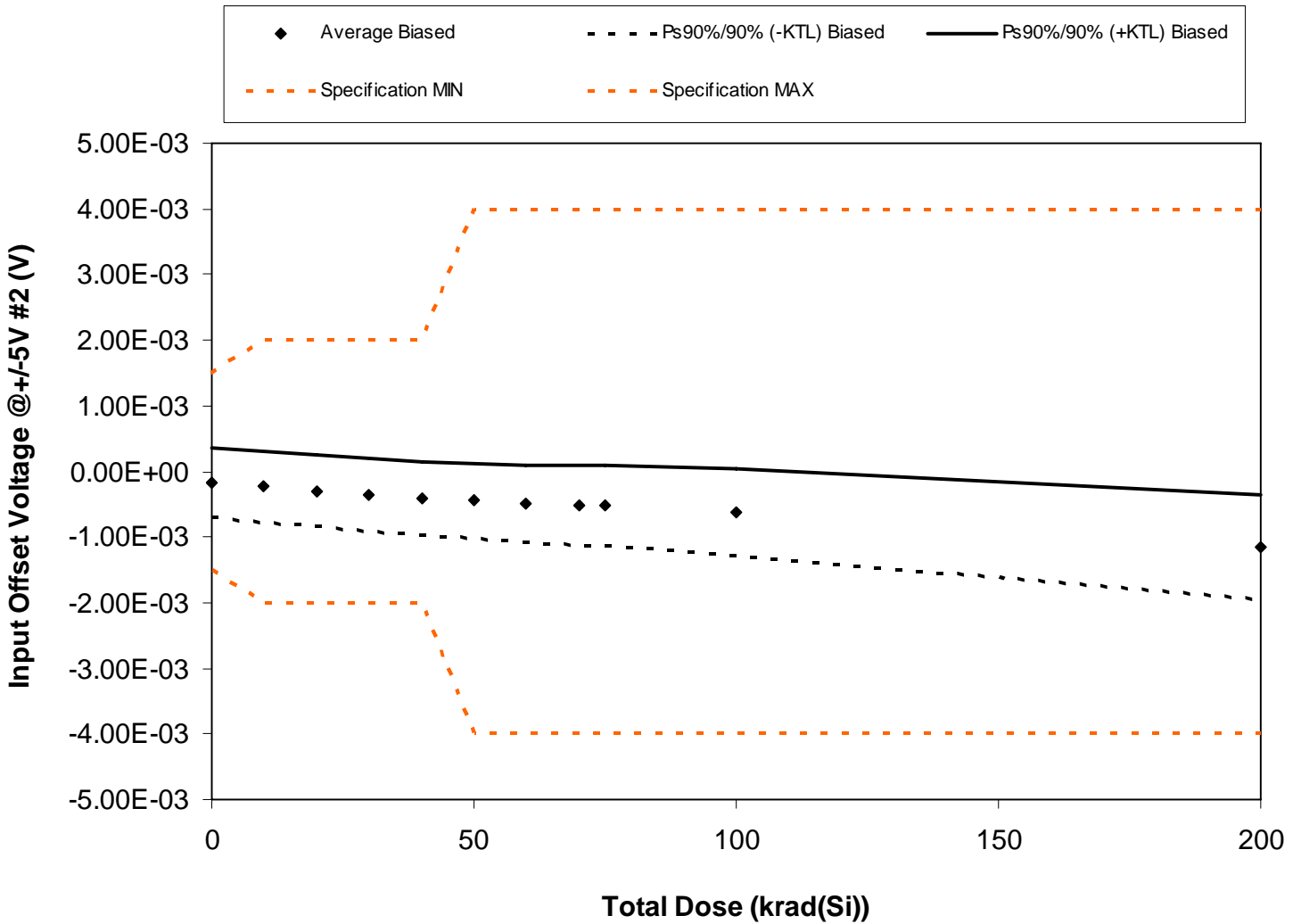

Figure 5.4. Plot of Input Offset Voltage @ +/-5V #2 (V) versus total dose. The solid diamonds are the average of the measured data points for the samples irradiated under electrical bias and the black lines (solid and/or dashed) are the average of the data points after application of the KTL statistics on the samples irradiated under electrical bias. The red dotted line(s) are the pre- and/or post-irradiation minimum and/or maximum specification value as defined in the datasheet and/or test plan.



Table 5.4. Raw data for Input Offset Voltage @+/-5V #2 (V) versus total dose, including the statistical analysis, specification and the status of the testing (pass/fail).

Input Offset Voltage @+/-5V #2 (V)	Total Dose (krad(Si))											
	0	10	20	30	40	50	60	70	75	100	200	
Device												
1245	-1.00E-04	-1.42E-04	-1.84E-04	-2.25E-04	-2.78E-04	-3.06E-04	-3.30E-04	-3.46E-04	-3.43E-04	-4.32E-04	-9.29E-04	
1246	-5.41E-04	-5.94E-04	-6.50E-04	-6.89E-04	-7.20E-04	-7.38E-04	-7.58E-04	-7.76E-04	-7.50E-04	-8.28E-04	-1.21E-03	
1247	-2.09E-04	-2.78E-04	-3.54E-04	-4.13E-04	-4.76E-04	-5.29E-04	-5.76E-04	-5.99E-04	-5.94E-04	-7.11E-04	-1.32E-03	
1248	-2.46E-04	-2.96E-04	-3.79E-04	-4.51E-04	-5.41E-04	-6.33E-04	-7.33E-04	-8.27E-04	-8.32E-04	-1.10E-03	-1.68E-03	
1249	7.40E-05	2.80E-05	-2.20E-05	-5.10E-05	-7.50E-05	-1.07E-04	-1.28E-04	-1.43E-04	-1.30E-04	-2.25E-04	-6.49E-04	
1250	3.34E-04	2.61E-04	1.92E-04	1.29E-04	8.60E-05	4.70E-05	1.40E-05	-1.70E-05	-7.00E-06	-1.08E-04	-5.65E-04	
1251	-5.32E-04	-5.90E-04	-6.52E-04	-6.99E-04	-7.36E-04	-7.67E-04	-8.12E-04	-8.25E-04	-8.16E-04	-8.98E-04	-1.36E-03	
1261	-7.00E-05	-1.20E-04	-1.85E-04	-2.31E-04	-2.78E-04	-3.03E-04	-3.29E-04	-3.53E-04	-3.44E-04	-4.36E-04	-8.97E-04	
1262	-1.89E-04	-2.53E-04	-3.18E-04	-3.76E-04	-4.23E-04	-4.55E-04	-4.87E-04	-5.17E-04	-5.09E-04	-6.19E-04	-1.17E-03	
1263	-2.53E-04	-3.73E-04	-4.67E-04	-5.34E-04	-6.06E-04	-6.57E-04	-7.10E-04	-7.60E-04	-7.64E-04	-8.99E-04	-1.68E-03	
1264	-1.93E-04	-1.91E-04	-1.91E-04	-1.93E-04	-1.92E-04	-1.92E-04	-1.93E-04	-1.93E-04	-1.93E-04	-1.93E-04	-1.93E-04	
1265	-5.97E-04	-5.97E-04	-5.98E-04	-5.97E-04	-5.96E-04	-6.00E-04	-5.98E-04	-5.97E-04	-6.01E-04	-6.00E-04	-5.98E-04	
Biased Statistics												
Average Biased	-1.73E-04	-2.36E-04	-3.02E-04	-3.54E-04	-4.05E-04	-4.45E-04	-4.85E-04	-5.16E-04	-5.09E-04	-6.26E-04	-1.15E-03	
Std Dev Biased	2.61E-04	2.62E-04	2.65E-04	2.65E-04	2.70E-04	2.73E-04	2.84E-04	2.92E-04	2.94E-04	3.21E-04	3.86E-04	
Ps90%/90% (+KTL) Biased	3.65E-04	3.05E-04	2.44E-04	1.94E-04	1.53E-04	1.20E-04	1.02E-04	8.76E-05	9.88E-05	3.68E-05	-3.48E-04	
Ps90%/90% (-KTL) Biased	-7.12E-04	-7.76E-04	-8.48E-04	-9.02E-04	-9.62E-04	-1.01E-03	-1.07E-03	-1.12E-03	-1.12E-03	-1.29E-03	-1.94E-03	
Specification MIN	-1.50E-03	-2.00E-03	-2.00E-03	-2.00E-03	-2.00E-03	-4.00E-03	-4.00E-03	-4.00E-03	-4.00E-03	-4.00E-03	-4.00E-03	
Status	PASS	PASS	PASS	PASS	PASS	PASS	PASS	PASS	PASS	PASS	PASS	
Specification MAX	1.50E-03	2.00E-03	2.00E-03	2.00E-03	2.00E-03	4.00E-03	4.00E-03	4.00E-03	4.00E-03	4.00E-03	4.00E-03	
Status	PASS	PASS	PASS	PASS	PASS	PASS	PASS	PASS	PASS	PASS	PASS	

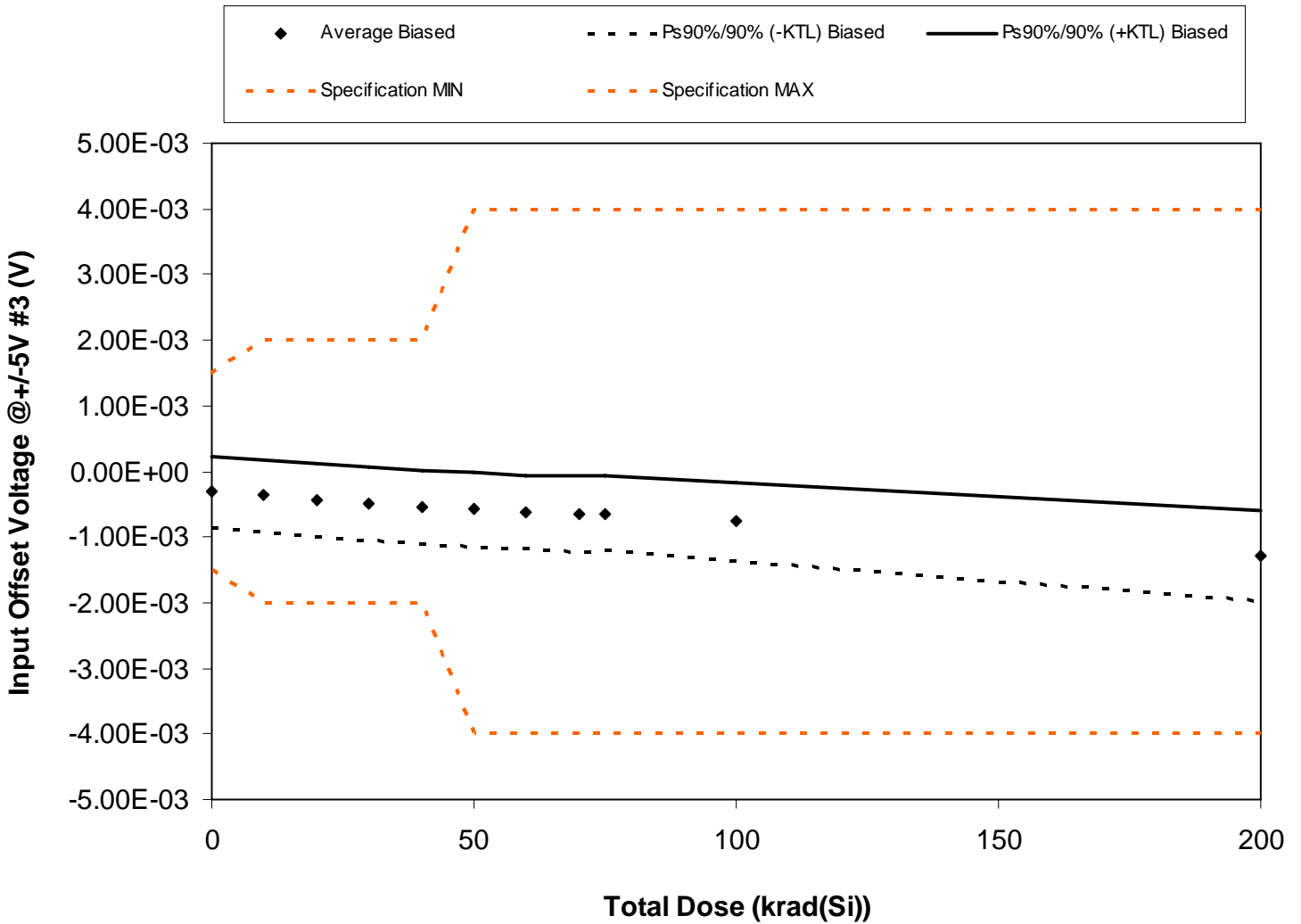

Figure 5.5. Plot of Input Offset Voltage @ +/-5V #3 (V) versus total dose. The solid diamonds are the average of the measured data points for the samples irradiated under electrical bias and the black lines (solid and/or dashed) are the average of the data points after application of the KTL statistics on the samples irradiated under electrical bias. The red dotted line(s) are the pre- and/or post-irradiation minimum and/or maximum specification value as defined in the datasheet and/or test plan.



**RLAT Report
10-326 100808 R1.0**

**Radiation Assured Devices
5017 N. 30th Street
Colorado Springs, CO 80919
(719) 531-0800**

Table 5.5. Raw data for Input Offset Voltage @+/-5V #3 (V) versus total dose, including the statistical analysis, specification and the status of the testing (pass/fail).

Input Offset Voltage @+/-5V #3 (V)	Total Dose (krad(Si))											
	0	10	20	30	40	50	60	70	75	100	200	
Device												
1245	-3.47E-04	-3.92E-04	-4.62E-04	-5.04E-04	-5.60E-04	-5.86E-04	-6.19E-04	-6.40E-04	-6.36E-04	-7.30E-04	-1.27E-03	
1246	-7.51E-04	-7.93E-04	-8.57E-04	-8.97E-04	-9.32E-04	-9.54E-04	-9.80E-04	-9.92E-04	-9.73E-04	-1.05E-03	-1.39E-03	
1247	-5.68E-04	-6.28E-04	-7.03E-04	-7.53E-04	-7.96E-04	-8.49E-04	-8.73E-04	-9.09E-04	-8.91E-04	-9.94E-04	-1.51E-03	
1248	-1.88E-04	-2.37E-04	-3.28E-04	-4.15E-04	-5.13E-04	-5.90E-04	-6.78E-04	-7.63E-04	-7.69E-04	-1.03E-03	-1.45E-03	
1249	-1.36E-04	-1.86E-04	-2.54E-04	-2.94E-04	-3.36E-04	-3.48E-04	-3.71E-04	-3.72E-04	-3.60E-04	-4.40E-04	-8.41E-04	
1250	-6.36E-04	-7.11E-04	-7.87E-04	-8.52E-04	-9.09E-04	-9.58E-04	-9.96E-04	-1.03E-03	-1.01E-03	-1.13E-03	-1.70E-03	
1251	9.90E-05	4.00E-05	-2.30E-05	-7.30E-05	-1.21E-04	-1.56E-04	-2.00E-04	-2.23E-04	-2.31E-04	-3.43E-04	-9.29E-04	
1261	-2.25E-04	-2.50E-04	-2.62E-04	-2.76E-04	-2.95E-04	-2.92E-04	-3.22E-04	-3.21E-04	-3.18E-04	-3.77E-04	-7.04E-04	
1262	-2.01E-04	-2.73E-04	-3.53E-04	-4.32E-04	-4.96E-04	-5.35E-04	-5.78E-04	-6.26E-04	-6.25E-04	-7.80E-04	-1.49E-03	
1263	-1.93E-04	-2.75E-04	-3.64E-04	-4.32E-04	-4.96E-04	-5.57E-04	-5.92E-04	-6.36E-04	-6.34E-04	-7.79E-04	-1.50E-03	
1264	5.00E-05	5.40E-05	5.30E-05	5.00E-05	5.00E-05	5.00E-05	4.90E-05	5.00E-05	5.00E-05	5.00E-05	4.70E-05	
1265	-2.41E-04	-2.49E-04	-2.49E-04	-2.50E-04	-2.49E-04	-2.49E-04	-2.49E-04	-2.49E-04	-2.49E-04	-2.49E-04	-2.49E-04	
Biased Statistics												
Average Biased	-3.15E-04	-3.71E-04	-4.39E-04	-4.93E-04	-5.45E-04	-5.83E-04	-6.21E-04	-6.51E-04	-6.45E-04	-7.65E-04	-1.28E-03	
Std Dev Biased	2.61E-04	2.61E-04	2.65E-04	2.66E-04	2.66E-04	2.74E-04	2.72E-04	2.80E-04	2.75E-04	2.93E-04	3.35E-04	
Ps90%/90% (+KTL) Biased	2.25E-04	1.69E-04	1.07E-04	5.63E-05	4.09E-06	-1.73E-05	-5.83E-05	-7.21E-05	-7.78E-05	-1.61E-04	-5.87E-04	
Ps90%/90% (-KTL) Biased	-8.54E-04	-9.10E-04	-9.86E-04	-1.04E-03	-1.09E-03	-1.15E-03	-1.18E-03	-1.23E-03	-1.21E-03	-1.37E-03	-1.97E-03	
Specification MIN	-1.50E-03	-2.00E-03	-2.00E-03	-2.00E-03	-2.00E-03	-4.00E-03	-4.00E-03	-4.00E-03	-4.00E-03	-4.00E-03	-4.00E-03	
Status	PASS	PASS	PASS	PASS	PASS	PASS	PASS	PASS	PASS	PASS	PASS	
Specification MAX	1.50E-03	2.00E-03	2.00E-03	2.00E-03	2.00E-03	4.00E-03	4.00E-03	4.00E-03	4.00E-03	4.00E-03	4.00E-03	
Status	PASS	PASS	PASS	PASS	PASS	PASS	PASS	PASS	PASS	PASS	PASS	

An ISO 9001:2008 and DSCC Certified Company

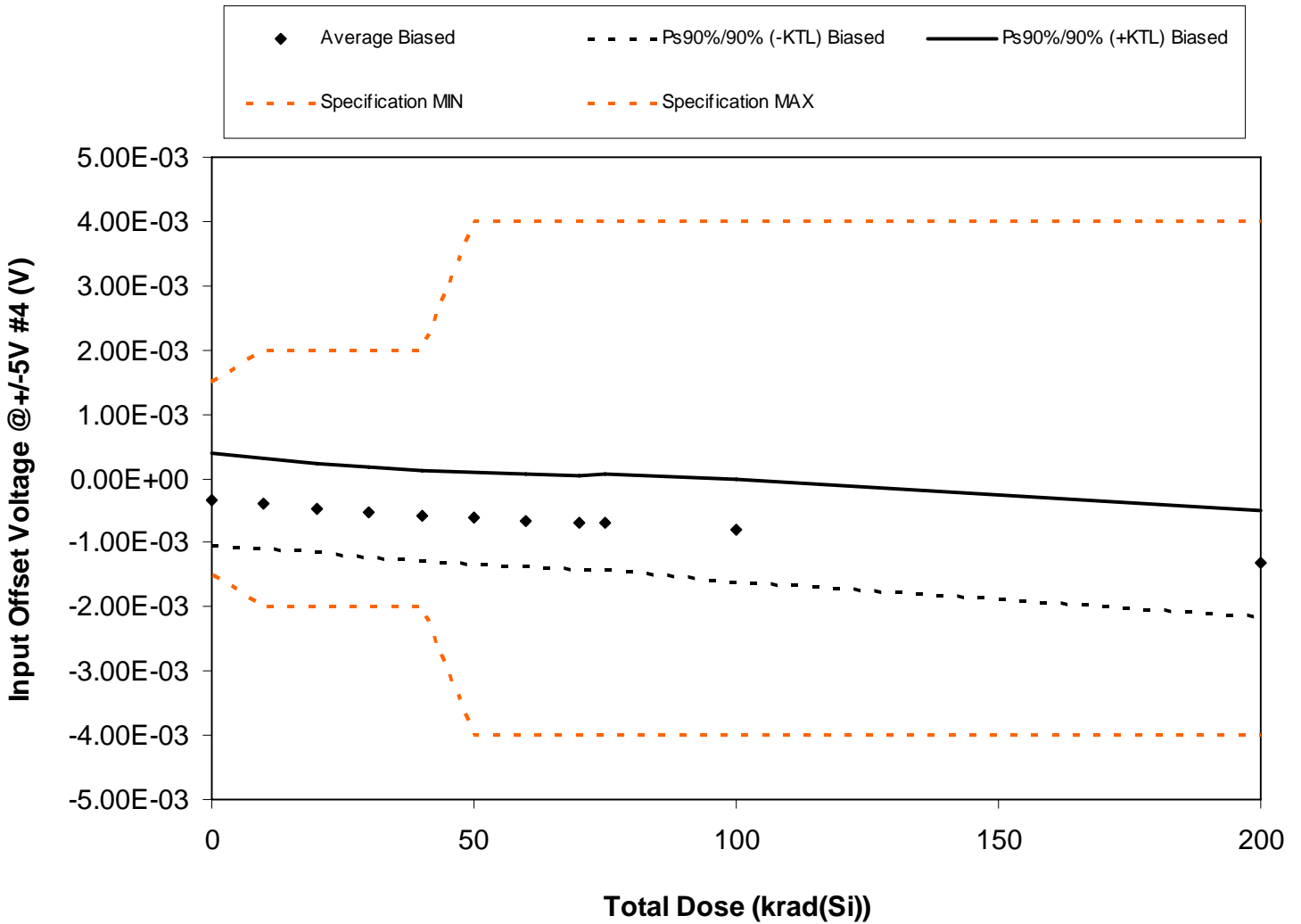

Figure 5.6. Plot of Input Offset Voltage @ +/-5V #4 (V) versus total dose. The solid diamonds are the average of the measured data points for the samples irradiated under electrical bias and the black lines (solid and/or dashed) are the average of the data points after application of the KTL statistics on the samples irradiated under electrical bias. The red dotted line(s) are the pre- and/or post-irradiation minimum and/or maximum specification value as defined in the datasheet and/or test plan.



**RLAT Report
10-326 100808 R1.0**

**Radiation Assured Devices
5017 N. 30th Street
Colorado Springs, CO 80919
(719) 531-0800**

Table 5.6. Raw data for Input Offset Voltage @+/-5V #4 (V) versus total dose, including the statistical analysis, specification and the status of the testing (pass/fail).

Input Offset Voltage @+/-5V #4 (V)	Total Dose (krad(Si))											
	0	10	20	30	40	50	60	70	75	100	200	
Device												
1245	-8.73E-04	-9.25E-04	-9.94E-04	-1.04E-03	-1.10E-03	-1.13E-03	-1.16E-03	-1.18E-03	-1.17E-03	-1.26E-03	-1.70E-03	
1246	-1.27E-04	-1.86E-04	-2.65E-04	-3.14E-04	-3.59E-04	-3.91E-04	-4.16E-04	-4.35E-04	-4.13E-04	-5.16E-04	-1.02E-03	
1247	-1.25E-04	-2.03E-04	-2.89E-04	-3.65E-04	-4.42E-04	-5.13E-04	-5.59E-04	-6.19E-04	-6.16E-04	-7.53E-04	-1.48E-03	
1248	-3.26E-04	-4.03E-04	-5.04E-04	-6.02E-04	-7.11E-04	-8.14E-04	-9.12E-04	-1.01E-03	-1.03E-03	-1.30E-03	-1.77E-03	
1249	-7.46E-04	-8.03E-04	-8.69E-04	-9.22E-04	-9.72E-04	-1.02E-03	-1.06E-03	-1.10E-03	-1.10E-03	-1.23E-03	-1.90E-03	
1250	-4.70E-05	-8.40E-05	-1.30E-04	-1.59E-04	-2.04E-04	-2.34E-04	-2.62E-04	-2.86E-04	-2.74E-04	-3.54E-04	-7.88E-04	
1251	-2.02E-04	-2.69E-04	-3.43E-04	-3.95E-04	-4.42E-04	-4.73E-04	-5.27E-04	-5.43E-04	-5.22E-04	-6.14E-04	-1.14E-03	
1261	-8.00E-04	-8.56E-04	-9.12E-04	-9.65E-04	-9.98E-04	-1.02E-03	-1.05E-03	-1.07E-03	-1.05E-03	-1.13E-03	-1.59E-03	
1262	-5.50E-05	-1.28E-04	-2.05E-04	-2.74E-04	-3.21E-04	-3.64E-04	-3.89E-04	-4.09E-04	-3.99E-04	-5.10E-04	-1.01E-03	
1263	4.20E-05	-3.10E-05	-1.17E-04	-1.76E-04	-2.15E-04	-2.49E-04	-2.64E-04	-2.86E-04	-2.68E-04	-3.68E-04	-8.66E-04	
1264	3.45E-04	3.40E-04	3.38E-04	3.38E-04	3.38E-04	3.39E-04	3.38E-04	3.39E-04	3.38E-04	3.38E-04	3.39E-04	
1265	-2.18E-04	-2.18E-04	-2.19E-04	-2.21E-04	-2.20E-04	-2.21E-04	-2.21E-04	-2.21E-04	-2.21E-04	-2.21E-04	-2.21E-04	
Biased Statistics												
Average Biased	-3.26E-04	-3.89E-04	-4.63E-04	-5.21E-04	-5.77E-04	-6.21E-04	-6.59E-04	-6.93E-04	-6.84E-04	-8.04E-04	-1.33E-03	
Std Dev Biased	3.47E-04	3.43E-04	3.38E-04	3.38E-04	3.41E-04	3.43E-04	3.49E-04	3.57E-04	3.63E-04	3.87E-04	4.05E-04	
Ps90%/90% (+KTL) Biased	3.90E-04	3.19E-04	2.36E-04	1.77E-04	1.28E-04	8.70E-05	6.15E-05	4.41E-05	6.54E-05	-4.89E-06	-4.89E-04	
Ps90%/90% (-KTL) Biased	-1.04E-03	-1.10E-03	-1.16E-03	-1.22E-03	-1.28E-03	-1.33E-03	-1.38E-03	-1.43E-03	-1.43E-03	-1.60E-03	-2.16E-03	
Specification MIN	-1.50E-03	-2.00E-03	-2.00E-03	-2.00E-03	-2.00E-03	-4.00E-03	-4.00E-03	-4.00E-03	-4.00E-03	-4.00E-03	-4.00E-03	
Status	PASS	PASS	PASS	PASS	PASS	PASS	PASS	PASS	PASS	PASS	PASS	
Specification MAX	1.50E-03	2.00E-03	2.00E-03	2.00E-03	2.00E-03	4.00E-03	4.00E-03	4.00E-03	4.00E-03	4.00E-03	4.00E-03	
Status	PASS	PASS	PASS	PASS	PASS	PASS	PASS	PASS	PASS	PASS	PASS	

An ISO 9001:2008 and DSCC Certified Company

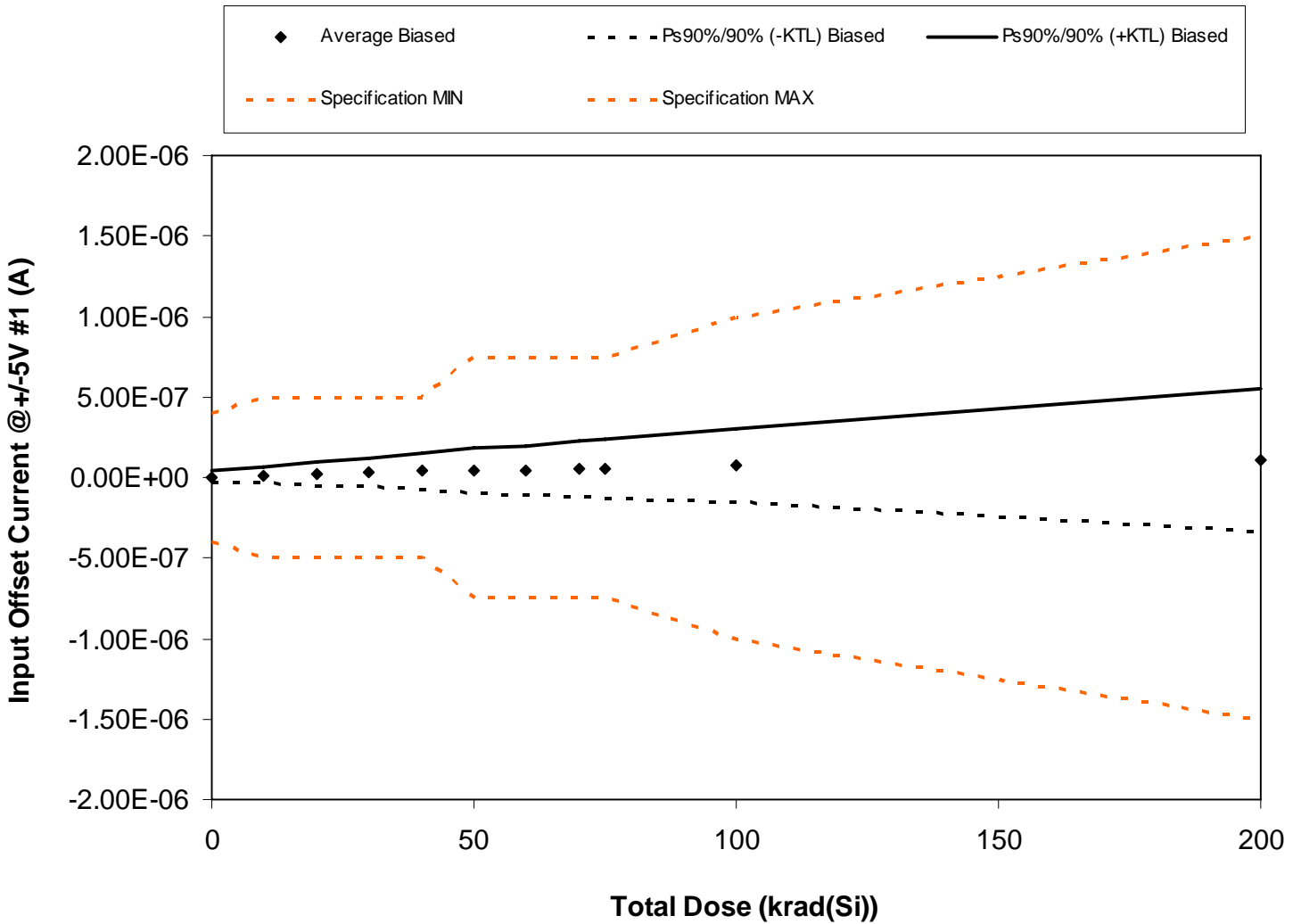

Figure 5.7. Plot of Input Offset Current @ +/-5V #1 (A) versus total dose. The solid diamonds are the average of the measured data points for the samples irradiated under electrical bias and the black lines (solid and/or dashed) are the average of the data points after application of the KTL statistics on the samples irradiated under electrical bias. The red dotted line(s) are the pre- and/or post-irradiation minimum and/or maximum specification value as defined in the datasheet and/or test plan.



**RLAT Report
10-326 100808 R1.0**

**Radiation Assured Devices
5017 N. 30th Street
Colorado Springs, CO 80919
(719) 531-0800**

Table 5.7. Raw data for Input Offset Current @+/-5V #1 (A) versus total dose, including the statistical analysis, specification and the status of the testing (pass/fail).

Input Offset Current @+/-5V #1 (A)	Total Dose (krad(Si))											
	0	10	20	30	40	50	60	70	75	100	200	
Device												
1245	-3.00E-08	-2.00E-08	-3.00E-08	-3.00E-08	-4.00E-08	-5.00E-08	-6.00E-08	-7.00E-08	-8.00E-08	-9.00E-08	-2.00E-07	
1246	2.00E-08	4.00E-08	6.00E-08	7.00E-08	9.00E-08	1.10E-07	1.20E-07	1.30E-07	1.40E-07	1.70E-07	2.80E-07	
1247	2.00E-08	5.00E-08	6.00E-08	8.00E-08	1.00E-07	1.10E-07	1.20E-07	1.40E-07	1.50E-07	1.80E-07	3.20E-07	
1248	0.00E+00	0.00E+00	1.00E-08	2.00E-08	3.00E-08	4.00E-08	4.00E-08	5.00E-08	6.00E-08	1.10E-07	1.20E-07	
1249	-1.00E-08	0.00E+00	0.00E+00	0.00E+00	0.00E+00	0.00E+00	0.00E+00	0.00E+00	0.00E+00	0.00E+00	-3.00E-08	
1250	0.00E+00	0.00E+00	0.00E+00	0.00E+00	-1.00E-08	-2.00E-08	-2.00E-08	-2.00E-08	-2.00E-08	-2.00E-08	-9.00E-08	
1251	0.00E+00	0.00E+00	0.00E+00	0.00E+00	0.00E+00	-1.00E-08	-1.00E-08	-2.00E-08	-2.00E-08	-2.00E-08	-9.00E-08	
1261	0.00E+00	0.00E+00	0.00E+00	1.00E-08	1.00E-08	0.00E+00	1.00E-08	1.00E-08	2.00E-08	3.00E-08	3.00E-08	
1262	2.00E-08	5.00E-08	7.00E-08	9.00E-08	1.10E-07	1.30E-07	1.40E-07	1.60E-07	1.70E-07	2.20E-07	4.10E-07	
1263	2.00E-08	4.00E-08	6.00E-08	8.00E-08	1.00E-07	1.10E-07	1.30E-07	1.40E-07	1.50E-07	1.80E-07	3.30E-07	
1264	0.00E+00	0.00E+00	0.00E+00	0.00E+00	0.00E+00	0.00E+00	0.00E+00	0.00E+00	0.00E+00	0.00E+00	0.00E+00	
1265	0.00E+00	0.00E+00	0.00E+00	0.00E+00	0.00E+00	0.00E+00	0.00E+00	0.00E+00	0.00E+00	0.00E+00	0.00E+00	
Biased Statistics												
Average Biased	4.00E-09	1.60E-08	2.30E-08	3.20E-08	3.90E-08	4.20E-08	4.70E-08	5.20E-08	5.70E-08	7.60E-08	1.08E-07	
Std Dev Biased	1.65E-08	2.59E-08	3.56E-08	4.34E-08	5.55E-08	6.68E-08	7.38E-08	8.36E-08	8.96E-08	1.09E-07	2.14E-07	
Ps90%/90% (+KTL) Biased	3.80E-08	6.95E-08	9.65E-08	1.22E-07	1.54E-07	1.80E-07	1.99E-07	2.25E-07	2.42E-07	3.00E-07	5.51E-07	
Ps90%/90% (-KTL) Biased	-3.00E-08	-3.75E-08	-5.05E-08	-5.76E-08	-7.55E-08	-9.59E-08	-1.05E-07	-1.21E-07	-1.28E-07	-1.48E-07	-3.35E-07	
Specification MIN	-4.00E-07	-5.00E-07	-5.00E-07	-5.00E-07	-5.00E-07	-7.50E-07	-7.50E-07	-7.50E-07	-7.50E-07	-1.00E-06	-1.50E-06	
Status	PASS	PASS	PASS	PASS	PASS	PASS	PASS	PASS	PASS	PASS	PASS	
Specification MAX	4.00E-07	5.00E-07	5.00E-07	5.00E-07	5.00E-07	7.50E-07	7.50E-07	7.50E-07	7.50E-07	1.00E-06	1.50E-06	
Status	PASS	PASS	PASS	PASS	PASS	PASS	PASS	PASS	PASS	PASS	PASS	

An ISO 9001:2008 and DSCC Certified Company

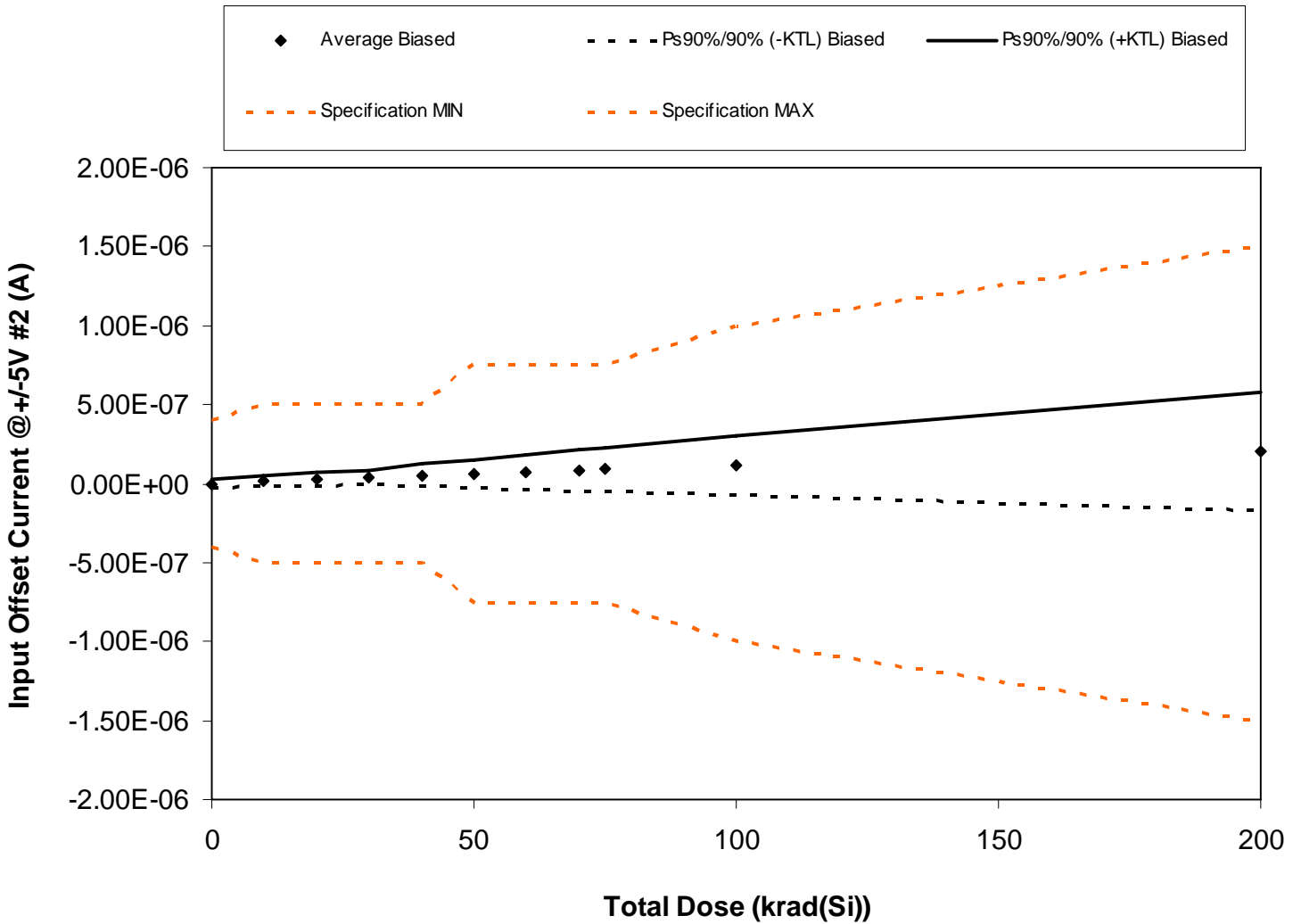

Figure 5.8. Plot of Input Offset Current @ +/-5V #2 (A) versus total dose. The solid diamonds are the average of the measured data points for the samples irradiated under electrical bias and the black lines (solid and/or dashed) are the average of the data points after application of the KTL statistics on the samples irradiated under electrical bias. The red dotted line(s) are the pre- and/or post-irradiation minimum and/or maximum specification value as defined in the datasheet and/or test plan.



Table 5.8. Raw data for Input Offset Current @+/-5V #2 (A) versus total dose, including the statistical analysis, specification and the status of the testing (pass/fail).

Input Offset Current @+/-5V #2 (A)	Total Dose (krad(Si))											
	0	10	20	30	40	50	60	70	75	100	200	
Device												
1245	1.00E-08	1.00E-08	0.00E+00	0.00E+00	0.00E+00	0.00E+00	0.00E+00	-1.00E-08	-1.00E-08	-2.00E-08	-1.10E-07	
1246	-2.00E-08	0.00E+00	2.00E-08	4.00E-08	5.00E-08	7.00E-08	8.00E-08	1.00E-07	1.10E-07	1.40E-07	2.80E-07	
1247	1.00E-08	4.00E-08	5.00E-08	5.00E-08	6.00E-08	7.00E-08	7.00E-08	8.00E-08	8.00E-08	1.00E-07	2.10E-07	
1248	0.00E+00	0.00E+00	3.00E-08	5.00E-08	8.00E-08	1.00E-07	1.30E-07	1.60E-07	1.70E-07	2.60E-07	3.90E-07	
1249	-1.00E-08	0.00E+00	3.00E-08	4.00E-08	6.00E-08	7.00E-08	9.00E-08	1.10E-07	1.10E-07	1.50E-07	2.80E-07	
1250	2.00E-08	4.00E-08	6.00E-08	7.00E-08	9.00E-08	1.00E-07	1.20E-07	1.40E-07	1.50E-07	1.80E-07	3.10E-07	
1251	0.00E+00	2.00E-08	4.00E-08	6.00E-08	7.00E-08	8.00E-08	9.00E-08	1.10E-07	1.10E-07	1.30E-07	2.60E-07	
1261	-2.00E-08	0.00E+00	2.00E-08	4.00E-08	5.00E-08	6.00E-08	8.00E-08	9.00E-08	1.10E-07	1.40E-07	2.80E-07	
1262	0.00E+00	2.00E-08	4.00E-08	5.00E-08	7.00E-08	8.00E-08	1.00E-07	1.10E-07	1.20E-07	1.50E-07	2.90E-07	
1263	0.00E+00	0.00E+00	0.00E+00	0.00E+00	-2.00E-08	-3.00E-08	-4.00E-08	-4.00E-08	-4.00E-08	-5.00E-08	-1.50E-07	
1264	3.00E-08	3.00E-08	3.00E-08	3.00E-08	3.00E-08	3.00E-08	3.00E-08	3.00E-08	3.00E-08	3.00E-08	3.00E-08	
1265	2.00E-08	2.00E-08	2.00E-08	2.00E-08	2.00E-08	2.00E-08	2.00E-08	2.00E-08	2.00E-08	1.00E-08	2.00E-08	
Biased Statistics												
Average Biased	-1.00E-09	1.30E-08	2.90E-08	4.00E-08	5.10E-08	6.00E-08	7.20E-08	8.50E-08	9.10E-08	1.18E-07	2.04E-07	
Std Dev Biased	1.29E-08	1.64E-08	1.97E-08	2.31E-08	3.48E-08	4.22E-08	5.27E-08	6.28E-08	6.62E-08	9.11E-08	1.82E-07	
Ps90%/90% (+KTL) Biased	2.56E-08	4.68E-08	6.97E-08	8.77E-08	1.23E-07	1.47E-07	1.81E-07	2.15E-07	2.28E-07	3.06E-07	5.80E-07	
Ps90%/90% (-KTL) Biased	-2.76E-08	-2.08E-08	-1.17E-08	-7.69E-09	-2.08E-08	-2.71E-08	-3.67E-08	-4.46E-08	-4.58E-08	-7.02E-08	-1.72E-07	
Specification MIN	-4.00E-07	-5.00E-07	-5.00E-07	-5.00E-07	-5.00E-07	-7.50E-07	-7.50E-07	-7.50E-07	-7.50E-07	-1.00E-06	-1.50E-06	
Status	PASS	PASS	PASS	PASS	PASS	PASS	PASS	PASS	PASS	PASS	PASS	
Specification MAX	4.00E-07	5.00E-07	5.00E-07	5.00E-07	5.00E-07	7.50E-07	7.50E-07	7.50E-07	7.50E-07	1.00E-06	1.50E-06	
Status	PASS	PASS	PASS	PASS	PASS	PASS	PASS	PASS	PASS	PASS	PASS	

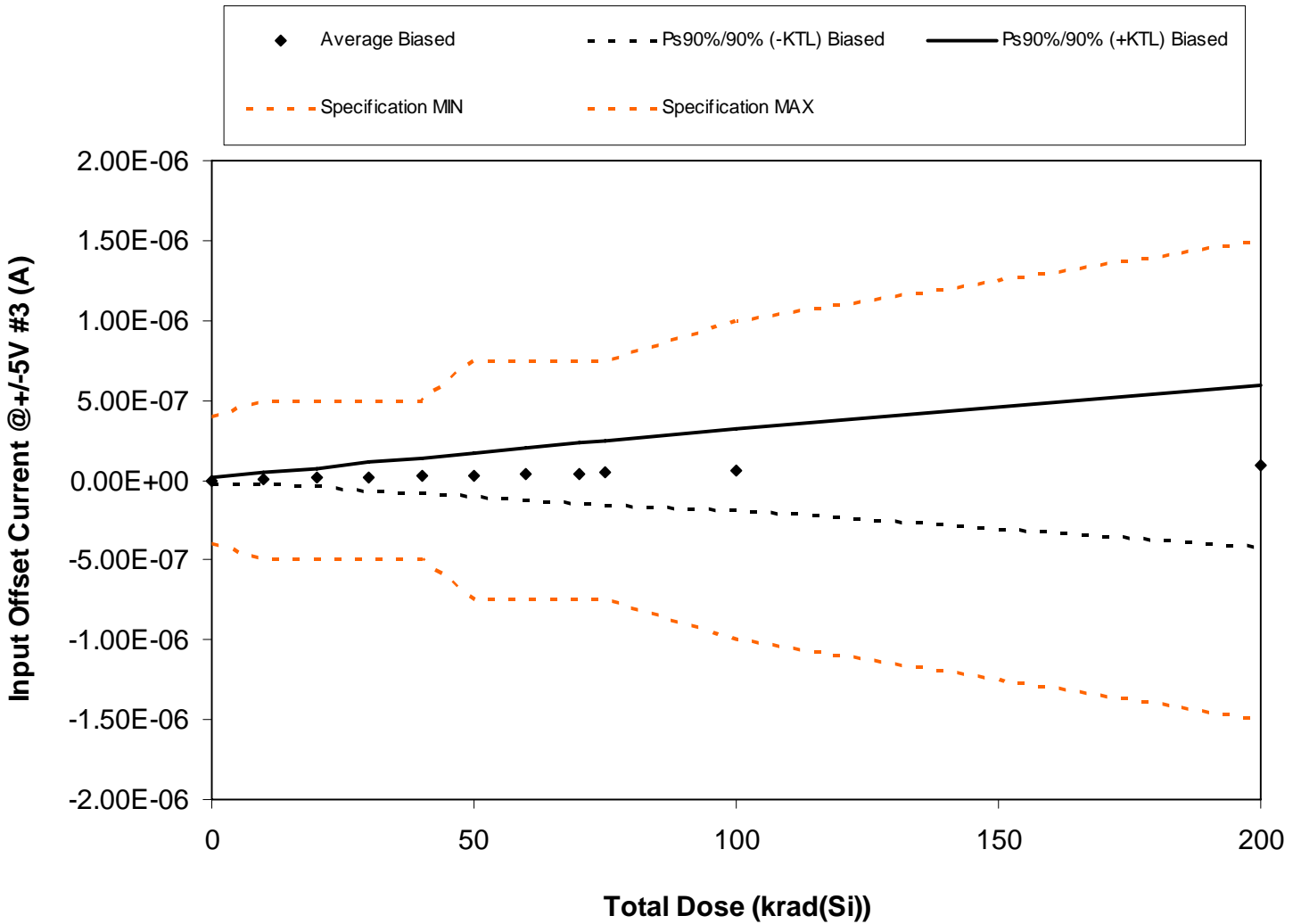

Figure 5.9. Plot of Input Offset Current @ +/-5V #3 (A) versus total dose. The solid diamonds are the average of the measured data points for the samples irradiated under electrical bias and the black lines (solid and/or dashed) are the average of the data points after application of the KTL statistics on the samples irradiated under electrical bias. The red dotted line(s) are the pre- and/or post-irradiation minimum and/or maximum specification value as defined in the datasheet and/or test plan.



**RLAT Report
10-326 100808 R1.0**

**Radiation Assured Devices
5017 N. 30th Street
Colorado Springs, CO 80919
(719) 531-0800**

Table 5.9. Raw data for Input Offset Current @+/-5V #3 (A) versus total dose, including the statistical analysis, specification and the status of the testing (pass/fail).

Input Offset Current @+/-5V #3 (A)	Total Dose (krad(Si))											
	0	10	20	30	40	50	60	70	75	100	200	
Device												
1245	-2.00E-08	-1.00E-08	-1.00E-08	-2.00E-08	-2.00E-08	-2.00E-08	-2.00E-08	-3.00E-08	-3.00E-08	-3.00E-08	-9.00E-08	-9.00E-08
1246	-2.00E-08	0.00E+00	2.00E-08	3.00E-08	5.00E-08	6.00E-08	7.00E-08	9.00E-08	1.00E-07	1.30E-07	2.60E-07	2.60E-07
1247	2.00E-08	4.00E-08	6.00E-08	8.00E-08	1.00E-07	1.10E-07	1.20E-07	1.40E-07	1.50E-07	1.80E-07	3.20E-07	3.20E-07
1248	0.00E+00	2.00E-08	4.00E-08	7.00E-08	9.00E-08	1.10E-07	1.40E-07	1.70E-07	1.80E-07	2.60E-07	4.20E-07	4.20E-07
1249	0.00E+00	2.00E-08	4.00E-08	6.00E-08	7.00E-08	9.00E-08	1.10E-07	1.20E-07	1.30E-07	1.60E-07	2.90E-07	2.90E-07
1250	-2.00E-08	-1.00E-08	-2.00E-08	-2.00E-08	-3.00E-08	-5.00E-08	-5.00E-08	-7.00E-08	-6.00E-08	-7.00E-08	-1.80E-07	-1.80E-07
1251	0.00E+00	3.00E-08	4.00E-08	6.00E-08	7.00E-08	9.00E-08	1.00E-07	1.20E-07	1.30E-07	1.50E-07	2.90E-07	2.90E-07
1261	0.00E+00	-1.00E-08	-1.00E-08	-2.00E-08	-2.00E-08	-2.00E-08	-2.00E-08	-3.00E-08	-4.00E-08	-4.00E-08	-1.30E-07	-1.30E-07
1262	0.00E+00	0.00E+00	0.00E+00	-2.00E-08	-2.00E-08	-3.00E-08	-4.00E-08	-4.00E-08	-4.00E-08	-5.00E-08	-1.70E-07	-1.70E-07
1263	-1.00E-08	-1.00E-08	0.00E+00	-2.00E-08	-2.00E-08	-3.00E-08	-4.00E-08	-4.00E-08	-4.00E-08	-5.00E-08	-1.30E-07	-1.30E-07
1264	1.00E-08	1.00E-08	1.00E-08	1.00E-08	1.00E-08	1.00E-08	1.00E-08	1.00E-08	1.00E-08	1.00E-08	1.00E-08	1.00E-08
1265	0.00E+00	0.00E+00	0.00E+00	0.00E+00	0.00E+00	0.00E+00	0.00E+00	0.00E+00	0.00E+00	0.00E+00	0.00E+00	0.00E+00
Biased Statistics												
Average Biased	-5.00E-09	7.00E-09	1.60E-08	2.00E-08	2.70E-08	3.10E-08	3.70E-08	4.30E-08	4.80E-08	6.40E-08	8.80E-08	8.80E-08
Std Dev Biased	1.27E-08	1.89E-08	2.76E-08	4.40E-08	5.33E-08	6.62E-08	7.73E-08	9.24E-08	9.72E-08	1.23E-07	2.45E-07	2.45E-07
Ps90%/90% (+KTL) Biased	2.12E-08	4.60E-08	7.29E-08	1.11E-07	1.37E-07	1.68E-07	1.97E-07	2.34E-07	2.49E-07	3.18E-07	5.94E-07	5.94E-07
Ps90%/90% (-KTL) Biased	-3.12E-08	-3.20E-08	-4.09E-08	-7.08E-08	-8.32E-08	-1.06E-07	-1.23E-07	-1.48E-07	-1.53E-07	-1.90E-07	-4.18E-07	-4.18E-07
Specification MIN	-4.00E-07	-5.00E-07	-5.00E-07	-5.00E-07	-5.00E-07	-7.50E-07	-7.50E-07	-7.50E-07	-7.50E-07	-1.00E-06	-1.50E-06	-1.50E-06
Status	PASS	PASS	PASS	PASS	PASS	PASS	PASS	PASS	PASS	PASS	PASS	PASS
Specification MAX	4.00E-07	5.00E-07	5.00E-07	5.00E-07	5.00E-07	7.50E-07	7.50E-07	7.50E-07	7.50E-07	1.00E-06	1.50E-06	1.50E-06
Status	PASS	PASS	PASS	PASS	PASS	PASS	PASS	PASS	PASS	PASS	PASS	PASS

An ISO 9001:2008 and DSCC Certified Company

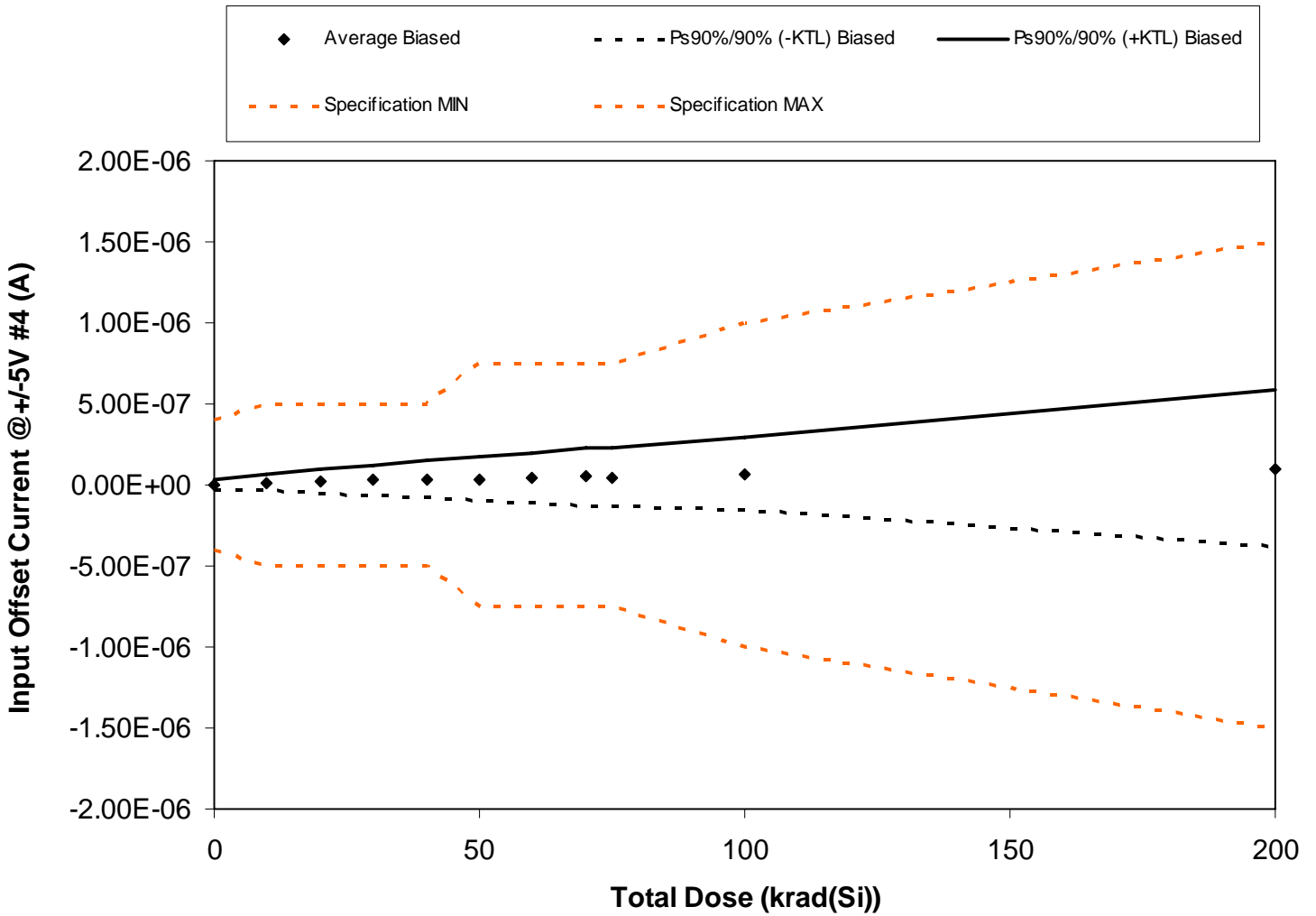

Figure 5.10. Plot of Input Offset Current @ +/-5V #4 (A) versus total dose. The solid diamonds are the average of the measured data points for the samples irradiated under electrical bias and the black lines (solid and/or dashed) are the average of the data points after application of the KTL statistics on the samples irradiated under electrical bias. The red dotted line(s) are the pre- and/or post-irradiation minimum and/or maximum specification value as defined in the datasheet and/or test plan.



**RLAT Report
10-326 100808 R1.0**

**Radiation Assured Devices
5017 N. 30th Street
Colorado Springs, CO 80919
(719) 531-0800**

Table 5.10. Raw data for Input Offset Current @+/-5V #4 (A) versus total dose, including the statistical analysis, specification and the status of the testing (pass/fail).

Input Offset Current @+/-5V #4 (A)	Total Dose (krad(Si))											
	0	10	20	30	40	50	60	70	75	100	200	
Device												
1245	0.00E+00	0.00E+00	0.00E+00	0.00E+00	-1.00E-08	-2.00E-08	-2.00E-08	-3.00E-08	-3.00E-08	-2.00E-08	-1.00E-07	
1246	0.00E+00	0.00E+00	0.00E+00	0.00E+00	0.00E+00	0.00E+00	0.00E+00	-1.00E-08	0.00E+00	-1.00E-08	-6.00E-08	
1247	-1.00E-08	0.00E+00	0.00E+00	0.00E+00	-1.00E-08	-2.00E-08	-2.00E-08	-2.00E-08	-3.00E-08	-2.00E-08	-7.00E-08	
1248	0.00E+00	-1.00E-08	-2.00E-08	-2.00E-08	-2.00E-08	-3.00E-08	-3.00E-08	-3.00E-08	-4.00E-08	-2.00E-08	-1.30E-07	
1249	0.00E+00	2.00E-08	3.00E-08	4.00E-08	5.00E-08	5.00E-08	5.00E-08	6.00E-08	6.00E-08	8.00E-08	1.10E-07	
1250	-2.00E-08	-1.00E-08	-2.00E-08	-2.00E-08	-3.00E-08	-3.00E-08	-3.00E-08	-3.00E-08	-3.00E-08	-2.00E-08	-8.00E-08	
1251	3.00E-08	5.00E-08	6.00E-08	7.00E-08	7.00E-08	8.00E-08	9.00E-08	1.00E-07	1.00E-07	1.20E-07	2.00E-07	
1261	2.00E-08	6.00E-08	9.00E-08	1.20E-07	1.40E-07	1.70E-07	1.90E-07	2.20E-07	2.20E-07	2.90E-07	6.00E-07	
1262	0.00E+00	2.00E-08	4.00E-08	6.00E-08	8.00E-08	9.00E-08	1.00E-07	1.20E-07	1.20E-07	1.50E-07	2.80E-07	
1263	-1.00E-08	0.00E+00	3.00E-08	5.00E-08	6.00E-08	8.00E-08	9.00E-08	1.10E-07	1.10E-07	1.50E-07	2.60E-07	
1264	0.00E+00	0.00E+00	0.00E+00	0.00E+00	0.00E+00	0.00E+00	0.00E+00	0.00E+00	0.00E+00	0.00E+00	0.00E+00	
1265	1.00E-08	1.00E-08	1.00E-08	1.00E-08	1.00E-08	1.00E-08	1.00E-08	1.00E-08	1.00E-08	1.00E-08	1.00E-08	
Biased Statistics												
Average Biased	1.00E-09	1.30E-08	2.10E-08	3.00E-08	3.30E-08	3.70E-08	4.20E-08	4.90E-08	4.80E-08	7.00E-08	1.01E-07	
Std Dev Biased	1.45E-08	2.45E-08	3.57E-08	4.57E-08	5.54E-08	6.77E-08	7.44E-08	8.67E-08	8.80E-08	1.07E-07	2.35E-07	
Ps90%/90% (+KTL) Biased	3.09E-08	6.36E-08	9.48E-08	1.24E-07	1.47E-07	1.77E-07	1.96E-07	2.28E-07	2.30E-07	2.90E-07	5.87E-07	
Ps90%/90% (-KTL) Biased	-2.89E-08	-3.76E-08	-5.28E-08	-6.44E-08	-8.14E-08	-1.03E-07	-1.12E-07	-1.30E-07	-1.34E-07	-1.50E-07	-3.85E-07	
Specification MIN	-4.00E-07	-5.00E-07	-5.00E-07	-5.00E-07	-5.00E-07	-7.50E-07	-7.50E-07	-7.50E-07	-7.50E-07	-1.00E-06	-1.50E-06	
Status	PASS	PASS	PASS	PASS	PASS	PASS	PASS	PASS	PASS	PASS	PASS	
Specification MAX	4.00E-07	5.00E-07	5.00E-07	5.00E-07	5.00E-07	7.50E-07	7.50E-07	7.50E-07	7.50E-07	1.00E-06	1.50E-06	
Status	PASS	PASS	PASS	PASS	PASS	PASS	PASS	PASS	PASS	PASS	PASS	

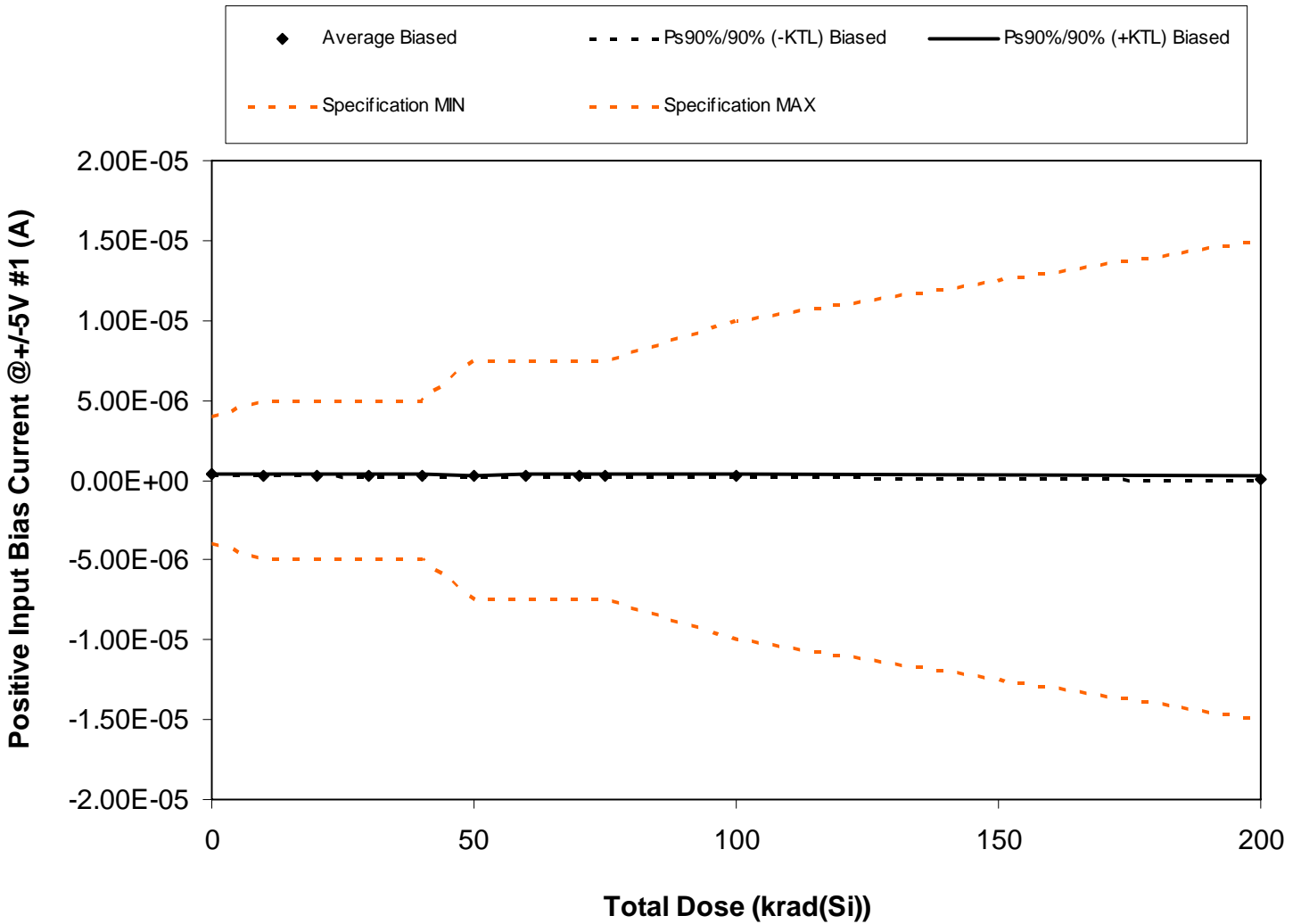

Figure 5.11. Plot of Positive Input Bias Current @ +/-5V #1 (A) versus total dose. The solid diamonds are the average of the measured data points for the samples irradiated under electrical bias and the black lines (solid and/or dashed) are the average of the data points after application of the KTL statistics on the samples irradiated under electrical bias. The red dotted line(s) are the pre- and/or post-irradiation minimum and/or maximum specification value as defined in the datasheet and/or test plan.



**RLAT Report
10-326 100808 R1.0**

**Radiation Assured Devices
5017 N. 30th Street
Colorado Springs, CO 80919
(719) 531-0800**

Table 5.11. Raw data for Positive Input Bias Current @+/-5V #1 (A) versus total dose, including the statistical analysis, specification and the status of the testing (pass/fail).

Positive Input Bias Current @+/-5V #1 (A)	Total Dose (krad(Si))											
	0	10	20	30	40	50	60	70	75	100	200	
Device												
1245	3.50E-07	3.30E-07	3.00E-07	2.80E-07	2.60E-07	2.40E-07	2.30E-07	2.20E-07	2.10E-07	1.90E-07	-5.00E-08	
1246	3.60E-07	3.30E-07	3.10E-07	3.00E-07	2.90E-07	2.80E-07	2.80E-07	2.80E-07	2.90E-07	2.80E-07	1.20E-07	
1247	3.00E-07	2.70E-07	2.40E-07	2.30E-07	2.20E-07	2.10E-07	2.00E-07	2.00E-07	2.00E-07	1.90E-07	2.00E-08	
1248	3.10E-07	2.80E-07	2.60E-07	2.50E-07	2.40E-07	2.30E-07	2.30E-07	2.20E-07	2.30E-07	2.20E-07	6.00E-08	
1249	2.80E-07	2.60E-07	2.40E-07	2.30E-07	2.20E-07	2.20E-07	2.20E-07	2.20E-07	2.30E-07	2.30E-07	1.10E-07	
1250	3.80E-07	3.40E-07	3.10E-07	3.00E-07	2.80E-07	2.70E-07	2.70E-07	2.70E-07	2.70E-07	2.60E-07	8.00E-08	
1251	4.00E-07	3.70E-07	3.40E-07	3.30E-07	3.20E-07	3.00E-07	3.00E-07	2.90E-07	3.00E-07	2.90E-07	1.20E-07	
1261	3.80E-07	3.30E-07	3.00E-07	2.90E-07	2.70E-07	2.60E-07	2.50E-07	2.40E-07	2.50E-07	2.40E-07	0.00E+00	
1262	3.70E-07	3.40E-07	3.20E-07	3.10E-07	3.10E-07	3.00E-07	3.00E-07	3.10E-07	3.10E-07	3.10E-07	2.00E-07	
1263	3.80E-07	3.40E-07	3.10E-07	2.90E-07	2.80E-07	2.80E-07	2.80E-07	2.80E-07	2.90E-07	2.80E-07	1.10E-07	
1264	3.20E-07	3.20E-07	3.20E-07	3.20E-07	3.20E-07	3.20E-07	3.20E-07	3.20E-07	3.20E-07	3.20E-07	3.20E-07	
1265	3.50E-07	3.50E-07	3.50E-07	3.50E-07	3.50E-07	3.50E-07	3.50E-07	3.50E-07	3.50E-07	3.50E-07	3.50E-07	
Biased Statistics												
Average Biased	3.51E-07	3.19E-07	2.93E-07	2.81E-07	2.69E-07	2.59E-07	2.56E-07	2.53E-07	2.58E-07	2.49E-07	7.70E-08	
Std Dev Biased	4.04E-08	3.60E-08	3.43E-08	3.38E-08	3.45E-08	3.25E-08	3.50E-08	3.74E-08	3.94E-08	4.18E-08	7.20E-08	
Ps90%/90% (+KTL) Biased	4.34E-07	3.93E-07	3.64E-07	3.51E-07	3.40E-07	3.26E-07	3.28E-07	3.30E-07	3.39E-07	3.35E-07	2.26E-07	
Ps90%/90% (-KTL) Biased	2.68E-07	2.45E-07	2.22E-07	2.11E-07	1.98E-07	1.92E-07	1.84E-07	1.76E-07	1.77E-07	1.63E-07	-7.16E-08	
Specification MIN	-4.00E-06	-5.00E-06	-5.00E-06	-5.00E-06	-5.00E-06	-7.50E-06	-7.50E-06	-7.50E-06	-7.50E-06	-1.00E-05	-1.50E-05	
Status	PASS	PASS	PASS	PASS	PASS	PASS	PASS	PASS	PASS	PASS	PASS	
Specification MAX	4.00E-06	5.00E-06	5.00E-06	5.00E-06	5.00E-06	7.50E-06	7.50E-06	7.50E-06	7.50E-06	1.00E-05	1.50E-05	
Status	PASS	PASS	PASS	PASS	PASS	PASS	PASS	PASS	PASS	PASS	PASS	

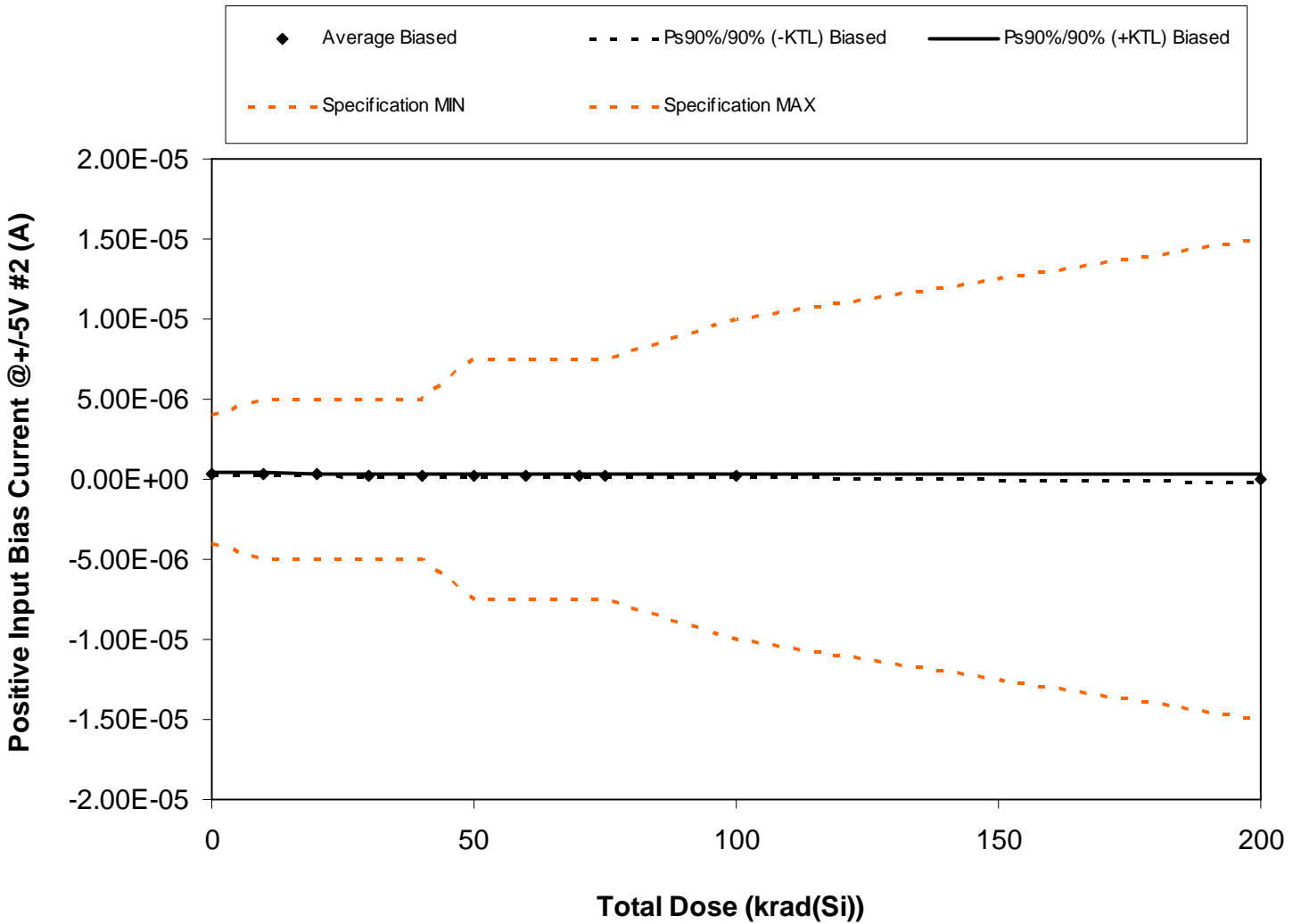

Figure 5.12. Plot of Positive Input Bias Current @ +/-5V #2 (A) versus total dose. The solid diamonds are the average of the measured data points for the samples irradiated under electrical bias and the black lines (solid and/or dashed) are the average of the data points after application of the KTL statistics on the samples irradiated under electrical bias. The red dotted line(s) are the pre- and/or post-irradiation minimum and/or maximum specification value as defined in the datasheet and/or test plan.



**RLAT Report
10-326 100808 R1.0**

**Radiation Assured Devices
5017 N. 30th Street
Colorado Springs, CO 80919
(719) 531-0800**

Table 5.12. Raw data for Positive Input Bias Current @+/-5V #2 (A) versus total dose, including the statistical analysis, specification and the status of the testing (pass/fail).

Positive Input Bias Current @+/-5V #2 (A)	Total Dose (krad(Si))											
	0	10	20	30	40	50	60	70	75	100	200	
Device												
1245	3.70E-07	3.40E-07	3.30E-07	3.10E-07	3.00E-07	2.90E-07	2.90E-07	2.90E-07	2.90E-07	2.80E-07	1.40E-07	
1246	3.30E-07	3.00E-07	2.70E-07	2.60E-07	2.40E-07	2.30E-07	2.30E-07	2.20E-07	2.30E-07	2.20E-07	3.00E-08	
1247	3.90E-07	3.70E-07	3.60E-07	3.60E-07	3.50E-07	3.60E-07	3.60E-07	3.70E-07	3.80E-07	3.90E-07	3.70E-07	
1248	2.50E-07	2.20E-07	2.00E-07	1.80E-07	1.70E-07	1.60E-07	1.50E-07	1.50E-07	1.50E-07	1.50E-07	-3.00E-08	
1249	3.30E-07	2.90E-07	2.70E-07	2.50E-07	2.40E-07	2.30E-07	2.30E-07	2.30E-07	2.40E-07	2.40E-07	7.00E-08	
1250	3.90E-07	3.40E-07	3.10E-07	2.80E-07	2.60E-07	2.40E-07	2.30E-07	2.20E-07	2.20E-07	2.00E-07	-8.00E-08	
1251	3.20E-07	2.90E-07	2.60E-07	2.40E-07	2.30E-07	2.20E-07	2.10E-07	2.10E-07	2.10E-07	2.00E-07	0.00E+00	
1261	3.30E-07	2.90E-07	2.60E-07	2.50E-07	2.30E-07	2.20E-07	2.10E-07	2.00E-07	2.00E-07	1.90E-07	-3.00E-08	
1262	3.10E-07	2.80E-07	2.50E-07	2.30E-07	2.20E-07	2.10E-07	2.00E-07	2.00E-07	2.00E-07	1.90E-07	-1.00E-08	
1263	2.80E-07	2.40E-07	2.10E-07	2.00E-07	1.90E-07	1.70E-07	1.70E-07	1.60E-07	1.60E-07	1.50E-07	-5.00E-08	
1264	4.10E-07	4.10E-07	4.10E-07	4.10E-07	4.10E-07	4.10E-07	4.10E-07	4.10E-07	4.10E-07	4.10E-07	4.10E-07	
1265	4.00E-07	4.00E-07	4.00E-07	3.90E-07	4.00E-07	4.00E-07	4.00E-07	4.00E-07	4.00E-07	4.00E-07	4.00E-07	
Biased Statistics												
Average Biased	3.30E-07	2.96E-07	2.72E-07	2.56E-07	2.43E-07	2.33E-07	2.28E-07	2.25E-07	2.28E-07	2.21E-07	4.10E-08	
Std Dev Biased	4.50E-08	4.55E-08	4.98E-08	5.19E-08	5.17E-08	5.74E-08	5.98E-08	6.38E-08	6.65E-08	7.09E-08	1.32E-07	
Ps90%/90% (+KTL) Biased	4.23E-07	3.90E-07	3.75E-07	3.63E-07	3.50E-07	3.51E-07	3.51E-07	3.57E-07	3.65E-07	3.67E-07	3.13E-07	
Ps90%/90% (-KTL) Biased	2.37E-07	2.02E-07	1.69E-07	1.49E-07	1.36E-07	1.15E-07	1.05E-07	9.32E-08	9.07E-08	7.45E-08	-2.31E-07	
Specification MIN	-4.00E-06	-5.00E-06	-5.00E-06	-5.00E-06	-5.00E-06	-7.50E-06	-7.50E-06	-7.50E-06	-7.50E-06	-1.00E-05	-1.50E-05	
Status	PASS	PASS	PASS	PASS	PASS	PASS	PASS	PASS	PASS	PASS	PASS	
Specification MAX	4.00E-06	5.00E-06	5.00E-06	5.00E-06	5.00E-06	7.50E-06	7.50E-06	7.50E-06	7.50E-06	1.00E-05	1.50E-05	
Status	PASS	PASS	PASS	PASS	PASS	PASS	PASS	PASS	PASS	PASS	PASS	

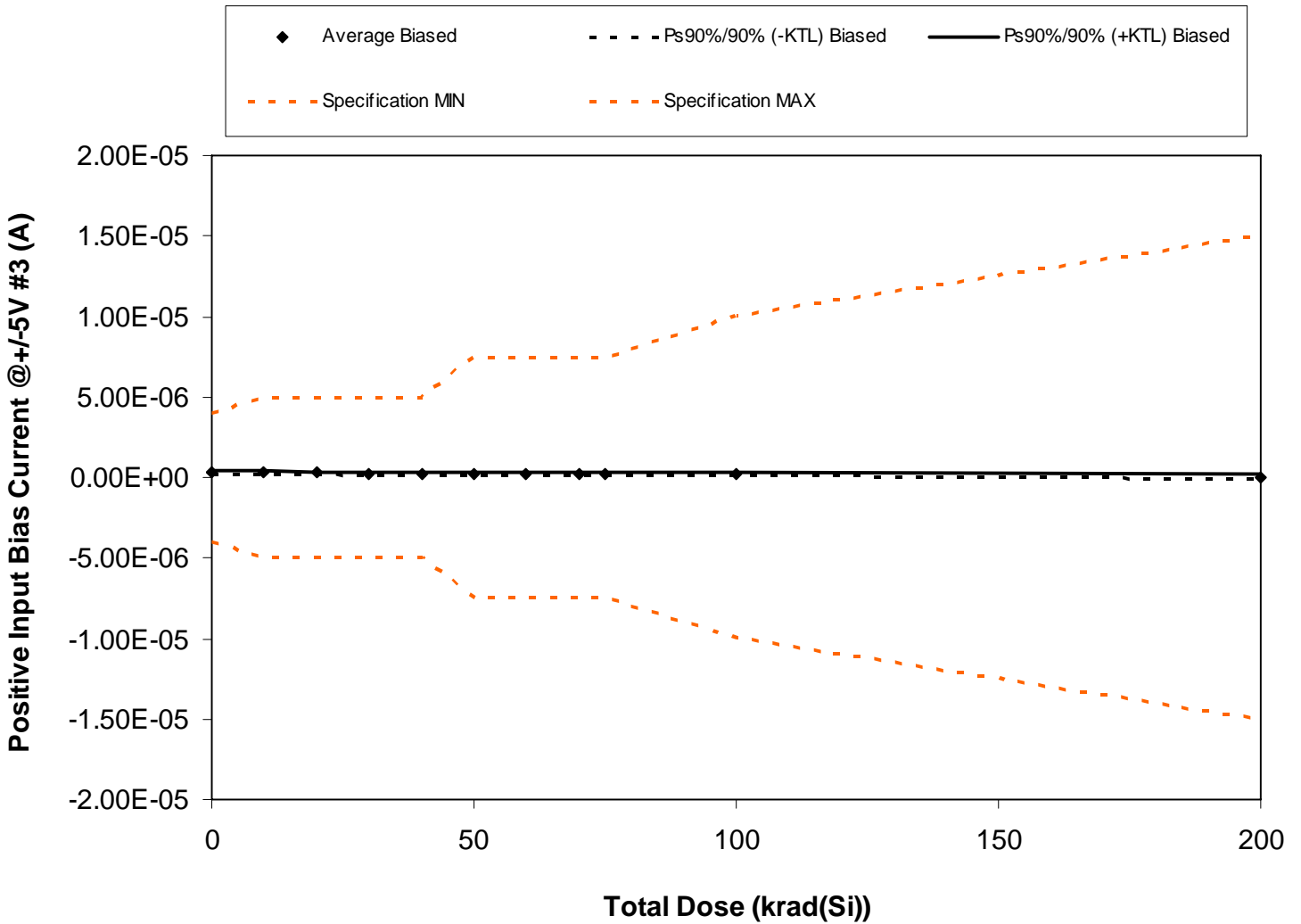

Figure 5.13. Plot of Positive Input Bias Current @ +/-5V #3 (A) versus total dose. The solid diamonds are the average of the measured data points for the samples irradiated under electrical bias and the black lines (solid and/or dashed) are the average of the data points after application of the KTL statistics on the samples irradiated under electrical bias. The red dotted line(s) are the pre- and/or post-irradiation minimum and/or maximum specification value as defined in the datasheet and/or test plan.



**RLAT Report
10-326 100808 R1.0**

**Radiation Assured Devices
5017 N. 30th Street
Colorado Springs, CO 80919
(719) 531-0800**

Table 5.13. Raw data for Positive Input Bias Current @+/-5V #3 (A) versus total dose, including the statistical analysis, specification and the status of the testing (pass/fail).

Positive Input Bias Current @+/-5V #3 (A)	Total Dose (krad(Si))											
	0	10	20	30	40	50	60	70	75	100	200	
Device												
1245	3.70E-07	3.40E-07	3.20E-07	3.10E-07	2.90E-07	2.80E-07	2.80E-07	2.80E-07	2.80E-07	2.70E-07	1.00E-07	
1246	3.00E-07	2.70E-07	2.50E-07	2.30E-07	2.20E-07	2.10E-07	2.10E-07	2.10E-07	2.10E-07	2.10E-07	3.00E-08	
1247	4.00E-07	3.60E-07	3.40E-07	3.30E-07	3.10E-07	3.00E-07	2.90E-07	3.00E-07	3.00E-07	3.00E-07	1.20E-07	
1248	2.50E-07	2.20E-07	2.00E-07	1.90E-07	1.90E-07	1.80E-07	1.80E-07	1.80E-07	1.80E-07	1.80E-07	7.00E-08	
1249	3.40E-07	3.00E-07	2.80E-07	2.70E-07	2.60E-07	2.50E-07	2.50E-07	2.50E-07	2.50E-07	2.50E-07	9.00E-08	
1250	3.80E-07	3.40E-07	3.10E-07	2.90E-07	2.70E-07	2.50E-07	2.40E-07	2.30E-07	2.30E-07	2.20E-07	-2.00E-08	
1251	3.30E-07	3.00E-07	2.70E-07	2.50E-07	2.40E-07	2.40E-07	2.30E-07	2.30E-07	2.30E-07	2.20E-07	2.00E-08	
1261	3.40E-07	3.10E-07	2.90E-07	2.80E-07	2.70E-07	2.70E-07	2.60E-07	2.60E-07	2.60E-07	2.60E-07	1.00E-07	
1262	3.20E-07	2.80E-07	2.70E-07	2.50E-07	2.40E-07	2.30E-07	2.30E-07	2.30E-07	2.30E-07	2.20E-07	5.00E-08	
1263	2.60E-07	2.20E-07	2.00E-07	1.80E-07	1.70E-07	1.60E-07	1.50E-07	1.50E-07	1.50E-07	1.40E-07	-4.00E-08	
1264	3.70E-07	3.70E-07	3.70E-07	3.70E-07	3.70E-07	3.70E-07	3.70E-07	3.70E-07	3.70E-07	3.70E-07	3.70E-07	
1265	3.80E-07	3.80E-07	3.80E-07	3.80E-07	3.80E-07	3.80E-07	3.80E-07	3.80E-07	3.80E-07	3.80E-07	3.80E-07	
Biased Statistics												
Average Biased	3.29E-07	2.94E-07	2.73E-07	2.58E-07	2.46E-07	2.37E-07	2.32E-07	2.32E-07	2.32E-07	2.27E-07	5.20E-08	
Std Dev Biased	4.89E-08	4.79E-08	4.67E-08	4.85E-08	4.35E-08	4.37E-08	4.32E-08	4.47E-08	4.47E-08	4.60E-08	5.39E-08	
Ps90%/90% (+KTL) Biased	4.30E-07	3.93E-07	3.69E-07	3.58E-07	3.36E-07	3.27E-07	3.21E-07	3.24E-07	3.24E-07	3.22E-07	1.63E-07	
Ps90%/90% (-KTL) Biased	2.28E-07	1.95E-07	1.77E-07	1.58E-07	1.56E-07	1.47E-07	1.43E-07	1.40E-07	1.40E-07	1.32E-07	-5.93E-08	
Specification MIN	-4.00E-06	-5.00E-06	-5.00E-06	-5.00E-06	-5.00E-06	-7.50E-06	-7.50E-06	-7.50E-06	-7.50E-06	-1.00E-05	-1.50E-05	
Status	PASS	PASS	PASS	PASS	PASS	PASS	PASS	PASS	PASS	PASS	PASS	
Specification MAX	4.00E-06	5.00E-06	5.00E-06	5.00E-06	5.00E-06	7.50E-06	7.50E-06	7.50E-06	7.50E-06	1.00E-05	1.50E-05	
Status	PASS	PASS	PASS	PASS	PASS	PASS	PASS	PASS	PASS	PASS	PASS	

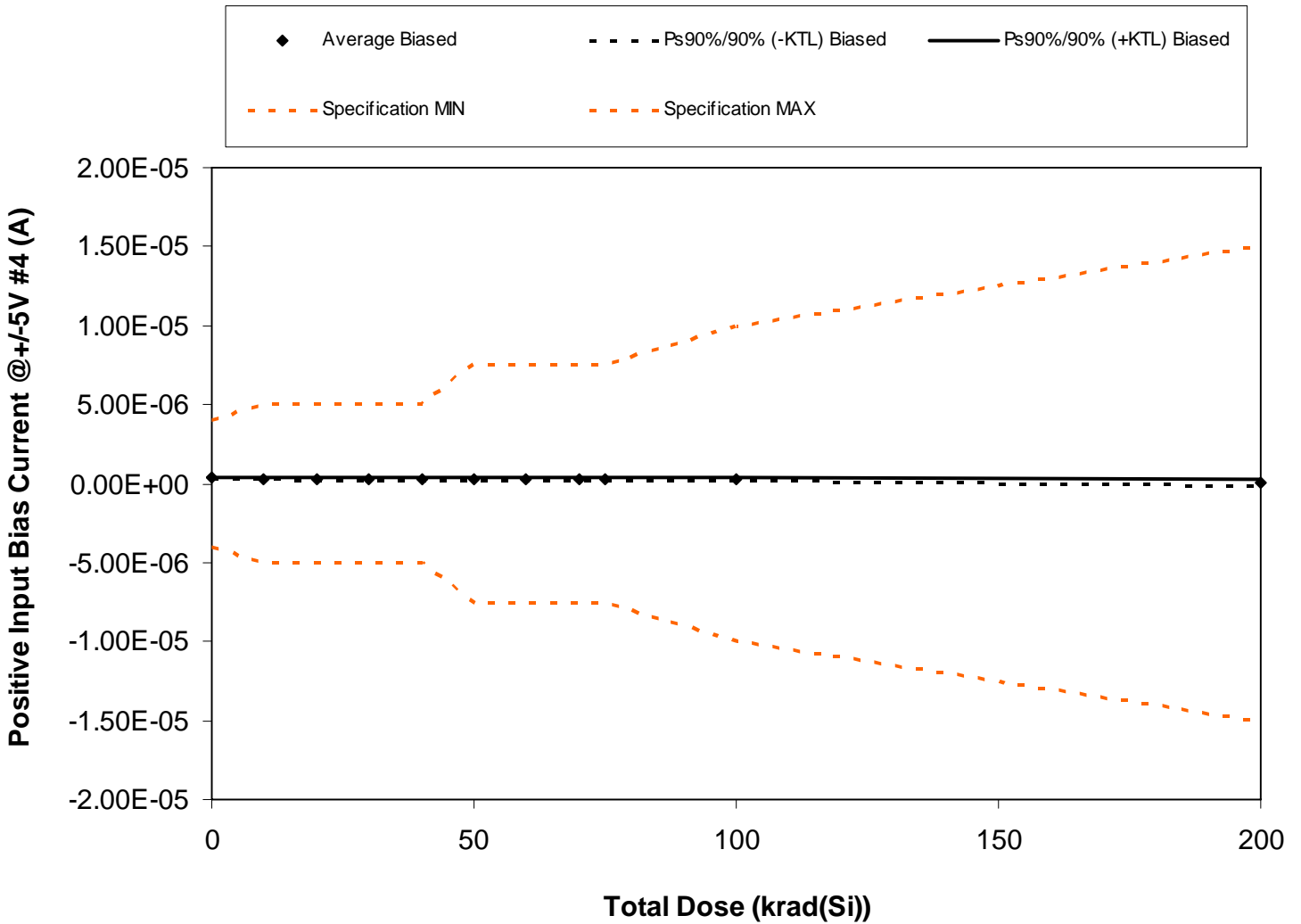

Figure 5.14. Plot of Positive Input Bias Current @ +/-5V #4 (A) versus total dose. The solid diamonds are the average of the measured data points for the samples irradiated under electrical bias and the black lines (solid and/or dashed) are the average of the data points after application of the KTL statistics on the samples irradiated under electrical bias. The red dotted line(s) are the pre- and/or post-irradiation minimum and/or maximum specification value as defined in the datasheet and/or test plan.



**RLAT Report
10-326 100808 R1.0**

**Radiation Assured Devices
5017 N. 30th Street
Colorado Springs, CO 80919
(719) 531-0800**

Table 5.14. Raw data for Positive Input Bias Current @+/-5V #4 (A) versus total dose, including the statistical analysis, specification and the status of the testing (pass/fail).

Positive Input Bias Current @+/-5V #4 (A)	Total Dose (krad(Si))											
	0	10	20	30	40	50	60	70	75	100	200	
Device												
1245	3.50E-07	3.20E-07	2.90E-07	2.70E-07	2.50E-07	2.30E-07	2.20E-07	2.10E-07	2.10E-07	2.00E-07	-6.00E-08	
1246	3.70E-07	3.40E-07	3.20E-07	3.00E-07	2.90E-07	2.80E-07	2.70E-07	2.60E-07	2.70E-07	2.60E-07	7.00E-08	
1247	2.90E-07	2.60E-07	2.40E-07	2.20E-07	2.10E-07	2.00E-07	1.90E-07	1.90E-07	1.90E-07	1.80E-07	-2.00E-08	
1248	3.50E-07	3.10E-07	2.90E-07	2.70E-07	2.60E-07	2.40E-07	2.30E-07	2.30E-07	2.30E-07	2.30E-07	2.00E-08	
1249	3.00E-07	2.70E-07	2.50E-07	2.40E-07	2.30E-07	2.20E-07	2.20E-07	2.20E-07	2.20E-07	2.30E-07	8.00E-08	
1250	3.70E-07	3.20E-07	2.90E-07	2.70E-07	2.60E-07	2.50E-07	2.40E-07	2.30E-07	2.30E-07	2.20E-07	-2.00E-08	
1251	4.10E-07	3.70E-07	3.50E-07	3.40E-07	3.20E-07	3.10E-07	3.10E-07	3.10E-07	3.10E-07	3.00E-07	1.20E-07	
1261	3.90E-07	3.70E-07	3.60E-07	3.60E-07	3.60E-07	3.60E-07	3.60E-07	3.70E-07	3.80E-07	3.90E-07	3.80E-07	
1262	3.60E-07	3.20E-07	2.90E-07	2.60E-07	2.50E-07	2.40E-07	2.30E-07	2.20E-07	2.30E-07	2.00E-07	-3.00E-08	
1263	3.50E-07	3.00E-07	2.70E-07	2.50E-07	2.30E-07	2.20E-07	2.20E-07	2.20E-07	2.20E-07	2.10E-07	-4.00E-08	
1264	3.50E-07	3.50E-07	3.50E-07	3.50E-07	3.50E-07	3.50E-07	3.50E-07	3.50E-07	3.50E-07	3.50E-07	3.50E-07	
1265	3.50E-07	3.40E-07	3.40E-07	3.40E-07	3.50E-07	3.50E-07	3.40E-07	3.40E-07	3.50E-07	3.50E-07	3.50E-07	
Biased Statistics												
Average Biased	3.54E-07	3.18E-07	2.95E-07	2.78E-07	2.66E-07	2.55E-07	2.49E-07	2.46E-07	2.49E-07	2.42E-07	5.00E-08	
Std Dev Biased	3.66E-08	3.65E-08	3.89E-08	4.37E-08	4.55E-08	4.86E-08	5.09E-08	5.44E-08	5.69E-08	6.21E-08	1.30E-07	
Ps90%/90% (+KTL) Biased	4.30E-07	3.93E-07	3.75E-07	3.68E-07	3.60E-07	3.55E-07	3.54E-07	3.58E-07	3.66E-07	3.70E-07	3.19E-07	
Ps90%/90% (-KTL) Biased	2.78E-07	2.43E-07	2.15E-07	1.88E-07	1.72E-07	1.55E-07	1.44E-07	1.34E-07	1.32E-07	1.14E-07	-2.19E-07	
Specification MIN	-4.00E-06	-5.00E-06	-5.00E-06	-5.00E-06	-5.00E-06	-7.50E-06	-7.50E-06	-7.50E-06	-7.50E-06	-1.00E-05	-1.50E-05	
Status	PASS	PASS	PASS	PASS	PASS	PASS	PASS	PASS	PASS	PASS	PASS	
Specification MAX	4.00E-06	5.00E-06	5.00E-06	5.00E-06	5.00E-06	7.50E-06	7.50E-06	7.50E-06	7.50E-06	1.00E-05	1.50E-05	
Status	PASS	PASS	PASS	PASS	PASS	PASS	PASS	PASS	PASS	PASS	PASS	

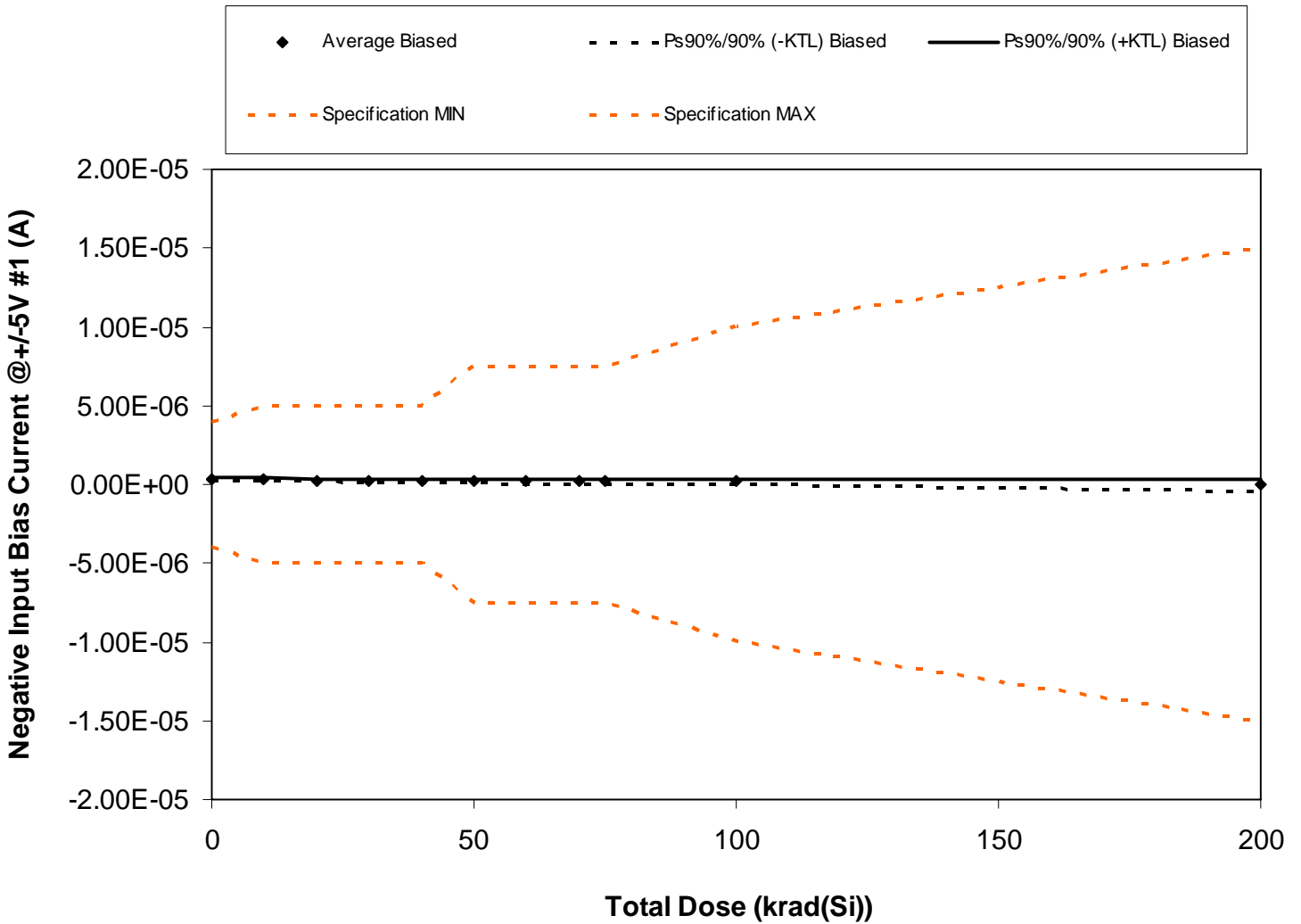

Figure 5.15. Plot of Negative Input Bias Current @ +/-5V #1 (A) versus total dose. The solid diamonds are the average of the measured data points for the samples irradiated under electrical bias and the black lines (solid and/or dashed) are the average of the data points after application of the KTL statistics on the samples irradiated under electrical bias. The red dotted line(s) are the pre- and/or post-irradiation minimum and/or maximum specification value as defined in the datasheet and/or test plan.



**RLAT Report
10-326 100808 R1.0**

**Radiation Assured Devices
5017 N. 30th Street
Colorado Springs, CO 80919
(719) 531-0800**

Table 5.15. Raw data for Negative Input Bias Current @+/-5V #1 (A) versus total dose, including the statistical analysis, specification and the status of the testing (pass/fail).

Negative Input Bias Current @+/-5V #1 (A)	Total Dose (krad(Si))											
	0	10	20	30	40	50	60	70	75	100	200	
Device												
1245	3.90E-07	3.50E-07	3.30E-07	3.20E-07	3.00E-07	3.00E-07	2.90E-07	2.90E-07	3.00E-07	2.80E-07	1.50E-07	
1246	3.50E-07	3.00E-07	2.50E-07	2.30E-07	2.00E-07	1.70E-07	1.60E-07	1.50E-07	1.50E-07	1.10E-07	-1.60E-07	
1247	2.70E-07	2.20E-07	1.80E-07	1.50E-07	1.20E-07	1.00E-07	8.00E-08	6.00E-08	6.00E-08	2.00E-08	-3.00E-07	
1248	3.10E-07	2.80E-07	2.50E-07	2.20E-07	2.10E-07	1.90E-07	1.80E-07	1.70E-07	1.70E-07	1.20E-07	-4.00E-08	
1249	3.00E-07	2.60E-07	2.40E-07	2.30E-07	2.20E-07	2.20E-07	2.20E-07	2.20E-07	2.30E-07	2.30E-07	1.50E-07	
1250	3.80E-07	3.40E-07	3.20E-07	3.00E-07	3.00E-07	2.90E-07	2.90E-07	2.90E-07	2.90E-07	2.80E-07	1.60E-07	
1251	4.00E-07	3.60E-07	3.40E-07	3.30E-07	3.20E-07	3.20E-07	3.10E-07	3.20E-07	3.20E-07	3.10E-07	2.00E-07	
1261	3.80E-07	3.30E-07	3.00E-07	2.80E-07	2.60E-07	2.50E-07	2.40E-07	2.40E-07	2.30E-07	2.10E-07	-3.00E-08	
1262	3.50E-07	2.90E-07	2.50E-07	2.20E-07	2.00E-07	1.80E-07	1.60E-07	1.50E-07	1.40E-07	1.00E-07	-2.10E-07	
1263	3.60E-07	3.00E-07	2.60E-07	2.30E-07	1.90E-07	1.70E-07	1.50E-07	1.40E-07	1.40E-07	1.00E-07	-2.20E-07	
1264	3.20E-07	3.20E-07	3.20E-07	3.20E-07	3.20E-07	3.20E-07	3.20E-07	3.20E-07	3.20E-07	3.20E-07	3.20E-07	
1265	3.40E-07	3.40E-07	3.40E-07	3.40E-07	3.40E-07	3.40E-07	3.40E-07	3.40E-07	3.40E-07	3.40E-07	3.40E-07	
Biased Statistics												
Average Biased	3.49E-07	3.03E-07	2.72E-07	2.51E-07	2.32E-07	2.19E-07	2.08E-07	2.03E-07	2.03E-07	1.76E-07	-3.00E-08	
Std Dev Biased	4.28E-08	4.35E-08	4.96E-08	5.55E-08	6.21E-08	7.00E-08	7.47E-08	8.27E-08	8.46E-08	9.83E-08	1.86E-07	
Ps90%/90% (+KTL) Biased	4.37E-07	3.93E-07	3.74E-07	3.66E-07	3.60E-07	3.64E-07	3.62E-07	3.74E-07	3.78E-07	3.79E-07	3.55E-07	
Ps90%/90% (-KTL) Biased	2.61E-07	2.13E-07	1.70E-07	1.36E-07	1.04E-07	7.45E-08	5.38E-08	3.21E-08	2.83E-08	-2.71E-08	-4.15E-07	
Specification MIN	-4.00E-06	-5.00E-06	-5.00E-06	-5.00E-06	-5.00E-06	-7.50E-06	-7.50E-06	-7.50E-06	-7.50E-06	-1.00E-05	-1.50E-05	
Status	PASS	PASS	PASS	PASS	PASS	PASS	PASS	PASS	PASS	PASS	PASS	
Specification MAX	4.00E-06	5.00E-06	5.00E-06	5.00E-06	5.00E-06	7.50E-06	7.50E-06	7.50E-06	7.50E-06	1.00E-05	1.50E-05	
Status	PASS	PASS	PASS	PASS	PASS	PASS	PASS	PASS	PASS	PASS	PASS	

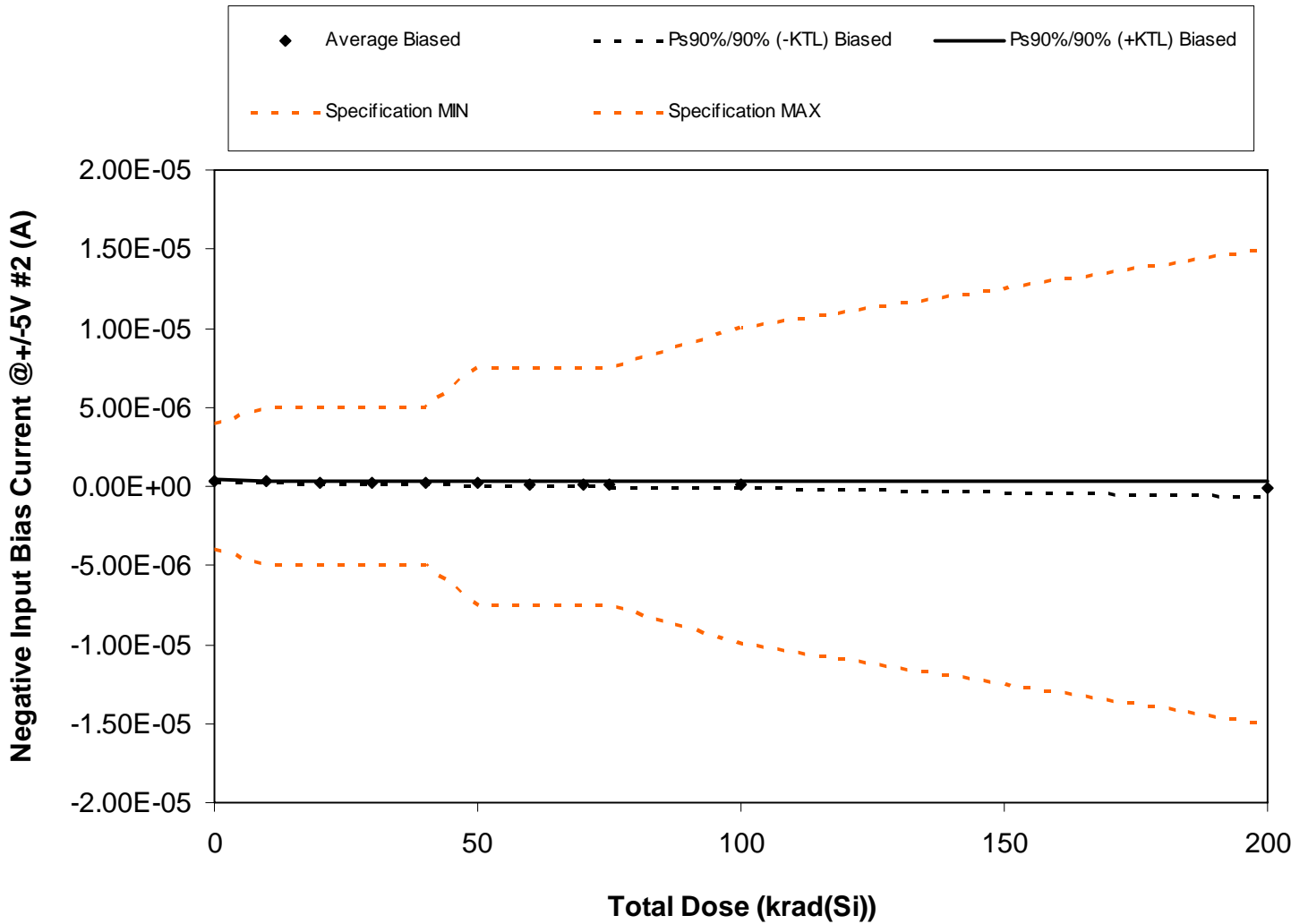

Figure 5.16. Plot of Negative Input Bias Current @ +/-5V #2 (A) versus total dose. The solid diamonds are the average of the measured data points for the samples irradiated under electrical bias and the black lines (solid and/or dashed) are the average of the data points after application of the KTL statistics on the samples irradiated under electrical bias. The red dotted line(s) are the pre- and/or post-irradiation minimum and/or maximum specification value as defined in the datasheet and/or test plan.



**RLAT Report
10-326 100808 R1.0**

**Radiation Assured Devices
5017 N. 30th Street
Colorado Springs, CO 80919
(719) 531-0800**

Table 5.16. Raw data for Negative Input Bias Current @+/-5V #2 (A) versus total dose, including the statistical analysis, specification and the status of the testing (pass/fail).

Negative Input Bias Current @+/-5V #2 (A)	Total Dose (krad(Si))											
	0	10	20	30	40	50	60	70	75	100	200	
Device												
1245	3.60E-07	3.40E-07	3.20E-07	3.10E-07	3.00E-07	3.00E-07	3.00E-07	3.00E-07	3.10E-07	3.00E-07	2.40E-07	
1246	3.50E-07	3.00E-07	2.60E-07	2.20E-07	2.00E-07	1.70E-07	1.50E-07	1.30E-07	1.30E-07	8.00E-08	-2.50E-07	
1247	3.70E-07	3.30E-07	3.10E-07	3.00E-07	3.00E-07	2.90E-07	2.90E-07	2.90E-07	2.90E-07	2.90E-07	1.70E-07	
1248	2.50E-07	2.20E-07	1.70E-07	1.30E-07	9.00E-08	6.00E-08	3.00E-08	0.00E+00	-2.00E-08	-1.00E-07	-4.10E-07	
1249	3.40E-07	2.90E-07	2.40E-07	2.10E-07	1.80E-07	1.60E-07	1.40E-07	1.30E-07	1.30E-07	9.00E-08	-2.20E-07	
1250	3.70E-07	3.00E-07	2.50E-07	2.10E-07	1.70E-07	1.40E-07	1.10E-07	8.00E-08	8.00E-08	2.00E-08	-3.80E-07	
1251	3.20E-07	2.70E-07	2.20E-07	1.90E-07	1.70E-07	1.50E-07	1.20E-07	1.10E-07	1.10E-07	7.00E-08	-2.60E-07	
1261	3.50E-07	2.90E-07	2.50E-07	2.10E-07	1.80E-07	1.50E-07	1.30E-07	1.10E-07	1.00E-07	5.00E-08	-3.10E-07	
1262	3.20E-07	2.60E-07	2.20E-07	1.80E-07	1.50E-07	1.20E-07	1.00E-07	9.00E-08	8.00E-08	4.00E-08	-3.10E-07	
1263	2.70E-07	2.40E-07	2.20E-07	2.10E-07	2.10E-07	2.00E-07	2.00E-07	2.00E-07	2.10E-07	2.00E-07	1.00E-07	
1264	3.80E-07	3.80E-07	3.80E-07	3.80E-07	3.80E-07	3.80E-07	3.80E-07	3.80E-07	3.80E-07	3.80E-07	3.80E-07	
1265	3.80E-07	3.80E-07	3.80E-07	3.80E-07	3.80E-07	3.80E-07	3.80E-07	3.80E-07	3.80E-07	3.80E-07	3.80E-07	
Biased Statistics												
Average Biased	3.30E-07	2.84E-07	2.46E-07	2.17E-07	1.95E-07	1.74E-07	1.57E-07	1.44E-07	1.42E-07	1.04E-07	-1.63E-07	
Std Dev Biased	4.11E-08	3.75E-08	4.43E-08	5.31E-08	6.42E-08	7.34E-08	8.43E-08	9.38E-08	1.01E-07	1.25E-07	2.39E-07	
Ps90%/90% (+KTL) Biased	4.15E-07	3.61E-07	3.37E-07	3.27E-07	3.27E-07	3.25E-07	3.31E-07	3.38E-07	3.51E-07	3.61E-07	3.30E-07	
Ps90%/90% (-KTL) Biased	2.45E-07	2.07E-07	1.55E-07	1.07E-07	6.25E-08	2.25E-08	-1.71E-08	-4.98E-08	-6.65E-08	-1.53E-07	-6.56E-07	
Specification MIN	-4.00E-06	-5.00E-06	-5.00E-06	-5.00E-06	-5.00E-06	-7.50E-06	-7.50E-06	-7.50E-06	-7.50E-06	-1.00E-05	-1.50E-05	
Status	PASS	PASS	PASS	PASS	PASS	PASS	PASS	PASS	PASS	PASS	PASS	
Specification MAX	4.00E-06	5.00E-06	5.00E-06	5.00E-06	5.00E-06	7.50E-06	7.50E-06	7.50E-06	7.50E-06	1.00E-05	1.50E-05	
Status	PASS	PASS	PASS	PASS	PASS	PASS	PASS	PASS	PASS	PASS	PASS	

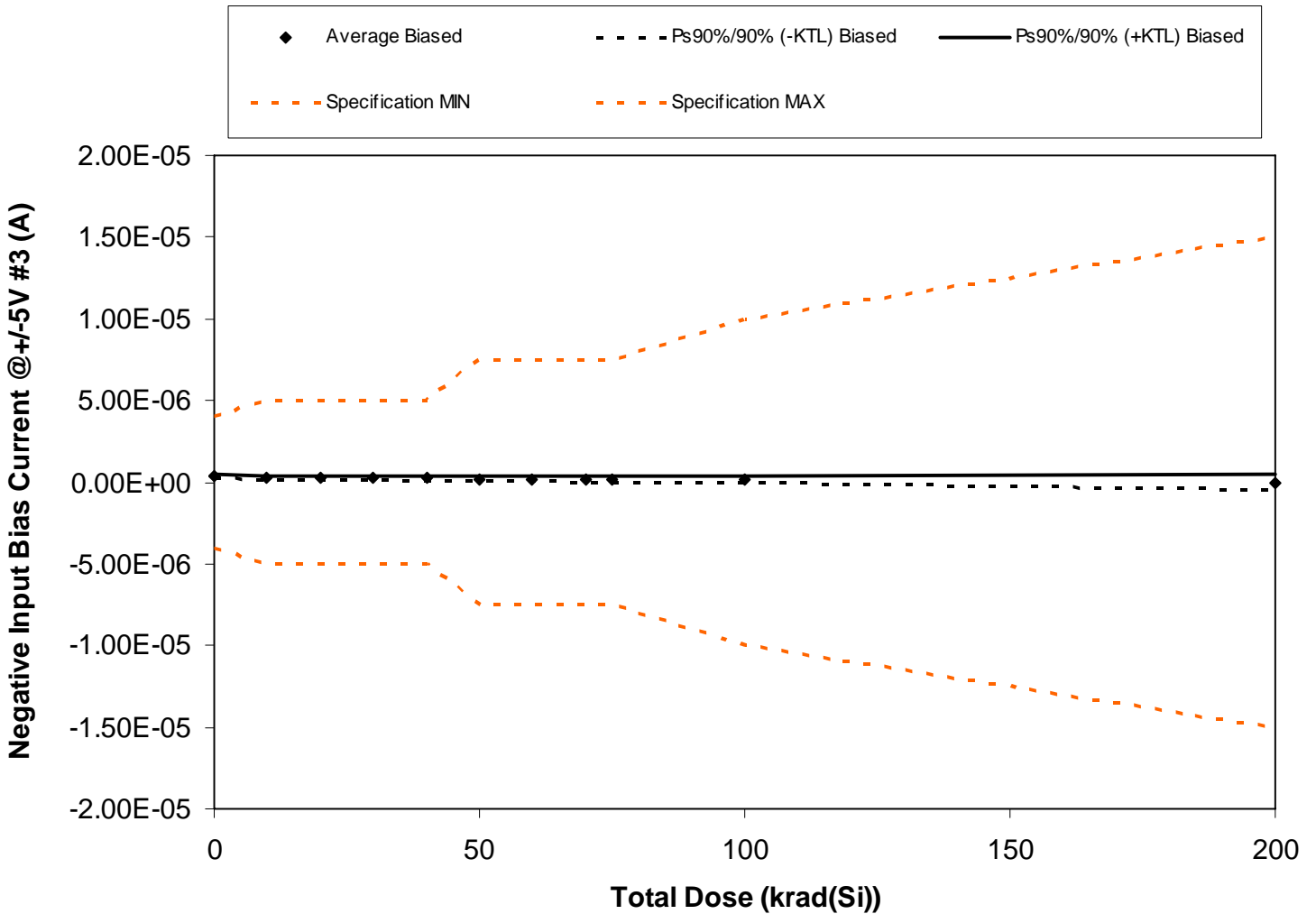

Figure 5.17. Plot of Negative Input Bias Current @ +/-5V #3 (A) versus total dose. The solid diamonds are the average of the measured data points for the samples irradiated under electrical bias and the black lines (solid and/or dashed) are the average of the data points after application of the KTL statistics on the samples irradiated under electrical bias. The red dotted line(s) are the pre- and/or post-irradiation minimum and/or maximum specification value as defined in the datasheet and/or test plan.



**RLAT Report
10-326 100808 R1.0**

**Radiation Assured Devices
5017 N. 30th Street
Colorado Springs, CO 80919
(719) 531-0800**

Table 5.17. Raw data for Negative Input Bias Current @+/-5V #3 (A) versus total dose, including the statistical analysis, specification and the status of the testing (pass/fail).

Negative Input Bias Current @+/-5V #3 (A)	Total Dose (krad(Si))											
	0	10	20	30	40	50	60	70	75	100	200	
Device												
1245	3.90E-07	3.60E-07	3.40E-07	3.20E-07	3.10E-07	3.10E-07	3.10E-07	3.10E-07	3.10E-07	3.00E-07	1.80E-07	
1246	3.30E-07	2.80E-07	2.40E-07	2.10E-07	1.80E-07	1.60E-07	1.40E-07	1.20E-07	1.20E-07	8.00E-08	-2.30E-07	
1247	3.70E-07	3.20E-07	2.80E-07	2.50E-07	2.20E-07	2.00E-07	1.80E-07	1.60E-07	1.60E-07	1.20E-07	-2.00E-07	
1248	2.40E-07	2.10E-07	1.70E-07	1.30E-07	1.00E-07	7.00E-08	4.00E-08	1.00E-08	0.00E+00	-7.00E-08	-3.30E-07	
1249	3.40E-07	2.90E-07	2.40E-07	2.10E-07	1.80E-07	1.60E-07	1.40E-07	1.30E-07	1.30E-07	1.00E-07	-2.00E-07	
1250	3.90E-07	3.50E-07	3.30E-07	3.10E-07	3.10E-07	3.00E-07	3.00E-07	3.00E-07	3.00E-07	2.90E-07	1.60E-07	
1251	3.20E-07	2.70E-07	2.30E-07	2.00E-07	1.70E-07	1.50E-07	1.20E-07	1.10E-07	1.10E-07	7.00E-08	-2.60E-07	
1261	3.50E-07	3.20E-07	3.00E-07	3.00E-07	2.90E-07	2.90E-07	2.90E-07	2.90E-07	3.00E-07	2.90E-07	2.30E-07	
1262	3.20E-07	2.90E-07	2.80E-07	2.70E-07	2.60E-07	2.60E-07	2.70E-07	2.70E-07	2.70E-07	2.70E-07	2.20E-07	
1263	2.70E-07	2.30E-07	2.10E-07	2.00E-07	1.90E-07	1.90E-07	1.90E-07	1.90E-07	2.00E-07	2.00E-07	9.00E-08	
1264	3.60E-07	3.60E-07	3.60E-07	3.60E-07	3.60E-07	3.60E-07	3.60E-07	3.60E-07	3.60E-07	3.60E-07	3.60E-07	
1265	3.80E-07	3.70E-07	3.70E-07	3.80E-07	3.80E-07	3.80E-07	3.80E-07	3.70E-07	3.80E-07	3.80E-07	3.80E-07	
Biased Statistics												
Average Biased	3.32E-07	2.92E-07	2.62E-07	2.40E-07	2.21E-07	2.09E-07	1.98E-07	1.89E-07	1.90E-07	1.65E-07	-3.40E-08	
Std Dev Biased	4.85E-08	4.80E-08	5.37E-08	6.06E-08	6.97E-08	7.87E-08	9.11E-08	1.01E-07	1.04E-07	1.24E-07	2.27E-07	
Ps90%/90% (+KTL) Biased	4.32E-07	3.91E-07	3.73E-07	3.65E-07	3.65E-07	3.71E-07	3.86E-07	3.97E-07	4.04E-07	4.22E-07	4.36E-07	
Ps90%/90% (-KTL) Biased	2.32E-07	1.93E-07	1.51E-07	1.15E-07	7.71E-08	4.66E-08	9.79E-09	-1.87E-08	-2.44E-08	-9.20E-08	-5.04E-07	
Specification MIN	-4.00E-06	-5.00E-06	-5.00E-06	-5.00E-06	-5.00E-06	-7.50E-06	-7.50E-06	-7.50E-06	-7.50E-06	-1.00E-05	-1.50E-05	
Status	PASS	PASS	PASS	PASS	PASS	PASS	PASS	PASS	PASS	PASS	PASS	
Specification MAX	4.00E-06	5.00E-06	5.00E-06	5.00E-06	5.00E-06	7.50E-06	7.50E-06	7.50E-06	7.50E-06	1.00E-05	1.50E-05	
Status	PASS	PASS	PASS	PASS	PASS	PASS	PASS	PASS	PASS	PASS	PASS	

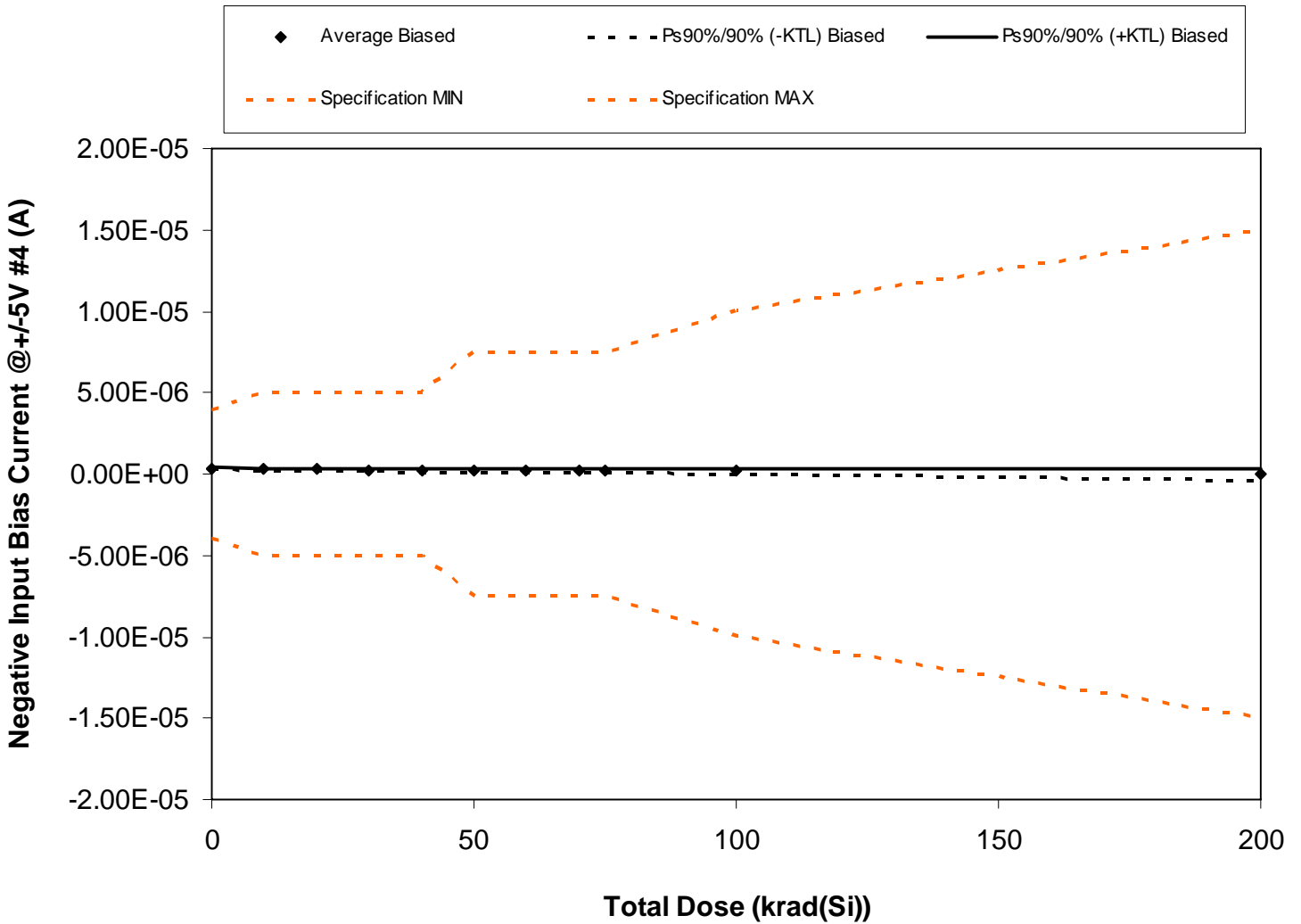

Figure 5.18. Plot of Negative Input Bias Current @ +/-5V #4 (A) versus total dose. The solid diamonds are the average of the measured data points for the samples irradiated under electrical bias and the black lines (solid and/or dashed) are the average of the data points after application of the KTL statistics on the samples irradiated under electrical bias. The red dotted line(s) are the pre- and/or post-irradiation minimum and/or maximum specification value as defined in the datasheet and/or test plan.



**RLAT Report
10-326 100808 R1.0**

**Radiation Assured Devices
5017 N. 30th Street
Colorado Springs, CO 80919
(719) 531-0800**

Table 5.18. Raw data for Negative Input Bias Current @+/-5V #4 (A) versus total dose, including the statistical analysis, specification and the status of the testing (pass/fail).

Negative Input Bias Current @+/-5V #4 (A)	Total Dose (krad(Si))											
	0	10	20	30	40	50	60	70	75	100	200	
Device												
1245	3.60E-07	3.20E-07	2.90E-07	2.80E-07	2.60E-07	2.50E-07	2.40E-07	2.40E-07	2.40E-07	2.20E-07	5.00E-08	
1246	3.70E-07	3.30E-07	3.10E-07	3.00E-07	2.90E-07	2.80E-07	2.80E-07	2.80E-07	2.80E-07	2.70E-07	1.40E-07	
1247	3.10E-07	2.70E-07	2.40E-07	2.30E-07	2.30E-07	2.20E-07	2.20E-07	2.10E-07	2.20E-07	2.00E-07	5.00E-08	
1248	3.50E-07	3.30E-07	3.10E-07	3.00E-07	2.80E-07	2.80E-07	2.70E-07	2.60E-07	2.70E-07	2.40E-07	1.60E-07	
1249	3.00E-07	2.50E-07	2.30E-07	2.00E-07	1.90E-07	1.80E-07	1.70E-07	1.60E-07	1.60E-07	1.50E-07	-3.00E-08	
1250	3.90E-07	3.40E-07	3.10E-07	3.00E-07	2.90E-07	2.70E-07	2.70E-07	2.60E-07	2.60E-07	2.50E-07	6.00E-08	
1251	3.80E-07	3.30E-07	2.90E-07	2.70E-07	2.50E-07	2.40E-07	2.20E-07	2.10E-07	2.10E-07	1.80E-07	-8.00E-08	
1261	3.60E-07	3.10E-07	2.70E-07	2.40E-07	2.10E-07	2.00E-07	1.70E-07	1.60E-07	1.60E-07	1.10E-07	-2.10E-07	
1262	3.60E-07	3.00E-07	2.50E-07	2.10E-07	1.80E-07	1.50E-07	1.30E-07	1.10E-07	1.00E-07	5.00E-08	-3.00E-07	
1263	3.60E-07	3.00E-07	2.50E-07	2.10E-07	1.80E-07	1.50E-07	1.20E-07	1.10E-07	1.10E-07	6.00E-08	-2.90E-07	
1264	3.60E-07	3.50E-07	3.50E-07	3.50E-07	3.50E-07	3.50E-07	3.50E-07	3.50E-07	3.50E-07	3.50E-07	3.50E-07	
1265	3.30E-07	3.30E-07	3.30E-07	3.30E-07	3.30E-07	3.30E-07	3.30E-07	3.30E-07	3.40E-07	3.30E-07	3.30E-07	
Biased Statistics												
Average Biased	3.54E-07	3.08E-07	2.75E-07	2.54E-07	2.36E-07	2.22E-07	2.09E-07	2.00E-07	2.01E-07	1.73E-07	-4.50E-08	
Std Dev Biased	2.84E-08	2.90E-08	3.10E-08	4.06E-08	4.43E-08	5.03E-08	5.86E-08	6.22E-08	6.52E-08	7.83E-08	1.70E-07	
Ps90%/90% (+KTL) Biased	4.13E-07	3.68E-07	3.39E-07	3.38E-07	3.27E-07	3.26E-07	3.30E-07	3.28E-07	3.36E-07	3.35E-07	3.05E-07	
Ps90%/90% (-KTL) Biased	2.95E-07	2.48E-07	2.11E-07	1.70E-07	1.45E-07	1.18E-07	8.80E-08	7.16E-08	6.63E-08	1.13E-08	-3.95E-07	
Specification MIN	-4.00E-06	-5.00E-06	-5.00E-06	-5.00E-06	-5.00E-06	-7.50E-06	-7.50E-06	-7.50E-06	-7.50E-06	-1.00E-05	-1.50E-05	
Status	PASS	PASS	PASS	PASS	PASS	PASS	PASS	PASS	PASS	PASS	PASS	
Specification MAX	4.00E-06	5.00E-06	5.00E-06	5.00E-06	5.00E-06	7.50E-06	7.50E-06	7.50E-06	7.50E-06	1.00E-05	1.50E-05	
Status	PASS	PASS	PASS	PASS	PASS	PASS	PASS	PASS	PASS	PASS	PASS	

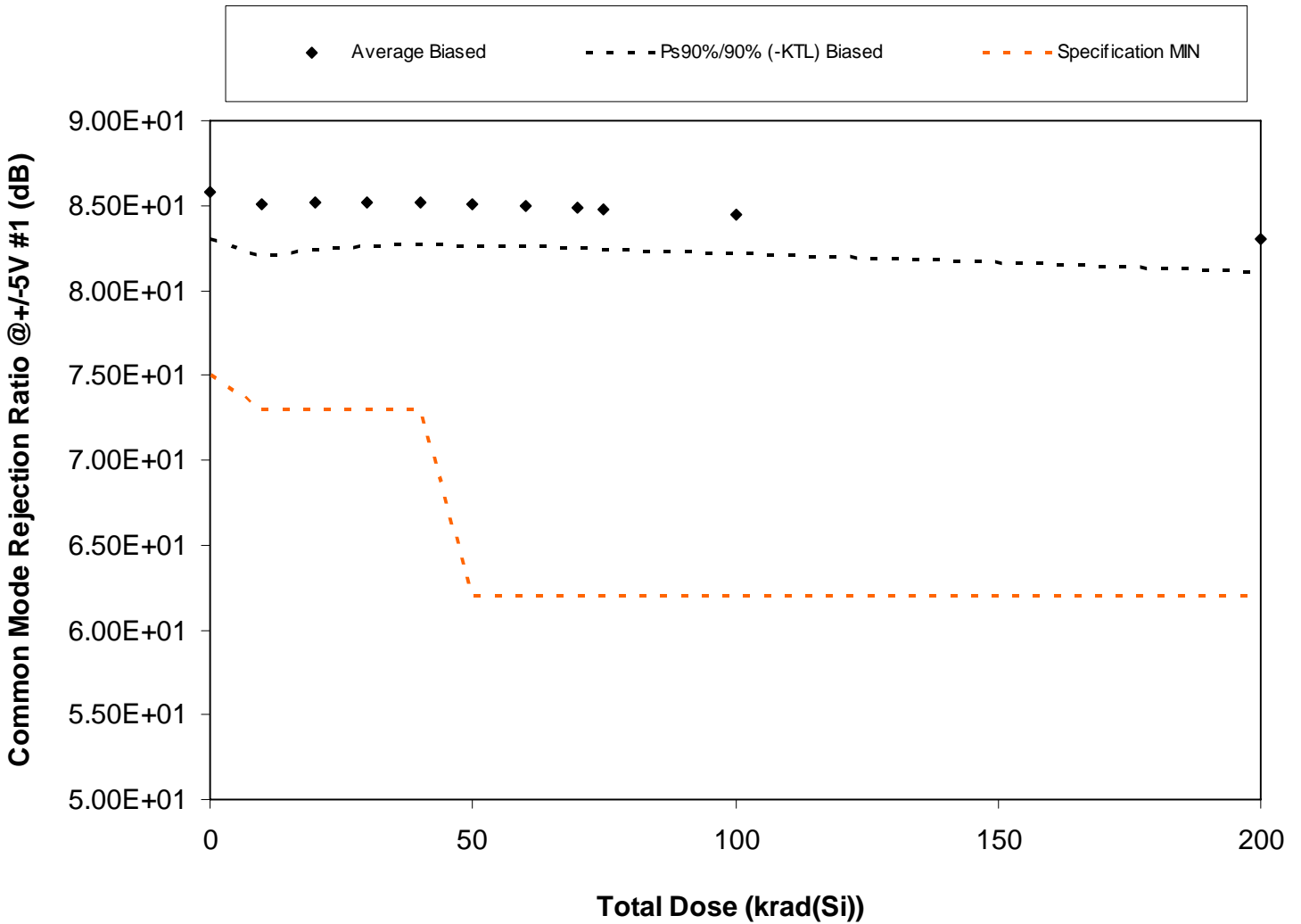

Figure 5.19. Plot of Common Mode Rejection Ratio @ +/-5V #1 (dB) versus total dose. The solid diamonds are the average of the measured data points for the samples irradiated under electrical bias and the black lines (solid and/or dashed) are the average of the data points after application of the KTL statistics on the samples irradiated under electrical bias. The red dotted line(s) are the pre- and/or post-irradiation minimum and/or maximum specification value as defined in the datasheet and/or test plan.



**RLAT Report
10-326 100808 R1.0**

**Radiation Assured Devices
5017 N. 30th Street
Colorado Springs, CO 80919
(719) 531-0800**

Table 5.19. Raw data for Common Mode Rejection Ratio @+/-5V #1 (dB) versus total dose, including the statistical analysis, specification and the status of the testing (pass/fail).

Common Mode Rejection Ratio @+/-5V #1 (dB)	Total Dose (krad(Si))											
	0	10	20	30	40	50	60	70	75	100	200	
Device												
1245	8.59E+01	8.48E+01	8.51E+01	8.53E+01	8.53E+01	8.53E+01	8.53E+01	8.52E+01	8.52E+01	8.50E+01	8.36E+01	
1246	8.87E+01	8.82E+01	8.79E+01	8.79E+01	8.77E+01	8.76E+01	8.74E+01	8.73E+01	8.72E+01	8.67E+01	8.46E+01	
1247	8.45E+01	8.33E+01	8.36E+01	8.39E+01	8.39E+01	8.39E+01	8.38E+01	8.37E+01	8.36E+01	8.33E+01	8.18E+01	
1248	8.63E+01	8.61E+01	8.60E+01	8.59E+01	8.58E+01	8.56E+01	8.55E+01	8.53E+01	8.52E+01	8.48E+01	8.35E+01	
1249	8.40E+01	8.36E+01	8.36E+01	8.36E+01	8.35E+01	8.34E+01	8.33E+01	8.32E+01	8.31E+01	8.28E+01	8.16E+01	
1250	8.67E+01	8.59E+01	8.60E+01	8.60E+01	8.59E+01	8.59E+01	8.58E+01	8.57E+01	8.56E+01	8.52E+01	8.36E+01	
1251	8.48E+01	8.39E+01	8.41E+01	8.42E+01	8.43E+01	8.42E+01	8.42E+01	8.40E+01	8.40E+01	8.37E+01	8.25E+01	
1261	8.58E+01	8.46E+01	8.50E+01	8.51E+01	8.51E+01	8.51E+01	8.49E+01	8.48E+01	8.48E+01	8.44E+01	8.28E+01	
1262	8.53E+01	8.44E+01	8.46E+01	8.47E+01	8.47E+01	8.47E+01	8.46E+01	8.45E+01	8.44E+01	8.41E+01	8.27E+01	
1263	8.64E+01	8.60E+01	8.58E+01	8.58E+01	8.56E+01	8.55E+01	8.54E+01	8.52E+01	8.51E+01	8.47E+01	8.31E+01	
1264	8.57E+01	8.57E+01	8.57E+01	8.57E+01	8.57E+01	8.57E+01	8.57E+01	8.57E+01	8.57E+01	8.57E+01	8.57E+01	
1265	8.42E+01	8.43E+01	8.43E+01	8.43E+01	8.42E+01	8.42E+01	8.42E+01	8.42E+01	8.43E+01	8.43E+01	8.42E+01	
Biased Statistics												
Average Biased	8.58E+01	8.51E+01	8.52E+01	8.52E+01	8.52E+01	8.51E+01	8.50E+01	8.49E+01	8.48E+01	8.45E+01	8.30E+01	
Std Dev Biased	1.35E+00	1.48E+00	1.31E+00	1.27E+00	1.22E+00	1.20E+00	1.16E+00	1.16E+00	1.14E+00	1.09E+00	9.00E-01	
Ps90%/90% (+KTL) Biased	8.86E+01	8.81E+01	8.79E+01	8.78E+01	8.77E+01	8.76E+01	8.74E+01	8.73E+01	8.71E+01	8.67E+01	8.48E+01	
Ps90%/90% (-KTL) Biased	8.30E+01	8.20E+01	8.25E+01	8.26E+01	8.27E+01	8.26E+01	8.26E+01	8.25E+01	8.24E+01	8.22E+01	8.11E+01	
Specification MIN	7.50E+01	7.30E+01	7.30E+01	7.30E+01	7.30E+01	6.20E+01	6.20E+01	6.20E+01	6.20E+01	6.20E+01	6.20E+01	
Status	PASS	PASS	PASS	PASS	PASS	PASS	PASS	PASS	PASS	PASS	PASS	

An ISO 9001:2008 and DSCC Certified Company

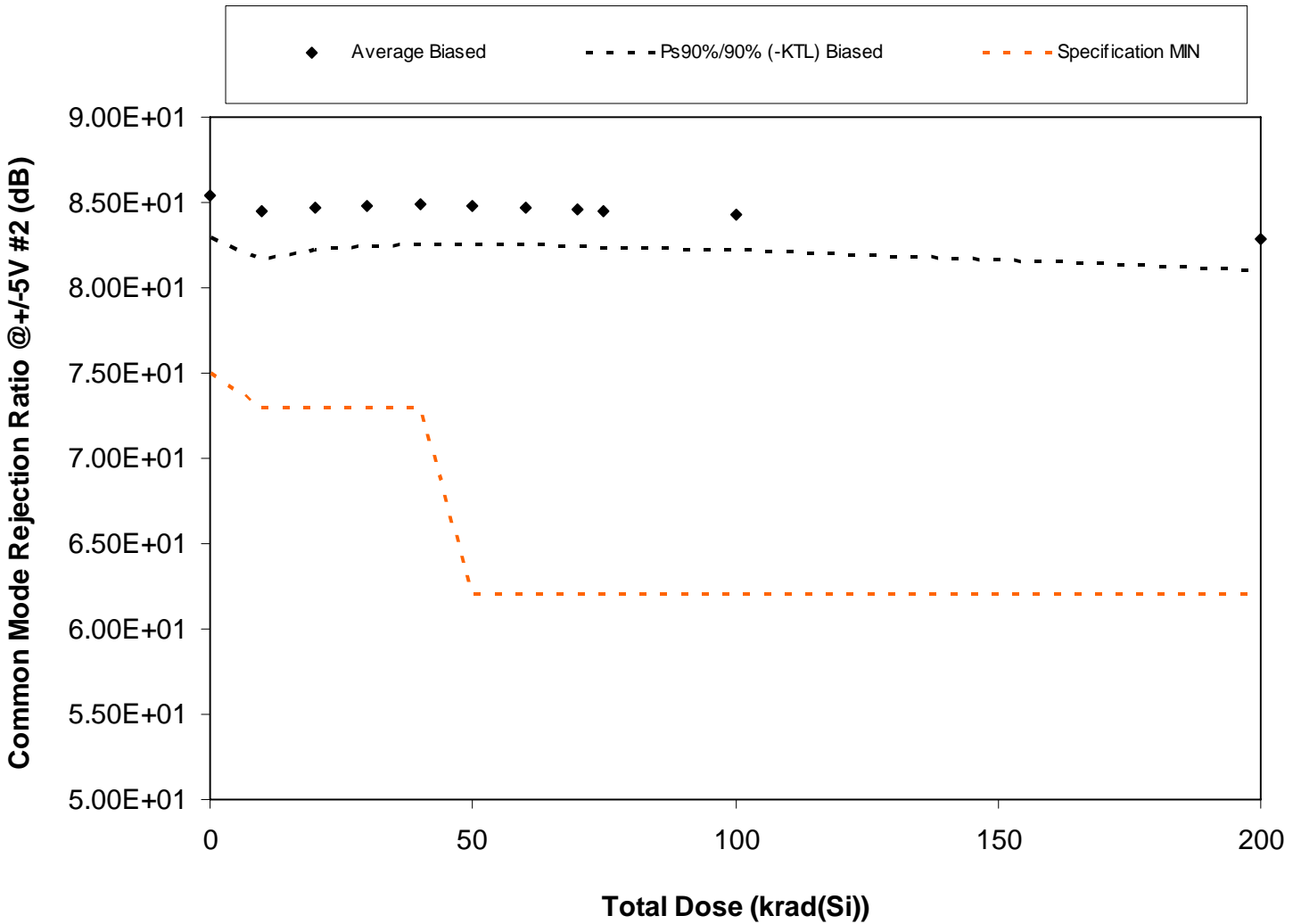

Figure 5.20. Plot of Common Mode Rejection Ratio @ +/-5V #2 (dB) versus total dose. The solid diamonds are the average of the measured data points for the samples irradiated under electrical bias and the black lines (solid and/or dashed) are the average of the data points after application of the KTL statistics on the samples irradiated under electrical bias. The red dotted line(s) are the pre- and/or post-irradiation minimum and/or maximum specification value as defined in the datasheet and/or test plan.



**RLAT Report
10-326 100808 R1.0**

**Radiation Assured Devices
5017 N. 30th Street
Colorado Springs, CO 80919
(719) 531-0800**

Table 5.20. Raw data for Common Mode Rejection Ratio @+/-5V #2 (dB) versus total dose, including the statistical analysis, specification and the status of the testing (pass/fail).

Common Mode Rejection Ratio @+/-5V #2 (dB)	Total Dose (krad(Si))											
	0	10	20	30	40	50	60	70	75	100	200	
Device												
1245	8.62E+01	8.56E+01	8.56E+01	8.55E+01	8.56E+01	8.55E+01	8.55E+01	8.54E+01	8.53E+01	8.50E+01	8.35E+01	
1246	8.33E+01	8.26E+01	8.27E+01	8.28E+01	8.28E+01	8.28E+01	8.27E+01	8.26E+01	8.26E+01	8.24E+01	8.11E+01	
1247	8.45E+01	8.29E+01	8.36E+01	8.39E+01	8.41E+01	8.41E+01	8.42E+01	8.40E+01	8.40E+01	8.38E+01	8.26E+01	
1248	8.64E+01	8.63E+01	8.61E+01	8.60E+01	8.59E+01	8.57E+01	8.56E+01	8.54E+01	8.53E+01	8.50E+01	8.35E+01	
1249	8.74E+01	8.67E+01	8.67E+01	8.66E+01	8.67E+01	8.65E+01	8.64E+01	8.62E+01	8.61E+01	8.58E+01	8.40E+01	
1250	8.47E+01	8.35E+01	8.39E+01	8.41E+01	8.41E+01	8.41E+01	8.40E+01	8.40E+01	8.38E+01	8.36E+01	8.22E+01	
1251	8.49E+01	8.43E+01	8.43E+01	8.43E+01	8.43E+01	8.43E+01	8.42E+01	8.41E+01	8.40E+01	8.37E+01	8.24E+01	
1261	8.57E+01	8.48E+01	8.49E+01	8.50E+01	8.51E+01	8.50E+01	8.50E+01	8.48E+01	8.47E+01	8.45E+01	8.29E+01	
1262	8.50E+01	8.42E+01	8.43E+01	8.44E+01	8.44E+01	8.43E+01	8.43E+01	8.41E+01	8.41E+01	8.38E+01	8.23E+01	
1263	8.56E+01	8.36E+01	8.48E+01	8.53E+01	8.55E+01	8.56E+01	8.56E+01	8.54E+01	8.54E+01	8.51E+01	8.37E+01	
1264	8.60E+01	8.60E+01	8.60E+01	8.60E+01	8.60E+01	8.60E+01	8.60E+01	8.60E+01	8.60E+01	8.60E+01	8.60E+01	
1265	8.56E+01	8.56E+01	8.56E+01	8.56E+01	8.56E+01	8.57E+01	8.57E+01	8.56E+01	8.56E+01	8.56E+01	8.56E+01	
Biased Statistics												
Average Biased	8.54E+01	8.45E+01	8.47E+01	8.48E+01	8.49E+01	8.48E+01	8.47E+01	8.46E+01	8.45E+01	8.43E+01	8.28E+01	
Std Dev Biased	1.16E+00	1.39E+00	1.20E+00	1.12E+00	1.10E+00	1.08E+00	1.06E+00	1.04E+00	1.04E+00	9.83E-01	8.75E-01	
Ps90%/90% (+KTL) Biased	8.78E+01	8.73E+01	8.72E+01	8.71E+01	8.71E+01	8.70E+01	8.69E+01	8.67E+01	8.67E+01	8.63E+01	8.46E+01	
Ps90%/90% (-KTL) Biased	8.30E+01	8.16E+01	8.22E+01	8.25E+01	8.26E+01	8.26E+01	8.25E+01	8.24E+01	8.24E+01	8.22E+01	8.10E+01	
Specification MIN	7.50E+01	7.30E+01	7.30E+01	7.30E+01	7.30E+01	6.20E+01	6.20E+01	6.20E+01	6.20E+01	6.20E+01	6.20E+01	
Status	PASS	PASS	PASS	PASS	PASS	PASS	PASS	PASS	PASS	PASS	PASS	

An ISO 9001:2008 and DSCC Certified Company

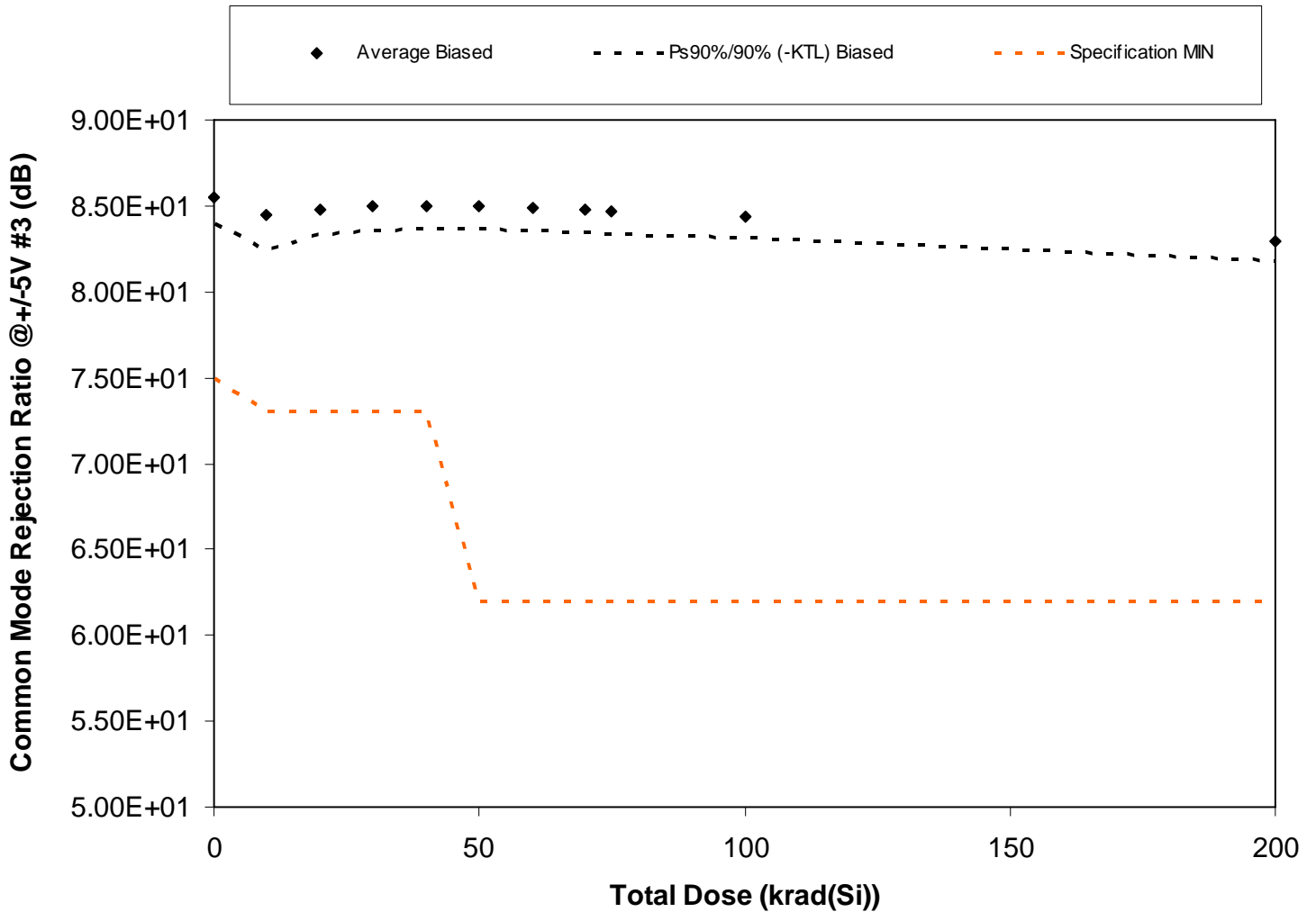

Figure 5.21. Plot of Common Mode Rejection Ratio @ +/-5V #3 (dB) versus total dose. The solid diamonds are the average of the measured data points for the samples irradiated under electrical bias and the black lines (solid and/or dashed) are the average of the data points after application of the KTL statistics on the samples irradiated under electrical bias. The red dotted line(s) are the pre- and/or post-irradiation minimum and/or maximum specification value as defined in the datasheet and/or test plan.



**RLAT Report
10-326 100808 R1.0**

**Radiation Assured Devices
5017 N. 30th Street
Colorado Springs, CO 80919
(719) 531-0800**

Table 5.21. Raw data for Common Mode Rejection Ratio @+/-5V #3 (dB) versus total dose, including the statistical analysis, specification and the status of the testing (pass/fail).

Common Mode Rejection Ratio @+/-5V #3 (dB)	Total Dose (krad(Si))											
	0	10	20	30	40	50	60	70	75	100	200	
Device												
1245	8.62E+01	8.54E+01	8.54E+01	8.55E+01	8.55E+01	8.55E+01	8.54E+01	8.53E+01	8.53E+01	8.49E+01	8.34E+01	
1246	8.51E+01	8.41E+01	8.43E+01	8.44E+01	8.44E+01	8.44E+01	8.42E+01	8.41E+01	8.40E+01	8.38E+01	8.23E+01	
1247	8.56E+01	8.48E+01	8.49E+01	8.49E+01	8.49E+01	8.48E+01	8.47E+01	8.46E+01	8.45E+01	8.42E+01	8.25E+01	
1248	8.47E+01	8.46E+01	8.46E+01	8.44E+01	8.43E+01	8.42E+01	8.41E+01	8.40E+01	8.39E+01	8.36E+01	8.24E+01	
1249	8.57E+01	8.52E+01	8.52E+01	8.51E+01	8.50E+01	8.49E+01	8.48E+01	8.46E+01	8.46E+01	8.42E+01	8.27E+01	
1250	8.51E+01	8.33E+01	8.44E+01	8.49E+01	8.52E+01	8.52E+01	8.51E+01	8.51E+01	8.50E+01	8.47E+01	8.33E+01	
1251	8.72E+01	8.62E+01	8.63E+01	8.65E+01	8.65E+01	8.64E+01	8.63E+01	8.62E+01	8.60E+01	8.57E+01	8.40E+01	
1261	8.47E+01	8.31E+01	8.37E+01	8.42E+01	8.44E+01	8.44E+01	8.44E+01	8.43E+01	8.42E+01	8.40E+01	8.28E+01	
1262	8.54E+01	8.38E+01	8.44E+01	8.48E+01	8.50E+01	8.49E+01	8.49E+01	8.49E+01	8.48E+01	8.45E+01	8.32E+01	
1263	8.54E+01	8.41E+01	8.46E+01	8.49E+01	8.49E+01	8.49E+01	8.48E+01	8.48E+01	8.46E+01	8.44E+01	8.30E+01	
1264	8.54E+01	8.55E+01	8.55E+01	8.55E+01	8.54E+01	8.55E+01	8.54E+01	8.54E+01	8.55E+01	8.55E+01	8.54E+01	
1265	8.76E+01	8.75E+01	8.75E+01	8.76E+01	8.75E+01	8.76E+01	8.76E+01	8.76E+01	8.76E+01	8.76E+01	8.76E+01	
Biased Statistics												
Average Biased	8.55E+01	8.45E+01	8.48E+01	8.49E+01	8.50E+01	8.50E+01	8.49E+01	8.48E+01	8.47E+01	8.44E+01	8.29E+01	
Std Dev Biased	7.53E-01	9.60E-01	7.11E-01	6.52E-01	6.38E-01	6.43E-01	6.42E-01	6.30E-01	6.25E-01	6.04E-01	5.29E-01	
Ps90%/90% (+KTL) Biased	8.71E+01	8.64E+01	8.62E+01	8.63E+01	8.63E+01	8.63E+01	8.62E+01	8.61E+01	8.60E+01	8.56E+01	8.40E+01	
Ps90%/90% (-KTL) Biased	8.39E+01	8.25E+01	8.33E+01	8.36E+01	8.37E+01	8.36E+01	8.35E+01	8.35E+01	8.34E+01	8.31E+01	8.18E+01	
Specification MIN	7.50E+01	7.30E+01	7.30E+01	7.30E+01	7.30E+01	6.20E+01	6.20E+01	6.20E+01	6.20E+01	6.20E+01	6.20E+01	
Status	PASS	PASS	PASS	PASS	PASS	PASS	PASS	PASS	PASS	PASS	PASS	

An ISO 9001:2008 and DSCC Certified Company

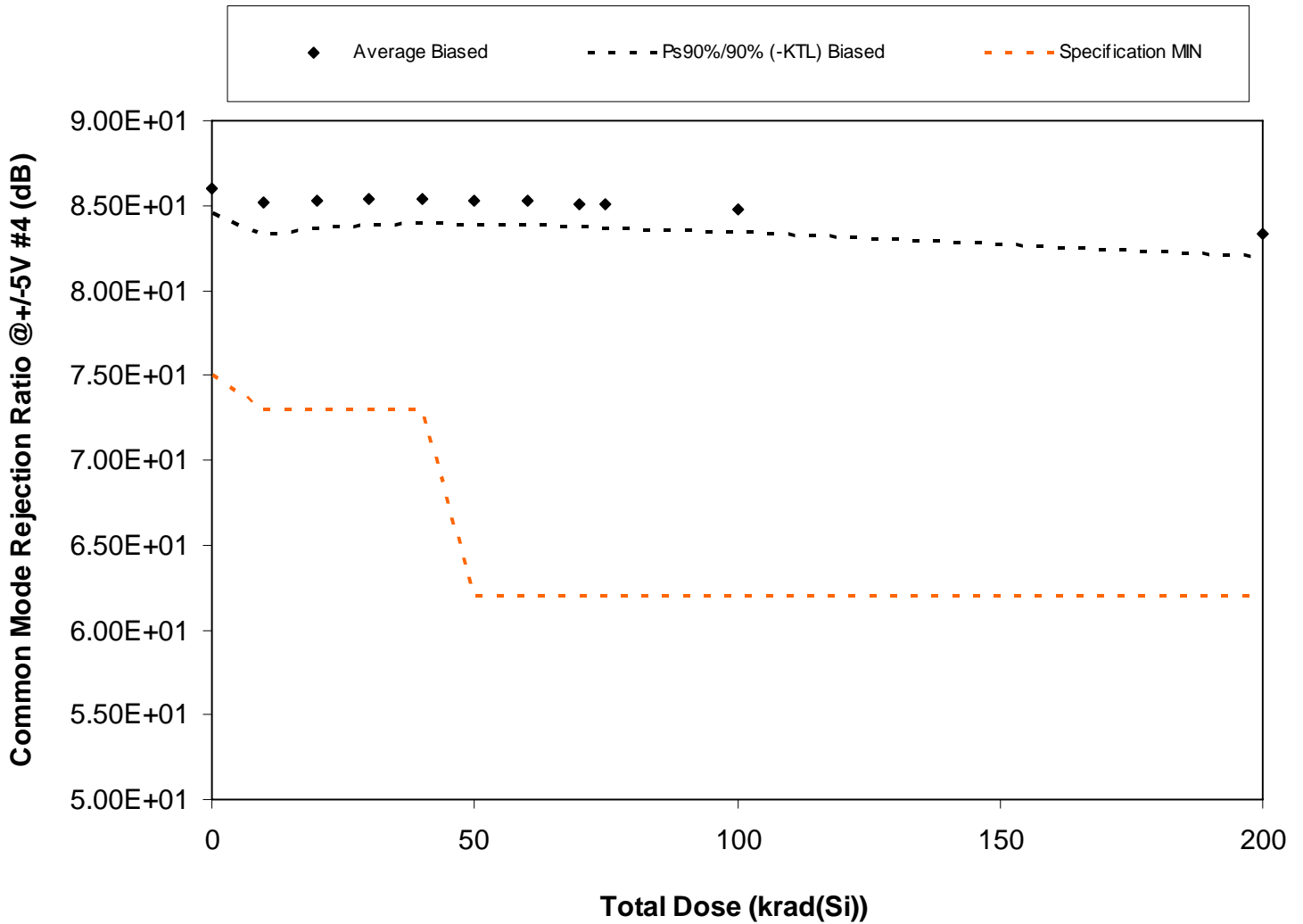

Figure 5.22. Plot of Common Mode Rejection Ratio @ +/-5V #4 (dB) versus total dose. The solid diamonds are the average of the measured data points for the samples irradiated under electrical bias and the black lines (solid and/or dashed) are the average of the data points after application of the KTL statistics on the samples irradiated under electrical bias. The red dotted line(s) are the pre- and/or post-irradiation minimum and/or maximum specification value as defined in the datasheet and/or test plan.



**RLAT Report
10-326 100808 R1.0**

**Radiation Assured Devices
5017 N. 30th Street
Colorado Springs, CO 80919
(719) 531-0800**

Table 5.22. Raw data for Common Mode Rejection Ratio @+/-5V #4 (dB) versus total dose, including the statistical analysis, specification and the status of the testing (pass/fail).

Common Mode Rejection Ratio @+/-5V #4 (dB)	Total Dose (krad(Si))											
	0	10	20	30	40	50	60	70	75	100	200	
Device												
1245	8.51E+01	8.38E+01	8.42E+01	8.44E+01	8.46E+01	8.46E+01	8.46E+01	8.45E+01	8.44E+01	8.42E+01	8.30E+01	
1246	8.59E+01	8.50E+01	8.51E+01	8.52E+01	8.52E+01	8.53E+01	8.52E+01	8.51E+01	8.50E+01	8.48E+01	8.33E+01	
1247	8.63E+01	8.44E+01	8.50E+01	8.54E+01	8.57E+01	8.57E+01	8.57E+01	8.56E+01	8.55E+01	8.53E+01	8.39E+01	
1248	8.73E+01	8.72E+01	8.70E+01	8.70E+01	8.69E+01	8.67E+01	8.66E+01	8.64E+01	8.63E+01	8.59E+01	8.45E+01	
1249	8.58E+01	8.52E+01	8.53E+01	8.53E+01	8.52E+01	8.51E+01	8.50E+01	8.49E+01	8.48E+01	8.45E+01	8.32E+01	
1250	8.53E+01	8.46E+01	8.46E+01	8.46E+01	8.46E+01	8.46E+01	8.45E+01	8.44E+01	8.42E+01	8.40E+01	8.25E+01	
1251	8.65E+01	8.59E+01	8.58E+01	8.58E+01	8.58E+01	8.58E+01	8.57E+01	8.56E+01	8.55E+01	8.53E+01	8.38E+01	
1261	8.59E+01	8.49E+01	8.51E+01	8.52E+01	8.53E+01	8.52E+01	8.51E+01	8.50E+01	8.49E+01	8.47E+01	8.32E+01	
1262	8.67E+01	8.55E+01	8.58E+01	8.59E+01	8.59E+01	8.59E+01	8.58E+01	8.57E+01	8.56E+01	8.52E+01	8.36E+01	
1263	8.53E+01	8.48E+01	8.48E+01	8.47E+01	8.47E+01	8.45E+01	8.44E+01	8.42E+01	8.42E+01	8.38E+01	8.24E+01	
1264	8.68E+01	8.68E+01	8.68E+01	8.68E+01	8.68E+01	8.68E+01	8.68E+01	8.68E+01	8.68E+01	8.68E+01	8.68E+01	
1265	8.64E+01	8.64E+01	8.64E+01	8.64E+01	8.63E+01	8.64E+01	8.64E+01	8.64E+01	8.64E+01	8.63E+01	8.64E+01	
Biased Statistics												
Average Biased	8.60E+01	8.51E+01	8.53E+01	8.54E+01	8.54E+01	8.53E+01	8.52E+01	8.51E+01	8.50E+01	8.48E+01	8.33E+01	
Std Dev Biased	6.93E-01	9.31E-01	7.83E-01	7.56E-01	7.08E-01	6.95E-01	6.88E-01	6.75E-01	6.82E-01	6.71E-01	6.46E-01	
Ps90%/90% (+KTL) Biased	8.74E+01	8.71E+01	8.69E+01	8.69E+01	8.68E+01	8.68E+01	8.67E+01	8.65E+01	8.64E+01	8.62E+01	8.47E+01	
Ps90%/90% (-KTL) Biased	8.46E+01	8.32E+01	8.36E+01	8.38E+01	8.39E+01	8.39E+01	8.38E+01	8.37E+01	8.36E+01	8.34E+01	8.20E+01	
Specification MIN	7.50E+01	7.30E+01	7.30E+01	7.30E+01	7.30E+01	6.20E+01	6.20E+01	6.20E+01	6.20E+01	6.20E+01	6.20E+01	
Status	PASS	PASS	PASS	PASS	PASS	PASS	PASS	PASS	PASS	PASS	PASS	

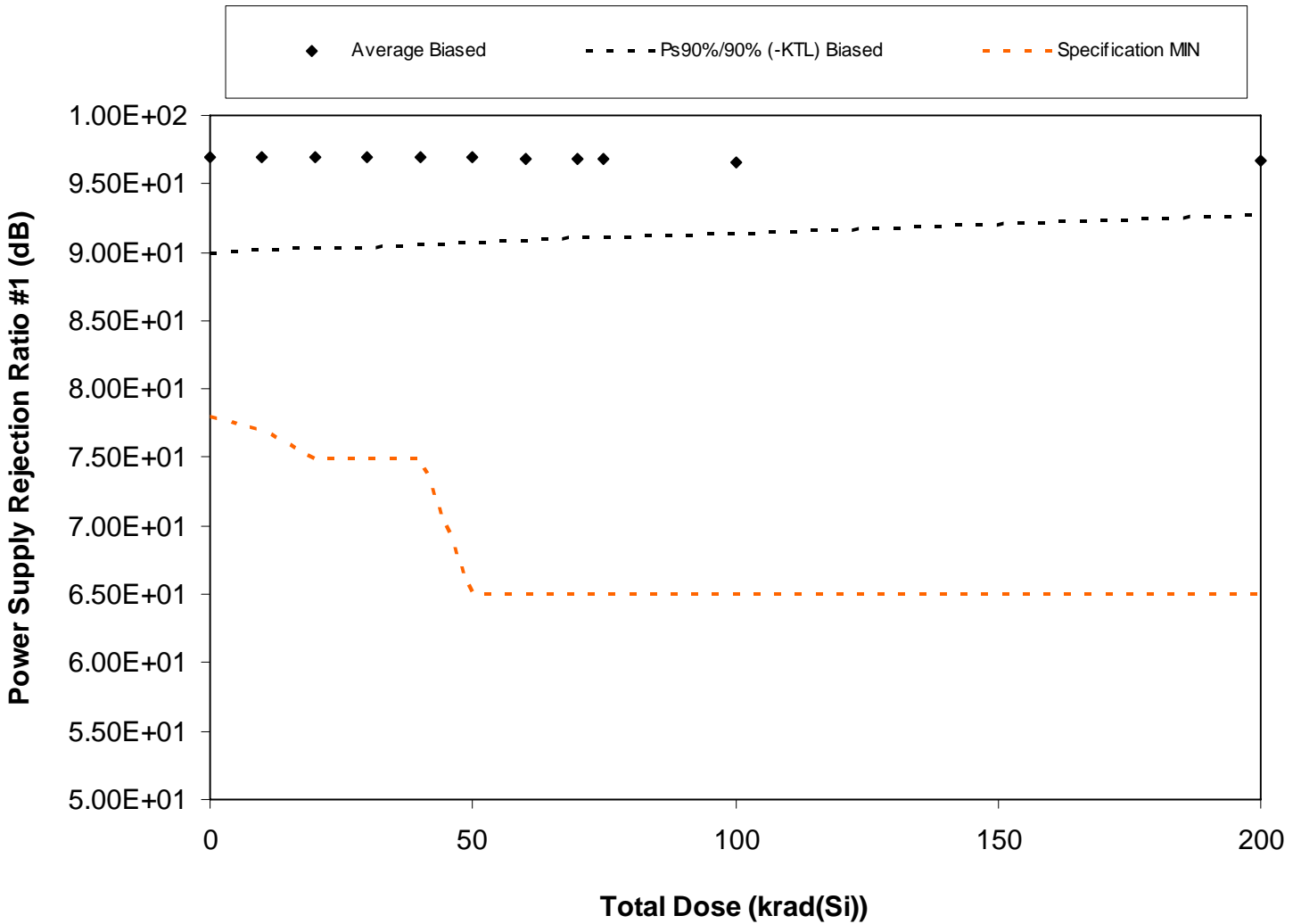

Figure 5.23. Plot of Power Supply Rejection Ratio #1 (dB) versus total dose. The solid diamonds are the average of the measured data points for the samples irradiated under electrical bias and the black lines (solid and/or dashed) are the average of the data points after application of the KTL statistics on the samples irradiated under electrical bias. The red dotted line(s) are the pre- and/or post-irradiation minimum and/or maximum specification value as defined in the datasheet and/or test plan.



**RLAT Report
10-326 100808 R1.0**

**Radiation Assured Devices
5017 N. 30th Street
Colorado Springs, CO 80919
(719) 531-0800**

Table 5.23. Raw data for Power Supply Rejection Ratio #1 (dB) versus total dose, including the statistical analysis, specification and the status of the testing (pass/fail).

Power Supply Rejection Ratio #1 (dB)	Total Dose (krad(Si))											
	0	10	20	30	40	50	60	70	75	100	200	
Device												
1245	9.50E+01	9.51E+01	9.52E+01	9.53E+01	9.53E+01	9.56E+01	9.57E+01	9.57E+01	9.58E+01	9.58E+01	9.70E+01	
1246	1.01E+02	1.01E+02	1.01E+02	1.01E+02	1.01E+02	1.01E+02	1.01E+02	1.01E+02	1.00E+02	1.00E+02	9.90E+01	
1247	1.03E+02	1.03E+02	1.02E+02	1.02E+02	1.02E+02	1.02E+02	1.02E+02	1.01E+02	1.01E+02	1.00E+02	9.83E+01	
1248	9.15E+01	9.16E+01	9.17E+01	9.18E+01	9.19E+01	9.19E+01	9.19E+01	9.21E+01	9.21E+01	9.24E+01	9.37E+01	
1249	9.32E+01	9.32E+01	9.33E+01	9.32E+01	9.33E+01	9.33E+01	9.32E+01	9.32E+01	9.32E+01	9.30E+01	9.35E+01	
1250	9.62E+01	9.64E+01	9.65E+01	9.65E+01	9.67E+01	9.68E+01	9.69E+01	9.72E+01	9.70E+01	9.73E+01	9.86E+01	
1251	9.73E+01	9.72E+01	9.74E+01	9.73E+01	9.74E+01	9.75E+01	9.75E+01	9.75E+01	9.74E+01	9.73E+01	9.69E+01	
1261	9.69E+01	9.70E+01	9.70E+01	9.71E+01	9.70E+01	9.70E+01	9.69E+01	9.69E+01	9.69E+01	9.67E+01	9.64E+01	
1262	9.74E+01	9.73E+01	9.72E+01	9.72E+01	9.71E+01	9.70E+01	9.67E+01	9.67E+01	9.66E+01	9.62E+01	9.56E+01	
1263	9.80E+01	9.77E+01	9.77E+01	9.76E+01	9.77E+01	9.76E+01	9.75E+01	9.74E+01	9.74E+01	9.72E+01	9.74E+01	
1264	9.95E+01	9.95E+01	9.95E+01	9.95E+01	9.95E+01	9.94E+01	9.95E+01	9.94E+01	9.95E+01	9.94E+01	9.93E+01	
1265	9.63E+01	9.65E+01	9.65E+01	9.64E+01	9.65E+01	9.65E+01	9.64E+01	9.65E+01	9.64E+01	9.64E+01	9.65E+01	
Biased Statistics												
Average Biased	9.70E+01	9.69E+01	9.70E+01	9.69E+01	9.70E+01	9.70E+01	9.69E+01	9.68E+01	9.68E+01	9.66E+01	9.66E+01	
Std Dev Biased	3.37E+00	3.28E+00	3.21E+00	3.17E+00	3.12E+00	3.03E+00	2.92E+00	2.78E+00	2.73E+00	2.52E+00	1.90E+00	
Ps90%/90% (+KTL) Biased	1.04E+02	1.04E+02	1.04E+02	1.03E+02	1.03E+02	1.03E+02	1.03E+02	1.03E+02	1.02E+02	1.02E+02	1.01E+02	
Ps90%/90% (-KTL) Biased	9.00E+01	9.02E+01	9.03E+01	9.04E+01	9.05E+01	9.07E+01	9.08E+01	9.11E+01	9.12E+01	9.14E+01	9.27E+01	
Specification MIN	7.80E+01	7.70E+01	7.50E+01	7.50E+01	7.50E+01	6.50E+01	6.50E+01	6.50E+01	6.50E+01	6.50E+01	6.50E+01	
Status	PASS	PASS	PASS	PASS	PASS	PASS	PASS	PASS	PASS	PASS	PASS	

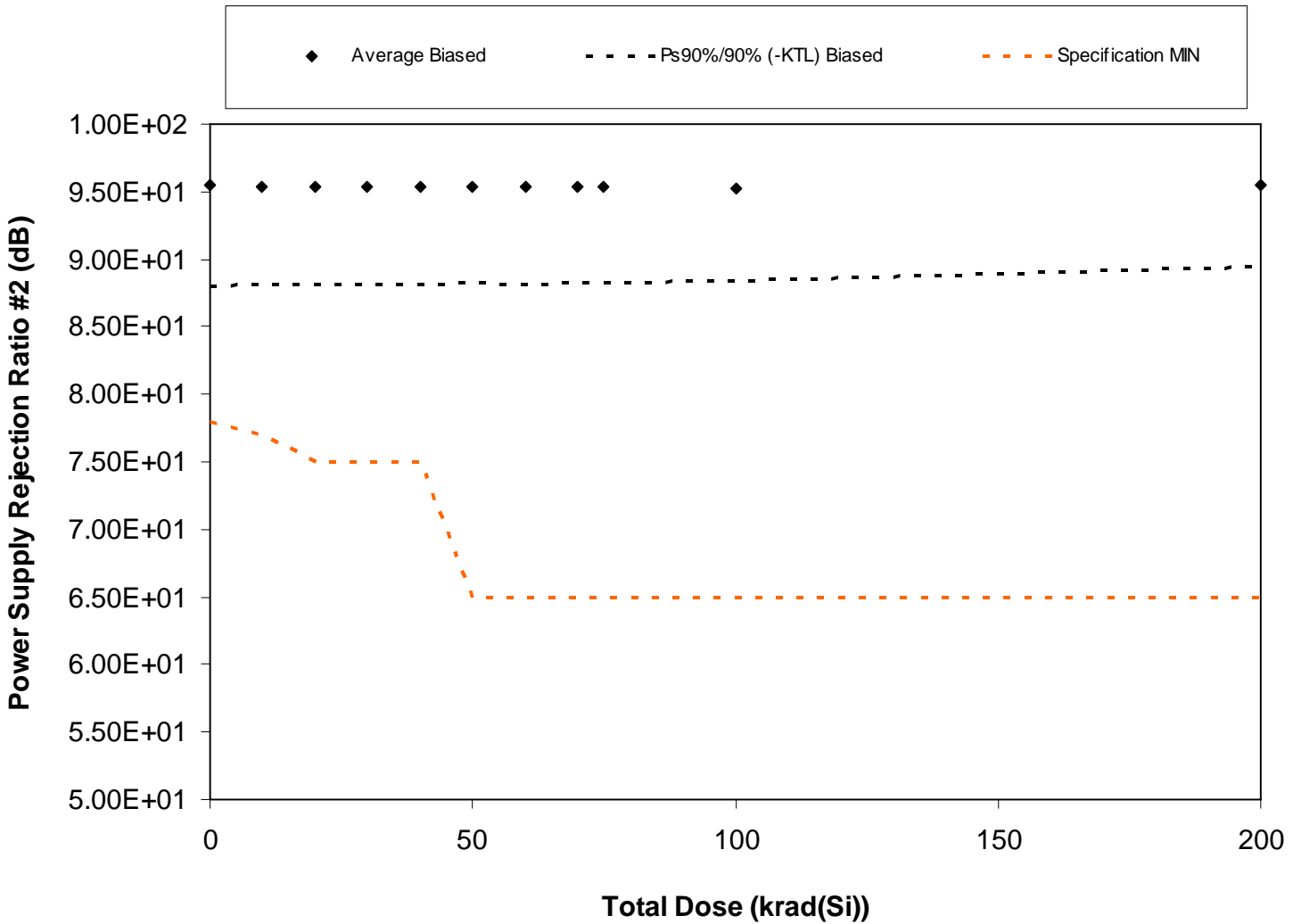

Figure 5.24. Plot of Power Supply Rejection Ratio #2 (dB) versus total dose. The solid diamonds are the average of the measured data points for the samples irradiated under electrical bias and the black lines (solid and/or dashed) are the average of the data points after application of the KTL statistics on the samples irradiated under electrical bias. The red dotted line(s) are the pre- and/or post-irradiation minimum and/or maximum specification value as defined in the datasheet and/or test plan.



**RLAT Report
10-326 100808 R1.0**

**Radiation Assured Devices
5017 N. 30th Street
Colorado Springs, CO 80919
(719) 531-0800**

Table 5.24. Raw data for Power Supply Rejection Ratio #2 (dB) versus total dose, including the statistical analysis, specification and the status of the testing (pass/fail).

Power Supply Rejection Ratio #2 (dB)	Total Dose (krad(Si))											
	0	10	20	30	40	50	60	70	75	100	200	
Device												
1245	1.00E+02	1.01E+02	1.01E+02	1.01E+02	1.01E+02	1.01E+02	1.01E+02	1.01E+02	1.01E+02	1.01E+02	1.01E+02	1.00E+02
1246	9.02E+01	9.03E+01	9.03E+01	9.04E+01	9.04E+01	9.05E+01	9.05E+01	9.07E+01	9.06E+01	9.06E+01	9.13E+01	9.13E+01
1247	9.93E+01	9.92E+01	9.91E+01	9.89E+01	9.90E+01	9.89E+01	9.89E+01	9.89E+01	9.88E+01	9.85E+01	9.82E+01	9.82E+01
1248	9.47E+01	9.49E+01	9.49E+01	9.47E+01	9.46E+01	9.46E+01	9.43E+01	9.42E+01	9.43E+01	9.39E+01	9.39E+01	9.39E+01
1249	9.68E+01	9.69E+01	9.68E+01	9.70E+01	9.70E+01	9.69E+01	9.69E+01	9.68E+01	9.69E+01	9.66E+01	9.69E+01	9.69E+01
1250	9.96E+01	9.91E+01	9.89E+01	9.90E+01	9.90E+01	9.88E+01	9.88E+01	9.88E+01	9.87E+01	9.85E+01	9.81E+01	9.81E+01
1251	9.06E+01	9.07E+01	9.07E+01	9.08E+01	9.09E+01	9.10E+01	9.10E+01	9.11E+01	9.12E+01	9.13E+01	9.23E+01	9.23E+01
1261	9.32E+01	9.32E+01	9.31E+01	9.31E+01	9.31E+01	9.31E+01	9.31E+01	9.30E+01	9.30E+01	9.30E+01	9.32E+01	9.32E+01
1262	9.40E+01	9.39E+01	9.39E+01	9.39E+01	9.39E+01	9.40E+01	9.39E+01	9.41E+01	9.40E+01	9.40E+01	9.45E+01	9.45E+01
1263	9.54E+01	9.50E+01	9.52E+01	9.51E+01	9.51E+01	9.51E+01	9.52E+01	9.51E+01	9.50E+01	9.50E+01	9.58E+01	9.58E+01
1264	9.89E+01	9.90E+01	9.89E+01	9.89E+01	9.88E+01	9.88E+01	9.89E+01	9.89E+01	9.88E+01	9.89E+01	9.88E+01	9.88E+01
1265	9.91E+01	9.91E+01	9.91E+01	9.91E+01	9.91E+01	9.91E+01	9.91E+01	9.91E+01	9.92E+01	9.90E+01	9.90E+01	9.90E+01
Biased Statistics												
Average Biased	9.54E+01	9.54E+01	9.54E+01	9.54E+01	9.54E+01	9.54E+01	9.53E+01	9.53E+01	9.53E+01	9.52E+01	9.55E+01	9.55E+01
Std Dev Biased	3.61E+00	3.53E+00	3.51E+00	3.50E+00	3.51E+00	3.46E+00	3.46E+00	3.40E+00	3.40E+00	3.30E+00	2.93E+00	2.93E+00
Ps90%/90% (+KTL) Biased	1.03E+02	1.03E+02	1.03E+02	1.03E+02	1.03E+02	1.03E+02	1.02E+02	1.02E+02	1.02E+02	1.02E+02	1.02E+02	1.02E+02
Ps90%/90% (-KTL) Biased	8.80E+01	8.81E+01	8.81E+01	8.81E+01	8.81E+01	8.82E+01	8.82E+01	8.83E+01	8.83E+01	8.84E+01	8.94E+01	8.94E+01
Specification MIN	7.80E+01	7.70E+01	7.50E+01	7.50E+01	7.50E+01	6.50E+01	6.50E+01	6.50E+01	6.50E+01	6.50E+01	6.50E+01	6.50E+01
Status	PASS	PASS	PASS	PASS	PASS	PASS	PASS	PASS	PASS	PASS	PASS	PASS

An ISO 9001:2008 and DSCC Certified Company

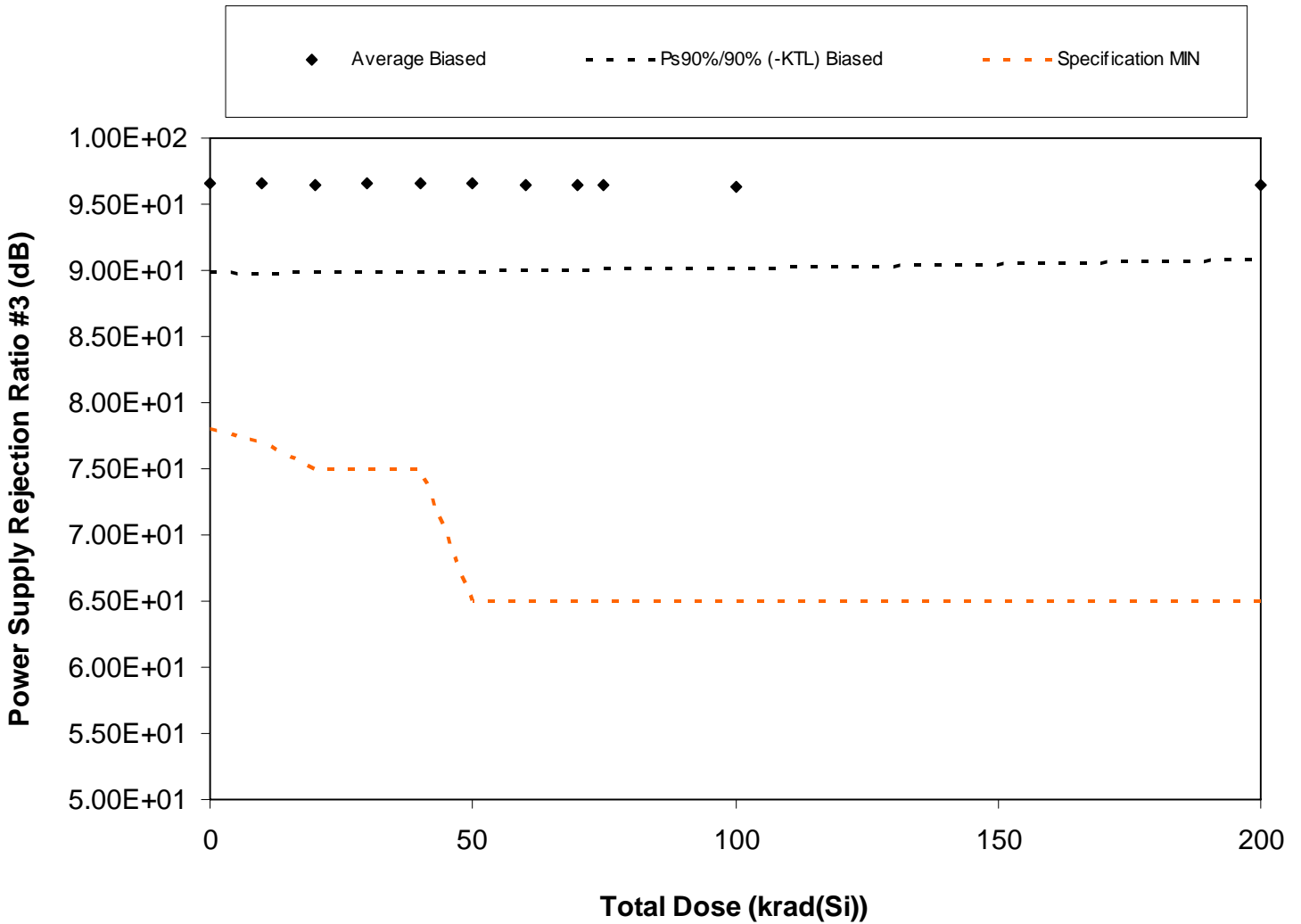

Figure 5.25. Plot of Power Supply Rejection Ratio #3 (dB) versus total dose. The solid diamonds are the average of the measured data points for the samples irradiated under electrical bias and the black lines (solid and/or dashed) are the average of the data points after application of the KTL statistics on the samples irradiated under electrical bias. The red dotted line(s) are the pre- and/or post-irradiation minimum and/or maximum specification value as defined in the datasheet and/or test plan.



**RLAT Report
10-326 100808 R1.0**

**Radiation Assured Devices
5017 N. 30th Street
Colorado Springs, CO 80919
(719) 531-0800**

Table 5.25. Raw data for Power Supply Rejection Ratio #3 (dB) versus total dose, including the statistical analysis, specification and the status of the testing (pass/fail).

Power Supply Rejection Ratio #3 (dB)	Total Dose (krad(Si))											
	0	10	20	30	40	50	60	70	75	100	200	
Device												
1245	9.70E+01	9.70E+01	9.70E+01	9.71E+01	9.72E+01	9.72E+01	9.72E+01	9.72E+01	9.72E+01	9.72E+01	9.71E+01	9.71E+01
1246	9.05E+01	9.06E+01	9.07E+01	9.07E+01	9.08E+01	9.08E+01	9.08E+01	9.10E+01	9.10E+01	9.10E+01	9.10E+01	9.19E+01
1247	9.78E+01	9.78E+01	9.78E+01	9.77E+01	9.78E+01	9.75E+01	9.76E+01	9.74E+01	9.74E+01	9.70E+01	9.67E+01	9.67E+01
1248	9.47E+01	9.49E+01	9.49E+01	9.47E+01	9.45E+01	9.45E+01	9.43E+01	9.43E+01	9.44E+01	9.40E+01	9.40E+01	9.40E+01
1249	9.83E+01	9.84E+01	9.85E+01	9.85E+01	9.84E+01	9.85E+01	9.86E+01	9.83E+01	9.84E+01	9.81E+01	9.81E+01	9.81E+01
1250	9.71E+01	9.64E+01	9.64E+01	9.63E+01	9.64E+01	9.66E+01	9.66E+01	9.65E+01	9.67E+01	9.66E+01	9.70E+01	9.70E+01
1251	9.81E+01	9.80E+01	9.79E+01	9.80E+01	9.80E+01	9.79E+01	9.79E+01	9.77E+01	9.77E+01	9.75E+01	9.71E+01	9.71E+01
1261	9.21E+01	9.20E+01	9.20E+01	9.20E+01	9.21E+01	9.21E+01	9.22E+01	9.22E+01	9.22E+01	9.23E+01	9.29E+01	9.29E+01
1262	1.01E+02	1.01E+02	1.01E+02	1.01E+02	1.01E+02	1.01E+02	1.01E+02	1.01E+02	1.01E+02	1.01E+02	1.01E+02	1.01E+02
1263	9.91E+01	9.89E+01	9.88E+01	9.89E+01	9.89E+01	9.88E+01	9.89E+01	9.89E+01	9.86E+01	9.84E+01	9.90E+01	9.90E+01
1264	9.90E+01	9.91E+01	9.90E+01	9.90E+01	9.91E+01	9.91E+01	9.91E+01	9.90E+01	9.89E+01	9.90E+01	9.89E+01	9.89E+01
1265	1.05E+02	1.05E+02	1.05E+02	1.05E+02	1.05E+02	1.05E+02	1.05E+02	1.05E+02	1.05E+02	1.05E+02	1.05E+02	1.05E+02
Biased Statistics												
Average Biased	9.66E+01	9.66E+01	9.65E+01	9.65E+01	9.65E+01	9.65E+01	9.65E+01	9.64E+01	9.65E+01	9.63E+01	9.64E+01	9.64E+01
Std Dev Biased	3.28E+00	3.28E+00	3.20E+00	3.23E+00	3.19E+00	3.23E+00	3.18E+00	3.12E+00	3.09E+00	2.95E+00	2.73E+00	2.73E+00
Ps90%/90% (+KTL) Biased	1.03E+02	1.03E+02	1.03E+02	1.03E+02	1.03E+02	1.03E+02	1.03E+02	1.03E+02	1.03E+02	1.02E+02	1.02E+02	1.02E+02
Ps90%/90% (-KTL) Biased	8.98E+01	8.98E+01	8.99E+01	8.99E+01	8.99E+01	8.99E+01	8.99E+01	9.00E+01	9.01E+01	9.02E+01	9.08E+01	9.08E+01
Specification MIN	7.80E+01	7.70E+01	7.50E+01	7.50E+01	7.50E+01	6.50E+01	6.50E+01	6.50E+01	6.50E+01	6.50E+01	6.50E+01	6.50E+01
Status	PASS	PASS	PASS	PASS	PASS	PASS	PASS	PASS	PASS	PASS	PASS	PASS

An ISO 9001:2008 and DSCC Certified Company

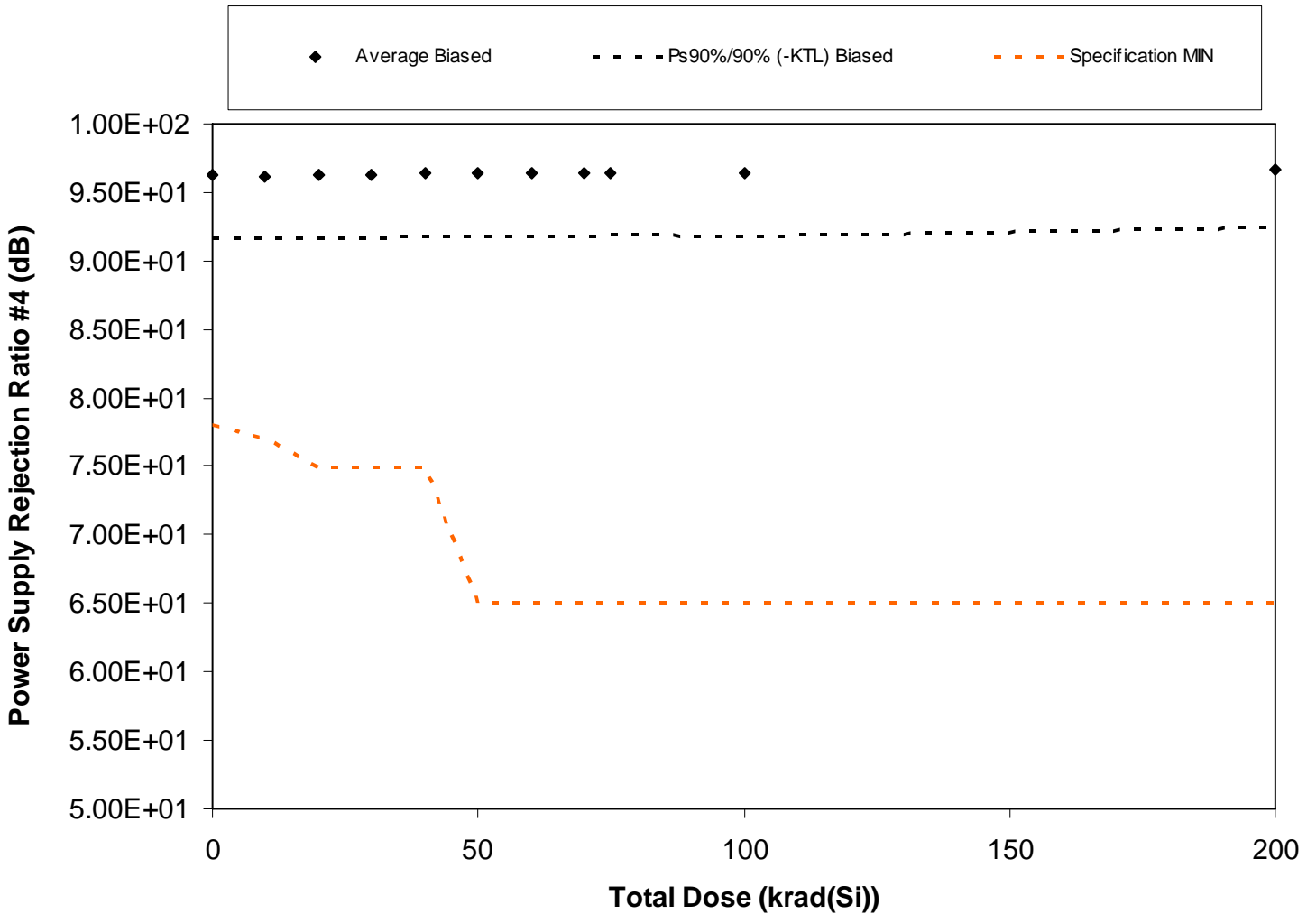

Figure 5.26. Plot of Power Supply Rejection Ratio #4 (dB) versus total dose. The solid diamonds are the average of the measured data points for the samples irradiated under electrical bias and the black lines (solid and/or dashed) are the average of the data points after application of the KTL statistics on the samples irradiated under electrical bias. The red dotted line(s) are the pre- and/or post-irradiation minimum and/or maximum specification value as defined in the datasheet and/or test plan.



**RLAT Report
10-326 100808 R1.0**

**Radiation Assured Devices
5017 N. 30th Street
Colorado Springs, CO 80919
(719) 531-0800**

Table 5.26. Raw data for Power Supply Rejection Ratio #4 (dB) versus total dose, including the statistical analysis, specification and the status of the testing (pass/fail).

Power Supply Rejection Ratio #4 (dB)	Total Dose (krad(Si))											
	0	10	20	30	40	50	60	70	75	100	200	
Device												
1245	9.38E+01	9.38E+01	9.39E+01	9.41E+01	9.42E+01	9.43E+01	9.45E+01	9.46E+01	9.47E+01	9.48E+01	9.61E+01	
1246	9.72E+01	9.72E+01	9.73E+01	9.73E+01	9.74E+01	9.74E+01	9.76E+01	9.76E+01	9.76E+01	9.76E+01	9.77E+01	
1247	9.83E+01	9.81E+01	9.81E+01	9.80E+01	9.82E+01	9.81E+01	9.81E+01	9.82E+01	9.80E+01	9.80E+01	9.87E+01	
1248	9.69E+01	9.68E+01	9.70E+01	9.69E+01	9.71E+01	9.71E+01	9.71E+01	9.72E+01	9.73E+01	9.73E+01	9.77E+01	
1249	9.24E+01	9.24E+01	9.24E+01	9.24E+01	9.24E+01	9.23E+01	9.24E+01	9.23E+01	9.24E+01	9.22E+01	9.26E+01	
1250	9.82E+01	9.84E+01	9.85E+01	9.86E+01	9.85E+01	9.87E+01	9.87E+01	9.84E+01	9.83E+01	9.83E+01	9.78E+01	
1251	9.89E+01	9.88E+01	9.89E+01	9.91E+01	9.92E+01	9.92E+01	9.94E+01	9.94E+01	9.93E+01	9.93E+01	9.93E+01	
1261	9.37E+01	9.39E+01	9.39E+01	9.39E+01	9.39E+01	9.39E+01	9.40E+01	9.40E+01	9.39E+01	9.40E+01	9.41E+01	
1262	9.56E+01	9.56E+01	9.56E+01	9.57E+01	9.57E+01	9.57E+01	9.57E+01	9.55E+01	9.56E+01	9.54E+01	9.56E+01	
1263	9.72E+01	9.69E+01	9.69E+01	9.69E+01	9.70E+01	9.69E+01	9.70E+01	9.72E+01	9.69E+01	9.70E+01	9.73E+01	
1264	1.02E+02	1.02E+02	1.02E+02	1.02E+02	1.02E+02	1.02E+02	1.02E+02	1.02E+02	1.02E+02	1.02E+02	1.02E+02	
1265	9.77E+01	9.78E+01	9.78E+01	9.78E+01	9.77E+01	9.77E+01	9.76E+01	9.77E+01	9.77E+01	9.77E+01	9.78E+01	
Biased Statistics												
Average Biased	9.62E+01	9.62E+01	9.62E+01	9.63E+01	9.64E+01	9.64E+01	9.64E+01	9.64E+01	9.64E+01	9.64E+01	9.67E+01	
Std Dev Biased	2.24E+00	2.20E+00	2.22E+00	2.22E+00	2.23E+00	2.26E+00	2.24E+00	2.24E+00	2.19E+00	2.23E+00	2.10E+00	
Ps90%/90% (+KTL) Biased	1.01E+02	1.01E+02	1.01E+02	1.01E+02	1.01E+02	1.01E+02	1.01E+02	1.01E+02	1.01E+02	1.01E+02	1.01E+02	
Ps90%/90% (-KTL) Biased	9.16E+01	9.16E+01	9.17E+01	9.17E+01	9.17E+01	9.17E+01	9.18E+01	9.18E+01	9.19E+01	9.18E+01	9.24E+01	
Specification MIN	7.80E+01	7.70E+01	7.50E+01	7.50E+01	7.50E+01	6.50E+01	6.50E+01	6.50E+01	6.50E+01	6.50E+01	6.50E+01	
Status	PASS	PASS	PASS	PASS	PASS	PASS	PASS	PASS	PASS	PASS	PASS	

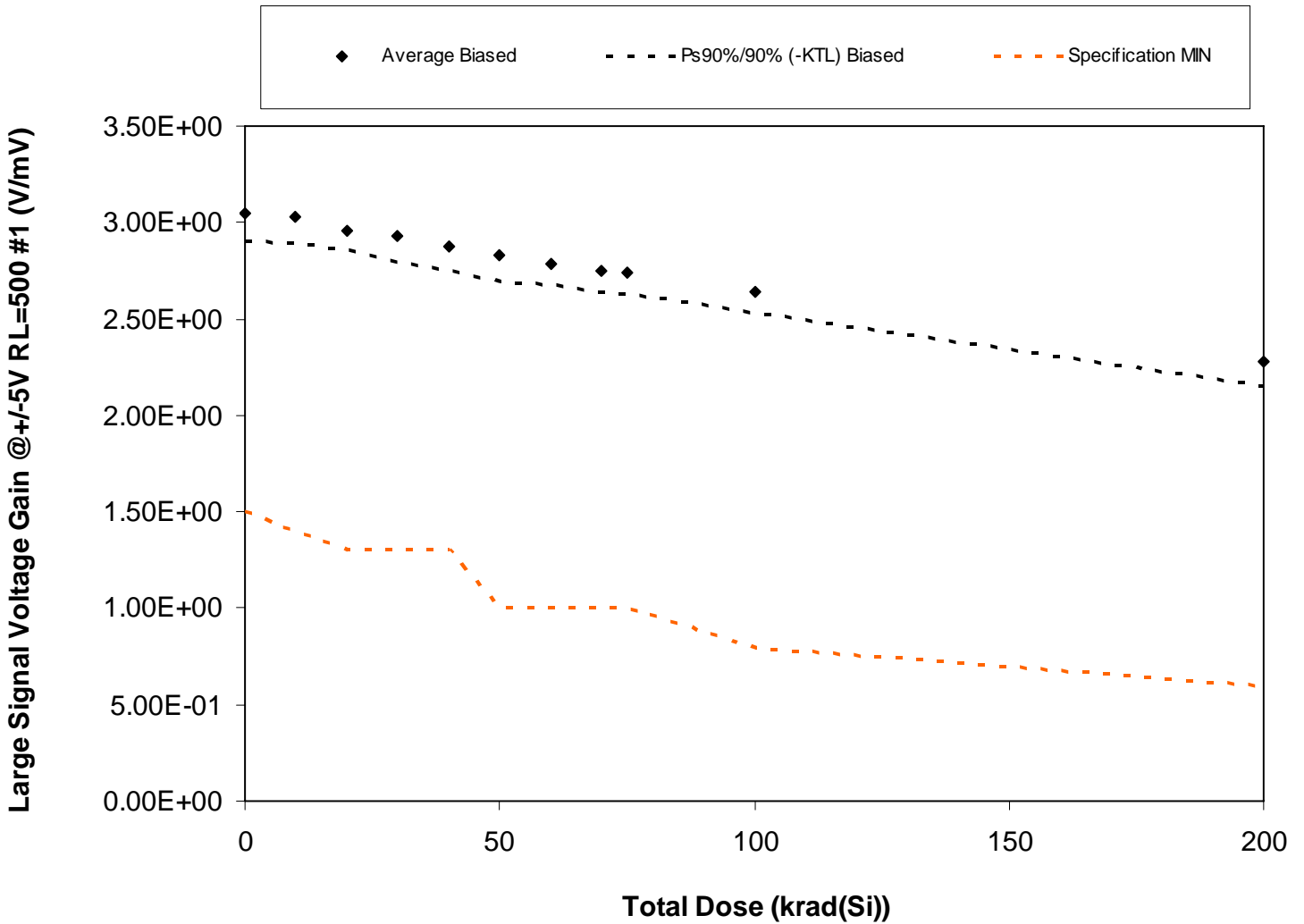

Figure 5.27. Plot of Large Signal Voltage Gain @ +/-5V RL=500 #1 (V/mV) versus total dose. The solid diamonds are the average of the measured data points for the samples irradiated under electrical bias and the black lines (solid and/or dashed) are the average of the data points after application of the KTL statistics on the samples irradiated under electrical bias. The red dotted line(s) are the pre- and/or post-irradiation minimum and/or maximum specification value as defined in the datasheet and/or test plan.



**RLAT Report
10-326 100808 R1.0**

**Radiation Assured Devices
5017 N. 30th Street
Colorado Springs, CO 80919
(719) 531-0800**

Table 5.27. Raw data for Large Signal Voltage Gain @+/-5V RL=500 #1 (V/mV) versus total dose, including the statistical analysis, specification and the status of the testing (pass/fail).

Large Signal Voltage Gain @+/-5V RL=500 #1 (V/mV)	Total Dose (krad(Si))											
	0	10	20	30	40	50	60	70	75	100	200	
Device												
1245	3.10E+00	3.10E+00	3.00E+00	3.00E+00	3.00E+00	2.90E+00	2.90E+00	2.80E+00	2.80E+00	2.70E+00	2.40E+00	
1246	3.00E+00	3.00E+00	2.90E+00	2.90E+00	2.80E+00	2.80E+00	2.70E+00	2.70E+00	2.70E+00	2.60E+00	2.20E+00	
1247	2.90E+00	2.90E+00	2.90E+00	2.80E+00	2.80E+00	2.70E+00	2.70E+00	2.70E+00	2.70E+00	2.60E+00	2.20E+00	
1248	3.10E+00	3.00E+00	3.00E+00	2.90E+00	2.90E+00	2.80E+00	2.80E+00	2.70E+00	2.70E+00	2.60E+00	2.20E+00	
1249	3.10E+00	3.10E+00	3.00E+00	3.00E+00	2.90E+00	2.90E+00	2.80E+00	2.80E+00	2.80E+00	2.70E+00	2.30E+00	
1250	3.10E+00	3.00E+00	3.00E+00	2.90E+00	2.90E+00	2.80E+00	2.80E+00	2.80E+00	2.70E+00	2.60E+00	2.30E+00	
1251	3.10E+00	3.10E+00	3.00E+00	3.00E+00	2.90E+00	2.90E+00	2.80E+00	2.80E+00	2.80E+00	2.70E+00	2.30E+00	
1261	3.00E+00	3.00E+00	2.90E+00	2.90E+00	2.90E+00	2.80E+00	2.80E+00	2.70E+00	2.70E+00	2.60E+00	2.30E+00	
1262	3.00E+00	3.00E+00	2.90E+00	2.90E+00	2.80E+00	2.80E+00	2.80E+00	2.70E+00	2.70E+00	2.60E+00	2.30E+00	
1263	3.10E+00	3.10E+00	3.00E+00	3.00E+00	2.90E+00	2.90E+00	2.80E+00	2.80E+00	2.80E+00	2.70E+00	2.30E+00	
1264	3.20E+00	3.20E+00	3.10E+00	3.20E+00	3.20E+00	3.20E+00	3.20E+00	3.20E+00	3.20E+00	3.20E+00	3.20E+00	
1265	2.90E+00	2.90E+00	2.90E+00	2.90E+00	2.90E+00	2.90E+00	2.90E+00	2.90E+00	2.90E+00	2.90E+00	2.90E+00	
Biased Statistics												
Average Biased	3.05E+00	3.03E+00	2.96E+00	2.93E+00	2.88E+00	2.83E+00	2.79E+00	2.75E+00	2.74E+00	2.64E+00	2.28E+00	
Std Dev Biased	7.07E-02	6.75E-02	5.16E-02	6.75E-02	6.32E-02	6.75E-02	5.68E-02	5.27E-02	5.16E-02	5.16E-02	6.32E-02	
Ps90%/90% (+KTL) Biased	3.20E+00	3.17E+00	3.07E+00	3.07E+00	3.01E+00	2.97E+00	2.91E+00	2.86E+00	2.85E+00	2.75E+00	2.41E+00	
Ps90%/90% (-KTL) Biased	2.90E+00	2.89E+00	2.85E+00	2.79E+00	2.75E+00	2.69E+00	2.67E+00	2.64E+00	2.63E+00	2.53E+00	2.15E+00	
Specification MIN	1.50E+00	1.40E+00	1.30E+00	1.30E+00	1.30E+00	1.00E+00	1.00E+00	1.00E+00	1.00E+00	8.00E-01	6.00E-01	
Status	PASS	PASS	PASS	PASS	PASS	PASS	PASS	PASS	PASS	PASS	PASS	

An ISO 9001:2008 and DSCC Certified Company

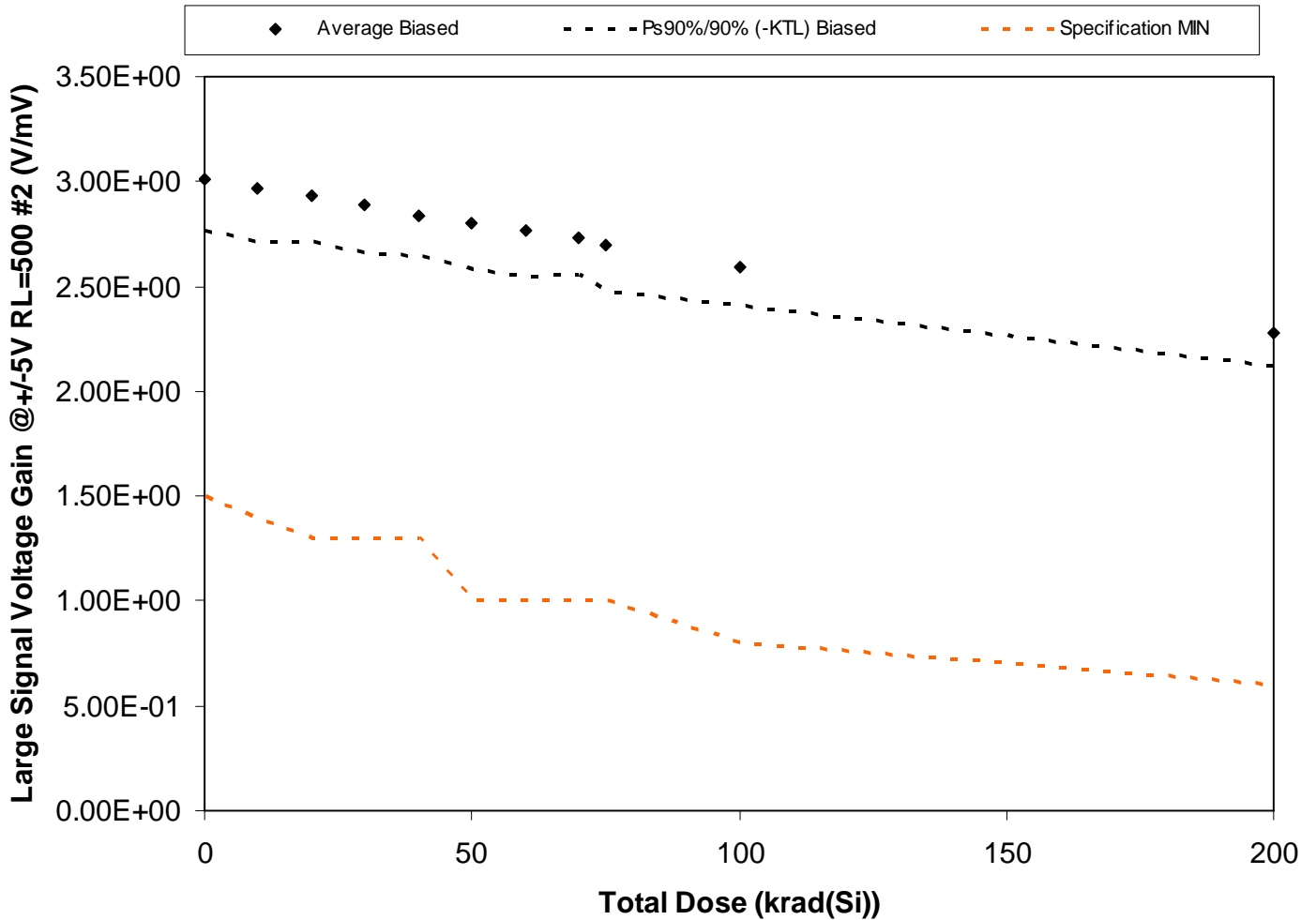

Figure 5.28. Plot of Large Signal Voltage Gain @ +/-5V RL=500 #2 (V/mV) versus total dose. The solid diamonds are the average of the measured data points for the samples irradiated under electrical bias and the black lines (solid and/or dashed) are the average of the data points after application of the KTL statistics on the samples irradiated under electrical bias. The red dotted line(s) are the pre- and/or post-irradiation minimum and/or maximum specification value as defined in the datasheet and/or test plan.



**RLAT Report
10-326 100808 R1.0**

**Radiation Assured Devices
5017 N. 30th Street
Colorado Springs, CO 80919
(719) 531-0800**

Table 5.28. Raw data for Large Signal Voltage Gain @+/-5V RL=500 #2 (V/mV) versus total dose, including the statistical analysis, specification and the status of the testing (pass/fail).

Large Signal Voltage Gain @+/-5V RL=500 #2 (V/mV)	Total Dose (krad(Si))											
	0	10	20	30	40	50	60	70	75	100	200	
Device												
1245	3.10E+00	3.10E+00	3.00E+00	3.00E+00	2.90E+00	2.90E+00	2.90E+00	2.80E+00	2.80E+00	2.70E+00	2.40E+00	
1246	2.90E+00	2.90E+00	2.90E+00	2.80E+00	2.80E+00	2.70E+00	2.70E+00	2.70E+00	2.60E+00	2.50E+00	2.20E+00	
1247	3.00E+00	3.00E+00	2.90E+00	2.90E+00	2.80E+00	2.80E+00	2.80E+00	2.70E+00	2.70E+00	2.60E+00	2.30E+00	
1248	3.20E+00	3.10E+00	3.10E+00	3.00E+00	3.00E+00	2.90E+00	2.90E+00	2.80E+00	2.80E+00	2.70E+00	2.30E+00	
1249	3.20E+00	3.20E+00	3.10E+00	3.10E+00	3.00E+00	3.00E+00	2.90E+00	2.90E+00	2.90E+00	2.70E+00	2.40E+00	
1250	3.00E+00	2.90E+00	2.90E+00	2.90E+00	2.80E+00	2.80E+00	2.80E+00	2.70E+00	2.70E+00	2.60E+00	2.30E+00	
1251	2.90E+00	2.90E+00	2.80E+00	2.80E+00	2.80E+00	2.70E+00	2.70E+00	2.70E+00	2.60E+00	2.50E+00	2.20E+00	
1261	2.90E+00	2.80E+00	2.80E+00	2.80E+00	2.70E+00	2.70E+00	2.60E+00	2.60E+00	2.60E+00	2.50E+00	2.20E+00	
1262	3.00E+00	2.90E+00	2.90E+00	2.80E+00	2.80E+00	2.80E+00	2.70E+00	2.70E+00	2.70E+00	2.60E+00	2.30E+00	
1263	2.90E+00	2.90E+00	2.90E+00	2.80E+00	2.80E+00	2.70E+00	2.70E+00	2.70E+00	2.60E+00	2.50E+00	2.20E+00	
1264	3.10E+00	3.10E+00	3.10E+00	3.10E+00	3.10E+00	3.10E+00	3.10E+00	3.10E+00	3.10E+00	3.10E+00	3.10E+00	
1265	3.10E+00	3.10E+00	3.10E+00	3.10E+00	3.10E+00	3.10E+00	3.10E+00	3.10E+00	3.10E+00	3.10E+00	3.10E+00	
Biased Statistics												
Average Biased	3.01E+00	2.97E+00	2.93E+00	2.89E+00	2.84E+00	2.80E+00	2.77E+00	2.73E+00	2.70E+00	2.59E+00	2.28E+00	
Std Dev Biased	1.20E-01	1.25E-01	1.06E-01	1.10E-01	9.66E-02	1.05E-01	1.06E-01	8.23E-02	1.05E-01	8.76E-02	7.89E-02	
Ps90%/90% (+KTL) Biased	3.26E+00	3.23E+00	3.15E+00	3.12E+00	3.04E+00	3.02E+00	2.99E+00	2.90E+00	2.92E+00	2.77E+00	2.44E+00	
Ps90%/90% (-KTL) Biased	2.76E+00	2.71E+00	2.71E+00	2.66E+00	2.64E+00	2.58E+00	2.55E+00	2.56E+00	2.48E+00	2.41E+00	2.12E+00	
Specification MIN	1.50E+00	1.40E+00	1.30E+00	1.30E+00	1.30E+00	1.00E+00	1.00E+00	1.00E+00	1.00E+00	8.00E-01	6.00E-01	
Status	PASS	PASS	PASS	PASS	PASS	PASS	PASS	PASS	PASS	PASS	PASS	

An ISO 9001:2008 and DSCC Certified Company

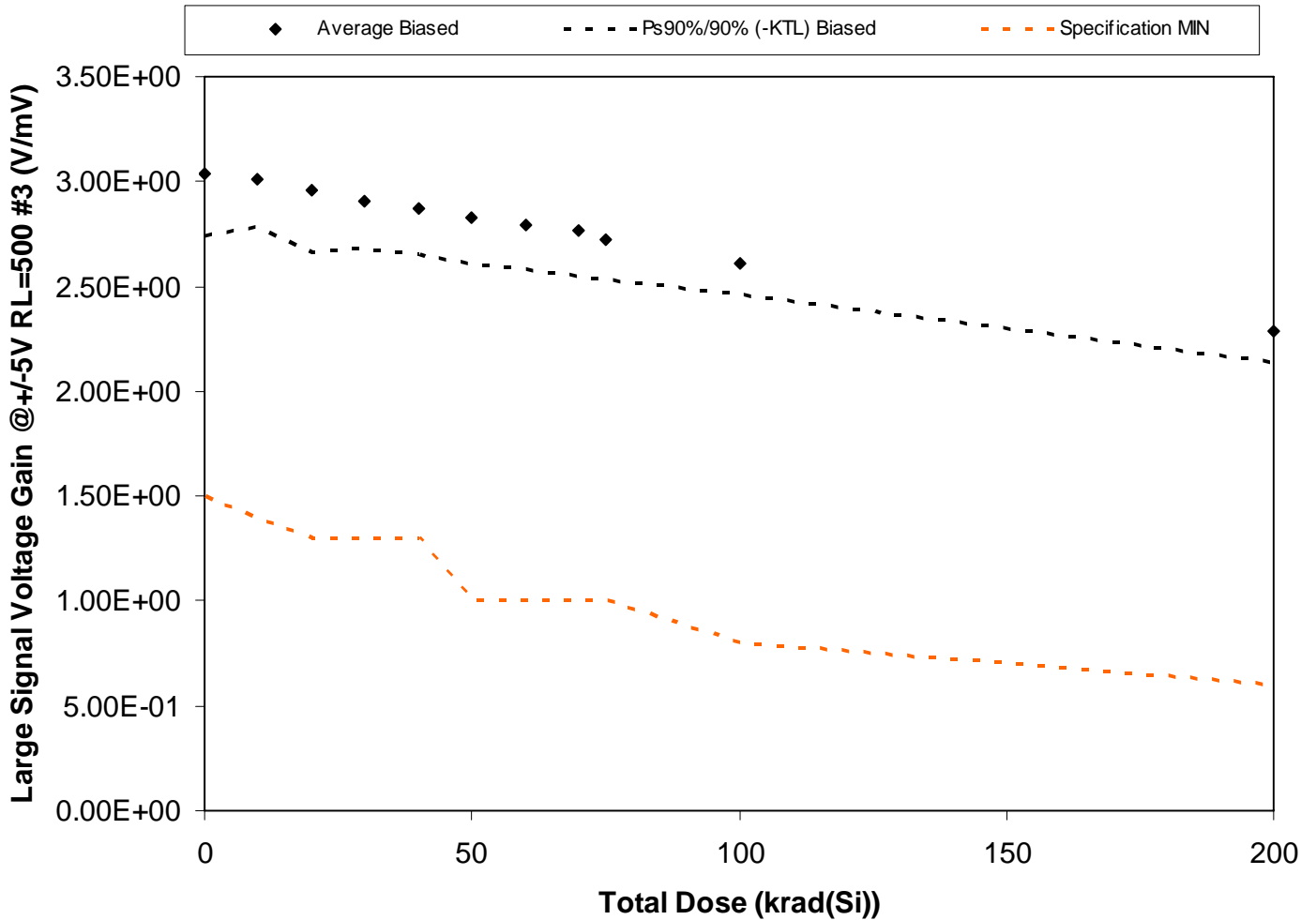

Figure 5.29. Plot of Large Signal Voltage Gain @ +/-5V RL=500 #3 (V/mV) versus total dose. The solid diamonds are the average of the measured data points for the samples irradiated under electrical bias and the black lines (solid and/or dashed) are the average of the data points after application of the KTL statistics on the samples irradiated under electrical bias. The red dotted line(s) are the pre- and/or post-irradiation minimum and/or maximum specification value as defined in the datasheet and/or test plan.



**RLAT Report
10-326 100808 R1.0**

**Radiation Assured Devices
5017 N. 30th Street
Colorado Springs, CO 80919
(719) 531-0800**

Table 5.29. Raw data for Large Signal Voltage Gain @+/-5V RL=500 #3 (V/mV) versus total dose, including the statistical analysis, specification and the status of the testing (pass/fail).

Large Signal Voltage Gain @+/-5V RL=500 #3 (V/mV)	Total Dose (krad(Si))											
	0	10	20	30	40	50	60	70	75	100	200	
Device												
1245	3.10E+00	3.10E+00	3.10E+00	3.00E+00	3.00E+00	2.90E+00	2.90E+00	2.90E+00	2.80E+00	2.70E+00	2.40E+00	
1246	2.90E+00	2.90E+00	2.90E+00	2.80E+00	2.80E+00	2.70E+00	2.70E+00	2.70E+00	2.60E+00	2.50E+00	2.20E+00	
1247	3.00E+00	3.00E+00	2.90E+00	2.90E+00	2.80E+00	2.80E+00	2.80E+00	2.70E+00	2.70E+00	2.60E+00	2.30E+00	
1248	3.30E+00	3.20E+00	3.20E+00	3.10E+00	3.00E+00	3.00E+00	2.90E+00	2.90E+00	2.90E+00	2.70E+00	2.30E+00	
1249	3.20E+00	3.10E+00	3.10E+00	3.00E+00	3.00E+00	3.00E+00	2.90E+00	2.90E+00	2.80E+00	2.70E+00	2.40E+00	
1250	3.10E+00	3.00E+00	3.00E+00	2.90E+00	2.90E+00	2.80E+00	2.80E+00	2.80E+00	2.70E+00	2.60E+00	2.30E+00	
1251	3.00E+00	3.00E+00	2.90E+00	2.90E+00	2.80E+00	2.80E+00	2.80E+00	2.70E+00	2.70E+00	2.60E+00	2.30E+00	
1261	2.80E+00	2.80E+00	2.70E+00	2.70E+00	2.70E+00	2.70E+00	2.60E+00	2.60E+00	2.60E+00	2.50E+00	2.20E+00	
1262	3.00E+00	3.00E+00	2.90E+00	2.90E+00	2.90E+00	2.80E+00	2.80E+00	2.80E+00	2.70E+00	2.60E+00	2.30E+00	
1263	3.00E+00	3.00E+00	2.90E+00	2.90E+00	2.80E+00	2.80E+00	2.70E+00	2.70E+00	2.70E+00	2.60E+00	2.20E+00	
1264	3.10E+00	3.10E+00	3.10E+00	3.10E+00	3.10E+00	3.10E+00	3.10E+00	3.10E+00	3.10E+00	3.10E+00	3.10E+00	
1265	3.10E+00	3.10E+00	3.10E+00	3.10E+00	3.10E+00	3.10E+00	3.10E+00	3.10E+00	3.10E+00	3.10E+00	3.10E+00	
Biased Statistics												
Average Biased	3.04E+00	3.01E+00	2.96E+00	2.91E+00	2.87E+00	2.83E+00	2.79E+00	2.77E+00	2.72E+00	2.61E+00	2.29E+00	
Std Dev Biased	1.43E-01	1.10E-01	1.43E-01	1.10E-01	1.06E-01	1.06E-01	9.94E-02	1.06E-01	9.19E-02	7.38E-02	7.38E-02	
Ps90%/90% (+KTL) Biased	3.34E+00	3.24E+00	3.26E+00	3.14E+00	3.09E+00	3.05E+00	3.00E+00	2.99E+00	2.91E+00	2.76E+00	2.44E+00	
Ps90%/90% (-KTL) Biased	2.74E+00	2.78E+00	2.66E+00	2.68E+00	2.65E+00	2.61E+00	2.58E+00	2.55E+00	2.53E+00	2.46E+00	2.14E+00	
Specification MIN	1.50E+00	1.40E+00	1.30E+00	1.30E+00	1.30E+00	1.00E+00	1.00E+00	1.00E+00	1.00E+00	8.00E-01	6.00E-01	
Status	PASS	PASS	PASS	PASS	PASS	PASS	PASS	PASS	PASS	PASS	PASS	

An ISO 9001:2008 and DSCC Certified Company

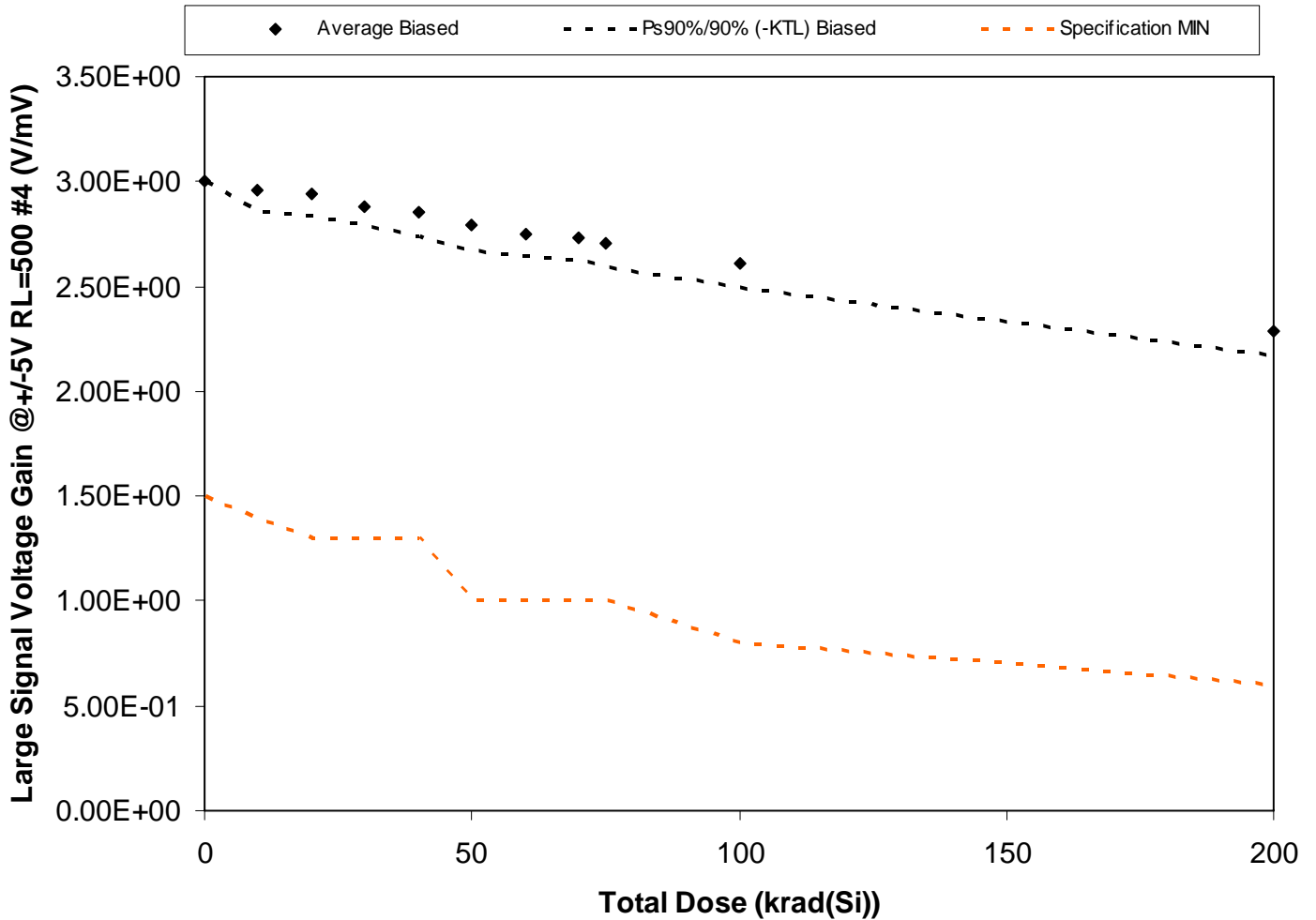

Figure 5.30. Plot of Large Signal Voltage Gain @ +/-5V RL=500 #4 (V/mV) versus total dose. The solid diamonds are the average of the measured data points for the samples irradiated under electrical bias and the black lines (solid and/or dashed) are the average of the data points after application of the KTL statistics on the samples irradiated under electrical bias. The red dotted line(s) are the pre- and/or post-irradiation minimum and/or maximum specification value as defined in the datasheet and/or test plan.



**RLAT Report
10-326 100808 R1.0**

**Radiation Assured Devices
5017 N. 30th Street
Colorado Springs, CO 80919
(719) 531-0800**

Table 5.30. Raw data for Large Signal Voltage Gain @+/-5V RL=500 #4 (V/mV) versus total dose, including the statistical analysis, specification and the status of the testing (pass/fail).

Large Signal Voltage Gain @+/-5V RL=500 #4 (V/mV)	Total Dose (krad(Si))											
	0	10	20	30	40	50	60	70	75	100	200	
Device												
1245	3.00E+00	3.00E+00	2.90E+00	2.90E+00	2.90E+00	2.80E+00	2.80E+00	2.70E+00	2.70E+00	2.60E+00	2.30E+00	
1246	3.00E+00	2.90E+00	2.90E+00	2.90E+00	2.80E+00	2.80E+00	2.70E+00	2.70E+00	2.70E+00	2.60E+00	2.30E+00	
1247	3.00E+00	3.00E+00	3.00E+00	2.90E+00	2.90E+00	2.80E+00	2.80E+00	2.80E+00	2.80E+00	2.70E+00	2.30E+00	
1248	3.00E+00	2.90E+00	2.90E+00	2.80E+00	2.80E+00	2.70E+00	2.70E+00	2.70E+00	2.60E+00	2.50E+00	2.20E+00	
1249	3.00E+00	2.90E+00	2.90E+00	2.90E+00	2.80E+00	2.80E+00	2.70E+00	2.70E+00	2.70E+00	2.60E+00	2.30E+00	
1250	3.00E+00	3.00E+00	3.00E+00	2.90E+00	2.90E+00	2.80E+00	2.80E+00	2.80E+00	2.70E+00	2.60E+00	2.30E+00	
1251	3.00E+00	3.00E+00	3.00E+00	2.90E+00	2.90E+00	2.90E+00	2.80E+00	2.80E+00	2.80E+00	2.70E+00	2.40E+00	
1261	3.00E+00	3.00E+00	2.90E+00	2.90E+00	2.80E+00	2.80E+00	2.70E+00	2.70E+00	2.70E+00	2.60E+00	2.30E+00	
1262	3.00E+00	2.90E+00	2.90E+00	2.80E+00	2.80E+00	2.70E+00	2.70E+00	2.70E+00	2.70E+00	2.60E+00	2.20E+00	
1263	3.00E+00	3.00E+00	3.00E+00	2.90E+00	2.90E+00	2.80E+00	2.80E+00	2.70E+00	2.70E+00	2.60E+00	2.30E+00	
1264	3.10E+00	3.10E+00	3.10E+00	3.10E+00	3.10E+00	3.10E+00	3.10E+00	3.10E+00	3.10E+00	3.10E+00	3.10E+00	
1265	3.00E+00	3.00E+00	3.00E+00	3.00E+00	3.00E+00	3.00E+00	3.00E+00	3.00E+00	3.00E+00	3.00E+00	3.00E+00	
Biased Statistics												
Average Biased	3.00E+00	2.96E+00	2.94E+00	2.88E+00	2.85E+00	2.79E+00	2.75E+00	2.73E+00	2.71E+00	2.61E+00	2.29E+00	
Std Dev Biased	0.00E+00	5.16E-02	5.16E-02	4.22E-02	5.27E-02	5.68E-02	5.27E-02	4.83E-02	5.68E-02	5.68E-02	5.68E-02	
Ps90%/90% (+KTL) Biased	3.00E+00	3.07E+00	3.05E+00	2.97E+00	2.96E+00	2.91E+00	2.86E+00	2.83E+00	2.83E+00	2.73E+00	2.41E+00	
Ps90%/90% (-KTL) Biased	3.00E+00	2.85E+00	2.83E+00	2.79E+00	2.74E+00	2.67E+00	2.64E+00	2.63E+00	2.59E+00	2.49E+00	2.17E+00	
Specification MIN	1.50E+00	1.40E+00	1.30E+00	1.30E+00	1.30E+00	1.00E+00	1.00E+00	1.00E+00	1.00E+00	8.00E-01	6.00E-01	
Status	PASS	PASS	PASS	PASS	PASS	PASS	PASS	PASS	PASS	PASS	PASS	

An ISO 9001:2008 and DSCC Certified Company

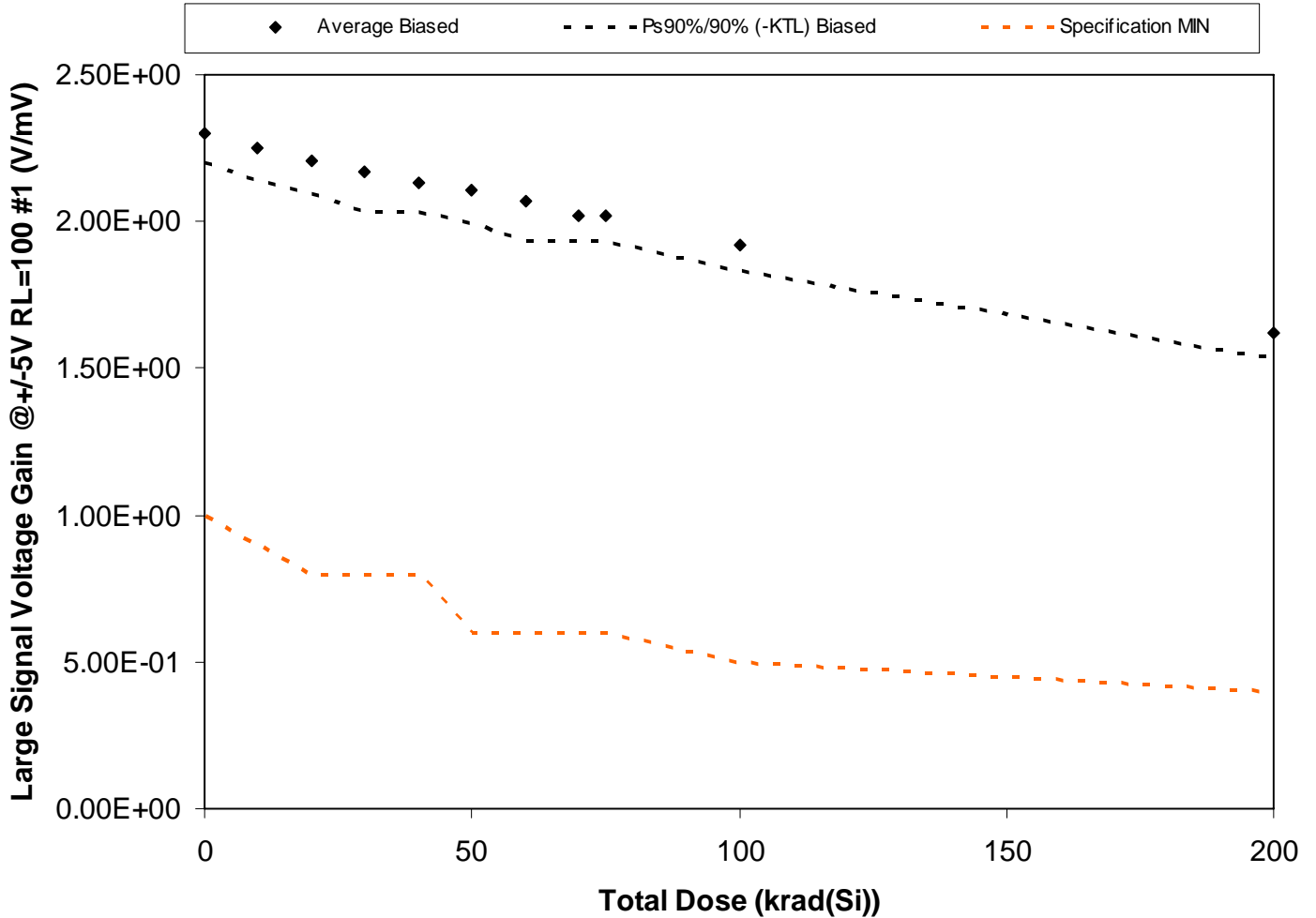

Figure 5.31. Plot of Large Signal Voltage Gain @ +/-5V RL=100 #1 (V/mV) versus total dose. The solid diamonds are the average of the measured data points for the samples irradiated under electrical bias and the black lines (solid and/or dashed) are the average of the data points after application of the KTL statistics on the samples irradiated under electrical bias. The red dotted line(s) are the pre- and/or post-irradiation minimum and/or maximum specification value as defined in the datasheet and/or test plan.



**RLAT Report
10-326 100808 R1.0**

**Radiation Assured Devices
5017 N. 30th Street
Colorado Springs, CO 80919
(719) 531-0800**

Table 5.31. Raw data for Large Signal Voltage Gain @+/-5V RL=100 #1 (V/mV) versus total dose, including the statistical analysis, specification and the status of the testing (pass/fail).

Large Signal Voltage Gain @+/-5V RL=100 #1 (V/mV)	Total Dose (krad(Si))											
	0	10	20	30	40	50	60	70	75	100	200	
Device												
1245	2.30E+00	2.30E+00	2.30E+00	2.20E+00	2.20E+00	2.20E+00	2.10E+00	2.10E+00	2.10E+00	2.00E+00	1.70E+00	
1246	2.30E+00	2.20E+00	2.20E+00	2.10E+00	2.10E+00	2.10E+00	2.00E+00	2.00E+00	2.00E+00	1.90E+00	1.60E+00	
1247	2.20E+00	2.20E+00	2.10E+00	2.10E+00	2.10E+00	2.00E+00	2.00E+00	2.00E+00	2.00E+00	1.90E+00	1.60E+00	
1248	2.30E+00	2.30E+00	2.20E+00	2.20E+00	2.10E+00	2.10E+00	2.10E+00	2.00E+00	2.00E+00	1.90E+00	1.60E+00	
1249	2.40E+00	2.30E+00	2.30E+00	2.30E+00	2.20E+00	2.20E+00	2.20E+00	2.10E+00	2.10E+00	2.00E+00	1.70E+00	
1250	2.30E+00	2.20E+00	2.20E+00	2.20E+00	2.10E+00	2.10E+00	2.10E+00	2.00E+00	2.00E+00	1.90E+00	1.60E+00	
1251	2.30E+00	2.30E+00	2.20E+00	2.20E+00	2.10E+00	2.10E+00	2.10E+00	2.00E+00	2.00E+00	1.90E+00	1.60E+00	
1261	2.30E+00	2.20E+00	2.20E+00	2.10E+00	2.10E+00	2.10E+00	2.00E+00	2.00E+00	2.00E+00	1.90E+00	1.60E+00	
1262	2.30E+00	2.20E+00	2.20E+00	2.10E+00	2.10E+00	2.10E+00	2.00E+00	2.00E+00	2.00E+00	1.90E+00	1.60E+00	
1263	2.30E+00	2.30E+00	2.20E+00	2.20E+00	2.20E+00	2.10E+00	2.10E+00	2.00E+00	2.00E+00	1.90E+00	1.60E+00	
1264	2.40E+00	2.40E+00	2.40E+00	2.40E+00	2.40E+00	2.40E+00	2.40E+00	2.40E+00	2.40E+00	2.40E+00	2.40E+00	
1265	2.20E+00	2.20E+00	2.20E+00	2.20E+00	2.20E+00	2.20E+00	2.20E+00	2.20E+00	2.20E+00	2.20E+00	2.20E+00	
Biased Statistics												
Average Biased	2.30E+00	2.25E+00	2.21E+00	2.17E+00	2.13E+00	2.11E+00	2.07E+00	2.02E+00	2.02E+00	1.92E+00	1.62E+00	
Std Dev Biased	4.71E-02	5.27E-02	5.68E-02	6.75E-02	4.83E-02	5.68E-02	6.75E-02	4.22E-02	4.22E-02	4.22E-02	4.22E-02	
Ps90%/90% (+KTL) Biased	2.40E+00	2.36E+00	2.33E+00	2.31E+00	2.23E+00	2.23E+00	2.21E+00	2.11E+00	2.11E+00	2.01E+00	1.71E+00	
Ps90%/90% (-KTL) Biased	2.20E+00	2.14E+00	2.09E+00	2.03E+00	2.03E+00	1.99E+00	1.93E+00	1.93E+00	1.93E+00	1.83E+00	1.53E+00	
Specification MIN	1.00E+00	9.00E-01	8.00E-01	8.00E-01	8.00E-01	6.00E-01	6.00E-01	6.00E-01	6.00E-01	5.00E-01	4.00E-01	
Status	PASS	PASS	PASS	PASS	PASS	PASS	PASS	PASS	PASS	PASS	PASS	

An ISO 9001:2008 and DSCC Certified Company

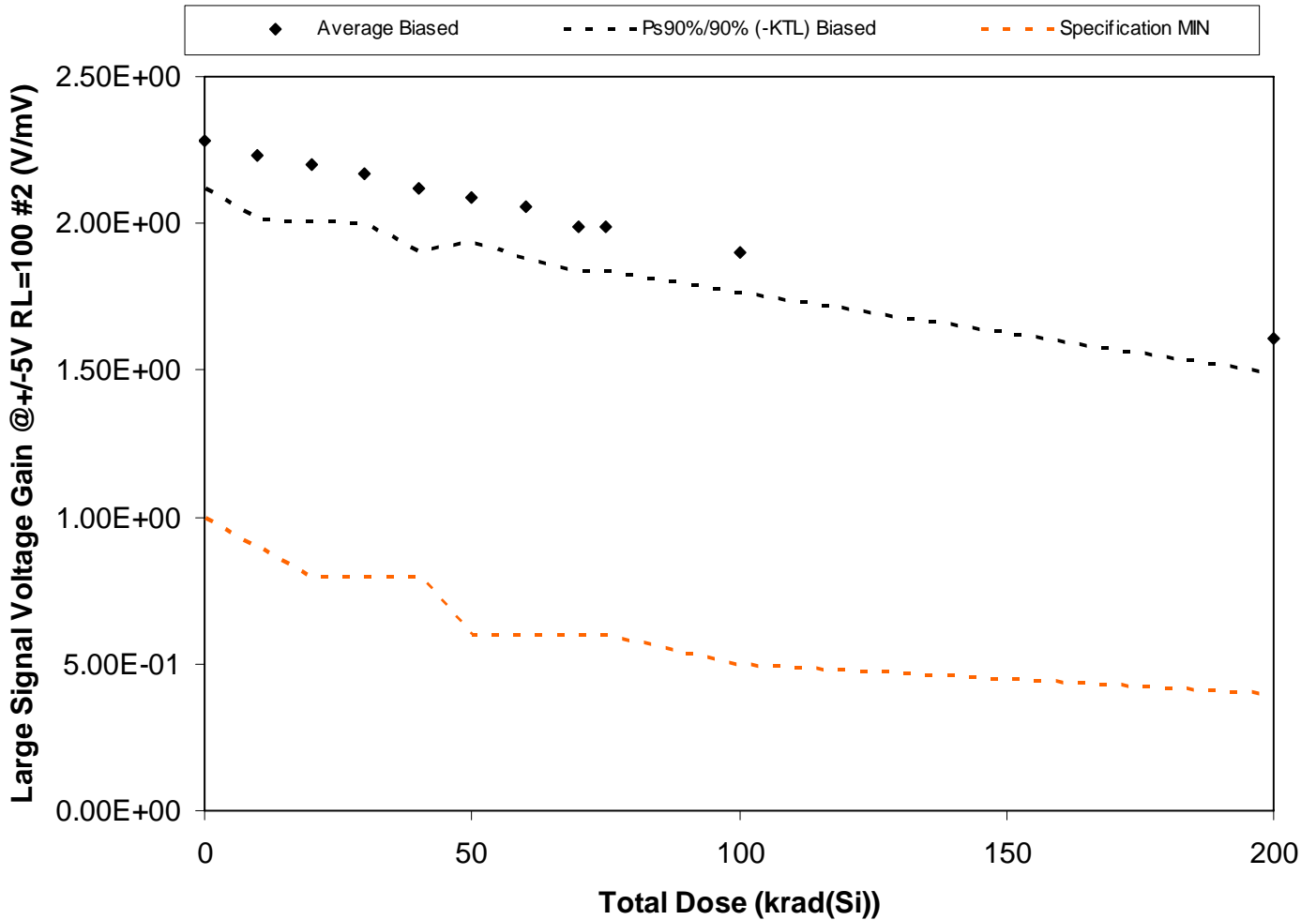

Figure 5.32. Plot of Large Signal Voltage Gain @ +/-5V RL=100 #2 (V/mV) versus total dose. The solid diamonds are the average of the measured data points for the samples irradiated under electrical bias and the black lines (solid and/or dashed) are the average of the data points after application of the KTL statistics on the samples irradiated under electrical bias. The red dotted line(s) are the pre- and/or post-irradiation minimum and/or maximum specification value as defined in the datasheet and/or test plan.



**RLAT Report
10-326 100808 R1.0**

**Radiation Assured Devices
5017 N. 30th Street
Colorado Springs, CO 80919
(719) 531-0800**

Table 5.32. Raw data for Large Signal Voltage Gain @+/-5V RL=100 #2 (V/mV) versus total dose, including the statistical analysis, specification and the status of the testing (pass/fail).

Large Signal Voltage Gain @+/-5V RL=100 #2 (V/mV)	Total Dose (krad(Si))											
	0	10	20	30	40	50	60	70	75	100	200	
Device												
1245	2.30E+00	2.30E+00	2.20E+00	2.20E+00	2.10E+00	2.10E+00	2.10E+00	2.00E+00	2.00E+00	1.90E+00	1.60E+00	
1246	2.20E+00	2.10E+00	2.10E+00	2.10E+00	2.10E+00	2.00E+00	2.00E+00	1.90E+00	1.90E+00	1.80E+00	1.60E+00	
1247	2.30E+00	2.20E+00	2.20E+00	2.20E+00	2.10E+00	2.10E+00	2.10E+00	2.00E+00	2.00E+00	1.90E+00	1.60E+00	
1248	2.40E+00	2.40E+00	2.40E+00	2.30E+00	2.30E+00	2.20E+00	2.20E+00	2.10E+00	2.10E+00	2.00E+00	1.70E+00	
1249	2.40E+00	2.40E+00	2.30E+00	2.30E+00	2.30E+00	2.20E+00	2.20E+00	2.10E+00	2.10E+00	2.00E+00	1.70E+00	
1250	2.30E+00	2.20E+00	2.20E+00	2.10E+00	2.10E+00	2.10E+00	2.00E+00	2.00E+00	2.00E+00	1.90E+00	1.60E+00	
1251	2.20E+00	2.20E+00	2.10E+00	2.10E+00	2.00E+00	2.00E+00	2.00E+00	1.90E+00	1.90E+00	1.90E+00	1.60E+00	
1261	2.20E+00	2.10E+00	2.10E+00	2.10E+00	2.00E+00	2.00E+00	2.00E+00	1.90E+00	1.90E+00	1.80E+00	1.50E+00	
1262	2.20E+00	2.20E+00	2.20E+00	2.10E+00	2.10E+00	2.10E+00	2.00E+00	2.00E+00	2.00E+00	1.90E+00	1.60E+00	
1263	2.30E+00	2.20E+00	2.20E+00	2.20E+00	2.10E+00	2.10E+00	2.00E+00	2.00E+00	2.00E+00	1.90E+00	1.60E+00	
1264	2.30E+00	2.30E+00	2.30E+00	2.30E+00	2.30E+00	2.30E+00	2.30E+00	2.30E+00	2.30E+00	2.30E+00	2.30E+00	
1265	2.30E+00	2.30E+00	2.30E+00	2.30E+00	2.30E+00	2.30E+00	2.30E+00	2.30E+00	2.30E+00	2.30E+00	2.30E+00	
Biased Statistics												
Average Biased	2.28E+00	2.23E+00	2.20E+00	2.17E+00	2.12E+00	2.09E+00	2.06E+00	1.99E+00	1.99E+00	1.90E+00	1.61E+00	
Std Dev Biased	7.89E-02	1.06E-01	9.43E-02	8.23E-02	1.03E-01	7.38E-02	8.43E-02	7.38E-02	7.38E-02	6.67E-02	5.68E-02	
Ps90%/90% (+KTL) Biased	2.44E+00	2.45E+00	2.39E+00	2.34E+00	2.33E+00	2.24E+00	2.23E+00	2.14E+00	2.14E+00	2.04E+00	1.73E+00	
Ps90%/90% (-KTL) Biased	2.12E+00	2.01E+00	2.01E+00	2.00E+00	1.91E+00	1.94E+00	1.89E+00	1.84E+00	1.84E+00	1.76E+00	1.49E+00	
Specification MIN	1.00E+00	9.00E-01	8.00E-01	8.00E-01	8.00E-01	6.00E-01	6.00E-01	6.00E-01	6.00E-01	5.00E-01	4.00E-01	
Status	PASS	PASS	PASS	PASS	PASS	PASS	PASS	PASS	PASS	PASS	PASS	

An ISO 9001:2008 and DSCC Certified Company

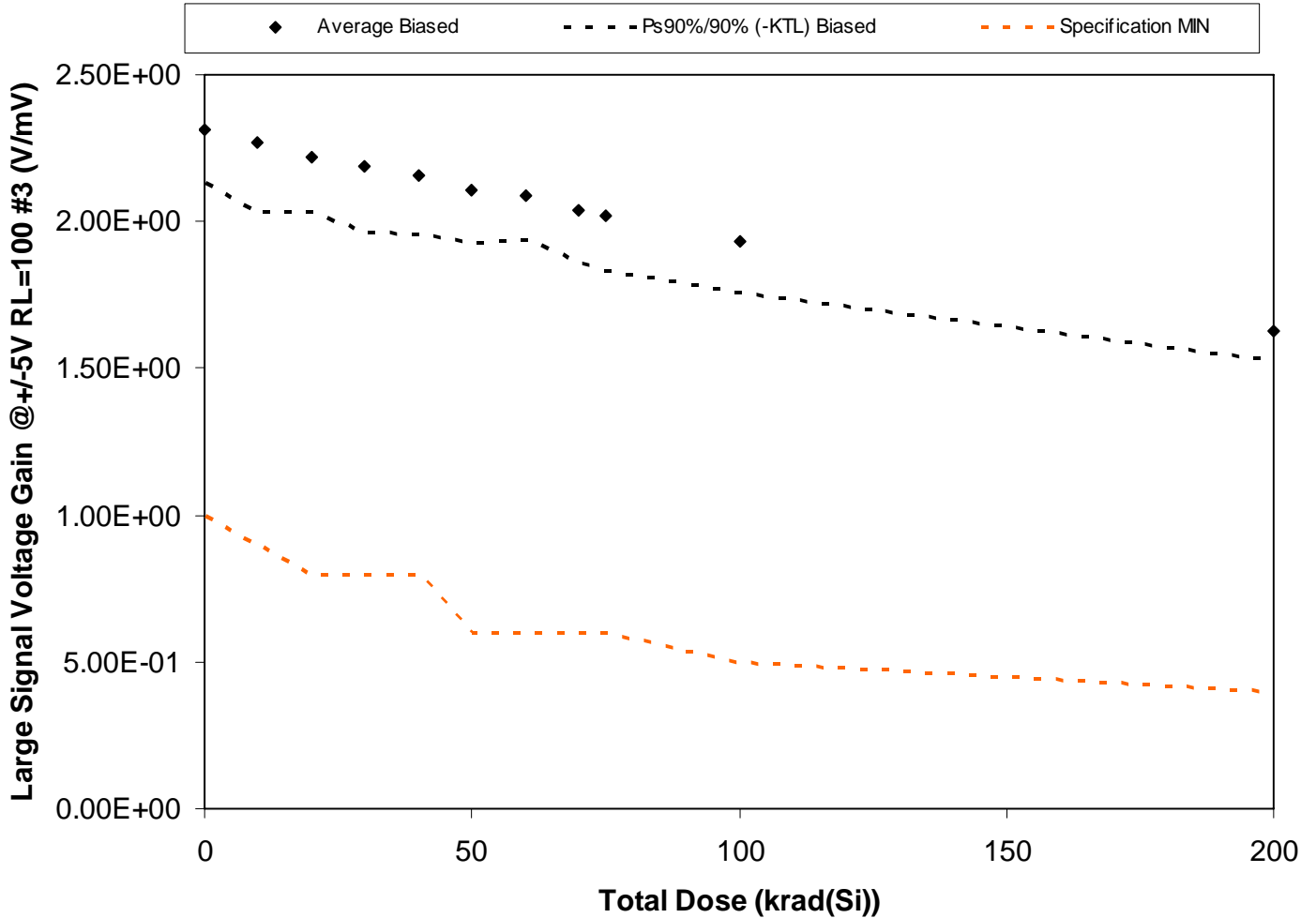

Figure 5.33. Plot of Large Signal Voltage Gain @ +/-5V RL=100 #3 (V/mV) versus total dose. The solid diamonds are the average of the measured data points for the samples irradiated under electrical bias and the black lines (solid and/or dashed) are the average of the data points after application of the KTL statistics on the samples irradiated under electrical bias. The red dotted line(s) are the pre- and/or post-irradiation minimum and/or maximum specification value as defined in the datasheet and/or test plan.



**RLAT Report
10-326 100808 R1.0**

**Radiation Assured Devices
5017 N. 30th Street
Colorado Springs, CO 80919
(719) 531-0800**

Table 5.33. Raw data for Large Signal Voltage Gain @+/-5V RL=100 #3 (V/mV) versus total dose, including the statistical analysis, specification and the status of the testing (pass/fail).

Large Signal Voltage Gain @+/-5V RL=100 #3 (V/mV)	Total Dose (krad(Si))											
	0	10	20	30	40	50	60	70	75	100	200	
Device												
1245	2.30E+00	2.30E+00	2.30E+00	2.20E+00	2.20E+00	2.10E+00	2.10E+00	2.10E+00	2.10E+00	2.00E+00	1.70E+00	
1246	2.20E+00	2.20E+00	2.10E+00	2.10E+00	2.10E+00	2.00E+00	2.00E+00	2.00E+00	1.90E+00	1.90E+00	1.60E+00	
1247	2.30E+00	2.20E+00	2.20E+00	2.20E+00	2.10E+00	2.10E+00	2.10E+00	2.00E+00	2.00E+00	1.90E+00	1.60E+00	
1248	2.50E+00	2.50E+00	2.40E+00	2.40E+00	2.30E+00	2.30E+00	2.20E+00	2.20E+00	2.20E+00	2.10E+00	1.70E+00	
1249	2.40E+00	2.40E+00	2.30E+00	2.30E+00	2.30E+00	2.20E+00	2.20E+00	2.10E+00	2.10E+00	2.00E+00	1.70E+00	
1250	2.30E+00	2.30E+00	2.20E+00	2.20E+00	2.20E+00	2.10E+00	2.10E+00	2.00E+00	2.00E+00	1.90E+00	1.60E+00	
1251	2.30E+00	2.20E+00	2.20E+00	2.10E+00	2.10E+00	2.10E+00	2.00E+00	2.00E+00	2.00E+00	1.90E+00	1.60E+00	
1261	2.20E+00	2.10E+00	2.10E+00	2.00E+00	2.00E+00	2.00E+00	2.00E+00	1.90E+00	1.90E+00	1.80E+00	1.60E+00	
1262	2.30E+00	2.20E+00	2.20E+00	2.20E+00	2.10E+00	2.10E+00	2.10E+00	2.10E+00	2.00E+00	1.90E+00	1.60E+00	
1263	2.30E+00	2.30E+00	2.20E+00	2.20E+00	2.20E+00	2.10E+00	2.10E+00	2.00E+00	2.00E+00	1.90E+00	1.60E+00	
1264	2.30E+00	2.30E+00	2.30E+00	2.30E+00	2.30E+00	2.30E+00	2.30E+00	2.30E+00	2.30E+00	2.30E+00	2.30E+00	
1265	2.30E+00	2.30E+00	2.30E+00	2.30E+00	2.30E+00	2.30E+00	2.30E+00	2.30E+00	2.30E+00	2.30E+00	2.30E+00	
Biased Statistics												
Average Biased	2.31E+00	2.27E+00	2.22E+00	2.19E+00	2.16E+00	2.11E+00	2.09E+00	2.04E+00	2.02E+00	1.93E+00	1.63E+00	
Std Dev Biased	8.76E-02	1.16E-01	9.19E-02	1.10E-01	9.66E-02	8.76E-02	7.38E-02	8.43E-02	9.19E-02	8.23E-02	4.83E-02	
Ps90%/90% (+KTL) Biased	2.49E+00	2.51E+00	2.41E+00	2.42E+00	2.36E+00	2.29E+00	2.24E+00	2.21E+00	2.21E+00	2.10E+00	1.73E+00	
Ps90%/90% (-KTL) Biased	2.13E+00	2.03E+00	2.03E+00	1.96E+00	1.96E+00	1.93E+00	1.94E+00	1.87E+00	1.83E+00	1.76E+00	1.53E+00	
Specification MIN	1.00E+00	9.00E-01	8.00E-01	8.00E-01	8.00E-01	6.00E-01	6.00E-01	6.00E-01	6.00E-01	5.00E-01	4.00E-01	
Status	PASS	PASS	PASS	PASS	PASS	PASS	PASS	PASS	PASS	PASS	PASS	

An ISO 9001:2008 and DSCC Certified Company

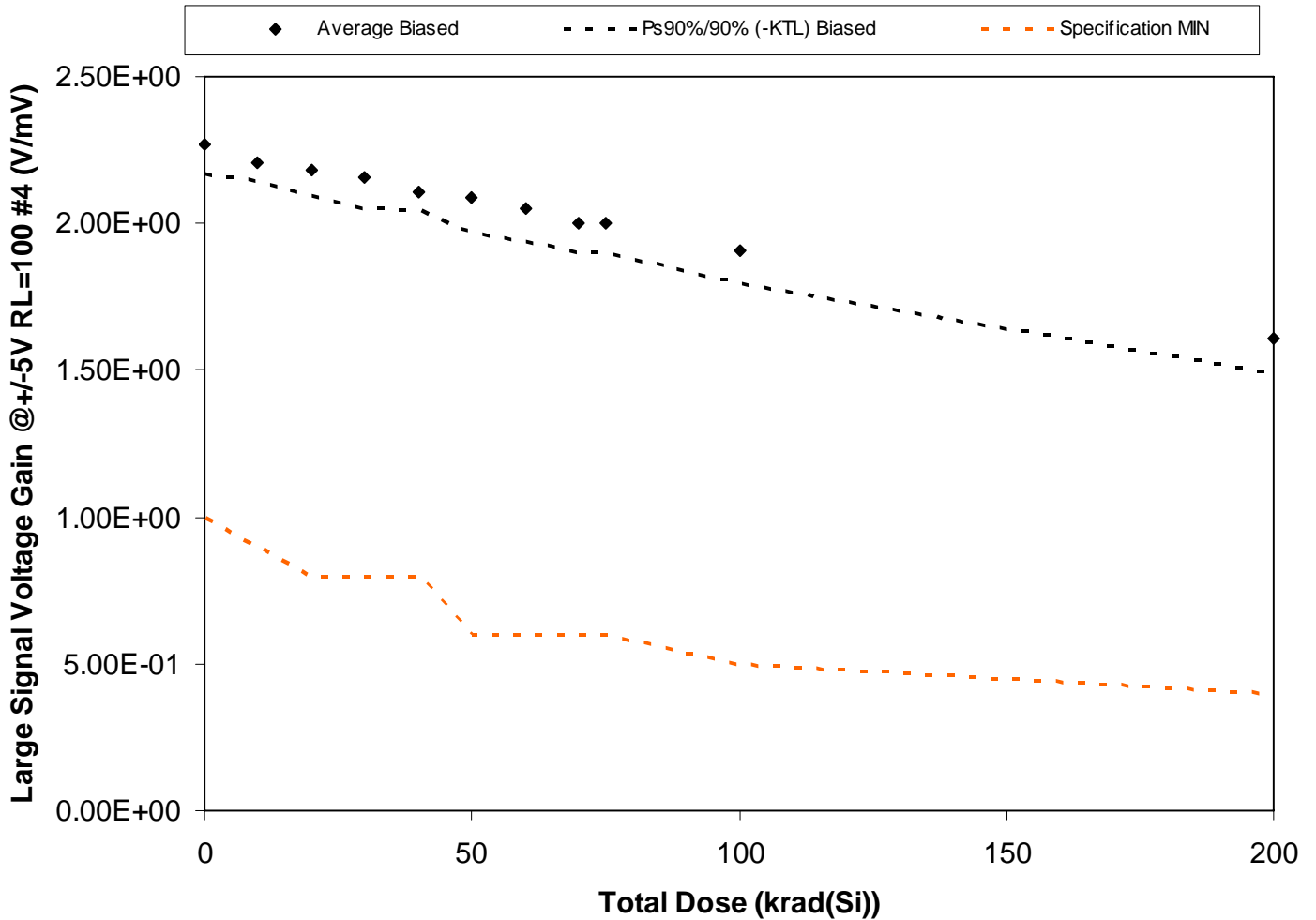

Figure 5.34. Plot of Large Signal Voltage Gain @ +/-5V RL=100 #4 (V/mV) versus total dose. The solid diamonds are the average of the measured data points for the samples irradiated under electrical bias and the black lines (solid and/or dashed) are the average of the data points after application of the KTL statistics on the samples irradiated under electrical bias. The red dotted line(s) are the pre- and/or post-irradiation minimum and/or maximum specification value as defined in the datasheet and/or test plan.



**RLAT Report
10-326 100808 R1.0**

**Radiation Assured Devices
5017 N. 30th Street
Colorado Springs, CO 80919
(719) 531-0800**

Table 5.34. Raw data for Large Signal Voltage Gain @+/-5V RL=100 #4 (V/mV) versus total dose, including the statistical analysis, specification and the status of the testing (pass/fail).

Large Signal Voltage Gain @+/-5V RL=100 #4 (V/mV)	Total Dose (krad(Si))											
	0	10	20	30	40	50	60	70	75	100	200	
Device												
1245	2.30E+00	2.20E+00	2.20E+00	2.20E+00	2.10E+00	2.10E+00	2.10E+00	2.00E+00	2.00E+00	1.90E+00	1.60E+00	
1246	2.20E+00	2.20E+00	2.20E+00	2.10E+00	2.10E+00	2.10E+00	2.00E+00	2.00E+00	2.00E+00	1.90E+00	1.60E+00	
1247	2.30E+00	2.30E+00	2.20E+00	2.20E+00	2.20E+00	2.20E+00	2.10E+00	2.10E+00	2.10E+00	2.00E+00	1.70E+00	
1248	2.20E+00	2.20E+00	2.10E+00	2.10E+00	2.10E+00	2.00E+00	2.00E+00	1.90E+00	1.90E+00	1.80E+00	1.50E+00	
1249	2.30E+00	2.20E+00	2.20E+00	2.20E+00	2.10E+00	2.10E+00	2.10E+00	2.00E+00	2.00E+00	1.90E+00	1.60E+00	
1250	2.30E+00	2.20E+00	2.20E+00	2.20E+00	2.10E+00	2.10E+00	2.10E+00	2.00E+00	2.00E+00	1.90E+00	1.60E+00	
1251	2.30E+00	2.20E+00	2.20E+00	2.20E+00	2.10E+00	2.10E+00	2.10E+00	2.00E+00	2.00E+00	2.00E+00	1.70E+00	
1261	2.30E+00	2.20E+00	2.20E+00	2.10E+00	2.10E+00	2.10E+00	2.00E+00	2.00E+00	2.00E+00	1.90E+00	1.60E+00	
1262	2.20E+00	2.20E+00	2.10E+00	2.10E+00	2.10E+00	2.00E+00	2.00E+00	2.00E+00	2.00E+00	1.90E+00	1.60E+00	
1263	2.30E+00	2.20E+00	2.20E+00	2.20E+00	2.10E+00	2.10E+00	2.00E+00	2.00E+00	2.00E+00	1.90E+00	1.60E+00	
1264	2.30E+00	2.30E+00	2.30E+00	2.30E+00	2.30E+00	2.30E+00	2.30E+00	2.30E+00	2.30E+00	2.30E+00	2.30E+00	
1265	2.20E+00	2.20E+00	2.20E+00	2.20E+00	2.20E+00	2.20E+00	2.20E+00	2.20E+00	2.20E+00	2.20E+00	2.20E+00	
Biased Statistics												
Average Biased	2.27E+00	2.21E+00	2.18E+00	2.16E+00	2.11E+00	2.09E+00	2.05E+00	2.00E+00	2.00E+00	1.91E+00	1.61E+00	
Std Dev Biased	4.83E-02	3.16E-02	4.22E-02	5.16E-02	3.16E-02	5.68E-02	5.27E-02	4.71E-02	4.71E-02	5.68E-02	5.68E-02	
Ps90%/90% (+KTL) Biased	2.37E+00	2.28E+00	2.27E+00	2.27E+00	2.18E+00	2.21E+00	2.16E+00	2.10E+00	2.10E+00	2.03E+00	1.73E+00	
Ps90%/90% (-KTL) Biased	2.17E+00	2.14E+00	2.09E+00	2.05E+00	2.04E+00	1.97E+00	1.94E+00	1.90E+00	1.90E+00	1.79E+00	1.49E+00	
Specification MIN	1.00E+00	9.00E-01	8.00E-01	8.00E-01	8.00E-01	6.00E-01	6.00E-01	6.00E-01	6.00E-01	5.00E-01	4.00E-01	
Status	PASS	PASS	PASS	PASS	PASS	PASS	PASS	PASS	PASS	PASS	PASS	

An ISO 9001:2008 and DSCC Certified Company

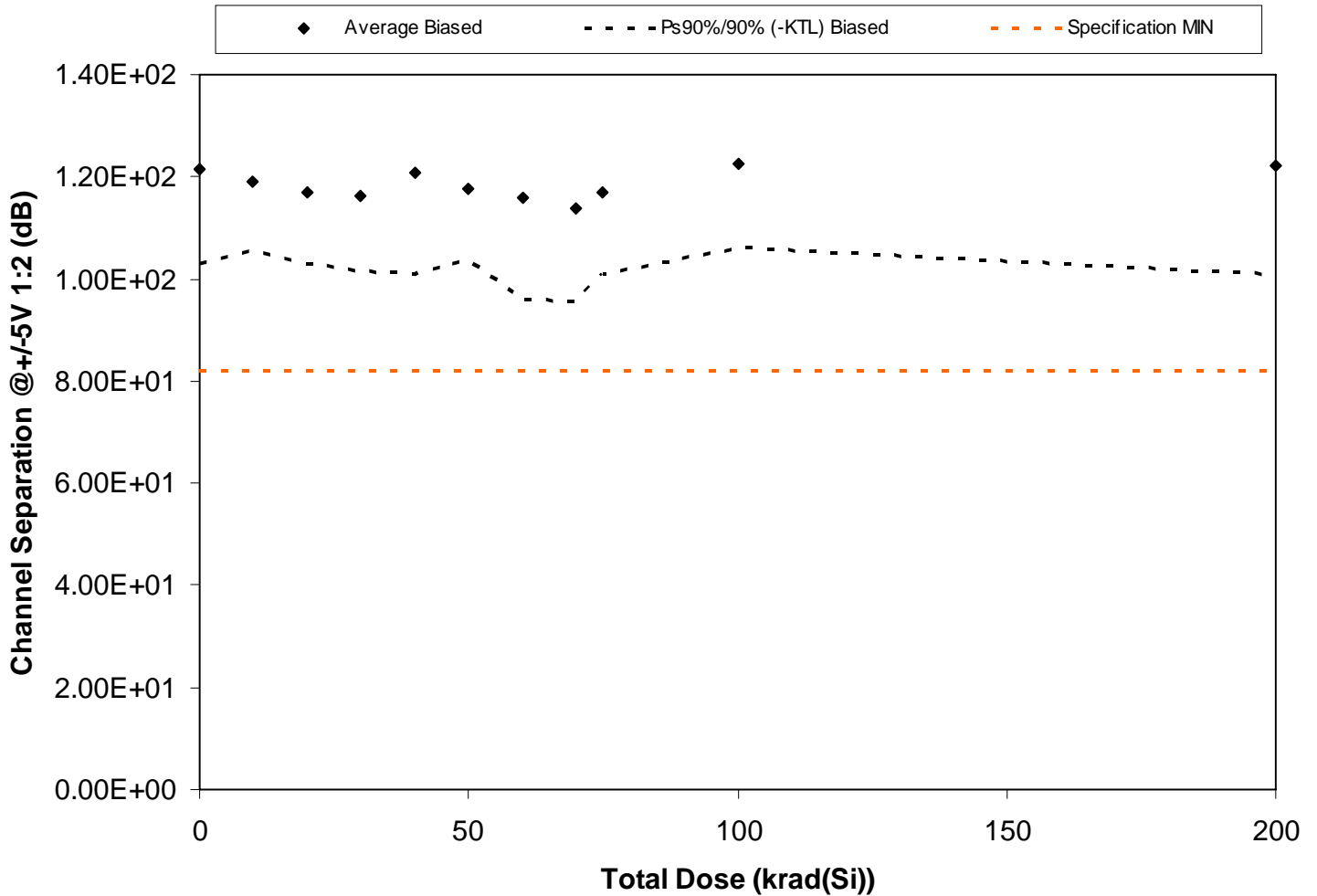

Figure 5.35. Plot of Channel Separation @ +/-5V 1:2 (dB) versus total dose. The solid diamonds are the average of the measured data points for the samples irradiated under electrical bias and the black lines (solid and/or dashed) are the average of the data points after application of the KTL statistics on the samples irradiated under electrical bias. The red dotted line(s) are the pre- and/or post-irradiation minimum and/or maximum specification value as defined in the datasheet and/or test plan.



**RLAT Report
10-326 100808 R1.0**

**Radiation Assured Devices
5017 N. 30th Street
Colorado Springs, CO 80919
(719) 531-0800**

Table 5.35. Raw data for Channel Separation @+/-5V 1:2 (dB) versus total dose, including the statistical analysis, specification and the status of the testing (pass/fail).

Channel Separation @+/-5V 1:2 (dB)	Total Dose (krad(Si))											
	0	10	20	30	40	50	60	70	75	100	200	
Device												
1245	1.32E+02	1.22E+02	1.12E+02	1.24E+02	1.25E+02	1.21E+02	1.11E+02	1.03E+02	1.09E+02	1.22E+02	1.20E+02	
1246	1.22E+02	1.24E+02	1.14E+02	1.13E+02	1.16E+02	1.15E+02	1.13E+02	1.13E+02	1.21E+02	1.16E+02	1.15E+02	
1247	1.13E+02	1.20E+02	1.15E+02	1.13E+02	1.06E+02	1.15E+02	1.09E+02	1.10E+02	1.13E+02	1.22E+02	1.20E+02	
1248	1.29E+02	1.16E+02	1.20E+02	1.06E+02	1.31E+02	1.14E+02	1.18E+02	1.10E+02	1.11E+02	1.30E+02	1.26E+02	
1249	1.24E+02	1.16E+02	1.12E+02	1.21E+02	1.13E+02	1.18E+02	1.39E+02	1.21E+02	1.14E+02	1.40E+02	1.41E+02	
1250	1.30E+02	1.13E+02	1.14E+02	1.22E+02	1.13E+02	1.13E+02	1.15E+02	1.15E+02	1.12E+02	1.26E+02	1.38E+02	
1251	1.32E+02	1.15E+02	1.19E+02	1.21E+02	1.27E+02	1.14E+02	1.06E+02	1.14E+02	1.17E+02	1.16E+02	1.11E+02	
1261	1.16E+02	1.10E+02	1.13E+02	1.24E+02	1.32E+02	1.36E+02	1.12E+02	1.35E+02	1.27E+02	1.23E+02	1.10E+02	
1262	1.08E+02	1.29E+02	1.34E+02	1.06E+02	1.13E+02	1.19E+02	1.11E+02	1.07E+02	1.32E+02	1.13E+02	1.23E+02	
1263	1.12E+02	1.28E+02	1.14E+02	1.12E+02	1.31E+02	1.13E+02	1.25E+02	1.09E+02	1.11E+02	1.16E+02	1.19E+02	
1264	1.16E+02	1.20E+02	1.27E+02	1.09E+02	1.19E+02	1.31E+02	1.15E+02	1.18E+02	1.11E+02	1.14E+02	1.13E+02	
1265	1.14E+02	1.23E+02	1.13E+02	1.14E+02	1.05E+02	1.34E+02	1.10E+02	1.10E+02	1.20E+02	1.27E+02	1.11E+02	
Biased Statistics												
Average Biased	1.22E+02	1.19E+02	1.17E+02	1.16E+02	1.21E+02	1.18E+02	1.16E+02	1.14E+02	1.17E+02	1.22E+02	1.22E+02	
Std Dev Biased	8.98E+00	6.61E+00	6.71E+00	7.09E+00	9.63E+00	6.80E+00	9.63E+00	8.72E+00	7.66E+00	7.95E+00	1.04E+01	
Ps90%/90% (+KTL) Biased	1.40E+02	1.33E+02	1.31E+02	1.31E+02	1.41E+02	1.32E+02	1.36E+02	1.32E+02	1.33E+02	1.39E+02	1.44E+02	
Ps90%/90% (-KTL) Biased	1.03E+02	1.06E+02	1.03E+02	1.02E+02	1.01E+02	1.04E+02	9.59E+01	9.57E+01	1.01E+02	1.06E+02	1.01E+02	
Specification MIN	8.20E+01	8.20E+01	8.20E+01	8.20E+01	8.20E+01	8.20E+01	8.20E+01	8.20E+01	8.20E+01	8.20E+01	8.20E+01	
Status	PASS	PASS	PASS	PASS	PASS	PASS	PASS	PASS	PASS	PASS	PASS	

An ISO 9001:2008 and DSCC Certified Company

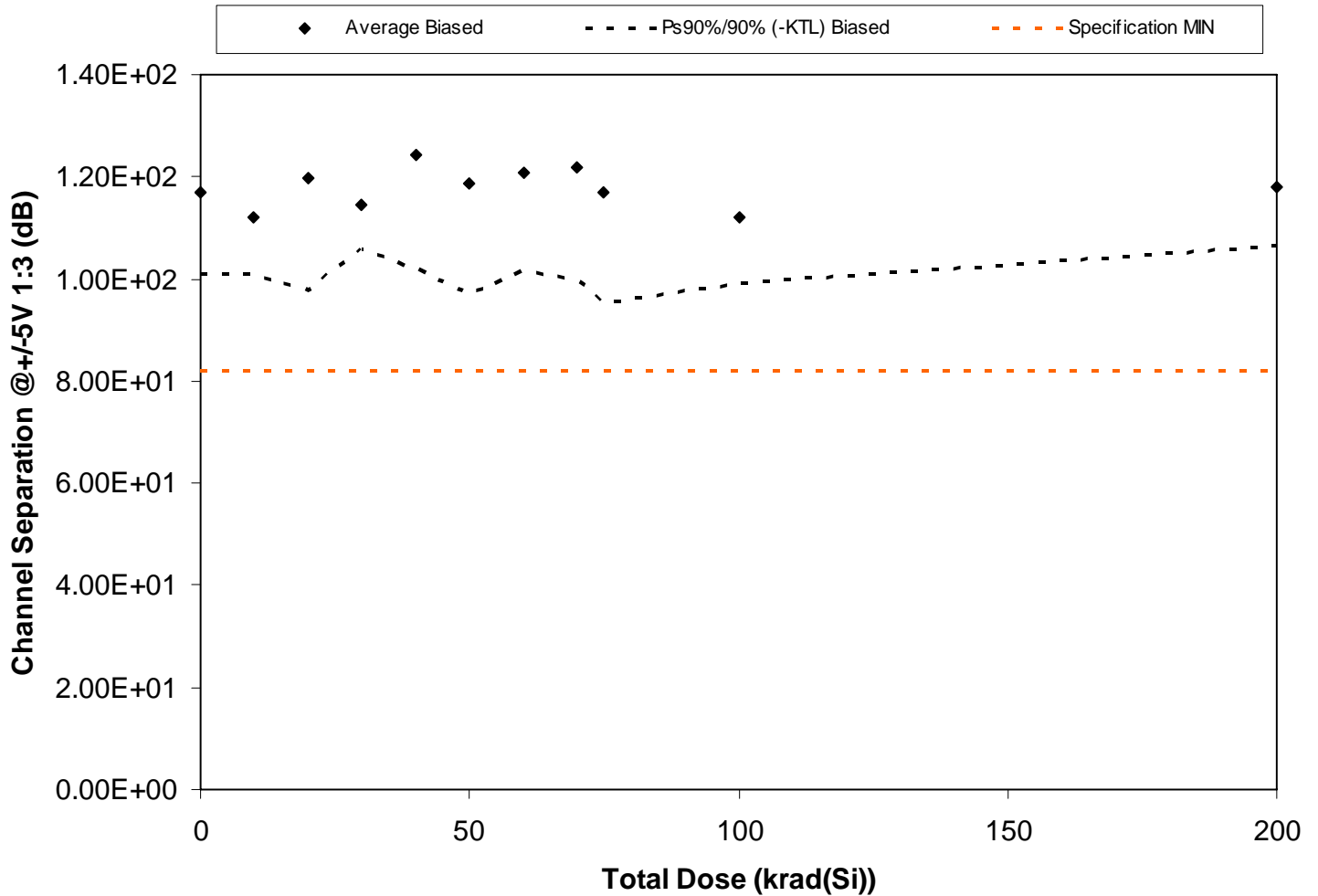

Figure 5.36. Plot of Channel Separation @ +/-5V 1:3 (dB) versus total dose. The solid diamonds are the average of the measured data points for the samples irradiated under electrical bias and the black lines (solid and/or dashed) are the average of the data points after application of the KTL statistics on the samples irradiated under electrical bias. The red dotted line(s) are the pre- and/or post-irradiation minimum and/or maximum specification value as defined in the datasheet and/or test plan.



**RLAT Report
10-326 100808 R1.0**

**Radiation Assured Devices
5017 N. 30th Street
Colorado Springs, CO 80919
(719) 531-0800**

Table 5.36. Raw data for Channel Separation @+/-5V 1:3 (dB) versus total dose, including the statistical analysis, specification and the status of the testing (pass/fail).

Channel Separation @+/-5V 1:3 (dB)	Total Dose (krad(Si))											
	0	10	20	30	40	50	60	70	75	100	200	
Device												
1245	1.18E+02	1.07E+02	1.11E+02	1.19E+02	1.27E+02	1.14E+02	1.37E+02	1.17E+02	1.05E+02	1.11E+02	1.18E+02	
1246	1.29E+02	1.23E+02	1.35E+02	1.14E+02	1.39E+02	1.10E+02	1.15E+02	1.30E+02	1.20E+02	1.07E+02	1.14E+02	
1247	1.18E+02	1.11E+02	1.23E+02	1.06E+02	1.37E+02	1.11E+02	1.36E+02	1.31E+02	1.06E+02	1.11E+02	1.11E+02	
1248	1.09E+02	1.05E+02	1.07E+02	1.14E+02	1.06E+02	1.15E+02	1.22E+02	1.38E+02	1.41E+02	1.08E+02	1.18E+02	
1249	1.15E+02	1.09E+02	1.14E+02	1.18E+02	1.22E+02	1.04E+02	1.23E+02	1.16E+02	1.12E+02	1.08E+02	1.23E+02	
1250	1.31E+02	1.12E+02	1.20E+02	1.19E+02	1.24E+02	1.35E+02	1.11E+02	1.20E+02	1.15E+02	1.10E+02	1.16E+02	
1251	1.08E+02	1.13E+02	1.29E+02	1.17E+02	1.26E+02	1.35E+02	1.20E+02	1.08E+02	1.09E+02	1.18E+02	1.21E+02	
1261	1.13E+02	1.14E+02	1.17E+02	1.13E+02	1.30E+02	1.28E+02	1.19E+02	1.33E+02	1.23E+02	1.14E+02	1.15E+02	
1262	1.14E+02	1.17E+02	1.36E+02	1.09E+02	1.09E+02	1.20E+02	1.10E+02	1.18E+02	1.19E+02	1.28E+02	1.15E+02	
1263	1.12E+02	1.09E+02	1.07E+02	1.14E+02	1.22E+02	1.16E+02	1.15E+02	1.08E+02	1.20E+02	1.08E+02	1.31E+02	
1264	1.18E+02	1.28E+02	1.13E+02	1.15E+02	1.15E+02	1.11E+02	1.16E+02	1.17E+02	1.44E+02	1.13E+02	1.16E+02	
1265	1.11E+02	1.27E+02	1.32E+02	1.13E+02	1.18E+02	1.14E+02	1.20E+02	1.22E+02	1.77E+02	1.22E+02	1.29E+02	
Biased Statistics												
Average Biased	1.17E+02	1.12E+02	1.20E+02	1.14E+02	1.24E+02	1.19E+02	1.21E+02	1.22E+02	1.17E+02	1.12E+02	1.18E+02	
Std Dev Biased	7.74E+00	5.38E+00	1.08E+01	4.19E+00	1.07E+01	1.06E+01	9.26E+00	1.06E+01	1.05E+01	6.41E+00	5.65E+00	
Ps90%/90% (+KTL) Biased	1.33E+02	1.23E+02	1.42E+02	1.23E+02	1.46E+02	1.41E+02	1.40E+02	1.44E+02	1.39E+02	1.25E+02	1.30E+02	
Ps90%/90% (-KTL) Biased	1.01E+02	1.01E+02	9.76E+01	1.06E+02	1.02E+02	9.69E+01	1.02E+02	1.00E+02	9.53E+01	9.90E+01	1.07E+02	
Specification MIN	8.20E+01	8.20E+01	8.20E+01	8.20E+01	8.20E+01	8.20E+01	8.20E+01	8.20E+01	8.20E+01	8.20E+01	8.20E+01	
Status	PASS	PASS	PASS	PASS	PASS	PASS	PASS	PASS	PASS	PASS	PASS	

An ISO 9001:2008 and DSCC Certified Company

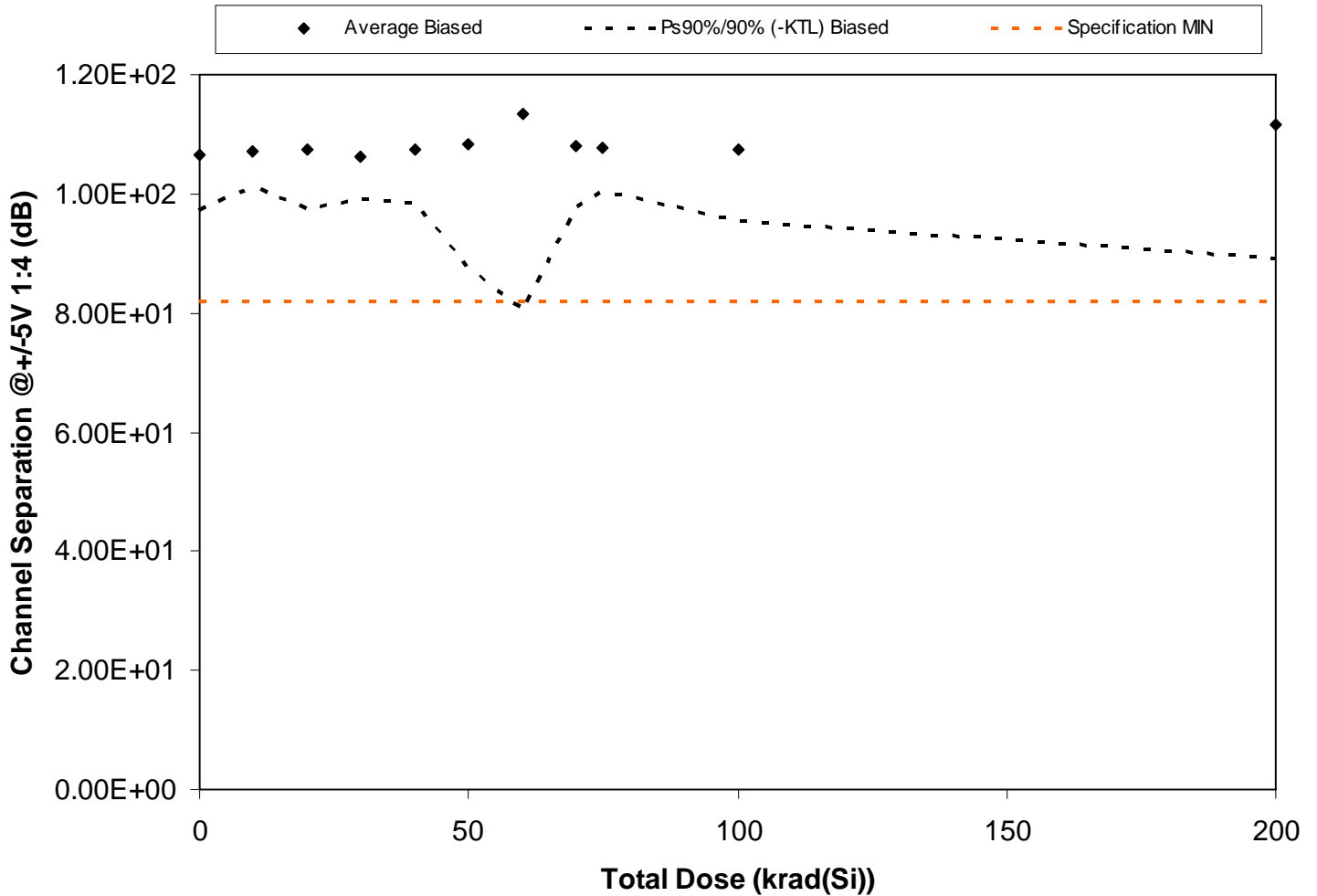

Figure 5.37. Plot of Channel Separation @ +/-5V 1:4 (dB) versus total dose. The solid diamonds are the average of the measured data points for the samples irradiated under electrical bias and the black lines (solid and/or dashed) are the average of the data points after application of the KTL statistics on the samples irradiated under electrical bias. The red dotted line(s) are the pre- and/or post-irradiation minimum and/or maximum specification value as defined in the datasheet and/or test plan.



**RLAT Report
10-326 100808 R1.0**

**Radiation Assured Devices
5017 N. 30th Street
Colorado Springs, CO 80919
(719) 531-0800**

Table 5.37. Raw data for Channel Separation @+/-5V 1:4 (dB) versus total dose, including the statistical analysis, specification and the status of the testing (pass/fail).

Channel Separation @+/-5V 1:4 (dB)	Total Dose (krad(Si))											
	0	10	20	30	40	50	60	70	75	100	200	
Device												
1245	1.14E+02	1.12E+02	1.04E+02	1.03E+02	1.08E+02	1.08E+02	1.57E+02	1.05E+02	1.14E+02	1.07E+02	1.15E+02	
1246	1.01E+02	1.07E+02	1.07E+02	1.06E+02	1.11E+02	1.00E+02	1.07E+02	1.06E+02	1.11E+02	1.03E+02	1.06E+02	
1247	1.03E+02	1.02E+02	1.07E+02	1.09E+02	1.06E+02	1.01E+02	1.06E+02	1.01E+02	1.09E+02	1.06E+02	1.00E+02	
1248	1.07E+02	1.06E+02	1.12E+02	1.07E+02	1.16E+02	1.28E+02	1.04E+02	1.07E+02	1.05E+02	1.22E+02	1.09E+02	
1249	1.06E+02	1.09E+02	1.03E+02	1.03E+02	1.04E+02	1.05E+02	1.06E+02	1.08E+02	1.02E+02	1.08E+02	1.05E+02	
1250	1.02E+02	1.07E+02	1.04E+02	1.01E+02	1.01E+02	1.00E+02	1.16E+02	1.10E+02	1.07E+02	1.05E+02	1.03E+02	
1251	1.04E+02	1.04E+02	1.16E+02	1.08E+02	1.04E+02	1.03E+02	1.10E+02	1.18E+02	1.05E+02	1.03E+02	1.35E+02	
1261	1.14E+02	1.09E+02	1.13E+02	1.11E+02	1.10E+02	1.25E+02	1.06E+02	1.03E+02	1.05E+02	1.11E+02	1.14E+02	
1262	1.07E+02	1.10E+02	1.02E+02	1.12E+02	1.06E+02	1.12E+02	1.14E+02	1.14E+02	1.10E+02	1.02E+02	1.04E+02	
1263	1.10E+02	1.07E+02	1.06E+02	1.04E+02	1.09E+02	1.03E+02	1.10E+02	1.09E+02	1.11E+02	1.07E+02	1.24E+02	
1264	1.03E+02	1.03E+02	1.05E+02	1.11E+02	1.08E+02	1.07E+02	1.12E+02	1.03E+02	1.05E+02	1.03E+02	1.02E+02	
1265	1.02E+02	1.05E+02	1.01E+02	1.06E+02	1.01E+02	1.04E+02	1.06E+02	1.07E+02	1.12E+02	1.02E+02	1.02E+02	
Biased Statistics												
Average Biased	1.07E+02	1.07E+02	1.08E+02	1.06E+02	1.07E+02	1.08E+02	1.14E+02	1.08E+02	1.08E+02	1.07E+02	1.12E+02	
Std Dev Biased	4.60E+00	2.88E+00	4.79E+00	3.52E+00	4.35E+00	1.01E+01	1.59E+01	5.08E+00	3.58E+00	5.78E+00	1.08E+01	
Ps90%/90% (+KTL) Biased	1.16E+02	1.13E+02	1.17E+02	1.14E+02	1.16E+02	1.29E+02	1.46E+02	1.19E+02	1.15E+02	1.19E+02	1.34E+02	
Ps90%/90% (-KTL) Biased	9.72E+01	1.01E+02	9.77E+01	9.91E+01	9.85E+01	8.75E+01	8.06E+01	9.77E+01	1.00E+02	9.54E+01	8.91E+01	
Specification MIN	8.20E+01	8.20E+01	8.20E+01	8.20E+01	8.20E+01	8.20E+01	8.20E+01	8.20E+01	8.20E+01	8.20E+01	8.20E+01	
Status	PASS	PASS	PASS	PASS	PASS	PASS	PASS	PASS	PASS	PASS	PASS	

An ISO 9001:2008 and DSCC Certified Company

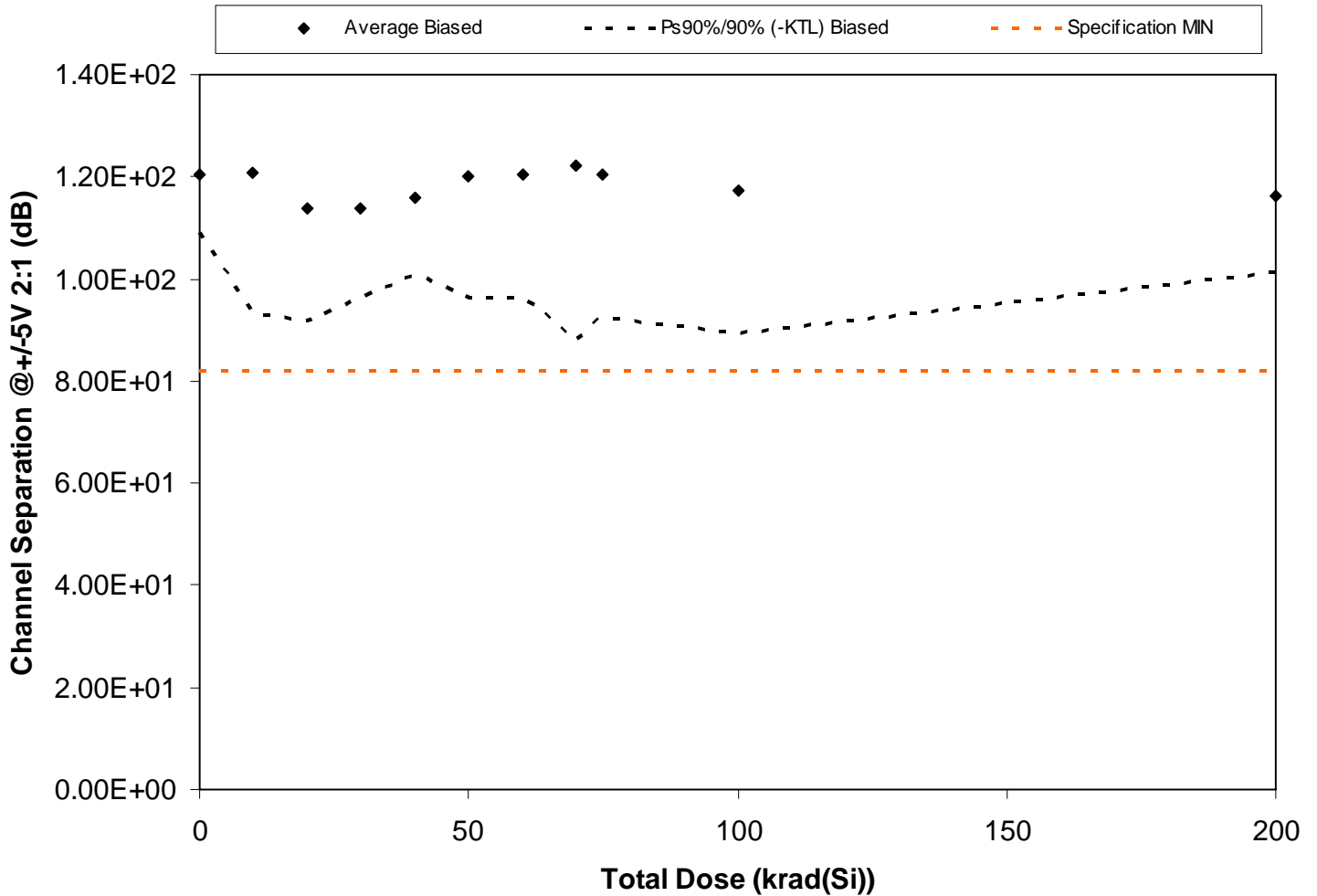

Figure 5.38. Plot of Channel Separation @ +/-5V 2:1 (dB) versus total dose. The solid diamonds are the average of the measured data points for the samples irradiated under electrical bias and the black lines (solid and/or dashed) are the average of the data points after application of the KTL statistics on the samples irradiated under electrical bias. The red dotted line(s) are the pre- and/or post-irradiation minimum and/or maximum specification value as defined in the datasheet and/or test plan.



**RLAT Report
10-326 100808 R1.0**

**Radiation Assured Devices
5017 N. 30th Street
Colorado Springs, CO 80919
(719) 531-0800**

Table 5.38. Raw data for Channel Separation @+/-5V 2:1 (dB) versus total dose, including the statistical analysis, specification and the status of the testing (pass/fail).

Channel Separation @+/-5V 2:1 (dB)	Total Dose (krad(Si))											
	0	10	20	30	40	50	60	70	75	100	200	
Device												
1245	1.27E+02	1.18E+02	1.07E+02	1.20E+02	1.17E+02	1.07E+02	1.19E+02	1.04E+02	1.17E+02	1.51E+02	1.10E+02	
1246	1.26E+02	1.27E+02	1.10E+02	1.13E+02	1.11E+02	1.20E+02	1.16E+02	1.49E+02	1.11E+02	1.19E+02	1.32E+02	
1247	1.15E+02	1.19E+02	1.03E+02	1.16E+02	1.07E+02	1.20E+02	1.20E+02	1.34E+02	1.10E+02	1.13E+02	1.09E+02	
1248	1.20E+02	1.23E+02	1.05E+02	1.35E+02	1.15E+02	1.22E+02	1.09E+02	1.21E+02	1.19E+02	1.14E+02	1.19E+02	
1249	1.25E+02	1.30E+02	1.13E+02	1.05E+02	1.19E+02	1.12E+02	1.25E+02	1.18E+02	1.19E+02	1.10E+02	1.11E+02	
1250	1.11E+02	1.11E+02	1.17E+02	1.09E+02	1.06E+02	1.31E+02	1.45E+02	1.14E+02	1.08E+02	1.05E+02	1.20E+02	
1251	1.25E+02	1.06E+02	1.41E+02	1.12E+02	1.20E+02	1.07E+02	1.08E+02	1.49E+02	1.17E+02	1.25E+02	1.16E+02	
1261	1.13E+02	1.07E+02	1.13E+02	1.10E+02	1.31E+02	1.13E+02	1.08E+02	1.13E+02	1.16E+02	1.20E+02	1.13E+02	
1262	1.22E+02	1.52E+02	1.19E+02	1.08E+02	1.18E+02	1.27E+02	1.30E+02	1.08E+02	1.54E+02	1.01E+02	1.22E+02	
1263	1.22E+02	1.17E+02	1.11E+02	1.09E+02	1.14E+02	1.44E+02	1.26E+02	1.10E+02	1.31E+02	1.16E+02	1.10E+02	
1264	1.23E+02	1.07E+02	1.11E+02	1.14E+02	1.24E+02	1.08E+02	1.05E+02	1.14E+02	1.08E+02	1.11E+02	1.08E+02	
1265	1.16E+02	1.44E+02	1.10E+02	1.21E+02	1.08E+02	1.05E+02	1.12E+02	1.17E+02	1.31E+02	1.22E+02	1.11E+02	
Biased Statistics												
Average Biased	1.21E+02	1.21E+02	1.14E+02	1.14E+02	1.16E+02	1.20E+02	1.20E+02	1.22E+02	1.20E+02	1.17E+02	1.16E+02	
Std Dev Biased	5.57E+00	1.34E+01	1.06E+01	8.41E+00	7.24E+00	1.16E+01	1.17E+01	1.65E+01	1.34E+01	1.36E+01	7.22E+00	
Ps90%/90% (+KTL) Biased	1.32E+02	1.48E+02	1.36E+02	1.31E+02	1.31E+02	1.44E+02	1.45E+02	1.56E+02	1.48E+02	1.46E+02	1.31E+02	
Ps90%/90% (-KTL) Biased	1.09E+02	9.32E+01	9.19E+01	9.63E+01	1.01E+02	9.62E+01	9.62E+01	8.79E+01	9.26E+01	8.92E+01	1.01E+02	
Specification MIN	8.20E+01	8.20E+01	8.20E+01	8.20E+01	8.20E+01	8.20E+01	8.20E+01	8.20E+01	8.20E+01	8.20E+01	8.20E+01	
Status	PASS	PASS	PASS	PASS	PASS	PASS	PASS	PASS	PASS	PASS	PASS	

An ISO 9001:2008 and DSCC Certified Company

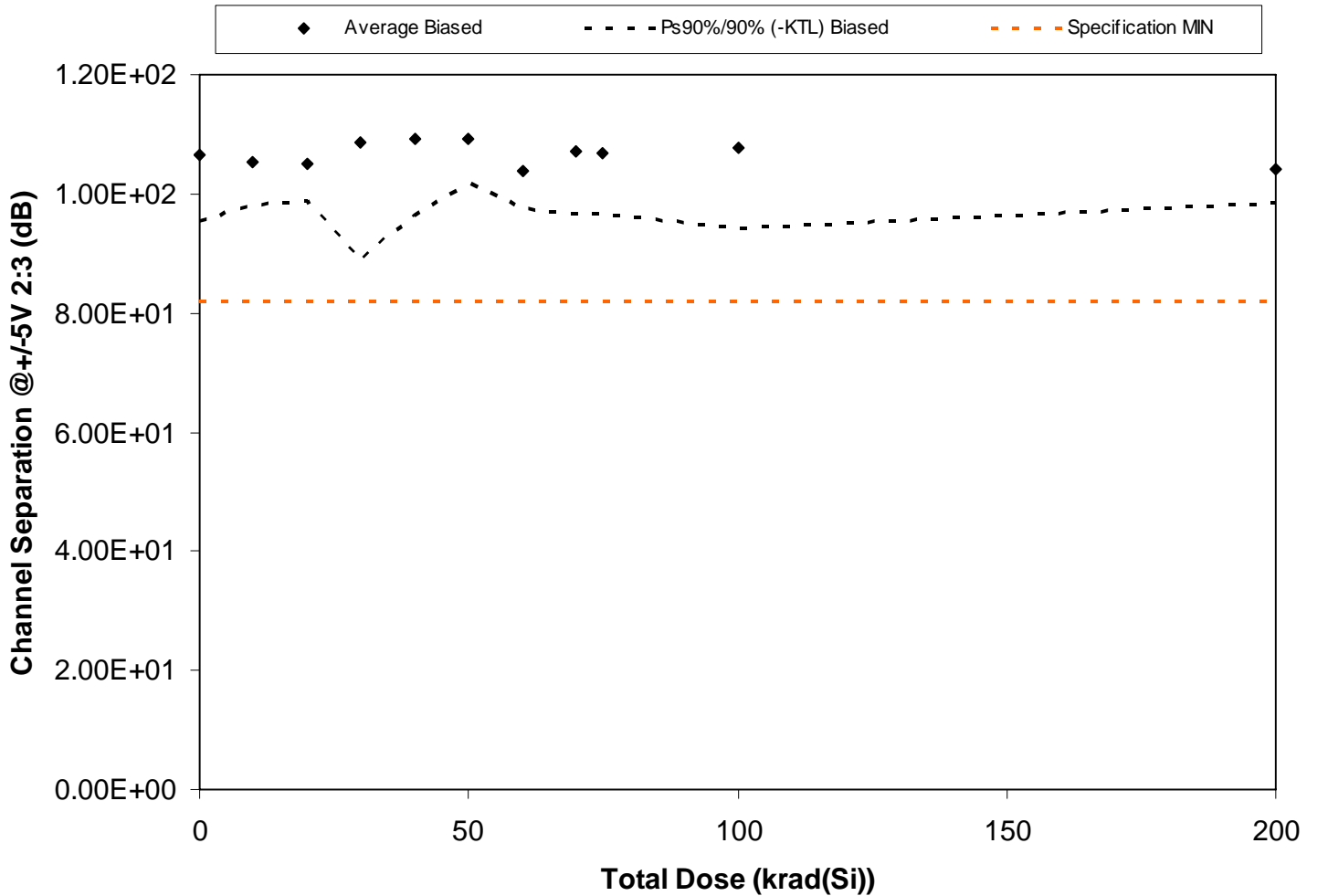

Figure 5.39. Plot of Channel Separation @ +/-5V 2:3 (dB) versus total dose. The solid diamonds are the average of the measured data points for the samples irradiated under electrical bias and the black lines (solid and/or dashed) are the average of the data points after application of the KTL statistics on the samples irradiated under electrical bias. The red dotted line(s) are the pre- and/or post-irradiation minimum and/or maximum specification value as defined in the datasheet and/or test plan.



**RLAT Report
10-326 100808 R1.0**

**Radiation Assured Devices
5017 N. 30th Street
Colorado Springs, CO 80919
(719) 531-0800**

Table 5.39. Raw data for Channel Separation @ $\pm 5V$ 2:3 (dB) versus total dose, including the statistical analysis, specification and the status of the testing (pass/fail).

Channel Separation @ $\pm 5V$ 2:3 (dB)	Total Dose (krad(Si))											
	0	10	20	30	40	50	60	70	75	100	200	
Device												
1245	1.01E+02	1.08E+02	1.02E+02	1.06E+02	1.06E+02	1.11E+02	1.10E+02	1.05E+02	1.05E+02	1.06E+02	1.02E+02	
1246	1.16E+02	1.03E+02	1.11E+02	1.33E+02	1.23E+02	1.07E+02	1.05E+02	1.06E+02	1.04E+02	1.10E+02	1.09E+02	
1247	1.07E+02	1.07E+02	1.05E+02	1.05E+02	1.08E+02	1.11E+02	1.02E+02	1.20E+02	1.05E+02	1.05E+02	1.06E+02	
1248	1.07E+02	1.03E+02	1.04E+02	1.02E+02	1.04E+02	1.15E+02	1.04E+02	1.07E+02	1.12E+02	1.24E+02	1.05E+02	
1249	1.16E+02	1.05E+02	1.07E+02	1.09E+02	1.10E+02	1.07E+02	9.95E+01	1.03E+02	1.15E+02	1.09E+02	1.06E+02	
1250	1.03E+02	1.06E+02	1.10E+02	1.05E+02	1.06E+02	1.05E+02	1.01E+02	1.08E+02	1.01E+02	1.09E+02	1.03E+02	
1251	1.01E+02	1.06E+02	1.03E+02	1.03E+02	1.06E+02	1.08E+02	1.07E+02	1.10E+02	1.14E+02	1.01E+02	1.02E+02	
1261	1.05E+02	1.14E+02	1.04E+02	1.16E+02	1.17E+02	1.07E+02	1.05E+02	1.03E+02	1.08E+02	1.05E+02	1.08E+02	
1262	1.05E+02	1.01E+02	1.02E+02	1.03E+02	1.04E+02	1.16E+02	1.04E+02	1.05E+02	1.05E+02	1.06E+02	1.00E+02	
1263	1.04E+02	1.02E+02	1.03E+02	1.04E+02	1.07E+02	1.06E+02	1.01E+02	1.04E+02	1.02E+02	1.02E+02	1.02E+02	
1264	1.16E+02	1.02E+02	1.06E+02	1.03E+02	1.04E+02	1.16E+02	1.02E+02	1.08E+02	1.07E+02	1.07E+02	1.08E+02	
1265	1.07E+02	1.02E+02	1.07E+02	1.06E+02	1.01E+02	1.14E+02	1.05E+02	1.03E+02	1.29E+02	9.99E+01	1.07E+02	
Biased Statistics												
Average Biased	1.07E+02	1.05E+02	1.05E+02	1.08E+02	1.09E+02	1.09E+02	1.04E+02	1.07E+02	1.07E+02	1.08E+02	1.04E+02	
Std Dev Biased	5.29E+00	3.60E+00	3.02E+00	9.56E+00	6.25E+00	3.67E+00	3.13E+00	5.00E+00	5.00E+00	6.57E+00	2.78E+00	
Ps90%/90% (+KTL) Biased	1.17E+02	1.13E+02	1.11E+02	1.28E+02	1.22E+02	1.17E+02	1.10E+02	1.17E+02	1.17E+02	1.21E+02	1.10E+02	
Ps90%/90% (-KTL) Biased	9.56E+01	9.80E+01	9.89E+01	8.87E+01	9.65E+01	1.02E+02	9.74E+01	9.68E+01	9.66E+01	9.42E+01	9.85E+01	
Specification MIN	8.20E+01	8.20E+01	8.20E+01	8.20E+01	8.20E+01	8.20E+01	8.20E+01	8.20E+01	8.20E+01	8.20E+01	8.20E+01	
Status	PASS	PASS	PASS	PASS	PASS	PASS	PASS	PASS	PASS	PASS	PASS	

An ISO 9001:2008 and DSCC Certified Company

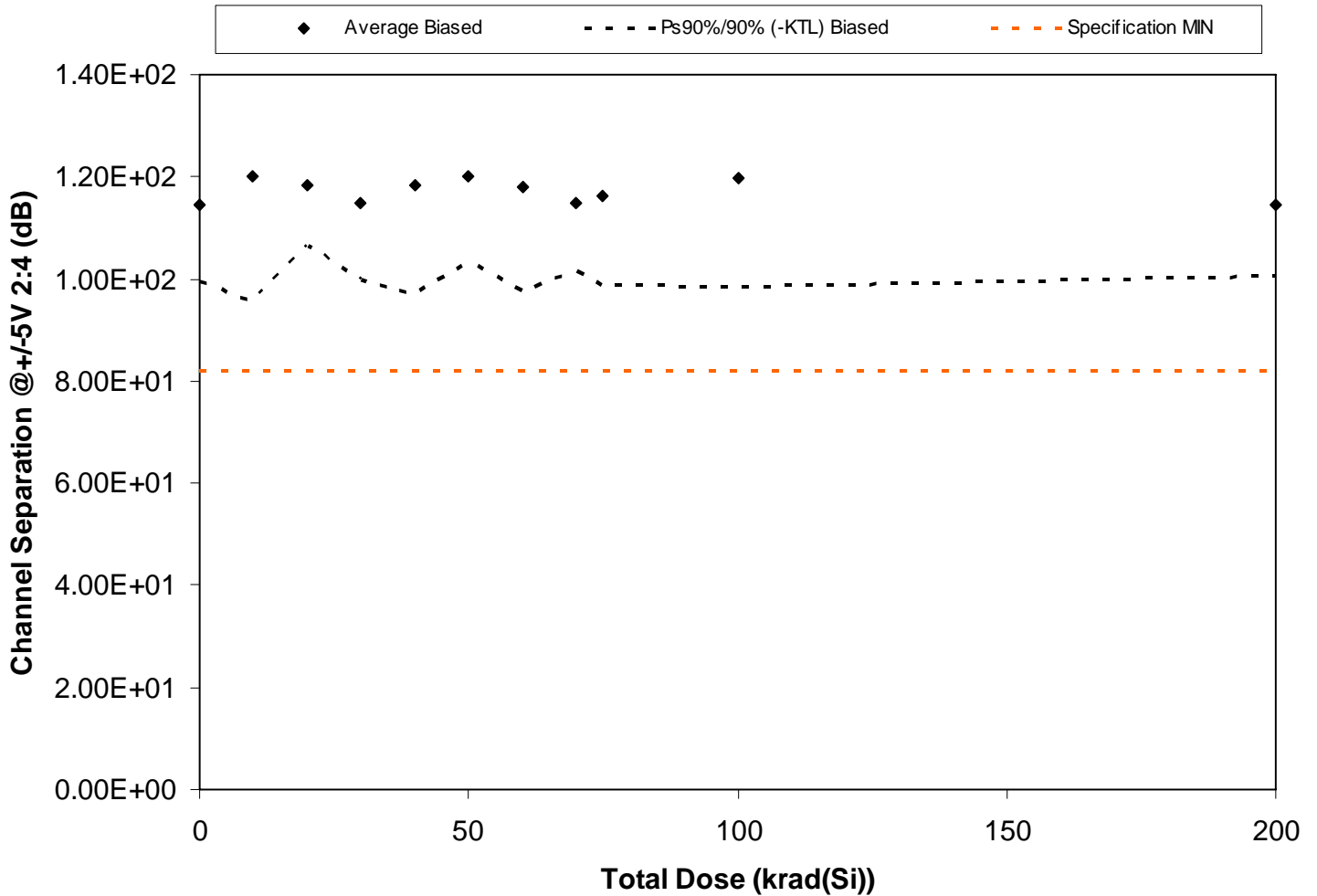

Figure 5.40. Plot of Channel Separation @ +/-5V 2:4 (dB) versus total dose. The solid diamonds are the average of the measured data points for the samples irradiated under electrical bias and the black lines (solid and/or dashed) are the average of the data points after application of the KTL statistics on the samples irradiated under electrical bias. The red dotted line(s) are the pre- and/or post-irradiation minimum and/or maximum specification value as defined in the datasheet and/or test plan.



**RLAT Report
10-326 100808 R1.0**

**Radiation Assured Devices
5017 N. 30th Street
Colorado Springs, CO 80919
(719) 531-0800**

Table 5.40. Raw data for Channel Separation @+/-5V 2:4 (dB) versus total dose, including the statistical analysis, specification and the status of the testing (pass/fail).

Channel Separation @+/-5V 2:4 (dB)	Total Dose (krad(Si))											
	0	10	20	30	40	50	60	70	75	100	200	
Device												
1245	1.10E+02	1.12E+02	1.17E+02	1.10E+02	1.23E+02	1.18E+02	1.12E+02	1.14E+02	1.14E+02	1.17E+02	1.21E+02	
1246	1.14E+02	1.12E+02	1.25E+02	1.16E+02	1.39E+02	1.23E+02	1.25E+02	1.14E+02	1.13E+02	1.09E+02	1.10E+02	
1247	1.14E+02	1.19E+02	1.24E+02	1.15E+02	1.30E+02	1.17E+02	1.09E+02	1.10E+02	1.14E+02	1.39E+02	1.11E+02	
1248	1.13E+02	1.12E+02	1.11E+02	1.08E+02	1.22E+02	1.17E+02	1.08E+02	1.27E+02	1.22E+02	1.23E+02	1.09E+02	
1249	1.11E+02	1.39E+02	1.26E+02	1.09E+02	1.07E+02	1.28E+02	1.23E+02	1.15E+02	1.09E+02	1.32E+02	1.07E+02	
1250	1.13E+02	1.28E+02	1.18E+02	1.25E+02	1.18E+02	1.14E+02	1.18E+02	1.11E+02	1.36E+02	1.19E+02	1.27E+02	
1251	1.27E+02	1.15E+02	1.21E+02	1.22E+02	1.14E+02	1.31E+02	1.09E+02	1.25E+02	1.25E+02	1.25E+02	1.16E+02	
1261	1.14E+02	1.40E+02	1.14E+02	1.27E+02	1.10E+02	1.13E+02	1.18E+02	1.08E+02	1.10E+02	1.14E+02	1.23E+02	
1262	1.27E+02	1.15E+02	1.10E+02	1.13E+02	1.08E+02	1.09E+02	1.40E+02	1.09E+02	1.10E+02	1.14E+02	1.08E+02	
1263	1.04E+02	1.07E+02	1.17E+02	1.05E+02	1.11E+02	1.33E+02	1.18E+02	1.18E+02	1.11E+02	1.05E+02	1.14E+02	
1264	1.17E+02	1.13E+02	1.16E+02	1.12E+02	1.31E+02	1.04E+02	1.20E+02	1.09E+02	1.13E+02	1.20E+02	1.15E+02	
1265	1.22E+02	1.18E+02	1.08E+02	1.30E+02	1.13E+02	1.25E+02	1.07E+02	1.27E+02	1.31E+02	1.12E+02	1.07E+02	
Biased Statistics												
Average Biased	1.15E+02	1.20E+02	1.18E+02	1.15E+02	1.18E+02	1.20E+02	1.18E+02	1.15E+02	1.16E+02	1.20E+02	1.14E+02	
Std Dev Biased	7.30E+00	1.18E+01	5.73E+00	7.31E+00	1.03E+01	8.16E+00	9.79E+00	6.49E+00	8.60E+00	1.03E+01	6.77E+00	
Ps90%/90% (+KTL) Biased	1.30E+02	1.44E+02	1.30E+02	1.30E+02	1.40E+02	1.37E+02	1.38E+02	1.28E+02	1.34E+02	1.41E+02	1.28E+02	
Ps90%/90% (-KTL) Biased	9.95E+01	9.56E+01	1.07E+02	9.98E+01	9.70E+01	1.03E+02	9.77E+01	1.02E+02	9.86E+01	9.83E+01	1.00E+02	
Specification MIN	8.20E+01	8.20E+01	8.20E+01	8.20E+01	8.20E+01	8.20E+01	8.20E+01	8.20E+01	8.20E+01	8.20E+01	8.20E+01	
Status	PASS	PASS	PASS	PASS	PASS	PASS	PASS	PASS	PASS	PASS	PASS	

An ISO 9001:2008 and DSCC Certified Company

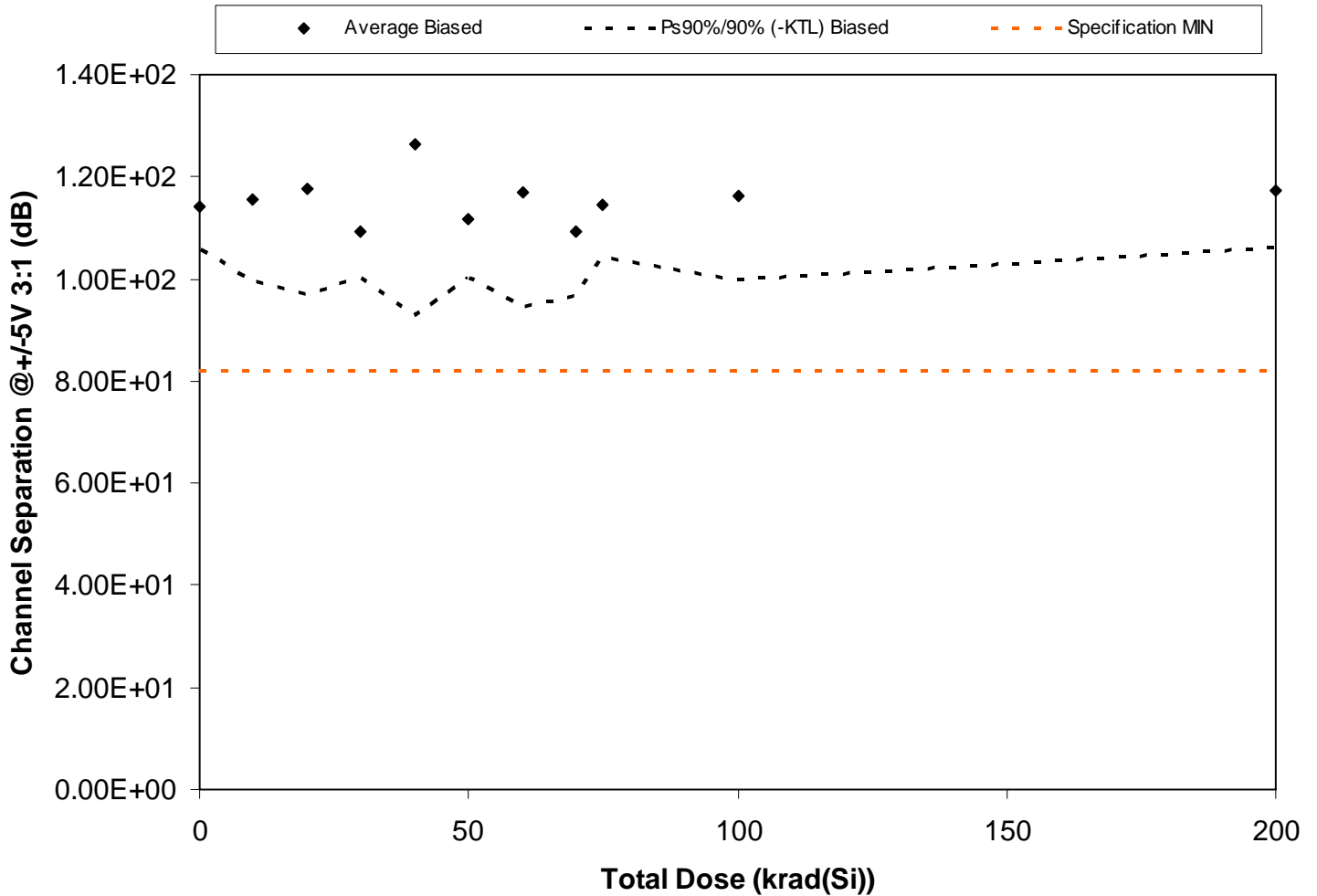

Figure 5.41. Plot of Channel Separation @ +/-5V 3:1 (dB) versus total dose. The solid diamonds are the average of the measured data points for the samples irradiated under electrical bias and the black lines (solid and/or dashed) are the average of the data points after application of the KTL statistics on the samples irradiated under electrical bias. The red dotted line(s) are the pre- and/or post-irradiation minimum and/or maximum specification value as defined in the datasheet and/or test plan.



**RLAT Report
10-326 100808 R1.0**

**Radiation Assured Devices
5017 N. 30th Street
Colorado Springs, CO 80919
(719) 531-0800**

Table 5.41. Raw data for Channel Separation @+/-5V 3:1 (dB) versus total dose, including the statistical analysis, specification and the status of the testing (pass/fail).

Channel Separation @+/-5V 3:1 (dB)	Total Dose (krad(Si))											
	0	10	20	30	40	50	60	70	75	100	200	
Device												
1245	1.08E+02	1.09E+02	1.17E+02	1.07E+02	1.26E+02	1.20E+02	1.43E+02	1.09E+02	1.09E+02	1.19E+02	1.27E+02	
1246	1.15E+02	1.11E+02	1.19E+02	1.03E+02	1.10E+02	1.12E+02	1.12E+02	1.02E+02	1.17E+02	1.22E+02	1.13E+02	
1247	1.13E+02	1.31E+02	1.17E+02	1.13E+02	1.56E+02	1.07E+02	1.14E+02	1.20E+02	1.11E+02	1.16E+02	1.14E+02	
1248	1.18E+02	1.24E+02	1.08E+02	1.09E+02	1.13E+02	1.20E+02	1.09E+02	1.15E+02	1.12E+02	1.06E+02	1.18E+02	
1249	1.17E+02	1.12E+02	1.10E+02	1.07E+02	1.14E+02	1.15E+02	1.23E+02	1.02E+02	1.27E+02	1.18E+02	1.22E+02	
1250	1.18E+02	1.10E+02	1.09E+02	1.11E+02	1.42E+02	1.14E+02	1.14E+02	1.09E+02	1.11E+02	1.34E+02	1.16E+02	
1251	1.21E+02	1.09E+02	1.24E+02	1.16E+02	1.32E+02	1.05E+02	1.04E+02	1.08E+02	1.14E+02	1.16E+02	1.11E+02	
1261	1.10E+02	1.17E+02	1.06E+02	1.04E+02	1.39E+02	1.09E+02	1.24E+02	1.08E+02	1.16E+02	1.11E+02	1.23E+02	
1262	1.12E+02	1.09E+02	1.32E+02	1.08E+02	1.05E+02	1.11E+02	1.14E+02	1.04E+02	1.16E+02	1.13E+02	1.19E+02	
1263	1.10E+02	1.23E+02	1.34E+02	1.14E+02	1.27E+02	1.04E+02	1.13E+02	1.15E+02	1.14E+02	1.08E+02	1.11E+02	
1264	1.16E+02	1.22E+02	1.10E+02	1.16E+02	1.69E+02	1.15E+02	1.05E+02	1.10E+02	1.09E+02	1.16E+02	1.11E+02	
1265	1.17E+02	1.29E+02	1.07E+02	1.17E+02	1.20E+02	1.17E+02	1.19E+02	1.10E+02	1.05E+02	1.08E+02	1.10E+02	
Biased Statistics												
Average Biased	1.14E+02	1.15E+02	1.17E+02	1.09E+02	1.26E+02	1.12E+02	1.17E+02	1.09E+02	1.15E+02	1.16E+02	1.17E+02	
Std Dev Biased	4.11E+00	7.77E+00	9.94E+00	4.39E+00	1.62E+01	5.51E+00	1.09E+01	5.99E+00	4.98E+00	7.88E+00	5.32E+00	
Ps90%/90% (+KTL) Biased	1.23E+02	1.32E+02	1.38E+02	1.18E+02	1.60E+02	1.23E+02	1.39E+02	1.21E+02	1.25E+02	1.33E+02	1.28E+02	
Ps90%/90% (-KTL) Biased	1.06E+02	9.94E+01	9.70E+01	1.00E+02	9.29E+01	1.00E+02	9.44E+01	9.68E+01	1.04E+02	1.00E+02	1.06E+02	
Specification MIN	8.20E+01	8.20E+01	8.20E+01	8.20E+01	8.20E+01	8.20E+01	8.20E+01	8.20E+01	8.20E+01	8.20E+01	8.20E+01	
Status	PASS	PASS	PASS	PASS	PASS	PASS	PASS	PASS	PASS	PASS	PASS	

An ISO 9001:2008 and DSCC Certified Company

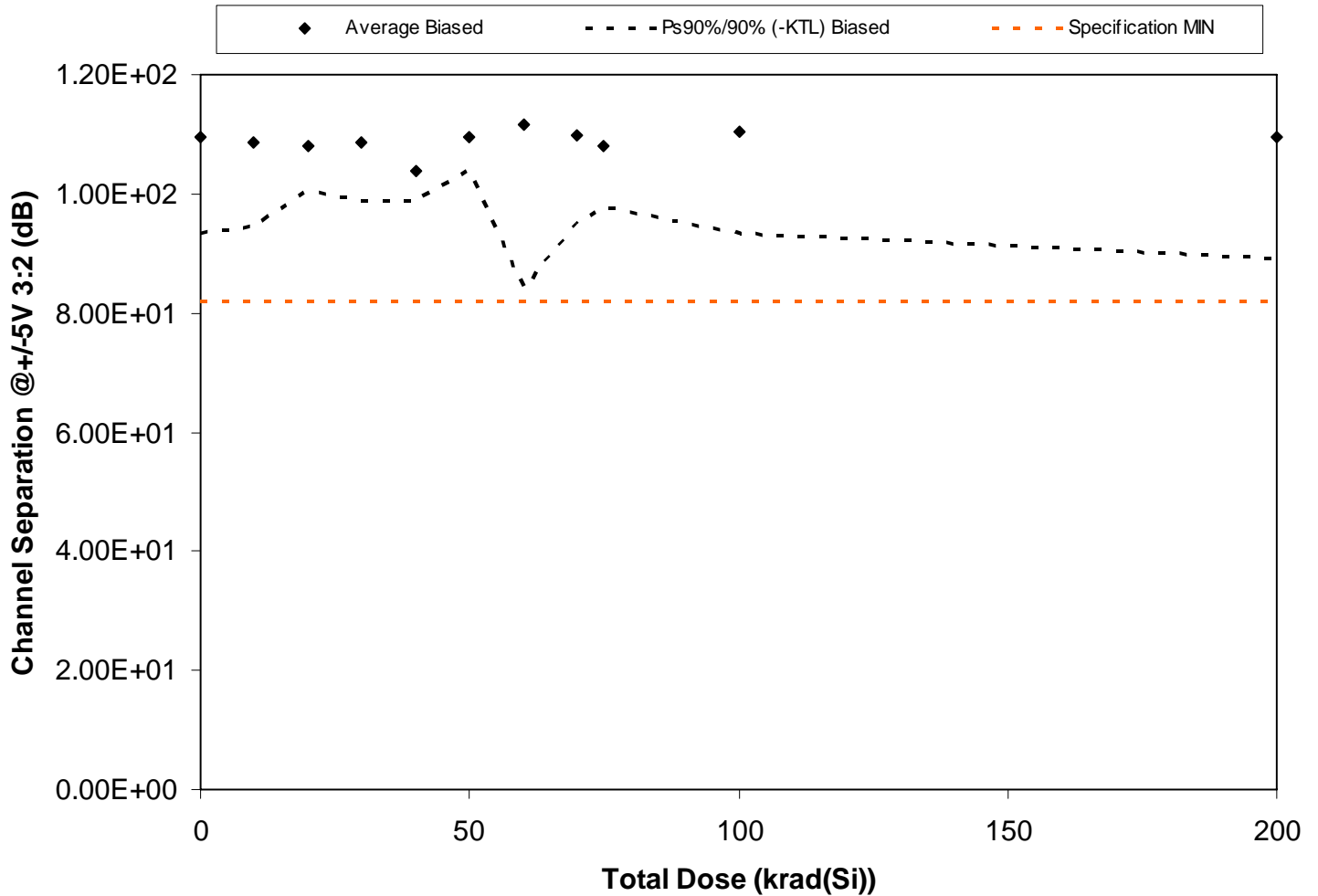

Figure 5.42. Plot of Channel Separation @ +/-5V 3:2 (dB) versus total dose. The solid diamonds are the average of the measured data points for the samples irradiated under electrical bias and the black lines (solid and/or dashed) are the average of the data points after application of the KTL statistics on the samples irradiated under electrical bias. The red dotted line(s) are the pre- and/or post-irradiation minimum and/or maximum specification value as defined in the datasheet and/or test plan.



**RLAT Report
10-326 100808 R1.0**

**Radiation Assured Devices
5017 N. 30th Street
Colorado Springs, CO 80919
(719) 531-0800**

Table 5.42. Raw data for Channel Separation @+/-5V 3:2 (dB) versus total dose, including the statistical analysis, specification and the status of the testing (pass/fail).

Channel Separation @+/-5V 3:2 (dB)	Total Dose (krad(Si))											
	0	10	20	30	40	50	60	70	75	100	200	
Device												
1245	1.07E+02	1.01E+02	1.04E+02	1.11E+02	1.01E+02	1.08E+02	1.14E+02	1.04E+02	1.06E+02	1.14E+02	1.06E+02	
1246	1.07E+02	1.15E+02	1.04E+02	1.04E+02	1.04E+02	1.12E+02	1.15E+02	1.14E+02	1.08E+02	1.13E+02	1.05E+02	
1247	1.06E+02	1.08E+02	1.10E+02	1.19E+02	1.06E+02	1.11E+02	1.07E+02	1.06E+02	1.14E+02	1.11E+02	1.04E+02	
1248	1.07E+02	1.06E+02	1.05E+02	1.10E+02	1.02E+02	1.12E+02	9.83E+01	1.04E+02	1.09E+02	1.05E+02	1.08E+02	
1249	1.24E+02	1.07E+02	1.11E+02	1.07E+02	1.09E+02	1.10E+02	1.45E+02	1.25E+02	1.04E+02	1.05E+02	1.25E+02	
1250	1.08E+02	1.04E+02	1.08E+02	1.03E+02	1.03E+02	1.07E+02	1.10E+02	1.02E+02	1.03E+02	1.10E+02	1.31E+02	
1251	1.05E+02	1.02E+02	1.15E+02	1.05E+02	1.06E+02	1.13E+02	1.03E+02	1.12E+02	1.06E+02	1.06E+02	1.05E+02	
1261	1.08E+02	1.23E+02	1.09E+02	1.09E+02	1.03E+02	1.05E+02	1.16E+02	1.19E+02	1.05E+02	1.01E+02	1.04E+02	
1262	1.23E+02	1.13E+02	1.05E+02	1.06E+02	1.02E+02	1.10E+02	1.01E+02	1.06E+02	1.07E+02	1.31E+02	1.04E+02	
1263	9.99E+01	1.07E+02	1.10E+02	1.12E+02	1.04E+02	1.06E+02	1.06E+02	1.08E+02	1.18E+02	1.08E+02	1.03E+02	
1264	1.05E+02	1.07E+02	1.11E+02	1.08E+02	1.11E+02	1.23E+02	1.04E+02	1.12E+02	1.11E+02	1.11E+02	1.09E+02	
1265	1.07E+02	1.02E+02	1.08E+02	1.05E+02	1.06E+02	1.06E+02	1.05E+02	1.08E+02	1.28E+02	1.06E+02	1.14E+02	
Biased Statistics												
Average Biased	1.09E+02	1.08E+02	1.08E+02	1.09E+02	1.04E+02	1.10E+02	1.12E+02	1.10E+02	1.08E+02	1.10E+02	1.10E+02	
Std Dev Biased	7.77E+00	6.68E+00	3.59E+00	4.80E+00	2.53E+00	2.72E+00	1.34E+01	7.29E+00	4.81E+00	8.21E+00	9.85E+00	
Ps90%/90% (+KTL) Biased	1.25E+02	1.22E+02	1.16E+02	1.19E+02	1.09E+02	1.15E+02	1.39E+02	1.25E+02	1.18E+02	1.27E+02	1.30E+02	
Ps90%/90% (-KTL) Biased	9.34E+01	9.47E+01	1.01E+02	9.88E+01	9.88E+01	1.04E+02	8.41E+01	9.48E+01	9.80E+01	9.34E+01	8.92E+01	
Specification MIN	8.20E+01	8.20E+01	8.20E+01	8.20E+01	8.20E+01	8.20E+01	8.20E+01	8.20E+01	8.20E+01	8.20E+01	8.20E+01	
Status	PASS	PASS	PASS	PASS	PASS	PASS	PASS	PASS	PASS	PASS	PASS	

An ISO 9001:2008 and DSCC Certified Company

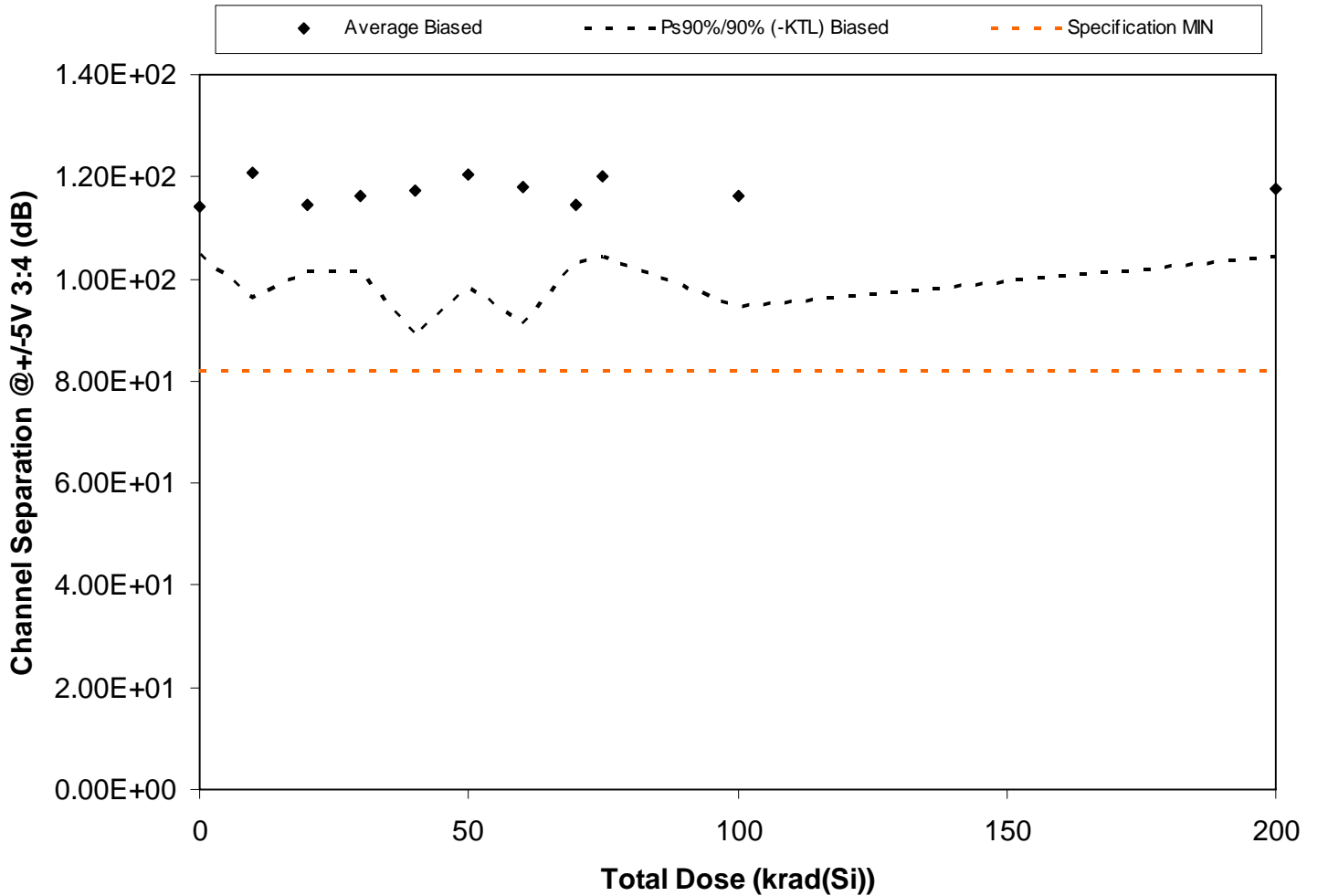

Figure 5.43. Plot of Channel Separation @ +/-5V 3:4 (dB) versus total dose. The solid diamonds are the average of the measured data points for the samples irradiated under electrical bias and the black lines (solid and/or dashed) are the average of the data points after application of the KTL statistics on the samples irradiated under electrical bias. The red dotted line(s) are the pre- and/or post-irradiation minimum and/or maximum specification value as defined in the datasheet and/or test plan.



**RLAT Report
10-326 100808 R1.0**

**Radiation Assured Devices
5017 N. 30th Street
Colorado Springs, CO 80919
(719) 531-0800**

Table 5.43. Raw data for Channel Separation @ \pm 5V 3:4 (dB) versus total dose, including the statistical analysis, specification and the status of the testing (pass/fail).

Channel Separation @ \pm 5V 3:4 (dB)	Total Dose (krad(Si))											
	0	10	20	30	40	50	60	70	75	100	200	
Device												
1245	1.14E+02	1.38E+02	1.17E+02	1.17E+02	1.10E+02	1.26E+02	1.17E+02	1.18E+02	1.14E+02	1.17E+02	1.26E+02	
1246	1.13E+02	1.25E+02	1.08E+02	1.17E+02	1.11E+02	1.24E+02	1.11E+02	1.20E+02	1.22E+02	1.07E+02	1.25E+02	
1247	1.17E+02	1.17E+02	1.11E+02	1.19E+02	1.54E+02	1.16E+02	1.51E+02	1.08E+02	1.37E+02	1.16E+02	1.10E+02	
1248	1.12E+02	1.34E+02	1.25E+02	1.18E+02	1.07E+02	1.32E+02	1.12E+02	1.25E+02	1.16E+02	1.34E+02	1.14E+02	
1249	1.24E+02	1.27E+02	1.11E+02	1.28E+02	1.19E+02	1.41E+02	1.21E+02	1.12E+02	1.22E+02	1.14E+02	1.23E+02	
1250	1.16E+02	1.32E+02	1.24E+02	1.05E+02	1.10E+02	1.11E+02	1.10E+02	1.09E+02	1.10E+02	1.03E+02	1.08E+02	
1251	1.13E+02	1.08E+02	1.17E+02	1.04E+02	1.11E+02	1.23E+02	1.14E+02	1.12E+02	1.17E+02	1.32E+02	1.21E+02	
1261	1.10E+02	1.02E+02	1.13E+02	1.17E+02	1.11E+02	1.09E+02	1.04E+02	1.17E+02	1.25E+02	1.24E+02	1.13E+02	
1262	1.07E+02	1.10E+02	1.10E+02	1.22E+02	1.21E+02	1.08E+02	1.13E+02	1.10E+02	1.21E+02	1.08E+02	1.14E+02	
1263	1.16E+02	1.17E+02	1.09E+02	1.15E+02	1.18E+02	1.15E+02	1.25E+02	1.16E+02	1.16E+02	1.09E+02	1.23E+02	
1264	1.11E+02	1.13E+02	1.11E+02	1.17E+02	1.18E+02	1.38E+02	1.15E+02	1.10E+02	1.22E+02	1.12E+02	1.09E+02	
1265	1.05E+02	1.19E+02	1.18E+02	1.14E+02	1.12E+02	1.22E+02	1.09E+02	1.27E+02	1.15E+02	1.08E+02	1.25E+02	
Biased Statistics												
Average Biased	1.14E+02	1.21E+02	1.14E+02	1.16E+02	1.17E+02	1.21E+02	1.18E+02	1.15E+02	1.20E+02	1.16E+02	1.18E+02	
Std Dev Biased	4.51E+00	1.19E+01	6.22E+00	7.08E+00	1.38E+01	1.07E+01	1.31E+01	5.45E+00	7.58E+00	1.06E+01	6.51E+00	
Ps90%/90% (+KTL) Biased	1.24E+02	1.46E+02	1.27E+02	1.31E+02	1.46E+02	1.43E+02	1.45E+02	1.26E+02	1.36E+02	1.38E+02	1.31E+02	
Ps90%/90% (-KTL) Biased	1.05E+02	9.62E+01	1.01E+02	1.02E+02	8.88E+01	9.85E+01	9.10E+01	1.03E+02	1.04E+02	9.46E+01	1.04E+02	
Specification MIN	8.20E+01	8.20E+01	8.20E+01	8.20E+01	8.20E+01	8.20E+01	8.20E+01	8.20E+01	8.20E+01	8.20E+01	8.20E+01	
Status	PASS	PASS	PASS	PASS	PASS	PASS	PASS	PASS	PASS	PASS	PASS	

An ISO 9001:2008 and DSCC Certified Company

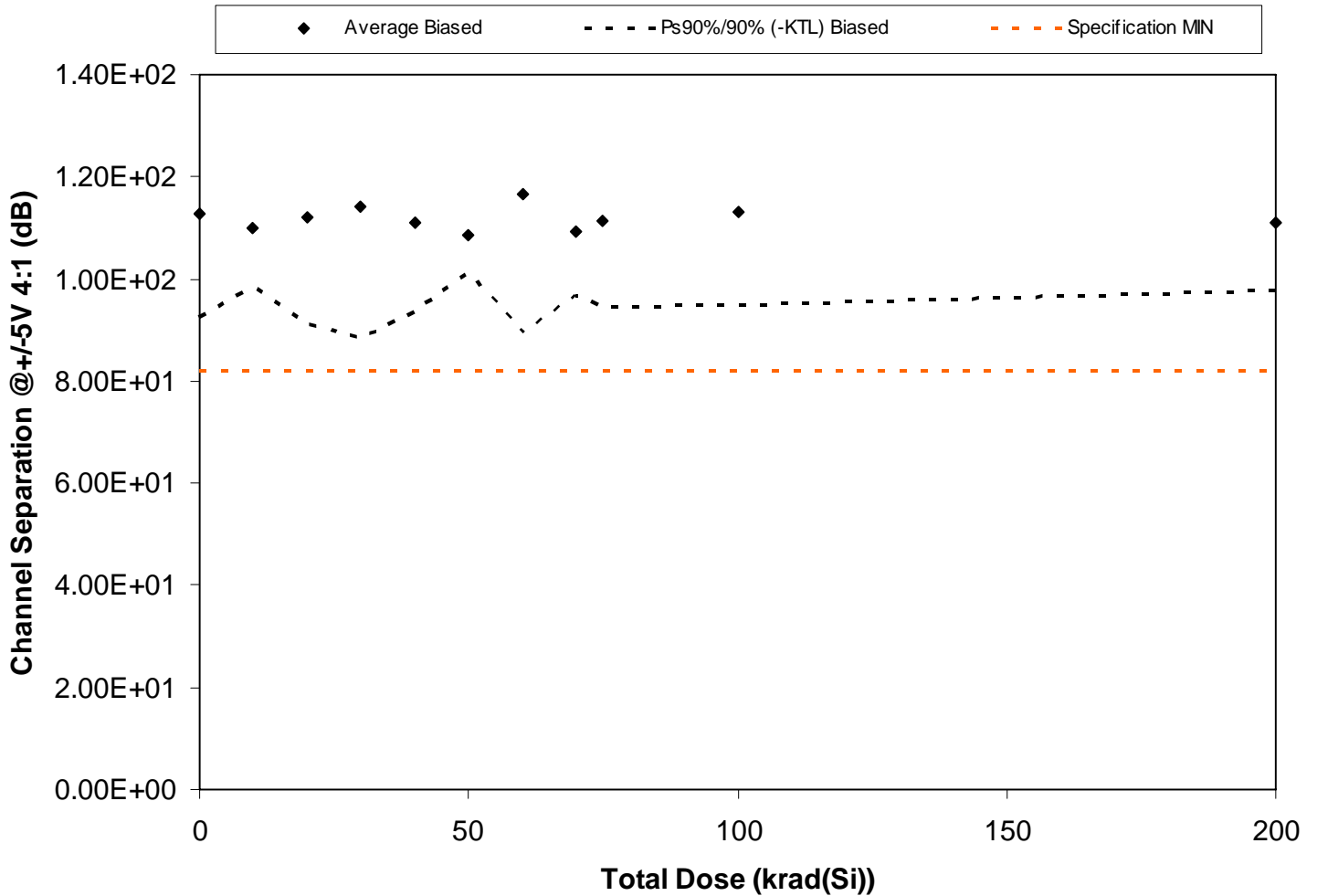

Figure 5.44. Plot of Channel Separation @ +/-5V 4:1 (dB) versus total dose. The solid diamonds are the average of the measured data points for the samples irradiated under electrical bias and the black lines (solid and/or dashed) are the average of the data points after application of the KTL statistics on the samples irradiated under electrical bias. The red dotted line(s) are the pre- and/or post-irradiation minimum and/or maximum specification value as defined in the datasheet and/or test plan.



**RLAT Report
10-326 100808 R1.0**

**Radiation Assured Devices
5017 N. 30th Street
Colorado Springs, CO 80919
(719) 531-0800**

Table 5.44. Raw data for Channel Separation @ $\pm 5V$ 4:1 (dB) versus total dose, including the statistical analysis, specification and the status of the testing (pass/fail).

Channel Separation @ $\pm 5V$ 4:1 (dB)	Total Dose (krad(Si))											
	0	10	20	30	40	50	60	70	75	100	200	
Device												
1245	1.11E+02	1.08E+02	1.11E+02	1.08E+02	1.24E+02	1.09E+02	1.08E+02	1.18E+02	1.24E+02	1.11E+02	1.27E+02	
1246	1.39E+02	1.16E+02	1.23E+02	1.04E+02	1.04E+02	1.17E+02	1.16E+02	1.02E+02	1.08E+02	1.06E+02	1.08E+02	
1247	1.03E+02	1.07E+02	1.07E+02	1.04E+02	1.04E+02	1.03E+02	9.96E+01	1.02E+02	1.06E+02	1.04E+02	1.07E+02	
1248	1.06E+02	1.15E+02	1.29E+02	1.45E+02	1.09E+02	1.09E+02	1.29E+02	1.10E+02	1.18E+02	1.04E+02	1.09E+02	
1249	1.10E+02	1.16E+02	1.25E+02	1.10E+02	1.07E+02	1.07E+02	1.10E+02	1.08E+02	1.06E+02	1.29E+02	1.15E+02	
1250	1.12E+02	1.17E+02	1.08E+02	1.13E+02	1.04E+02	1.11E+02	1.08E+02	1.19E+02	1.04E+02	1.18E+02	1.10E+02	
1251	1.08E+02	1.05E+02	1.10E+02	1.25E+02	1.29E+02	1.08E+02	1.19E+02	1.13E+02	1.26E+02	1.19E+02	1.04E+02	
1261	1.13E+02	1.09E+02	1.00E+02	1.12E+02	1.09E+02	1.08E+02	1.43E+02	1.11E+02	1.04E+02	1.20E+02	1.11E+02	
1262	1.10E+02	1.04E+02	1.03E+02	1.05E+02	1.07E+02	1.10E+02	1.26E+02	1.05E+02	1.11E+02	1.17E+02	1.13E+02	
1263	1.17E+02	1.02E+02	1.04E+02	1.16E+02	1.13E+02	1.06E+02	1.06E+02	1.05E+02	1.06E+02	1.03E+02	1.08E+02	
1264	1.10E+02	1.09E+02	1.07E+02	1.29E+02	1.10E+02	1.13E+02	1.04E+02	1.18E+02	1.11E+02	1.00E+02	1.11E+02	
1265	1.26E+02	1.10E+02	1.11E+02	1.16E+02	1.19E+02	1.30E+02	1.08E+02	1.11E+02	1.21E+02	1.10E+02	1.09E+02	
Biased Statistics												
Average Biased	1.13E+02	1.10E+02	1.12E+02	1.14E+02	1.11E+02	1.09E+02	1.17E+02	1.09E+02	1.11E+02	1.13E+02	1.11E+02	
Std Dev Biased	9.85E+00	5.57E+00	1.01E+01	1.25E+01	8.49E+00	3.57E+00	1.31E+01	6.12E+00	8.09E+00	8.82E+00	6.50E+00	
Ps90%/90% (+KTL) Biased	1.33E+02	1.21E+02	1.33E+02	1.40E+02	1.28E+02	1.16E+02	1.44E+02	1.22E+02	1.28E+02	1.31E+02	1.25E+02	
Ps90%/90% (-KTL) Biased	9.25E+01	9.84E+01	9.12E+01	8.82E+01	9.34E+01	1.01E+02	8.94E+01	9.66E+01	9.46E+01	9.49E+01	9.77E+01	
Specification MIN	8.20E+01	8.20E+01	8.20E+01	8.20E+01	8.20E+01	8.20E+01	8.20E+01	8.20E+01	8.20E+01	8.20E+01	8.20E+01	
Status	PASS	PASS	PASS	PASS	PASS	PASS	PASS	PASS	PASS	PASS	PASS	

An ISO 9001:2008 and DSCC Certified Company

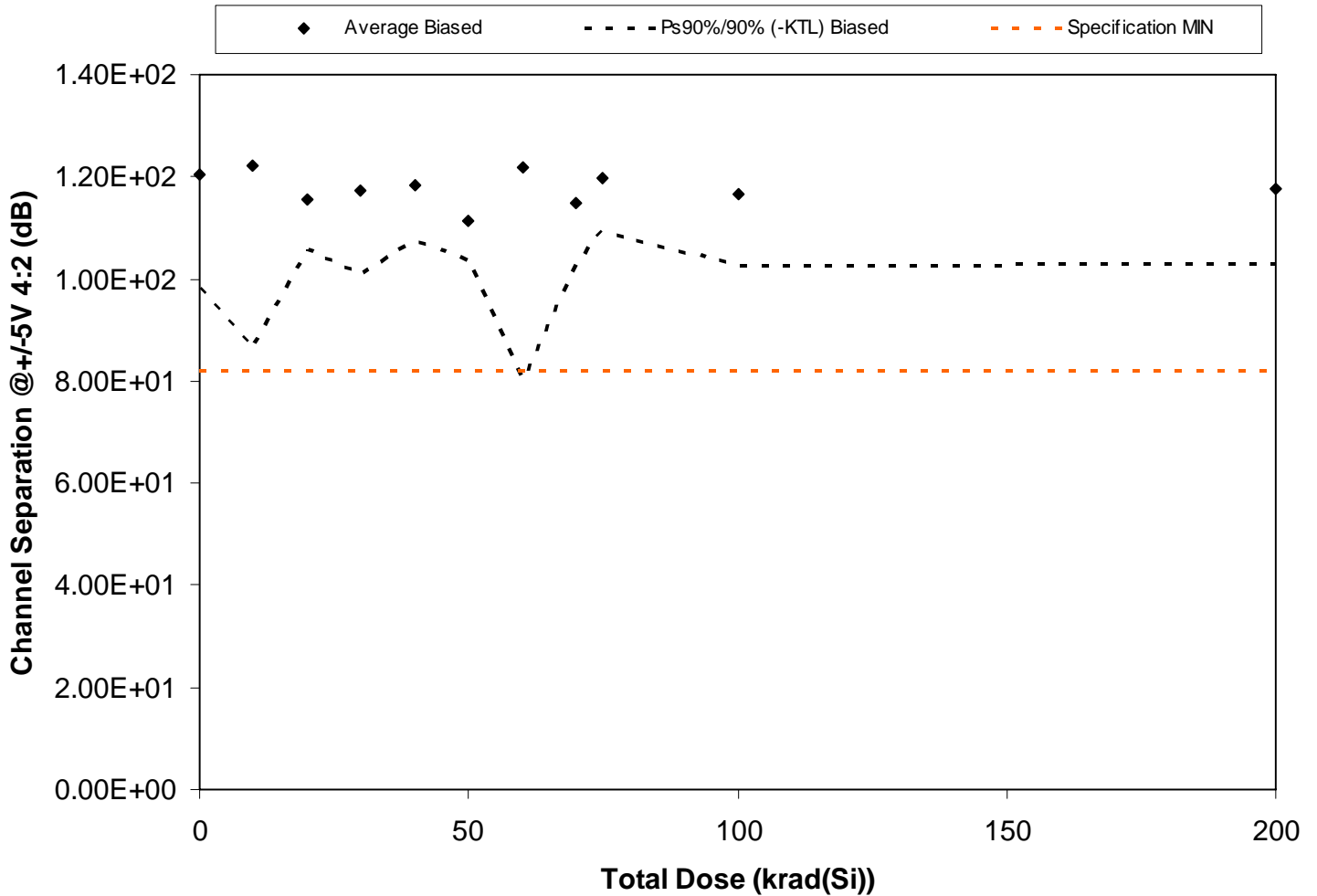

Figure 5.45. Plot of Channel Separation @ +/-5V 4:2 (dB) versus total dose. The solid diamonds are the average of the measured data points for the samples irradiated under electrical bias and the black lines (solid and/or dashed) are the average of the data points after application of the KTL statistics on the samples irradiated under electrical bias. The red dotted line(s) are the pre- and/or post-irradiation minimum and/or maximum specification value as defined in the datasheet and/or test plan.



**RLAT Report
10-326 100808 R1.0**

**Radiation Assured Devices
5017 N. 30th Street
Colorado Springs, CO 80919
(719) 531-0800**

Table 5.45. Raw data for Channel Separation @+/-5V 4:2 (dB) versus total dose, including the statistical analysis, specification and the status of the testing (pass/fail).

Channel Separation @+/-5V 4:2 (dB)	Total Dose (krad(Si))											
	0	10	20	30	40	50	60	70	75	100	200	
Device												
1245	1.14E+02	1.11E+02	1.15E+02	1.15E+02	1.14E+02	1.17E+02	1.09E+02	1.09E+02	1.23E+02	1.22E+02	1.18E+02	
1246	1.22E+02	1.40E+02	1.13E+02	1.21E+02	1.14E+02	1.11E+02	1.16E+02	1.15E+02	1.25E+02	1.18E+02	1.25E+02	
1247	1.48E+02	1.14E+02	1.15E+02	1.15E+02	1.31E+02	1.13E+02	1.14E+02	1.13E+02	1.28E+02	1.13E+02	1.15E+02	
1248	1.29E+02	1.23E+02	1.15E+02	1.08E+02	1.15E+02	1.09E+02	1.13E+02	1.06E+02	1.13E+02	1.11E+02	1.17E+02	
1249	1.15E+02	1.20E+02	1.27E+02	1.15E+02	1.16E+02	1.09E+02	1.23E+02	1.24E+02	1.19E+02	1.28E+02	1.13E+02	
1250	1.20E+02	1.09E+02	1.14E+02	1.26E+02	1.17E+02	1.15E+02	1.32E+02	1.14E+02	1.16E+02	1.25E+02	1.22E+02	
1251	1.16E+02	1.09E+02	1.19E+02	1.10E+02	1.20E+02	1.08E+02	1.75E+02	1.23E+02	1.15E+02	1.11E+02	1.06E+02	
1261	1.17E+02	1.65E+02	1.17E+02	1.13E+02	1.15E+02	1.12E+02	1.12E+02	1.19E+02	1.23E+02	1.19E+02	1.14E+02	
1262	1.12E+02	1.18E+02	1.13E+02	1.35E+02	1.21E+02	1.05E+02	1.16E+02	1.14E+02	1.14E+02	1.08E+02	1.15E+02	
1263	1.12E+02	1.14E+02	1.09E+02	1.17E+02	1.19E+02	1.14E+02	1.08E+02	1.11E+02	1.24E+02	1.12E+02	1.31E+02	
1264	1.18E+02	1.30E+02	1.05E+02	1.38E+02	1.15E+02	1.23E+02	1.24E+02	1.19E+02	1.24E+02	1.17E+02	1.15E+02	
1265	1.12E+02	1.16E+02	1.20E+02	1.21E+02	1.08E+02	1.20E+02	1.22E+02	1.15E+02	1.16E+02	1.12E+02	1.09E+02	
Biased Statistics												
Average Biased	1.20E+02	1.22E+02	1.16E+02	1.17E+02	1.18E+02	1.11E+02	1.22E+02	1.15E+02	1.20E+02	1.17E+02	1.18E+02	
Std Dev Biased	1.09E+01	1.74E+01	4.73E+00	7.89E+00	5.25E+00	3.79E+00	2.00E+01	5.70E+00	5.12E+00	6.77E+00	7.04E+00	
Ps90%/90% (+KTL) Biased	1.43E+02	1.58E+02	1.25E+02	1.34E+02	1.29E+02	1.19E+02	1.63E+02	1.27E+02	1.30E+02	1.31E+02	1.32E+02	
Ps90%/90% (-KTL) Biased	9.80E+01	8.63E+01	1.06E+02	1.01E+02	1.07E+02	1.04E+02	8.04E+01	1.03E+02	1.09E+02	1.03E+02	1.03E+02	
Specification MIN	8.20E+01	8.20E+01	8.20E+01	8.20E+01	8.20E+01	8.20E+01	8.20E+01	8.20E+01	8.20E+01	8.20E+01	8.20E+01	
Status	PASS	PASS	PASS	PASS	PASS	PASS	PASS	PASS	PASS	PASS	PASS	

An ISO 9001:2008 and DSCC Certified Company

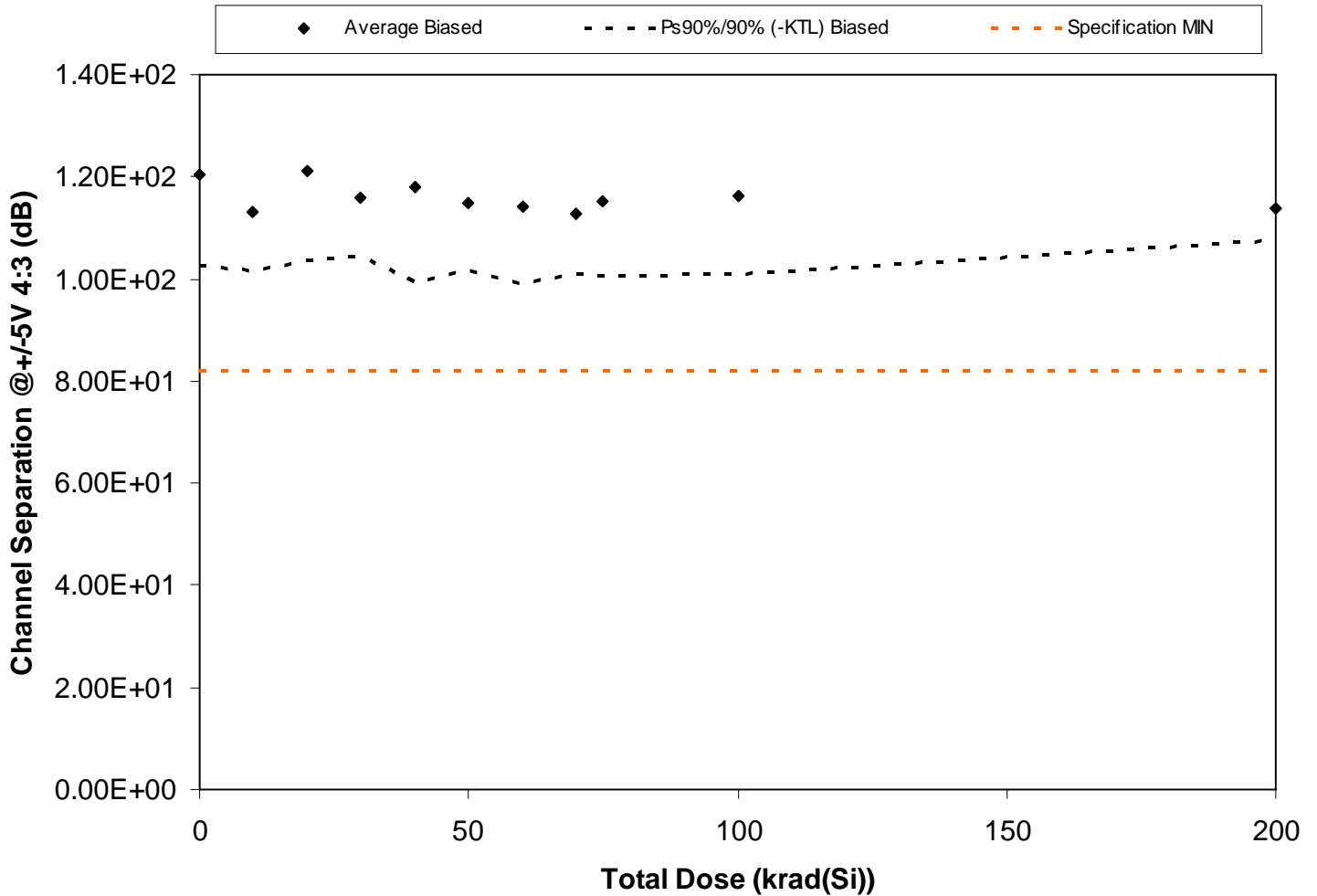

Figure 5.46. Plot of Channel Separation @ +/-5V 4:3 (dB) versus total dose. The solid diamonds are the average of the measured data points for the samples irradiated under electrical bias and the black lines (solid and/or dashed) are the average of the data points after application of the KTL statistics on the samples irradiated under electrical bias. The red dotted line(s) are the pre- and/or post-irradiation minimum and/or maximum specification value as defined in the datasheet and/or test plan.



**RLAT Report
10-326 100808 R1.0**

**Radiation Assured Devices
5017 N. 30th Street
Colorado Springs, CO 80919
(719) 531-0800**

Table 5.46. Raw data for Channel Separation @+/-5V 4:3 (dB) versus total dose, including the statistical analysis, specification and the status of the testing (pass/fail).

Channel Separation @+/-5V 4:3 (dB)	Total Dose (krad(Si))											
	0	10	20	30	40	50	60	70	75	100	200	
Device												
1245	1.21E+02	1.16E+02	1.19E+02	1.20E+02	1.17E+02	1.06E+02	1.10E+02	1.14E+02	1.06E+02	1.06E+02	1.15E+02	
1246	1.34E+02	1.08E+02	1.24E+02	1.13E+02	1.14E+02	1.13E+02	1.20E+02	1.09E+02	1.10E+02	1.14E+02	1.11E+02	
1247	1.30E+02	1.08E+02	1.22E+02	1.11E+02	1.19E+02	1.20E+02	1.13E+02	1.15E+02	1.20E+02	1.08E+02	1.20E+02	
1248	1.12E+02	1.12E+02	1.22E+02	1.08E+02	1.17E+02	1.21E+02	1.11E+02	1.06E+02	1.10E+02	1.22E+02	1.12E+02	
1249	1.20E+02	1.14E+02	1.03E+02	1.25E+02	1.16E+02	1.13E+02	1.31E+02	1.07E+02	1.16E+02	1.15E+02	1.12E+02	
1250	1.14E+02	1.12E+02	1.20E+02	1.20E+02	1.06E+02	1.18E+02	1.12E+02	1.19E+02	1.18E+02	1.14E+02	1.15E+02	
1251	1.11E+02	1.27E+02	1.22E+02	1.20E+02	1.22E+02	1.08E+02	1.15E+02	1.08E+02	1.28E+02	1.15E+02	1.10E+02	
1261	1.30E+02	1.10E+02	1.34E+02	1.09E+02	1.23E+02	1.26E+02	1.15E+02	1.10E+02	1.19E+02	1.28E+02	1.13E+02	
1262	1.23E+02	1.14E+02	1.32E+02	1.16E+02	1.38E+02	1.14E+02	1.10E+02	1.23E+02	1.20E+02	1.12E+02	1.17E+02	
1263	1.10E+02	1.11E+02	1.16E+02	1.17E+02	1.08E+02	1.09E+02	1.04E+02	1.19E+02	1.05E+02	1.27E+02	1.13E+02	
1264	1.08E+02	1.22E+02	1.10E+02	1.11E+02	1.05E+02	1.21E+02	1.20E+02	1.28E+02	1.16E+02	1.16E+02	1.11E+02	
1265	1.18E+02	1.10E+02	1.11E+02	1.12E+02	1.14E+02	1.23E+02	1.17E+02	1.20E+02	1.07E+02	1.33E+02	1.10E+02	
Biased Statistics												
Average Biased	1.20E+02	1.13E+02	1.21E+02	1.16E+02	1.18E+02	1.15E+02	1.14E+02	1.13E+02	1.15E+02	1.16E+02	1.14E+02	
Std Dev Biased	8.66E+00	5.60E+00	8.59E+00	5.53E+00	8.93E+00	6.29E+00	7.25E+00	5.88E+00	7.12E+00	7.44E+00	3.10E+00	
Ps90%/90% (+KTL) Biased	1.38E+02	1.25E+02	1.39E+02	1.27E+02	1.36E+02	1.28E+02	1.29E+02	1.25E+02	1.30E+02	1.31E+02	1.20E+02	
Ps90%/90% (-KTL) Biased	1.02E+02	1.02E+02	1.04E+02	1.04E+02	9.94E+01	1.02E+02	9.91E+01	1.01E+02	1.00E+02	1.01E+02	1.07E+02	
Specification MIN	8.20E+01	8.20E+01	8.20E+01	8.20E+01	8.20E+01	8.20E+01	8.20E+01	8.20E+01	8.20E+01	8.20E+01	8.20E+01	
Status	PASS	PASS	PASS	PASS	PASS	PASS	PASS	PASS	PASS	PASS	PASS	

An ISO 9001:2008 and DSCC Certified Company

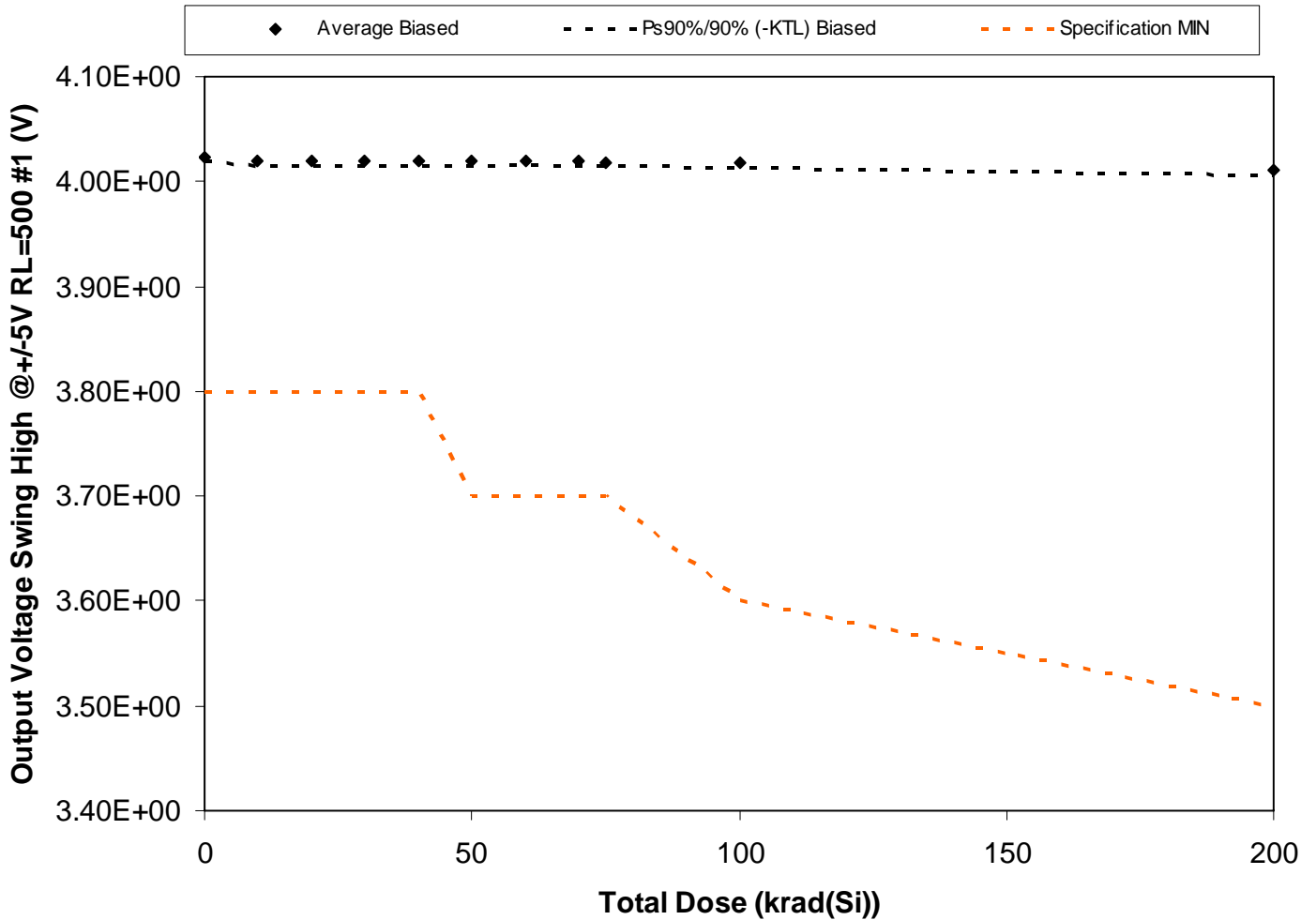

Figure 5.47. Plot of Output Voltage Swing High @ +/-5V RL=500 #1 (V) versus total dose. The solid diamonds are the average of the measured data points for the samples irradiated under electrical bias and the black lines (solid and/or dashed) are the average of the data points after application of the KTL statistics on the samples irradiated under electrical bias. The red dotted line(s) are the pre- and/or post-irradiation minimum and/or maximum specification value as defined in the datasheet and/or test plan.



**RLAT Report
10-326 100808 R1.0**

**Radiation Assured Devices
5017 N. 30th Street
Colorado Springs, CO 80919
(719) 531-0800**

Table 5.47. Raw data for Output Voltage Swing High @+/-5V RL=500 #1 (V) versus total dose, including the statistical analysis, specification and the status of the testing (pass/fail).

Output Voltage Swing High @+/-5V RL=500 #1 (V)	Total Dose (krad(Si))											
	0	10	20	30	40	50	60	70	75	100	200	
Device												
1245	4.02E+00	4.02E+00	4.02E+00	4.02E+00	4.02E+00	4.02E+00	4.02E+00	4.02E+00	4.02E+00	4.02E+00	4.01E+00	4.01E+00
1246	4.02E+00	4.02E+00	4.02E+00	4.02E+00	4.02E+00	4.02E+00	4.02E+00	4.02E+00	4.02E+00	4.02E+00	4.01E+00	4.01E+00
1247	4.03E+00	4.02E+00	4.02E+00	4.02E+00	4.02E+00	4.02E+00	4.02E+00	4.02E+00	4.02E+00	4.02E+00	4.01E+00	4.01E+00
1248	4.03E+00	4.02E+00	4.02E+00	4.02E+00	4.02E+00	4.02E+00	4.02E+00	4.02E+00	4.02E+00	4.02E+00	4.01E+00	4.01E+00
1249	4.03E+00	4.02E+00	4.02E+00	4.02E+00	4.02E+00	4.02E+00	4.02E+00	4.02E+00	4.02E+00	4.02E+00	4.01E+00	4.01E+00
1250	4.02E+00	4.02E+00	4.02E+00	4.02E+00	4.02E+00	4.02E+00	4.02E+00	4.02E+00	4.02E+00	4.02E+00	4.01E+00	4.01E+00
1251	4.02E+00	4.02E+00	4.02E+00	4.02E+00	4.02E+00	4.02E+00	4.02E+00	4.02E+00	4.02E+00	4.02E+00	4.01E+00	4.01E+00
1261	4.03E+00	4.02E+00	4.02E+00	4.02E+00	4.02E+00	4.02E+00	4.02E+00	4.02E+00	4.02E+00	4.02E+00	4.01E+00	4.01E+00
1262	4.02E+00	4.02E+00	4.02E+00	4.02E+00	4.02E+00	4.02E+00	4.02E+00	4.02E+00	4.02E+00	4.02E+00	4.01E+00	4.01E+00
1263	4.02E+00	4.02E+00	4.02E+00	4.02E+00	4.02E+00	4.02E+00	4.02E+00	4.02E+00	4.02E+00	4.02E+00	4.01E+00	4.01E+00
1264	4.02E+00	4.02E+00	4.02E+00	4.02E+00	4.02E+00	4.02E+00	4.02E+00	4.02E+00	4.02E+00	4.02E+00	4.02E+00	4.02E+00
1265	4.03E+00	4.02E+00	4.02E+00	4.02E+00	4.02E+00	4.02E+00	4.02E+00	4.02E+00	4.02E+00	4.02E+00	4.02E+00	4.02E+00
Biased Statistics												
Average Biased	4.02E+00	4.02E+00	4.02E+00	4.02E+00	4.02E+00	4.02E+00	4.02E+00	4.02E+00	4.02E+00	4.02E+00	4.01E+00	4.01E+00
Std Dev Biased	2.33E-03	2.33E-03	2.64E-03	2.44E-03	2.16E-03	2.20E-03	1.96E-03	1.85E-03	2.06E-03	2.01E-03	1.90E-03	1.90E-03
Ps90%/90% (+KTL) Biased	4.03E+00	4.02E+00	4.02E+00	4.02E+00	4.02E+00	4.02E+00	4.02E+00	4.02E+00	4.02E+00	4.02E+00	4.01E+00	4.01E+00
Ps90%/90% (-KTL) Biased	4.02E+00	4.02E+00	4.01E+00	4.01E+00	4.02E+00	4.01E+00	4.02E+00	4.02E+00	4.01E+00	4.01E+00	4.01E+00	4.01E+00
Specification MIN	3.80E+00	3.80E+00	3.80E+00	3.80E+00	3.80E+00	3.70E+00	3.70E+00	3.70E+00	3.70E+00	3.60E+00	3.50E+00	3.50E+00
Status	PASS	PASS	PASS	PASS	PASS	PASS	PASS	PASS	PASS	PASS	PASS	PASS

An ISO 9001:2008 and DSCC Certified Company

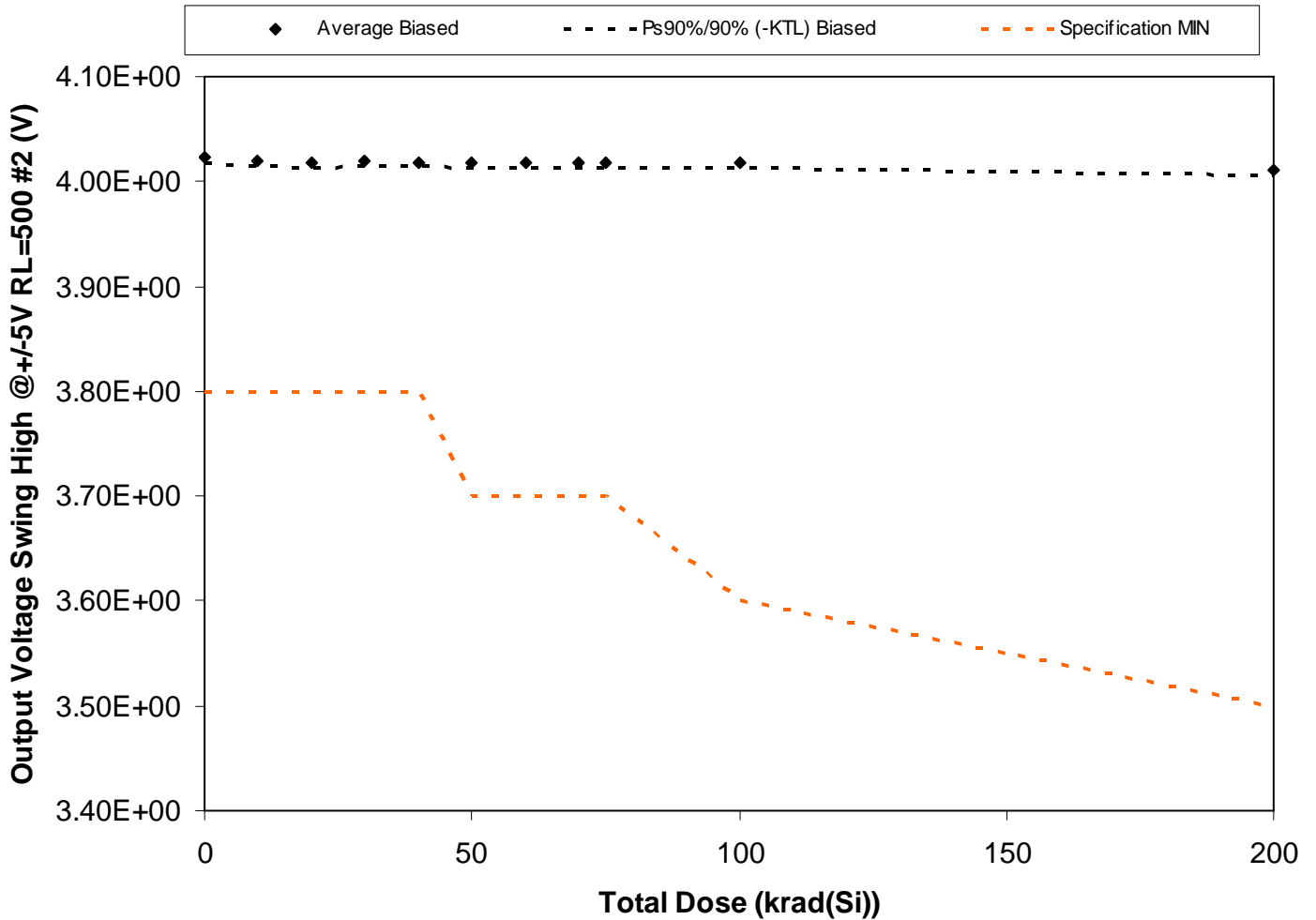

Figure 5.48. Plot of Output Voltage Swing High @ +/-5V RL=500 #2 (V) versus total dose. The solid diamonds are the average of the measured data points for the samples irradiated under electrical bias and the black lines (solid and/or dashed) are the average of the data points after application of the KTL statistics on the samples irradiated under electrical bias. The red dotted line(s) are the pre- and/or post-irradiation minimum and/or maximum specification value as defined in the datasheet and/or test plan.



**RLAT Report
10-326 100808 R1.0**

**Radiation Assured Devices
5017 N. 30th Street
Colorado Springs, CO 80919
(719) 531-0800**

Table 5.48. Raw data for Output Voltage Swing High @+/-5V RL=500 #2 (V) versus total dose, including the statistical analysis, specification and the status of the testing (pass/fail).

Output Voltage Swing High @+/-5V RL=500 #2 (V)	Total Dose (krad(Si))											
	0	10	20	30	40	50	60	70	75	100	200	
Device												
1245	4.02E+00	4.02E+00	4.02E+00	4.02E+00	4.02E+00	4.01E+00	4.01E+00	4.01E+00	4.01E+00	4.01E+00	4.01E+00	4.01E+00
1246	4.02E+00	4.02E+00	4.02E+00	4.02E+00	4.02E+00	4.02E+00	4.02E+00	4.02E+00	4.02E+00	4.02E+00	4.02E+00	4.01E+00
1247	4.02E+00	4.02E+00	4.02E+00	4.02E+00	4.02E+00	4.02E+00	4.02E+00	4.02E+00	4.02E+00	4.02E+00	4.02E+00	4.01E+00
1248	4.03E+00	4.02E+00	4.02E+00	4.02E+00	4.02E+00	4.02E+00	4.02E+00	4.02E+00	4.02E+00	4.02E+00	4.02E+00	4.02E+00
1249	4.02E+00	4.02E+00	4.02E+00	4.02E+00	4.02E+00	4.02E+00	4.02E+00	4.02E+00	4.02E+00	4.02E+00	4.02E+00	4.01E+00
1250	4.02E+00	4.02E+00	4.02E+00	4.02E+00	4.02E+00	4.02E+00	4.02E+00	4.02E+00	4.02E+00	4.02E+00	4.02E+00	4.01E+00
1251	4.02E+00	4.02E+00	4.02E+00	4.02E+00	4.02E+00	4.02E+00	4.02E+00	4.02E+00	4.02E+00	4.02E+00	4.02E+00	4.01E+00
1261	4.03E+00	4.02E+00	4.02E+00	4.02E+00	4.02E+00	4.02E+00	4.02E+00	4.02E+00	4.02E+00	4.02E+00	4.02E+00	4.01E+00
1262	4.02E+00	4.02E+00	4.02E+00	4.02E+00	4.02E+00	4.02E+00	4.02E+00	4.02E+00	4.02E+00	4.02E+00	4.02E+00	4.01E+00
1263	4.03E+00	4.02E+00	4.02E+00	4.02E+00	4.02E+00	4.02E+00	4.02E+00	4.02E+00	4.02E+00	4.02E+00	4.02E+00	4.01E+00
1264	4.02E+00	4.02E+00	4.02E+00	4.02E+00	4.02E+00	4.02E+00	4.02E+00	4.02E+00	4.02E+00	4.02E+00	4.02E+00	4.02E+00
1265	4.02E+00	4.02E+00	4.02E+00	4.02E+00	4.02E+00	4.02E+00	4.02E+00	4.02E+00	4.02E+00	4.02E+00	4.02E+00	4.02E+00
Biased Statistics												
Average Biased	4.02E+00	4.02E+00	4.02E+00	4.02E+00	4.02E+00	4.02E+00	4.02E+00	4.02E+00	4.02E+00	4.02E+00	4.02E+00	4.01E+00
Std Dev Biased	2.08E-03	2.36E-03	2.63E-03	2.25E-03	2.41E-03	2.59E-03	2.59E-03	2.59E-03	2.39E-03	2.47E-03	2.50E-03	
Ps90%/90% (+KTL) Biased	4.03E+00	4.02E+00	4.02E+00	4.02E+00	4.02E+00	4.02E+00	4.02E+00	4.02E+00	4.02E+00	4.02E+00	4.02E+00	4.02E+00
Ps90%/90% (-KTL) Biased	4.02E+00	4.01E+00	4.01E+00	4.01E+00	4.01E+00	4.01E+00	4.01E+00	4.01E+00	4.01E+00	4.01E+00	4.01E+00	4.01E+00
Specification MIN	3.80E+00	3.80E+00	3.80E+00	3.80E+00	3.80E+00	3.70E+00	3.70E+00	3.70E+00	3.70E+00	3.60E+00	3.50E+00	
Status	PASS	PASS	PASS	PASS	PASS	PASS	PASS	PASS	PASS	PASS	PASS	PASS

An ISO 9001:2008 and DSCC Certified Company

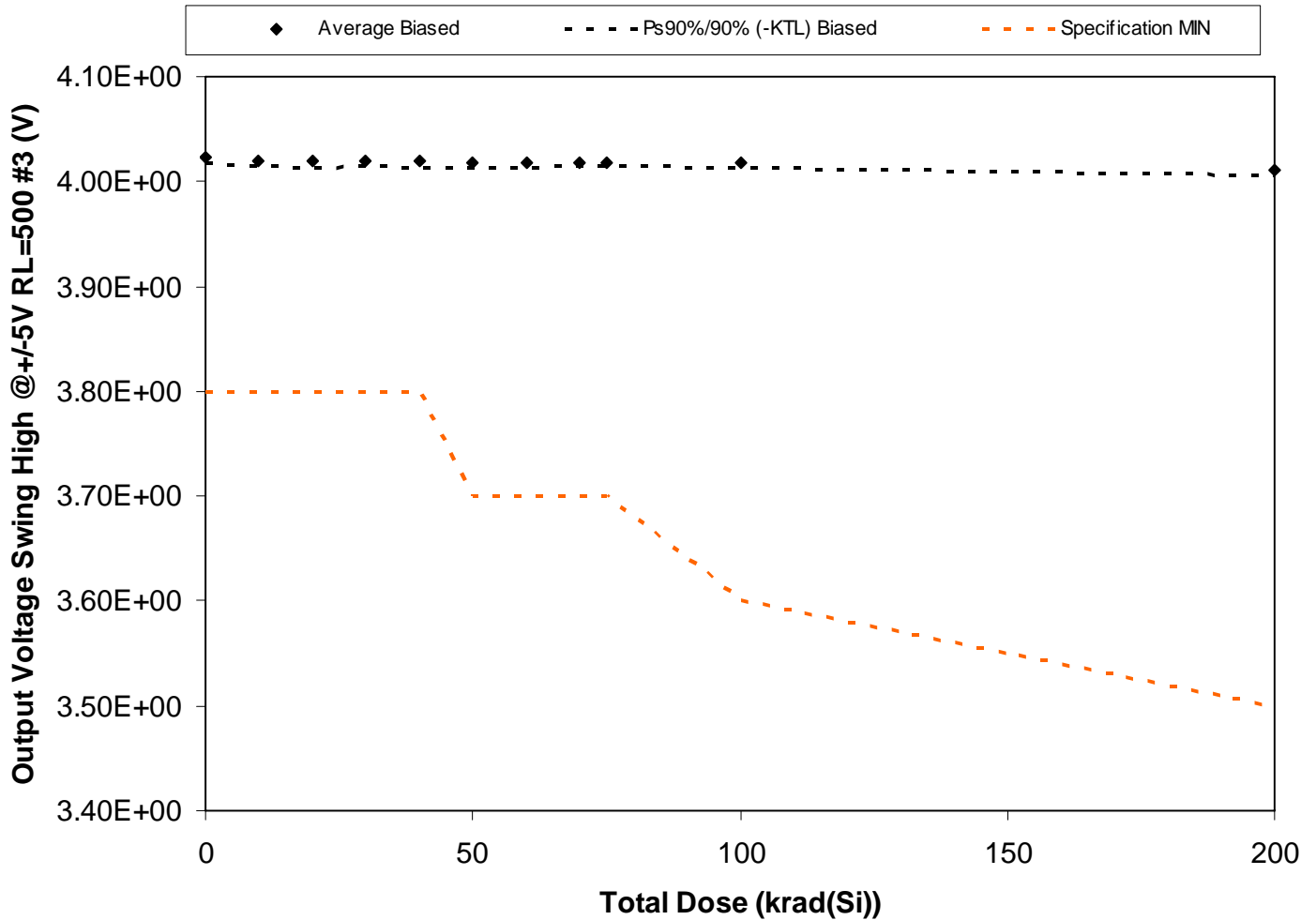

Figure 5.49. Plot of Output Voltage Swing High @ +/-5V RL=500 #3 (V) versus total dose. The solid diamonds are the average of the measured data points for the samples irradiated under electrical bias and the black lines (solid and/or dashed) are the average of the data points after application of the KTL statistics on the samples irradiated under electrical bias. The red dotted line(s) are the pre- and/or post-irradiation minimum and/or maximum specification value as defined in the datasheet and/or test plan.



**RLAT Report
10-326 100808 R1.0**

**Radiation Assured Devices
5017 N. 30th Street
Colorado Springs, CO 80919
(719) 531-0800**

Table 5.49. Raw data for Output Voltage Swing High @+/-5V RL=500 #3 (V) versus total dose, including the statistical analysis, specification and the status of the testing (pass/fail).

Output Voltage Swing High @+/-5V RL=500 #3 (V)	Total Dose (krad(Si))											
	0	10	20	30	40	50	60	70	75	100	200	
Device												
1245	4.02E+00	4.02E+00	4.02E+00	4.02E+00	4.02E+00	4.02E+00	4.02E+00	4.02E+00	4.02E+00	4.02E+00	4.01E+00	4.01E+00
1246	4.02E+00	4.02E+00	4.02E+00	4.02E+00	4.02E+00	4.02E+00	4.02E+00	4.02E+00	4.02E+00	4.02E+00	4.02E+00	4.01E+00
1247	4.02E+00	4.02E+00	4.02E+00	4.02E+00	4.02E+00	4.02E+00	4.02E+00	4.02E+00	4.02E+00	4.02E+00	4.02E+00	4.01E+00
1248	4.03E+00	4.03E+00	4.03E+00	4.03E+00	4.03E+00	4.02E+00	4.02E+00	4.02E+00	4.02E+00	4.02E+00	4.02E+00	4.01E+00
1249	4.02E+00	4.02E+00	4.02E+00	4.02E+00	4.02E+00	4.02E+00	4.02E+00	4.02E+00	4.02E+00	4.02E+00	4.02E+00	4.01E+00
1250	4.02E+00	4.02E+00	4.02E+00	4.02E+00	4.02E+00	4.02E+00	4.02E+00	4.02E+00	4.02E+00	4.02E+00	4.02E+00	4.01E+00
1251	4.02E+00	4.02E+00	4.02E+00	4.02E+00	4.02E+00	4.02E+00	4.02E+00	4.02E+00	4.02E+00	4.02E+00	4.02E+00	4.01E+00
1261	4.03E+00	4.02E+00	4.02E+00	4.02E+00	4.02E+00	4.02E+00	4.02E+00	4.02E+00	4.02E+00	4.02E+00	4.02E+00	4.01E+00
1262	4.02E+00	4.02E+00	4.02E+00	4.02E+00	4.02E+00	4.02E+00	4.02E+00	4.02E+00	4.02E+00	4.02E+00	4.02E+00	4.01E+00
1263	4.03E+00	4.02E+00	4.02E+00	4.02E+00	4.02E+00	4.02E+00	4.02E+00	4.02E+00	4.02E+00	4.02E+00	4.02E+00	4.01E+00
1264	4.02E+00	4.02E+00	4.02E+00	4.02E+00	4.02E+00	4.02E+00	4.02E+00	4.02E+00	4.02E+00	4.02E+00	4.02E+00	4.02E+00
1265	4.02E+00	4.02E+00	4.02E+00	4.02E+00	4.02E+00	4.02E+00	4.02E+00	4.02E+00	4.02E+00	4.02E+00	4.02E+00	4.02E+00
Biased Statistics												
Average Biased	4.02E+00	4.02E+00	4.02E+00	4.02E+00	4.02E+00	4.02E+00	4.02E+00	4.02E+00	4.02E+00	4.02E+00	4.02E+00	4.01E+00
Std Dev Biased	2.80E-03	2.64E-03	2.92E-03	2.80E-03	2.79E-03	2.54E-03	2.58E-03	2.36E-03	2.13E-03	2.31E-03	2.32E-03	
Ps90%/90% (+KTL) Biased	4.03E+00	4.02E+00	4.03E+00	4.03E+00	4.03E+00	4.02E+00	4.02E+00	4.02E+00	4.02E+00	4.02E+00	4.02E+00	4.02E+00
Ps90%/90% (-KTL) Biased	4.02E+00	4.01E+00	4.01E+00	4.01E+00	4.01E+00	4.01E+00	4.01E+00	4.01E+00	4.01E+00	4.01E+00	4.01E+00	4.01E+00
Specification MIN	3.80E+00	3.80E+00	3.80E+00	3.80E+00	3.80E+00	3.70E+00	3.70E+00	3.70E+00	3.70E+00	3.60E+00	3.50E+00	
Status	PASS	PASS	PASS	PASS	PASS	PASS	PASS	PASS	PASS	PASS	PASS	PASS

An ISO 9001:2008 and DSCC Certified Company

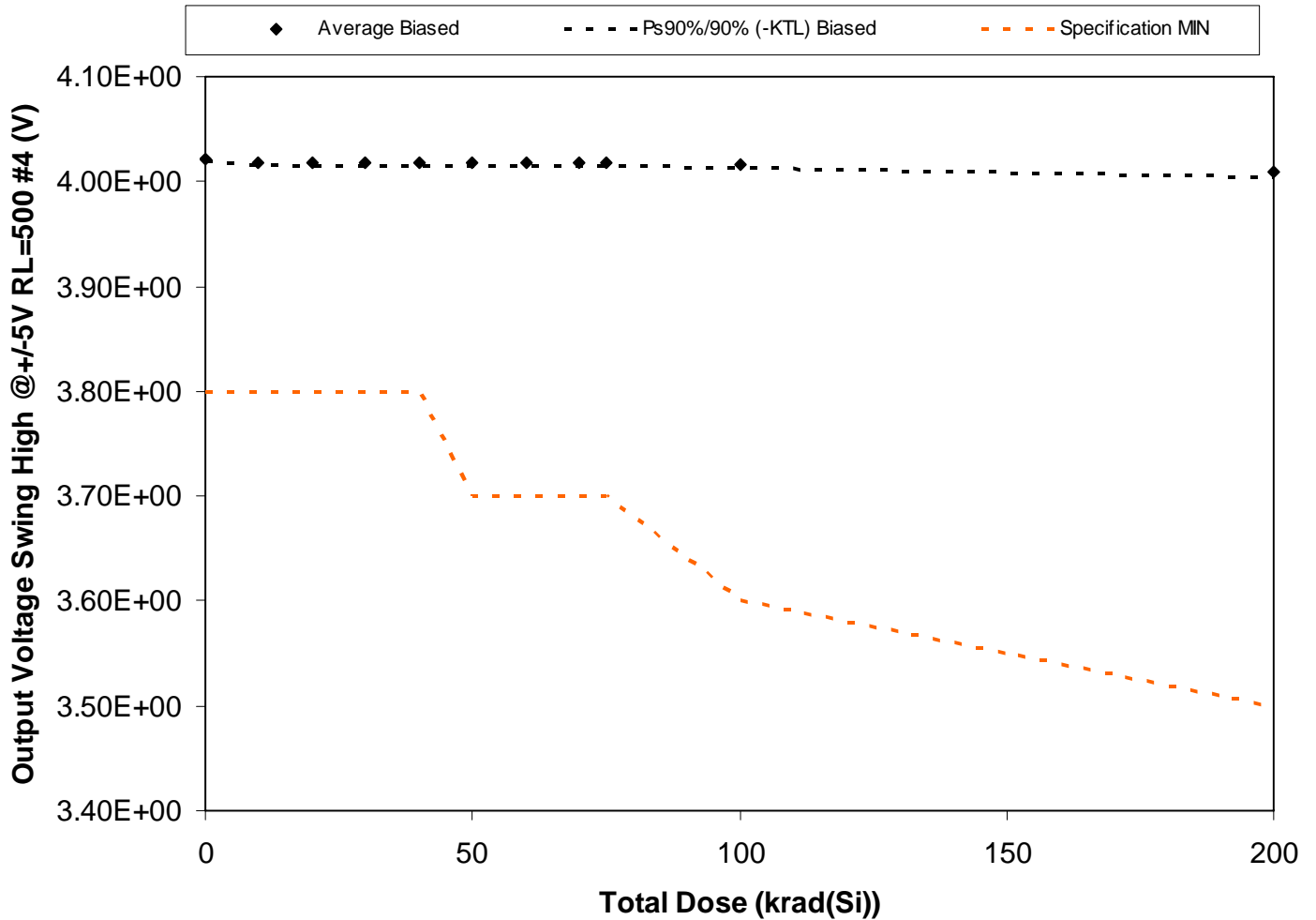

Figure 5.50. Plot of Output Voltage Swing High @ +/-5V RL=500 #4 (V) versus total dose. The solid diamonds are the average of the measured data points for the samples irradiated under electrical bias and the black lines (solid and/or dashed) are the average of the data points after application of the KTL statistics on the samples irradiated under electrical bias. The red dotted line(s) are the pre- and/or post-irradiation minimum and/or maximum specification value as defined in the datasheet and/or test plan.



**RLAT Report
10-326 100808 R1.0**

**Radiation Assured Devices
5017 N. 30th Street
Colorado Springs, CO 80919
(719) 531-0800**

Table 5.50. Raw data for Output Voltage Swing High @+/-5V RL=500 #4 (V) versus total dose, including the statistical analysis, specification and the status of the testing (pass/fail).

Output Voltage Swing High @+/-5V RL=500 #4 (V)	Total Dose (krad(Si))											
	0	10	20	30	40	50	60	70	75	100	200	
Device												
1245	4.02E+00	4.02E+00	4.02E+00	4.02E+00	4.02E+00	4.02E+00	4.02E+00	4.02E+00	4.02E+00	4.02E+00	4.01E+00	4.01E+00
1246	4.02E+00	4.02E+00	4.02E+00	4.02E+00	4.02E+00	4.02E+00	4.02E+00	4.02E+00	4.02E+00	4.02E+00	4.02E+00	4.01E+00
1247	4.02E+00	4.02E+00	4.02E+00	4.02E+00	4.02E+00	4.02E+00	4.02E+00	4.02E+00	4.02E+00	4.02E+00	4.02E+00	4.01E+00
1248	4.02E+00	4.02E+00	4.02E+00	4.02E+00	4.02E+00	4.02E+00	4.02E+00	4.02E+00	4.02E+00	4.02E+00	4.02E+00	4.01E+00
1249	4.02E+00	4.02E+00	4.02E+00	4.02E+00	4.02E+00	4.02E+00	4.02E+00	4.02E+00	4.02E+00	4.02E+00	4.02E+00	4.01E+00
1250	4.02E+00	4.02E+00	4.02E+00	4.02E+00	4.02E+00	4.02E+00	4.02E+00	4.02E+00	4.02E+00	4.02E+00	4.02E+00	4.01E+00
1251	4.02E+00	4.02E+00	4.02E+00	4.02E+00	4.02E+00	4.02E+00	4.02E+00	4.02E+00	4.02E+00	4.02E+00	4.02E+00	4.01E+00
1261	4.02E+00	4.02E+00	4.02E+00	4.02E+00	4.02E+00	4.02E+00	4.02E+00	4.02E+00	4.02E+00	4.02E+00	4.02E+00	4.01E+00
1262	4.02E+00	4.02E+00	4.02E+00	4.02E+00	4.02E+00	4.02E+00	4.02E+00	4.02E+00	4.02E+00	4.02E+00	4.02E+00	4.01E+00
1263	4.02E+00	4.02E+00	4.02E+00	4.02E+00	4.02E+00	4.02E+00	4.02E+00	4.02E+00	4.02E+00	4.02E+00	4.01E+00	4.01E+00
1264	4.02E+00	4.02E+00	4.02E+00	4.02E+00	4.02E+00	4.02E+00	4.02E+00	4.02E+00	4.02E+00	4.02E+00	4.02E+00	4.02E+00
1265	4.02E+00	4.02E+00	4.02E+00	4.02E+00	4.02E+00	4.02E+00	4.02E+00	4.02E+00	4.02E+00	4.02E+00	4.02E+00	4.02E+00
Biased Statistics												
Average Biased	4.02E+00	4.02E+00	4.02E+00	4.02E+00	4.02E+00	4.02E+00	4.02E+00	4.02E+00	4.02E+00	4.02E+00	4.02E+00	4.01E+00
Std Dev Biased	1.42E-03	1.34E-03	1.57E-03	1.57E-03	1.51E-03	1.49E-03	1.33E-03	1.29E-03	1.65E-03	1.81E-03	2.32E-03	
Ps90%/90% (+KTL) Biased	4.03E+00	4.02E+00	4.02E+00	4.02E+00	4.02E+00	4.02E+00	4.02E+00	4.02E+00	4.02E+00	4.02E+00	4.02E+00	4.01E+00
Ps90%/90% (-KTL) Biased	4.02E+00	4.02E+00	4.02E+00	4.02E+00	4.02E+00	4.01E+00	4.02E+00	4.02E+00	4.01E+00	4.01E+00	4.00E+00	
Specification MIN	3.80E+00	3.80E+00	3.80E+00	3.80E+00	3.80E+00	3.70E+00	3.70E+00	3.70E+00	3.70E+00	3.60E+00	3.50E+00	
Status	PASS	PASS	PASS	PASS	PASS	PASS	PASS	PASS	PASS	PASS	PASS	PASS

An ISO 9001:2008 and DSCC Certified Company

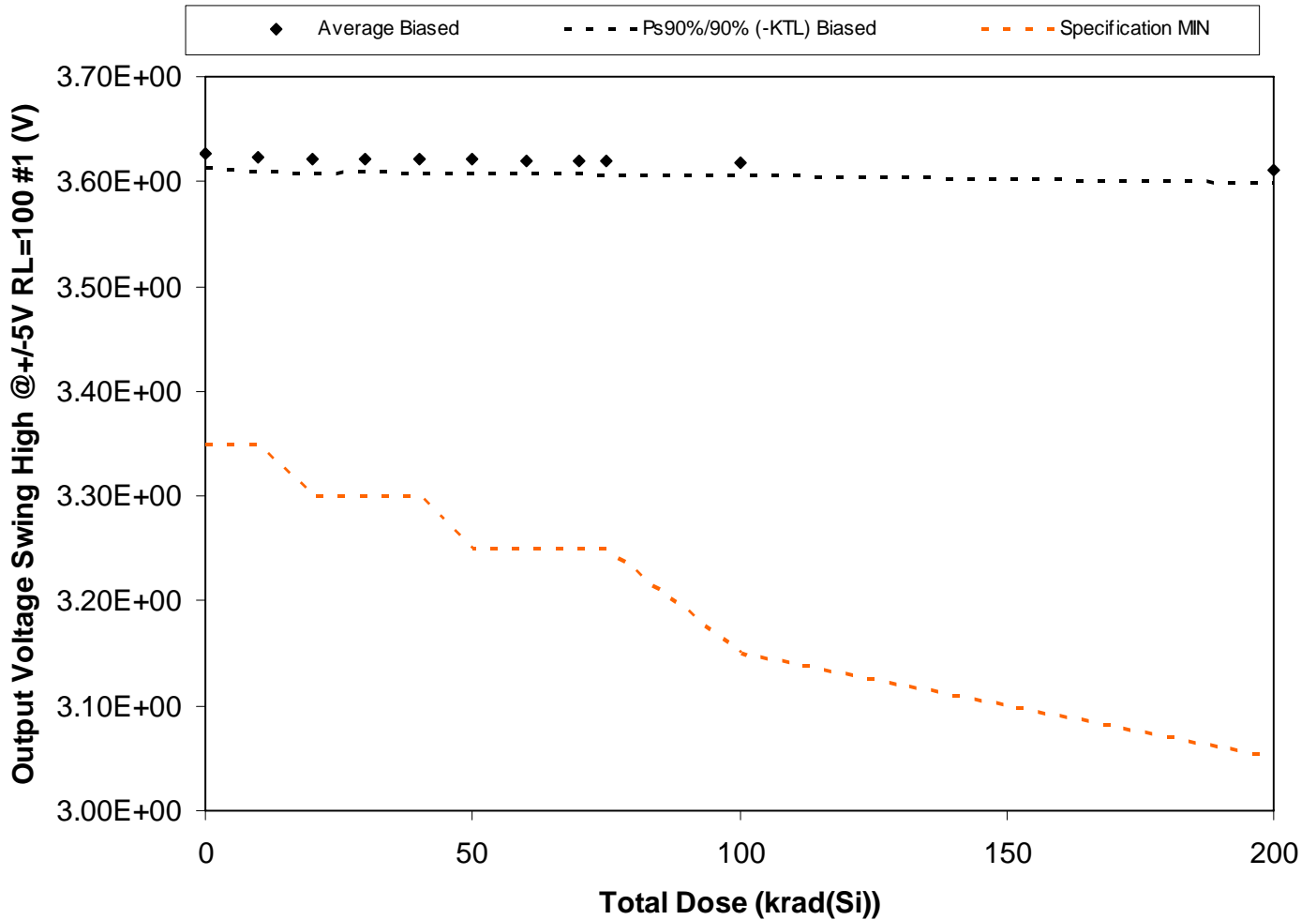

Figure 5.51. Plot of Output Voltage Swing High @ +/-5V RL=100 #1 (V) versus total dose. The solid diamonds are the average of the measured data points for the samples irradiated under electrical bias and the black lines (solid and/or dashed) are the average of the data points after application of the KTL statistics on the samples irradiated under electrical bias. The red dotted line(s) are the pre- and/or post-irradiation minimum and/or maximum specification value as defined in the datasheet and/or test plan.



**RLAT Report
10-326 100808 R1.0**

**Radiation Assured Devices
5017 N. 30th Street
Colorado Springs, CO 80919
(719) 531-0800**

Table 5.51. Raw data for Output Voltage Swing High @+/-5V RL=100 #1 (V) versus total dose, including the statistical analysis, specification and the status of the testing (pass/fail).

Output Voltage Swing High @+/-5V RL=100 #1 (V)	Total Dose (krad(Si))											
	0	10	20	30	40	50	60	70	75	100	200	
Device												
1245	3.62E+00	3.62E+00	3.62E+00	3.62E+00	3.62E+00	3.62E+00	3.62E+00	3.62E+00	3.62E+00	3.62E+00	3.61E+00	3.61E+00
1246	3.63E+00	3.62E+00	3.62E+00	3.62E+00	3.62E+00	3.62E+00	3.62E+00	3.62E+00	3.62E+00	3.62E+00	3.62E+00	3.61E+00
1247	3.63E+00	3.63E+00	3.63E+00	3.63E+00	3.63E+00	3.63E+00	3.63E+00	3.63E+00	3.63E+00	3.63E+00	3.62E+00	3.62E+00
1248	3.63E+00	3.63E+00	3.63E+00	3.63E+00	3.63E+00	3.63E+00	3.63E+00	3.63E+00	3.63E+00	3.63E+00	3.62E+00	3.62E+00
1249	3.64E+00	3.63E+00	3.63E+00	3.63E+00	3.63E+00	3.63E+00	3.63E+00	3.63E+00	3.63E+00	3.63E+00	3.63E+00	3.62E+00
1250	3.62E+00	3.62E+00	3.62E+00	3.62E+00	3.62E+00	3.62E+00	3.62E+00	3.62E+00	3.62E+00	3.61E+00	3.61E+00	3.61E+00
1251	3.62E+00	3.62E+00	3.62E+00	3.62E+00	3.61E+00	3.61E+00	3.61E+00	3.61E+00	3.61E+00	3.61E+00	3.61E+00	3.60E+00
1261	3.63E+00	3.62E+00	3.62E+00	3.62E+00	3.62E+00	3.62E+00	3.62E+00	3.62E+00	3.62E+00	3.62E+00	3.62E+00	3.61E+00
1262	3.62E+00	3.62E+00	3.62E+00	3.62E+00	3.62E+00	3.62E+00	3.62E+00	3.62E+00	3.62E+00	3.62E+00	3.62E+00	3.61E+00
1263	3.62E+00	3.62E+00	3.62E+00	3.62E+00	3.62E+00	3.62E+00	3.62E+00	3.62E+00	3.62E+00	3.61E+00	3.61E+00	3.61E+00
1264	3.63E+00	3.63E+00	3.63E+00	3.63E+00	3.63E+00	3.63E+00	3.63E+00	3.63E+00	3.63E+00	3.63E+00	3.63E+00	3.63E+00
1265	3.63E+00	3.63E+00	3.63E+00	3.63E+00	3.63E+00	3.63E+00	3.63E+00	3.63E+00	3.63E+00	3.63E+00	3.63E+00	3.63E+00
Biased Statistics												
Average Biased	3.63E+00	3.62E+00	3.62E+00	3.62E+00	3.62E+00	3.62E+00	3.62E+00	3.62E+00	3.62E+00	3.62E+00	3.62E+00	3.61E+00
Std Dev Biased	6.29E-03	6.26E-03	6.52E-03	6.41E-03	6.58E-03	6.27E-03	6.36E-03	6.02E-03	6.14E-03	6.13E-03	6.13E-03	5.78E-03
Ps90%/90% (+KTL) Biased	3.64E+00	3.64E+00	3.64E+00	3.64E+00	3.63E+00	3.63E+00	3.63E+00	3.63E+00	3.63E+00	3.63E+00	3.63E+00	3.62E+00
Ps90%/90% (-KTL) Biased	3.61E+00	3.61E+00	3.61E+00	3.61E+00	3.61E+00	3.61E+00	3.61E+00	3.61E+00	3.61E+00	3.61E+00	3.61E+00	3.60E+00
Specification MIN	3.35E+00	3.35E+00	3.30E+00	3.30E+00	3.30E+00	3.25E+00	3.25E+00	3.25E+00	3.25E+00	3.25E+00	3.15E+00	3.05E+00
Status	PASS	PASS	PASS	PASS	PASS	PASS	PASS	PASS	PASS	PASS	PASS	PASS

An ISO 9001:2008 and DSCC Certified Company

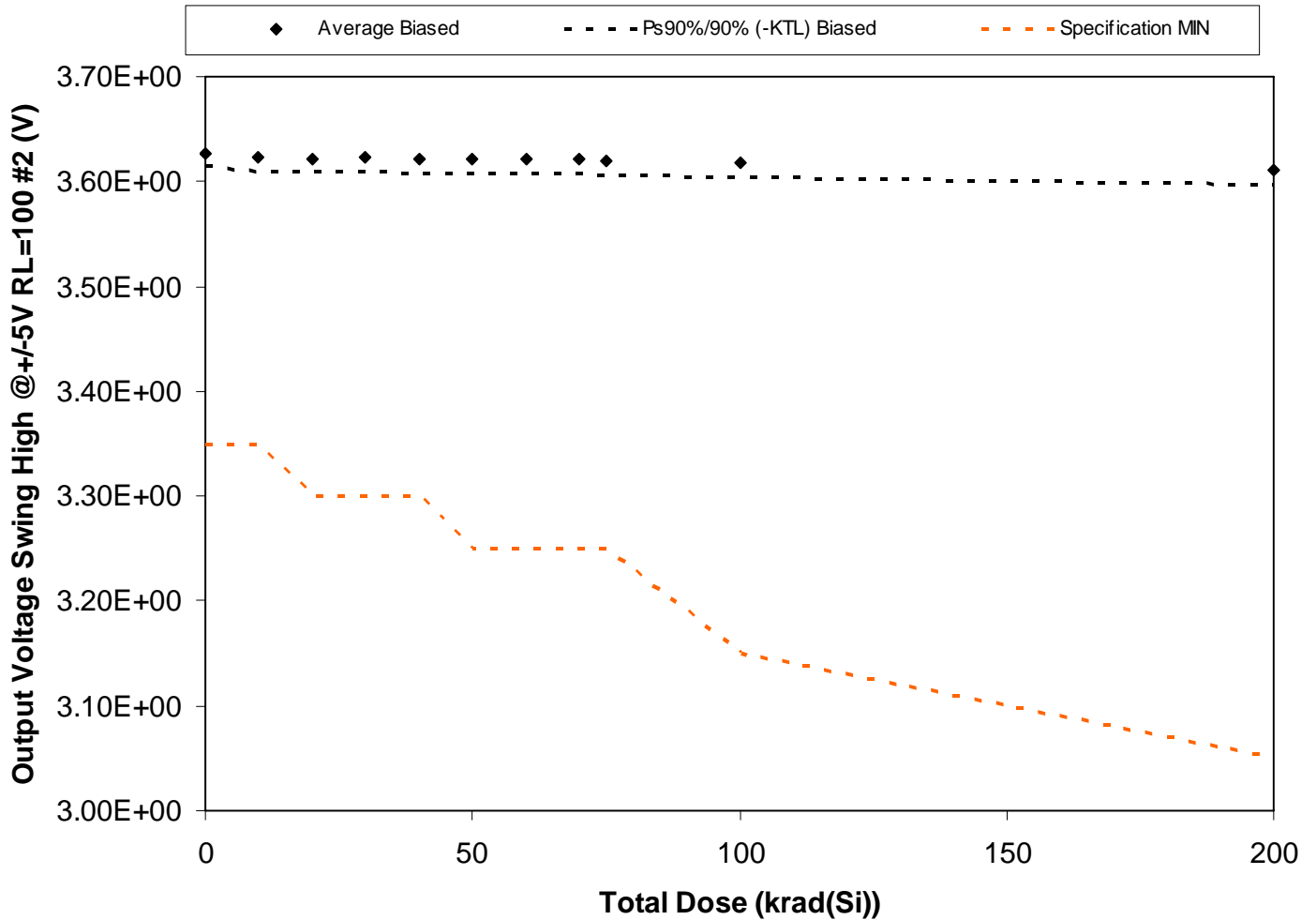

Figure 5.52. Plot of Output Voltage Swing High @ +/-5V RL=100 #2 (V) versus total dose. The solid diamonds are the average of the measured data points for the samples irradiated under electrical bias and the black lines (solid and/or dashed) are the average of the data points after application of the KTL statistics on the samples irradiated under electrical bias. The red dotted line(s) are the pre- and/or post-irradiation minimum and/or maximum specification value as defined in the datasheet and/or test plan.



**RLAT Report
10-326 100808 R1.0**

**Radiation Assured Devices
5017 N. 30th Street
Colorado Springs, CO 80919
(719) 531-0800**

Table 5.52. Raw data for Output Voltage Swing High @+/-5V RL=100 #2 (V) versus total dose, including the statistical analysis, specification and the status of the testing (pass/fail).

Output Voltage Swing High @+/-5V RL=100 #2 (V)	Total Dose (krad(Si))											
	0	10	20	30	40	50	60	70	75	100	200	
Device												
1245	3.62E+00	3.61E+00	3.61E+00	3.61E+00	3.61E+00	3.61E+00	3.61E+00	3.61E+00	3.61E+00	3.61E+00	3.61E+00	3.60E+00
1246	3.62E+00	3.62E+00	3.62E+00	3.62E+00	3.62E+00	3.62E+00	3.62E+00	3.62E+00	3.62E+00	3.62E+00	3.62E+00	3.61E+00
1247	3.63E+00	3.62E+00	3.62E+00	3.62E+00	3.62E+00	3.62E+00	3.62E+00	3.62E+00	3.62E+00	3.62E+00	3.62E+00	3.61E+00
1248	3.64E+00	3.64E+00	3.64E+00	3.64E+00	3.64E+00	3.64E+00	3.64E+00	3.63E+00	3.63E+00	3.63E+00	3.63E+00	3.63E+00
1249	3.63E+00	3.62E+00	3.62E+00	3.62E+00	3.62E+00	3.62E+00	3.62E+00	3.62E+00	3.62E+00	3.62E+00	3.62E+00	3.61E+00
1250	3.62E+00	3.62E+00	3.62E+00	3.62E+00	3.62E+00	3.62E+00	3.62E+00	3.62E+00	3.62E+00	3.62E+00	3.61E+00	3.61E+00
1251	3.62E+00	3.62E+00	3.62E+00	3.62E+00	3.62E+00	3.62E+00	3.62E+00	3.62E+00	3.62E+00	3.62E+00	3.62E+00	3.61E+00
1261	3.63E+00	3.62E+00	3.62E+00	3.62E+00	3.62E+00	3.62E+00	3.62E+00	3.62E+00	3.62E+00	3.62E+00	3.62E+00	3.61E+00
1262	3.63E+00	3.62E+00	3.62E+00	3.62E+00	3.62E+00	3.62E+00	3.62E+00	3.62E+00	3.62E+00	3.62E+00	3.62E+00	3.61E+00
1263	3.63E+00	3.63E+00	3.63E+00	3.63E+00	3.63E+00	3.63E+00	3.63E+00	3.63E+00	3.63E+00	3.63E+00	3.63E+00	3.62E+00
1264	3.62E+00	3.62E+00	3.62E+00	3.62E+00	3.62E+00	3.62E+00	3.62E+00	3.62E+00	3.62E+00	3.62E+00	3.62E+00	3.62E+00
1265	3.62E+00	3.62E+00	3.62E+00	3.62E+00	3.62E+00	3.62E+00	3.62E+00	3.62E+00	3.62E+00	3.62E+00	3.62E+00	3.62E+00
Biased Statistics												
Average Biased	3.63E+00	3.62E+00	3.62E+00	3.62E+00	3.62E+00	3.62E+00	3.62E+00	3.62E+00	3.62E+00	3.62E+00	3.62E+00	3.61E+00
Std Dev Biased	6.07E-03	6.36E-03	6.55E-03	6.67E-03	6.77E-03	6.83E-03	6.68E-03	6.67E-03	6.69E-03	6.73E-03	7.09E-03	
Ps90%/90% (+KTL) Biased	3.64E+00	3.64E+00	3.64E+00	3.64E+00	3.64E+00	3.64E+00	3.63E+00	3.63E+00	3.63E+00	3.63E+00	3.63E+00	3.63E+00
Ps90%/90% (-KTL) Biased	3.61E+00	3.61E+00	3.61E+00	3.61E+00	3.61E+00	3.61E+00	3.61E+00	3.61E+00	3.61E+00	3.61E+00	3.60E+00	3.60E+00
Specification MIN	3.35E+00	3.35E+00	3.30E+00	3.30E+00	3.30E+00	3.25E+00	3.25E+00	3.25E+00	3.25E+00	3.25E+00	3.15E+00	3.05E+00
Status	PASS	PASS	PASS	PASS	PASS	PASS	PASS	PASS	PASS	PASS	PASS	PASS

An ISO 9001:2008 and DSCC Certified Company

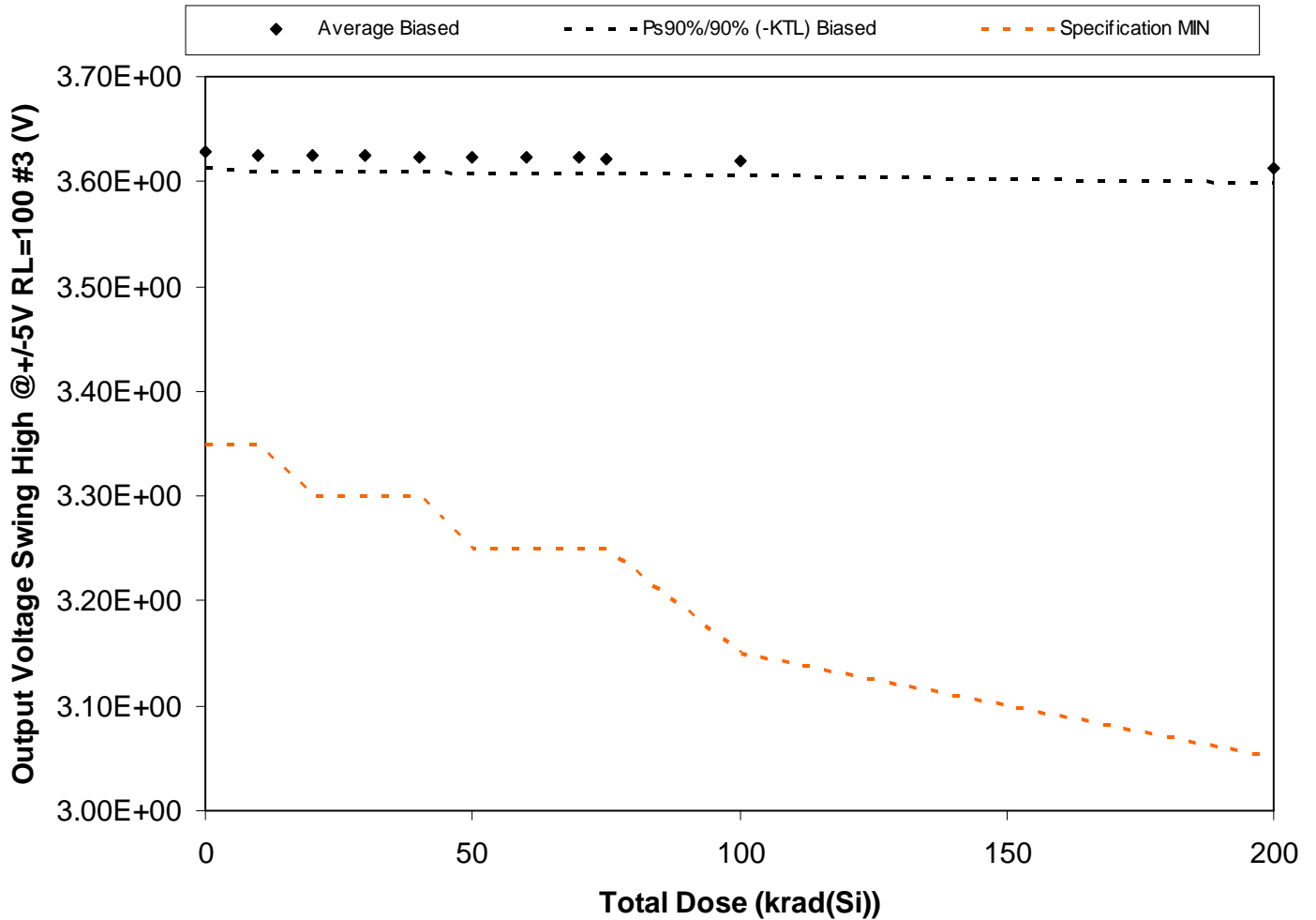

Figure 5.53. Plot of Output Voltage Swing High @ +/-5V RL=100 #3 (V) versus total dose. The solid diamonds are the average of the measured data points for the samples irradiated under electrical bias and the black lines (solid and/or dashed) are the average of the data points after application of the KTL statistics on the samples irradiated under electrical bias. The red dotted line(s) are the pre- and/or post-irradiation minimum and/or maximum specification value as defined in the datasheet and/or test plan.



**RLAT Report
10-326 100808 R1.0**

**Radiation Assured Devices
5017 N. 30th Street
Colorado Springs, CO 80919
(719) 531-0800**

Table 5.53. Raw data for Output Voltage Swing High @+/-5V RL=100 #3 (V) versus total dose, including the statistical analysis, specification and the status of the testing (pass/fail).

Output Voltage Swing High @+/-5V RL=100 #3 (V)	Total Dose (krad(Si))											
	0	10	20	30	40	50	60	70	75	100	200	
Device												
1245	3.62E+00	3.61E+00	3.61E+00	3.61E+00	3.61E+00	3.61E+00	3.61E+00	3.61E+00	3.61E+00	3.61E+00	3.61E+00	3.60E+00
1246	3.63E+00	3.62E+00	3.62E+00	3.62E+00	3.62E+00	3.62E+00	3.62E+00	3.62E+00	3.62E+00	3.62E+00	3.62E+00	3.61E+00
1247	3.63E+00	3.62E+00	3.62E+00	3.62E+00	3.62E+00	3.62E+00	3.62E+00	3.62E+00	3.62E+00	3.62E+00	3.62E+00	3.61E+00
1248	3.64E+00	3.64E+00	3.64E+00	3.64E+00	3.64E+00	3.64E+00	3.64E+00	3.64E+00	3.64E+00	3.64E+00	3.64E+00	3.63E+00
1249	3.63E+00	3.62E+00	3.62E+00	3.62E+00	3.62E+00	3.62E+00	3.62E+00	3.62E+00	3.62E+00	3.62E+00	3.62E+00	3.61E+00
1250	3.62E+00	3.62E+00	3.62E+00	3.62E+00	3.62E+00	3.62E+00	3.62E+00	3.62E+00	3.62E+00	3.62E+00	3.61E+00	3.61E+00
1251	3.63E+00	3.62E+00	3.62E+00	3.62E+00	3.62E+00	3.62E+00	3.62E+00	3.62E+00	3.62E+00	3.62E+00	3.62E+00	3.61E+00
1261	3.63E+00	3.63E+00	3.62E+00	3.62E+00	3.62E+00	3.62E+00	3.62E+00	3.62E+00	3.62E+00	3.62E+00	3.62E+00	3.61E+00
1262	3.63E+00	3.62E+00	3.62E+00	3.62E+00	3.62E+00	3.62E+00	3.62E+00	3.62E+00	3.62E+00	3.62E+00	3.62E+00	3.61E+00
1263	3.64E+00	3.63E+00	3.63E+00	3.63E+00	3.63E+00	3.63E+00	3.63E+00	3.63E+00	3.63E+00	3.63E+00	3.63E+00	3.62E+00
1264	3.63E+00	3.62E+00	3.62E+00	3.62E+00	3.62E+00	3.62E+00	3.62E+00	3.62E+00	3.62E+00	3.62E+00	3.62E+00	3.62E+00
1265	3.62E+00	3.62E+00	3.62E+00	3.62E+00	3.62E+00	3.62E+00	3.62E+00	3.62E+00	3.62E+00	3.62E+00	3.62E+00	3.62E+00
Biased Statistics												
Average Biased	3.63E+00	3.62E+00	3.62E+00	3.62E+00	3.62E+00	3.62E+00	3.62E+00	3.62E+00	3.62E+00	3.62E+00	3.62E+00	3.61E+00
Std Dev Biased	7.18E-03	7.29E-03	7.20E-03	7.52E-03	7.10E-03	7.29E-03	7.06E-03	7.06E-03	6.79E-03	6.93E-03	6.72E-03	
Ps90%/90% (+KTL) Biased	3.64E+00	3.64E+00	3.64E+00	3.64E+00	3.64E+00	3.64E+00	3.64E+00	3.64E+00	3.64E+00	3.64E+00	3.63E+00	3.63E+00
Ps90%/90% (-KTL) Biased	3.61E+00	3.61E+00	3.61E+00	3.61E+00	3.61E+00	3.61E+00	3.61E+00	3.61E+00	3.61E+00	3.61E+00	3.61E+00	3.60E+00
Specification MIN	3.35E+00	3.35E+00	3.30E+00	3.30E+00	3.30E+00	3.25E+00	3.25E+00	3.25E+00	3.25E+00	3.15E+00	3.05E+00	
Status	PASS	PASS	PASS	PASS	PASS	PASS	PASS	PASS	PASS	PASS	PASS	PASS

An ISO 9001:2008 and DSCC Certified Company

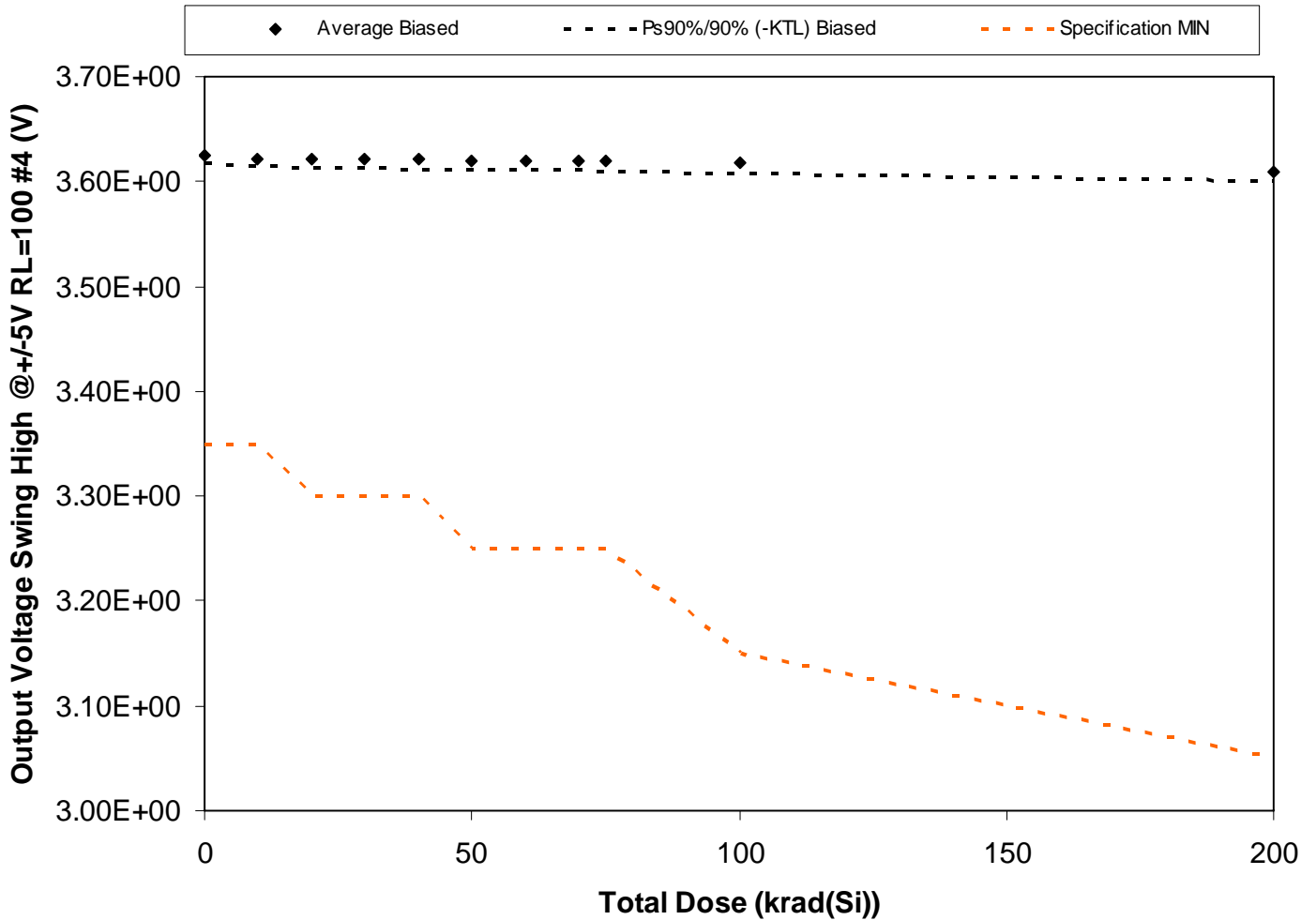

Figure 5.54. Plot of Output Voltage Swing High @ +/-5V RL=100 #4 (V) versus total dose. The solid diamonds are the average of the measured data points for the samples irradiated under electrical bias and the black lines (solid and/or dashed) are the average of the data points after application of the KTL statistics on the samples irradiated under electrical bias. The red dotted line(s) are the pre- and/or post-irradiation minimum and/or maximum specification value as defined in the datasheet and/or test plan.



**RLAT Report
10-326 100808 R1.0**

**Radiation Assured Devices
5017 N. 30th Street
Colorado Springs, CO 80919
(719) 531-0800**

Table 5.54. Raw data for Output Voltage Swing High @+/-5V RL=100 #4 (V) versus total dose, including the statistical analysis, specification and the status of the testing (pass/fail).

Output Voltage Swing High @+/-5V RL=100 #4 (V)	Total Dose (krad(Si))											
	0	10	20	30	40	50	60	70	75	100	200	
Device												
1245	3.62E+00	3.62E+00	3.62E+00	3.62E+00	3.62E+00	3.62E+00	3.62E+00	3.62E+00	3.62E+00	3.62E+00	3.61E+00	3.61E+00
1246	3.63E+00	3.62E+00	3.62E+00	3.62E+00	3.62E+00	3.62E+00	3.62E+00	3.62E+00	3.62E+00	3.62E+00	3.62E+00	3.61E+00
1247	3.63E+00	3.63E+00	3.63E+00	3.63E+00	3.63E+00	3.63E+00	3.63E+00	3.63E+00	3.62E+00	3.62E+00	3.62E+00	3.62E+00
1248	3.63E+00	3.63E+00	3.63E+00	3.63E+00	3.63E+00	3.63E+00	3.62E+00	3.62E+00	3.62E+00	3.62E+00	3.62E+00	3.61E+00
1249	3.63E+00	3.63E+00	3.63E+00	3.63E+00	3.63E+00	3.63E+00	3.63E+00	3.63E+00	3.63E+00	3.63E+00	3.63E+00	3.62E+00
1250	3.62E+00	3.62E+00	3.62E+00	3.62E+00	3.62E+00	3.62E+00	3.62E+00	3.62E+00	3.62E+00	3.61E+00	3.61E+00	3.60E+00
1251	3.62E+00	3.62E+00	3.62E+00	3.62E+00	3.62E+00	3.62E+00	3.62E+00	3.62E+00	3.62E+00	3.62E+00	3.62E+00	3.61E+00
1261	3.63E+00	3.62E+00	3.62E+00	3.62E+00	3.62E+00	3.62E+00	3.62E+00	3.62E+00	3.62E+00	3.62E+00	3.62E+00	3.61E+00
1262	3.63E+00	3.62E+00	3.62E+00	3.62E+00	3.62E+00	3.62E+00	3.62E+00	3.62E+00	3.62E+00	3.62E+00	3.62E+00	3.61E+00
1263	3.62E+00	3.62E+00	3.62E+00	3.62E+00	3.62E+00	3.62E+00	3.62E+00	3.62E+00	3.62E+00	3.61E+00	3.61E+00	3.60E+00
1264	3.63E+00	3.63E+00	3.63E+00	3.63E+00	3.63E+00	3.63E+00	3.63E+00	3.63E+00	3.63E+00	3.63E+00	3.63E+00	3.63E+00
1265	3.63E+00	3.63E+00	3.63E+00	3.63E+00	3.63E+00	3.63E+00	3.63E+00	3.63E+00	3.63E+00	3.63E+00	3.63E+00	3.63E+00
Biased Statistics												
Average Biased	3.63E+00	3.62E+00	3.62E+00	3.62E+00	3.62E+00	3.62E+00	3.62E+00	3.62E+00	3.62E+00	3.62E+00	3.62E+00	3.61E+00
Std Dev Biased	4.03E-03	4.07E-03	4.50E-03	4.53E-03	4.71E-03	4.48E-03	4.58E-03	4.45E-03	4.61E-03	4.58E-03	4.81E-03	
Ps90%/90% (+KTL) Biased	3.63E+00	3.63E+00	3.63E+00	3.63E+00	3.63E+00	3.63E+00	3.63E+00	3.63E+00	3.63E+00	3.63E+00	3.63E+00	3.62E+00
Ps90%/90% (-KTL) Biased	3.62E+00	3.61E+00	3.61E+00	3.61E+00	3.61E+00	3.61E+00	3.61E+00	3.61E+00	3.61E+00	3.61E+00	3.61E+00	3.60E+00
Specification MIN	3.35E+00	3.35E+00	3.30E+00	3.30E+00	3.30E+00	3.25E+00	3.25E+00	3.25E+00	3.25E+00	3.15E+00	3.05E+00	
Status	PASS	PASS	PASS	PASS	PASS	PASS	PASS	PASS	PASS	PASS	PASS	PASS

An ISO 9001:2008 and DSCC Certified Company

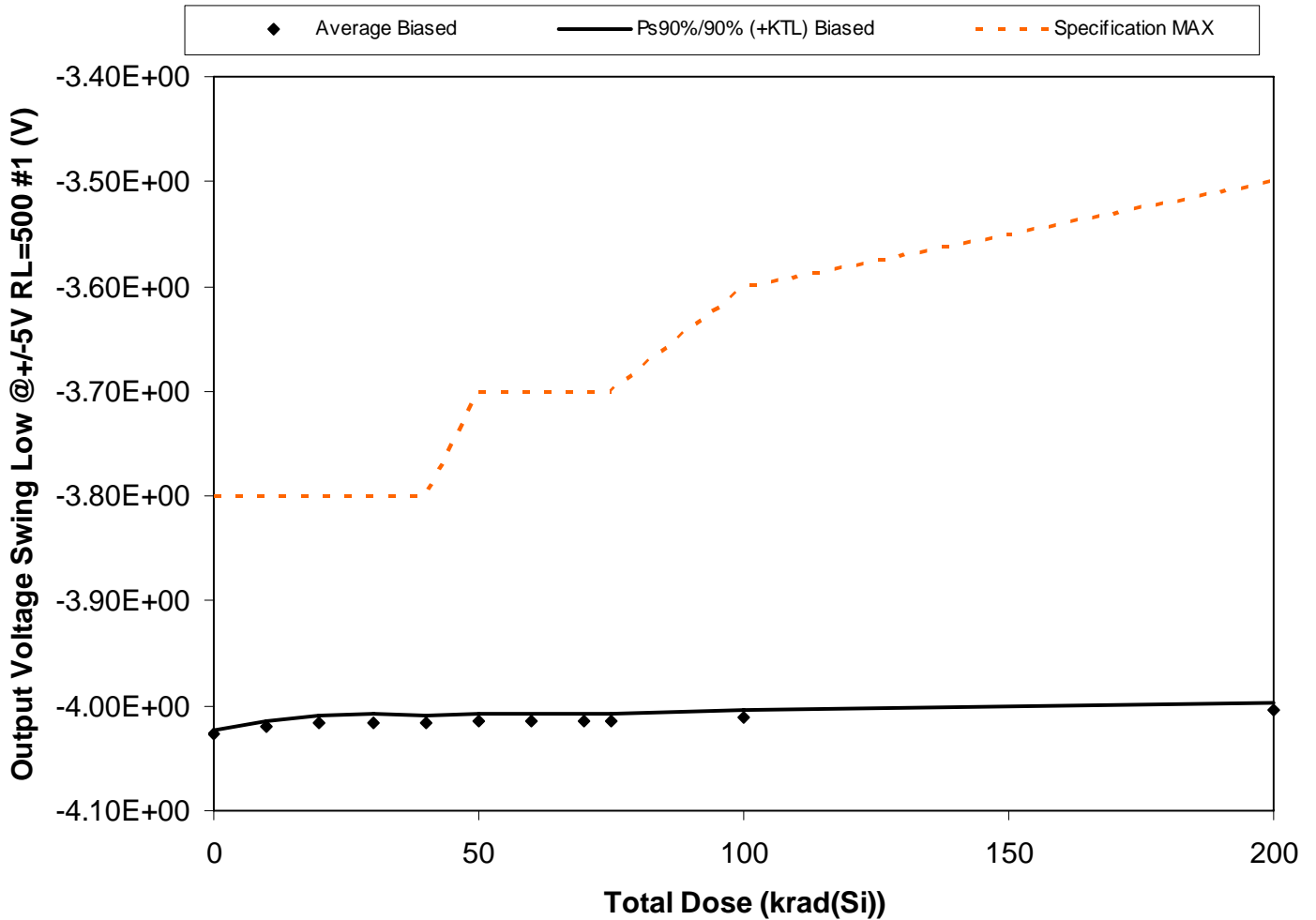

Figure 5.55. Plot of Output Voltage Swing Low @ +/-5V RL=500 #1 (V) versus total dose. The solid diamonds are the average of the measured data points for the samples irradiated under electrical bias and the black lines (solid and/or dashed) are the average of the data points after application of the KTL statistics on the samples irradiated under electrical bias. The red dotted line(s) are the pre- and/or post-irradiation minimum and/or maximum specification value as defined in the datasheet and/or test plan.



**RLAT Report
10-326 100808 R1.0**

**Radiation Assured Devices
5017 N. 30th Street
Colorado Springs, CO 80919
(719) 531-0800**

Table 5.55. Raw data for Output Voltage Swing Low @+/-5V RL=500 #1 (V) versus total dose, including the statistical analysis, specification and the status of the testing (pass/fail).

Output Voltage Swing Low @+/-5V RL=500 #1 (V)	Total Dose (krad(Si))											
	0	10	20	30	40	50	60	70	75	100	200	
Device												
1245	-4.02E+00	-4.02E+00	-4.02E+00	-4.02E+00	-4.02E+00	-4.01E+00	-4.01E+00	-4.01E+00	-4.01E+00	-4.01E+00	-4.01E+00	-4.01E+00
1246	-4.03E+00	-4.02E+00	-4.01E+00	-4.01E+00	-4.01E+00	-4.01E+00	-4.01E+00	-4.01E+00	-4.01E+00	-4.01E+00	-4.01E+00	-4.00E+00
1247	-4.03E+00	-4.02E+00	-4.02E+00	-4.02E+00	-4.02E+00	-4.02E+00	-4.02E+00	-4.02E+00	-4.01E+00	-4.01E+00	-4.01E+00	-4.00E+00
1248	-4.03E+00	-4.03E+00	-4.03E+00	-4.03E+00	-4.02E+00	-4.02E+00	-4.02E+00	-4.02E+00	-4.02E+00	-4.02E+00	-4.02E+00	-4.01E+00
1249	-4.03E+00	-4.02E+00	-4.02E+00	-4.02E+00	-4.02E+00	-4.02E+00	-4.02E+00	-4.02E+00	-4.02E+00	-4.02E+00	-4.02E+00	-4.01E+00
1250	-4.03E+00	-4.02E+00	-4.01E+00	-4.01E+00	-4.01E+00	-4.01E+00	-4.01E+00	-4.01E+00	-4.01E+00	-4.01E+00	-4.01E+00	-4.00E+00
1251	-4.03E+00	-4.02E+00	-4.01E+00	-4.01E+00	-4.01E+00	-4.01E+00	-4.01E+00	-4.01E+00	-4.01E+00	-4.01E+00	-4.01E+00	-4.00E+00
1261	-4.03E+00	-4.02E+00	-4.02E+00	-4.02E+00	-4.02E+00	-4.01E+00	-4.01E+00	-4.01E+00	-4.01E+00	-4.01E+00	-4.01E+00	-4.00E+00
1262	-4.03E+00	-4.02E+00	-4.02E+00	-4.02E+00	-4.02E+00	-4.02E+00	-4.02E+00	-4.02E+00	-4.01E+00	-4.01E+00	-4.01E+00	-4.00E+00
1263	-4.02E+00	-4.02E+00	-4.01E+00	-4.01E+00	-4.01E+00	-4.01E+00	-4.01E+00	-4.01E+00	-4.01E+00	-4.01E+00	-4.01E+00	-4.00E+00
1264	-4.03E+00	-4.02E+00	-4.02E+00	-4.02E+00	-4.02E+00	-4.02E+00	-4.02E+00	-4.02E+00	-4.03E+00	-4.02E+00	-4.03E+00	-4.03E+00
1265	-4.02E+00	-4.02E+00	-4.02E+00	-4.02E+00	-4.02E+00	-4.02E+00	-4.02E+00	-4.02E+00	-4.02E+00	-4.02E+00	-4.02E+00	-4.02E+00
Biased Statistics												
Average Biased	-4.03E+00	-4.02E+00	-4.02E+00	-4.02E+00	-4.02E+00	-4.02E+00	-4.01E+00	-4.01E+00	-4.01E+00	-4.01E+00	-4.01E+00	-4.00E+00
Std Dev Biased	1.96E-03	2.80E-03	3.60E-03	3.74E-03	3.41E-03	3.41E-03	3.23E-03	3.28E-03	3.40E-03	3.26E-03	3.55E-03	
Ps90%/90% (+KTL) Biased	-4.02E+00	-4.01E+00	-4.01E+00	-4.01E+00	-4.01E+00	-4.01E+00	-4.01E+00	-4.01E+00	-4.01E+00	-4.00E+00	-4.00E+00	
Ps90%/90% (-KTL) Biased	-4.03E+00	-4.03E+00	-4.02E+00	-4.02E+00	-4.02E+00	-4.02E+00	-4.02E+00	-4.02E+00	-4.02E+00	-4.02E+00	-4.01E+00	
Specification MAX	-3.80E+00	-3.80E+00	-3.80E+00	-3.80E+00	-3.80E+00	-3.70E+00	-3.70E+00	-3.70E+00	-3.70E+00	-3.60E+00	-3.50E+00	
Status	PASS	PASS	PASS	PASS	PASS	PASS	PASS	PASS	PASS	PASS	PASS	PASS

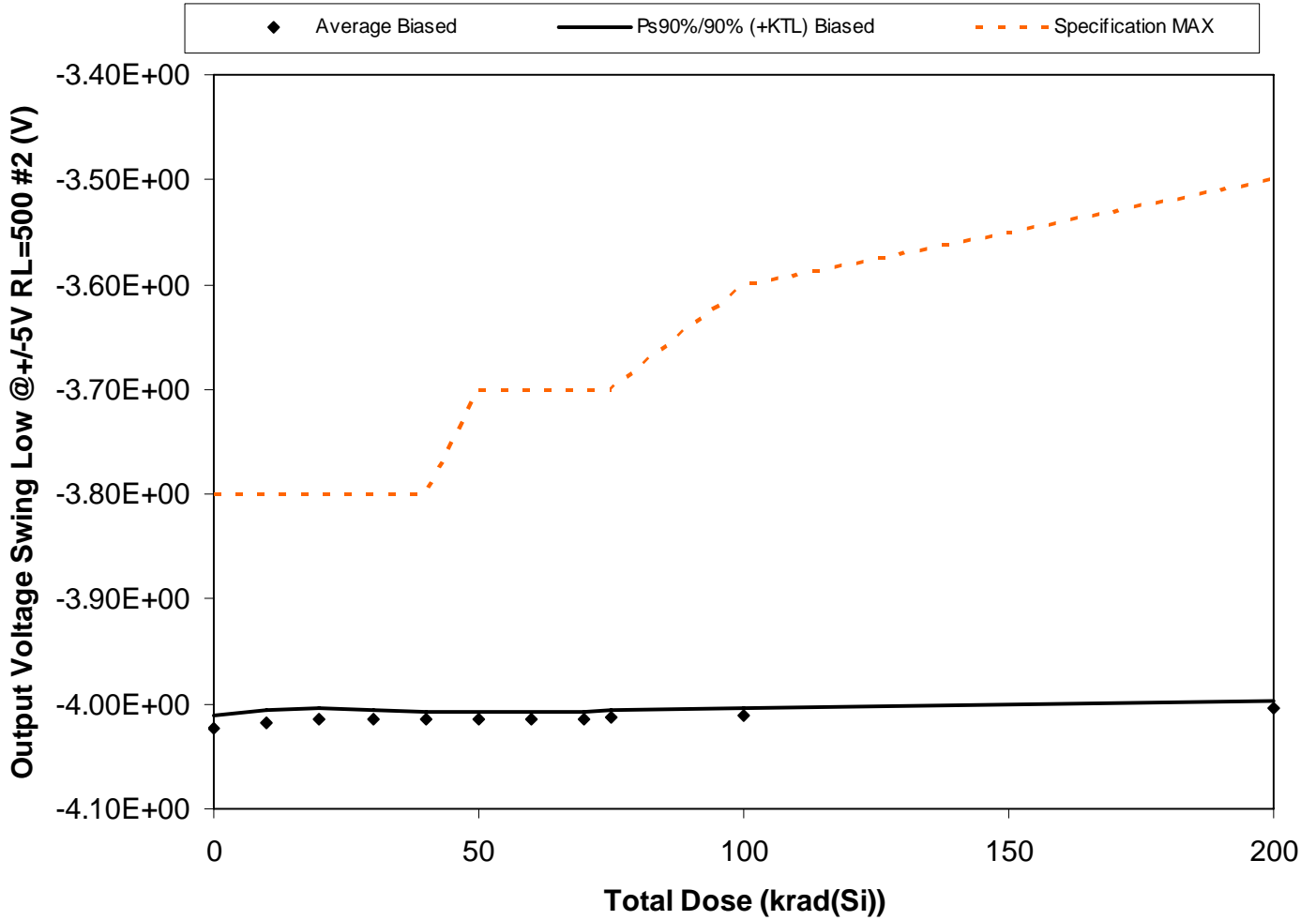

Figure 5.56. Plot of Output Voltage Swing Low @ +/-5V RL=500 #2 (V) versus total dose. The solid diamonds are the average of the measured data points for the samples irradiated under electrical bias and the black lines (solid and/or dashed) are the average of the data points after application of the KTL statistics on the samples irradiated under electrical bias. The red dotted line(s) are the pre- and/or post-irradiation minimum and/or maximum specification value as defined in the datasheet and/or test plan.



**RLAT Report
10-326 100808 R1.0**

**Radiation Assured Devices
5017 N. 30th Street
Colorado Springs, CO 80919
(719) 531-0800**

Table 5.56. Raw data for Output Voltage Swing Low @+/-5V RL=500 #2 (V) versus total dose, including the statistical analysis, specification and the status of the testing (pass/fail).

Output Voltage Swing Low @+/-5V RL=500 #2 (V)	Total Dose (krad(Si))											
	0	10	20	30	40	50	60	70	75	100	200	
Device												
1245	-4.02E+00	-4.01E+00	-4.01E+00	-4.01E+00	-4.01E+00	-4.01E+00	-4.01E+00	-4.01E+00	-4.01E+00	-4.01E+00	-4.01E+00	-4.00E+00
1246	-4.02E+00	-4.01E+00	-4.01E+00	-4.01E+00	-4.01E+00	-4.01E+00	-4.01E+00	-4.01E+00	-4.01E+00	-4.01E+00	-4.01E+00	-4.00E+00
1247	-4.03E+00	-4.02E+00	-4.02E+00	-4.02E+00	-4.02E+00	-4.01E+00	-4.01E+00	-4.01E+00	-4.01E+00	-4.01E+00	-4.01E+00	-4.00E+00
1248	-4.03E+00	-4.03E+00	-4.03E+00	-4.03E+00	-4.02E+00	-4.02E+00	-4.02E+00	-4.02E+00	-4.02E+00	-4.02E+00	-4.02E+00	-4.01E+00
1249	-4.03E+00	-4.02E+00	-4.02E+00	-4.01E+00	-4.01E+00	-4.01E+00	-4.01E+00	-4.01E+00	-4.01E+00	-4.01E+00	-4.01E+00	-4.00E+00
1250	-4.02E+00	-4.02E+00	-4.01E+00	-4.01E+00	-4.01E+00	-4.01E+00	-4.01E+00	-4.01E+00	-4.01E+00	-4.01E+00	-4.01E+00	-4.00E+00
1251	-4.03E+00	-4.02E+00	-4.01E+00	-4.01E+00	-4.01E+00	-4.01E+00	-4.01E+00	-4.01E+00	-4.01E+00	-4.01E+00	-4.01E+00	-4.00E+00
1261	-4.03E+00	-4.02E+00	-4.02E+00	-4.01E+00	-4.02E+00	-4.02E+00	-4.02E+00	-4.02E+00	-4.02E+00	-4.01E+00	-4.01E+00	-4.01E+00
1262	-4.01E+00	-4.01E+00	-4.01E+00	-4.01E+00	-4.01E+00	-4.01E+00	-4.01E+00	-4.01E+00	-4.01E+00	-4.01E+00	-4.01E+00	-4.00E+00
1263	-4.03E+00	-4.02E+00	-4.02E+00	-4.02E+00	-4.02E+00	-4.02E+00	-4.02E+00	-4.02E+00	-4.02E+00	-4.02E+00	-4.02E+00	-4.01E+00
1264	-4.03E+00	-4.02E+00	-4.02E+00	-4.02E+00	-4.02E+00	-4.02E+00	-4.02E+00	-4.02E+00	-4.02E+00	-4.02E+00	-4.02E+00	-4.02E+00
1265	-4.02E+00	-4.02E+00	-4.02E+00	-4.02E+00	-4.02E+00	-4.02E+00	-4.02E+00	-4.02E+00	-4.02E+00	-4.02E+00	-4.02E+00	-4.02E+00
Biased Statistics												
Average Biased	-4.02E+00	-4.02E+00	-4.02E+00	-4.01E+00	-4.01E+00	-4.01E+00	-4.01E+00	-4.01E+00	-4.01E+00	-4.01E+00	-4.01E+00	-4.00E+00
Std Dev Biased	5.74E-03	5.79E-03	5.12E-03	4.27E-03	3.97E-03	3.60E-03	3.53E-03	3.57E-03	3.33E-03	3.58E-03	3.53E-03	3.53E-03
Ps90%/90% (+KTL) Biased	-4.01E+00	-4.01E+00	-4.00E+00	-4.01E+00	-4.01E+00	-4.01E+00	-4.01E+00	-4.01E+00	-4.01E+00	-4.00E+00	-4.00E+00	-4.00E+00
Ps90%/90% (-KTL) Biased	-4.04E+00	-4.03E+00	-4.03E+00	-4.02E+00	-4.02E+00	-4.02E+00	-4.02E+00	-4.02E+00	-4.02E+00	-4.02E+00	-4.02E+00	-4.01E+00
Specification MAX	-3.80E+00	-3.80E+00	-3.80E+00	-3.80E+00	-3.80E+00	-3.70E+00	-3.70E+00	-3.70E+00	-3.70E+00	-3.60E+00	-3.50E+00	-3.50E+00
Status	PASS	PASS	PASS	PASS	PASS	PASS	PASS	PASS	PASS	PASS	PASS	PASS

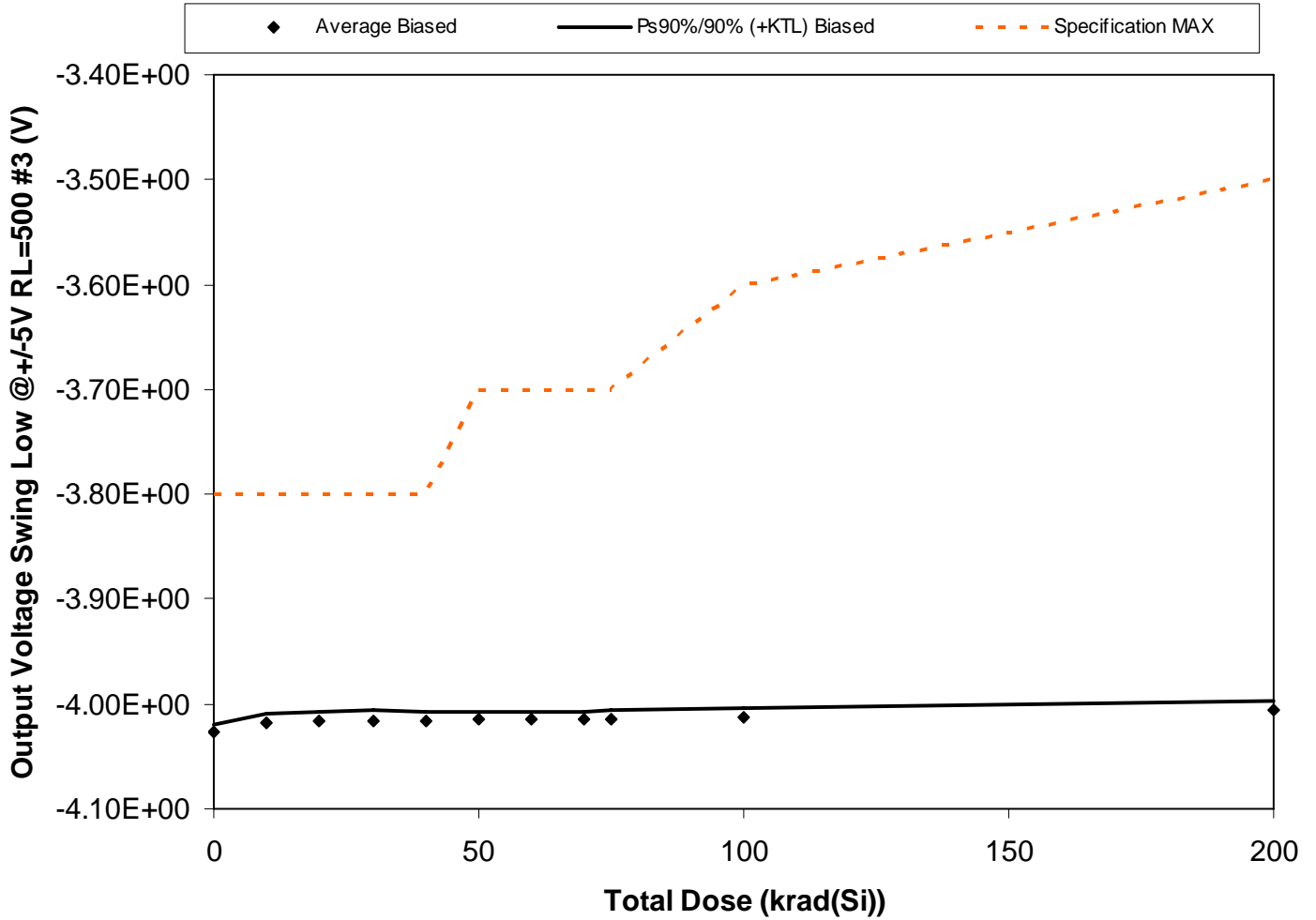

Figure 5.57. Plot of Output Voltage Swing Low @ +/-5V RL=500 #3 (V) versus total dose. The solid diamonds are the average of the measured data points for the samples irradiated under electrical bias and the black lines (solid and/or dashed) are the average of the data points after application of the KTL statistics on the samples irradiated under electrical bias. The red dotted line(s) are the pre- and/or post-irradiation minimum and/or maximum specification value as defined in the datasheet and/or test plan.



**RLAT Report
10-326 100808 R1.0**

**Radiation Assured Devices
5017 N. 30th Street
Colorado Springs, CO 80919
(719) 531-0800**

Table 5.57. Raw data for Output Voltage Swing Low @+/-5V RL=500 #3 (V) versus total dose, including the statistical analysis, specification and the status of the testing (pass/fail).

Output Voltage Swing Low @+/-5V RL=500 #3 (V)	Total Dose (krad(Si))											
	0	10	20	30	40	50	60	70	75	100	200	
Device												
1245	-4.02E+00	-4.01E+00	-4.01E+00	-4.01E+00	-4.01E+00	-4.01E+00	-4.01E+00	-4.01E+00	-4.01E+00	-4.01E+00	-4.01E+00	-4.00E+00
1246	-4.03E+00	-4.02E+00	-4.01E+00	-4.01E+00	-4.01E+00	-4.01E+00	-4.01E+00	-4.01E+00	-4.01E+00	-4.01E+00	-4.01E+00	-4.00E+00
1247	-4.03E+00	-4.02E+00	-4.02E+00	-4.02E+00	-4.02E+00	-4.01E+00	-4.01E+00	-4.01E+00	-4.01E+00	-4.01E+00	-4.01E+00	-4.00E+00
1248	-4.03E+00	-4.03E+00	-4.03E+00	-4.03E+00	-4.03E+00	-4.02E+00	-4.02E+00	-4.02E+00	-4.02E+00	-4.02E+00	-4.02E+00	-4.01E+00
1249	-4.03E+00	-4.02E+00	-4.02E+00	-4.02E+00	-4.01E+00	-4.01E+00	-4.01E+00	-4.01E+00	-4.01E+00	-4.01E+00	-4.01E+00	-4.00E+00
1250	-4.02E+00	-4.02E+00	-4.02E+00	-4.01E+00	-4.01E+00	-4.01E+00	-4.01E+00	-4.01E+00	-4.01E+00	-4.01E+00	-4.01E+00	-4.00E+00
1251	-4.03E+00	-4.02E+00	-4.01E+00	-4.01E+00	-4.01E+00	-4.01E+00	-4.02E+00	-4.01E+00	-4.01E+00	-4.01E+00	-4.01E+00	-4.01E+00
1261	-4.03E+00	-4.02E+00	-4.02E+00	-4.02E+00	-4.02E+00	-4.02E+00	-4.02E+00	-4.02E+00	-4.02E+00	-4.02E+00	-4.02E+00	-4.01E+00
1262	-4.03E+00	-4.02E+00	-4.02E+00	-4.02E+00	-4.02E+00	-4.02E+00	-4.02E+00	-4.02E+00	-4.02E+00	-4.02E+00	-4.01E+00	-4.01E+00
1263	-4.03E+00	-4.02E+00	-4.02E+00	-4.02E+00	-4.02E+00	-4.02E+00	-4.02E+00	-4.02E+00	-4.02E+00	-4.02E+00	-4.02E+00	-4.01E+00
1264	-4.03E+00	-4.03E+00	-4.02E+00	-4.02E+00	-4.02E+00	-4.03E+00	-4.03E+00	-4.03E+00	-4.03E+00	-4.03E+00	-4.03E+00	-4.03E+00
1265	-4.02E+00	-4.02E+00	-4.02E+00	-4.02E+00	-4.02E+00	-4.02E+00	-4.02E+00	-4.02E+00	-4.02E+00	-4.02E+00	-4.02E+00	-4.02E+00
Biased Statistics												
Average Biased	-4.03E+00	-4.02E+00	-4.02E+00	-4.02E+00	-4.02E+00	-4.02E+00	-4.02E+00	-4.01E+00	-4.01E+00	-4.01E+00	-4.01E+00	-4.01E+00
Std Dev Biased	3.31E-03	4.48E-03	4.64E-03	4.47E-03	4.06E-03	3.84E-03	3.57E-03	3.63E-03	3.79E-03	3.63E-03	3.78E-03	3.78E-03
Ps90%/90% (+KTL) Biased	-4.02E+00	-4.01E+00	-4.01E+00	-4.01E+00	-4.01E+00	-4.01E+00	-4.01E+00	-4.01E+00	-4.01E+00	-4.00E+00	-4.00E+00	-4.00E+00
Ps90%/90% (-KTL) Biased	-4.03E+00	-4.03E+00	-4.03E+00	-4.03E+00	-4.02E+00	-4.02E+00	-4.02E+00	-4.02E+00	-4.02E+00	-4.02E+00	-4.02E+00	-4.01E+00
Specification MAX	-3.80E+00	-3.80E+00	-3.80E+00	-3.80E+00	-3.80E+00	-3.70E+00	-3.70E+00	-3.70E+00	-3.70E+00	-3.60E+00	-3.50E+00	-3.50E+00
Status	PASS	PASS	PASS	PASS	PASS	PASS	PASS	PASS	PASS	PASS	PASS	PASS

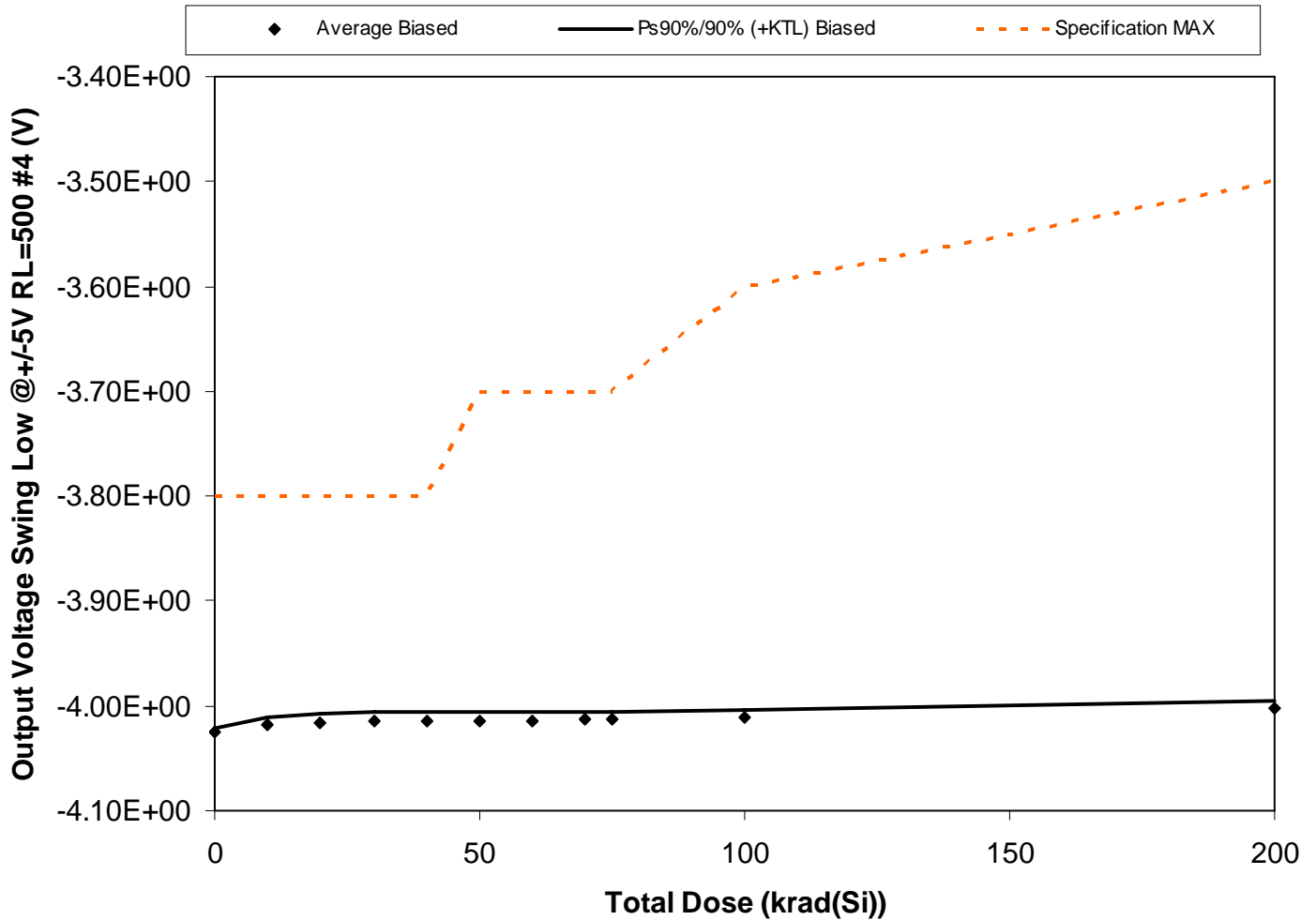

Figure 5.58. Plot of Output Voltage Swing Low @ +/-5V RL=500 #4 (V) versus total dose. The solid diamonds are the average of the measured data points for the samples irradiated under electrical bias and the black lines (solid and/or dashed) are the average of the data points after application of the KTL statistics on the samples irradiated under electrical bias. The red dotted line(s) are the pre- and/or post-irradiation minimum and/or maximum specification value as defined in the datasheet and/or test plan.



**RLAT Report
10-326 100808 R1.0**

**Radiation Assured Devices
5017 N. 30th Street
Colorado Springs, CO 80919
(719) 531-0800**

Table 5.58. Raw data for Output Voltage Swing Low @+/-5V RL=500 #4 (V) versus total dose, including the statistical analysis, specification and the status of the testing (pass/fail).

Output Voltage Swing Low @+/-5V RL=500 #4 (V)	Total Dose (krad(Si))											
	0	10	20	30	40	50	60	70	75	100	200	
Device												
1245	-4.02E+00	-4.02E+00	-4.01E+00	-4.01E+00	-4.01E+00	-4.01E+00	-4.01E+00	-4.01E+00	-4.01E+00	-4.01E+00	-4.01E+00	-4.00E+00
1246	-4.03E+00	-4.02E+00	-4.01E+00	-4.01E+00	-4.02E+00	-4.01E+00	-4.01E+00	-4.01E+00	-4.01E+00	-4.01E+00	-4.01E+00	-4.01E+00
1247	-4.03E+00	-4.02E+00	-4.02E+00	-4.02E+00	-4.02E+00	-4.02E+00	-4.02E+00	-4.02E+00	-4.02E+00	-4.02E+00	-4.01E+00	-4.01E+00
1248	-4.03E+00	-4.03E+00	-4.03E+00	-4.02E+00	-4.02E+00	-4.02E+00	-4.02E+00	-4.02E+00	-4.02E+00	-4.02E+00	-4.02E+00	-4.01E+00
1249	-4.03E+00	-4.02E+00	-4.02E+00	-4.02E+00	-4.02E+00	-4.02E+00	-4.02E+00	-4.02E+00	-4.02E+00	-4.02E+00	-4.02E+00	-4.01E+00
1250	-4.03E+00	-4.02E+00	-4.01E+00	-4.01E+00	-4.01E+00	-4.01E+00	-4.01E+00	-4.01E+00	-4.01E+00	-4.01E+00	-4.01E+00	-4.00E+00
1251	-4.02E+00	-4.02E+00	-4.01E+00	-4.01E+00	-4.01E+00	-4.01E+00	-4.01E+00	-4.01E+00	-4.01E+00	-4.01E+00	-4.01E+00	-4.00E+00
1261	-4.03E+00	-4.02E+00	-4.01E+00	-4.01E+00	-4.01E+00	-4.01E+00	-4.01E+00	-4.01E+00	-4.01E+00	-4.01E+00	-4.01E+00	-4.00E+00
1262	-4.03E+00	-4.02E+00	-4.02E+00	-4.01E+00	-4.01E+00	-4.01E+00	-4.01E+00	-4.01E+00	-4.01E+00	-4.01E+00	-4.01E+00	-4.00E+00
1263	-4.02E+00	-4.02E+00	-4.01E+00	-4.01E+00	-4.01E+00	-4.01E+00	-4.01E+00	-4.01E+00	-4.01E+00	-4.01E+00	-4.01E+00	-4.00E+00
1264	-4.03E+00	-4.03E+00	-4.03E+00	-4.03E+00	-4.03E+00	-4.03E+00	-4.03E+00	-4.03E+00	-4.03E+00	-4.03E+00	-4.03E+00	-4.03E+00
1265	-4.02E+00	-4.02E+00	-4.02E+00	-4.02E+00	-4.02E+00	-4.02E+00	-4.02E+00	-4.02E+00	-4.02E+00	-4.02E+00	-4.02E+00	-4.02E+00
Biased Statistics												
Average Biased	-4.03E+00	-4.02E+00	-4.02E+00	-4.01E+00	-4.01E+00	-4.01E+00	-4.01E+00	-4.01E+00	-4.01E+00	-4.01E+00	-4.01E+00	-4.00E+00
Std Dev Biased	2.21E-03	3.44E-03	4.30E-03	4.20E-03	4.11E-03	4.00E-03	3.66E-03	3.46E-03	3.53E-03	3.44E-03	3.98E-03	
Ps90%/90% (+KTL) Biased	-4.02E+00	-4.01E+00	-4.01E+00	-4.01E+00	-4.01E+00	-4.01E+00	-4.01E+00	-4.01E+00	-4.01E+00	-4.00E+00	-3.99E+00	
Ps90%/90% (-KTL) Biased	-4.03E+00	-4.03E+00	-4.02E+00	-4.02E+00	-4.02E+00	-4.02E+00	-4.02E+00	-4.02E+00	-4.02E+00	-4.02E+00	-4.01E+00	
Specification MAX	-3.80E+00	-3.80E+00	-3.80E+00	-3.80E+00	-3.80E+00	-3.70E+00	-3.70E+00	-3.70E+00	-3.70E+00	-3.60E+00	-3.50E+00	
Status	PASS	PASS	PASS	PASS	PASS	PASS	PASS	PASS	PASS	PASS	PASS	PASS

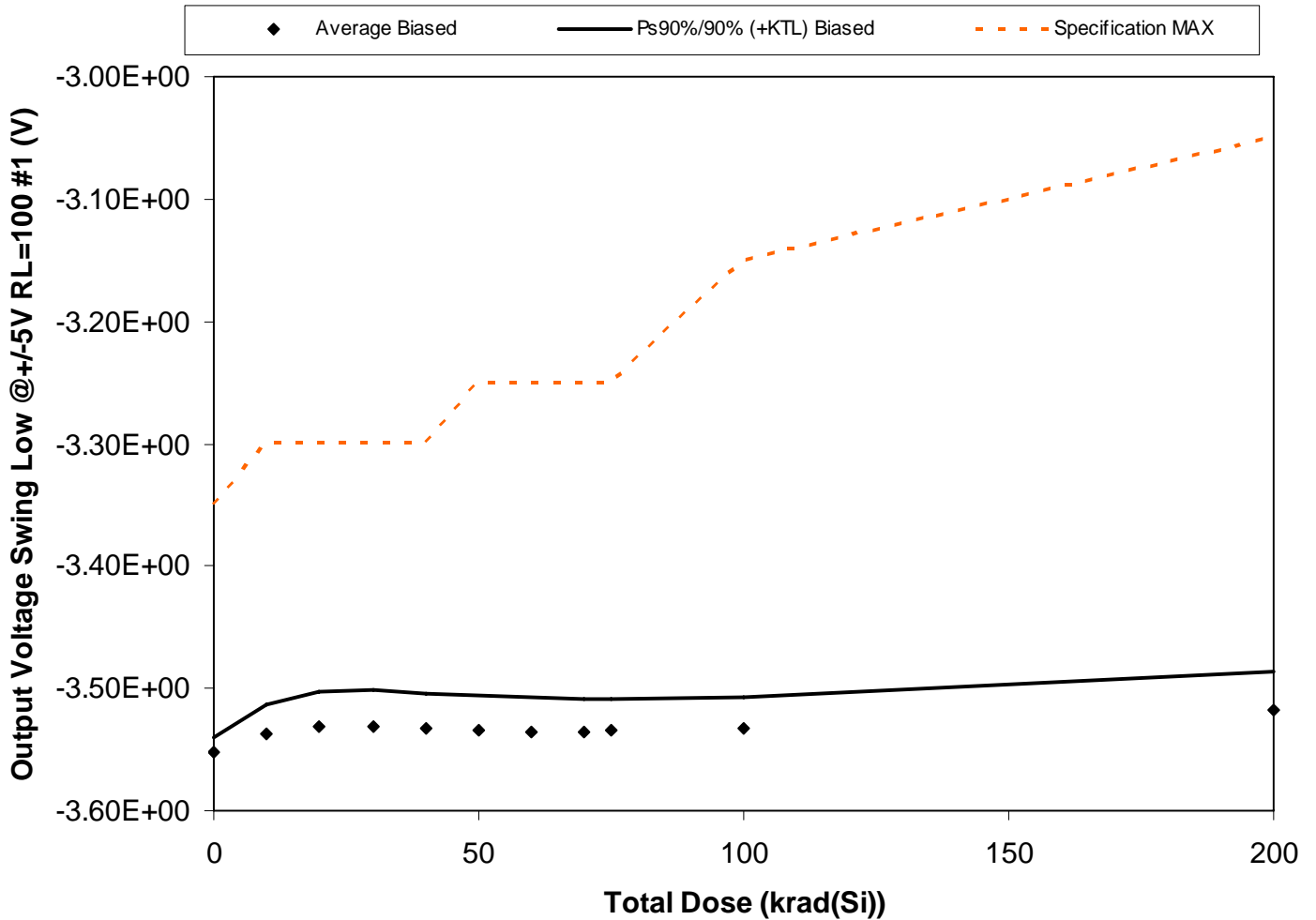

Figure 5.59. Plot of Output Voltage Swing Low @ +/-5V RL=100 #1 (V) versus total dose. The solid diamonds are the average of the measured data points for the samples irradiated under electrical bias and the black lines (solid and/or dashed) are the average of the data points after application of the KTL statistics on the samples irradiated under electrical bias. The red dotted line(s) are the pre- and/or post-irradiation minimum and/or maximum specification value as defined in the datasheet and/or test plan.



**RLAT Report
10-326 100808 R1.0**

**Radiation Assured Devices
5017 N. 30th Street
Colorado Springs, CO 80919
(719) 531-0800**

Table 5.59. Raw data for Output Voltage Swing Low @+/-5V RL=100 #1 (V) versus total dose, including the statistical analysis, specification and the status of the testing (pass/fail).

Output Voltage Swing Low @+/-5V RL=100 #1 (V)	Total Dose (krad(Si))											
	0	10	20	30	40	50	60	70	75	100	200	
Device												
1245	-3.55E+00	-3.54E+00	-3.54E+00	-3.53E+00	-3.53E+00	-3.53E+00	-3.53E+00	-3.53E+00	-3.53E+00	-3.53E+00	-3.52E+00	
1246	-3.55E+00	-3.53E+00	-3.52E+00	-3.52E+00	-3.53E+00	-3.53E+00	-3.53E+00	-3.53E+00	-3.53E+00	-3.53E+00	-3.51E+00	
1247	-3.56E+00	-3.54E+00	-3.53E+00	-3.53E+00	-3.54E+00	-3.54E+00	-3.54E+00	-3.54E+00	-3.54E+00	-3.54E+00	-3.53E+00	
1248	-3.56E+00	-3.56E+00	-3.56E+00	-3.56E+00	-3.56E+00	-3.56E+00	-3.56E+00	-3.56E+00	-3.56E+00	-3.55E+00	-3.53E+00	
1249	-3.56E+00	-3.55E+00	-3.55E+00	-3.55E+00	-3.56E+00	-3.56E+00	-3.56E+00	-3.56E+00	-3.56E+00	-3.56E+00	-3.55E+00	
1250	-3.55E+00	-3.53E+00	-3.52E+00	-3.52E+00	-3.53E+00	-3.53E+00	-3.53E+00	-3.53E+00	-3.53E+00	-3.53E+00	-3.51E+00	
1251	-3.55E+00	-3.53E+00	-3.52E+00	-3.52E+00	-3.52E+00	-3.52E+00	-3.52E+00	-3.52E+00	-3.52E+00	-3.52E+00	-3.50E+00	
1261	-3.55E+00	-3.53E+00	-3.52E+00	-3.52E+00	-3.52E+00	-3.52E+00	-3.52E+00	-3.53E+00	-3.53E+00	-3.52E+00	-3.50E+00	
1262	-3.55E+00	-3.53E+00	-3.52E+00	-3.52E+00	-3.53E+00	-3.53E+00	-3.53E+00	-3.53E+00	-3.53E+00	-3.53E+00	-3.51E+00	
1263	-3.55E+00	-3.54E+00	-3.53E+00	-3.53E+00	-3.53E+00	-3.53E+00	-3.53E+00	-3.53E+00	-3.53E+00	-3.52E+00	-3.50E+00	
1264	-3.55E+00	-3.55E+00	-3.55E+00	-3.55E+00	-3.55E+00	-3.55E+00	-3.55E+00	-3.55E+00	-3.55E+00	-3.55E+00	-3.55E+00	
1265	-3.55E+00	-3.54E+00	-3.54E+00	-3.54E+00	-3.54E+00	-3.54E+00	-3.54E+00	-3.54E+00	-3.54E+00	-3.54E+00	-3.54E+00	
Biased Statistics												
Average Biased	-3.55E+00	-3.54E+00	-3.53E+00	-3.53E+00	-3.53E+00	-3.53E+00	-3.54E+00	-3.54E+00	-3.53E+00	-3.53E+00	-3.52E+00	
Std Dev Biased	6.11E-03	1.17E-02	1.40E-02	1.45E-02	1.38E-02	1.35E-02	1.32E-02	1.28E-02	1.29E-02	1.27E-02	1.46E-02	
Ps90%/90% (+KTL) Biased	-3.54E+00	-3.51E+00	-3.50E+00	-3.50E+00	-3.50E+00	-3.51E+00	-3.51E+00	-3.51E+00	-3.51E+00	-3.51E+00	-3.49E+00	
Ps90%/90% (-KTL) Biased	-3.57E+00	-3.56E+00	-3.56E+00	-3.56E+00	-3.56E+00	-3.56E+00	-3.56E+00	-3.56E+00	-3.56E+00	-3.56E+00	-3.55E+00	
Specification MAX	-3.35E+00	-3.30E+00	-3.30E+00	-3.30E+00	-3.30E+00	-3.25E+00	-3.25E+00	-3.25E+00	-3.25E+00	-3.15E+00	-3.05E+00	
Status	PASS	PASS	PASS	PASS	PASS	PASS	PASS	PASS	PASS	PASS	PASS	

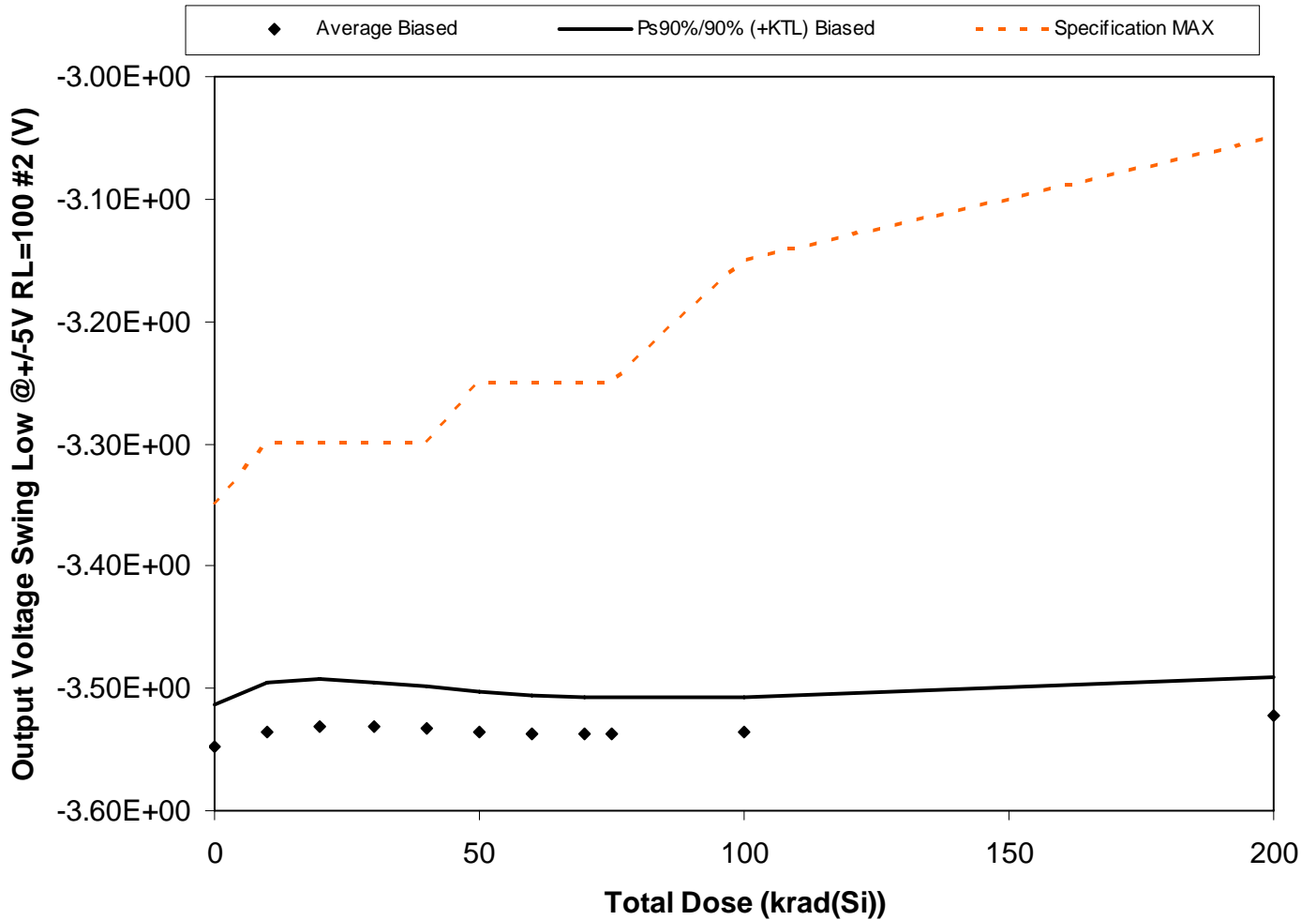

Figure 5.60. Plot of Output Voltage Swing Low @ +/-5V RL=100 #2 (V) versus total dose. The solid diamonds are the average of the measured data points for the samples irradiated under electrical bias and the black lines (solid and/or dashed) are the average of the data points after application of the KTL statistics on the samples irradiated under electrical bias. The red dotted line(s) are the pre- and/or post-irradiation minimum and/or maximum specification value as defined in the datasheet and/or test plan.



**RLAT Report
10-326 100808 R1.0**

**Radiation Assured Devices
5017 N. 30th Street
Colorado Springs, CO 80919
(719) 531-0800**

Table 5.60. Raw data for Output Voltage Swing Low @+/-5V RL=100 #2 (V) versus total dose, including the statistical analysis, specification and the status of the testing (pass/fail).

Output Voltage Swing Low @+/-5V RL=100 #2 (V)	Total Dose (krad(Si))											
	0	10	20	30	40	50	60	70	75	100	200	
Device												
1245	-3.54E+00	-3.52E+00	-3.51E+00	-3.51E+00	-3.51E+00	-3.51E+00	-3.52E+00	-3.52E+00	-3.52E+00	-3.52E+00	-3.50E+00	-3.52E+00
1246	-3.53E+00	-3.51E+00	-3.51E+00	-3.52E+00	-3.53E+00	-3.53E+00	-3.53E+00	-3.53E+00	-3.53E+00	-3.53E+00	-3.52E+00	-3.52E+00
1247	-3.55E+00	-3.54E+00	-3.53E+00	-3.53E+00	-3.53E+00	-3.53E+00	-3.54E+00	-3.54E+00	-3.54E+00	-3.53E+00	-3.52E+00	-3.52E+00
1248	-3.57E+00	-3.57E+00	-3.57E+00	-3.57E+00	-3.57E+00	-3.57E+00	-3.57E+00	-3.57E+00	-3.57E+00	-3.56E+00	-3.54E+00	-3.54E+00
1249	-3.56E+00	-3.55E+00	-3.54E+00	-3.54E+00	-3.54E+00	-3.54E+00	-3.54E+00	-3.54E+00	-3.54E+00	-3.54E+00	-3.52E+00	-3.52E+00
1250	-3.55E+00	-3.53E+00	-3.53E+00	-3.52E+00	-3.52E+00	-3.52E+00	-3.52E+00	-3.52E+00	-3.52E+00	-3.52E+00	-3.50E+00	-3.50E+00
1251	-3.55E+00	-3.53E+00	-3.52E+00	-3.52E+00	-3.52E+00	-3.53E+00	-3.53E+00	-3.53E+00	-3.53E+00	-3.53E+00	-3.52E+00	-3.52E+00
1261	-3.55E+00	-3.54E+00	-3.53E+00	-3.53E+00	-3.53E+00	-3.54E+00	-3.54E+00	-3.54E+00	-3.54E+00	-3.54E+00	-3.53E+00	-3.53E+00
1262	-3.52E+00	-3.51E+00	-3.51E+00	-3.52E+00	-3.53E+00	-3.53E+00	-3.53E+00	-3.54E+00	-3.54E+00	-3.54E+00	-3.52E+00	-3.52E+00
1263	-3.56E+00	-3.56E+00	-3.55E+00	-3.55E+00	-3.55E+00	-3.55E+00	-3.56E+00	-3.56E+00	-3.56E+00	-3.56E+00	-3.55E+00	-3.55E+00
1264	-3.55E+00	-3.54E+00	-3.54E+00	-3.54E+00	-3.54E+00	-3.54E+00	-3.54E+00	-3.54E+00	-3.54E+00	-3.54E+00	-3.54E+00	-3.54E+00
1265	-3.54E+00	-3.54E+00	-3.54E+00	-3.54E+00	-3.54E+00	-3.54E+00	-3.54E+00	-3.54E+00	-3.54E+00	-3.54E+00	-3.54E+00	-3.54E+00
Biased Statistics												
Average Biased	-3.55E+00	-3.54E+00	-3.53E+00	-3.53E+00	-3.53E+00	-3.54E+00	-3.54E+00	-3.54E+00	-3.54E+00	-3.54E+00	-3.52E+00	-3.52E+00
Std Dev Biased	1.66E-02	1.92E-02	1.91E-02	1.78E-02	1.70E-02	1.57E-02	1.49E-02	1.46E-02	1.44E-02	1.41E-02	1.52E-02	1.52E-02
Ps90%/90% (+KTL) Biased	-3.51E+00	-3.50E+00	-3.49E+00	-3.49E+00	-3.50E+00	-3.50E+00	-3.51E+00	-3.51E+00	-3.51E+00	-3.51E+00	-3.49E+00	-3.49E+00
Ps90%/90% (-KTL) Biased	-3.58E+00	-3.57E+00	-3.57E+00	-3.57E+00	-3.57E+00	-3.57E+00	-3.57E+00	-3.57E+00	-3.57E+00	-3.57E+00	-3.55E+00	-3.55E+00
Specification MAX	-3.35E+00	-3.30E+00	-3.30E+00	-3.30E+00	-3.30E+00	-3.25E+00	-3.25E+00	-3.25E+00	-3.25E+00	-3.15E+00	-3.05E+00	-3.05E+00
Status	PASS	PASS	PASS	PASS	PASS	PASS	PASS	PASS	PASS	PASS	PASS	PASS

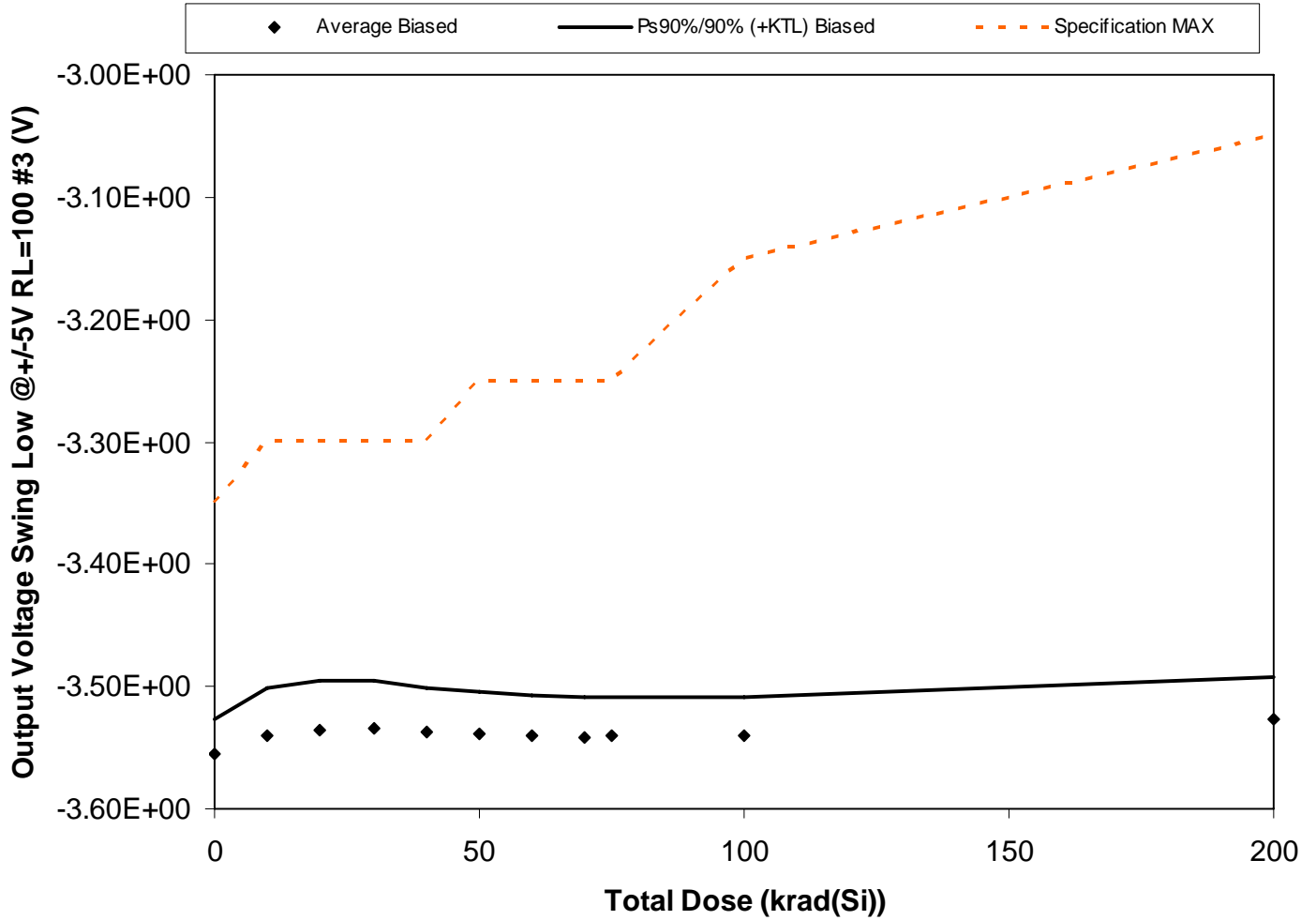

Figure 5.61. Plot of Output Voltage Swing Low @ +/-5V RL=100 #3 (V) versus total dose. The solid diamonds are the average of the measured data points for the samples irradiated under electrical bias and the black lines (solid and/or dashed) are the average of the data points after application of the KTL statistics on the samples irradiated under electrical bias. The red dotted line(s) are the pre- and/or post-irradiation minimum and/or maximum specification value as defined in the datasheet and/or test plan.



**RLAT Report
10-326 100808 R1.0**

**Radiation Assured Devices
5017 N. 30th Street
Colorado Springs, CO 80919
(719) 531-0800**

Table 5.61. Raw data for Output Voltage Swing Low @+/-5V RL=100 #3 (V) versus total dose, including the statistical analysis, specification and the status of the testing (pass/fail).

Output Voltage Swing Low @+/-5V RL=100 #3 (V)	Total Dose (krad(Si))											
	0	10	20	30	40	50	60	70	75	100	200	
Device												
1245	-3.53E+00	-3.50E+00	-3.50E+00	-3.51E+00	-3.51E+00	-3.52E+00	-3.52E+00	-3.52E+00	-3.52E+00	-3.52E+00	-3.52E+00	-3.50E+00
1246	-3.55E+00	-3.53E+00	-3.53E+00	-3.53E+00	-3.53E+00	-3.54E+00	-3.54E+00	-3.54E+00	-3.54E+00	-3.54E+00	-3.54E+00	-3.52E+00
1247	-3.55E+00	-3.54E+00	-3.53E+00	-3.53E+00	-3.53E+00	-3.53E+00	-3.53E+00	-3.53E+00	-3.53E+00	-3.53E+00	-3.53E+00	-3.51E+00
1248	-3.58E+00	-3.58E+00	-3.58E+00	-3.58E+00	-3.58E+00	-3.58E+00	-3.58E+00	-3.58E+00	-3.57E+00	-3.57E+00	-3.57E+00	-3.55E+00
1249	-3.56E+00	-3.55E+00	-3.54E+00	-3.54E+00	-3.54E+00	-3.54E+00	-3.54E+00	-3.54E+00	-3.54E+00	-3.54E+00	-3.54E+00	-3.52E+00
1250	-3.55E+00	-3.54E+00	-3.53E+00	-3.53E+00	-3.53E+00	-3.53E+00	-3.53E+00	-3.53E+00	-3.53E+00	-3.53E+00	-3.53E+00	-3.52E+00
1251	-3.55E+00	-3.53E+00	-3.52E+00	-3.52E+00	-3.52E+00	-3.53E+00	-3.53E+00	-3.53E+00	-3.53E+00	-3.53E+00	-3.53E+00	-3.52E+00
1261	-3.56E+00	-3.54E+00	-3.54E+00	-3.54E+00	-3.54E+00	-3.54E+00	-3.54E+00	-3.54E+00	-3.54E+00	-3.54E+00	-3.55E+00	-3.54E+00
1262	-3.56E+00	-3.54E+00	-3.53E+00	-3.53E+00	-3.54E+00	-3.54E+00	-3.54E+00	-3.54E+00	-3.54E+00	-3.54E+00	-3.54E+00	-3.53E+00
1263	-3.57E+00	-3.56E+00	-3.55E+00	-3.55E+00	-3.56E+00	-3.56E+00	-3.56E+00	-3.56E+00	-3.56E+00	-3.56E+00	-3.56E+00	-3.55E+00
1264	-3.55E+00	-3.55E+00	-3.55E+00	-3.55E+00	-3.55E+00	-3.55E+00	-3.55E+00	-3.55E+00	-3.55E+00	-3.55E+00	-3.55E+00	-3.55E+00
1265	-3.55E+00	-3.54E+00	-3.54E+00	-3.54E+00	-3.54E+00	-3.54E+00	-3.54E+00	-3.54E+00	-3.55E+00	-3.54E+00	-3.54E+00	-3.55E+00
Biased Statistics												
Average Biased	-3.55E+00	-3.54E+00	-3.54E+00	-3.53E+00	-3.54E+00	-3.54E+00	-3.54E+00	-3.54E+00	-3.54E+00	-3.54E+00	-3.54E+00	-3.53E+00
Std Dev Biased	1.34E-02	1.89E-02	1.93E-02	1.91E-02	1.78E-02	1.66E-02	1.62E-02	1.55E-02	1.52E-02	1.52E-02	1.52E-02	1.65E-02
Ps90%/90% (+KTL) Biased	-3.53E+00	-3.50E+00	-3.50E+00	-3.50E+00	-3.50E+00	-3.50E+00	-3.51E+00	-3.51E+00	-3.51E+00	-3.51E+00	-3.51E+00	-3.49E+00
Ps90%/90% (-KTL) Biased	-3.58E+00	-3.58E+00	-3.58E+00	-3.57E+00	-3.57E+00	-3.57E+00	-3.57E+00	-3.57E+00	-3.57E+00	-3.57E+00	-3.57E+00	-3.56E+00
Specification MAX	-3.35E+00	-3.30E+00	-3.30E+00	-3.30E+00	-3.30E+00	-3.25E+00	-3.25E+00	-3.25E+00	-3.25E+00	-3.25E+00	-3.15E+00	-3.05E+00
Status	PASS	PASS	PASS	PASS	PASS	PASS	PASS	PASS	PASS	PASS	PASS	PASS

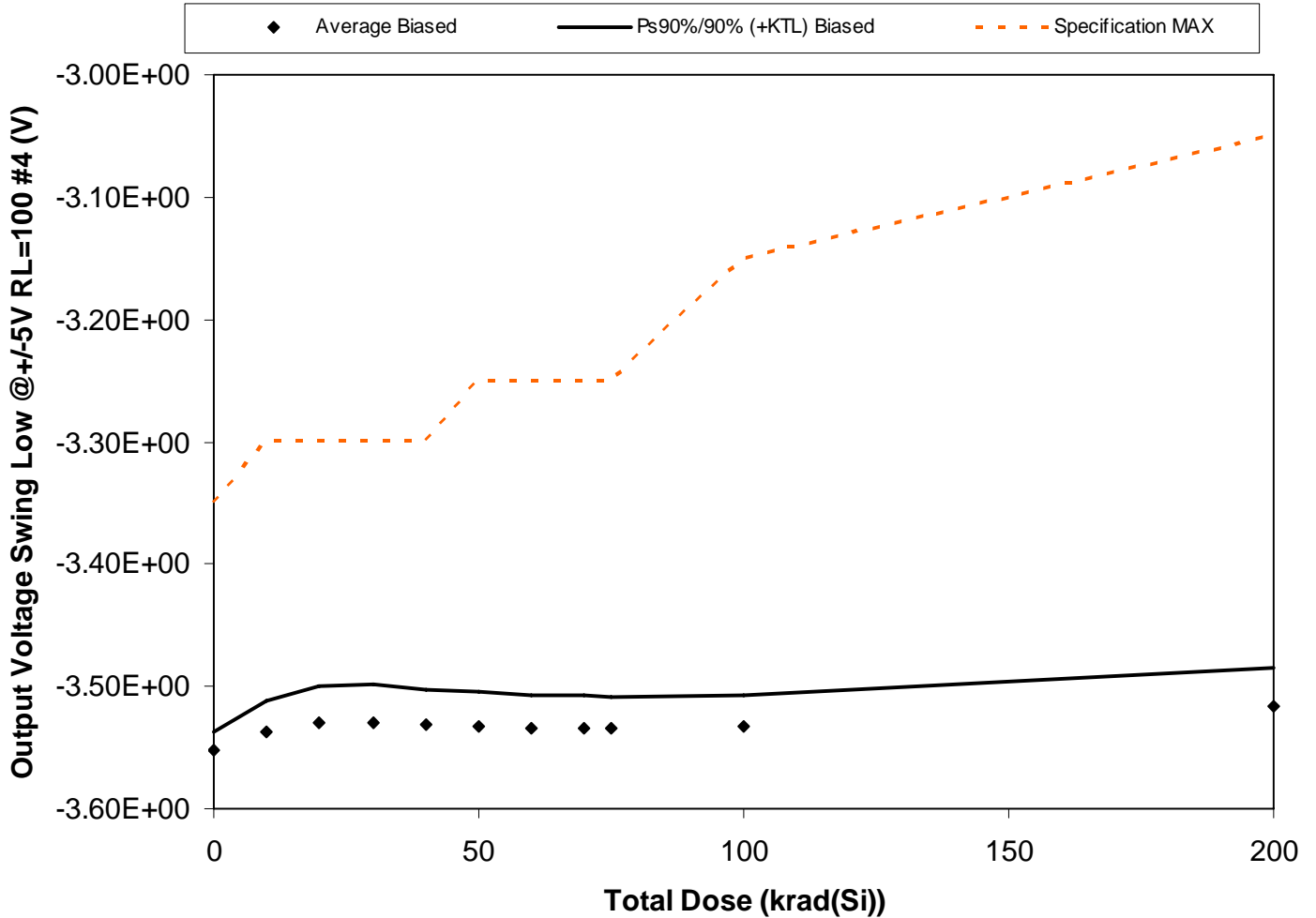

Figure 5.62. Plot of Output Voltage Swing Low @ +/-5V RL=100 #4 (V) versus total dose. The solid diamonds are the average of the measured data points for the samples irradiated under electrical bias and the black lines (solid and/or dashed) are the average of the data points after application of the KTL statistics on the samples irradiated under electrical bias. The red dotted line(s) are the pre- and/or post-irradiation minimum and/or maximum specification value as defined in the datasheet and/or test plan.



**RLAT Report
10-326 100808 R1.0**

**Radiation Assured Devices
5017 N. 30th Street
Colorado Springs, CO 80919
(719) 531-0800**

Table 5.62. Raw data for Output Voltage Swing Low @+/-5V RL=100 #4 (V) versus total dose, including the statistical analysis, specification and the status of the testing (pass/fail).

Output Voltage Swing Low @+/-5V RL=100 #4 (V)	Total Dose (krad(Si))											
	0	10	20	30	40	50	60	70	75	100	200	
Device												
1245	-3.55E+00	-3.54E+00	-3.53E+00	-3.53E+00	-3.53E+00	-3.53E+00	-3.53E+00	-3.53E+00	-3.53E+00	-3.53E+00	-3.53E+00	-3.52E+00
1246	-3.55E+00	-3.53E+00	-3.53E+00	-3.53E+00	-3.53E+00	-3.53E+00	-3.53E+00	-3.54E+00	-3.54E+00	-3.53E+00	-3.53E+00	-3.52E+00
1247	-3.56E+00	-3.54E+00	-3.54E+00	-3.54E+00	-3.54E+00	-3.54E+00	-3.54E+00	-3.54E+00	-3.55E+00	-3.54E+00	-3.55E+00	-3.54E+00
1248	-3.56E+00	-3.56E+00	-3.56E+00	-3.56E+00	-3.56E+00	-3.56E+00	-3.56E+00	-3.56E+00	-3.55E+00	-3.55E+00	-3.55E+00	-3.53E+00
1249	-3.57E+00	-3.56E+00	-3.55E+00	-3.55E+00	-3.55E+00	-3.55E+00	-3.55E+00	-3.55E+00	-3.55E+00	-3.55E+00	-3.55E+00	-3.54E+00
1250	-3.55E+00	-3.53E+00	-3.52E+00	-3.52E+00	-3.52E+00	-3.52E+00	-3.52E+00	-3.52E+00	-3.52E+00	-3.53E+00	-3.52E+00	-3.51E+00
1251	-3.54E+00	-3.52E+00	-3.52E+00	-3.51E+00	-3.52E+00	-3.52E+00	-3.52E+00	-3.52E+00	-3.52E+00	-3.52E+00	-3.52E+00	-3.50E+00
1261	-3.55E+00	-3.53E+00	-3.52E+00	-3.52E+00	-3.52E+00	-3.52E+00	-3.52E+00	-3.52E+00	-3.52E+00	-3.52E+00	-3.52E+00	-3.50E+00
1262	-3.55E+00	-3.53E+00	-3.52E+00	-3.52E+00	-3.52E+00	-3.53E+00	-3.53E+00	-3.53E+00	-3.53E+00	-3.53E+00	-3.53E+00	-3.51E+00
1263	-3.55E+00	-3.53E+00	-3.53E+00	-3.52E+00	-3.53E+00	-3.53E+00	-3.53E+00	-3.53E+00	-3.53E+00	-3.53E+00	-3.52E+00	-3.50E+00
1264	-3.56E+00	-3.56E+00	-3.55E+00	-3.56E+00	-3.56E+00	-3.56E+00	-3.56E+00	-3.56E+00	-3.56E+00	-3.56E+00	-3.56E+00	-3.56E+00
1265	-3.54E+00	-3.53E+00	-3.53E+00	-3.53E+00	-3.53E+00	-3.53E+00	-3.53E+00	-3.53E+00	-3.53E+00	-3.53E+00	-3.53E+00	-3.53E+00
Biased Statistics												
Average Biased	-3.55E+00	-3.54E+00	-3.53E+00	-3.53E+00	-3.53E+00	-3.53E+00	-3.53E+00	-3.53E+00	-3.53E+00	-3.53E+00	-3.53E+00	-3.52E+00
Std Dev Biased	7.12E-03	1.23E-02	1.49E-02	1.48E-02	1.41E-02	1.36E-02	1.30E-02	1.29E-02	1.24E-02	1.21E-02	1.21E-02	1.51E-02
Ps90%/90% (+KTL) Biased	-3.54E+00	-3.51E+00	-3.50E+00	-3.50E+00	-3.50E+00	-3.50E+00	-3.51E+00	-3.51E+00	-3.51E+00	-3.51E+00	-3.51E+00	-3.49E+00
Ps90%/90% (-KTL) Biased	-3.57E+00	-3.56E+00	-3.56E+00	-3.56E+00	-3.56E+00	-3.56E+00	-3.56E+00	-3.56E+00	-3.56E+00	-3.56E+00	-3.56E+00	-3.55E+00
Specification MAX	-3.35E+00	-3.30E+00	-3.30E+00	-3.30E+00	-3.30E+00	-3.25E+00	-3.25E+00	-3.25E+00	-3.25E+00	-3.25E+00	-3.15E+00	-3.05E+00
Status	PASS	PASS	PASS	PASS	PASS	PASS	PASS	PASS	PASS	PASS	PASS	PASS

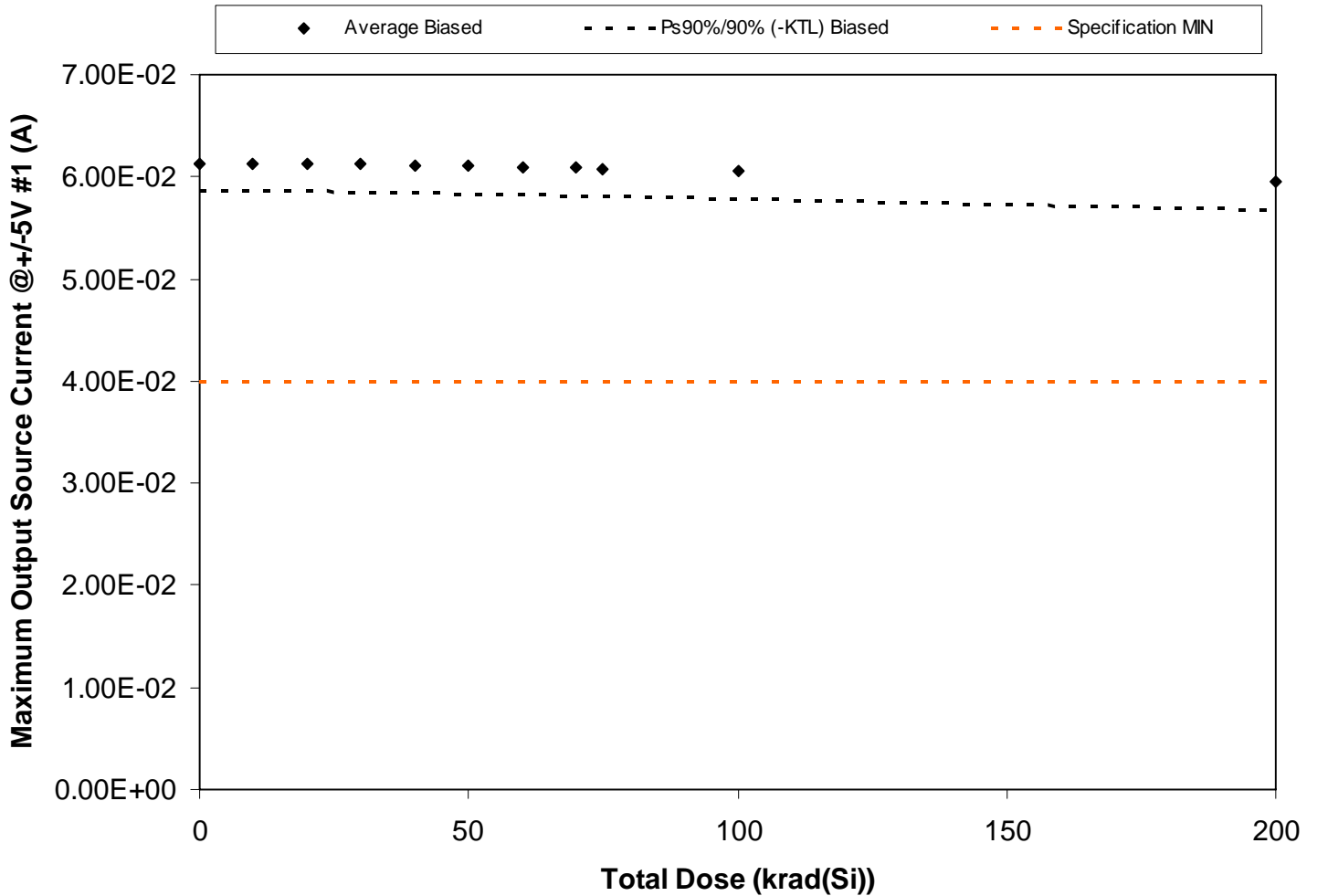

Figure 5.63. Plot of Maximum Output Source Current @ +/-5V #1 (A) versus total dose. The solid diamonds are the average of the measured data points for the samples irradiated under electrical bias and the black lines (solid and/or dashed) are the average of the data points after application of the KTL statistics on the samples irradiated under electrical bias. The red dotted line(s) are the pre- and/or post-irradiation minimum and/or maximum specification value as defined in the datasheet and/or test plan.



**RLAT Report
10-326 100808 R1.0**

**Radiation Assured Devices
5017 N. 30th Street
Colorado Springs, CO 80919
(719) 531-0800**

Table 5.63. Raw data for Maximum Output Source Current @+/-5V #1 (A) versus total dose, including the statistical analysis, specification and the status of the testing (pass/fail).

Maximum Output Source Current @+/-5V #1 (A)	Total Dose (krad(Si))											
	0	10	20	30	40	50	60	70	75	100	200	
Device												
1245	6.02E-02	6.02E-02	6.02E-02	6.01E-02	6.01E-02	6.00E-02	5.99E-02	5.98E-02	5.98E-02	5.95E-02	5.85E-02	
1246	6.17E-02	6.17E-02	6.17E-02	6.16E-02	6.15E-02	6.13E-02	6.13E-02	6.12E-02	6.12E-02	6.09E-02	6.00E-02	
1247	6.23E-02	6.23E-02	6.24E-02	6.23E-02	6.22E-02	6.22E-02	6.20E-02	6.20E-02	6.20E-02	6.17E-02	6.10E-02	
1248	6.31E-02	6.32E-02	6.31E-02	6.30E-02	6.29E-02	6.28E-02	6.27E-02	6.25E-02	6.25E-02	6.22E-02	6.10E-02	
1249	6.36E-02	6.36E-02	6.35E-02	6.35E-02	6.34E-02	6.33E-02	6.31E-02	6.30E-02	6.30E-02	6.27E-02	6.17E-02	
1250	6.01E-02	6.01E-02	6.01E-02	6.00E-02	5.99E-02	5.99E-02	5.97E-02	5.96E-02	5.96E-02	5.93E-02	5.82E-02	
1251	5.99E-02	5.99E-02	5.99E-02	5.96E-02	5.96E-02	5.94E-02	5.94E-02	5.93E-02	5.92E-02	5.88E-02	5.75E-02	
1261	6.06E-02	6.07E-02	6.06E-02	6.06E-02	6.05E-02	6.04E-02	6.02E-02	6.02E-02	6.01E-02	5.99E-02	5.89E-02	
1262	6.11E-02	6.12E-02	6.12E-02	6.11E-02	6.10E-02	6.10E-02	6.08E-02	6.08E-02	6.08E-02	6.05E-02	5.98E-02	
1263	6.04E-02	6.05E-02	6.04E-02	6.02E-02	6.02E-02	6.01E-02	6.01E-02	6.00E-02	5.99E-02	5.96E-02	5.88E-02	
1264	6.13E-02	6.16E-02	6.16E-02	6.16E-02	6.16E-02	6.16E-02	6.16E-02	6.16E-02	6.16E-02	6.15E-02	6.15E-02	
1265	6.19E-02	6.22E-02	6.22E-02	6.22E-02	6.22E-02	6.22E-02	6.22E-02	6.22E-02	6.22E-02	6.21E-02	6.21E-02	
Biased Statistics												
Average Biased	6.13E-02	6.13E-02	6.13E-02	6.12E-02	6.11E-02	6.10E-02	6.09E-02	6.08E-02	6.08E-02	6.05E-02	5.95E-02	
Std Dev Biased	1.32E-03	1.32E-03	1.32E-03	1.35E-03	1.32E-03	1.33E-03	1.31E-03	1.31E-03	1.34E-03	1.32E-03	1.37E-03	
Ps90%/90% (+KTL) Biased	6.40E-02	6.41E-02	6.40E-02	6.40E-02	6.38E-02	6.38E-02	6.36E-02	6.35E-02	6.36E-02	6.32E-02	6.24E-02	
Ps90%/90% (-KTL) Biased	5.86E-02	5.86E-02	5.86E-02	5.84E-02	5.84E-02	5.83E-02	5.82E-02	5.81E-02	5.80E-02	5.78E-02	5.67E-02	
Specification MIN	4.00E-02	4.00E-02	4.00E-02	4.00E-02	4.00E-02	4.00E-02	4.00E-02	4.00E-02	4.00E-02	4.00E-02	4.00E-02	
Status	PASS	PASS	PASS	PASS	PASS	PASS	PASS	PASS	PASS	PASS	PASS	

An ISO 9001:2008 and DSCC Certified Company

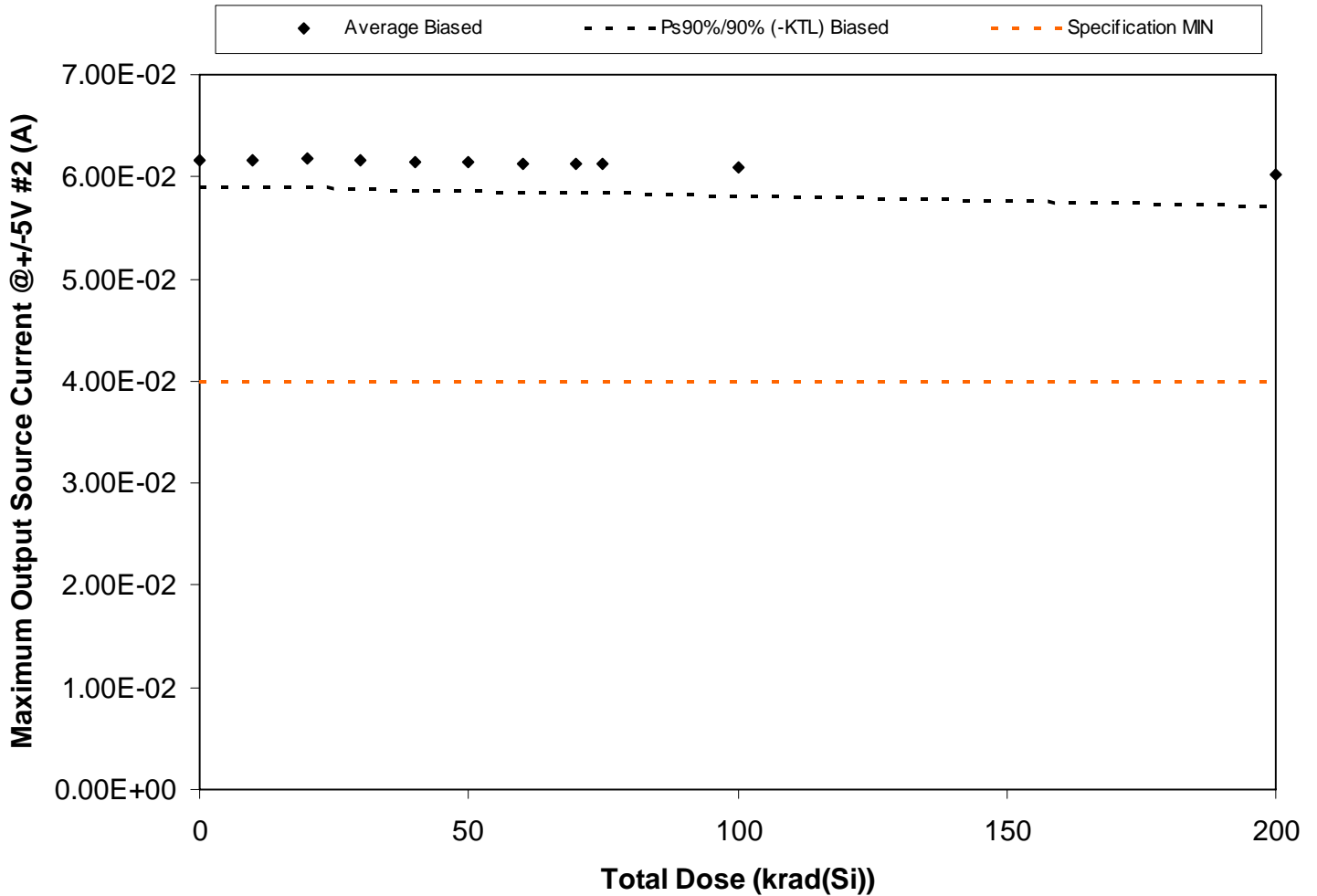

Figure 5.64. Plot of Maximum Output Source Current @ +/-5V #2 (A) versus total dose. The solid diamonds are the average of the measured data points for the samples irradiated under electrical bias and the black lines (solid and/or dashed) are the average of the data points after application of the KTL statistics on the samples irradiated under electrical bias. The red dotted line(s) are the pre- and/or post-irradiation minimum and/or maximum specification value as defined in the datasheet and/or test plan.



**RLAT Report
10-326 100808 R1.0**

**Radiation Assured Devices
5017 N. 30th Street
Colorado Springs, CO 80919
(719) 531-0800**

Table 5.64. Raw data for Maximum Output Source Current @+/-5V #2 (A) versus total dose, including the statistical analysis, specification and the status of the testing (pass/fail).

Maximum Output Source Current @+/-5V #2 (A)	Total Dose (krad(Si))											
	0	10	20	30	40	50	60	70	75	100	200	
Device												
1245	5.99E-02	5.96E-02	5.97E-02	5.95E-02	5.94E-02	5.93E-02	5.92E-02	5.90E-02	5.90E-02	5.87E-02	5.75E-02	
1246	6.16E-02	6.16E-02	6.16E-02	6.14E-02	6.13E-02	6.13E-02	6.12E-02	6.11E-02	6.11E-02	6.07E-02	6.00E-02	
1247	6.11E-02	6.11E-02	6.12E-02	6.11E-02	6.10E-02	6.09E-02	6.08E-02	6.07E-02	6.07E-02	6.05E-02	5.98E-02	
1248	6.39E-02	6.40E-02	6.41E-02	6.40E-02	6.40E-02	6.39E-02	6.39E-02	6.38E-02	6.39E-02	6.36E-02	6.30E-02	
1249	6.14E-02	6.15E-02	6.15E-02	6.13E-02	6.12E-02	6.11E-02	6.11E-02	6.10E-02	6.10E-02	6.07E-02	5.98E-02	
1250	6.01E-02	6.01E-02	6.02E-02	6.01E-02	6.00E-02	6.00E-02	5.99E-02	5.98E-02	5.98E-02	5.95E-02	5.87E-02	
1251	6.15E-02	6.15E-02	6.16E-02	6.15E-02	6.13E-02	6.13E-02	6.11E-02	6.11E-02	6.11E-02	6.09E-02	6.00E-02	
1261	6.18E-02	6.20E-02	6.19E-02	6.19E-02	6.18E-02	6.18E-02	6.17E-02	6.16E-02	6.16E-02	6.13E-02	6.06E-02	
1262	6.18E-02	6.19E-02	6.19E-02	6.18E-02	6.18E-02	6.17E-02	6.17E-02	6.16E-02	6.16E-02	6.13E-02	6.07E-02	
1263	6.34E-02	6.35E-02	6.35E-02	6.33E-02	6.31E-02	6.31E-02	6.30E-02	6.29E-02	6.28E-02	6.25E-02	6.16E-02	
1264	6.07E-02	6.08E-02	6.09E-02	6.08E-02	6.09E-02	6.09E-02	6.08E-02	6.08E-02	6.09E-02	6.08E-02	6.09E-02	
1265	5.99E-02	6.01E-02	6.01E-02	6.01E-02	6.01E-02	6.01E-02	6.01E-02	6.01E-02	6.01E-02	6.00E-02	6.01E-02	
Biased Statistics												
Average Biased	6.16E-02	6.17E-02	6.17E-02	6.16E-02	6.15E-02	6.14E-02	6.14E-02	6.12E-02	6.13E-02	6.10E-02	6.02E-02	
Std Dev Biased	1.25E-03	1.33E-03	1.32E-03	1.31E-03	1.34E-03	1.33E-03	1.36E-03	1.38E-03	1.37E-03	1.40E-03	1.51E-03	
Ps90%/90% (+KTL) Biased	6.42E-02	6.44E-02	6.44E-02	6.43E-02	6.43E-02	6.42E-02	6.42E-02	6.41E-02	6.41E-02	6.39E-02	6.33E-02	
Ps90%/90% (-KTL) Biased	5.91E-02	5.89E-02	5.90E-02	5.89E-02	5.87E-02	5.87E-02	5.85E-02	5.84E-02	5.84E-02	5.81E-02	5.70E-02	
Specification MIN	4.00E-02	4.00E-02	4.00E-02	4.00E-02	4.00E-02	4.00E-02	4.00E-02	4.00E-02	4.00E-02	4.00E-02	4.00E-02	
Status	PASS	PASS	PASS	PASS	PASS	PASS	PASS	PASS	PASS	PASS	PASS	

An ISO 9001:2008 and DSCC Certified Company

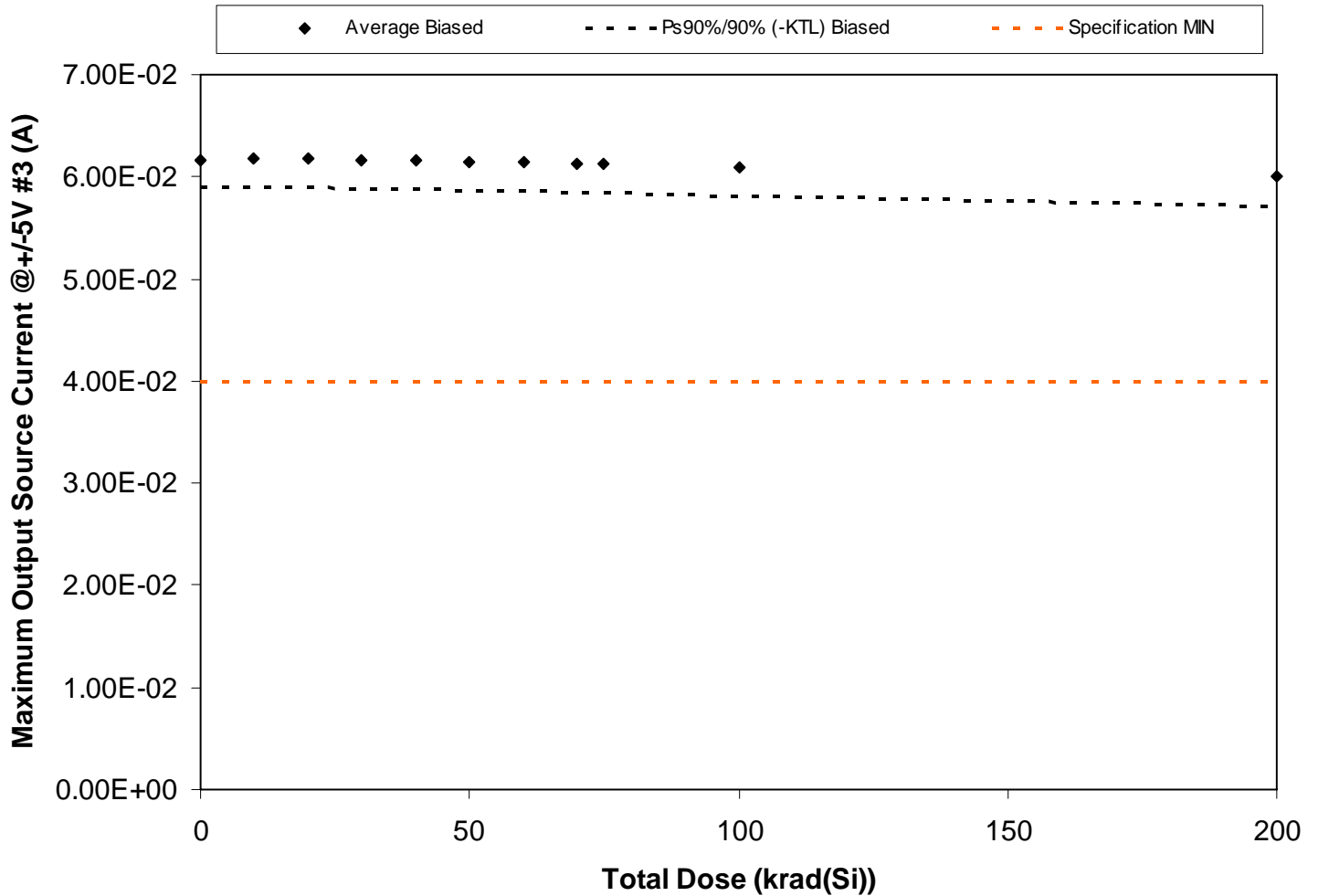

Figure 5.65. Plot of Maximum Output Source Current @ +/-5V #3 (A) versus total dose. The solid diamonds are the average of the measured data points for the samples irradiated under electrical bias and the black lines (solid and/or dashed) are the average of the data points after application of the KTL statistics on the samples irradiated under electrical bias. The red dotted line(s) are the pre- and/or post-irradiation minimum and/or maximum specification value as defined in the datasheet and/or test plan.



**RLAT Report
10-326 100808 R1.0**

**Radiation Assured Devices
5017 N. 30th Street
Colorado Springs, CO 80919
(719) 531-0800**

Table 5.65. Raw data for Maximum Output Source Current @+/-5V #3 (A) versus total dose, including the statistical analysis, specification and the status of the testing (pass/fail).

Maximum Output Source Current @+/-5V #3 (A)	Total Dose (krad(Si))											
	0	10	20	30	40	50	60	70	75	100	200	
Device												
1245	5.97E-02	5.97E-02	5.96E-02	5.95E-02	5.94E-02	5.94E-02	5.93E-02	5.91E-02	5.92E-02	5.88E-02	5.78E-02	
1246	6.17E-02	6.18E-02	6.18E-02	6.16E-02	6.16E-02	6.15E-02	6.14E-02	6.13E-02	6.12E-02	6.10E-02	6.03E-02	
1247	6.11E-02	6.11E-02	6.12E-02	6.11E-02	6.11E-02	6.10E-02	6.08E-02	6.08E-02	6.07E-02	6.05E-02	5.98E-02	
1248	6.42E-02	6.44E-02	6.44E-02	6.42E-02	6.42E-02	6.41E-02	6.40E-02	6.40E-02	6.39E-02	6.37E-02	6.29E-02	
1249	6.13E-02	6.12E-02	6.13E-02	6.12E-02	6.12E-02	6.11E-02	6.11E-02	6.10E-02	6.09E-02	6.07E-02	6.00E-02	
1250	6.03E-02	6.04E-02	6.04E-02	6.02E-02	6.01E-02	6.00E-02	5.99E-02	5.97E-02	5.97E-02	5.94E-02	5.82E-02	
1251	6.16E-02	6.16E-02	6.16E-02	6.15E-02	6.15E-02	6.14E-02	6.12E-02	6.12E-02	6.12E-02	6.10E-02	6.01E-02	
1261	6.19E-02	6.23E-02	6.22E-02	6.21E-02	6.20E-02	6.18E-02	6.18E-02	6.17E-02	6.16E-02	6.13E-02	6.05E-02	
1262	6.18E-02	6.19E-02	6.19E-02	6.17E-02	6.16E-02	6.16E-02	6.14E-02	6.14E-02	6.13E-02	6.11E-02	6.01E-02	
1263	6.33E-02	6.34E-02	6.33E-02	6.32E-02	6.31E-02	6.30E-02	6.29E-02	6.28E-02	6.27E-02	6.24E-02	6.14E-02	
1264	6.10E-02	6.11E-02	6.12E-02	6.11E-02	6.11E-02	6.11E-02	6.11E-02	6.11E-02	6.11E-02	6.10E-02	6.11E-02	
1265	5.98E-02	6.00E-02	6.00E-02	6.00E-02	6.00E-02	6.00E-02	6.00E-02	6.00E-02	6.00E-02	5.99E-02	6.00E-02	
Biased Statistics												
Average Biased	6.17E-02	6.18E-02	6.18E-02	6.16E-02	6.16E-02	6.15E-02	6.14E-02	6.13E-02	6.12E-02	6.10E-02	6.01E-02	
Std Dev Biased	1.30E-03	1.37E-03	1.34E-03	1.34E-03	1.36E-03	1.36E-03	1.35E-03	1.38E-03	1.34E-03	1.39E-03	1.46E-03	
Ps90%/90% (+KTL) Biased	6.44E-02	6.46E-02	6.45E-02	6.44E-02	6.44E-02	6.43E-02	6.42E-02	6.41E-02	6.40E-02	6.39E-02	6.31E-02	
Ps90%/90% (-KTL) Biased	5.90E-02	5.90E-02	5.90E-02	5.89E-02	5.88E-02	5.87E-02	5.86E-02	5.84E-02	5.85E-02	5.81E-02	5.71E-02	
Specification MIN	4.00E-02	4.00E-02	4.00E-02	4.00E-02	4.00E-02	4.00E-02	4.00E-02	4.00E-02	4.00E-02	4.00E-02	4.00E-02	
Status	PASS	PASS	PASS	PASS	PASS	PASS	PASS	PASS	PASS	PASS	PASS	

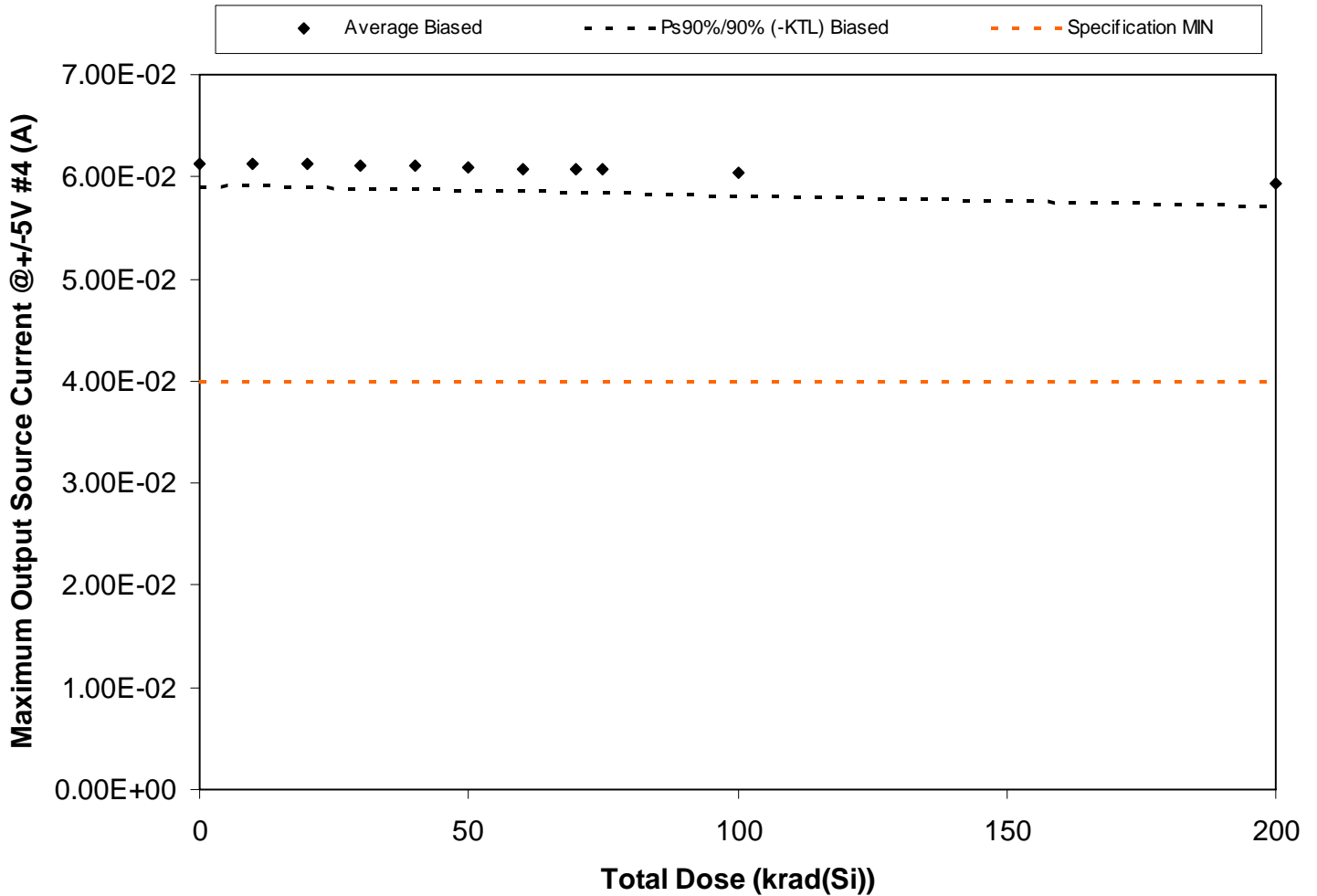

Figure 5.66. Plot of Maximum Output Source Current @ +/-5V #4 (A) versus total dose. The solid diamonds are the average of the measured data points for the samples irradiated under electrical bias and the black lines (solid and/or dashed) are the average of the data points after application of the KTL statistics on the samples irradiated under electrical bias. The red dotted line(s) are the pre- and/or post-irradiation minimum and/or maximum specification value as defined in the datasheet and/or test plan.



**RLAT Report
10-326 100808 R1.0**

**Radiation Assured Devices
5017 N. 30th Street
Colorado Springs, CO 80919
(719) 531-0800**

Table 5.66. Raw data for Maximum Output Source Current @+/-5V #4 (A) versus total dose, including the statistical analysis, specification and the status of the testing (pass/fail).

Maximum Output Source Current @+/-5V #4 (A)	Total Dose (krad(Si))											
	0	10	20	30	40	50	60	70	75	100	200	
Device												
1245	6.06E-02	6.05E-02	6.05E-02	6.04E-02	6.02E-02	6.01E-02	6.00E-02	5.99E-02	5.99E-02	5.95E-02	5.84E-02	
1246	6.14E-02	6.13E-02	6.15E-02	6.13E-02	6.12E-02	6.11E-02	6.10E-02	6.10E-02	6.09E-02	6.06E-02	5.96E-02	
1247	6.20E-02	6.21E-02	6.21E-02	6.21E-02	6.19E-02	6.18E-02	6.18E-02	6.17E-02	6.17E-02	6.14E-02	6.06E-02	
1248	6.25E-02	6.26E-02	6.26E-02	6.24E-02	6.23E-02	6.22E-02	6.21E-02	6.19E-02	6.18E-02	6.15E-02	6.01E-02	
1249	6.32E-02	6.32E-02	6.33E-02	6.31E-02	6.30E-02	6.29E-02	6.29E-02	6.27E-02	6.27E-02	6.24E-02	6.16E-02	
1250	6.02E-02	6.02E-02	6.02E-02	6.00E-02	5.99E-02	5.98E-02	5.96E-02	5.95E-02	5.95E-02	5.91E-02	5.79E-02	
1251	6.01E-02	6.02E-02	6.02E-02	6.01E-02	6.00E-02	5.99E-02	5.99E-02	5.97E-02	5.98E-02	5.95E-02	5.87E-02	
1261	6.06E-02	6.08E-02	6.07E-02	6.06E-02	6.06E-02	6.06E-02	6.05E-02	6.03E-02	6.04E-02	6.02E-02	5.97E-02	
1262	6.10E-02	6.11E-02	6.10E-02	6.09E-02	6.08E-02	6.07E-02	6.06E-02	6.06E-02	6.05E-02	6.02E-02	5.93E-02	
1263	6.05E-02	6.05E-02	6.04E-02	6.02E-02	6.02E-02	6.01E-02	6.00E-02	5.99E-02	5.99E-02	5.95E-02	5.85E-02	
1264	6.13E-02	6.15E-02	6.16E-02	6.16E-02	6.15E-02	6.15E-02	6.15E-02	6.14E-02	6.15E-02	6.15E-02	6.15E-02	
1265	6.19E-02	6.22E-02	6.21E-02	6.21E-02	6.21E-02	6.21E-02	6.21E-02	6.21E-02	6.21E-02	6.21E-02	6.21E-02	
Biased Statistics												
Average Biased	6.12E-02	6.12E-02	6.12E-02	6.11E-02	6.10E-02	6.09E-02	6.08E-02	6.07E-02	6.07E-02	6.04E-02	5.94E-02	
Std Dev Biased	1.05E-03	1.04E-03	1.06E-03	1.08E-03	1.08E-03	1.07E-03	1.08E-03	1.07E-03	1.05E-03	1.08E-03	1.12E-03	
Ps90%/90% (+KTL) Biased	6.34E-02	6.34E-02	6.34E-02	6.33E-02	6.32E-02	6.31E-02	6.31E-02	6.29E-02	6.29E-02	6.26E-02	6.17E-02	
Ps90%/90% (-KTL) Biased	5.91E-02	5.91E-02	5.90E-02	5.89E-02	5.88E-02	5.87E-02	5.86E-02	5.85E-02	5.85E-02	5.82E-02	5.71E-02	
Specification MIN	4.00E-02	4.00E-02	4.00E-02	4.00E-02	4.00E-02	4.00E-02	4.00E-02	4.00E-02	4.00E-02	4.00E-02	4.00E-02	
Status	PASS	PASS	PASS	PASS	PASS	PASS	PASS	PASS	PASS	PASS	PASS	

An ISO 9001:2008 and DSCC Certified Company

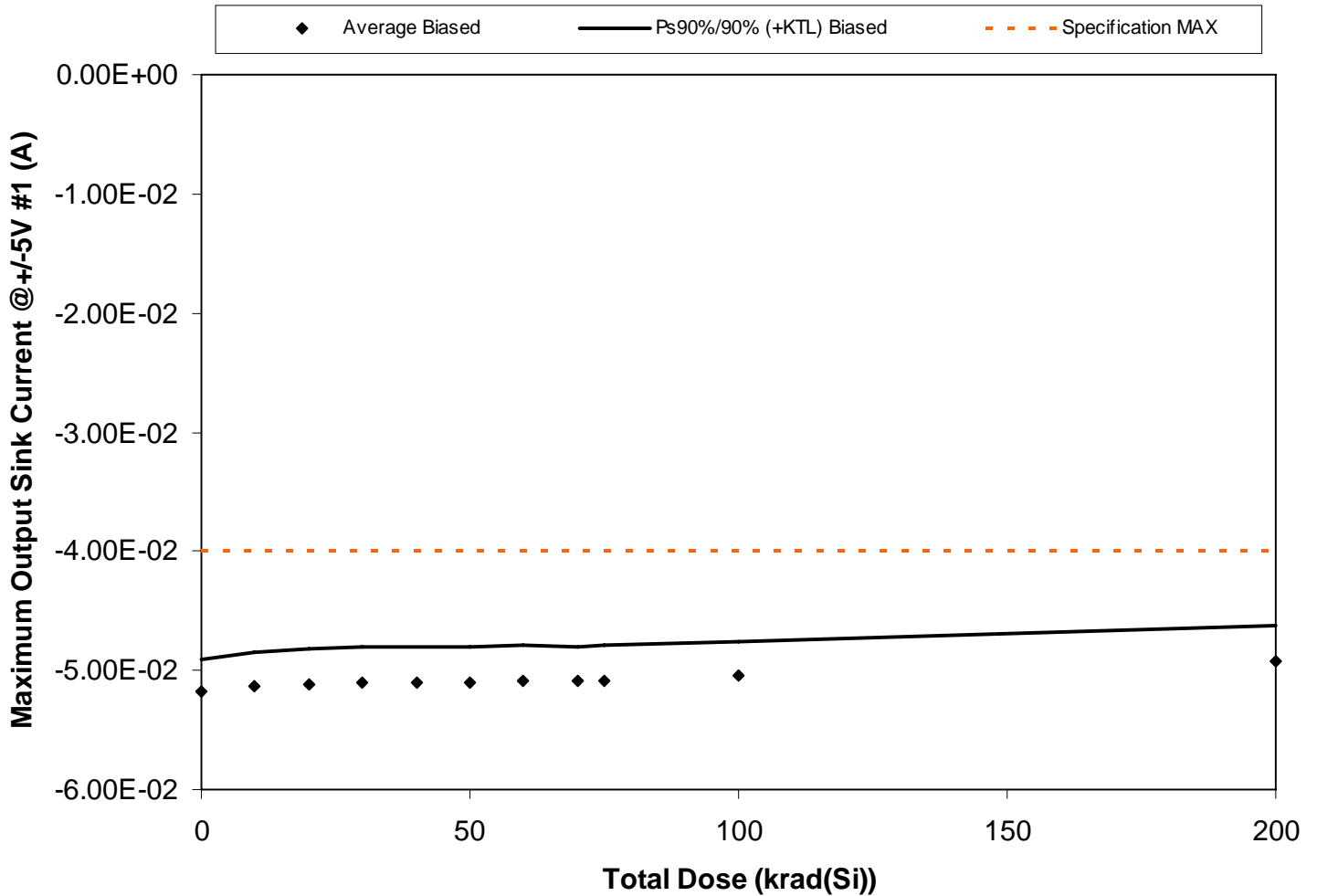

Figure 5.67. Plot of Maximum Output Sink Current @ +/-5V #1 (A) versus total dose. The solid diamonds are the average of the measured data points for the samples irradiated under electrical bias and the black lines (solid and/or dashed) are the average of the data points after application of the KTL statistics on the samples irradiated under electrical bias. The red dotted line(s) are the pre- and/or post-irradiation minimum and/or maximum specification value as defined in the datasheet and/or test plan.



Table 5.67. Raw data for Maximum Output Sink Current @+/-5V #1 (A) versus total dose, including the statistical analysis, specification and the status of the testing (pass/fail).

Maximum Output Sink Current @+/-5V #1 (A)	Total Dose (krad(Si))											
	0	10	20	30	40	50	60	70	75	100	200	
Device												
1245	-5.12E-02	-5.08E-02	-5.06E-02	-5.05E-02	-5.05E-02	-5.05E-02	-5.04E-02	-5.04E-02	-5.04E-02	-5.01E-02	-4.93E-02	
1246	-5.18E-02	-5.11E-02	-5.08E-02	-5.08E-02	-5.08E-02	-5.09E-02	-5.08E-02	-5.08E-02	-5.07E-02	-5.04E-02	-4.90E-02	
1247	-5.28E-02	-5.22E-02	-5.19E-02	-5.18E-02	-5.18E-02	-5.19E-02	-5.19E-02	-5.19E-02	-5.18E-02	-5.16E-02	-5.02E-02	
1248	-5.35E-02	-5.35E-02	-5.35E-02	-5.34E-02	-5.31E-02	-5.31E-02	-5.29E-02	-5.25E-02	-5.26E-02	-5.20E-02	-5.05E-02	
1249	-5.41E-02	-5.37E-02	-5.35E-02	-5.36E-02	-5.37E-02	-5.38E-02	-5.38E-02	-5.37E-02	-5.37E-02	-5.34E-02	-5.23E-02	
1250	-5.07E-02	-5.01E-02	-5.00E-02	-5.00E-02	-5.00E-02	-5.00E-02	-5.00E-02	-4.99E-02	-4.99E-02	-4.96E-02	-4.85E-02	
1251	-5.02E-02	-4.99E-02	-4.96E-02	-4.95E-02	-4.95E-02	-4.95E-02	-4.94E-02	-4.94E-02	-4.93E-02	-4.90E-02	-4.78E-02	
1261	-5.10E-02	-5.05E-02	-5.01E-02	-5.00E-02	-5.00E-02	-5.00E-02	-4.99E-02	-4.98E-02	-4.98E-02	-4.94E-02	-4.81E-02	
1262	-5.15E-02	-5.10E-02	-5.06E-02	-5.05E-02	-5.05E-02	-5.05E-02	-5.04E-02	-5.04E-02	-5.02E-02	-4.99E-02	-4.83E-02	
1263	-5.10E-02	-5.06E-02	-5.02E-02	-5.02E-02	-5.01E-02	-5.00E-02	-5.00E-02	-4.99E-02	-4.98E-02	-4.94E-02	-4.78E-02	
1264	-5.17E-02	-5.17E-02	-5.17E-02	-5.17E-02	-5.17E-02	-5.17E-02	-5.18E-02	-5.18E-02	-5.18E-02	-5.17E-02	-5.18E-02	
1265	-5.20E-02	-5.19E-02	-5.20E-02	-5.20E-02	-5.21E-02	-5.21E-02	-5.21E-02	-5.21E-02	-5.21E-02	-5.21E-02	-5.21E-02	
Biased Statistics												
Average Biased	-5.18E-02	-5.13E-02	-5.11E-02	-5.10E-02	-5.10E-02	-5.10E-02	-5.09E-02	-5.09E-02	-5.08E-02	-5.05E-02	-4.92E-02	
Std Dev Biased	1.28E-03	1.35E-03	1.42E-03	1.44E-03	1.42E-03	1.46E-03	1.45E-03	1.41E-03	1.43E-03	1.40E-03	1.44E-03	
Ps90%/90% (+KTL) Biased	-4.91E-02	-4.86E-02	-4.82E-02	-4.81E-02	-4.81E-02	-4.80E-02	-4.80E-02	-4.80E-02	-4.79E-02	-4.76E-02	-4.62E-02	
Ps90%/90% (-KTL) Biased	-5.44E-02	-5.41E-02	-5.40E-02	-5.40E-02	-5.39E-02	-5.40E-02	-5.39E-02	-5.38E-02	-5.38E-02	-5.34E-02	-5.22E-02	
Specification MAX	-4.00E-02	-4.00E-02	-4.00E-02	-4.00E-02	-4.00E-02	-4.00E-02	-4.00E-02	-4.00E-02	-4.00E-02	-4.00E-02	-4.00E-02	
Status	PASS	PASS	PASS	PASS	PASS	PASS	PASS	PASS	PASS	PASS	PASS	

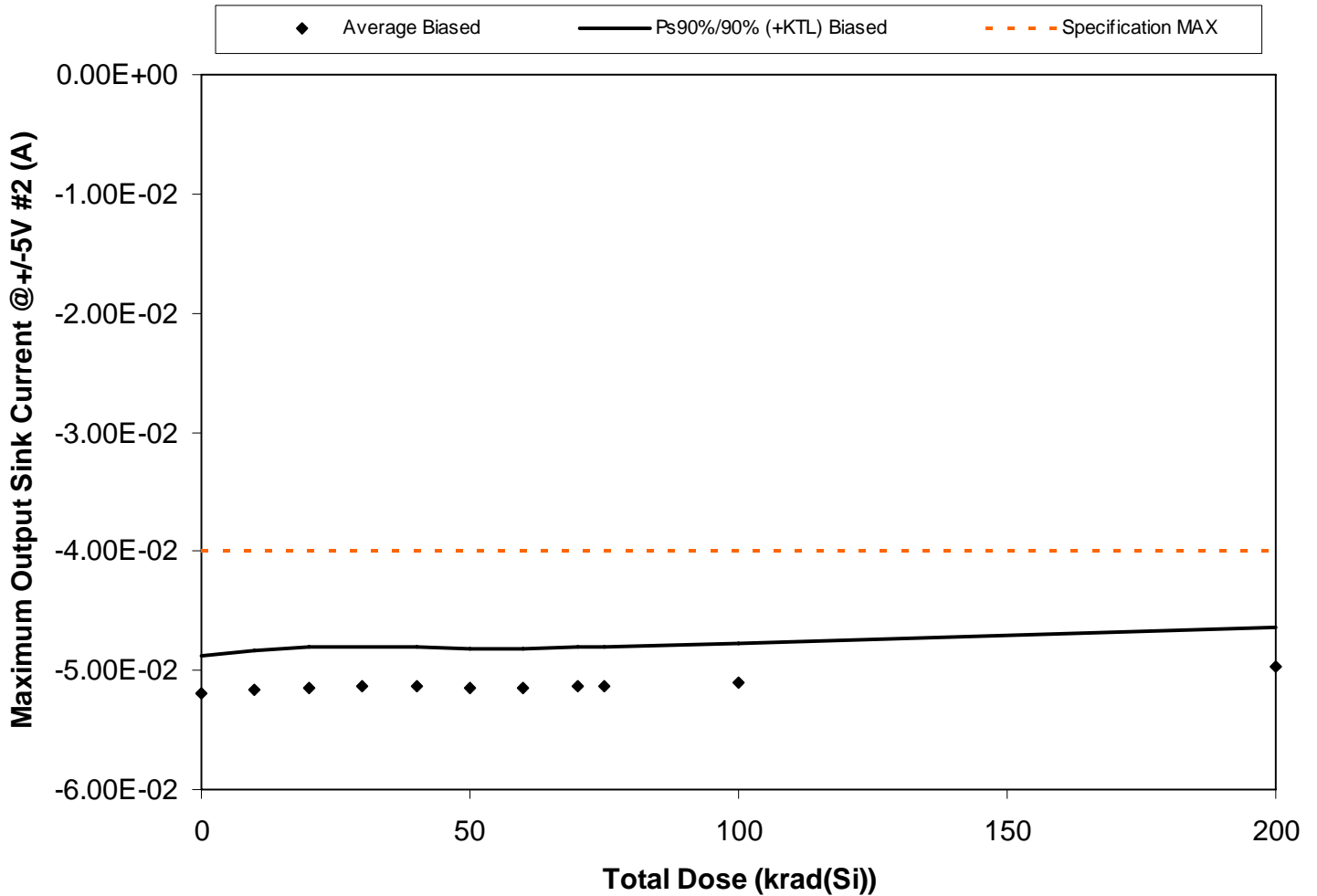

Figure 5.68. Plot of Maximum Output Sink Current @ +/-5V #2 (A) versus total dose. The solid diamonds are the average of the measured data points for the samples irradiated under electrical bias and the black lines (solid and/or dashed) are the average of the data points after application of the KTL statistics on the samples irradiated under electrical bias. The red dotted line(s) are the pre- and/or post-irradiation minimum and/or maximum specification value as defined in the datasheet and/or test plan.



**RLAT Report
10-326 100808 R1.0**

**Radiation Assured Devices
5017 N. 30th Street
Colorado Springs, CO 80919
(719) 531-0800**

Table 5.68. Raw data for Maximum Output Sink Current @+/-5V #2 (A) versus total dose, including the statistical analysis, specification and the status of the testing (pass/fail).

Maximum Output Sink Current @+/-5V #2 (A)	Total Dose (krad(Si))											
	0	10	20	30	40	50	60	70	75	100	200	
Device												
1245	-4.98E-02	-4.93E-02	-4.91E-02	-4.90E-02	-4.90E-02	-4.90E-02	-4.90E-02	-4.90E-02	-4.89E-02	-4.87E-02	-4.77E-02	
1246	-5.11E-02	-5.07E-02	-5.07E-02	-5.10E-02	-5.11E-02	-5.12E-02	-5.12E-02	-5.11E-02	-5.11E-02	-5.08E-02	-4.94E-02	
1247	-5.16E-02	-5.11E-02	-5.09E-02	-5.07E-02	-5.07E-02	-5.07E-02	-5.07E-02	-5.06E-02	-5.06E-02	-5.04E-02	-4.90E-02	
1248	-5.47E-02	-5.46E-02	-5.46E-02	-5.45E-02	-5.43E-02	-5.42E-02	-5.40E-02	-5.39E-02	-5.38E-02	-5.31E-02	-5.16E-02	
1249	-5.19E-02	-5.16E-02	-5.14E-02	-5.11E-02	-5.11E-02	-5.11E-02	-5.10E-02	-5.09E-02	-5.09E-02	-5.05E-02	-4.92E-02	
1250	-5.06E-02	-5.02E-02	-5.00E-02	-4.97E-02	-4.96E-02	-4.98E-02	-4.96E-02	-4.95E-02	-4.94E-02	-4.91E-02	-4.76E-02	
1251	-5.19E-02	-5.15E-02	-5.12E-02	-5.11E-02	-5.11E-02	-5.12E-02	-5.12E-02	-5.11E-02	-5.11E-02	-5.08E-02	-4.95E-02	
1261	-5.27E-02	-5.22E-02	-5.19E-02	-5.18E-02	-5.19E-02	-5.19E-02	-5.19E-02	-5.19E-02	-5.19E-02	-5.16E-02	-5.04E-02	
1262	-5.10E-02	-5.10E-02	-5.09E-02	-5.12E-02	-5.12E-02	-5.14E-02	-5.14E-02	-5.13E-02	-5.13E-02	-5.11E-02	-4.97E-02	
1263	-5.42E-02	-5.40E-02	-5.39E-02	-5.37E-02	-5.38E-02	-5.38E-02	-5.39E-02	-5.39E-02	-5.39E-02	-5.36E-02	-5.28E-02	
1264	-5.08E-02	-5.07E-02	-5.07E-02	-5.07E-02	-5.08E-02	-5.09E-02	-5.08E-02	-5.08E-02	-5.09E-02	-5.08E-02	-5.08E-02	
1265	-5.00E-02	-4.99E-02	-5.00E-02	-5.00E-02	-5.00E-02	-5.00E-02	-5.00E-02	-5.00E-02	-5.00E-02	-5.00E-02	-5.00E-02	
Biased Statistics												
Average Biased	-5.19E-02	-5.16E-02	-5.15E-02	-5.14E-02	-5.14E-02	-5.14E-02	-5.14E-02	-5.13E-02	-5.13E-02	-5.10E-02	-4.97E-02	
Std Dev Biased	1.56E-03	1.62E-03	1.65E-03	1.64E-03	1.62E-03	1.60E-03	1.59E-03	1.59E-03	1.60E-03	1.56E-03	1.60E-03	
Ps90%/90% (+KTL) Biased	-4.87E-02	-4.83E-02	-4.80E-02	-4.80E-02	-4.80E-02	-4.81E-02	-4.81E-02	-4.80E-02	-4.80E-02	-4.78E-02	-4.64E-02	
Ps90%/90% (-KTL) Biased	-5.52E-02	-5.50E-02	-5.49E-02	-5.48E-02	-5.47E-02	-5.47E-02	-5.47E-02	-5.46E-02	-5.46E-02	-5.42E-02	-5.30E-02	
Specification MAX	-4.00E-02	-4.00E-02	-4.00E-02	-4.00E-02	-4.00E-02	-4.00E-02	-4.00E-02	-4.00E-02	-4.00E-02	-4.00E-02	-4.00E-02	
Status	PASS	PASS	PASS	PASS	PASS	PASS	PASS	PASS	PASS	PASS	PASS	

An ISO 9001:2008 and DSCC Certified Company

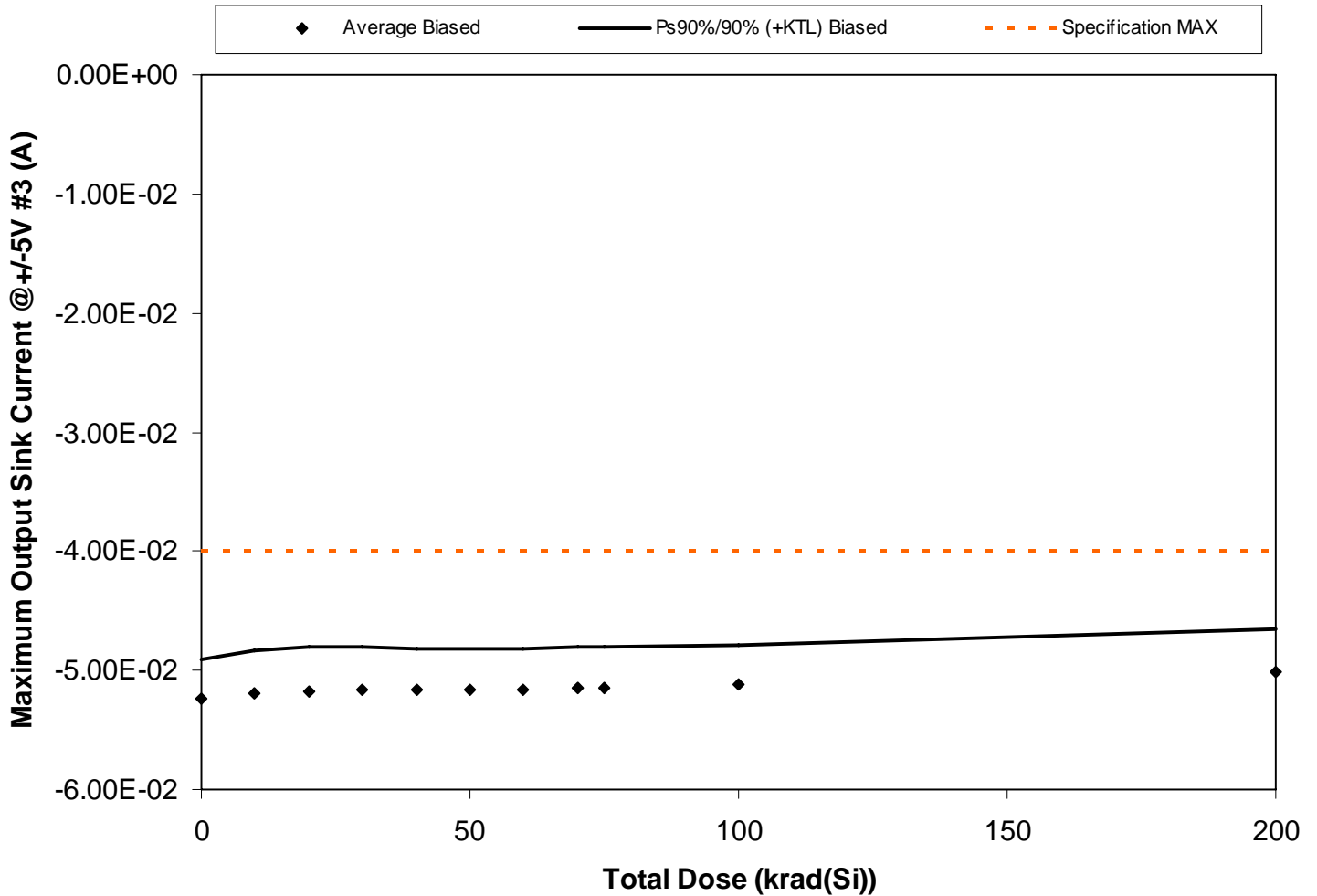

Figure 5.69. Plot of Maximum Output Sink Current @ +/-5V #3 (A) versus total dose. The solid diamonds are the average of the measured data points for the samples irradiated under electrical bias and the black lines (solid and/or dashed) are the average of the data points after application of the KTL statistics on the samples irradiated under electrical bias. The red dotted line(s) are the pre- and/or post-irradiation minimum and/or maximum specification value as defined in the datasheet and/or test plan.



**RLAT Report
10-326 100808 R1.0**

**Radiation Assured Devices
5017 N. 30th Street
Colorado Springs, CO 80919
(719) 531-0800**

Table 5.69. Raw data for Maximum Output Sink Current @+/-5V #3 (A) versus total dose, including the statistical analysis, specification and the status of the testing (pass/fail).

Maximum Output Sink Current @+/-5V #3 (A)	Total Dose (krad(Si))											
	0	10	20	30	40	50	60	70	75	100	200	
Device												
1245	-4.96E-02	-4.90E-02	-4.89E-02	-4.90E-02	-4.91E-02	-4.92E-02	-4.91E-02	-4.90E-02	-4.90E-02	-4.87E-02	-4.76E-02	
1246	-5.23E-02	-5.17E-02	-5.15E-02	-5.14E-02	-5.14E-02	-5.15E-02	-5.15E-02	-5.13E-02	-5.13E-02	-5.10E-02	-4.98E-02	
1247	-5.16E-02	-5.10E-02	-5.08E-02	-5.06E-02	-5.07E-02	-5.07E-02	-5.07E-02	-5.05E-02	-5.05E-02	-5.01E-02	-4.87E-02	
1248	-5.53E-02	-5.53E-02	-5.52E-02	-5.51E-02	-5.50E-02	-5.49E-02	-5.46E-02	-5.45E-02	-5.44E-02	-5.38E-02	-5.22E-02	
1249	-5.20E-02	-5.16E-02	-5.13E-02	-5.12E-02	-5.12E-02	-5.12E-02	-5.11E-02	-5.09E-02	-5.09E-02	-5.06E-02	-4.92E-02	
1250	-5.10E-02	-5.06E-02	-5.05E-02	-5.02E-02	-5.02E-02	-5.02E-02	-5.02E-02	-5.02E-02	-5.01E-02	-4.99E-02	-4.89E-02	
1251	-5.20E-02	-5.15E-02	-5.12E-02	-5.11E-02	-5.10E-02	-5.11E-02	-5.11E-02	-5.11E-02	-5.11E-02	-5.08E-02	-4.95E-02	
1261	-5.29E-02	-5.24E-02	-5.22E-02	-5.20E-02	-5.21E-02	-5.22E-02	-5.22E-02	-5.22E-02	-5.22E-02	-5.21E-02	-5.13E-02	
1262	-5.25E-02	-5.19E-02	-5.17E-02	-5.17E-02	-5.17E-02	-5.18E-02	-5.18E-02	-5.17E-02	-5.17E-02	-5.14E-02	-5.05E-02	
1263	-5.45E-02	-5.41E-02	-5.39E-02	-5.39E-02	-5.40E-02	-5.41E-02	-5.41E-02	-5.41E-02	-5.41E-02	-5.39E-02	-5.30E-02	
1264	-5.17E-02	-5.16E-02	-5.16E-02	-5.16E-02	-5.17E-02	-5.17E-02	-5.17E-02	-5.17E-02	-5.17E-02	-5.17E-02	-5.17E-02	
1265	-5.04E-02	-5.03E-02	-5.04E-02	-5.04E-02	-5.04E-02	-5.05E-02	-5.05E-02	-5.05E-02	-5.05E-02	-5.05E-02	-5.05E-02	
Biased Statistics												
Average Biased	-5.24E-02	-5.19E-02	-5.17E-02	-5.16E-02	-5.16E-02	-5.17E-02	-5.16E-02	-5.15E-02	-5.15E-02	-5.12E-02	-5.01E-02	
Std Dev Biased	1.63E-03	1.76E-03	1.76E-03	1.75E-03	1.71E-03	1.71E-03	1.66E-03	1.69E-03	1.67E-03	1.65E-03	1.68E-03	
Ps90%/90% (+KTL) Biased	-4.90E-02	-4.83E-02	-4.81E-02	-4.80E-02	-4.81E-02	-4.82E-02	-4.82E-02	-4.81E-02	-4.81E-02	-4.78E-02	-4.66E-02	
Ps90%/90% (-KTL) Biased	-5.57E-02	-5.56E-02	-5.54E-02	-5.52E-02	-5.52E-02	-5.52E-02	-5.51E-02	-5.50E-02	-5.50E-02	-5.46E-02	-5.35E-02	
Specification MAX	-4.00E-02	-4.00E-02	-4.00E-02	-4.00E-02	-4.00E-02	-4.00E-02	-4.00E-02	-4.00E-02	-4.00E-02	-4.00E-02	-4.00E-02	
Status	PASS	PASS	PASS	PASS	PASS	PASS	PASS	PASS	PASS	PASS	PASS	

An ISO 9001:2008 and DSCC Certified Company

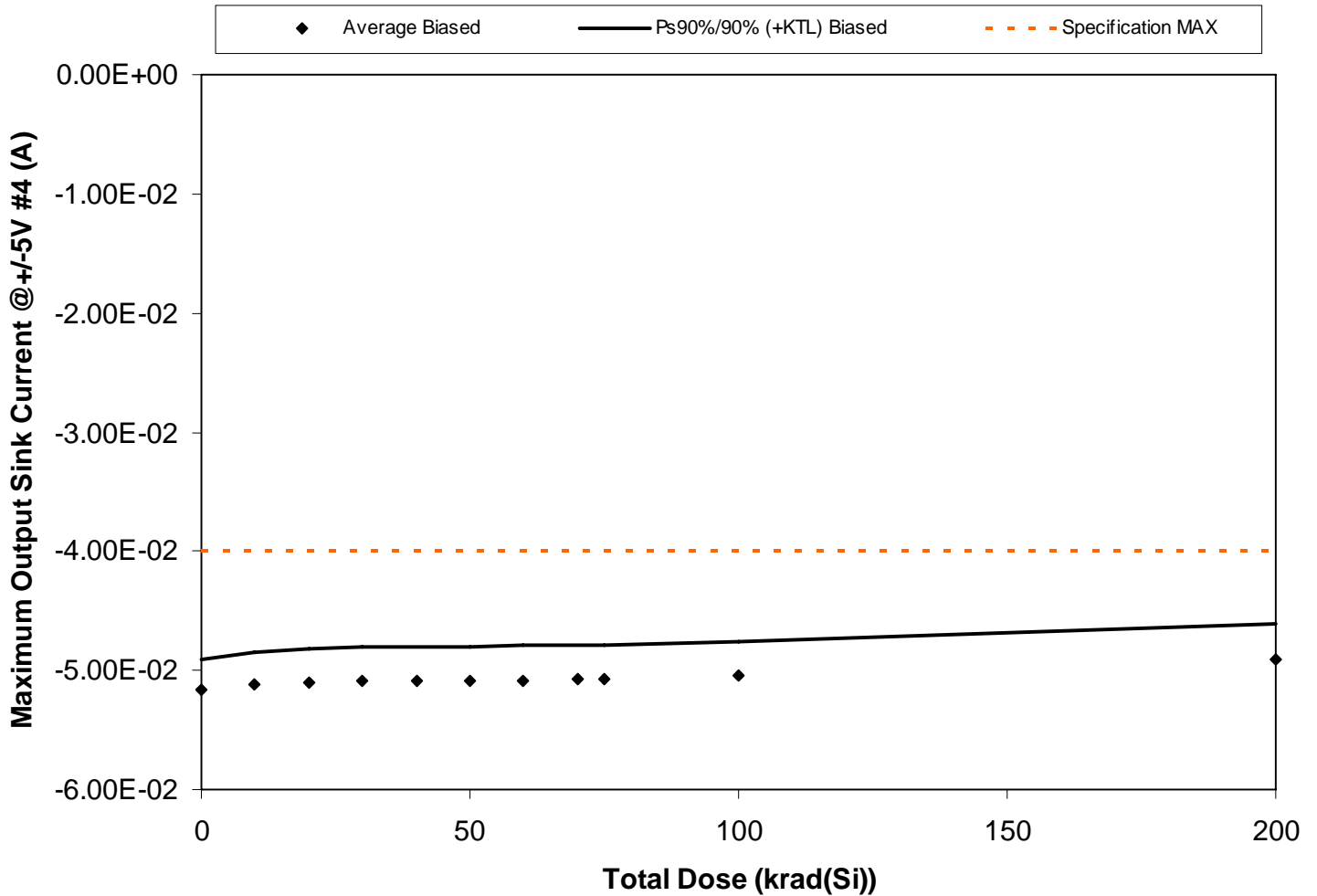

Figure 5.70. Plot of Maximum Output Sink Current @ +/-5V #4 (A) versus total dose. The solid diamonds are the average of the measured data points for the samples irradiated under electrical bias and the black lines (solid and/or dashed) are the average of the data points after application of the KTL statistics on the samples irradiated under electrical bias. The red dotted line(s) are the pre- and/or post-irradiation minimum and/or maximum specification value as defined in the datasheet and/or test plan.



**RLAT Report
10-326 100808 R1.0**

**Radiation Assured Devices
5017 N. 30th Street
Colorado Springs, CO 80919
(719) 531-0800**

Table 5.70. Raw data for Maximum Output Sink Current @+/-5V #4 (A) versus total dose, including the statistical analysis, specification and the status of the testing (pass/fail).

Maximum Output Sink Current @+/-5V #4 (A)	Total Dose (krad(Si))											
	0	10	20	30	40	50	60	70	75	100	200	
Device												
1245	-5.11E-02	-5.07E-02	-5.05E-02	-5.04E-02	-5.03E-02	-5.04E-02	-5.03E-02	-5.02E-02	-5.02E-02	-5.00E-02	-4.89E-02	
1246	-5.18E-02	-5.12E-02	-5.11E-02	-5.10E-02	-5.11E-02	-5.11E-02	-5.11E-02	-5.10E-02	-5.10E-02	-5.07E-02	-4.97E-02	
1247	-5.29E-02	-5.26E-02	-5.22E-02	-5.22E-02	-5.22E-02	-5.23E-02	-5.23E-02	-5.23E-02	-5.23E-02	-5.21E-02	-5.11E-02	
1248	-5.33E-02	-5.32E-02	-5.31E-02	-5.30E-02	-5.29E-02	-5.28E-02	-5.27E-02	-5.24E-02	-5.23E-02	-5.18E-02	-5.06E-02	
1249	-5.39E-02	-5.34E-02	-5.34E-02	-5.31E-02	-5.31E-02	-5.32E-02	-5.31E-02	-5.30E-02	-5.30E-02	-5.27E-02	-5.13E-02	
1250	-5.06E-02	-5.00E-02	-4.99E-02	-4.97E-02	-4.97E-02	-4.98E-02	-4.96E-02	-4.96E-02	-4.96E-02	-4.93E-02	-4.82E-02	
1251	-5.01E-02	-4.96E-02	-4.94E-02	-4.93E-02	-4.93E-02	-4.93E-02	-4.93E-02	-4.91E-02	-4.91E-02	-4.88E-02	-4.75E-02	
1261	-5.08E-02	-5.03E-02	-5.00E-02	-4.97E-02	-4.97E-02	-4.98E-02	-4.96E-02	-4.96E-02	-4.95E-02	-4.91E-02	-4.75E-02	
1262	-5.12E-02	-5.08E-02	-5.05E-02	-5.04E-02	-5.04E-02	-5.04E-02	-5.04E-02	-5.02E-02	-5.02E-02	-5.00E-02	-4.85E-02	
1263	-5.10E-02	-5.05E-02	-5.02E-02	-5.00E-02	-5.01E-02	-5.00E-02	-4.99E-02	-4.99E-02	-4.98E-02	-4.94E-02	-4.78E-02	
1264	-5.19E-02	-5.19E-02	-5.19E-02	-5.19E-02	-5.20E-02	-5.21E-02	-5.21E-02	-5.20E-02	-5.21E-02	-5.21E-02	-5.21E-02	
1265	-5.17E-02	-5.17E-02	-5.17E-02	-5.17E-02	-5.17E-02	-5.18E-02	-5.18E-02	-5.18E-02	-5.18E-02	-5.17E-02	-5.18E-02	
Biased Statistics												
Average Biased	-5.17E-02	-5.12E-02	-5.10E-02	-5.09E-02	-5.09E-02	-5.09E-02	-5.08E-02	-5.07E-02	-5.07E-02	-5.04E-02	-4.91E-02	
Std Dev Biased	1.27E-03	1.33E-03	1.40E-03	1.40E-03	1.39E-03	1.39E-03	1.39E-03	1.37E-03	1.37E-03	1.36E-03	1.48E-03	
Ps90%/90% (+KTL) Biased	-4.90E-02	-4.85E-02	-4.81E-02	-4.80E-02	-4.80E-02	-4.80E-02	-4.80E-02	-4.79E-02	-4.79E-02	-4.76E-02	-4.60E-02	
Ps90%/90% (-KTL) Biased	-5.43E-02	-5.40E-02	-5.39E-02	-5.38E-02	-5.37E-02	-5.38E-02	-5.37E-02	-5.36E-02	-5.35E-02	-5.32E-02	-5.22E-02	
Specification MAX	-4.00E-02	-4.00E-02	-4.00E-02	-4.00E-02	-4.00E-02	-4.00E-02	-4.00E-02	-4.00E-02	-4.00E-02	-4.00E-02	-4.00E-02	
Status	PASS	PASS	PASS	PASS	PASS	PASS	PASS	PASS	PASS	PASS	PASS	

An ISO 9001:2008 and DSCC Certified Company

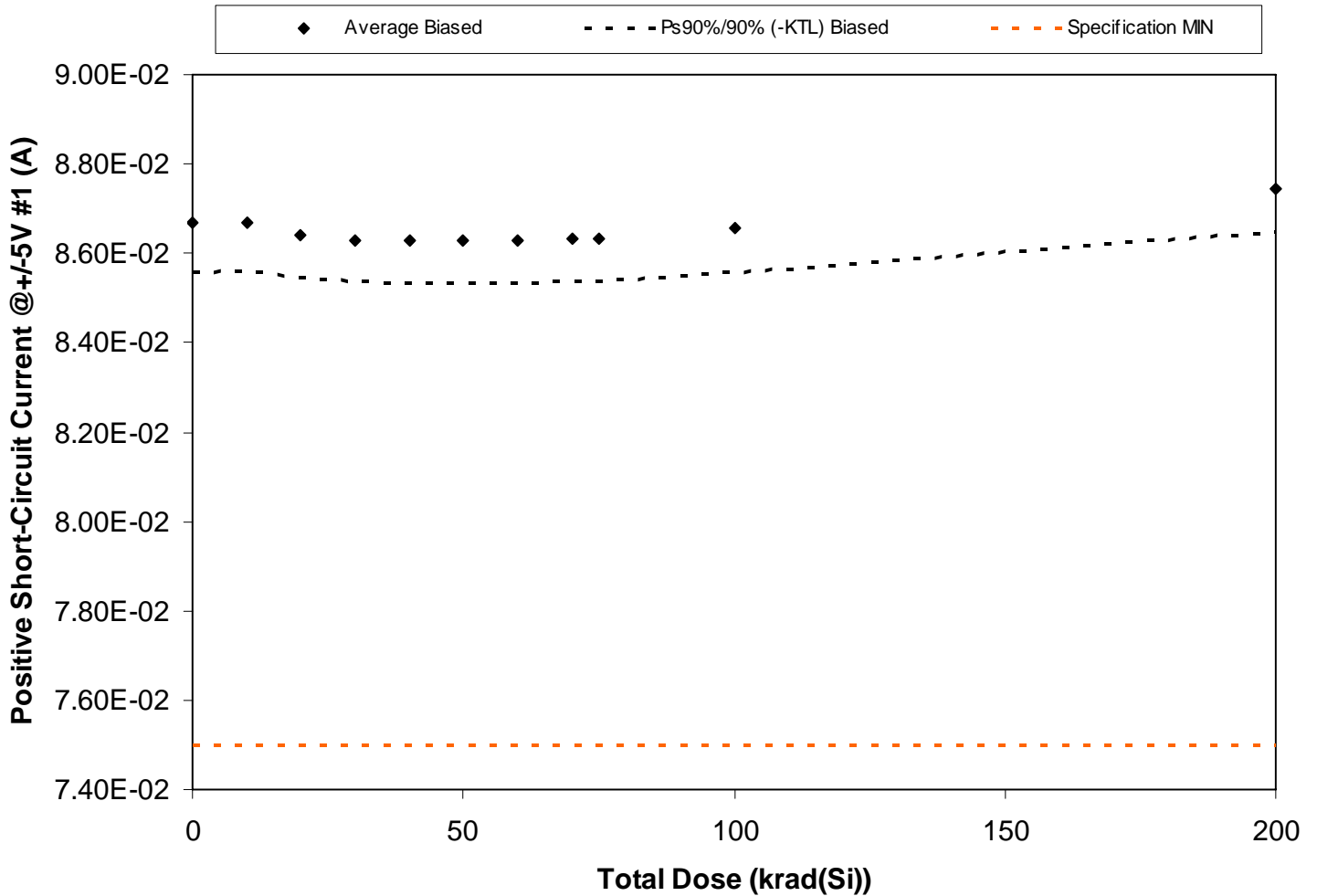

Figure 5.71. Plot of Positive Short-Circuit Current @ +/-5V #1 (A) versus total dose. The solid diamonds are the average of the measured data points for the samples irradiated under electrical bias and the black lines (solid and/or dashed) are the average of the data points after application of the KTL statistics on the samples irradiated under electrical bias. The red dotted line(s) are the pre- and/or post-irradiation minimum and/or maximum specification value as defined in the datasheet and/or test plan.



**RLAT Report
10-326 100808 R1.0**

**Radiation Assured Devices
5017 N. 30th Street
Colorado Springs, CO 80919
(719) 531-0800**

Table 5.71. Raw data for Positive Short-Circuit Current @+/-5V #1 (A) versus total dose, including the statistical analysis, specification and the status of the testing (pass/fail).

Positive Short-Circuit Current @+/-5V #1 (A)	Total Dose (krad(Si))											
	0	10	20	30	40	50	60	70	75	100	200	
Device												
1245	8.68E-02	8.66E-02	8.62E-02	8.61E-02	8.60E-02	8.60E-02	8.59E-02	8.60E-02	8.61E-02	8.63E-02	8.73E-02	
1246	8.71E-02	8.70E-02	8.67E-02	8.65E-02	8.66E-02	8.66E-02	8.65E-02	8.65E-02	8.66E-02	8.68E-02	8.77E-02	
1247	8.70E-02	8.70E-02	8.67E-02	8.65E-02	8.65E-02	8.66E-02	8.65E-02	8.65E-02	8.66E-02	8.67E-02	8.76E-02	
1248	8.75E-02	8.75E-02	8.72E-02	8.70E-02	8.70E-02	8.71E-02	8.70E-02	8.71E-02	8.72E-02	8.74E-02	8.84E-02	
1249	8.74E-02	8.73E-02	8.70E-02	8.69E-02	8.69E-02	8.69E-02	8.69E-02	8.69E-02	8.69E-02	8.72E-02	8.80E-02	
1250	8.62E-02	8.61E-02	8.59E-02	8.58E-02	8.58E-02	8.58E-02	8.58E-02	8.58E-02	8.58E-02	8.61E-02	8.70E-02	
1251	8.63E-02	8.63E-02	8.61E-02	8.61E-02	8.60E-02	8.60E-02	8.61E-02	8.60E-02	8.61E-02	8.62E-02	8.71E-02	
1261	8.63E-02	8.64E-02	8.62E-02	8.61E-02	8.61E-02	8.61E-02	8.61E-02	8.61E-02	8.61E-02	8.63E-02	8.72E-02	
1262	8.65E-02	8.66E-02	8.64E-02	8.63E-02	8.63E-02	8.63E-02	8.63E-02	8.63E-02	8.63E-02	8.66E-02	8.74E-02	
1263	8.59E-02	8.59E-02	8.58E-02	8.57E-02	8.57E-02	8.57E-02	8.57E-02	8.57E-02	8.57E-02	8.59E-02	8.69E-02	
1264	8.63E-02	8.63E-02	8.61E-02	8.60E-02	8.59E-02	8.58E-02	8.58E-02	8.58E-02	8.57E-02	8.58E-02	8.58E-02	
1265	8.63E-02	8.64E-02	8.62E-02	8.61E-02	8.59E-02	8.59E-02	8.58E-02	8.58E-02	8.58E-02	8.58E-02	8.59E-02	
Biased Statistics												
Average Biased	8.67E-02	8.67E-02	8.64E-02	8.63E-02	8.63E-02	8.63E-02	8.63E-02	8.63E-02	8.63E-02	8.66E-02	8.75E-02	
Std Dev Biased	5.56E-04	5.16E-04	4.74E-04	4.44E-04	4.55E-04	4.70E-04	4.54E-04	4.61E-04	4.70E-04	4.74E-04	4.69E-04	
Ps90%/90% (+KTL) Biased	8.79E-02	8.78E-02	8.74E-02	8.72E-02	8.72E-02	8.73E-02	8.72E-02	8.73E-02	8.73E-02	8.75E-02	8.84E-02	
Ps90%/90% (-KTL) Biased	8.56E-02	8.56E-02	8.54E-02	8.54E-02	8.53E-02	8.53E-02	8.53E-02	8.54E-02	8.54E-02	8.56E-02	8.65E-02	
Specification MIN	7.50E-02	7.50E-02	7.50E-02	7.50E-02	7.50E-02	7.50E-02	7.50E-02	7.50E-02	7.50E-02	7.50E-02	7.50E-02	
Status	PASS	PASS	PASS	PASS	PASS	PASS	PASS	PASS	PASS	PASS	PASS	

An ISO 9001:2008 and DSCC Certified Company

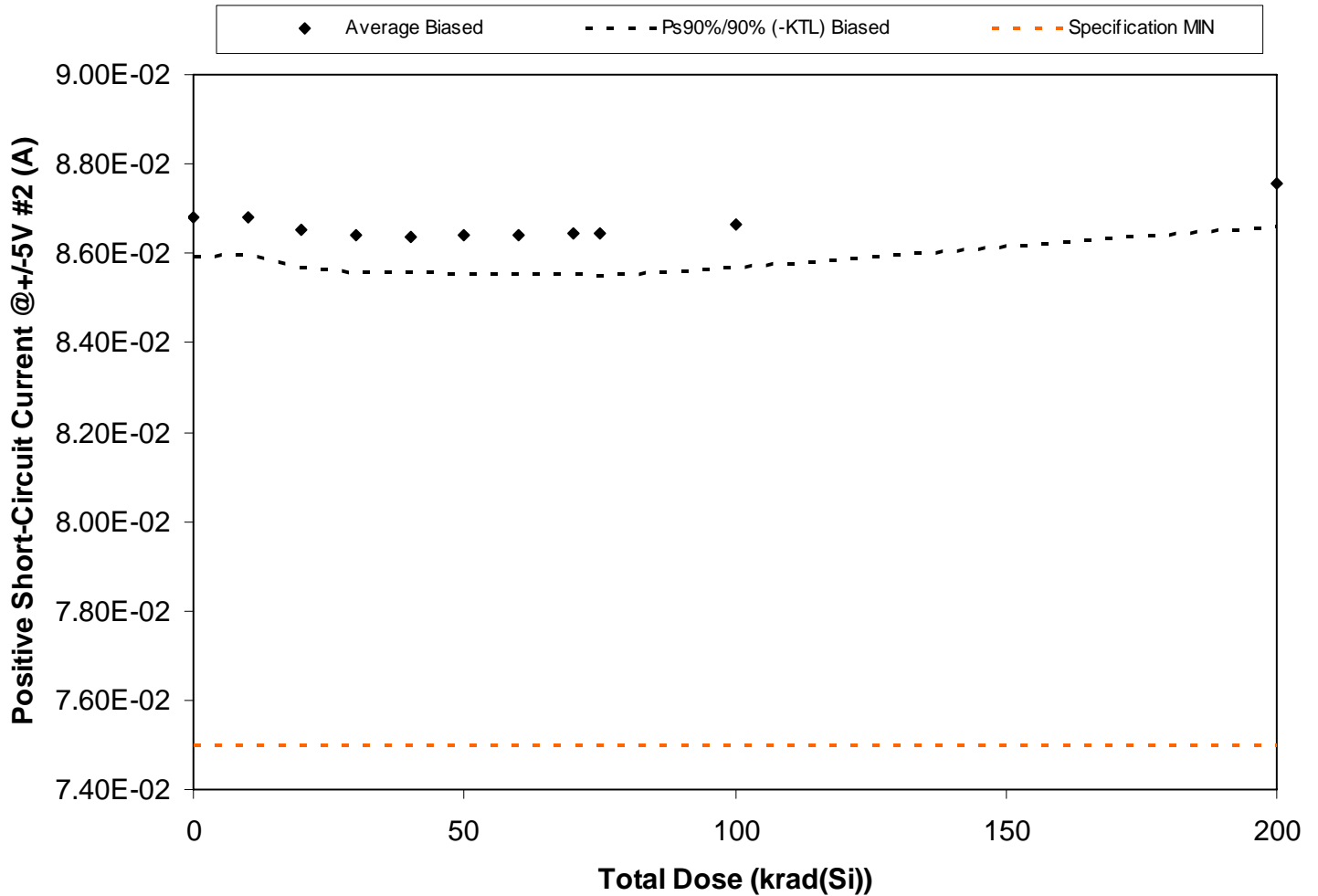

Figure 5.72. Plot of Positive Short-Circuit Current @ +/-5V #2 (A) versus total dose. The solid diamonds are the average of the measured data points for the samples irradiated under electrical bias and the black lines (solid and/or dashed) are the average of the data points after application of the KTL statistics on the samples irradiated under electrical bias. The red dotted line(s) are the pre- and/or post-irradiation minimum and/or maximum specification value as defined in the datasheet and/or test plan.



**RLAT Report
10-326 100808 R1.0**

**Radiation Assured Devices
5017 N. 30th Street
Colorado Springs, CO 80919
(719) 531-0800**

Table 5.72. Raw data for Positive Short-Circuit Current @+/-5V #2 (A) versus total dose, including the statistical analysis, specification and the status of the testing (pass/fail).

Positive Short-Circuit Current @+/-5V #2 (A)	Total Dose (krad(Si))											
	0	10	20	30	40	50	60	70	75	100	200	
Device												
1245	8.67E-02	8.66E-02	8.62E-02	8.60E-02	8.59E-02	8.60E-02	8.59E-02	8.59E-02	8.60E-02	8.62E-02	8.72E-02	
1246	8.72E-02	8.72E-02	8.68E-02	8.67E-02	8.66E-02	8.66E-02	8.66E-02	8.67E-02	8.67E-02	8.69E-02	8.78E-02	
1247	8.68E-02	8.68E-02	8.64E-02	8.63E-02	8.63E-02	8.63E-02	8.63E-02	8.63E-02	8.63E-02	8.66E-02	8.74E-02	
1248	8.78E-02	8.77E-02	8.74E-02	8.73E-02	8.73E-02	8.74E-02	8.74E-02	8.74E-02	8.74E-02	8.75E-02	8.87E-02	
1249	8.67E-02	8.66E-02	8.63E-02	8.62E-02	8.62E-02	8.62E-02	8.62E-02	8.62E-02	8.62E-02	8.64E-02	8.73E-02	
1250	8.62E-02	8.62E-02	8.59E-02	8.58E-02	8.58E-02	8.58E-02	8.58E-02	8.59E-02	8.58E-02	8.61E-02	8.70E-02	
1251	8.67E-02	8.67E-02	8.64E-02	8.63E-02	8.63E-02	8.63E-02	8.64E-02	8.64E-02	8.64E-02	8.66E-02	8.75E-02	
1261	8.67E-02	8.68E-02	8.66E-02	8.65E-02	8.64E-02	8.64E-02	8.65E-02	8.65E-02	8.65E-02	8.67E-02	8.75E-02	
1262	8.67E-02	8.67E-02	8.66E-02	8.64E-02	8.64E-02	8.64E-02	8.64E-02	8.64E-02	8.64E-02	8.67E-02	8.75E-02	
1263	8.68E-02	8.69E-02	8.67E-02	8.66E-02	8.66E-02	8.66E-02	8.66E-02	8.67E-02	8.67E-02	8.68E-02	8.76E-02	
1264	8.61E-02	8.60E-02	8.58E-02	8.57E-02	8.57E-02	8.56E-02	8.56E-02	8.55E-02	8.55E-02	8.56E-02	8.56E-02	
1265	8.58E-02	8.59E-02	8.56E-02	8.55E-02	8.54E-02	8.54E-02	8.53E-02	8.53E-02	8.53E-02	8.53E-02	8.53E-02	
Biased Statistics												
Average Biased	8.68E-02	8.68E-02	8.65E-02	8.64E-02	8.64E-02	8.64E-02	8.64E-02	8.64E-02	8.65E-02	8.67E-02	8.76E-02	
Std Dev Biased	4.19E-04	4.12E-04	3.98E-04	4.06E-04	3.98E-04	4.18E-04	4.29E-04	4.37E-04	4.62E-04	4.68E-04	4.66E-04	
Ps90%/90% (+KTL) Biased	8.77E-02	8.77E-02	8.73E-02	8.72E-02	8.72E-02	8.73E-02	8.73E-02	8.73E-02	8.74E-02	8.76E-02	8.85E-02	
Ps90%/90% (-KTL) Biased	8.59E-02	8.60E-02	8.57E-02	8.56E-02	8.56E-02	8.55E-02	8.55E-02	8.55E-02	8.55E-02	8.57E-02	8.66E-02	
Specification MIN	7.50E-02	7.50E-02	7.50E-02	7.50E-02	7.50E-02	7.50E-02	7.50E-02	7.50E-02	7.50E-02	7.50E-02	7.50E-02	
Status	PASS	PASS	PASS	PASS	PASS	PASS	PASS	PASS	PASS	PASS	PASS	

An ISO 9001:2008 and DSCC Certified Company

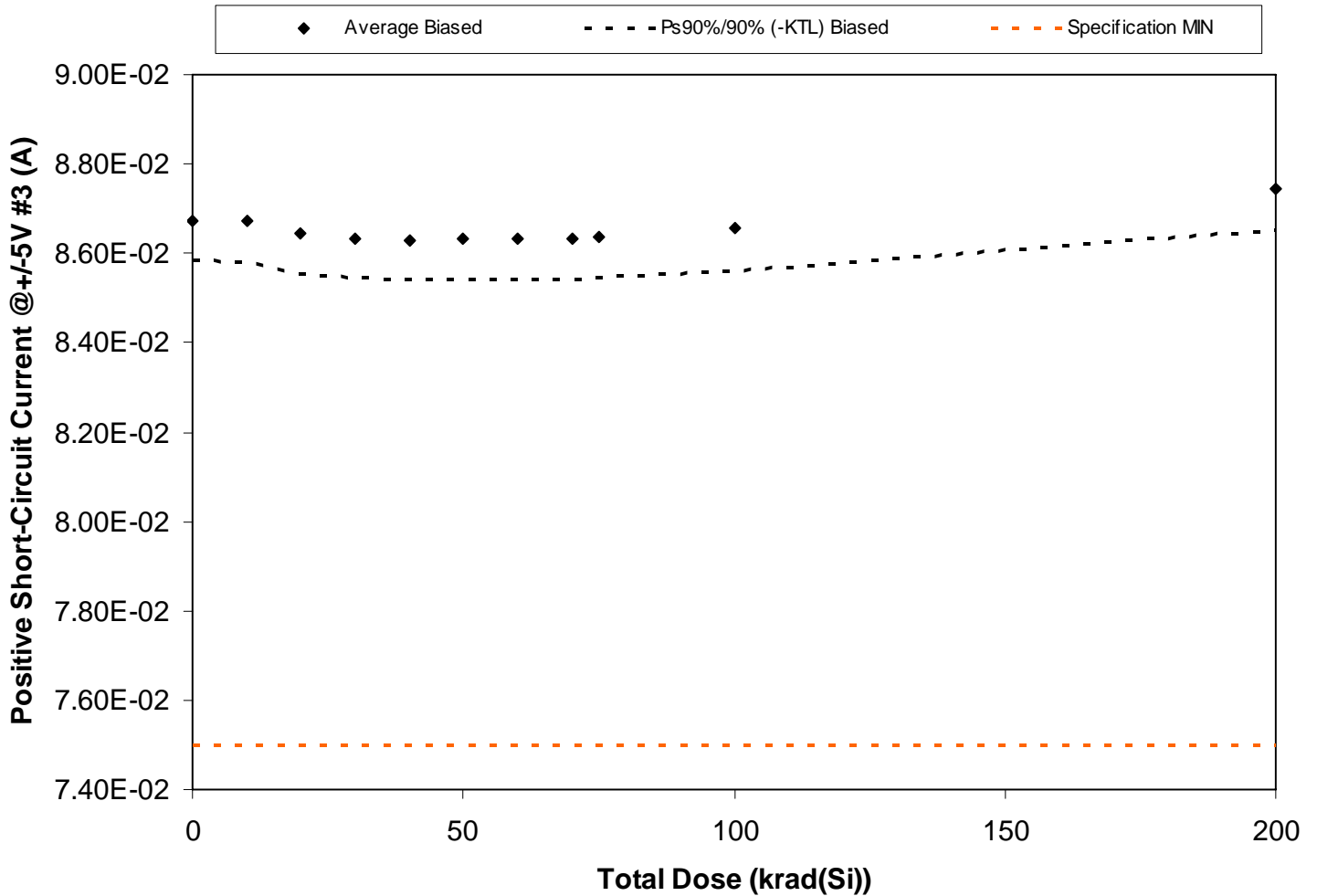

Figure 5.73. Plot of Positive Short-Circuit Current @ +/-5V #3 (A) versus total dose. The solid diamonds are the average of the measured data points for the samples irradiated under electrical bias and the black lines (solid and/or dashed) are the average of the data points after application of the KTL statistics on the samples irradiated under electrical bias. The red dotted line(s) are the pre- and/or post-irradiation minimum and/or maximum specification value as defined in the datasheet and/or test plan.



**RLAT Report
10-326 100808 R1.0**

**Radiation Assured Devices
5017 N. 30th Street
Colorado Springs, CO 80919
(719) 531-0800**

Table 5.73. Raw data for Positive Short-Circuit Current @+/-5V #3 (A) versus total dose, including the statistical analysis, specification and the status of the testing (pass/fail).

Positive Short-Circuit Current @+/-5V #3 (A)	Total Dose (krad(Si))											
	0	10	20	30	40	50	60	70	75	100	200	
Device												
1245	8.66E-02	8.64E-02	8.60E-02	8.58E-02	8.58E-02	8.58E-02	8.58E-02	8.58E-02	8.58E-02	8.61E-02	8.70E-02	
1246	8.71E-02	8.71E-02	8.68E-02	8.66E-02	8.66E-02	8.66E-02	8.65E-02	8.65E-02	8.66E-02	8.68E-02	8.78E-02	
1247	8.68E-02	8.68E-02	8.64E-02	8.63E-02	8.63E-02	8.63E-02	8.63E-02	8.63E-02	8.63E-02	8.66E-02	8.74E-02	
1248	8.76E-02	8.77E-02	8.73E-02	8.71E-02	8.72E-02	8.72E-02	8.72E-02	8.73E-02	8.73E-02	8.75E-02	8.85E-02	
1249	8.64E-02	8.64E-02	8.61E-02	8.61E-02	8.61E-02	8.61E-02	8.61E-02	8.60E-02	8.61E-02	8.63E-02	8.72E-02	
1250	8.60E-02	8.60E-02	8.57E-02	8.56E-02	8.56E-02	8.56E-02	8.56E-02	8.57E-02	8.57E-02	8.58E-02	8.68E-02	
1251	8.68E-02	8.68E-02	8.66E-02	8.64E-02	8.64E-02	8.64E-02	8.64E-02	8.65E-02	8.64E-02	8.67E-02	8.75E-02	
1261	8.67E-02	8.68E-02	8.66E-02	8.65E-02	8.64E-02	8.65E-02	8.65E-02	8.65E-02	8.66E-02	8.67E-02	8.75E-02	
1262	8.65E-02	8.66E-02	8.64E-02	8.63E-02	8.63E-02	8.63E-02	8.63E-02	8.63E-02	8.63E-02	8.66E-02	8.74E-02	
1263	8.67E-02	8.67E-02	8.66E-02	8.64E-02	8.64E-02	8.64E-02	8.64E-02	8.65E-02	8.64E-02	8.67E-02	8.75E-02	
1264	8.61E-02	8.60E-02	8.58E-02	8.58E-02	8.57E-02	8.56E-02	8.56E-02	8.55E-02	8.55E-02	8.56E-02	8.56E-02	
1265	8.56E-02	8.57E-02	8.55E-02	8.53E-02	8.52E-02	8.52E-02	8.52E-02	8.51E-02	8.51E-02	8.52E-02	8.52E-02	
Biased Statistics												
Average Biased	8.67E-02	8.67E-02	8.64E-02	8.63E-02	8.63E-02	8.63E-02	8.63E-02	8.63E-02	8.64E-02	8.66E-02	8.75E-02	
Std Dev Biased	4.32E-04	4.48E-04	4.39E-04	4.25E-04	4.28E-04	4.36E-04	4.45E-04	4.43E-04	4.40E-04	4.61E-04	4.57E-04	
Ps90%/90% (+KTL) Biased	8.76E-02	8.76E-02	8.73E-02	8.72E-02	8.72E-02	8.72E-02	8.72E-02	8.73E-02	8.73E-02	8.75E-02	8.84E-02	
Ps90%/90% (-KTL) Biased	8.58E-02	8.58E-02	8.55E-02	8.54E-02	8.54E-02	8.54E-02	8.54E-02	8.54E-02	8.54E-02	8.56E-02	8.65E-02	
Specification MIN	7.50E-02	7.50E-02	7.50E-02	7.50E-02	7.50E-02	7.50E-02	7.50E-02	7.50E-02	7.50E-02	7.50E-02	7.50E-02	
Status	PASS	PASS	PASS	PASS	PASS	PASS	PASS	PASS	PASS	PASS	PASS	

An ISO 9001:2008 and DSCC Certified Company

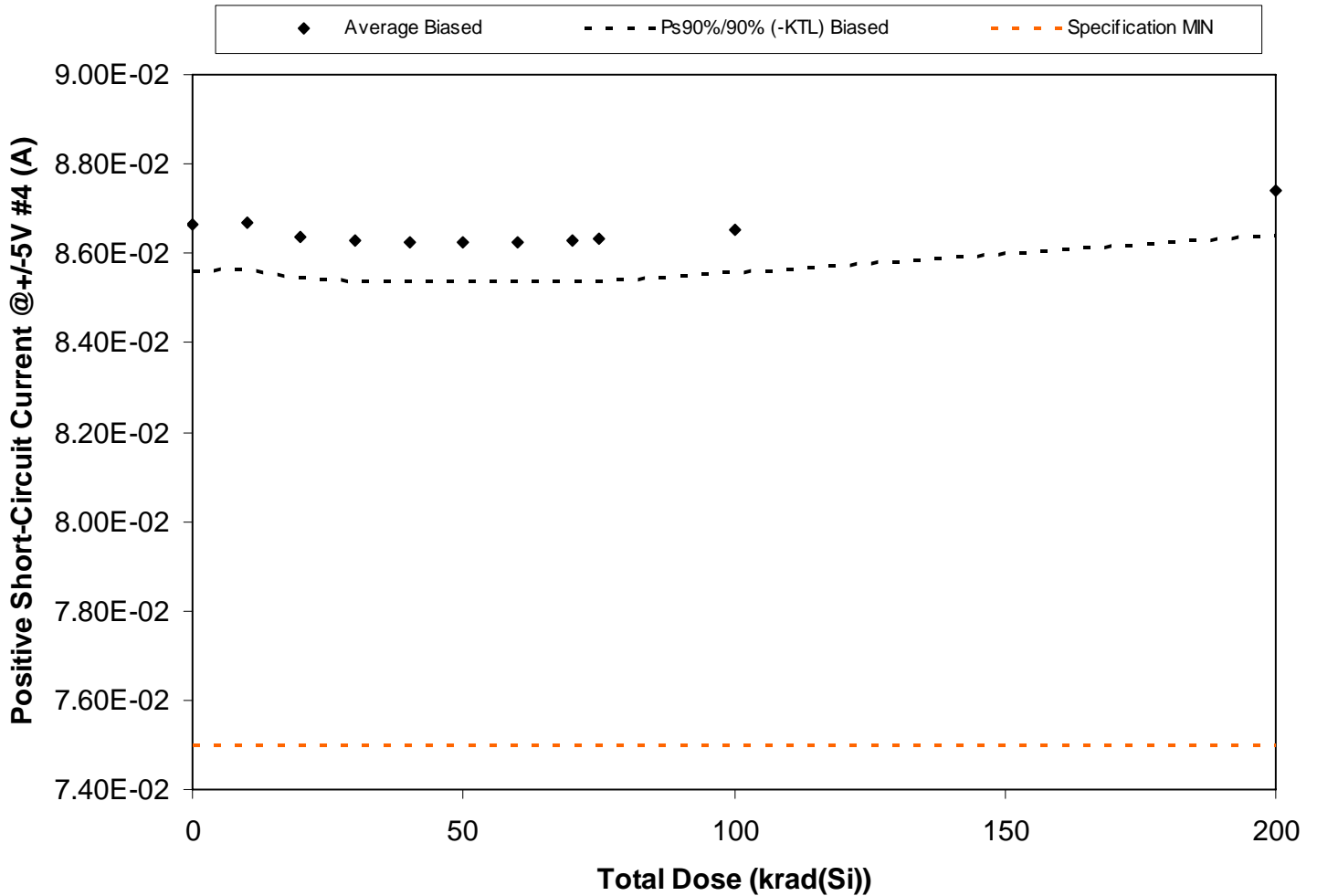

Figure 5.74. Plot of Positive Short-Circuit Current @ +/-5V #4 (A) versus total dose. The solid diamonds are the average of the measured data points for the samples irradiated under electrical bias and the black lines (solid and/or dashed) are the average of the data points after application of the KTL statistics on the samples irradiated under electrical bias. The red dotted line(s) are the pre- and/or post-irradiation minimum and/or maximum specification value as defined in the datasheet and/or test plan.



**RLAT Report
10-326 100808 R1.0**

**Radiation Assured Devices
5017 N. 30th Street
Colorado Springs, CO 80919
(719) 531-0800**

Table 5.74. Raw data for Positive Short-Circuit Current @+/-5V #4 (A) versus total dose, including the statistical analysis, specification and the status of the testing (pass/fail).

Positive Short-Circuit Current @+/-5V #4 (A)	Total Dose (krad(Si))											
	0	10	20	30	40	50	60	70	75	100	200	
Device												
1245	8.68E-02	8.66E-02	8.62E-02	8.61E-02	8.60E-02	8.60E-02	8.60E-02	8.60E-02	8.61E-02	8.63E-02	8.72E-02	
1246	8.70E-02	8.70E-02	8.67E-02	8.65E-02	8.64E-02	8.64E-02	8.64E-02	8.65E-02	8.66E-02	8.68E-02	8.77E-02	
1247	8.70E-02	8.70E-02	8.67E-02	8.65E-02	8.65E-02	8.65E-02	8.65E-02	8.65E-02	8.65E-02	8.68E-02	8.76E-02	
1248	8.74E-02	8.74E-02	8.71E-02	8.70E-02	8.70E-02	8.70E-02	8.70E-02	8.71E-02	8.71E-02	8.74E-02	8.83E-02	
1249	8.73E-02	8.73E-02	8.69E-02	8.69E-02	8.68E-02	8.68E-02	8.68E-02	8.69E-02	8.69E-02	8.70E-02	8.80E-02	
1250	8.62E-02	8.62E-02	8.59E-02	8.58E-02	8.58E-02	8.58E-02	8.58E-02	8.58E-02	8.58E-02	8.61E-02	8.70E-02	
1251	8.64E-02	8.64E-02	8.62E-02	8.61E-02	8.61E-02	8.61E-02	8.61E-02	8.61E-02	8.61E-02	8.63E-02	8.72E-02	
1261	8.62E-02	8.63E-02	8.61E-02	8.61E-02	8.60E-02	8.60E-02	8.61E-02	8.60E-02	8.61E-02	8.63E-02	8.71E-02	
1262	8.64E-02	8.65E-02	8.63E-02	8.62E-02	8.62E-02	8.62E-02	8.62E-02	8.62E-02	8.62E-02	8.64E-02	8.73E-02	
1263	8.59E-02	8.59E-02	8.58E-02	8.57E-02	8.57E-02	8.57E-02	8.57E-02	8.57E-02	8.57E-02	8.59E-02	8.68E-02	
1264	8.63E-02	8.63E-02	8.61E-02	8.61E-02	8.59E-02	8.58E-02	8.58E-02	8.58E-02	8.57E-02	8.58E-02	8.58E-02	
1265	8.62E-02	8.63E-02	8.61E-02	8.59E-02	8.58E-02	8.58E-02	8.58E-02	8.57E-02	8.57E-02	8.57E-02	8.58E-02	
Biased Statistics												
Average Biased	8.67E-02	8.67E-02	8.64E-02	8.63E-02	8.62E-02	8.63E-02	8.63E-02	8.63E-02	8.63E-02	8.65E-02	8.74E-02	
Std Dev Biased	5.16E-04	4.99E-04	4.46E-04	4.47E-04	4.25E-04	4.29E-04	4.26E-04	4.54E-04	4.58E-04	4.58E-04	4.85E-04	
Ps90%/90% (+KTL) Biased	8.77E-02	8.77E-02	8.73E-02	8.72E-02	8.71E-02	8.72E-02	8.71E-02	8.72E-02	8.73E-02	8.75E-02	8.84E-02	
Ps90%/90% (-KTL) Biased	8.56E-02	8.57E-02	8.55E-02	8.54E-02	8.54E-02	8.54E-02	8.54E-02	8.54E-02	8.54E-02	8.56E-02	8.64E-02	
Specification MIN	7.50E-02	7.50E-02	7.50E-02	7.50E-02	7.50E-02	7.50E-02	7.50E-02	7.50E-02	7.50E-02	7.50E-02	7.50E-02	
Status	PASS	PASS	PASS	PASS	PASS	PASS	PASS	PASS	PASS	PASS	PASS	

An ISO 9001:2008 and DSCC Certified Company

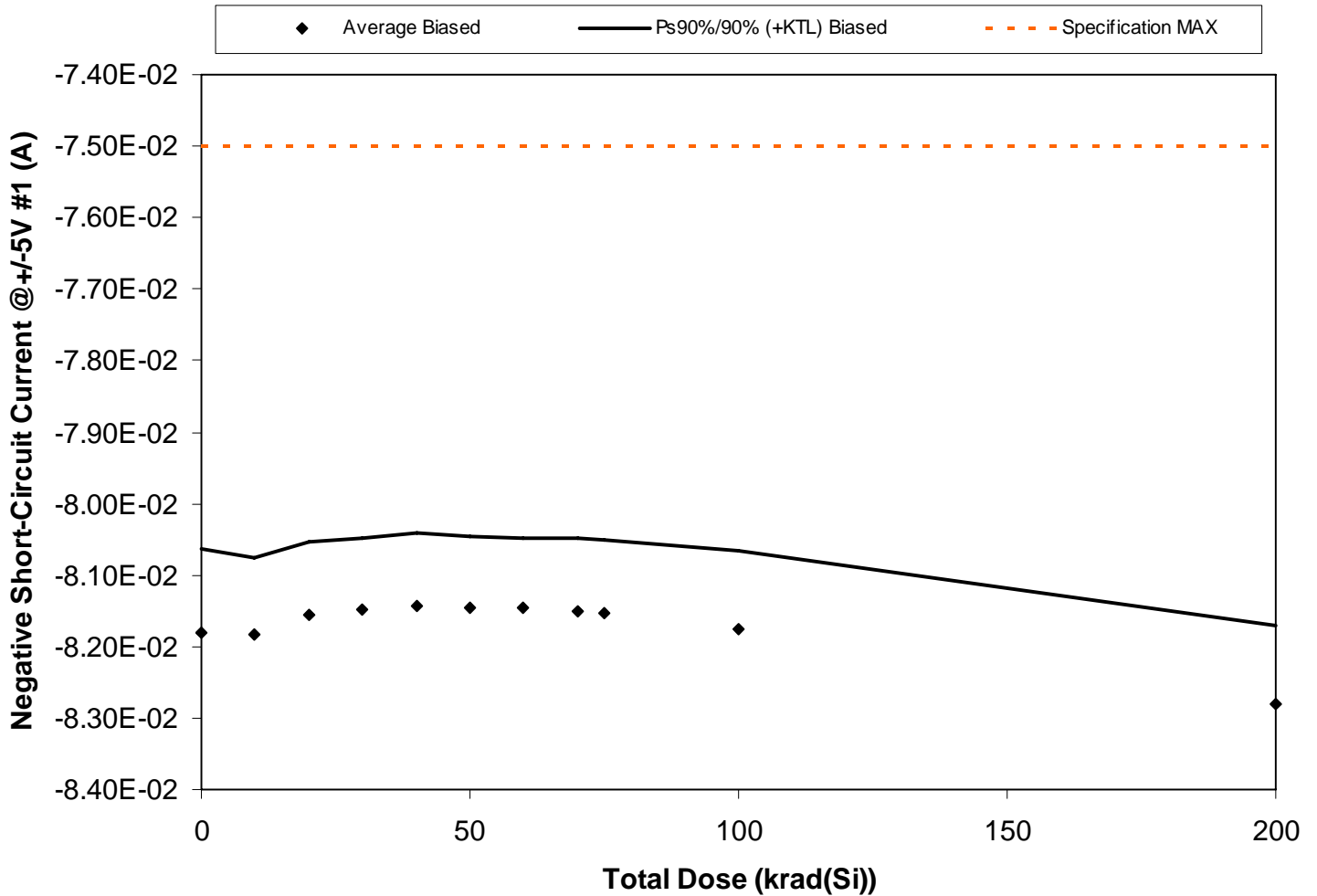

Figure 5.75. Plot of Negative Short-Circuit Current @ +/-5V #1 (A) versus total dose. The solid diamonds are the average of the measured data points for the samples irradiated under electrical bias and the black lines (solid and/or dashed) are the average of the data points after application of the KTL statistics on the samples irradiated under electrical bias. The red dotted line(s) are the pre- and/or post-irradiation minimum and/or maximum specification value as defined in the datasheet and/or test plan.



**RLAT Report
10-326 100808 R1.0**

**Radiation Assured Devices
5017 N. 30th Street
Colorado Springs, CO 80919
(719) 531-0800**

Table 5.75. Raw data for Negative Short-Circuit Current @+/-5V #1 (A) versus total dose, including the statistical analysis, specification and the status of the testing (pass/fail).

Negative Short-Circuit Current @+/-5V #1 (A)	Total Dose (krad(Si))											
	0	10	20	30	40	50	60	70	75	100	200	
Device												
1245	-8.18E-02	-8.17E-02	-8.13E-02	-8.12E-02	-8.11E-02	-8.11E-02	-8.11E-02	-8.11E-02	-8.12E-02	-8.14E-02	-8.25E-02	
1246	-8.22E-02	-8.21E-02	-8.18E-02	-8.16E-02	-8.17E-02	-8.17E-02	-8.16E-02	-8.18E-02	-8.18E-02	-8.20E-02	-8.30E-02	
1247	-8.23E-02	-8.23E-02	-8.19E-02	-8.19E-02	-8.18E-02	-8.18E-02	-8.18E-02	-8.19E-02	-8.18E-02	-8.21E-02	-8.31E-02	
1248	-8.27E-02	-8.26E-02	-8.24E-02	-8.23E-02	-8.23E-02	-8.23E-02	-8.22E-02	-8.24E-02	-8.24E-02	-8.27E-02	-8.38E-02	
1249	-8.25E-02	-8.25E-02	-8.21E-02	-8.20E-02	-8.20E-02	-8.20E-02	-8.20E-02	-8.21E-02	-8.22E-02	-8.23E-02	-8.33E-02	
1250	-8.13E-02	-8.13E-02	-8.11E-02	-8.09E-02	-8.09E-02	-8.09E-02	-8.09E-02	-8.10E-02	-8.10E-02	-8.13E-02	-8.23E-02	
1251	-8.14E-02	-8.15E-02	-8.12E-02	-8.11E-02	-8.10E-02	-8.11E-02	-8.12E-02	-8.11E-02	-8.12E-02	-8.13E-02	-8.24E-02	
1261	-8.13E-02	-8.14E-02	-8.12E-02	-8.11E-02	-8.10E-02	-8.11E-02	-8.12E-02	-8.11E-02	-8.12E-02	-8.13E-02	-8.23E-02	
1262	-8.18E-02	-8.19E-02	-8.17E-02	-8.16E-02	-8.15E-02	-8.16E-02	-8.16E-02	-8.16E-02	-8.17E-02	-8.19E-02	-8.29E-02	
1263	-8.10E-02	-8.12E-02	-8.09E-02	-8.09E-02	-8.09E-02	-8.09E-02	-8.09E-02	-8.10E-02	-8.10E-02	-8.12E-02	-8.22E-02	
1264	-8.15E-02	-8.15E-02	-8.14E-02	-8.12E-02	-8.11E-02	-8.11E-02	-8.10E-02	-8.09E-02	-8.09E-02	-8.10E-02	-8.10E-02	
1265	-8.13E-02	-8.14E-02	-8.12E-02	-8.10E-02	-8.09E-02	-8.09E-02	-8.08E-02	-8.08E-02	-8.08E-02	-8.08E-02	-8.09E-02	
Biased Statistics												
Average Biased	-8.18E-02	-8.18E-02	-8.16E-02	-8.15E-02	-8.14E-02	-8.15E-02	-8.15E-02	-8.15E-02	-8.15E-02	-8.18E-02	-8.28E-02	
Std Dev Biased	5.75E-04	5.28E-04	4.89E-04	4.79E-04	4.90E-04	4.79E-04	4.74E-04	4.98E-04	4.96E-04	5.24E-04	5.30E-04	
Ps90%/90% (+KTL) Biased	-8.06E-02	-8.07E-02	-8.05E-02	-8.05E-02	-8.04E-02	-8.05E-02	-8.05E-02	-8.05E-02	-8.05E-02	-8.07E-02	-8.17E-02	
Ps90%/90% (-KTL) Biased	-8.30E-02	-8.29E-02	-8.26E-02	-8.25E-02	-8.24E-02	-8.24E-02	-8.24E-02	-8.25E-02	-8.26E-02	-8.28E-02	-8.39E-02	
Specification MAX	-7.50E-02	-7.50E-02	-7.50E-02	-7.50E-02	-7.50E-02	-7.50E-02	-7.50E-02	-7.50E-02	-7.50E-02	-7.50E-02	-7.50E-02	
Status	PASS	PASS	PASS	PASS	PASS	PASS	PASS	PASS	PASS	PASS	PASS	

An ISO 9001:2008 and DSCC Certified Company

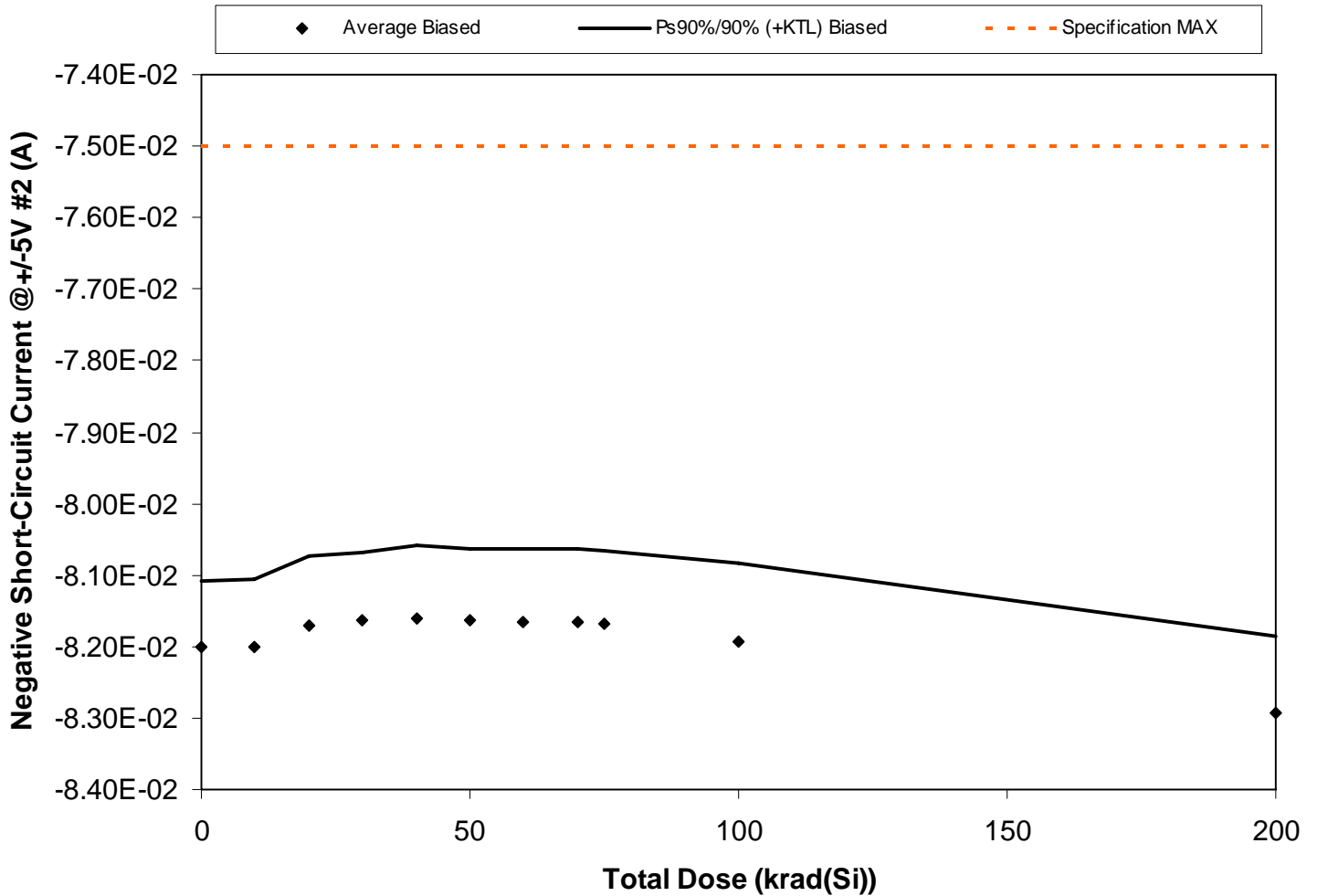

Figure 5.76. Plot of Negative Short-Circuit Current @ +/-5V #2 (A) versus total dose. The solid diamonds are the average of the measured data points for the samples irradiated under electrical bias and the black lines (solid and/or dashed) are the average of the data points after application of the KTL statistics on the samples irradiated under electrical bias. The red dotted line(s) are the pre- and/or post-irradiation minimum and/or maximum specification value as defined in the datasheet and/or test plan.



**RLAT Report
10-326 100808 R1.0**

**Radiation Assured Devices
5017 N. 30th Street
Colorado Springs, CO 80919
(719) 531-0800**

Table 5.76. Raw data for Negative Short-Circuit Current @+/-5V #2 (A) versus total dose, including the statistical analysis, specification and the status of the testing (pass/fail).

Negative Short-Circuit Current @+/-5V #2 (A)	Total Dose (krad(Si))											
	0	10	20	30	40	50	60	70	75	100	200	
Device												
1245	-8.17E-02	-8.15E-02	-8.12E-02	-8.10E-02	-8.10E-02	-8.10E-02	-8.10E-02	-8.10E-02	-8.11E-02	-8.13E-02	-8.23E-02	
1246	-8.25E-02	-8.24E-02	-8.20E-02	-8.19E-02	-8.19E-02	-8.19E-02	-8.19E-02	-8.19E-02	-8.19E-02	-8.21E-02	-8.32E-02	
1247	-8.19E-02	-8.19E-02	-8.15E-02	-8.14E-02	-8.14E-02	-8.14E-02	-8.14E-02	-8.15E-02	-8.14E-02	-8.17E-02	-8.27E-02	
1248	-8.29E-02	-8.29E-02	-8.26E-02	-8.25E-02	-8.25E-02	-8.25E-02	-8.26E-02	-8.26E-02	-8.26E-02	-8.30E-02	-8.40E-02	
1249	-8.18E-02	-8.18E-02	-8.14E-02	-8.14E-02	-8.13E-02	-8.14E-02	-8.14E-02	-8.14E-02	-8.14E-02	-8.16E-02	-8.26E-02	
1250	-8.13E-02	-8.12E-02	-8.10E-02	-8.09E-02	-8.08E-02	-8.09E-02	-8.09E-02	-8.09E-02	-8.09E-02	-8.12E-02	-8.21E-02	
1251	-8.20E-02	-8.20E-02	-8.18E-02	-8.17E-02	-8.17E-02	-8.17E-02	-8.18E-02	-8.18E-02	-8.18E-02	-8.20E-02	-8.31E-02	
1261	-8.19E-02	-8.20E-02	-8.18E-02	-8.18E-02	-8.18E-02	-8.18E-02	-8.18E-02	-8.18E-02	-8.18E-02	-8.20E-02	-8.30E-02	
1262	-8.19E-02	-8.20E-02	-8.18E-02	-8.18E-02	-8.17E-02	-8.18E-02	-8.18E-02	-8.18E-02	-8.18E-02	-8.20E-02	-8.30E-02	
1263	-8.21E-02	-8.22E-02	-8.20E-02	-8.20E-02	-8.19E-02	-8.20E-02	-8.20E-02	-8.20E-02	-8.20E-02	-8.23E-02	-8.32E-02	
1264	-8.13E-02	-8.13E-02	-8.11E-02	-8.10E-02	-8.09E-02	-8.08E-02	-8.08E-02	-8.07E-02	-8.07E-02	-8.08E-02	-8.08E-02	
1265	-8.09E-02	-8.10E-02	-8.07E-02	-8.06E-02	-8.05E-02	-8.05E-02	-8.04E-02	-8.04E-02	-8.03E-02	-8.04E-02	-8.04E-02	
Biased Statistics												
Average Biased	-8.20E-02	-8.20E-02	-8.17E-02	-8.16E-02	-8.16E-02	-8.16E-02	-8.16E-02	-8.17E-02	-8.17E-02	-8.19E-02	-8.29E-02	
Std Dev Biased	4.47E-04	4.53E-04	4.73E-04	4.62E-04	4.91E-04	4.78E-04	4.90E-04	4.92E-04	4.94E-04	5.21E-04	5.20E-04	
Ps90%/90% (+KTL) Biased	-8.11E-02	-8.11E-02	-8.07E-02	-8.07E-02	-8.06E-02	-8.06E-02	-8.06E-02	-8.06E-02	-8.07E-02	-8.08E-02	-8.19E-02	
Ps90%/90% (-KTL) Biased	-8.29E-02	-8.29E-02	-8.27E-02	-8.26E-02	-8.26E-02	-8.26E-02	-8.27E-02	-8.27E-02	-8.27E-02	-8.30E-02	-8.40E-02	
Specification MAX	-7.50E-02	-7.50E-02	-7.50E-02	-7.50E-02	-7.50E-02	-7.50E-02	-7.50E-02	-7.50E-02	-7.50E-02	-7.50E-02	-7.50E-02	
Status	PASS	PASS	PASS	PASS	PASS	PASS	PASS	PASS	PASS	PASS	PASS	

An ISO 9001:2008 and DSCC Certified Company

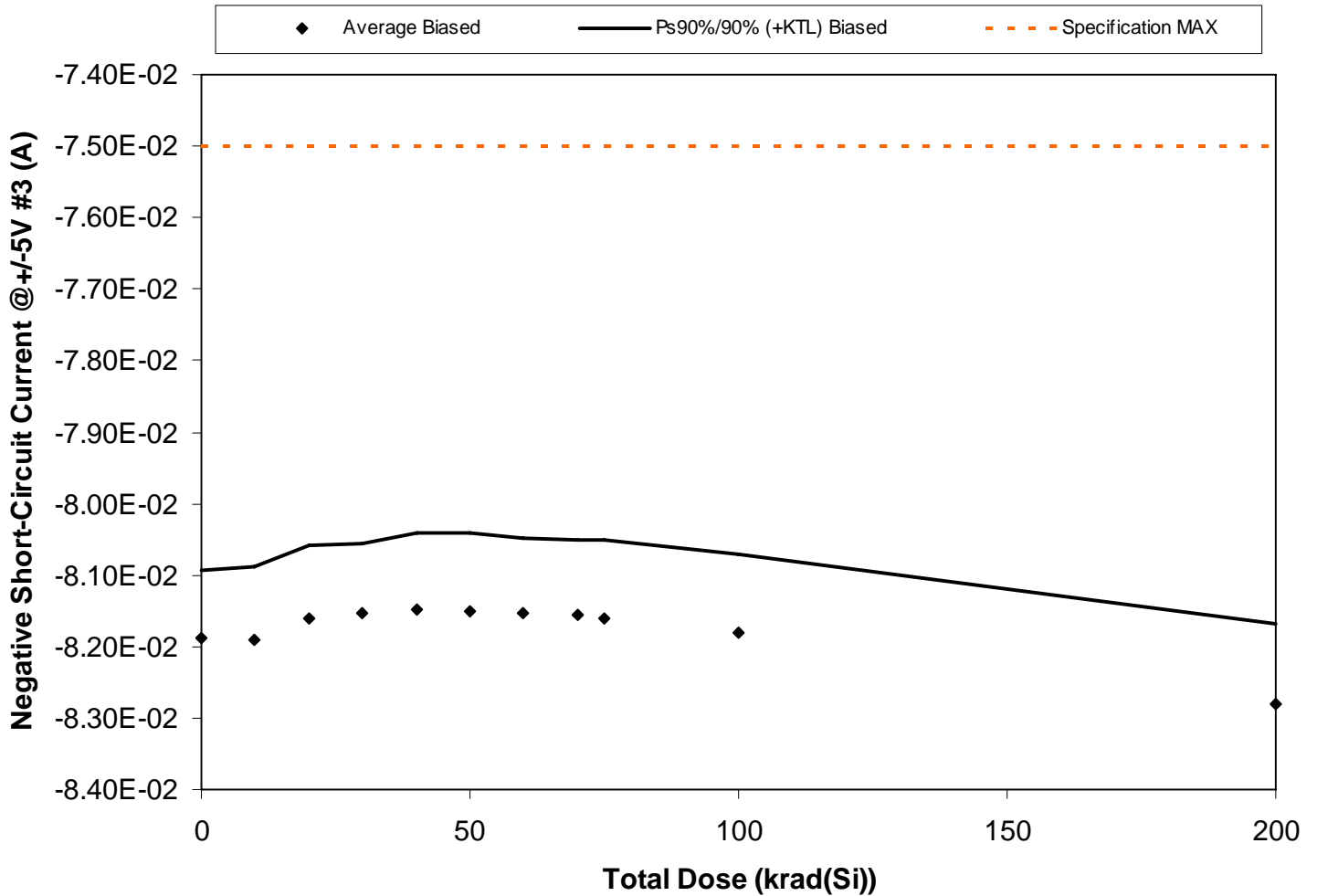

Figure 5.77. Plot of Negative Short-Circuit Current @ +/-5V #3 (A) versus total dose. The solid diamonds are the average of the measured data points for the samples irradiated under electrical bias and the black lines (solid and/or dashed) are the average of the data points after application of the KTL statistics on the samples irradiated under electrical bias. The red dotted line(s) are the pre- and/or post-irradiation minimum and/or maximum specification value as defined in the datasheet and/or test plan.



**RLAT Report
10-326 100808 R1.0**

**Radiation Assured Devices
5017 N. 30th Street
Colorado Springs, CO 80919
(719) 531-0800**

Table 5.77. Raw data for Negative Short-Circuit Current @+/-5V #3 (A) versus total dose, including the statistical analysis, specification and the status of the testing (pass/fail).

Negative Short-Circuit Current @+/-5V #3 (A)	Total Dose (krad(Si))											
	0	10	20	30	40	50	60	70	75	100	200	
Device												
1245	-8.15E-02	-8.14E-02	-8.11E-02	-8.09E-02	-8.08E-02	-8.08E-02	-8.08E-02	-8.09E-02	-8.09E-02	-8.12E-02	-8.21E-02	
1246	-8.22E-02	-8.22E-02	-8.19E-02	-8.18E-02	-8.17E-02	-8.17E-02	-8.18E-02	-8.17E-02	-8.18E-02	-8.20E-02	-8.31E-02	
1247	-8.19E-02	-8.19E-02	-8.16E-02	-8.15E-02	-8.14E-02	-8.14E-02	-8.14E-02	-8.15E-02	-8.15E-02	-8.18E-02	-8.27E-02	
1248	-8.29E-02	-8.29E-02	-8.25E-02	-8.24E-02	-8.24E-02	-8.25E-02	-8.25E-02	-8.25E-02	-8.26E-02	-8.29E-02	-8.39E-02	
1249	-8.15E-02	-8.15E-02	-8.12E-02	-8.11E-02	-8.10E-02	-8.11E-02	-8.12E-02	-8.11E-02	-8.12E-02	-8.14E-02	-8.24E-02	
1250	-8.11E-02	-8.11E-02	-8.08E-02	-8.08E-02	-8.07E-02	-8.07E-02	-8.08E-02	-8.08E-02	-8.08E-02	-8.10E-02	-8.20E-02	
1251	-8.20E-02	-8.21E-02	-8.19E-02	-8.18E-02	-8.18E-02	-8.18E-02	-8.18E-02	-8.19E-02	-8.19E-02	-8.20E-02	-8.31E-02	
1261	-8.19E-02	-8.20E-02	-8.18E-02	-8.18E-02	-8.17E-02	-8.17E-02	-8.18E-02	-8.18E-02	-8.18E-02	-8.20E-02	-8.29E-02	
1262	-8.18E-02	-8.18E-02	-8.16E-02	-8.15E-02	-8.15E-02	-8.15E-02	-8.15E-02	-8.15E-02	-8.15E-02	-8.18E-02	-8.27E-02	
1263	-8.20E-02	-8.20E-02	-8.19E-02	-8.18E-02	-8.18E-02	-8.18E-02	-8.18E-02	-8.19E-02	-8.19E-02	-8.21E-02	-8.31E-02	
1264	-8.13E-02	-8.14E-02	-8.12E-02	-8.10E-02	-8.09E-02	-8.09E-02	-8.08E-02	-8.08E-02	-8.07E-02	-8.08E-02	-8.09E-02	
1265	-8.08E-02	-8.08E-02	-8.06E-02	-8.05E-02	-8.04E-02	-8.03E-02	-8.03E-02	-8.03E-02	-8.02E-02	-8.03E-02	-8.03E-02	
Biased Statistics												
Average Biased	-8.19E-02	-8.19E-02	-8.16E-02	-8.15E-02	-8.15E-02	-8.15E-02	-8.15E-02	-8.16E-02	-8.16E-02	-8.18E-02	-8.28E-02	
Std Dev Biased	4.64E-04	4.93E-04	4.95E-04	4.72E-04	5.14E-04	5.27E-04	5.08E-04	5.09E-04	5.24E-04	5.31E-04	5.43E-04	
Ps90%/90% (+KTL) Biased	-8.09E-02	-8.09E-02	-8.06E-02	-8.06E-02	-8.04E-02	-8.04E-02	-8.05E-02	-8.05E-02	-8.05E-02	-8.07E-02	-8.17E-02	
Ps90%/90% (-KTL) Biased	-8.28E-02	-8.29E-02	-8.26E-02	-8.25E-02	-8.25E-02	-8.26E-02	-8.26E-02	-8.26E-02	-8.27E-02	-8.29E-02	-8.39E-02	
Specification MAX	-7.50E-02	-7.50E-02	-7.50E-02	-7.50E-02	-7.50E-02	-7.50E-02	-7.50E-02	-7.50E-02	-7.50E-02	-7.50E-02	-7.50E-02	
Status	PASS	PASS	PASS	PASS	PASS	PASS	PASS	PASS	PASS	PASS	PASS	

An ISO 9001:2008 and DSCC Certified Company

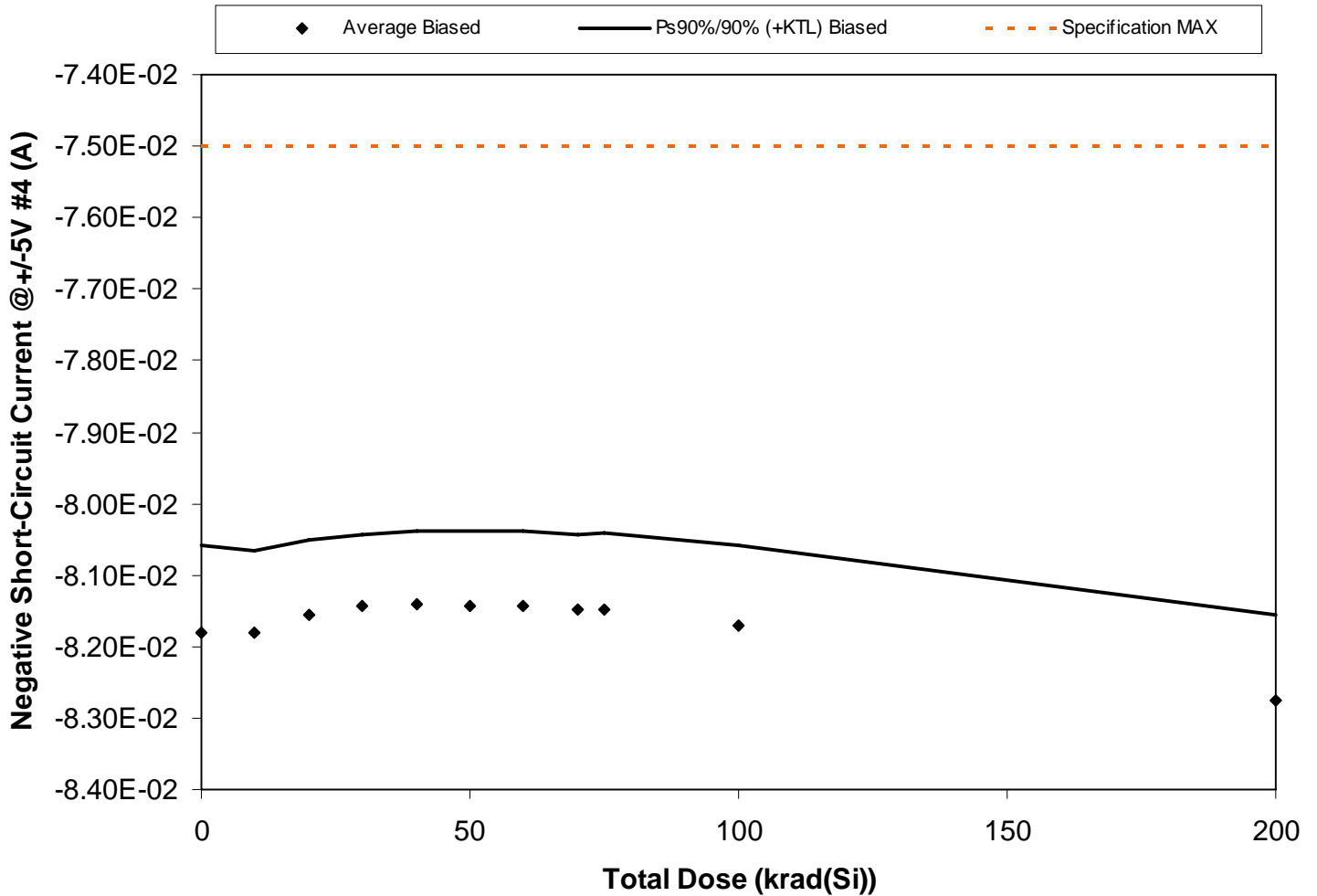

Figure 5.78. Plot of Negative Short-Circuit Current @ +/-5V #4 (A) versus total dose. The solid diamonds are the average of the measured data points for the samples irradiated under electrical bias and the black lines (solid and/or dashed) are the average of the data points after application of the KTL statistics on the samples irradiated under electrical bias. The red dotted line(s) are the pre- and/or post-irradiation minimum and/or maximum specification value as defined in the datasheet and/or test plan.



**RLAT Report
10-326 100808 R1.0**

**Radiation Assured Devices
5017 N. 30th Street
Colorado Springs, CO 80919
(719) 531-0800**

Table 5.78. Raw data for Negative Short-Circuit Current @+/-5V #4 (A) versus total dose, including the statistical analysis, specification and the status of the testing (pass/fail).

Negative Short-Circuit Current @+/-5V #4 (A)	Total Dose (krad(Si))											
	0	10	20	30	40	50	60	70	75	100	200	
Device												
1245	-8.19E-02	-8.17E-02	-8.14E-02	-8.12E-02	-8.12E-02	-8.12E-02	-8.12E-02	-8.11E-02	-8.12E-02	-8.15E-02	-8.24E-02	
1246	-8.22E-02	-8.22E-02	-8.18E-02	-8.17E-02	-8.16E-02	-8.17E-02	-8.17E-02	-8.17E-02	-8.18E-02	-8.20E-02	-8.31E-02	
1247	-8.22E-02	-8.23E-02	-8.19E-02	-8.18E-02	-8.18E-02	-8.18E-02	-8.18E-02	-8.18E-02	-8.18E-02	-8.20E-02	-8.31E-02	
1248	-8.26E-02	-8.26E-02	-8.24E-02	-8.22E-02	-8.23E-02	-8.23E-02	-8.23E-02	-8.24E-02	-8.24E-02	-8.27E-02	-8.38E-02	
1249	-8.25E-02	-8.24E-02	-8.21E-02	-8.20E-02	-8.20E-02	-8.20E-02	-8.20E-02	-8.21E-02	-8.20E-02	-8.23E-02	-8.34E-02	
1250	-8.12E-02	-8.11E-02	-8.09E-02	-8.08E-02	-8.08E-02	-8.08E-02	-8.08E-02	-8.08E-02	-8.09E-02	-8.10E-02	-8.21E-02	
1251	-8.14E-02	-8.14E-02	-8.12E-02	-8.12E-02	-8.11E-02	-8.11E-02	-8.11E-02	-8.12E-02	-8.12E-02	-8.14E-02	-8.24E-02	
1261	-8.13E-02	-8.15E-02	-8.13E-02	-8.12E-02	-8.12E-02	-8.12E-02	-8.12E-02	-8.13E-02	-8.12E-02	-8.14E-02	-8.24E-02	
1262	-8.16E-02	-8.18E-02	-8.15E-02	-8.15E-02	-8.14E-02	-8.15E-02	-8.15E-02	-8.15E-02	-8.15E-02	-8.18E-02	-8.27E-02	
1263	-8.10E-02	-8.10E-02	-8.09E-02	-8.08E-02	-8.08E-02	-8.08E-02	-8.08E-02	-8.09E-02	-8.08E-02	-8.10E-02	-8.20E-02	
1264	-8.14E-02	-8.15E-02	-8.13E-02	-8.12E-02	-8.11E-02	-8.10E-02	-8.09E-02	-8.09E-02	-8.09E-02	-8.09E-02	-8.10E-02	
1265	-8.15E-02	-8.16E-02	-8.13E-02	-8.12E-02	-8.12E-02	-8.10E-02	-8.10E-02	-8.10E-02	-8.09E-02	-8.10E-02	-8.10E-02	
Biased Statistics												
Average Biased	-8.18E-02	-8.18E-02	-8.15E-02	-8.14E-02	-8.14E-02	-8.14E-02	-8.14E-02	-8.15E-02	-8.15E-02	-8.17E-02	-8.27E-02	
Std Dev Biased	5.84E-04	5.53E-04	5.03E-04	4.91E-04	4.99E-04	5.01E-04	5.10E-04	5.09E-04	5.17E-04	5.46E-04	5.80E-04	
Ps90%/90% (+KTL) Biased	-8.06E-02	-8.07E-02	-8.05E-02	-8.04E-02	-8.04E-02	-8.04E-02	-8.04E-02	-8.04E-02	-8.04E-02	-8.06E-02	-8.15E-02	
Ps90%/90% (-KTL) Biased	-8.30E-02	-8.29E-02	-8.26E-02	-8.24E-02	-8.24E-02	-8.25E-02	-8.25E-02	-8.25E-02	-8.25E-02	-8.28E-02	-8.39E-02	
Specification MAX	-7.50E-02	-7.50E-02	-7.50E-02	-7.50E-02	-7.50E-02	-7.50E-02	-7.50E-02	-7.50E-02	-7.50E-02	-7.50E-02	-7.50E-02	
Status	PASS	PASS	PASS	PASS	PASS	PASS	PASS	PASS	PASS	PASS	PASS	

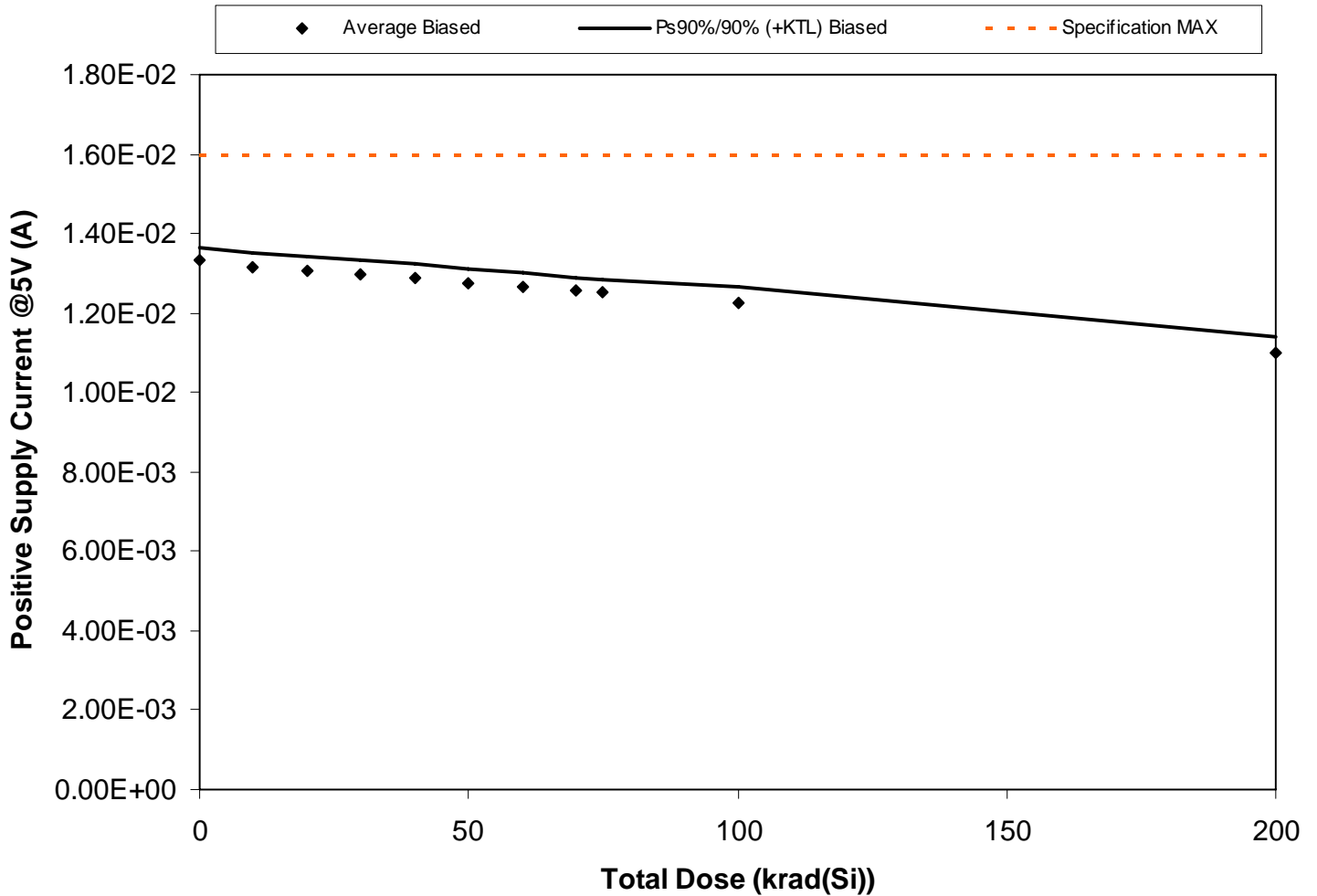

Figure 5.79. Plot of Positive Supply Current @5V (A) versus total dose. The solid diamonds are the average of the measured data points for the samples irradiated under electrical bias and the black lines (solid and/or dashed) are the average of the data points after application of the KTL statistics on the samples irradiated under electrical bias. The red dotted line(s) are the pre- and/or post-irradiation minimum and/or maximum specification value as defined in the datasheet and/or test plan.



**RLAT Report
10-326 100808 R1.0**

**Radiation Assured Devices
5017 N. 30th Street
Colorado Springs, CO 80919
(719) 531-0800**

Table 5.79. Raw data for Positive Supply Current @5V (A) versus total dose, including the statistical analysis, specification and the status of the testing (pass/fail).

Positive Supply Current @5V (A)	Total Dose (krad(Si))											
	0	10	20	30	40	50	60	70	75	100	200	
Device												
1245	1.32E-02	1.31E-02	1.30E-02	1.29E-02	1.28E-02	1.27E-02	1.26E-02	1.25E-02	1.25E-02	1.23E-02	1.10E-02	
1246	1.32E-02	1.31E-02	1.29E-02	1.29E-02	1.28E-02	1.27E-02	1.26E-02	1.24E-02	1.24E-02	1.22E-02	1.09E-02	
1247	1.34E-02	1.32E-02	1.32E-02	1.31E-02	1.30E-02	1.29E-02	1.28E-02	1.27E-02	1.27E-02	1.25E-02	1.12E-02	
1248	1.34E-02	1.32E-02	1.31E-02	1.30E-02	1.28E-02	1.27E-02	1.25E-02	1.24E-02	1.23E-02	1.20E-02	1.07E-02	
1249	1.36E-02	1.34E-02	1.33E-02	1.32E-02	1.31E-02	1.29E-02	1.28E-02	1.27E-02	1.27E-02	1.24E-02	1.12E-02	
1250	1.34E-02	1.33E-02	1.32E-02	1.31E-02	1.30E-02	1.29E-02	1.28E-02	1.27E-02	1.26E-02	1.24E-02	1.11E-02	
1251	1.31E-02	1.29E-02	1.28E-02	1.27E-02	1.26E-02	1.25E-02	1.24E-02	1.23E-02	1.23E-02	1.20E-02	1.08E-02	
1261	1.33E-02	1.30E-02	1.29E-02	1.29E-02	1.28E-02	1.27E-02	1.26E-02	1.25E-02	1.25E-02	1.23E-02	1.11E-02	
1262	1.31E-02	1.29E-02	1.28E-02	1.28E-02	1.27E-02	1.26E-02	1.25E-02	1.24E-02	1.24E-02	1.21E-02	1.09E-02	
1263	1.35E-02	1.34E-02	1.33E-02	1.32E-02	1.31E-02	1.30E-02	1.29E-02	1.28E-02	1.28E-02	1.25E-02	1.12E-02	
1264	1.32E-02	1.31E-02	1.31E-02	1.31E-02	1.31E-02	1.31E-02	1.31E-02	1.31E-02	1.32E-02	1.31E-02	1.32E-02	
1265	1.34E-02	1.32E-02	1.32E-02	1.32E-02	1.32E-02	1.32E-02	1.32E-02	1.33E-02	1.33E-02	1.33E-02	1.33E-02	
Biased Statistics												
Average Biased	1.33E-02	1.32E-02	1.31E-02	1.30E-02	1.29E-02	1.28E-02	1.27E-02	1.26E-02	1.25E-02	1.23E-02	1.10E-02	
Std Dev Biased	1.63E-04	1.77E-04	1.79E-04	1.73E-04	1.69E-04	1.64E-04	1.66E-04	1.65E-04	1.70E-04	1.85E-04	1.88E-04	
Ps90%/90% (+KTL) Biased	1.37E-02	1.35E-02	1.34E-02	1.33E-02	1.32E-02	1.31E-02	1.30E-02	1.29E-02	1.29E-02	1.26E-02	1.14E-02	
Ps90%/90% (-KTL) Biased	1.30E-02	1.28E-02	1.27E-02	1.26E-02	1.25E-02	1.24E-02	1.23E-02	1.22E-02	1.22E-02	1.19E-02	1.06E-02	
Specification MAX	1.60E-02	1.60E-02	1.60E-02	1.60E-02	1.60E-02	1.60E-02	1.60E-02	1.60E-02	1.60E-02	1.60E-02	1.60E-02	
Status	PASS	PASS	PASS	PASS	PASS	PASS	PASS	PASS	PASS	PASS	PASS	

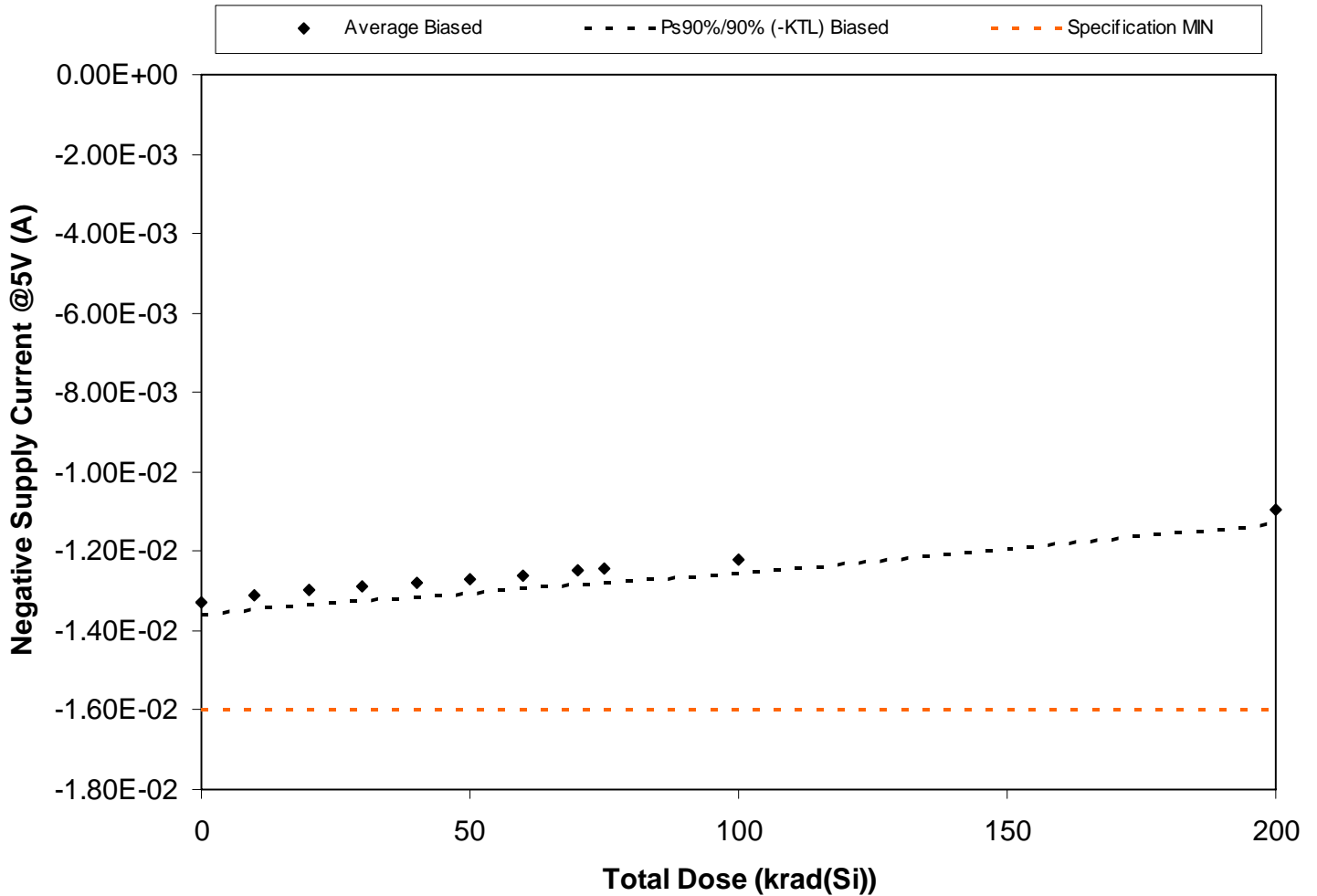

Figure 5.80. Plot of Negative Supply Current @5V (A) versus total dose. The solid diamonds are the average of the measured data points for the samples irradiated under electrical bias and the black lines (solid and/or dashed) are the average of the data points after application of the KTL statistics on the samples irradiated under electrical bias. The red dotted line(s) are the pre- and/or post-irradiation minimum and/or maximum specification value as defined in the datasheet and/or test plan.



Table 5.80. Raw data for Negative Supply Current @5V (A) versus total dose, including the statistical analysis, specification and the status of the testing (pass/fail).

Negative Supply Current @5V (A)	Total Dose (krad(Si))											
	0	10	20	30	40	50	60	70	75	100	200	
Device												
1245	-1.32E-02	-1.31E-02	-1.29E-02	-1.29E-02	-1.28E-02	-1.27E-02	-1.26E-02	-1.25E-02	-1.24E-02	-1.22E-02	-1.10E-02	
1246	-1.32E-02	-1.30E-02	-1.29E-02	-1.28E-02	-1.27E-02	-1.26E-02	-1.25E-02	-1.24E-02	-1.24E-02	-1.21E-02	-1.09E-02	
1247	-1.34E-02	-1.32E-02	-1.31E-02	-1.30E-02	-1.29E-02	-1.28E-02	-1.28E-02	-1.26E-02	-1.26E-02	-1.24E-02	-1.12E-02	
1248	-1.33E-02	-1.32E-02	-1.30E-02	-1.29E-02	-1.28E-02	-1.26E-02	-1.25E-02	-1.23E-02	-1.23E-02	-1.19E-02	-1.06E-02	
1249	-1.35E-02	-1.33E-02	-1.32E-02	-1.31E-02	-1.30E-02	-1.29E-02	-1.28E-02	-1.27E-02	-1.26E-02	-1.24E-02	-1.11E-02	
1250	-1.33E-02	-1.33E-02	-1.32E-02	-1.31E-02	-1.30E-02	-1.29E-02	-1.27E-02	-1.26E-02	-1.26E-02	-1.23E-02	-1.10E-02	
1251	-1.30E-02	-1.28E-02	-1.27E-02	-1.26E-02	-1.25E-02	-1.25E-02	-1.23E-02	-1.22E-02	-1.22E-02	-1.20E-02	-1.07E-02	
1261	-1.32E-02	-1.30E-02	-1.29E-02	-1.28E-02	-1.27E-02	-1.26E-02	-1.25E-02	-1.24E-02	-1.24E-02	-1.22E-02	-1.10E-02	
1262	-1.31E-02	-1.29E-02	-1.28E-02	-1.27E-02	-1.26E-02	-1.25E-02	-1.24E-02	-1.23E-02	-1.23E-02	-1.21E-02	-1.09E-02	
1263	-1.35E-02	-1.33E-02	-1.32E-02	-1.31E-02	-1.30E-02	-1.29E-02	-1.28E-02	-1.27E-02	-1.27E-02	-1.24E-02	-1.12E-02	
1264	-1.32E-02	-1.30E-02	-1.30E-02	-1.30E-02	-1.31E-02	-1.31E-02	-1.31E-02	-1.31E-02	-1.31E-02	-1.31E-02	-1.31E-02	
1265	-1.33E-02	-1.31E-02	-1.32E-02	-1.31E-02	-1.32E-02	-1.32E-02	-1.32E-02	-1.32E-02	-1.32E-02	-1.32E-02	-1.32E-02	
Biased Statistics												
Average Biased	-1.33E-02	-1.31E-02	-1.30E-02	-1.29E-02	-1.28E-02	-1.27E-02	-1.26E-02	-1.25E-02	-1.24E-02	-1.22E-02	-1.10E-02	
Std Dev Biased	1.65E-04	1.80E-04	1.78E-04	1.71E-04	1.71E-04	1.67E-04	1.67E-04	1.68E-04	1.71E-04	1.81E-04	1.84E-04	
Ps90%/90% (+KTL) Biased	-1.29E-02	-1.27E-02	-1.26E-02	-1.26E-02	-1.25E-02	-1.24E-02	-1.22E-02	-1.21E-02	-1.21E-02	-1.18E-02	-1.06E-02	
Ps90%/90% (-KTL) Biased	-1.36E-02	-1.35E-02	-1.34E-02	-1.33E-02	-1.32E-02	-1.30E-02	-1.29E-02	-1.28E-02	-1.28E-02	-1.26E-02	-1.13E-02	
Specification MIN	-1.60E-02	-1.60E-02	-1.60E-02	-1.60E-02	-1.60E-02	-1.60E-02	-1.60E-02	-1.60E-02	-1.60E-02	-1.60E-02	-1.60E-02	
Status	PASS	PASS	PASS	PASS	PASS	PASS	PASS	PASS	PASS	PASS	PASS	

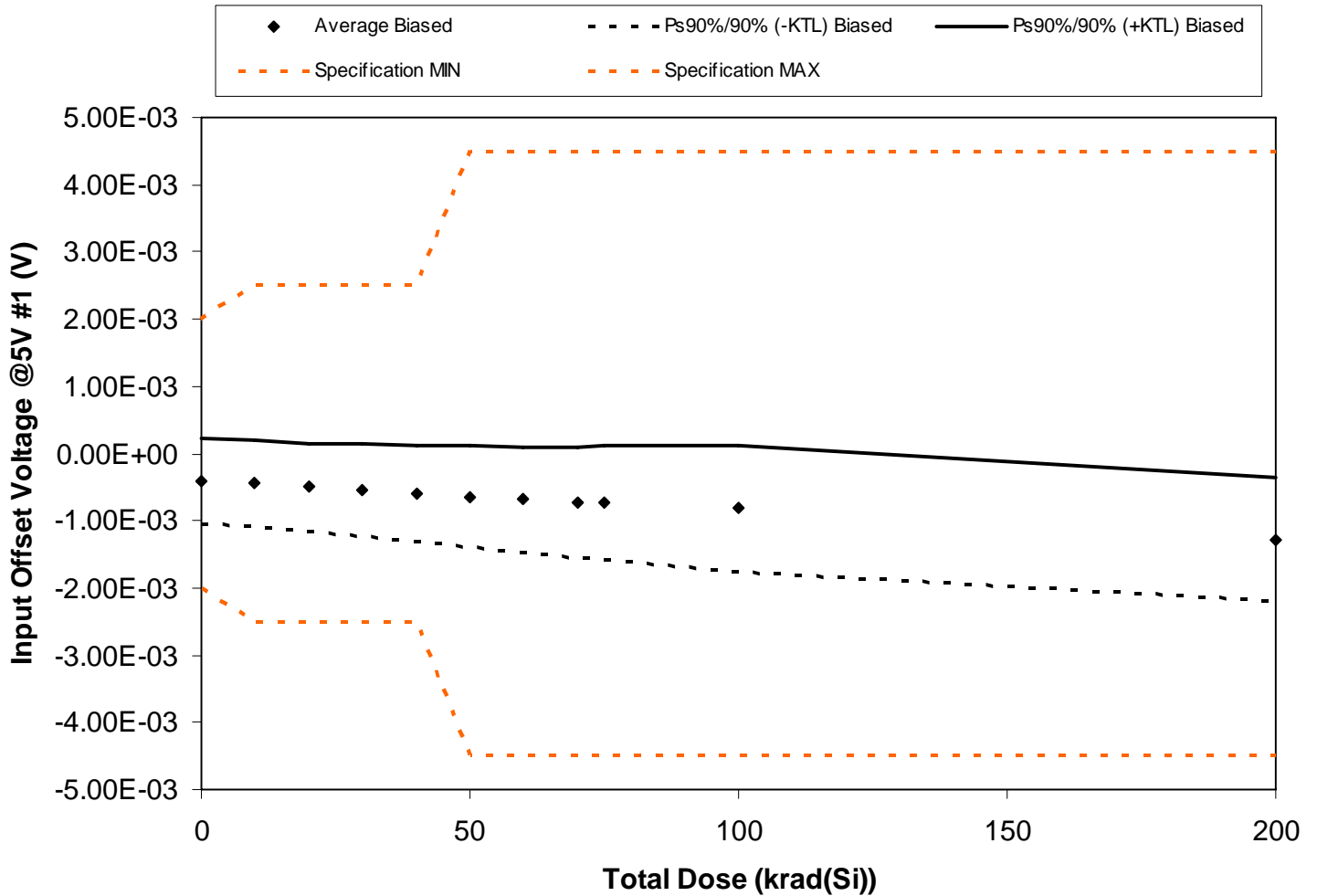

Figure 5.81. Plot of Input Offset Voltage @5V #1 (V) versus total dose. The solid diamonds are the average of the measured data points for the samples irradiated under electrical bias and the black lines (solid and/or dashed) are the average of the data points after application of the KTL statistics on the samples irradiated under electrical bias. The red dotted line(s) are the pre- and/or post-irradiation minimum and/or maximum specification value as defined in the datasheet and/or test plan.



**RLAT Report
10-326 100808 R1.0**

**Radiation Assured Devices
5017 N. 30th Street
Colorado Springs, CO 80919
(719) 531-0800**

Table 5.81. Raw data for Input Offset Voltage @5V #1 (V) versus total dose, including the statistical analysis, specification and the status of the testing (pass/fail).

Input Offset Voltage @5V #1 (V)	Total Dose (krad(Si))										
	0	10	20	30	40	50	60	70	75	100	200
Device											
1245	-2.49E-04	-2.87E-04	-3.34E-04	-3.77E-04	-4.27E-04	-4.71E-04	-5.04E-04	-5.35E-04	-5.43E-04	-6.10E-04	-1.14E-03
1246	-1.05E-04	-1.33E-04	-1.79E-04	-2.24E-04	-2.65E-04	-2.89E-04	-3.16E-04	-3.37E-04	-3.34E-04	-3.95E-04	-7.37E-04
1247	-9.40E-05	-1.37E-04	-1.92E-04	-2.49E-04	-3.00E-04	-3.50E-04	-3.98E-04	-4.38E-04	-4.47E-04	-5.32E-04	-1.12E-03
1248	-1.10E-03	-1.13E-03	-1.21E-03	-1.31E-03	-1.42E-03	-1.53E-03	-1.63E-03	-1.73E-03	-1.75E-03	-2.00E-03	-2.39E-03
1249	-3.01E-04	-3.35E-04	-3.79E-04	-4.23E-04	-4.67E-04	-5.11E-04	-5.46E-04	-5.89E-04	-5.94E-04	-6.82E-04	-1.21E-03
1250	-8.06E-04	-8.24E-04	-8.72E-04	-9.17E-04	-9.54E-04	-9.89E-04	-1.01E-03	-1.03E-03	-1.02E-03	-1.07E-03	-1.49E-03
1251	-4.15E-04	-4.47E-04	-5.00E-04	-5.42E-04	-5.77E-04	-6.06E-04	-6.40E-04	-6.68E-04	-6.75E-04	-7.27E-04	-1.19E-03
1261	-3.64E-04	-4.03E-04	-4.66E-04	-5.19E-04	-5.71E-04	-6.13E-04	-6.58E-04	-6.91E-04	-6.95E-04	-7.67E-04	-1.28E-03
1262	-4.21E-04	-4.65E-04	-5.21E-04	-5.81E-04	-6.30E-04	-6.71E-04	-7.09E-04	-7.39E-04	-7.51E-04	-8.29E-04	-1.33E-03
1263	-2.49E-04	-2.87E-04	-3.39E-04	-3.79E-04	-4.08E-04	-4.42E-04	-4.67E-04	-4.78E-04	-4.76E-04	-5.17E-04	-9.14E-04
1264	-4.36E-04	-4.37E-04	-4.37E-04	-4.38E-04	-4.36E-04	-4.38E-04	-4.39E-04	-4.37E-04	-4.39E-04	-4.40E-04	-4.39E-04
1265	-5.69E-04	-5.65E-04	-5.69E-04	-5.69E-04	-5.69E-04	-5.69E-04	-5.69E-04	-5.70E-04	-5.69E-04	-5.69E-04	-5.69E-04
Biased Statistics											
Average Biased	-4.10E-04	-4.45E-04	-5.00E-04	-5.53E-04	-6.02E-04	-6.47E-04	-6.88E-04	-7.23E-04	-7.28E-04	-8.13E-04	-1.28E-03
Std Dev Biased	3.14E-04	3.10E-04	3.19E-04	3.32E-04	3.47E-04	3.66E-04	3.82E-04	4.01E-04	4.06E-04	4.57E-04	4.43E-04
Ps90%/90% (+KTL) Biased	2.38E-04	1.96E-04	1.59E-04	1.33E-04	1.16E-04	1.09E-04	1.02E-04	1.05E-04	1.11E-04	1.31E-04	-3.64E-04
Ps90%/90% (-KTL) Biased	-1.06E-03	-1.09E-03	-1.16E-03	-1.24E-03	-1.32E-03	-1.40E-03	-1.48E-03	-1.55E-03	-1.57E-03	-1.76E-03	-2.19E-03
Specification MIN	-2.00E-03	-2.50E-03	-2.50E-03	-2.50E-03	-2.50E-03	-4.50E-03	-4.50E-03	-4.50E-03	-4.50E-03	-4.50E-03	-4.50E-03
Status	PASS	PASS	PASS	PASS	PASS	PASS	PASS	PASS	PASS	PASS	PASS
Specification MAX	2.00E-03	2.50E-03	2.50E-03	2.50E-03	2.50E-03	4.50E-03	4.50E-03	4.50E-03	4.50E-03	4.50E-03	4.50E-03
Status	PASS	PASS	PASS	PASS	PASS	PASS	PASS	PASS	PASS	PASS	PASS

An ISO 9001:2008 and DSCC Certified Company

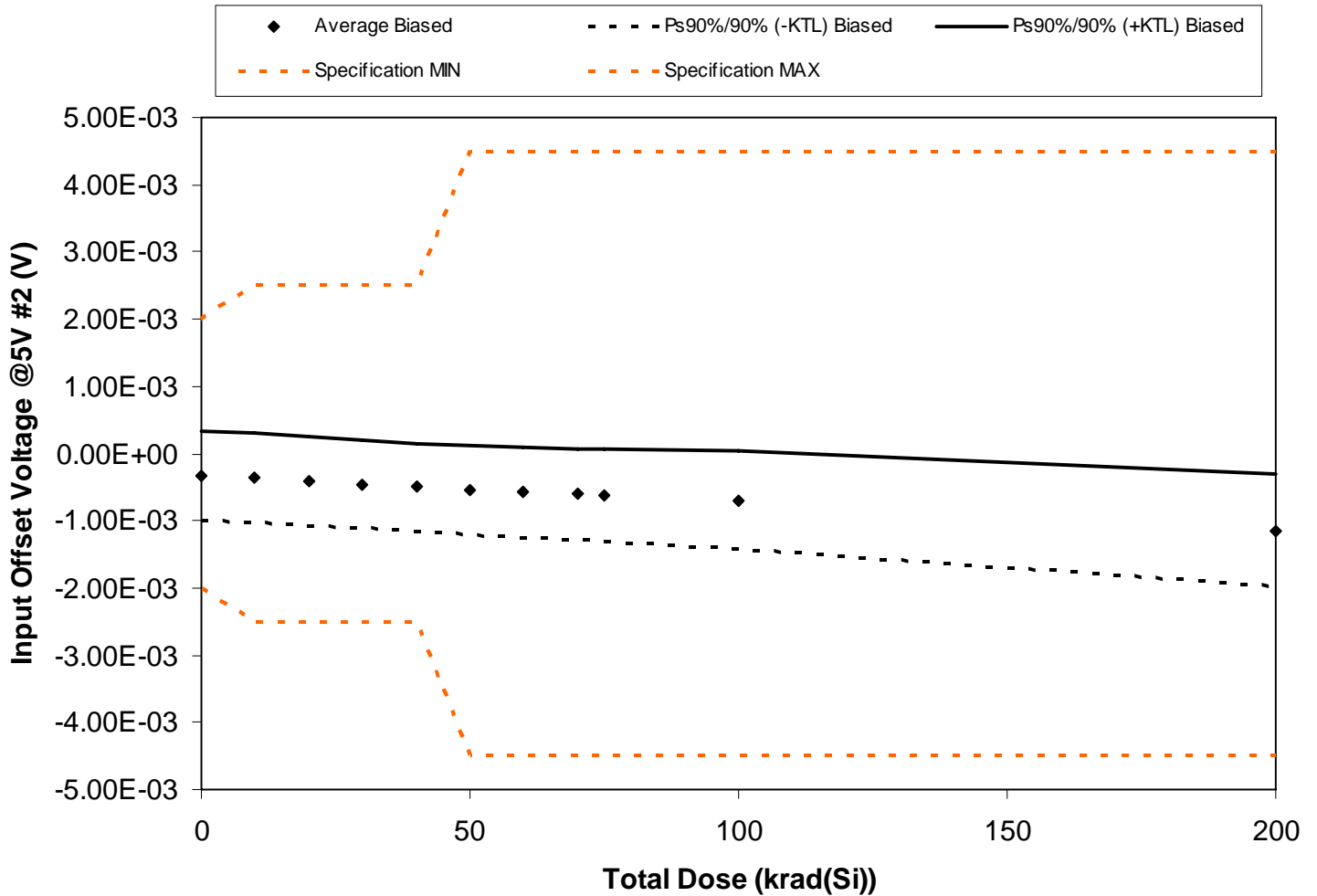

Figure 5.82. Plot of Input Offset Voltage @5V #2 (V) versus total dose. The solid diamonds are the average of the measured data points for the samples irradiated under electrical bias and the black lines (solid and/or dashed) are the average of the data points after application of the KTL statistics on the samples irradiated under electrical bias. The red dotted line(s) are the pre- and/or post-irradiation minimum and/or maximum specification value as defined in the datasheet and/or test plan.



**RLAT Report
10-326 100808 R1.0**

**Radiation Assured Devices
5017 N. 30th Street
Colorado Springs, CO 80919
(719) 531-0800**

Table 5.82. Raw data for Input Offset Voltage @5V #2 (V) versus total dose, including the statistical analysis, specification and the status of the testing (pass/fail).

Input Offset Voltage @5V #2 (V)	Total Dose (krad(Si))											
	0	10	20	30	40	50	60	70	75	100	200	
Device												
1245	-1.92E-04	-2.12E-04	-2.34E-04	-2.74E-04	-3.09E-04	-3.37E-04	-3.56E-04	-3.79E-04	-3.80E-04	-4.36E-04	-8.54E-04	
1246	-8.19E-04	-8.40E-04	-8.79E-04	-9.13E-04	-9.33E-04	-9.54E-04	-9.67E-04	-9.75E-04	-9.75E-04	-1.01E-03	-1.31E-03	
1247	-3.01E-04	-3.39E-04	-4.00E-04	-4.54E-04	-5.09E-04	-5.59E-04	-6.06E-04	-6.30E-04	-6.42E-04	-7.19E-04	-1.28E-03	
1248	-3.88E-04	-4.14E-04	-4.76E-04	-5.40E-04	-6.30E-04	-7.17E-04	-8.12E-04	-9.05E-04	-9.30E-04	-1.15E-03	-1.67E-03	
1249	-3.90E-05	-5.50E-05	-8.70E-05	-1.16E-04	-1.33E-04	-1.59E-04	-1.77E-04	-1.94E-04	-1.95E-04	-2.41E-04	-5.91E-04	
1250	2.53E-04	2.11E-04	1.58E-04	1.03E-04	5.80E-05	1.90E-05	-1.10E-05	-4.50E-05	-4.40E-05	-1.19E-04	-5.33E-04	
1251	-7.93E-04	-8.20E-04	-8.64E-04	-9.05E-04	-9.38E-04	-9.60E-04	-9.98E-04	-1.02E-03	-1.02E-03	-1.07E-03	-1.45E-03	
1261	-2.57E-04	-2.78E-04	-3.24E-04	-3.77E-04	-4.15E-04	-4.42E-04	-4.66E-04	-4.89E-04	-4.92E-04	-5.50E-04	-9.58E-04	
1262	-3.63E-04	-3.95E-04	-4.42E-04	-4.96E-04	-5.38E-04	-5.69E-04	-6.02E-04	-6.30E-04	-6.34E-04	-7.04E-04	-1.19E-03	
1263	-3.59E-04	-4.59E-04	-5.34E-04	-5.97E-04	-6.70E-04	-7.20E-04	-7.73E-04	-8.25E-04	-8.39E-04	-9.41E-04	-1.62E-03	
1264	-2.94E-04	-2.87E-04	-2.87E-04	-2.87E-04	-2.87E-04	-2.87E-04	-2.88E-04	-2.90E-04	-2.90E-04	-2.90E-04	-2.89E-04	
1265	-7.14E-04	-7.09E-04	-7.11E-04	-7.07E-04	-7.10E-04	-7.11E-04	-7.11E-04	-7.11E-04	-7.11E-04	-7.11E-04	-7.12E-04	
Biased Statistics												
Average Biased	-3.26E-04	-3.60E-04	-4.08E-04	-4.57E-04	-5.02E-04	-5.40E-04	-5.77E-04	-6.09E-04	-6.15E-04	-6.95E-04	-1.15E-03	
Std Dev Biased	3.18E-04	3.17E-04	3.18E-04	3.17E-04	3.19E-04	3.20E-04	3.28E-04	3.33E-04	3.36E-04	3.56E-04	4.02E-04	
Ps90%/90% (+KTL) Biased	3.30E-04	2.94E-04	2.49E-04	1.98E-04	1.57E-04	1.21E-04	9.97E-05	7.80E-05	7.89E-05	4.02E-05	-3.17E-04	
Ps90%/90% (-KTL) Biased	-9.82E-04	-1.01E-03	-1.07E-03	-1.11E-03	-1.16E-03	-1.20E-03	-1.25E-03	-1.30E-03	-1.31E-03	-1.43E-03	-1.98E-03	
Specification MIN	-2.00E-03	-2.50E-03	-2.50E-03	-2.50E-03	-2.50E-03	-4.50E-03	-4.50E-03	-4.50E-03	-4.50E-03	-4.50E-03	-4.50E-03	
Status	PASS	PASS	PASS	PASS	PASS	PASS	PASS	PASS	PASS	PASS	PASS	
Specification MAX	2.00E-03	2.50E-03	2.50E-03	2.50E-03	2.50E-03	4.50E-03	4.50E-03	4.50E-03	4.50E-03	4.50E-03	4.50E-03	
Status	PASS	PASS	PASS	PASS	PASS	PASS	PASS	PASS	PASS	PASS	PASS	

An ISO 9001:2008 and DSCC Certified Company

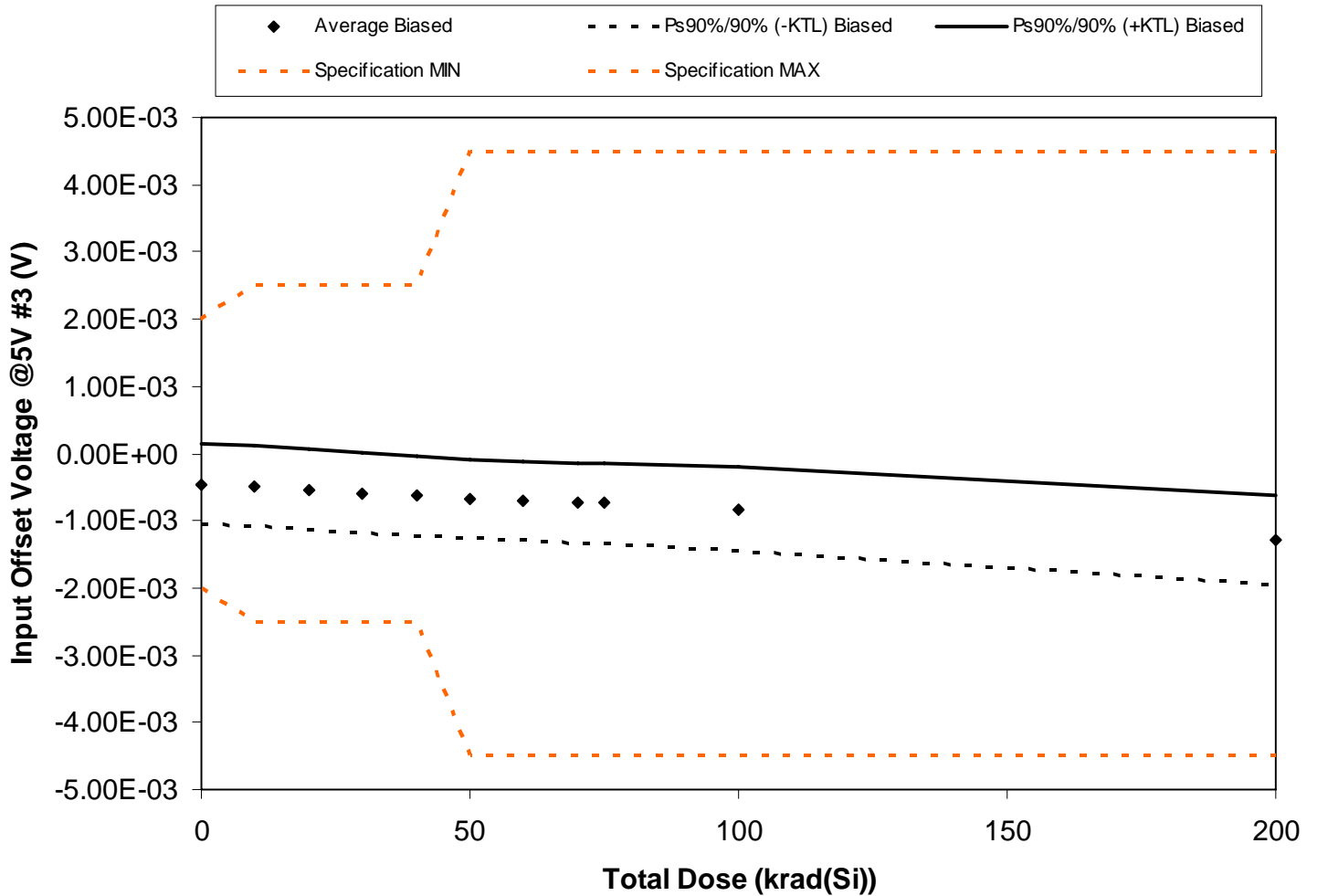

Figure 5.83. Plot of Input Offset Voltage @5V #3 (V) versus total dose. The solid diamonds are the average of the measured data points for the samples irradiated under electrical bias and the black lines (solid and/or dashed) are the average of the data points after application of the KTL statistics on the samples irradiated under electrical bias. The red dotted line(s) are the pre- and/or post-irradiation minimum and/or maximum specification value as defined in the datasheet and/or test plan.



**RLAT Report
10-326 100808 R1.0**

**Radiation Assured Devices
5017 N. 30th Street
Colorado Springs, CO 80919
(719) 531-0800**

Table 5.83. Raw data for Input Offset Voltage @5V #3 (V) versus total dose, including the statistical analysis, specification and the status of the testing (pass/fail).

Input Offset Voltage @5V #3 (V)	Total Dose (krad(Si))											
	0	10	20	30	40	50	60	70	75	100	200	
Device												
1245	-4.66E-04	-4.84E-04	-5.29E-04	-5.72E-04	-6.13E-04	-6.42E-04	-6.75E-04	-6.91E-04	-7.00E-04	-7.64E-04	-1.23E-03	
1246	-1.02E-03	-1.04E-03	-1.07E-03	-1.11E-03	-1.14E-03	-1.16E-03	-1.18E-03	-1.19E-03	-1.18E-03	-1.24E-03	-1.50E-03	
1247	-6.88E-04	-7.20E-04	-7.75E-04	-8.18E-04	-8.70E-04	-9.06E-04	-9.34E-04	-9.72E-04	-9.74E-04	-1.04E-03	-1.50E-03	
1248	-3.38E-04	-3.60E-04	-4.27E-04	-5.08E-04	-5.98E-04	-6.82E-04	-7.67E-04	-8.49E-04	-8.74E-04	-1.09E-03	-1.49E-03	
1249	-2.52E-04	-2.74E-04	-3.14E-04	-3.49E-04	-3.81E-04	-4.02E-04	-4.19E-04	-4.26E-04	-4.20E-04	-4.64E-04	-8.06E-04	
1250	-7.59E-04	-8.08E-04	-8.66E-04	-9.24E-04	-9.81E-04	-1.02E-03	-1.06E-03	-1.09E-03	-1.09E-03	-1.17E-03	-1.67E-03	
1251	-2.20E-05	-5.50E-05	-1.03E-04	-1.47E-04	-1.94E-04	-2.28E-04	-2.69E-04	-2.97E-04	-3.06E-04	-3.87E-04	-8.95E-04	
1261	-4.68E-04	-4.68E-04	-4.76E-04	-4.87E-04	-5.00E-04	-5.04E-04	-5.19E-04	-5.23E-04	-5.26E-04	-5.51E-04	-8.23E-04	
1262	-2.83E-04	-3.22E-04	-3.87E-04	-4.53E-04	-5.17E-04	-5.62E-04	-5.99E-04	-6.50E-04	-6.61E-04	-7.71E-04	-1.42E-03	
1263	-2.89E-04	-3.42E-04	-4.15E-04	-4.72E-04	-5.33E-04	-5.88E-04	-6.38E-04	-6.77E-04	-6.87E-04	-7.91E-04	-1.43E-03	
1264	-4.70E-05	-4.30E-05	-4.30E-05	-4.40E-05	-4.50E-05	-4.50E-05	-4.70E-05	-4.70E-05	-4.40E-05	-4.70E-05	-4.70E-05	
1265	-2.80E-04	-2.83E-04	-2.83E-04	-2.84E-04	-2.85E-04	-2.83E-04	-2.83E-04	-2.79E-04	-2.83E-04	-2.82E-04	-2.81E-04	
Biased Statistics												
Average Biased	-4.59E-04	-4.87E-04	-5.37E-04	-5.84E-04	-6.32E-04	-6.70E-04	-7.06E-04	-7.36E-04	-7.42E-04	-8.26E-04	-1.28E-03	
Std Dev Biased	2.92E-04	2.90E-04	2.88E-04	2.87E-04	2.85E-04	2.86E-04	2.85E-04	2.87E-04	2.87E-04	2.99E-04	3.20E-04	
Ps90%/90% (+KTL) Biased	1.44E-04	1.11E-04	5.74E-05	8.07E-06	-4.42E-05	-7.99E-05	-1.18E-04	-1.43E-04	-1.50E-04	-2.08E-04	-6.16E-04	
Ps90%/90% (-KTL) Biased	-1.06E-03	-1.08E-03	-1.13E-03	-1.18E-03	-1.22E-03	-1.26E-03	-1.29E-03	-1.33E-03	-1.33E-03	-1.44E-03	-1.94E-03	
Specification MIN	-2.00E-03	-2.50E-03	-2.50E-03	-2.50E-03	-2.50E-03	-4.50E-03	-4.50E-03	-4.50E-03	-4.50E-03	-4.50E-03	-4.50E-03	
Status	PASS	PASS	PASS	PASS	PASS	PASS	PASS	PASS	PASS	PASS	PASS	
Specification MAX	2.00E-03	2.50E-03	2.50E-03	2.50E-03	2.50E-03	4.50E-03	4.50E-03	4.50E-03	4.50E-03	4.50E-03	4.50E-03	
Status	PASS	PASS	PASS	PASS	PASS	PASS	PASS	PASS	PASS	PASS	PASS	

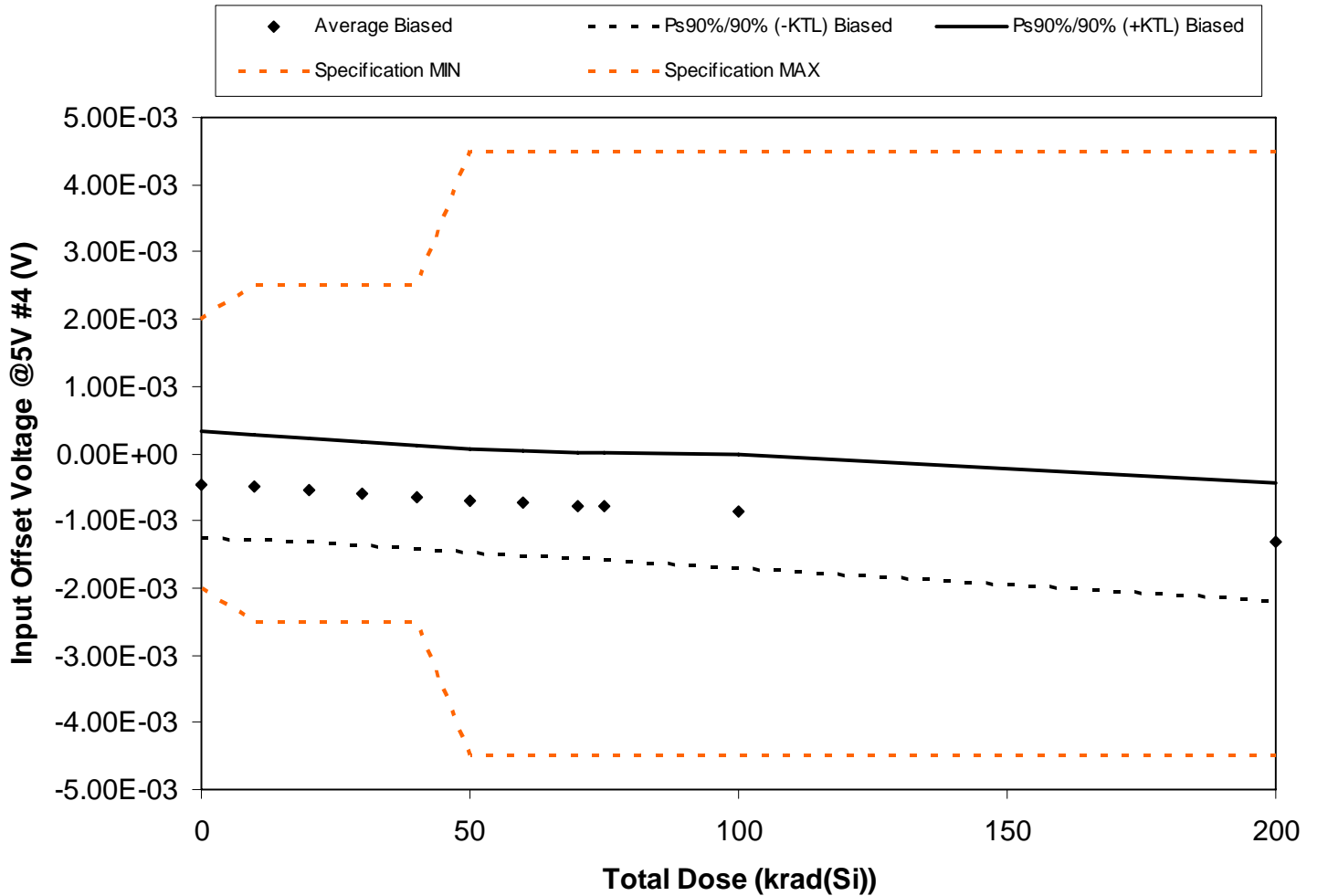

Figure 5.84. Plot of Input Offset Voltage @5V #4 (V) versus total dose. The solid diamonds are the average of the measured data points for the samples irradiated under electrical bias and the black lines (solid and/or dashed) are the average of the data points after application of the KTL statistics on the samples irradiated under electrical bias. The red dotted line(s) are the pre- and/or post-irradiation minimum and/or maximum specification value as defined in the datasheet and/or test plan.



**RLAT Report
10-326 100808 R1.0**

**Radiation Assured Devices
5017 N. 30th Street
Colorado Springs, CO 80919
(719) 531-0800**

Table 5.84. Raw data for Input Offset Voltage @5V #4 (V) versus total dose, including the statistical analysis, specification and the status of the testing (pass/fail).

Input Offset Voltage @5V #4 (V)	Total Dose (krad(Si))											
	0	10	20	30	40	50	60	70	75	100	200	
Device												
1245	-1.06E-03	-1.08E-03	-1.13E-03	-1.17E-03	-1.22E-03	-1.25E-03	-1.28E-03	-1.30E-03	-1.31E-03	-1.36E-03	-1.72E-03	
1246	-2.44E-04	-2.79E-04	-3.30E-04	-3.68E-04	-4.10E-04	-4.41E-04	-4.65E-04	-4.81E-04	-4.80E-04	-5.40E-04	-9.84E-04	
1247	-2.19E-04	-2.70E-04	-3.40E-04	-4.04E-04	-4.71E-04	-5.38E-04	-5.89E-04	-6.52E-04	-6.66E-04	-7.57E-04	-1.41E-03	
1248	-4.35E-04	-4.87E-04	-5.73E-04	-6.58E-04	-7.66E-04	-8.73E-04	-9.63E-04	-1.06E-03	-1.09E-03	-1.33E-03	-1.77E-03	
1249	-9.45E-04	-9.71E-04	-1.02E-03	-1.06E-03	-1.11E-03	-1.16E-03	-1.19E-03	-1.24E-03	-1.24E-03	-1.34E-03	-1.91E-03	
1250	-1.59E-04	-1.72E-04	-1.96E-04	-2.23E-04	-2.66E-04	-2.96E-04	-3.23E-04	-3.42E-04	-3.41E-04	-3.85E-04	-7.72E-04	
1251	-3.15E-04	-3.55E-04	-4.06E-04	-4.52E-04	-5.00E-04	-5.30E-04	-5.73E-04	-5.93E-04	-5.90E-04	-6.51E-04	-1.11E-03	
1261	-9.86E-04	-1.01E-03	-1.05E-03	-1.09E-03	-1.13E-03	-1.14E-03	-1.17E-03	-1.19E-03	-1.19E-03	-1.24E-03	-1.65E-03	
1262	-1.92E-04	-2.32E-04	-2.94E-04	-3.54E-04	-4.10E-04	-4.40E-04	-4.70E-04	-5.00E-04	-5.01E-04	-5.68E-04	-1.02E-03	
1263	-7.50E-05	-1.19E-04	-1.84E-04	-2.36E-04	-2.74E-04	-3.01E-04	-3.24E-04	-3.48E-04	-3.47E-04	-4.03E-04	-8.38E-04	
1264	2.78E-04	2.74E-04	2.77E-04	2.76E-04	2.77E-04	2.77E-04	2.77E-04	2.77E-04	2.78E-04	2.77E-04	2.77E-04	
1265	-3.31E-04	-3.30E-04	-3.30E-04	-3.31E-04	-3.31E-04	-3.30E-04	-3.32E-04	-3.31E-04	-3.34E-04	-3.34E-04	-3.32E-04	
Biased Statistics												
Average Biased	-4.63E-04	-4.98E-04	-5.52E-04	-6.02E-04	-6.56E-04	-6.97E-04	-7.35E-04	-7.70E-04	-7.75E-04	-8.57E-04	-1.32E-03	
Std Dev Biased	3.82E-04	3.76E-04	3.72E-04	3.71E-04	3.71E-04	3.73E-04	3.76E-04	3.83E-04	3.87E-04	4.10E-04	4.22E-04	
Ps90%/90% (+KTL) Biased	3.25E-04	2.78E-04	2.15E-04	1.63E-04	1.10E-04	7.32E-05	4.25E-05	2.13E-05	2.41E-05	-9.33E-06	-4.45E-04	
Ps90%/90% (-KTL) Biased	-1.25E-03	-1.27E-03	-1.32E-03	-1.37E-03	-1.42E-03	-1.47E-03	-1.51E-03	-1.56E-03	-1.57E-03	-1.70E-03	-2.19E-03	
Specification MIN	-2.00E-03	-2.50E-03	-2.50E-03	-2.50E-03	-2.50E-03	-4.50E-03	-4.50E-03	-4.50E-03	-4.50E-03	-4.50E-03	-4.50E-03	
Status	PASS	PASS	PASS	PASS	PASS	PASS	PASS	PASS	PASS	PASS	PASS	
Specification MAX	2.00E-03	2.50E-03	2.50E-03	2.50E-03	2.50E-03	4.50E-03	4.50E-03	4.50E-03	4.50E-03	4.50E-03	4.50E-03	
Status	PASS	PASS	PASS	PASS	PASS	PASS	PASS	PASS	PASS	PASS	PASS	

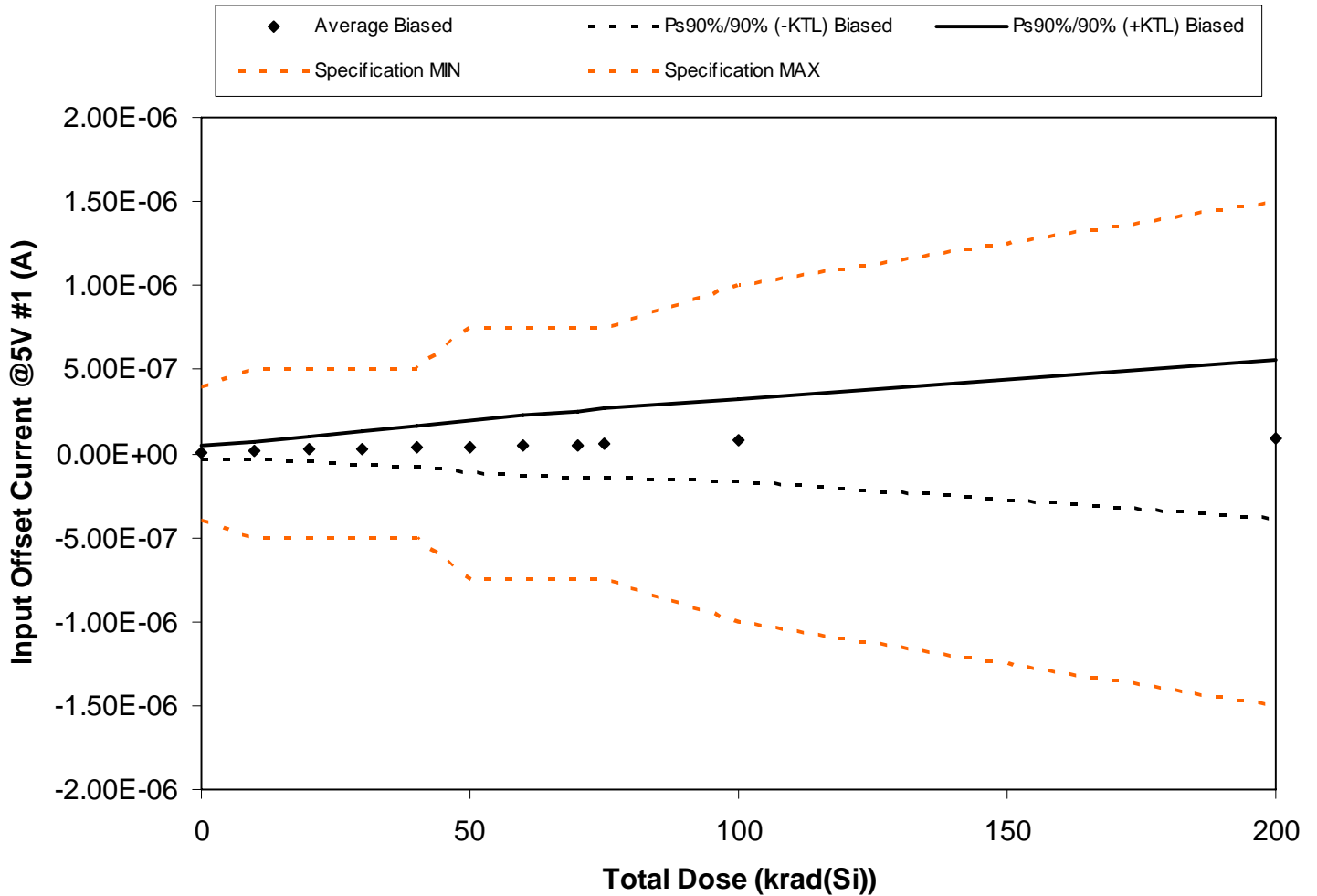

Figure 5.85. Plot of Input Offset Current @5V #1 (A) versus total dose. The solid diamonds are the average of the measured data points for the samples irradiated under electrical bias and the black lines (solid and/or dashed) are the average of the data points after application of the KTL statistics on the samples irradiated under electrical bias. The red dotted line(s) are the pre- and/or post-irradiation minimum and/or maximum specification value as defined in the datasheet and/or test plan.



**RLAT Report
10-326 100808 R1.0**

**Radiation Assured Devices
5017 N. 30th Street
Colorado Springs, CO 80919
(719) 531-0800**

Table 5.85. Raw data for Input Offset Current @5V #1 (A) versus total dose, including the statistical analysis, specification and the status of the testing (pass/fail).

Input Offset Current @5V #1 (A)	Total Dose (krad(Si))											
	0	10	20	30	40	50	60	70	75	100	200	
Device												
1245	-3.00E-08	-3.00E-08	-3.00E-08	-4.00E-08	-5.00E-08	-7.00E-08	-8.00E-08	-9.00E-08	-9.00E-08	-1.00E-07	-2.40E-07	
1246	2.00E-08	4.00E-08	6.00E-08	8.00E-08	1.00E-07	1.10E-07	1.30E-07	1.40E-07	1.60E-07	1.80E-07	2.70E-07	
1247	3.00E-08	5.00E-08	6.00E-08	8.00E-08	1.00E-07	1.20E-07	1.40E-07	1.50E-07	1.60E-07	2.00E-07	3.30E-07	
1248	1.00E-08	0.00E+00	1.00E-08	2.00E-08	3.00E-08	3.00E-08	4.00E-08	5.00E-08	6.00E-08	1.00E-07	7.00E-08	
1249	-2.00E-08	0.00E+00	0.00E+00	0.00E+00	0.00E+00	0.00E+00	0.00E+00	0.00E+00	0.00E+00	0.00E+00	-7.00E-08	
1250	0.00E+00	0.00E+00	0.00E+00	-1.00E-08	-2.00E-08	-2.00E-08	-3.00E-08	-3.00E-08	-3.00E-08	-3.00E-08	-1.20E-07	
1251	0.00E+00	0.00E+00	0.00E+00	0.00E+00	0.00E+00	-2.00E-08	-2.00E-08	-2.00E-08	-2.00E-08	-2.00E-08	-1.10E-07	
1261	0.00E+00	0.00E+00	0.00E+00	0.00E+00	1.00E-08	0.00E+00	0.00E+00	0.00E+00	2.00E-08	3.00E-08	1.00E-08	
1262	3.00E-08	5.00E-08	7.00E-08	1.00E-07	1.10E-07	1.40E-07	1.60E-07	1.80E-07	1.90E-07	2.30E-07	4.10E-07	
1263	2.00E-08	3.00E-08	6.00E-08	7.00E-08	1.00E-07	1.10E-07	1.30E-07	1.50E-07	1.60E-07	2.00E-07	3.20E-07	
1264	0.00E+00	0.00E+00	0.00E+00	0.00E+00	0.00E+00	0.00E+00	0.00E+00	0.00E+00	0.00E+00	0.00E+00	0.00E+00	
1265	0.00E+00	0.00E+00	0.00E+00	0.00E+00	0.00E+00	0.00E+00	0.00E+00	0.00E+00	0.00E+00	0.00E+00	0.00E+00	
Biased Statistics												
Average Biased	6.00E-09	1.40E-08	2.30E-08	3.00E-08	3.80E-08	4.00E-08	4.70E-08	5.30E-08	6.10E-08	7.90E-08	8.70E-08	
Std Dev Biased	2.01E-08	2.67E-08	3.56E-08	4.81E-08	5.92E-08	7.36E-08	8.58E-08	9.48E-08	9.95E-08	1.18E-07	2.29E-07	
Ps90%/90% (+KTL) Biased	4.75E-08	6.92E-08	9.65E-08	1.29E-07	1.60E-07	1.92E-07	2.24E-07	2.49E-07	2.66E-07	3.22E-07	5.59E-07	
Ps90%/90% (-KTL) Biased	-3.55E-08	-4.12E-08	-5.05E-08	-6.93E-08	-8.43E-08	-1.12E-07	-1.30E-07	-1.43E-07	-1.44E-07	-1.64E-07	-3.85E-07	
Specification MIN	-4.00E-07	-5.00E-07	-5.00E-07	-5.00E-07	-5.00E-07	-7.50E-07	-7.50E-07	-7.50E-07	-7.50E-07	-1.00E-06	-1.50E-06	
Status	PASS	PASS	PASS	PASS	PASS	PASS	PASS	PASS	PASS	PASS	PASS	
Specification MAX	4.00E-07	5.00E-07	5.00E-07	5.00E-07	5.00E-07	7.50E-07	7.50E-07	7.50E-07	7.50E-07	1.00E-06	1.50E-06	
Status	PASS	PASS	PASS	PASS	PASS	PASS	PASS	PASS	PASS	PASS	PASS	

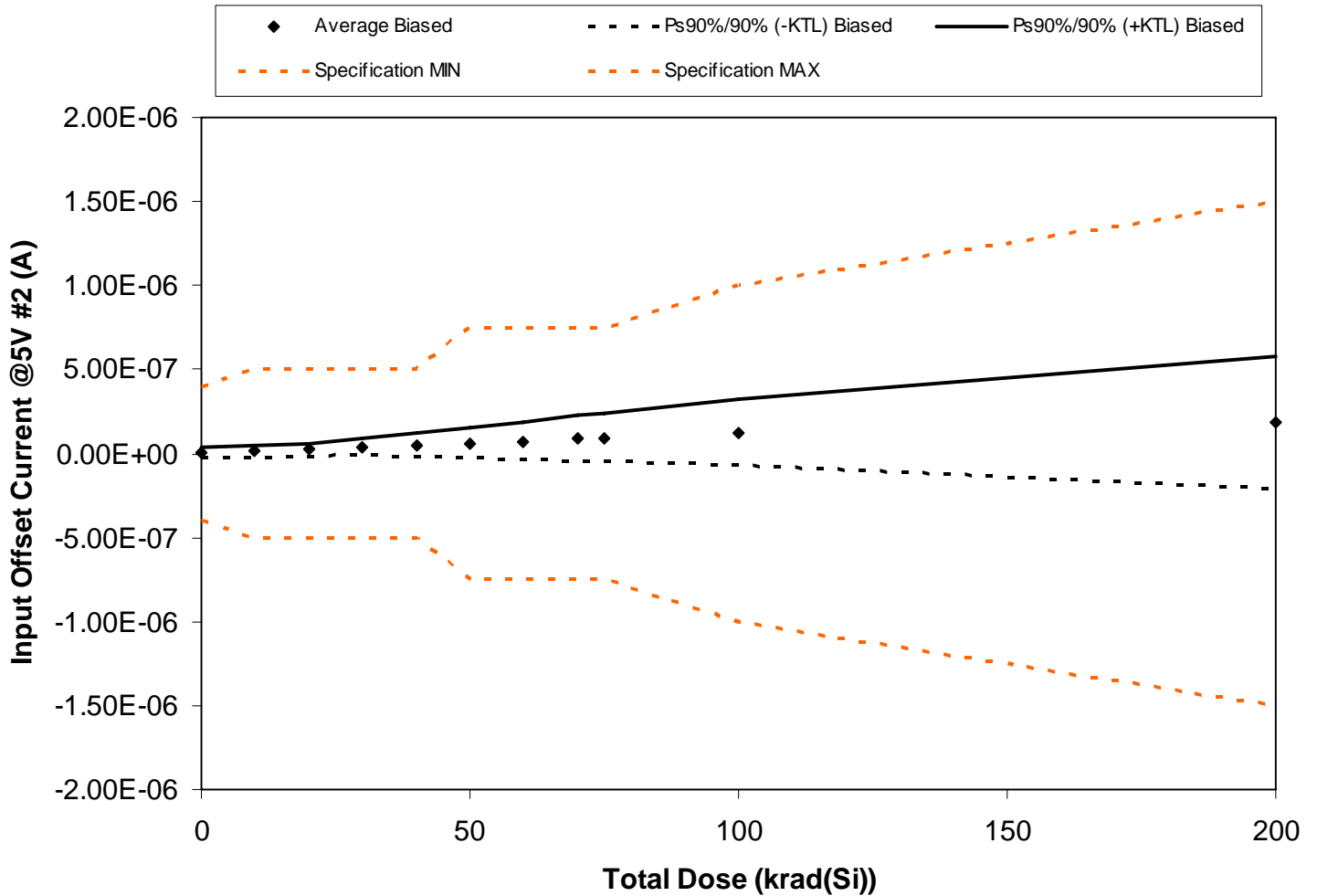

Figure 5.86. Plot of Input Offset Current @5V #2 (A) versus total dose. The solid diamonds are the average of the measured data points for the samples irradiated under electrical bias and the black lines (solid and/or dashed) are the average of the data points after application of the KTL statistics on the samples irradiated under electrical bias. The red dotted line(s) are the pre- and/or post-irradiation minimum and/or maximum specification value as defined in the datasheet and/or test plan.



Table 5.86. Raw data for Input Offset Current @5V #2 (A) versus total dose, including the statistical analysis, specification and the status of the testing (pass/fail).

Input Offset Current @5V #2 (A)	Total Dose (krad(Si))											
	0	10	20	30	40	50	60	70	75	100	200	
Device												
1245	1.00E-08	1.00E-08	0.00E+00	0.00E+00	0.00E+00	0.00E+00	0.00E+00	-1.00E-08	-1.00E-08	-2.00E-08	-2.00E-08	-1.40E-07
1246	-2.00E-08	0.00E+00	1.00E-08	3.00E-08	5.00E-08	7.00E-08	8.00E-08	1.00E-07	1.10E-07	1.50E-07	1.50E-07	2.70E-07
1247	2.00E-08	4.00E-08	5.00E-08	6.00E-08	6.00E-08	7.00E-08	8.00E-08	9.00E-08	9.00E-08	1.10E-07	1.10E-07	2.00E-07
1248	0.00E+00	0.00E+00	2.00E-08	5.00E-08	7.00E-08	7.00E-08	1.00E-07	1.30E-07	1.70E-07	1.80E-07	2.60E-07	3.50E-07
1249	-1.00E-08	0.00E+00	2.00E-08	4.00E-08	6.00E-08	7.00E-08	1.00E-07	1.10E-07	1.20E-07	1.60E-07	1.60E-07	2.70E-07
1250	2.00E-08	4.00E-08	5.00E-08	7.00E-08	9.00E-08	1.00E-07	1.20E-07	1.50E-07	1.50E-07	2.00E-07	2.00E-07	3.00E-07
1251	0.00E+00	2.00E-08	4.00E-08	5.00E-08	7.00E-08	8.00E-08	1.00E-07	1.10E-07	1.20E-07	1.50E-07	1.50E-07	2.50E-07
1261	-2.00E-08	-1.00E-08	1.00E-08	3.00E-08	5.00E-08	6.00E-08	8.00E-08	1.00E-07	1.10E-07	1.50E-07	1.50E-07	2.70E-07
1262	0.00E+00	1.00E-08	3.00E-08	5.00E-08	7.00E-08	9.00E-08	1.00E-07	1.20E-07	1.30E-07	1.70E-07	1.70E-07	2.90E-07
1263	2.00E-08	0.00E+00	0.00E+00	0.00E+00	-2.00E-08	-3.00E-08	-4.00E-08	-4.00E-08	-4.00E-08	-6.00E-08	-6.00E-08	-1.90E-07
1264	3.00E-08	3.00E-08	4.00E-08	4.00E-08	4.00E-08	4.00E-08	3.00E-08	3.00E-08	3.00E-08	3.00E-08	3.00E-08	3.00E-08
1265	2.00E-08	2.00E-08	2.00E-08	2.00E-08	2.00E-08	2.00E-08	2.00E-08	2.00E-08	2.00E-08	2.00E-08	2.00E-08	2.00E-08
Biased Statistics												
Average Biased	2.00E-09	1.10E-08	2.30E-08	3.80E-08	5.00E-08	6.10E-08	7.40E-08	9.00E-08	9.50E-08	1.27E-07	1.27E-07	1.87E-07
Std Dev Biased	1.55E-08	1.73E-08	1.89E-08	2.35E-08	3.40E-08	4.28E-08	5.52E-08	6.57E-08	7.04E-08	9.68E-08	9.68E-08	1.90E-07
Ps90%/90% (+KTL) Biased	3.40E-08	4.67E-08	6.20E-08	8.65E-08	1.20E-07	1.49E-07	1.88E-07	2.26E-07	2.40E-07	3.27E-07	3.27E-07	5.79E-07
Ps90%/90% (-KTL) Biased	-3.00E-08	-2.47E-08	-1.60E-08	-1.05E-08	-2.02E-08	-2.74E-08	-4.00E-08	-4.56E-08	-5.04E-08	-7.30E-08	-7.30E-08	-2.05E-07
Specification MIN	-4.00E-07	-5.00E-07	-5.00E-07	-5.00E-07	-5.00E-07	-7.50E-07	-7.50E-07	-7.50E-07	-7.50E-07	-1.00E-06	-1.00E-06	-1.50E-06
Status	PASS	PASS	PASS	PASS	PASS	PASS	PASS	PASS	PASS	PASS	PASS	PASS
Specification MAX	4.00E-07	5.00E-07	5.00E-07	5.00E-07	5.00E-07	7.50E-07	7.50E-07	7.50E-07	7.50E-07	1.00E-06	1.00E-06	1.50E-06
Status	PASS	PASS	PASS	PASS	PASS	PASS	PASS	PASS	PASS	PASS	PASS	PASS

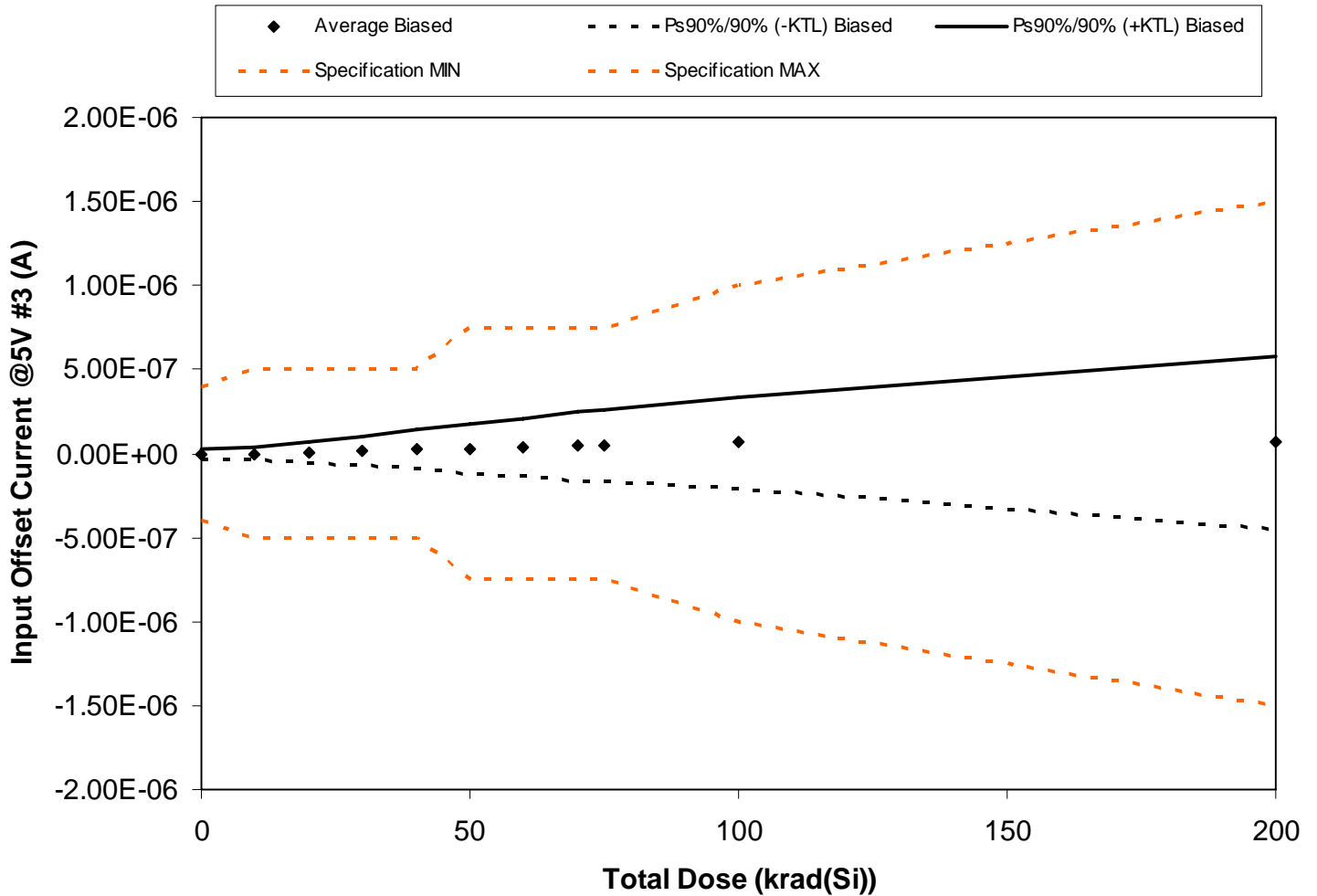

Figure 5.87. Plot of Input Offset Current @5V #3 (A) versus total dose. The solid diamonds are the average of the measured data points for the samples irradiated under electrical bias and the black lines (solid and/or dashed) are the average of the data points after application of the KTL statistics on the samples irradiated under electrical bias. The red dotted line(s) are the pre- and/or post-irradiation minimum and/or maximum specification value as defined in the datasheet and/or test plan.



**RLAT Report
10-326 100808 R1.0**

**Radiation Assured Devices
5017 N. 30th Street
Colorado Springs, CO 80919
(719) 531-0800**

Table 5.87. Raw data for Input Offset Current @5V #3 (A) versus total dose, including the statistical analysis, specification and the status of the testing (pass/fail).

Input Offset Current @5V #3 (A)	Total Dose (krad(Si))											
	0	10	20	30	40	50	60	70	75	100	200	
Device												
1245	-2.00E-08	-2.00E-08	-2.00E-08	-2.00E-08	-2.00E-08	-3.00E-08	-3.00E-08	-4.00E-08	-3.00E-08	-3.00E-08	-1.10E-07	
1246	-3.00E-08	-1.00E-08	0.00E+00	2.00E-08	4.00E-08	5.00E-08	7.00E-08	9.00E-08	1.00E-07	1.30E-07	2.40E-07	
1247	3.00E-08	4.00E-08	6.00E-08	8.00E-08	1.00E-07	1.10E-07	1.30E-07	1.50E-07	1.60E-07	2.00E-07	3.10E-07	
1248	0.00E+00	1.00E-08	3.00E-08	6.00E-08	9.00E-08	1.20E-07	1.50E-07	1.80E-07	1.90E-07	2.70E-07	3.90E-07	
1249	0.00E+00	1.00E-08	3.00E-08	5.00E-08	7.00E-08	9.00E-08	1.10E-07	1.30E-07	1.30E-07	1.70E-07	2.70E-07	
1250	-2.00E-08	-2.00E-08	-2.00E-08	-3.00E-08	-4.00E-08	-5.00E-08	-6.00E-08	-7.00E-08	-7.00E-08	-8.00E-08	-2.10E-07	
1251	0.00E+00	2.00E-08	4.00E-08	6.00E-08	7.00E-08	9.00E-08	1.10E-07	1.30E-07	1.30E-07	1.60E-07	2.80E-07	
1261	0.00E+00	-1.00E-08	-2.00E-08	-2.00E-08	-2.00E-08	-3.00E-08	-3.00E-08	-4.00E-08	-4.00E-08	-4.00E-08	-1.50E-07	
1262	0.00E+00	-1.00E-08	-1.00E-08	-2.00E-08	-3.00E-08	-4.00E-08	-4.00E-08	-5.00E-08	-5.00E-08	-6.00E-08	-2.00E-07	
1263	-1.00E-08	-1.00E-08	-2.00E-08	-2.00E-08	-3.00E-08	-4.00E-08	-4.00E-08	-5.00E-08	-5.00E-08	-6.00E-08	-1.60E-07	
1264	1.00E-08	2.00E-08	1.00E-08	1.00E-08	2.00E-08	1.00E-08	2.00E-08	1.00E-08	1.00E-08	2.00E-08	1.00E-08	
1265	0.00E+00	0.00E+00	0.00E+00	0.00E+00	0.00E+00	0.00E+00	0.00E+00	0.00E+00	0.00E+00	0.00E+00	0.00E+00	
Biased Statistics												
Average Biased	-5.00E-09	-3.31E-25	7.00E-09	1.60E-08	2.30E-08	2.70E-08	3.70E-08	4.30E-08	4.70E-08	6.60E-08	6.60E-08	
Std Dev Biased	1.65E-08	1.94E-08	3.02E-08	4.27E-08	5.62E-08	7.10E-08	8.39E-08	1.01E-07	1.03E-07	1.32E-07	2.49E-07	
Ps90%/90% (+KTL) Biased	2.91E-08	4.01E-08	6.94E-08	1.04E-07	1.39E-07	1.74E-07	2.10E-07	2.51E-07	2.60E-07	3.39E-07	5.80E-07	
Ps90%/90% (-KTL) Biased	-3.91E-08	-4.01E-08	-5.54E-08	-7.23E-08	-9.30E-08	-1.20E-07	-1.36E-07	-1.65E-07	-1.66E-07	-2.07E-07	-4.48E-07	
Specification MIN	-4.00E-07	-5.00E-07	-5.00E-07	-5.00E-07	-5.00E-07	-7.50E-07	-7.50E-07	-7.50E-07	-7.50E-07	-1.00E-06	-1.50E-06	
Status	PASS	PASS	PASS	PASS	PASS	PASS	PASS	PASS	PASS	PASS	PASS	
Specification MAX	4.00E-07	5.00E-07	5.00E-07	5.00E-07	5.00E-07	7.50E-07	7.50E-07	7.50E-07	7.50E-07	1.00E-06	1.50E-06	
Status	PASS	PASS	PASS	PASS	PASS	PASS	PASS	PASS	PASS	PASS	PASS	

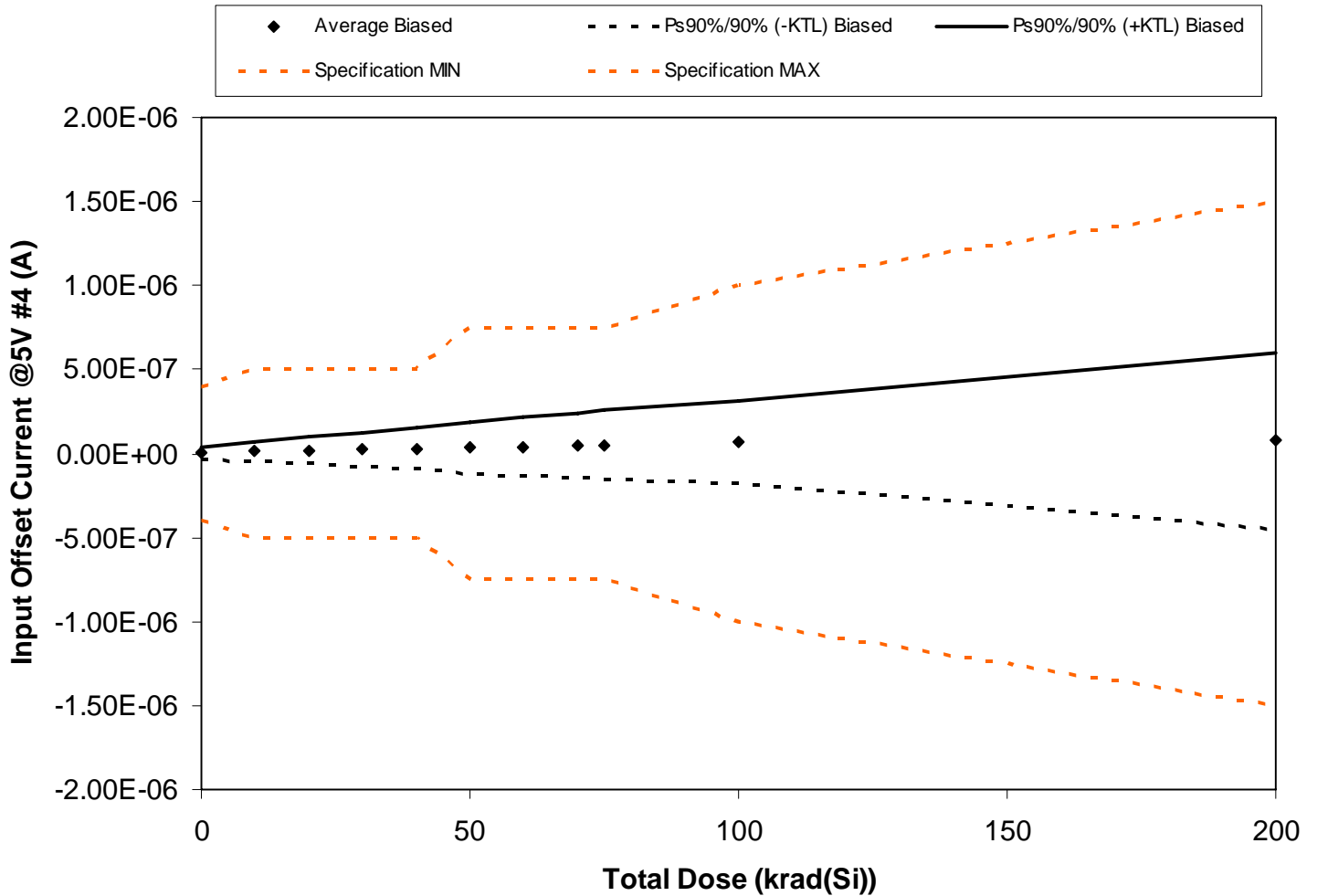

Figure 5.88. Plot of Input Offset Current @5V #4 (A) versus total dose. The solid diamonds are the average of the measured data points for the samples irradiated under electrical bias and the black lines (solid and/or dashed) are the average of the data points after application of the KTL statistics on the samples irradiated under electrical bias. The red dotted line(s) are the pre- and/or post-irradiation minimum and/or maximum specification value as defined in the datasheet and/or test plan.



Table 5.88. Raw data for Input Offset Current @5V #4 (A) versus total dose, including the statistical analysis, specification and the status of the testing (pass/fail).

Input Offset Current @5V #4 (A)	Total Dose (krad(Si))											
	0	10	20	30	40	50	60	70	75	100	200	
Device												
1245	0.00E+00	0.00E+00	0.00E+00	-1.00E-08	-2.00E-08	-3.00E-08	-3.00E-08	-3.00E-08	-3.00E-08	-3.00E-08	-3.00E-08	-1.40E-07
1246	0.00E+00	0.00E+00	0.00E+00	0.00E+00	0.00E+00	0.00E+00	0.00E+00	-1.00E-08	-2.00E-08	-1.00E-08	-2.00E-08	-9.00E-08
1247	-1.00E-08	-1.00E-08	-1.00E-08	-1.00E-08	-2.00E-08	-3.00E-08	-3.00E-08	-3.00E-08	-3.00E-08	-4.00E-08	-3.00E-08	-1.10E-07
1248	0.00E+00	-1.00E-08	-2.00E-08	-3.00E-08	-3.00E-08	-3.00E-08	-4.00E-08	-4.00E-08	-5.00E-08	-5.00E-08	-3.00E-08	-1.90E-07
1249	1.00E-08	2.00E-08	3.00E-08	4.00E-08	5.00E-08	5.00E-08	6.00E-08	6.00E-08	7.00E-08	9.00E-08	1.00E-07	1.00E-07
1250	-2.00E-08	-2.00E-08	-3.00E-08	-3.00E-08	-3.00E-08	-4.00E-08	-4.00E-08	-4.00E-08	-4.00E-08	-4.00E-08	-3.00E-08	-1.10E-07
1251	4.00E-08	5.00E-08	6.00E-08	7.00E-08	8.00E-08	8.00E-08	9.00E-08	1.00E-07	1.10E-07	1.30E-07	2.00E-07	2.00E-07
1261	3.00E-08	6.00E-08	1.00E-07	1.20E-07	1.50E-07	1.80E-07	2.10E-07	2.30E-07	2.50E-07	3.10E-07	6.10E-07	6.10E-07
1262	0.00E+00	2.00E-08	4.00E-08	6.00E-08	7.00E-08	9.00E-08	1.10E-07	1.20E-07	1.30E-07	1.70E-07	2.70E-07	2.70E-07
1263	-1.00E-08	0.00E+00	2.00E-08	4.00E-08	6.00E-08	7.00E-08	9.00E-08	1.10E-07	1.20E-07	1.50E-07	2.40E-07	2.40E-07
1264	0.00E+00	0.00E+00	0.00E+00	0.00E+00	0.00E+00	0.00E+00	0.00E+00	0.00E+00	0.00E+00	0.00E+00	0.00E+00	0.00E+00
1265	2.00E-08	2.00E-08	2.00E-08	1.00E-08	1.00E-08	2.00E-08	1.00E-08	2.00E-08	1.00E-08	2.00E-08	2.00E-08	2.00E-08
Biased Statistics												
Average Biased	4.00E-09	1.10E-08	1.90E-08	2.50E-08	3.10E-08	3.30E-08	4.10E-08	4.50E-08	5.10E-08	7.10E-08	7.80E-08	7.80E-08
Std Dev Biased	1.84E-08	2.64E-08	3.98E-08	4.93E-08	6.05E-08	7.33E-08	8.45E-08	9.37E-08	1.01E-07	1.18E-07	2.54E-07	2.54E-07
Ps90%/90% (+KTL) Biased	4.20E-08	6.56E-08	1.01E-07	1.27E-07	1.56E-07	1.84E-07	2.16E-07	2.39E-07	2.59E-07	3.15E-07	6.02E-07	6.02E-07
Ps90%/90% (-KTL) Biased	-3.40E-08	-4.36E-08	-6.33E-08	-7.67E-08	-9.38E-08	-1.18E-07	-1.34E-07	-1.49E-07	-1.57E-07	-1.73E-07	-4.46E-07	-4.46E-07
Specification MIN	-4.00E-07	-5.00E-07	-5.00E-07	-5.00E-07	-5.00E-07	-7.50E-07	-7.50E-07	-7.50E-07	-7.50E-07	-1.00E-06	-1.50E-06	-1.50E-06
Status	PASS	PASS	PASS	PASS	PASS	PASS	PASS	PASS	PASS	PASS	PASS	PASS
Specification MAX	4.00E-07	5.00E-07	5.00E-07	5.00E-07	5.00E-07	7.50E-07	7.50E-07	7.50E-07	7.50E-07	1.00E-06	1.50E-06	1.50E-06
Status	PASS	PASS	PASS	PASS	PASS	PASS	PASS	PASS	PASS	PASS	PASS	PASS

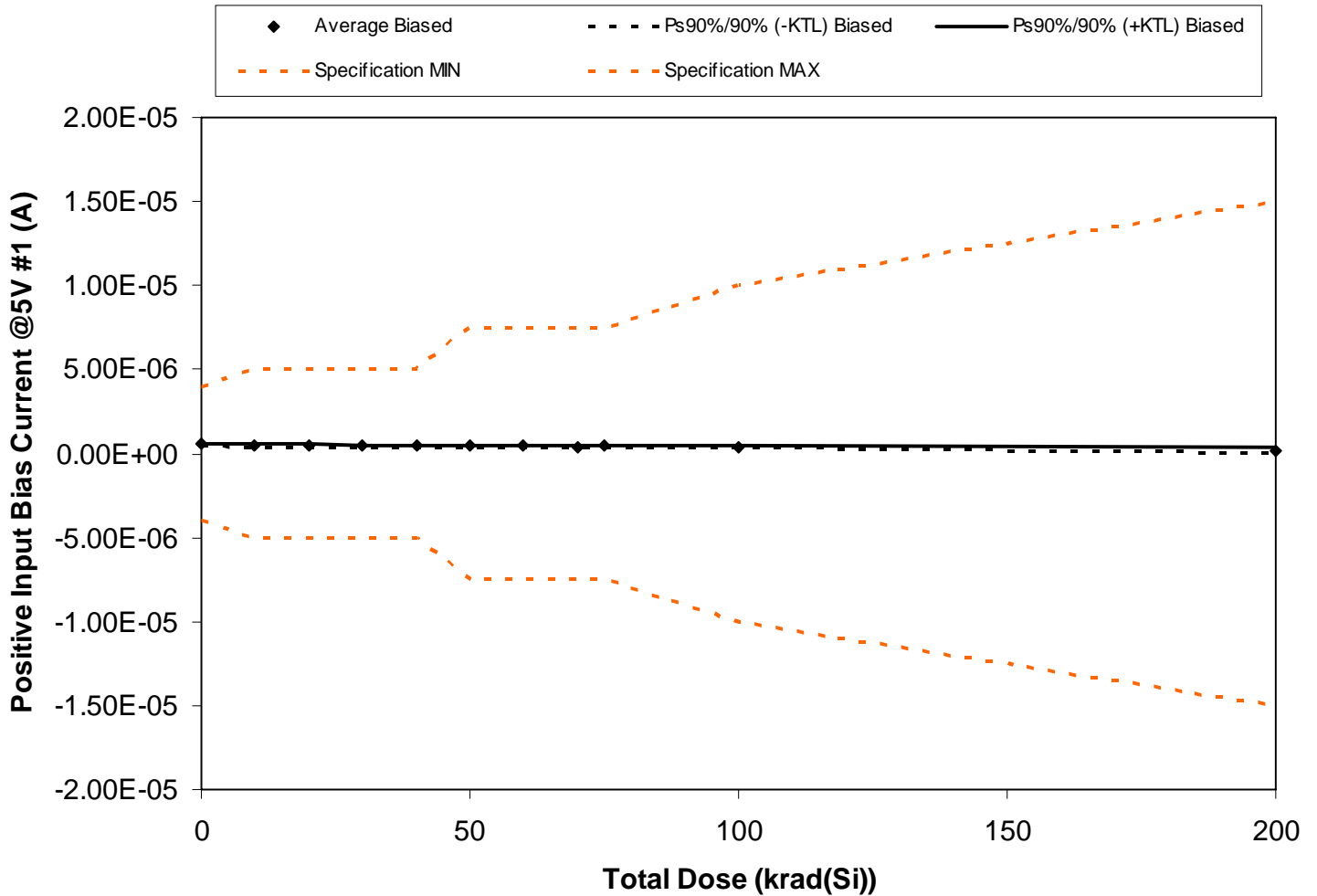

Figure 5.89. Plot of Positive Input Bias Current @5V #1 (A) versus total dose. The solid diamonds are the average of the measured data points for the samples irradiated under electrical bias and the black lines (solid and/or dashed) are the average of the data points after application of the KTL statistics on the samples irradiated under electrical bias. The red dotted line(s) are the pre- and/or post-irradiation minimum and/or maximum specification value as defined in the datasheet and/or test plan.



**RLAT Report
10-326 100808 R1.0**

**Radiation Assured Devices
5017 N. 30th Street
Colorado Springs, CO 80919
(719) 531-0800**

Table 5.89. Raw data for Positive Input Bias Current @5V #1 (A) versus total dose, including the statistical analysis, specification and the status of the testing (pass/fail).

Positive Input Bias Current @5V #1 (A)	Total Dose (krad(Si))											
	0	10	20	30	40	50	60	70	75	100	200	
Device												
1245	5.30E-07	5.00E-07	4.70E-07	4.50E-07	4.20E-07	4.00E-07	3.90E-07	3.70E-07	3.70E-07	3.50E-07	6.00E-08	
1246	5.50E-07	5.20E-07	5.00E-07	4.80E-07	4.70E-07	4.60E-07	4.60E-07	4.60E-07	4.70E-07	4.60E-07	2.40E-07	
1247	4.70E-07	4.40E-07	4.20E-07	4.00E-07	3.90E-07	3.80E-07	3.70E-07	3.70E-07	3.80E-07	3.70E-07	1.40E-07	
1248	5.00E-07	4.60E-07	4.40E-07	4.20E-07	4.10E-07	4.00E-07	3.90E-07	3.90E-07	4.00E-07	3.90E-07	1.80E-07	
1249	4.60E-07	4.30E-07	4.10E-07	4.00E-07	3.90E-07	3.90E-07	3.90E-07	3.90E-07	4.00E-07	4.00E-07	2.40E-07	
1250	5.50E-07	5.20E-07	4.90E-07	4.70E-07	4.50E-07	4.40E-07	4.40E-07	4.30E-07	4.40E-07	4.20E-07	1.90E-07	
1251	5.80E-07	5.50E-07	5.20E-07	5.00E-07	4.90E-07	4.80E-07	4.70E-07	4.70E-07	4.70E-07	4.60E-07	2.40E-07	
1261	5.60E-07	5.10E-07	4.80E-07	4.60E-07	4.40E-07	4.30E-07	4.20E-07	4.10E-07	4.20E-07	4.10E-07	1.30E-07	
1262	5.60E-07	5.30E-07	5.10E-07	5.00E-07	4.90E-07	4.80E-07	4.80E-07	4.90E-07	4.90E-07	4.90E-07	3.40E-07	
1263	5.50E-07	5.10E-07	4.80E-07	4.60E-07	4.50E-07	4.40E-07	4.40E-07	4.50E-07	4.60E-07	4.50E-07	2.20E-07	
1264	4.90E-07	4.90E-07	4.90E-07	4.90E-07	4.90E-07	4.90E-07	4.90E-07	4.90E-07	4.90E-07	4.90E-07	4.90E-07	
1265	5.40E-07	5.30E-07	5.30E-07	5.30E-07	5.40E-07	5.40E-07	5.40E-07	5.30E-07	5.40E-07	5.30E-07	5.40E-07	
Biased Statistics												
Average Biased	5.31E-07	4.97E-07	4.72E-07	4.54E-07	4.40E-07	4.30E-07	4.25E-07	4.23E-07	4.30E-07	4.20E-07	1.98E-07	
Std Dev Biased	4.07E-08	4.00E-08	3.74E-08	3.69E-08	3.71E-08	3.65E-08	3.87E-08	4.32E-08	4.19E-08	4.45E-08	7.70E-08	
Ps90%/90% (+KTL) Biased	6.15E-07	5.80E-07	5.49E-07	5.30E-07	5.17E-07	5.05E-07	5.05E-07	5.12E-07	5.17E-07	5.12E-07	3.57E-07	
Ps90%/90% (-KTL) Biased	4.47E-07	4.14E-07	3.95E-07	3.78E-07	3.63E-07	3.55E-07	3.45E-07	3.34E-07	3.43E-07	3.28E-07	3.90E-08	
Specification MIN	-4.00E-06	-5.00E-06	-5.00E-06	-5.00E-06	-5.00E-06	-7.50E-06	-7.50E-06	-7.50E-06	-7.50E-06	-1.00E-05	-1.50E-05	
Status	PASS	PASS	PASS	PASS	PASS	PASS	PASS	PASS	PASS	PASS	PASS	
Specification MAX	4.00E-06	5.00E-06	5.00E-06	5.00E-06	5.00E-06	7.50E-06	7.50E-06	7.50E-06	7.50E-06	1.00E-05	1.50E-05	
Status	PASS	PASS	PASS	PASS	PASS	PASS	PASS	PASS	PASS	PASS	PASS	

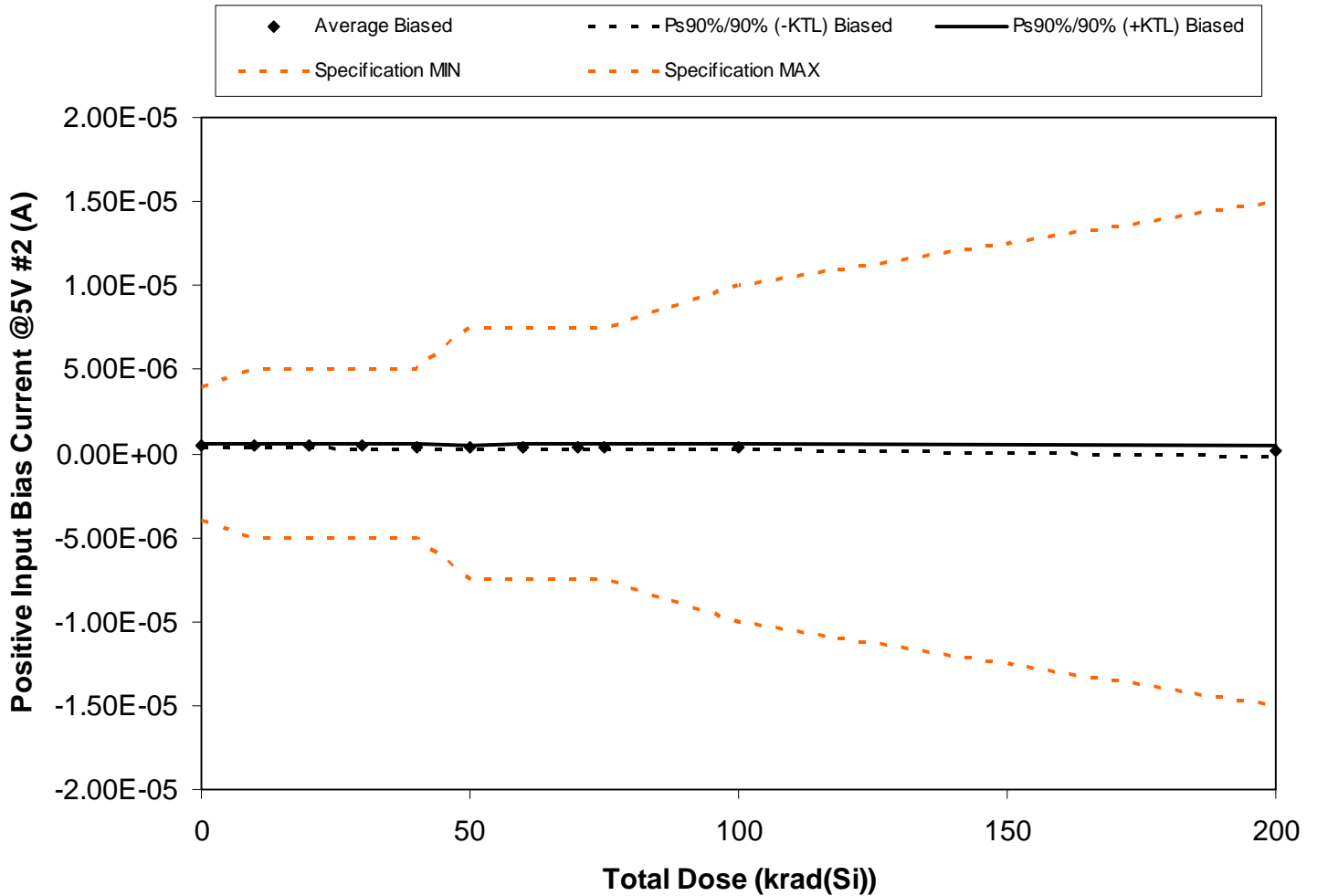

Figure 5.90. Plot of Positive Input Bias Current @5V #2 (A) versus total dose. The solid diamonds are the average of the measured data points for the samples irradiated under electrical bias and the black lines (solid and/or dashed) are the average of the data points after application of the KTL statistics on the samples irradiated under electrical bias. The red dotted line(s) are the pre- and/or post-irradiation minimum and/or maximum specification value as defined in the datasheet and/or test plan.



**RLAT Report
10-326 100808 R1.0**

**Radiation Assured Devices
5017 N. 30th Street
Colorado Springs, CO 80919
(719) 531-0800**

Table 5.90. Raw data for Positive Input Bias Current @5V #2 (A) versus total dose, including the statistical analysis, specification and the status of the testing (pass/fail).

Positive Input Bias Current @5V #2 (A)	Total Dose (krad(Si))											
	0	10	20	30	40	50	60	70	75	100	200	
Device												
1245	5.40E-07	5.10E-07	4.90E-07	4.80E-07	4.70E-07	4.60E-07	4.50E-07	4.50E-07	4.60E-07	4.40E-07	2.50E-07	
1246	5.10E-07	4.80E-07	4.50E-07	4.30E-07	4.20E-07	4.10E-07	4.00E-07	4.00E-07	4.00E-07	3.90E-07	1.50E-07	
1247	5.80E-07	5.50E-07	5.50E-07	5.40E-07	5.40E-07	5.40E-07	5.50E-07	5.50E-07	5.60E-07	5.70E-07	5.30E-07	
1248	4.20E-07	3.90E-07	3.60E-07	3.40E-07	3.30E-07	3.20E-07	3.10E-07	3.10E-07	3.20E-07	3.10E-07	9.00E-08	
1249	5.00E-07	4.60E-07	4.30E-07	4.20E-07	4.00E-07	3.90E-07	4.00E-07	3.90E-07	4.00E-07	4.00E-07	1.80E-07	
1250	5.60E-07	5.20E-07	4.80E-07	4.60E-07	4.30E-07	4.10E-07	4.00E-07	3.90E-07	3.90E-07	3.60E-07	3.00E-08	
1251	5.10E-07	4.70E-07	4.40E-07	4.20E-07	4.10E-07	4.00E-07	3.90E-07	3.80E-07	3.90E-07	3.80E-07	1.20E-07	
1261	5.10E-07	4.70E-07	4.40E-07	4.30E-07	4.10E-07	4.00E-07	3.90E-07	3.80E-07	3.80E-07	3.70E-07	1.00E-07	
1262	4.90E-07	4.50E-07	4.30E-07	4.00E-07	3.90E-07	3.80E-07	3.70E-07	3.70E-07	3.70E-07	3.60E-07	1.10E-07	
1263	4.70E-07	4.20E-07	4.00E-07	3.80E-07	3.70E-07	3.50E-07	3.40E-07	3.40E-07	3.40E-07	3.30E-07	8.00E-08	
1264	6.00E-07	5.90E-07	5.90E-07	5.90E-07	5.90E-07	5.90E-07	5.90E-07	5.90E-07	5.90E-07	5.90E-07	5.90E-07	
1265	5.80E-07	5.70E-07	5.70E-07	5.70E-07	5.80E-07	5.70E-07	5.70E-07	5.70E-07	5.80E-07	5.80E-07	5.70E-07	
Biased Statistics												
Average Biased	5.09E-07	4.72E-07	4.47E-07	4.30E-07	4.17E-07	4.06E-07	4.00E-07	3.96E-07	4.01E-07	3.91E-07	1.64E-07	
Std Dev Biased	4.53E-08	4.71E-08	5.17E-08	5.50E-08	5.68E-08	6.00E-08	6.48E-08	6.54E-08	6.72E-08	7.25E-08	1.42E-07	
Ps90%/90% (+KTL) Biased	6.03E-07	5.69E-07	5.54E-07	5.44E-07	5.34E-07	5.30E-07	5.34E-07	5.31E-07	5.40E-07	5.41E-07	4.57E-07	
Ps90%/90% (-KTL) Biased	4.15E-07	3.75E-07	3.40E-07	3.16E-07	3.00E-07	2.82E-07	2.66E-07	2.61E-07	2.62E-07	2.41E-07	-1.29E-07	
Specification MIN	-4.00E-06	-5.00E-06	-5.00E-06	-5.00E-06	-5.00E-06	-7.50E-06	-7.50E-06	-7.50E-06	-7.50E-06	-1.00E-05	-1.50E-05	
Status	PASS	PASS	PASS	PASS	PASS	PASS	PASS	PASS	PASS	PASS	PASS	
Specification MAX	4.00E-06	5.00E-06	5.00E-06	5.00E-06	5.00E-06	7.50E-06	7.50E-06	7.50E-06	7.50E-06	1.00E-05	1.50E-05	
Status	PASS	PASS	PASS	PASS	PASS	PASS	PASS	PASS	PASS	PASS	PASS	

An ISO 9001:2008 and DSCC Certified Company

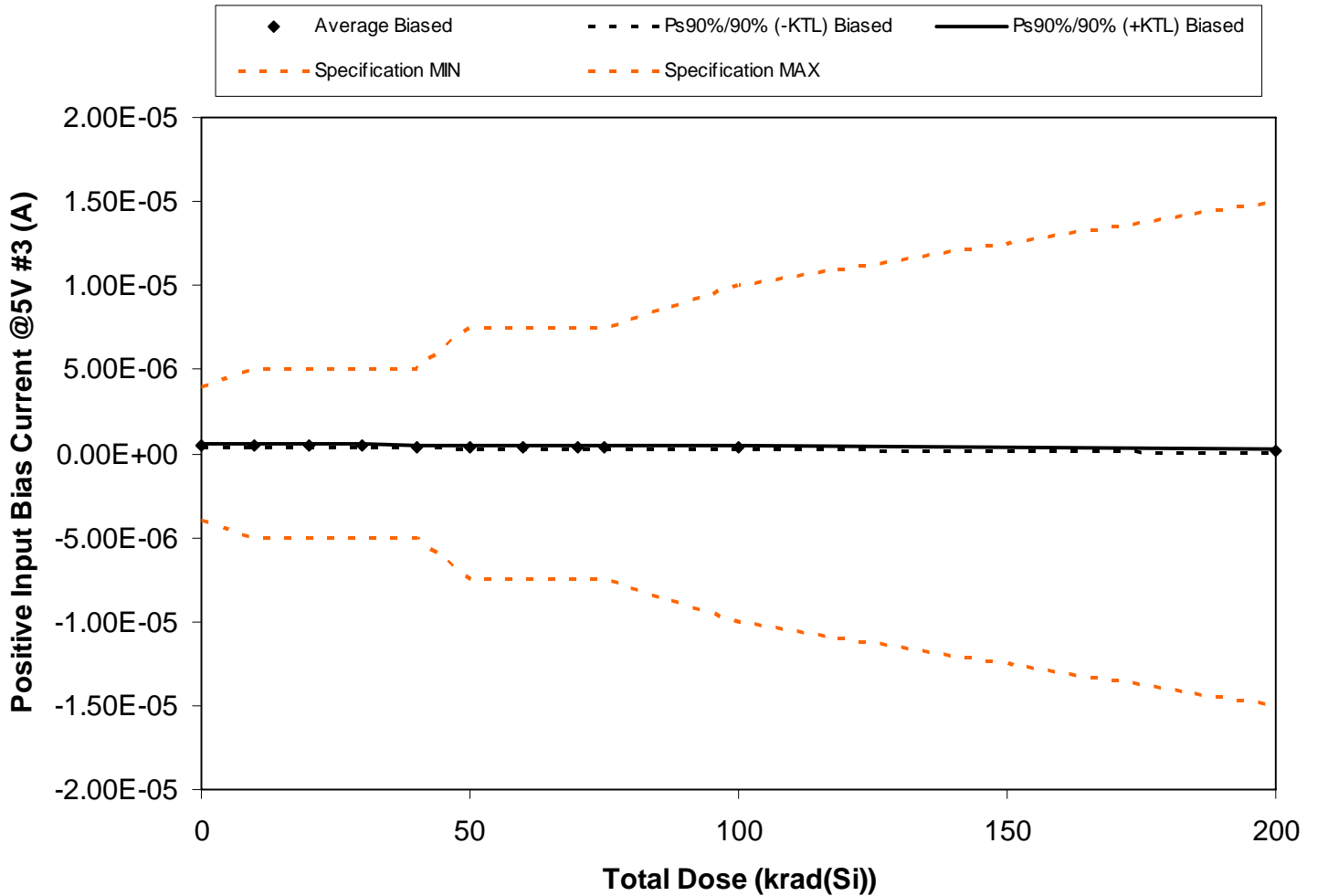

Figure 5.91. Plot of Positive Input Bias Current @5V #3 (A) versus total dose. The solid diamonds are the average of the measured data points for the samples irradiated under electrical bias and the black lines (solid and/or dashed) are the average of the data points after application of the KTL statistics on the samples irradiated under electrical bias. The red dotted line(s) are the pre- and/or post-irradiation minimum and/or maximum specification value as defined in the datasheet and/or test plan.



**RLAT Report
10-326 100808 R1.0**

**Radiation Assured Devices
5017 N. 30th Street
Colorado Springs, CO 80919
(719) 531-0800**

Table 5.91. Raw data for Positive Input Bias Current @5V #3 (A) versus total dose, including the statistical analysis, specification and the status of the testing (pass/fail).

Positive Input Bias Current @5V #3 (A)	Total Dose (krad(Si))											
	0	10	20	30	40	50	60	70	75	100	200	
Device												
1245	5.50E-07	5.10E-07	4.90E-07	4.70E-07	4.60E-07	4.50E-07	4.40E-07	4.40E-07	4.40E-07	4.30E-07	2.20E-07	
1246	4.80E-07	4.50E-07	4.20E-07	4.00E-07	3.90E-07	3.80E-07	3.80E-07	3.80E-07	3.80E-07	3.80E-07	1.50E-07	
1247	5.80E-07	5.50E-07	5.30E-07	5.10E-07	4.90E-07	4.80E-07	4.80E-07	4.70E-07	4.80E-07	4.80E-07	2.50E-07	
1248	4.20E-07	3.90E-07	3.70E-07	3.60E-07	3.50E-07	3.40E-07	3.40E-07	3.40E-07	3.50E-07	3.50E-07	2.00E-07	
1249	5.10E-07	4.70E-07	4.50E-07	4.30E-07	4.20E-07	4.10E-07	4.10E-07	4.10E-07	4.20E-07	4.20E-07	2.00E-07	
1250	5.50E-07	5.10E-07	4.80E-07	4.60E-07	4.40E-07	4.20E-07	4.10E-07	4.00E-07	4.00E-07	3.80E-07	9.00E-08	
1251	5.20E-07	4.80E-07	4.50E-07	4.30E-07	4.20E-07	4.10E-07	4.00E-07	4.00E-07	4.10E-07	3.90E-07	1.50E-07	
1261	5.30E-07	5.00E-07	4.70E-07	4.60E-07	4.50E-07	4.50E-07	4.40E-07	4.40E-07	4.40E-07	4.40E-07	2.50E-07	
1262	5.00E-07	4.60E-07	4.40E-07	4.20E-07	4.10E-07	4.00E-07	4.00E-07	4.00E-07	4.00E-07	3.90E-07	1.70E-07	
1263	4.30E-07	4.00E-07	3.70E-07	3.50E-07	3.40E-07	3.30E-07	3.20E-07	3.20E-07	3.20E-07	3.10E-07	8.00E-08	
1264	5.50E-07	5.50E-07	5.50E-07	5.50E-07	5.50E-07	5.50E-07	5.50E-07	5.50E-07	5.50E-07	5.50E-07	5.50E-07	
1265	5.60E-07	5.50E-07	5.50E-07	5.50E-07	5.50E-07	5.50E-07	5.50E-07	5.50E-07	5.50E-07	5.50E-07	5.50E-07	
Biased Statistics												
Average Biased	5.07E-07	4.72E-07	4.47E-07	4.29E-07	4.17E-07	4.07E-07	4.02E-07	4.00E-07	4.04E-07	3.97E-07	1.76E-07	
Std Dev Biased	5.17E-08	4.98E-08	5.06E-08	4.95E-08	4.72E-08	4.76E-08	4.73E-08	4.55E-08	4.62E-08	4.81E-08	5.97E-08	
Ps90%/90% (+KTL) Biased	6.14E-07	5.75E-07	5.51E-07	5.31E-07	5.14E-07	5.05E-07	5.00E-07	4.94E-07	4.99E-07	4.96E-07	2.99E-07	
Ps90%/90% (-KTL) Biased	4.00E-07	3.69E-07	3.43E-07	3.27E-07	3.20E-07	3.09E-07	3.04E-07	3.06E-07	3.09E-07	2.98E-07	5.28E-08	
Specification MIN	-4.00E-06	-5.00E-06	-5.00E-06	-5.00E-06	-5.00E-06	-7.50E-06	-7.50E-06	-7.50E-06	-7.50E-06	-1.00E-05	-1.50E-05	
Status	PASS	PASS	PASS	PASS	PASS	PASS	PASS	PASS	PASS	PASS	PASS	
Specification MAX	4.00E-06	5.00E-06	5.00E-06	5.00E-06	5.00E-06	7.50E-06	7.50E-06	7.50E-06	7.50E-06	1.00E-05	1.50E-05	
Status	PASS	PASS	PASS	PASS	PASS	PASS	PASS	PASS	PASS	PASS	PASS	

An ISO 9001:2008 and DSCC Certified Company

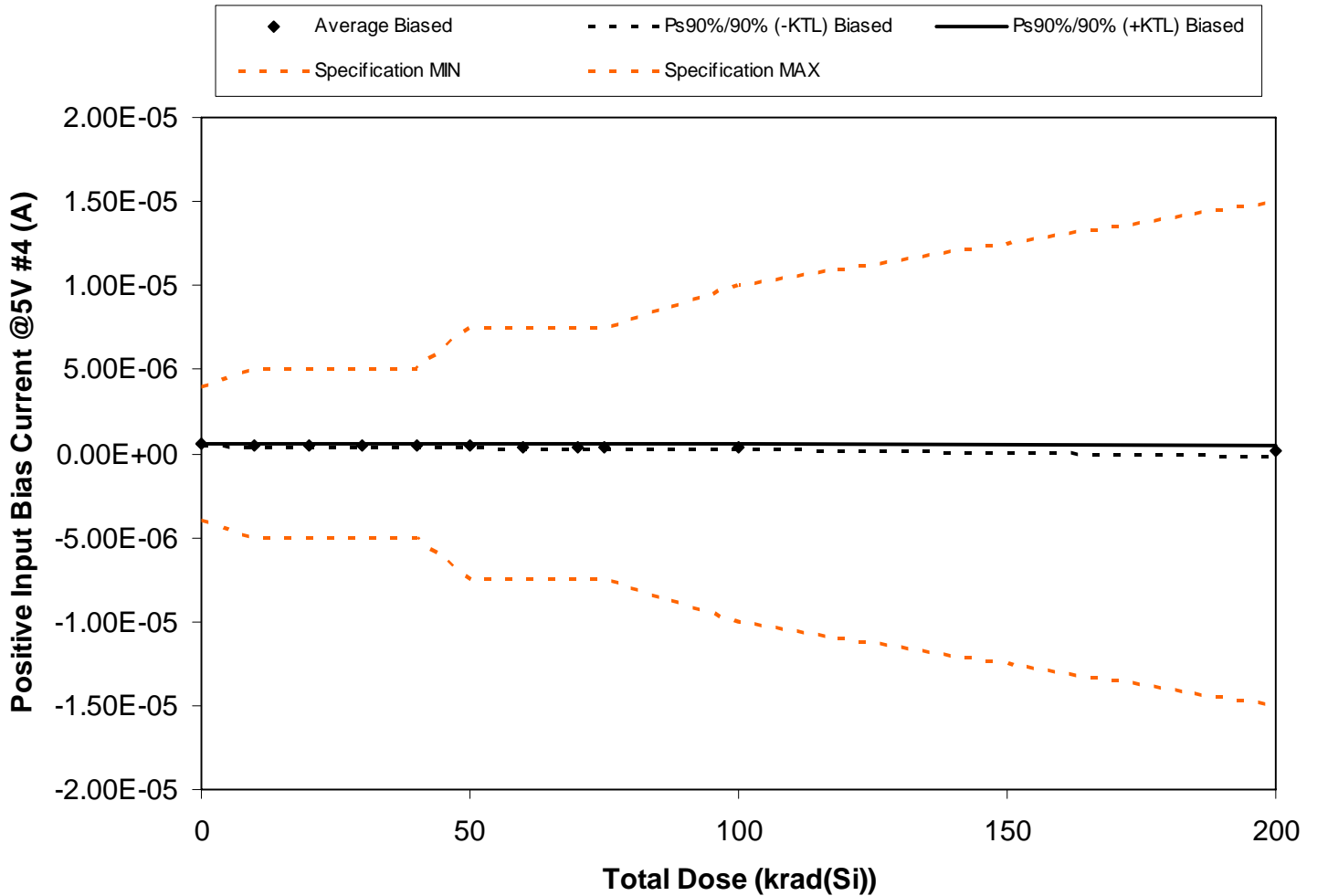

Figure 5.92. Plot of Positive Input Bias Current @5V #4 (A) versus total dose. The solid diamonds are the average of the measured data points for the samples irradiated under electrical bias and the black lines (solid and/or dashed) are the average of the data points after application of the KTL statistics on the samples irradiated under electrical bias. The red dotted line(s) are the pre- and/or post-irradiation minimum and/or maximum specification value as defined in the datasheet and/or test plan.



**RLAT Report
10-326 100808 R1.0**

**Radiation Assured Devices
5017 N. 30th Street
Colorado Springs, CO 80919
(719) 531-0800**

Table 5.92. Raw data for Positive Input Bias Current @5V #4 (A) versus total dose, including the statistical analysis, specification and the status of the testing (pass/fail).

Positive Input Bias Current @5V #4 (A)	Total Dose (krad(Si))											
	0	10	20	30	40	50	60	70	75	100	200	
Device												
1245	5.30E-07	4.90E-07	4.60E-07	4.30E-07	4.10E-07	4.00E-07	3.80E-07	3.70E-07	3.80E-07	3.50E-07	5.00E-08	
1246	5.60E-07	5.30E-07	5.00E-07	4.80E-07	4.60E-07	4.50E-07	4.40E-07	4.40E-07	4.40E-07	4.30E-07	2.00E-07	
1247	4.70E-07	4.40E-07	4.10E-07	4.00E-07	3.80E-07	3.70E-07	3.60E-07	3.50E-07	3.60E-07	3.40E-07	1.00E-07	
1248	5.40E-07	5.00E-07	4.70E-07	4.50E-07	4.30E-07	4.20E-07	4.10E-07	4.00E-07	4.10E-07	4.00E-07	1.40E-07	
1249	4.90E-07	4.60E-07	4.30E-07	4.20E-07	4.10E-07	4.00E-07	4.00E-07	3.90E-07	4.00E-07	4.00E-07	2.10E-07	
1250	5.40E-07	5.00E-07	4.60E-07	4.40E-07	4.20E-07	4.10E-07	4.00E-07	3.90E-07	4.00E-07	3.80E-07	9.00E-08	
1251	5.90E-07	5.50E-07	5.20E-07	5.10E-07	5.00E-07	4.90E-07	4.80E-07	4.80E-07	4.80E-07	4.70E-07	2.40E-07	
1261	5.70E-07	5.50E-07	5.40E-07	5.30E-07	5.30E-07	5.40E-07	5.40E-07	5.50E-07	5.60E-07	5.80E-07	5.30E-07	
1262	5.50E-07	5.00E-07	4.70E-07	4.40E-07	4.20E-07	4.10E-07	4.00E-07	3.90E-07	4.00E-07	3.80E-07	1.00E-07	
1263	5.20E-07	4.70E-07	4.40E-07	4.10E-07	4.00E-07	3.80E-07	3.80E-07	3.70E-07	3.80E-07	3.70E-07	7.00E-08	
1264	5.40E-07	5.30E-07	5.30E-07	5.30E-07	5.30E-07	5.30E-07	5.30E-07	5.30E-07	5.40E-07	5.30E-07	5.30E-07	
1265	5.40E-07	5.30E-07	5.30E-07	5.30E-07	5.30E-07	5.30E-07	5.30E-07	5.40E-07	5.40E-07	5.30E-07	5.30E-07	
Biased Statistics												
Average Biased	5.36E-07	4.99E-07	4.70E-07	4.51E-07	4.36E-07	4.27E-07	4.19E-07	4.13E-07	4.21E-07	4.10E-07	1.73E-07	
Std Dev Biased	3.60E-08	3.67E-08	4.03E-08	4.28E-08	4.70E-08	5.25E-08	5.43E-08	6.09E-08	5.93E-08	7.07E-08	1.41E-07	
Ps90%/90% (+KTL) Biased	6.10E-07	5.75E-07	5.53E-07	5.39E-07	5.33E-07	5.35E-07	5.31E-07	5.39E-07	5.44E-07	5.56E-07	4.64E-07	
Ps90%/90% (-KTL) Biased	4.62E-07	4.23E-07	3.87E-07	3.63E-07	3.39E-07	3.19E-07	3.07E-07	2.87E-07	2.98E-07	2.64E-07	-1.18E-07	
Specification MIN	-4.00E-06	-5.00E-06	-5.00E-06	-5.00E-06	-5.00E-06	-7.50E-06	-7.50E-06	-7.50E-06	-7.50E-06	-1.00E-05	-1.50E-05	
Status	PASS	PASS	PASS	PASS	PASS	PASS	PASS	PASS	PASS	PASS	PASS	
Specification MAX	4.00E-06	5.00E-06	5.00E-06	5.00E-06	5.00E-06	7.50E-06	7.50E-06	7.50E-06	7.50E-06	1.00E-05	1.50E-05	
Status	PASS	PASS	PASS	PASS	PASS	PASS	PASS	PASS	PASS	PASS	PASS	

An ISO 9001:2008 and DSCC Certified Company

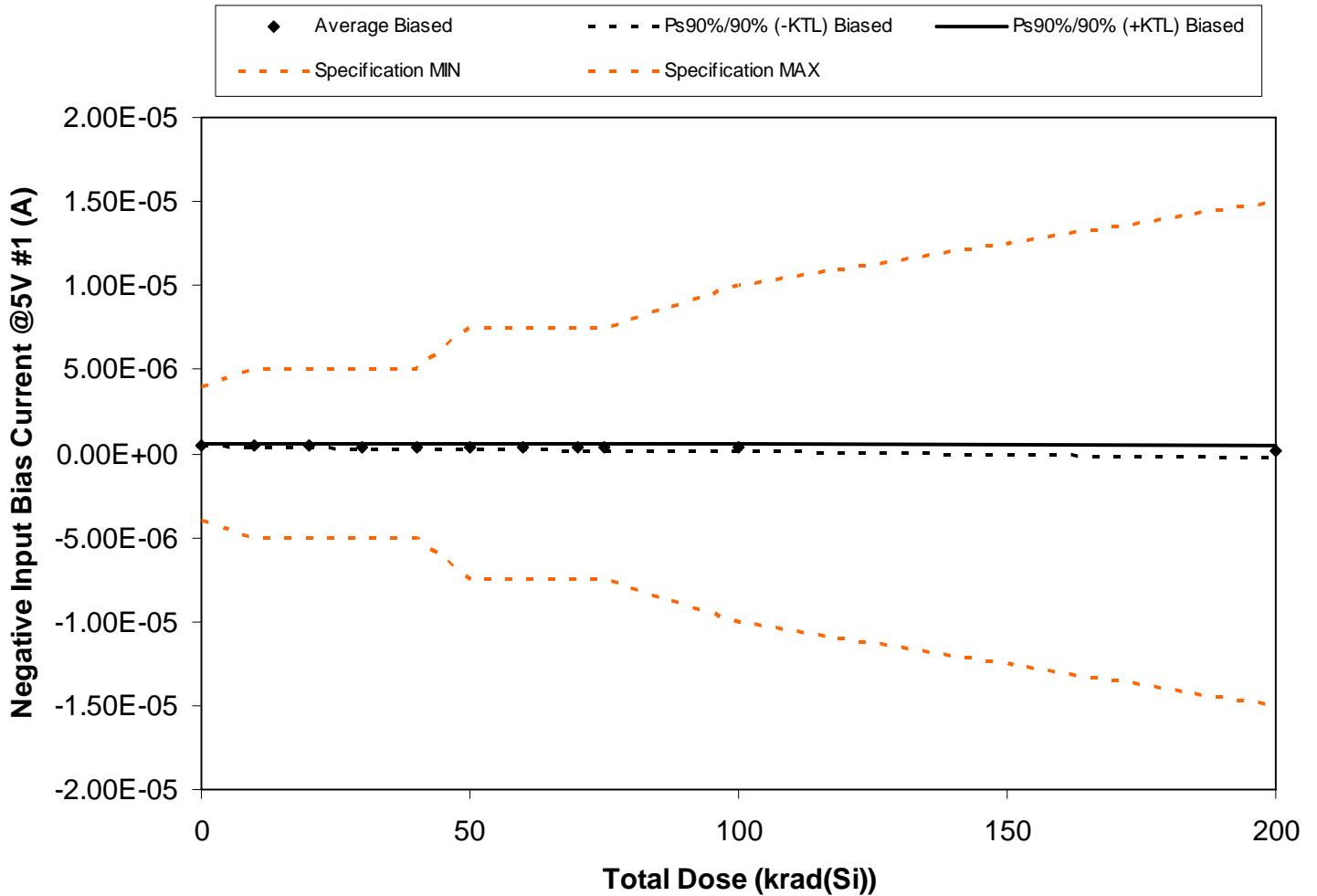

Figure 5.93. Plot of Negative Input Bias Current @5V #1 (A) versus total dose. The solid diamonds are the average of the measured data points for the samples irradiated under electrical bias and the black lines (solid and/or dashed) are the average of the data points after application of the KTL statistics on the samples irradiated under electrical bias. The red dotted line(s) are the pre- and/or post-irradiation minimum and/or maximum specification value as defined in the datasheet and/or test plan.



**RLAT Report
10-326 100808 R1.0**

**Radiation Assured Devices
5017 N. 30th Street
Colorado Springs, CO 80919
(719) 531-0800**

Table 5.93. Raw data for Negative Input Bias Current @5V #1 (A) versus total dose, including the statistical analysis, specification and the status of the testing (pass/fail).

Negative Input Bias Current @5V #1 (A)	Total Dose (krad(Si))											
	0	10	20	30	40	50	60	70	75	100	200	
Device												
1245	5.60E-07	5.30E-07	5.10E-07	4.90E-07	4.80E-07	4.70E-07	4.60E-07	4.60E-07	4.70E-07	4.50E-07	3.00E-07	
1246	5.30E-07	4.80E-07	4.30E-07	4.00E-07	3.70E-07	3.50E-07	3.30E-07	3.20E-07	3.10E-07	2.80E-07	-3.00E-08	
1247	4.50E-07	4.00E-07	3.50E-07	3.20E-07	2.90E-07	2.60E-07	2.40E-07	2.20E-07	2.10E-07	1.70E-07	-1.80E-07	
1248	4.80E-07	4.50E-07	4.30E-07	4.00E-07	3.80E-07	3.70E-07	3.50E-07	3.40E-07	3.40E-07	2.90E-07	1.10E-07	
1249	4.80E-07	4.40E-07	4.20E-07	4.00E-07	4.00E-07	4.00E-07	4.00E-07	4.00E-07	4.00E-07	4.00E-07	3.10E-07	
1250	5.60E-07	5.20E-07	5.00E-07	4.80E-07	4.70E-07	4.60E-07	4.60E-07	4.60E-07	4.70E-07	4.50E-07	3.10E-07	
1251	5.80E-07	5.40E-07	5.20E-07	5.10E-07	5.00E-07	4.90E-07	4.90E-07	4.90E-07	4.90E-07	4.80E-07	3.50E-07	
1261	5.60E-07	5.10E-07	4.70E-07	4.50E-07	4.30E-07	4.30E-07	4.10E-07	4.00E-07	4.00E-07	3.80E-07	1.10E-07	
1262	5.40E-07	4.80E-07	4.40E-07	4.00E-07	3.70E-07	3.50E-07	3.30E-07	3.10E-07	3.10E-07	2.60E-07	-8.00E-08	
1263	5.30E-07	4.70E-07	4.30E-07	3.90E-07	3.60E-07	3.30E-07	3.10E-07	2.90E-07	2.90E-07	2.50E-07	-1.00E-07	
1264	4.90E-07	4.90E-07	4.90E-07	4.90E-07	4.90E-07	4.90E-07	4.90E-07	4.90E-07	4.90E-07	4.90E-07	4.90E-07	
1265	5.30E-07	5.30E-07	5.30E-07	5.30E-07	5.30E-07	5.30E-07	5.30E-07	5.30E-07	5.30E-07	5.30E-07	5.30E-07	
Biased Statistics												
Average Biased	5.27E-07	4.82E-07	4.50E-07	4.24E-07	4.05E-07	3.91E-07	3.78E-07	3.69E-07	3.69E-07	3.41E-07	1.10E-07	
Std Dev Biased	4.30E-08	4.42E-08	5.12E-08	5.76E-08	6.49E-08	7.23E-08	7.93E-08	8.71E-08	9.21E-08	1.05E-07	1.99E-07	
Ps90%/90% (+KTL) Biased	6.16E-07	5.73E-07	5.56E-07	5.43E-07	5.39E-07	5.40E-07	5.42E-07	5.49E-07	5.59E-07	5.57E-07	5.22E-07	
Ps90%/90% (-KTL) Biased	4.38E-07	3.91E-07	3.44E-07	3.05E-07	2.71E-07	2.42E-07	2.14E-07	1.89E-07	1.79E-07	1.25E-07	-3.02E-07	
Specification MIN	-4.00E-06	-5.00E-06	-5.00E-06	-5.00E-06	-5.00E-06	-7.50E-06	-7.50E-06	-7.50E-06	-7.50E-06	-1.00E-05	-1.50E-05	
Status	PASS	PASS	PASS	PASS	PASS	PASS	PASS	PASS	PASS	PASS	PASS	
Specification MAX	4.00E-06	5.00E-06	5.00E-06	5.00E-06	5.00E-06	7.50E-06	7.50E-06	7.50E-06	7.50E-06	1.00E-05	1.50E-05	
Status	PASS	PASS	PASS	PASS	PASS	PASS	PASS	PASS	PASS	PASS	PASS	

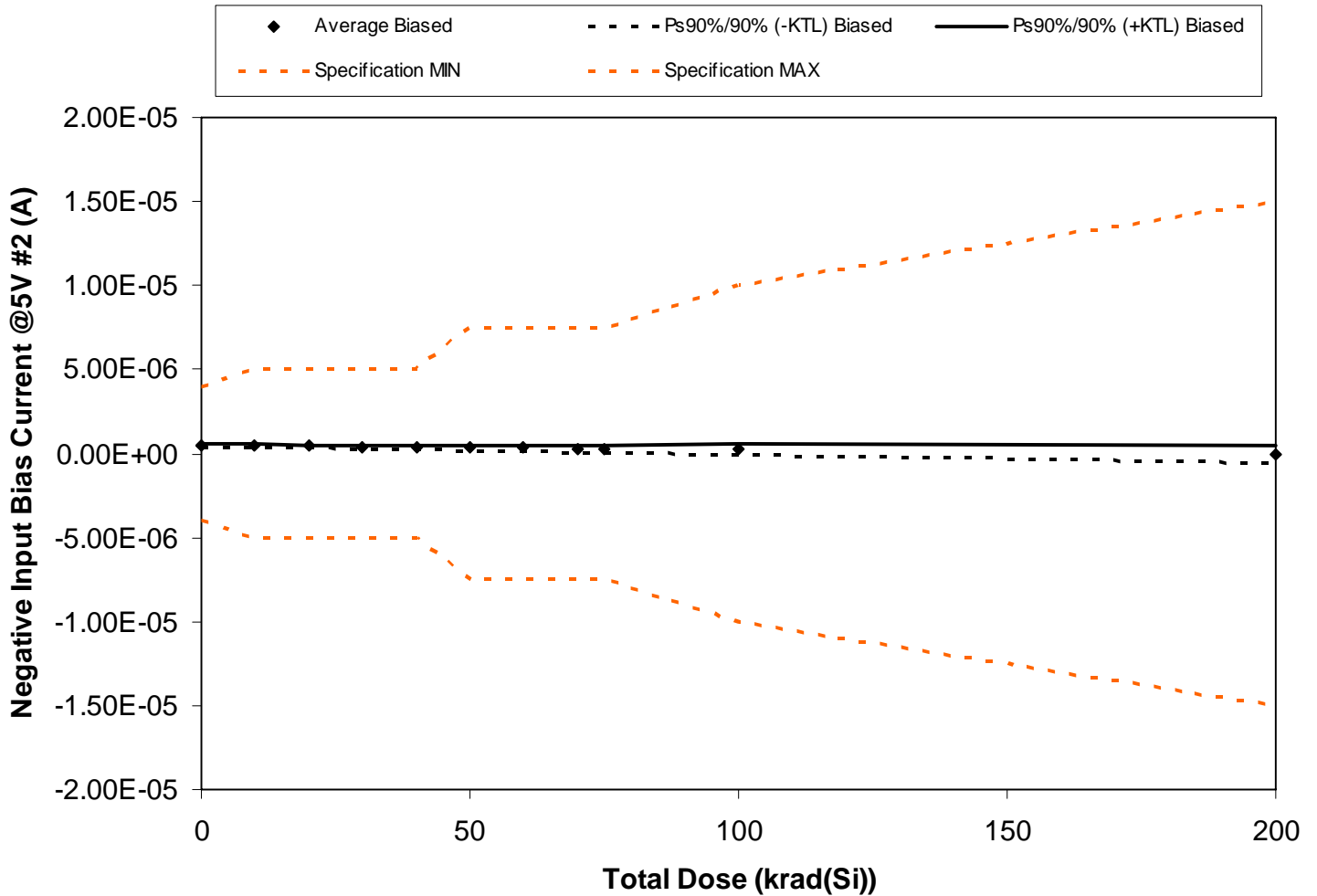

Figure 5.94. Plot of Negative Input Bias Current @5V #2 (A) versus total dose. The solid diamonds are the average of the measured data points for the samples irradiated under electrical bias and the black lines (solid and/or dashed) are the average of the data points after application of the KTL statistics on the samples irradiated under electrical bias. The red dotted line(s) are the pre- and/or post-irradiation minimum and/or maximum specification value as defined in the datasheet and/or test plan.



**RLAT Report
10-326 100808 R1.0**

**Radiation Assured Devices
5017 N. 30th Street
Colorado Springs, CO 80919
(719) 531-0800**

Table 5.94. Raw data for Negative Input Bias Current @5V #2 (A) versus total dose, including the statistical analysis, specification and the status of the testing (pass/fail).

Negative Input Bias Current @5V #2 (A)	Total Dose (krad(Si))											
	0	10	20	30	40	50	60	70	75	100	200	
Device												
1245	5.30E-07	5.00E-07	4.90E-07	4.80E-07	4.70E-07	4.70E-07	4.60E-07	4.70E-07	4.70E-07	4.70E-07	4.70E-07	3.90E-07
1246	5.40E-07	4.90E-07	4.40E-07	4.00E-07	3.70E-07	3.40E-07	3.20E-07	3.00E-07	2.90E-07	2.50E-07	2.50E-07	-1.10E-07
1247	5.60E-07	5.20E-07	5.00E-07	4.80E-07	4.70E-07	4.70E-07	4.70E-07	4.70E-07	4.70E-07	4.60E-07	4.60E-07	3.30E-07
1248	4.30E-07	3.90E-07	3.40E-07	2.90E-07	2.60E-07	2.20E-07	1.80E-07	1.50E-07	1.30E-07	5.00E-08	5.00E-08	-2.70E-07
1249	5.10E-07	4.60E-07	4.20E-07	3.80E-07	3.50E-07	3.20E-07	3.00E-07	2.80E-07	2.80E-07	2.40E-07	2.40E-07	-9.00E-08
1250	5.40E-07	4.80E-07	4.30E-07	3.80E-07	3.40E-07	3.10E-07	2.80E-07	2.40E-07	2.30E-07	1.70E-07	1.70E-07	-2.70E-07
1251	5.00E-07	4.50E-07	4.00E-07	3.70E-07	3.40E-07	3.20E-07	2.90E-07	2.70E-07	2.70E-07	2.30E-07	2.30E-07	-1.30E-07
1261	5.40E-07	4.80E-07	4.40E-07	4.00E-07	3.60E-07	3.40E-07	3.00E-07	2.80E-07	2.70E-07	2.20E-07	2.20E-07	-1.80E-07
1262	5.00E-07	4.40E-07	3.90E-07	3.60E-07	3.20E-07	2.90E-07	2.70E-07	2.50E-07	2.50E-07	1.90E-07	1.90E-07	-1.80E-07
1263	4.50E-07	4.20E-07	4.00E-07	3.90E-07	3.80E-07	3.80E-07	3.80E-07	3.80E-07	3.90E-07	3.90E-07	3.90E-07	2.70E-07
1264	5.60E-07	5.60E-07	5.60E-07	5.60E-07	5.60E-07	5.60E-07	5.60E-07	5.60E-07	5.60E-07	5.60E-07	5.60E-07	5.60E-07
1265	5.60E-07	5.50E-07	5.50E-07	5.50E-07	5.50E-07	5.50E-07	5.50E-07	5.50E-07	5.50E-07	5.50E-07	5.50E-07	5.50E-07
Biased Statistics												
Average Biased	5.10E-07	4.63E-07	4.25E-07	3.93E-07	3.66E-07	3.46E-07	3.25E-07	3.09E-07	3.05E-07	2.67E-07	2.67E-07	-2.40E-08
Std Dev Biased	4.19E-08	3.92E-08	4.72E-08	5.56E-08	6.40E-08	7.72E-08	8.87E-08	1.02E-07	1.08E-07	1.34E-07	1.34E-07	2.53E-07
Ps90%/90% (+KTL) Biased	5.97E-07	5.44E-07	5.22E-07	5.08E-07	4.98E-07	5.05E-07	5.08E-07	5.20E-07	5.27E-07	5.43E-07	5.43E-07	4.98E-07
Ps90%/90% (-KTL) Biased	4.23E-07	3.82E-07	3.28E-07	2.78E-07	2.34E-07	1.87E-07	1.42E-07	9.83E-08	8.28E-08	-8.86E-09	-8.86E-09	-5.46E-07
Specification MIN	-4.00E-06	-5.00E-06	-5.00E-06	-5.00E-06	-5.00E-06	-7.50E-06	-7.50E-06	-7.50E-06	-7.50E-06	-7.50E-06	-1.00E-05	-1.50E-05
Status	PASS	PASS	PASS	PASS	PASS	PASS	PASS	PASS	PASS	PASS	PASS	PASS
Specification MAX	4.00E-06	5.00E-06	5.00E-06	5.00E-06	5.00E-06	7.50E-06	7.50E-06	7.50E-06	7.50E-06	1.00E-05	1.00E-05	1.50E-05
Status	PASS	PASS	PASS	PASS	PASS	PASS	PASS	PASS	PASS	PASS	PASS	PASS

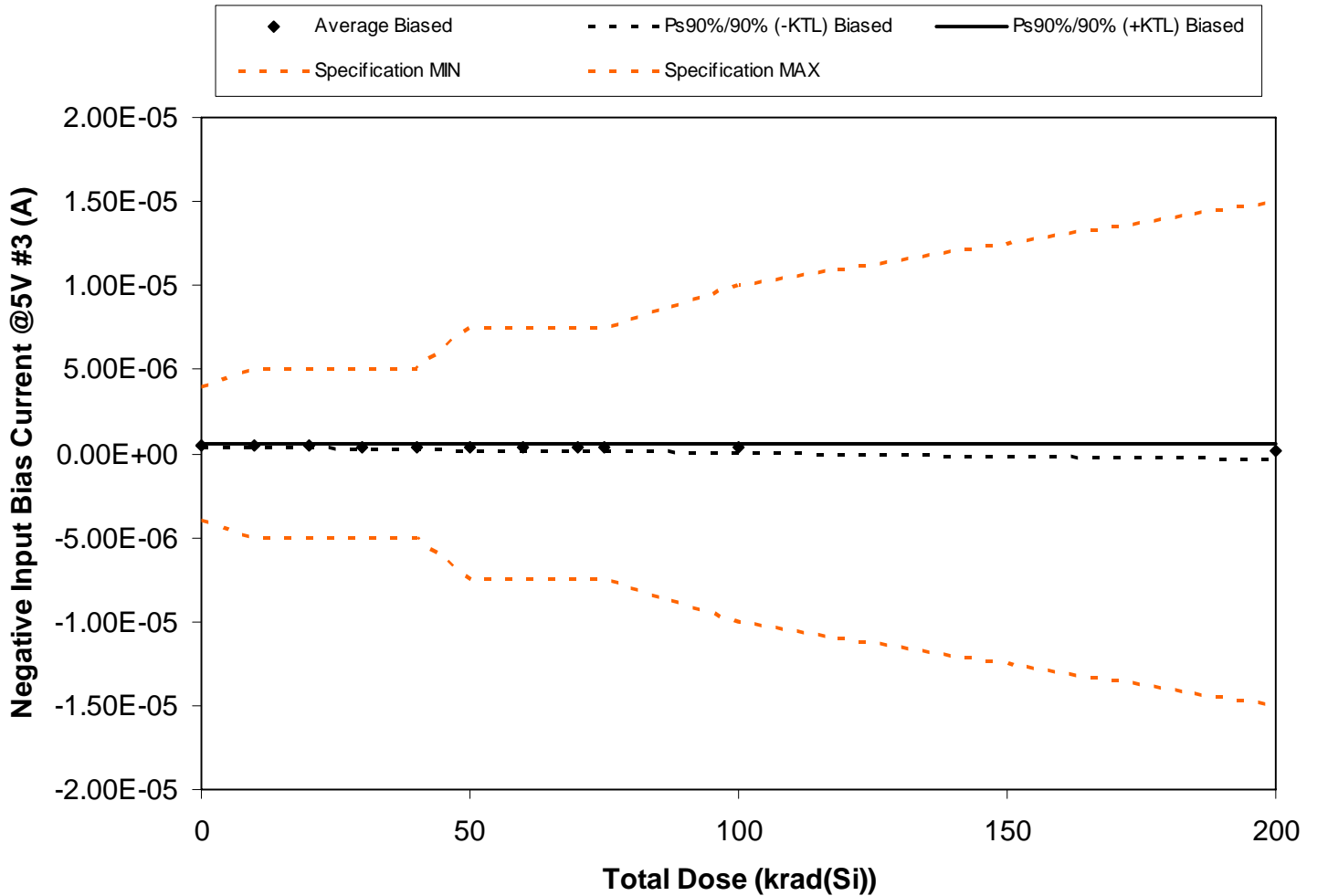

Figure 5.95. Plot of Negative Input Bias Current @5V #3 (A) versus total dose. The solid diamonds are the average of the measured data points for the samples irradiated under electrical bias and the black lines (solid and/or dashed) are the average of the data points after application of the KTL statistics on the samples irradiated under electrical bias. The red dotted line(s) are the pre- and/or post-irradiation minimum and/or maximum specification value as defined in the datasheet and/or test plan.



**RLAT Report
10-326 100808 R1.0**

**Radiation Assured Devices
5017 N. 30th Street
Colorado Springs, CO 80919
(719) 531-0800**

Table 5.95. Raw data for Negative Input Bias Current @5V #3 (A) versus total dose, including the statistical analysis, specification and the status of the testing (pass/fail).

Negative Input Bias Current @5V #3 (A)	Total Dose (krad(Si))											
	0	10	20	30	40	50	60	70	75	100	200	
Device												
1245	5.70E-07	5.40E-07	5.10E-07	4.90E-07	4.90E-07	4.80E-07	4.80E-07	4.80E-07	4.80E-07	4.70E-07	3.30E-07	
1246	5.10E-07	4.60E-07	4.20E-07	3.80E-07	3.50E-07	3.30E-07	3.10E-07	2.90E-07	2.80E-07	2.40E-07	-9.00E-08	
1247	5.60E-07	5.10E-07	4.60E-07	4.30E-07	3.90E-07	3.70E-07	3.50E-07	3.30E-07	3.20E-07	2.80E-07	-6.00E-08	
1248	4.10E-07	3.80E-07	3.40E-07	3.00E-07	2.60E-07	2.30E-07	1.90E-07	1.70E-07	1.50E-07	7.00E-08	-1.80E-07	
1249	5.10E-07	4.60E-07	4.10E-07	3.80E-07	3.50E-07	3.30E-07	3.10E-07	2.90E-07	2.90E-07	2.50E-07	-7.00E-08	
1250	5.60E-07	5.30E-07	5.10E-07	4.90E-07	4.80E-07	4.70E-07	4.70E-07	4.70E-07	4.80E-07	4.60E-07	3.10E-07	
1251	5.10E-07	4.60E-07	4.10E-07	3.80E-07	3.50E-07	3.20E-07	2.90E-07	2.70E-07	2.70E-07	2.30E-07	-1.30E-07	
1261	5.40E-07	5.10E-07	4.90E-07	4.90E-07	4.80E-07	4.80E-07	4.70E-07	4.80E-07	4.90E-07	4.80E-07	4.00E-07	
1262	5.00E-07	4.70E-07	4.60E-07	4.40E-07	4.40E-07	4.40E-07	4.40E-07	4.40E-07	4.60E-07	4.50E-07	3.70E-07	
1263	4.40E-07	4.10E-07	3.90E-07	3.70E-07	3.70E-07	3.60E-07	3.60E-07	3.60E-07	3.70E-07	3.60E-07	2.40E-07	
1264	5.40E-07	5.30E-07	5.40E-07	5.30E-07	5.30E-07	5.40E-07	5.40E-07	5.30E-07	5.40E-07	5.40E-07	5.40E-07	
1265	5.50E-07	5.50E-07	5.50E-07	5.50E-07	5.50E-07	5.50E-07	5.50E-07	5.50E-07	5.50E-07	5.50E-07	5.50E-07	
Biased Statistics												
Average Biased	5.11E-07	4.73E-07	4.40E-07	4.15E-07	3.96E-07	3.81E-07	3.67E-07	3.58E-07	3.59E-07	3.29E-07	1.12E-07	
Std Dev Biased	5.22E-08	5.12E-08	5.56E-08	6.38E-08	7.49E-08	8.39E-08	9.63E-08	1.07E-07	1.16E-07	1.37E-07	2.36E-07	
Ps90%/90% (+KTL) Biased	6.19E-07	5.79E-07	5.55E-07	5.47E-07	5.51E-07	5.54E-07	5.66E-07	5.78E-07	5.98E-07	6.12E-07	5.99E-07	
Ps90%/90% (-KTL) Biased	4.03E-07	3.67E-07	3.25E-07	2.83E-07	2.41E-07	2.08E-07	1.68E-07	1.38E-07	1.20E-07	4.61E-08	-3.75E-07	
Specification MIN	-4.00E-06	-5.00E-06	-5.00E-06	-5.00E-06	-5.00E-06	-7.50E-06	-7.50E-06	-7.50E-06	-7.50E-06	-1.00E-05	-1.50E-05	
Status	PASS	PASS	PASS	PASS	PASS	PASS	PASS	PASS	PASS	PASS	PASS	
Specification MAX	4.00E-06	5.00E-06	5.00E-06	5.00E-06	5.00E-06	7.50E-06	7.50E-06	7.50E-06	7.50E-06	1.00E-05	1.50E-05	
Status	PASS	PASS	PASS	PASS	PASS	PASS	PASS	PASS	PASS	PASS	PASS	

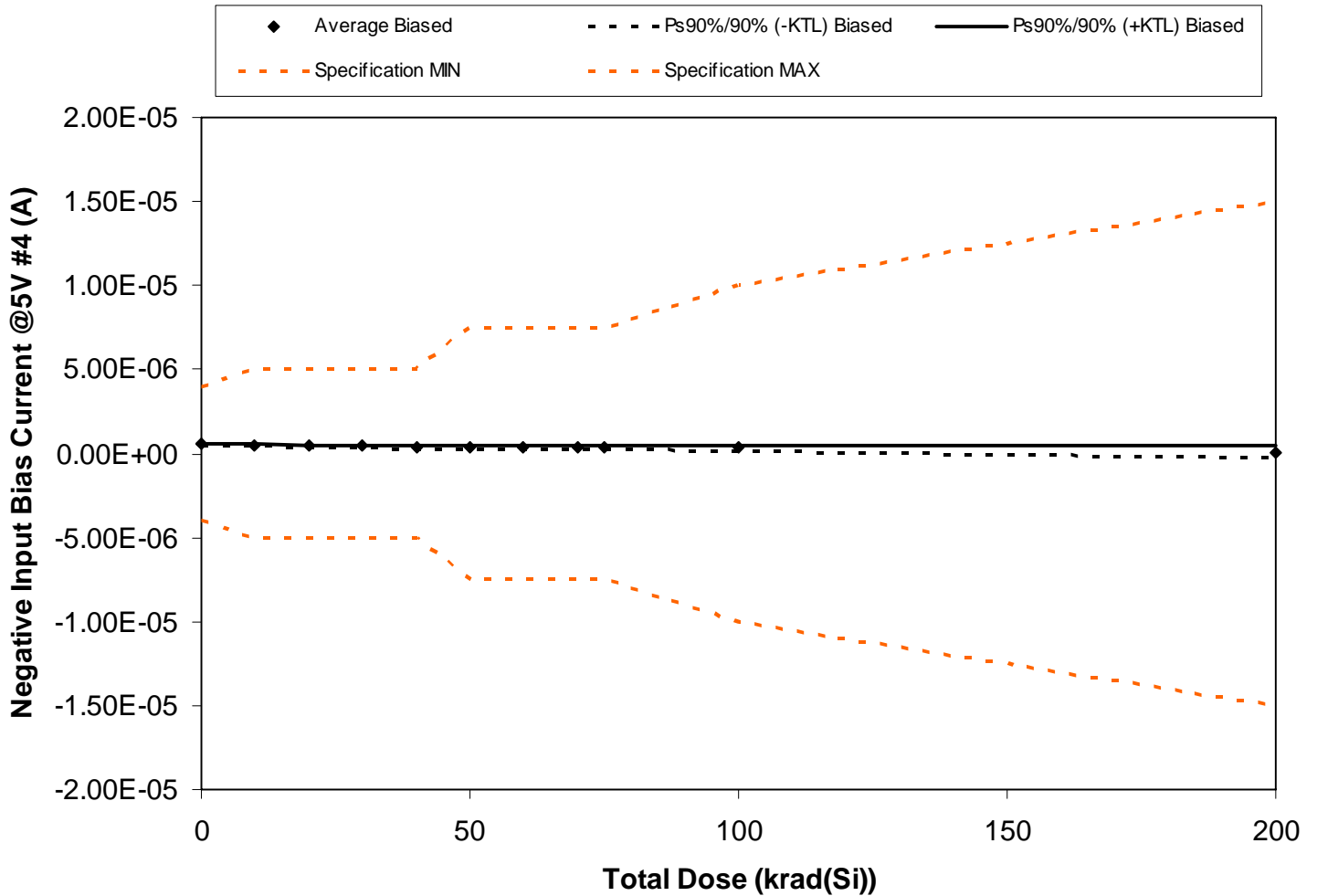

Figure 5.96. Plot of Negative Input Bias Current @5V #4 (A) versus total dose. The solid diamonds are the average of the measured data points for the samples irradiated under electrical bias and the black lines (solid and/or dashed) are the average of the data points after application of the KTL statistics on the samples irradiated under electrical bias. The red dotted line(s) are the pre- and/or post-irradiation minimum and/or maximum specification value as defined in the datasheet and/or test plan.



**RLAT Report
10-326 100808 R1.0**

**Radiation Assured Devices
5017 N. 30th Street
Colorado Springs, CO 80919
(719) 531-0800**

Table 5.96. Raw data for Negative Input Bias Current @5V #4 (A) versus total dose, including the statistical analysis, specification and the status of the testing (pass/fail).

Negative Input Bias Current @5V #4 (A)	Total Dose (krad(Si))											
	0	10	20	30	40	50	60	70	75	100	200	
Device												
1245	5.40E-07	5.00E-07	4.70E-07	4.50E-07	4.30E-07	4.20E-07	4.20E-07	4.10E-07	4.10E-07	3.90E-07	1.90E-07	
1246	5.50E-07	5.20E-07	4.90E-07	4.80E-07	4.70E-07	4.60E-07	4.60E-07	4.50E-07	4.60E-07	4.40E-07	3.00E-07	
1247	4.80E-07	4.50E-07	4.30E-07	4.10E-07	4.00E-07	3.90E-07	3.90E-07	3.90E-07	3.90E-07	3.70E-07	2.10E-07	
1248	5.40E-07	5.10E-07	4.90E-07	4.80E-07	4.70E-07	4.60E-07	4.50E-07	4.50E-07	4.60E-07	4.30E-07	3.30E-07	
1249	4.80E-07	4.30E-07	4.00E-07	3.80E-07	3.60E-07	3.50E-07	3.40E-07	3.40E-07	3.30E-07	3.10E-07	1.10E-07	
1250	5.70E-07	5.20E-07	4.90E-07	4.70E-07	4.60E-07	4.50E-07	4.40E-07	4.40E-07	4.30E-07	4.10E-07	2.00E-07	
1251	5.50E-07	5.00E-07	4.70E-07	4.40E-07	4.20E-07	4.10E-07	3.90E-07	3.70E-07	3.70E-07	3.40E-07	5.00E-08	
1261	5.40E-07	4.90E-07	4.40E-07	4.10E-07	3.80E-07	3.60E-07	3.40E-07	3.20E-07	3.20E-07	2.70E-07	-9.00E-08	
1262	5.40E-07	4.80E-07	4.30E-07	3.90E-07	3.50E-07	3.20E-07	3.00E-07	2.70E-07	2.70E-07	2.10E-07	-1.80E-07	
1263	5.30E-07	4.70E-07	4.20E-07	3.80E-07	3.40E-07	3.10E-07	2.90E-07	2.70E-07	2.60E-07	2.10E-07	-1.70E-07	
1264	5.30E-07	5.30E-07	5.30E-07	5.30E-07	5.30E-07	5.30E-07	5.30E-07	5.30E-07	5.30E-07	5.30E-07	5.30E-07	
1265	5.20E-07	5.20E-07	5.20E-07	5.20E-07	5.20E-07	5.20E-07	5.20E-07	5.20E-07	5.20E-07	5.20E-07	5.20E-07	
Biased Statistics												
Average Biased	5.32E-07	4.87E-07	4.53E-07	4.29E-07	4.08E-07	3.93E-07	3.82E-07	3.71E-07	3.70E-07	3.38E-07	9.50E-08	
Std Dev Biased	2.94E-08	2.98E-08	3.30E-08	4.01E-08	4.96E-08	5.62E-08	6.18E-08	6.92E-08	7.30E-08	8.56E-08	1.86E-07	
Ps90%/90% (+KTL) Biased	5.93E-07	5.49E-07	5.21E-07	5.12E-07	5.10E-07	5.09E-07	5.10E-07	5.14E-07	5.21E-07	5.15E-07	4.80E-07	
Ps90%/90% (-KTL) Biased	4.71E-07	4.25E-07	3.85E-07	3.46E-07	3.06E-07	2.77E-07	2.54E-07	2.28E-07	2.19E-07	1.61E-07	-2.90E-07	
Specification MIN	-4.00E-06	-5.00E-06	-5.00E-06	-5.00E-06	-5.00E-06	-7.50E-06	-7.50E-06	-7.50E-06	-7.50E-06	-1.00E-05	-1.50E-05	
Status	PASS	PASS	PASS	PASS	PASS	PASS	PASS	PASS	PASS	PASS	PASS	
Specification MAX	4.00E-06	5.00E-06	5.00E-06	5.00E-06	5.00E-06	7.50E-06	7.50E-06	7.50E-06	7.50E-06	1.00E-05	1.50E-05	
Status	PASS	PASS	PASS	PASS	PASS	PASS	PASS	PASS	PASS	PASS	PASS	

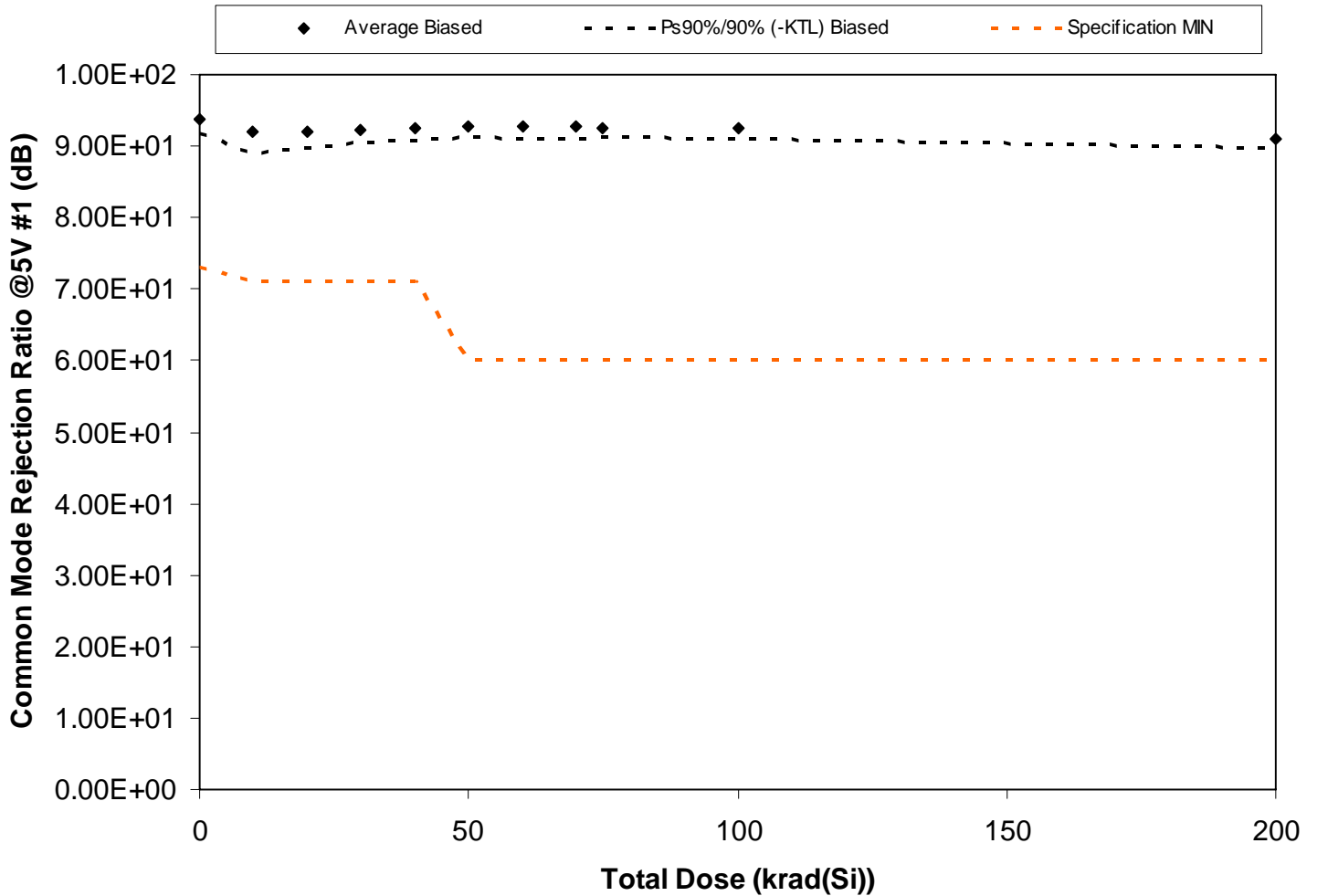

Figure 5.97. Plot of Common Mode Rejection Ratio @5V #1 (dB) versus total dose. The solid diamonds are the average of the measured data points for the samples irradiated under electrical bias and the black lines (solid and/or dashed) are the average of the data points after application of the KTL statistics on the samples irradiated under electrical bias. The red dotted line(s) are the pre- and/or post-irradiation minimum and/or maximum specification value as defined in the datasheet and/or test plan.



**RLAT Report
10-326 100808 R1.0**

**Radiation Assured Devices
5017 N. 30th Street
Colorado Springs, CO 80919
(719) 531-0800**

Table 5.97. Raw data for Common Mode Rejection Ratio @5V #1 (dB) versus total dose, including the statistical analysis, specification and the status of the testing (pass/fail).

Common Mode Rejection Ratio @5V #1 (dB)	Total Dose (krad(Si))											
	0	10	20	30	40	50	60	70	75	100	200	
Device												
1245	9.36E+01	9.12E+01	9.15E+01	9.19E+01	9.24E+01	9.27E+01	9.28E+01	9.28E+01	9.27E+01	9.28E+01	9.14E+01	
1246	9.54E+01	9.42E+01	9.39E+01	9.38E+01	9.40E+01	9.41E+01	9.42E+01	9.41E+01	9.40E+01	9.39E+01	9.21E+01	
1247	9.29E+01	9.00E+01	9.06E+01	9.12E+01	9.16E+01	9.20E+01	9.18E+01	9.19E+01	9.19E+01	9.19E+01	9.04E+01	
1248	9.44E+01	9.40E+01	9.39E+01	9.37E+01	9.37E+01	9.34E+01	9.32E+01	9.32E+01	9.30E+01	9.26E+01	9.15E+01	
1249	9.26E+01	9.17E+01	9.16E+01	9.17E+01	9.17E+01	9.17E+01	9.16E+01	9.16E+01	9.17E+01	9.14E+01	9.01E+01	
1250	9.42E+01	9.27E+01	9.28E+01	9.30E+01	9.32E+01	9.34E+01	9.34E+01	9.34E+01	9.32E+01	9.32E+01	9.17E+01	
1251	9.27E+01	9.07E+01	9.11E+01	9.15E+01	9.17E+01	9.19E+01	9.20E+01	9.20E+01	9.20E+01	9.19E+01	9.08E+01	
1261	9.36E+01	9.09E+01	9.16E+01	9.22E+01	9.25E+01	9.27E+01	9.26E+01	9.26E+01	9.25E+01	9.25E+01	9.08E+01	
1262	9.33E+01	9.13E+01	9.16E+01	9.21E+01	9.24E+01	9.25E+01	9.26E+01	9.25E+01	9.25E+01	9.24E+01	9.09E+01	
1263	9.39E+01	9.30E+01	9.27E+01	9.28E+01	9.29E+01	9.29E+01	9.29E+01	9.28E+01	9.27E+01	9.25E+01	9.08E+01	
1264	9.38E+01	9.38E+01	9.38E+01	9.38E+01	9.38E+01	9.37E+01	9.37E+01	9.38E+01	9.38E+01	9.38E+01	9.37E+01	
1265	9.23E+01	9.24E+01	9.23E+01	9.24E+01	9.24E+01	9.23E+01	9.22E+01	9.23E+01	9.24E+01	9.23E+01	9.23E+01	
Biased Statistics												
Average Biased	9.37E+01	9.20E+01	9.21E+01	9.24E+01	9.26E+01	9.27E+01	9.27E+01	9.27E+01	9.26E+01	9.25E+01	9.10E+01	
Std Dev Biased	8.68E-01	1.43E+00	1.14E+00	9.17E-01	8.38E-01	7.45E-01	7.72E-01	7.53E-01	6.98E-01	7.03E-01	6.05E-01	
Ps90%/90% (+KTL) Biased	9.54E+01	9.49E+01	9.45E+01	9.43E+01	9.43E+01	9.42E+01	9.43E+01	9.42E+01	9.41E+01	9.39E+01	9.23E+01	
Ps90%/90% (-KTL) Biased	9.19E+01	8.90E+01	8.98E+01	9.05E+01	9.09E+01	9.12E+01	9.11E+01	9.11E+01	9.12E+01	9.10E+01	8.98E+01	
Specification MIN	7.30E+01	7.10E+01	7.10E+01	7.10E+01	7.10E+01	6.00E+01	6.00E+01	6.00E+01	6.00E+01	6.00E+01	6.00E+01	
Status	PASS	PASS	PASS	PASS	PASS	PASS	PASS	PASS	PASS	PASS	PASS	

An ISO 9001:2008 and DSCC Certified Company

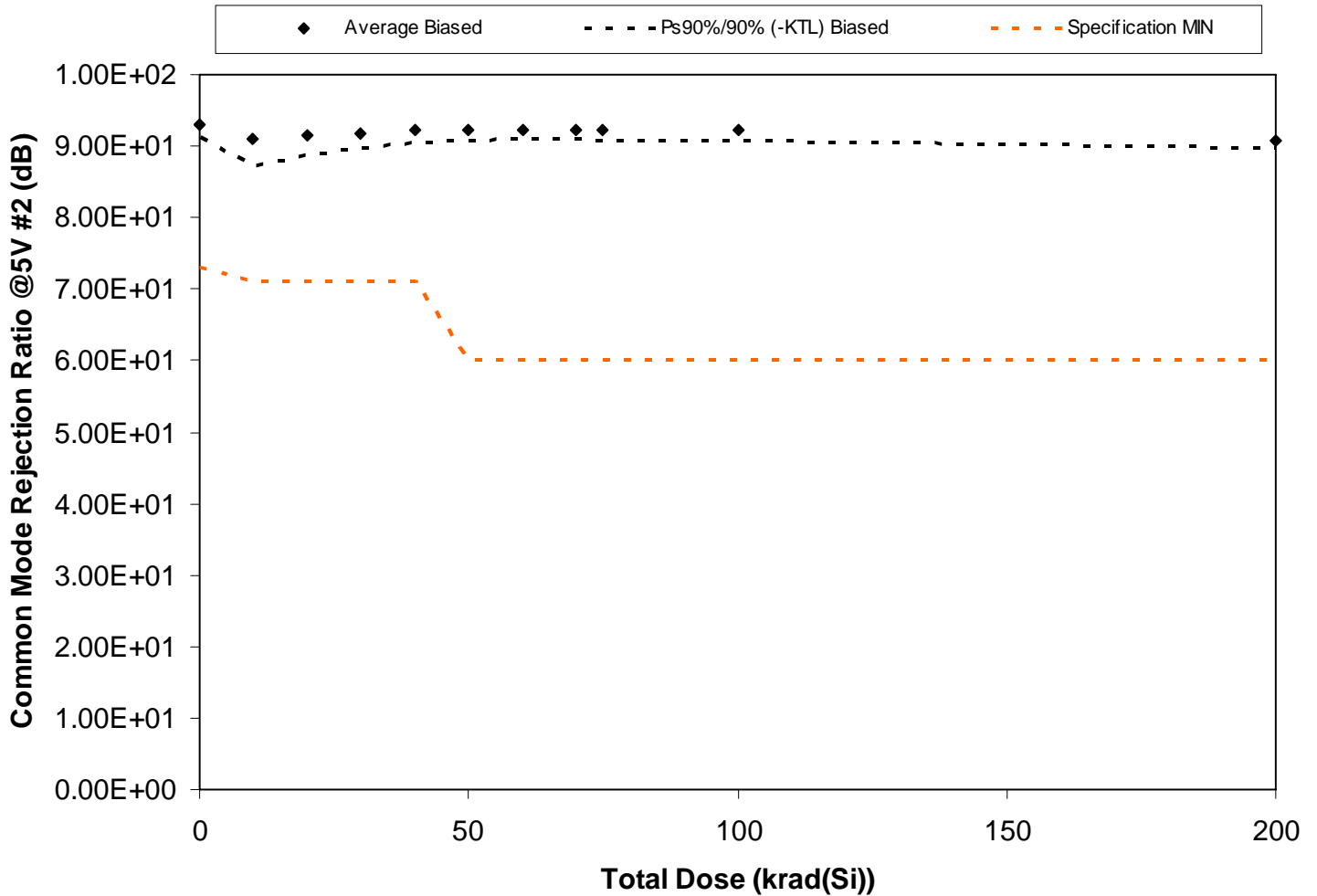

Figure 5.98. Plot of Common Mode Rejection Ratio @5V #2 (dB) versus total dose. The solid diamonds are the average of the measured data points for the samples irradiated under electrical bias and the black lines (solid and/or dashed) are the average of the data points after application of the KTL statistics on the samples irradiated under electrical bias. The red dotted line(s) are the pre- and/or post-irradiation minimum and/or maximum specification value as defined in the datasheet and/or test plan.



**RLAT Report
10-326 100808 R1.0**

**Radiation Assured Devices
5017 N. 30th Street
Colorado Springs, CO 80919
(719) 531-0800**

Table 5.98. Raw data for Common Mode Rejection Ratio @5V #2 (dB) versus total dose, including the statistical analysis, specification and the status of the testing (pass/fail).

Common Mode Rejection Ratio @5V #2 (dB)	Total Dose (krad(Si))											
	0	10	20	30	40	50	60	70	75	100	200	
Device												
1245	9.38E+01	9.25E+01	9.23E+01	9.23E+01	9.25E+01	9.27E+01	9.29E+01	9.28E+01	9.27E+01	9.29E+01	9.14E+01	
1246	9.20E+01	9.02E+01	9.03E+01	9.06E+01	9.10E+01	9.11E+01	9.12E+01	9.12E+01	9.12E+01	9.11E+01	8.98E+01	
1247	9.22E+01	8.87E+01	8.98E+01	9.07E+01	9.14E+01	9.18E+01	9.19E+01	9.19E+01	9.18E+01	9.19E+01	9.08E+01	
1248	9.41E+01	9.39E+01	9.38E+01	9.35E+01	9.35E+01	9.33E+01	9.30E+01	9.30E+01	9.29E+01	9.26E+01	9.12E+01	
1249	9.46E+01	9.30E+01	9.29E+01	9.32E+01	9.34E+01	9.34E+01	9.35E+01	9.35E+01	9.35E+01	9.34E+01	9.16E+01	
1250	9.26E+01	8.99E+01	9.06E+01	9.12E+01	9.16E+01	9.18E+01	9.18E+01	9.19E+01	9.17E+01	9.17E+01	9.04E+01	
1251	9.27E+01	9.12E+01	9.11E+01	9.15E+01	9.17E+01	9.19E+01	9.19E+01	9.18E+01	9.18E+01	9.17E+01	9.04E+01	
1261	9.36E+01	9.14E+01	9.16E+01	9.20E+01	9.23E+01	9.25E+01	9.26E+01	9.26E+01	9.25E+01	9.24E+01	9.09E+01	
1262	9.31E+01	9.13E+01	9.14E+01	9.18E+01	9.21E+01	9.22E+01	9.23E+01	9.22E+01	9.22E+01	9.21E+01	9.07E+01	
1263	9.24E+01	8.81E+01	9.02E+01	9.17E+01	9.24E+01	9.26E+01	9.27E+01	9.27E+01	9.27E+01	9.26E+01	9.14E+01	
1264	9.38E+01	9.38E+01	9.38E+01	9.37E+01	9.37E+01	9.38E+01	9.38E+01	9.37E+01	9.38E+01	9.37E+01	9.38E+01	
1265	9.30E+01	9.30E+01	9.30E+01	9.30E+01	9.31E+01	9.30E+01	9.30E+01	9.30E+01	9.31E+01	9.31E+01	9.31E+01	
Biased Statistics												
Average Biased	9.31E+01	9.10E+01	9.14E+01	9.18E+01	9.22E+01	9.23E+01	9.24E+01	9.24E+01	9.23E+01	9.22E+01	9.09E+01	
Std Dev Biased	8.76E-01	1.82E+00	1.27E+00	9.71E-01	8.16E-01	7.28E-01	6.94E-01	6.82E-01	6.85E-01	6.58E-01	5.61E-01	
Ps90%/90% (+KTL) Biased	9.49E+01	9.48E+01	9.40E+01	9.39E+01	9.39E+01	9.38E+01	9.38E+01	9.38E+01	9.37E+01	9.36E+01	9.20E+01	
Ps90%/90% (-KTL) Biased	9.13E+01	8.72E+01	8.88E+01	8.98E+01	9.05E+01	9.08E+01	9.09E+01	9.10E+01	9.09E+01	9.09E+01	8.97E+01	
Specification MIN	7.30E+01	7.10E+01	7.10E+01	7.10E+01	7.10E+01	6.00E+01	6.00E+01	6.00E+01	6.00E+01	6.00E+01	6.00E+01	
Status	PASS	PASS	PASS	PASS	PASS	PASS	PASS	PASS	PASS	PASS	PASS	

An ISO 9001:2008 and DSCC Certified Company

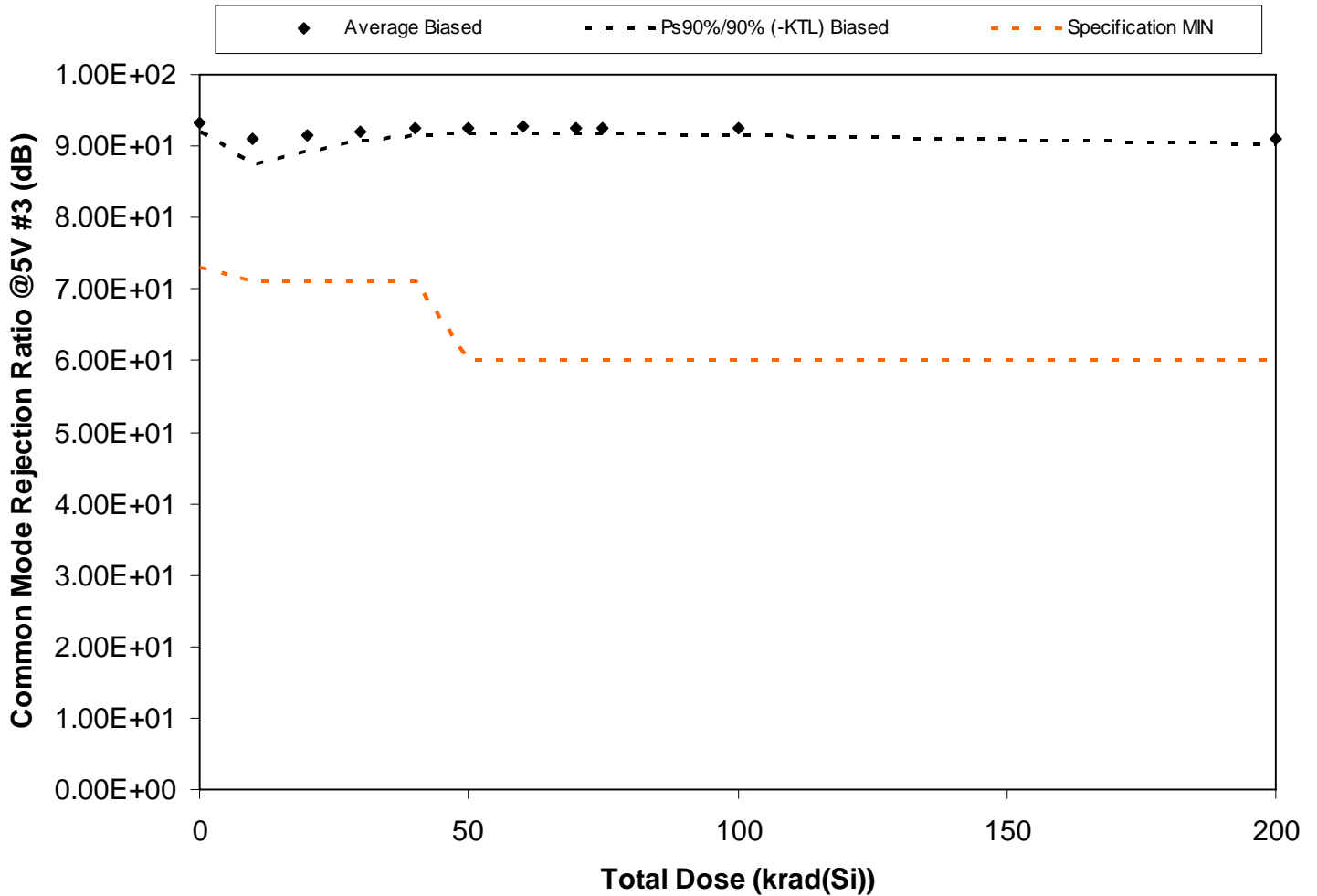

Figure 5.99. Plot of Common Mode Rejection Ratio @5V #3 (dB) versus total dose. The solid diamonds are the average of the measured data points for the samples irradiated under electrical bias and the black lines (solid and/or dashed) are the average of the data points after application of the KTL statistics on the samples irradiated under electrical bias. The red dotted line(s) are the pre- and/or post-irradiation minimum and/or maximum specification value as defined in the datasheet and/or test plan.



**RLAT Report
10-326 100808 R1.0**

**Radiation Assured Devices
5017 N. 30th Street
Colorado Springs, CO 80919
(719) 531-0800**

Table 5.99. Raw data for Common Mode Rejection Ratio @5V #3 (dB) versus total dose, including the statistical analysis, specification and the status of the testing (pass/fail).

Common Mode Rejection Ratio @5V #3 (dB)	Total Dose (krad(Si))											
	0	10	20	30	40	50	60	70	75	100	200	
Device												
1245	9.40E+01	9.23E+01	9.24E+01	9.26E+01	9.30E+01	9.31E+01	9.32E+01	9.32E+01	9.31E+01	9.31E+01	9.14E+01	
1246	9.31E+01	9.11E+01	9.14E+01	9.17E+01	9.20E+01	9.22E+01	9.22E+01	9.22E+01	9.21E+01	9.20E+01	9.06E+01	
1247	9.33E+01	9.16E+01	9.18E+01	9.21E+01	9.23E+01	9.25E+01	9.25E+01	9.23E+01	9.23E+01	9.21E+01	9.06E+01	
1248	9.34E+01	9.32E+01	9.31E+01	9.31E+01	9.28E+01	9.28E+01	9.27E+01	9.24E+01	9.24E+01	9.21E+01	9.09E+01	
1249	9.36E+01	9.25E+01	9.24E+01	9.25E+01	9.26E+01	9.26E+01	9.26E+01	9.25E+01	9.24E+01	9.23E+01	9.10E+01	
1250	9.22E+01	8.86E+01	9.04E+01	9.18E+01	9.25E+01	9.29E+01	9.30E+01	9.30E+01	9.30E+01	9.30E+01	9.13E+01	
1251	9.42E+01	9.19E+01	9.21E+01	9.26E+01	9.29E+01	9.31E+01	9.33E+01	9.31E+01	9.31E+01	9.30E+01	9.15E+01	
1261	9.23E+01	8.86E+01	8.98E+01	9.10E+01	9.17E+01	9.19E+01	9.22E+01	9.22E+01	9.22E+01	9.22E+01	9.08E+01	
1262	9.32E+01	8.97E+01	9.08E+01	9.18E+01	9.24E+01	9.26E+01	9.27E+01	9.28E+01	9.28E+01	9.28E+01	9.14E+01	
1263	9.30E+01	8.99E+01	9.10E+01	9.18E+01	9.21E+01	9.22E+01	9.24E+01	9.22E+01	9.22E+01	9.23E+01	9.09E+01	
1264	9.34E+01	9.33E+01	9.34E+01	9.34E+01	9.34E+01	9.35E+01	9.33E+01	9.34E+01	9.34E+01	9.35E+01	9.33E+01	
1265	9.48E+01	9.48E+01	9.48E+01	9.48E+01	9.47E+01	9.48E+01	9.48E+01	9.48E+01	9.47E+01	9.48E+01	9.48E+01	
Biased Statistics												
Average Biased	9.32E+01	9.09E+01	9.15E+01	9.21E+01	9.24E+01	9.26E+01	9.27E+01	9.26E+01	9.26E+01	9.25E+01	9.10E+01	
Std Dev Biased	6.38E-01	1.64E+00	1.03E+00	6.05E-01	4.37E-01	3.96E-01	3.87E-01	4.08E-01	4.01E-01	4.42E-01	3.58E-01	
Ps90%/90% (+KTL) Biased	9.45E+01	9.43E+01	9.36E+01	9.33E+01	9.33E+01	9.34E+01	9.35E+01	9.34E+01	9.34E+01	9.34E+01	9.18E+01	
Ps90%/90% (-KTL) Biased	9.19E+01	8.76E+01	8.94E+01	9.08E+01	9.15E+01	9.18E+01	9.19E+01	9.18E+01	9.17E+01	9.16E+01	9.03E+01	
Specification MIN	7.30E+01	7.10E+01	7.10E+01	7.10E+01	7.10E+01	6.00E+01	6.00E+01	6.00E+01	6.00E+01	6.00E+01	6.00E+01	
Status	PASS	PASS	PASS	PASS	PASS	PASS	PASS	PASS	PASS	PASS	PASS	

An ISO 9001:2008 and DSCC Certified Company

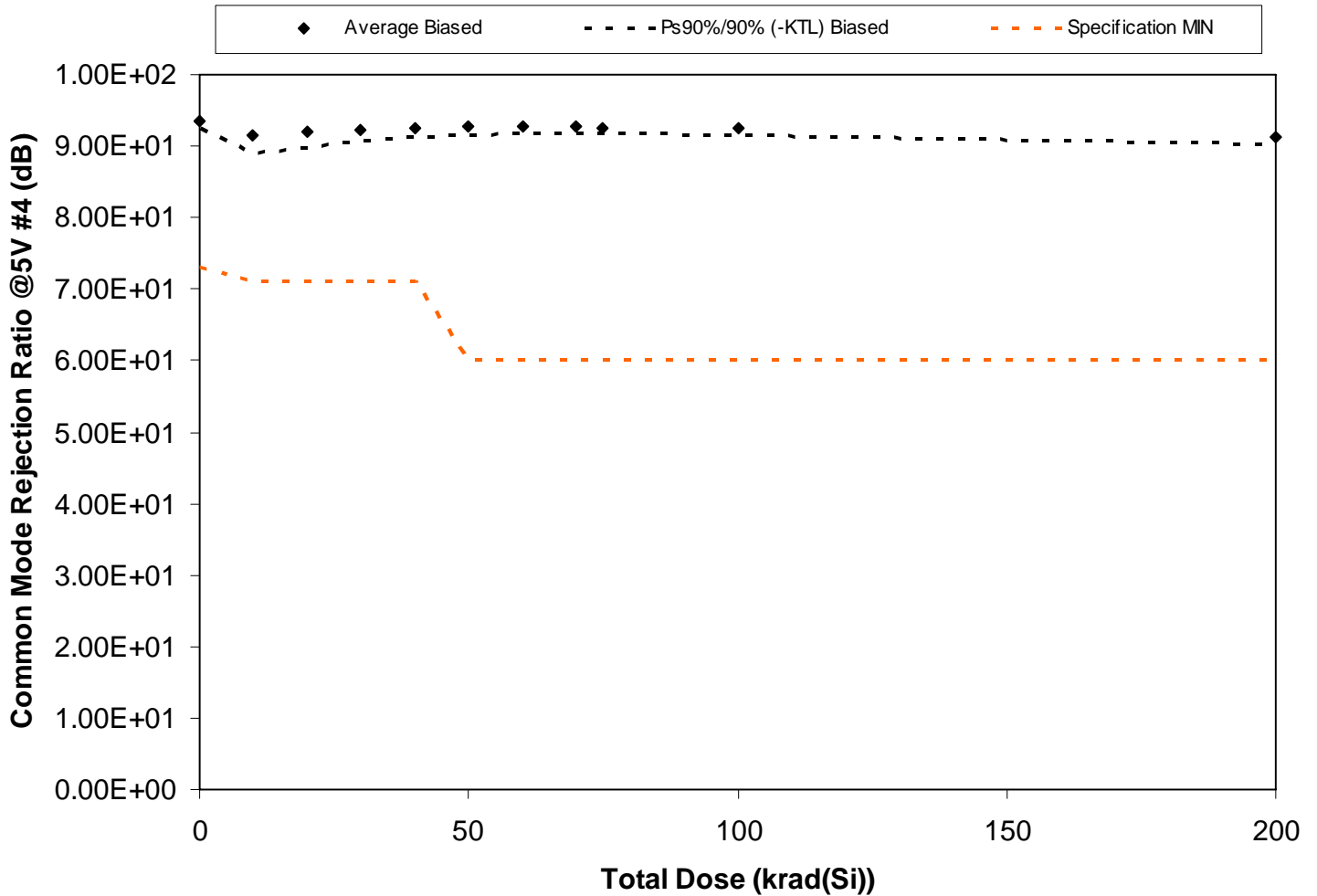

Figure 5.100. Plot of Common Mode Rejection Ratio @5V #4 (dB) versus total dose. The solid diamonds are the average of the measured data points for the samples irradiated under electrical bias and the black lines (solid and/or dashed) are the average of the data points after application of the KTL statistics on the samples irradiated under electrical bias. The red dotted line(s) are the pre- and/or post-irradiation minimum and/or maximum specification value as defined in the datasheet and/or test plan.



**RLAT Report
10-326 100808 R1.0**

**Radiation Assured Devices
5017 N. 30th Street
Colorado Springs, CO 80919
(719) 531-0800**

Table 5.100. Raw data for Common Mode Rejection Ratio @5V #4 (dB) versus total dose, including the statistical analysis, specification and the status of the testing (pass/fail).

Common Mode Rejection Ratio @5V #4 (dB)	Total Dose (krad(Si))											
	0	10	20	30	40	50	60	70	75	100	200	
Device												
1245	9.28E+01	9.01E+01	9.07E+01	9.13E+01	9.19E+01	9.22E+01	9.23E+01	9.22E+01	9.22E+01	9.23E+01	9.10E+01	
1246	9.36E+01	9.16E+01	9.17E+01	9.20E+01	9.25E+01	9.27E+01	9.28E+01	9.28E+01	9.27E+01	9.27E+01	9.13E+01	
1247	9.38E+01	8.96E+01	9.08E+01	9.17E+01	9.25E+01	9.31E+01	9.31E+01	9.31E+01	9.31E+01	9.32E+01	9.16E+01	
1248	9.45E+01	9.44E+01	9.42E+01	9.41E+01	9.40E+01	9.39E+01	9.37E+01	9.34E+01	9.33E+01	9.32E+01	9.19E+01	
1249	9.32E+01	9.18E+01	9.20E+01	9.23E+01	9.24E+01	9.24E+01	9.24E+01	9.23E+01	9.23E+01	9.23E+01	9.09E+01	
1250	9.30E+01	9.13E+01	9.15E+01	9.19E+01	9.19E+01	9.21E+01	9.21E+01	9.21E+01	9.21E+01	9.19E+01	9.04E+01	
1251	9.38E+01	9.28E+01	9.26E+01	9.27E+01	9.29E+01	9.29E+01	9.30E+01	9.30E+01	9.31E+01	9.30E+01	9.14E+01	
1261	9.35E+01	9.14E+01	9.17E+01	9.22E+01	9.25E+01	9.26E+01	9.27E+01	9.27E+01	9.26E+01	9.26E+01	9.11E+01	
1262	9.40E+01	9.15E+01	9.20E+01	9.27E+01	9.29E+01	9.30E+01	9.31E+01	9.32E+01	9.29E+01	9.28E+01	9.13E+01	
1263	9.32E+01	9.20E+01	9.20E+01	9.21E+01	9.23E+01	9.23E+01	9.23E+01	9.23E+01	9.21E+01	9.19E+01	9.05E+01	
1264	9.45E+01	9.45E+01	9.45E+01	9.44E+01	9.45E+01	9.45E+01	9.45E+01	9.46E+01	9.45E+01	9.45E+01	9.44E+01	
1265	9.38E+01	9.39E+01	9.39E+01	9.39E+01	9.39E+01	9.38E+01	9.38E+01	9.39E+01	9.39E+01	9.39E+01	9.39E+01	
Biased Statistics												
Average Biased	9.35E+01	9.16E+01	9.19E+01	9.23E+01	9.26E+01	9.27E+01	9.28E+01	9.27E+01	9.26E+01	9.26E+01	9.12E+01	
Std Dev Biased	5.27E-01	1.33E+00	9.91E-01	7.54E-01	5.99E-01	5.44E-01	4.95E-01	4.73E-01	4.55E-01	4.71E-01	4.60E-01	
Ps90%/90% (+KTL) Biased	9.46E+01	9.44E+01	9.40E+01	9.38E+01	9.38E+01	9.38E+01	9.38E+01	9.37E+01	9.36E+01	9.36E+01	9.21E+01	
Ps90%/90% (-KTL) Biased	9.25E+01	8.89E+01	8.99E+01	9.07E+01	9.13E+01	9.16E+01	9.17E+01	9.17E+01	9.17E+01	9.16E+01	9.02E+01	
Specification MIN	7.30E+01	7.10E+01	7.10E+01	7.10E+01	7.10E+01	6.00E+01	6.00E+01	6.00E+01	6.00E+01	6.00E+01	6.00E+01	
Status	PASS	PASS	PASS	PASS	PASS	PASS	PASS	PASS	PASS	PASS	PASS	

An ISO 9001:2008 and DSCC Certified Company

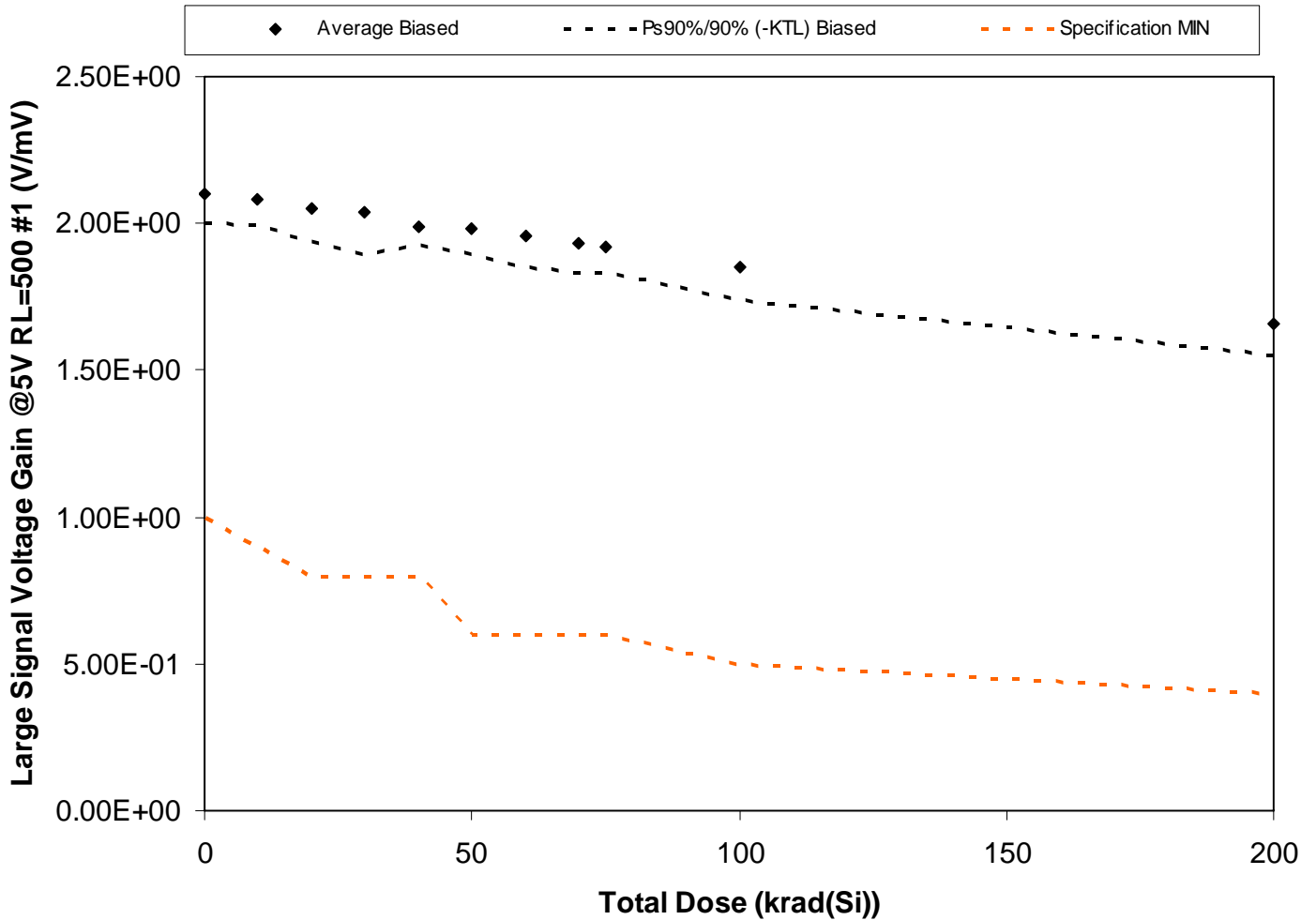

Figure 5.101. Plot of Large Signal Voltage Gain @5V RL=500 #1 (V/mV) versus total dose. The solid diamonds are the average of the measured data points for the samples irradiated under electrical bias and the black lines (solid and/or dashed) are the average of the data points after application of the KTL statistics on the samples irradiated under electrical bias. The red dotted line(s) are the pre- and/or post-irradiation minimum and/or maximum specification value as defined in the datasheet and/or test plan.



**RLAT Report
10-326 100808 R1.0**

**Radiation Assured Devices
5017 N. 30th Street
Colorado Springs, CO 80919
(719) 531-0800**

Table 5.101. Raw data for Large Signal Voltage Gain @5V RL=500 #1 (V/mV) versus total dose, including the statistical analysis, specification and the status of the testing (pass/fail).

Large Signal Voltage Gain @5V RL=500 #1 (V/mV)	Total Dose (krad(Si))											
	0	10	20	30	40	50	60	70	75	100	200	
Device												
1245	2.10E+00	2.10E+00	2.10E+00	2.10E+00	2.00E+00	2.00E+00	2.00E+00	2.00E+00	2.00E+00	1.90E+00	1.70E+00	
1246	2.10E+00	2.00E+00	2.00E+00	2.00E+00	2.00E+00	1.90E+00	1.90E+00	1.90E+00	1.90E+00	1.80E+00	1.60E+00	
1247	2.00E+00	2.00E+00	2.00E+00	1.90E+00	1.90E+00	1.90E+00	1.90E+00	1.90E+00	1.90E+00	1.80E+00	1.60E+00	
1248	2.10E+00	2.10E+00	2.10E+00	2.10E+00	2.00E+00	2.00E+00	2.00E+00	1.90E+00	1.90E+00	1.90E+00	1.70E+00	
1249	2.10E+00	2.10E+00	2.10E+00	2.10E+00	2.00E+00	2.00E+00	2.00E+00	2.00E+00	2.00E+00	1.90E+00	1.70E+00	
1250	2.10E+00	2.10E+00	2.00E+00	2.00E+00	2.00E+00	2.00E+00	2.00E+00	1.90E+00	1.90E+00	1.80E+00	1.70E+00	
1251	2.10E+00	2.10E+00	2.10E+00	2.10E+00	2.00E+00	2.00E+00	2.00E+00	2.00E+00	1.90E+00	1.90E+00	1.70E+00	
1261	2.10E+00	2.10E+00	2.00E+00	2.00E+00	2.00E+00	2.00E+00	1.90E+00	1.90E+00	1.90E+00	1.80E+00	1.60E+00	
1262	2.10E+00	2.10E+00	2.00E+00	2.00E+00	2.00E+00	2.00E+00	1.90E+00	1.90E+00	1.90E+00	1.80E+00	1.60E+00	
1263	2.20E+00	2.10E+00	2.10E+00	2.10E+00	2.00E+00	2.00E+00	2.00E+00	1.90E+00	1.90E+00	1.90E+00	1.70E+00	
1264	2.20E+00	2.20E+00	2.20E+00	2.20E+00	2.20E+00	2.20E+00	2.20E+00	2.20E+00	2.20E+00	2.20E+00	2.20E+00	
1265	2.00E+00	2.00E+00	2.00E+00	2.00E+00	2.00E+00	2.00E+00	2.00E+00	2.00E+00	2.00E+00	2.00E+00	2.00E+00	
Biased Statistics												
Average Biased	2.10E+00	2.08E+00	2.05E+00	2.04E+00	1.99E+00	1.98E+00	1.96E+00	1.93E+00	1.92E+00	1.85E+00	1.66E+00	
Std Dev Biased	4.71E-02	4.22E-02	5.27E-02	6.99E-02	3.16E-02	4.22E-02	5.16E-02	4.83E-02	4.22E-02	5.27E-02	5.16E-02	
Ps90%/90% (+KTL) Biased	2.20E+00	2.17E+00	2.16E+00	2.18E+00	2.06E+00	2.07E+00	2.07E+00	2.03E+00	2.01E+00	1.96E+00	1.77E+00	
Ps90%/90% (-KTL) Biased	2.00E+00	1.99E+00	1.94E+00	1.90E+00	1.92E+00	1.89E+00	1.85E+00	1.83E+00	1.83E+00	1.74E+00	1.55E+00	
Specification MIN	1.00E+00	9.00E-01	8.00E-01	8.00E-01	8.00E-01	6.00E-01	6.00E-01	6.00E-01	6.00E-01	5.00E-01	4.00E-01	
Status	PASS	PASS	PASS	PASS	PASS	PASS	PASS	PASS	PASS	PASS	PASS	

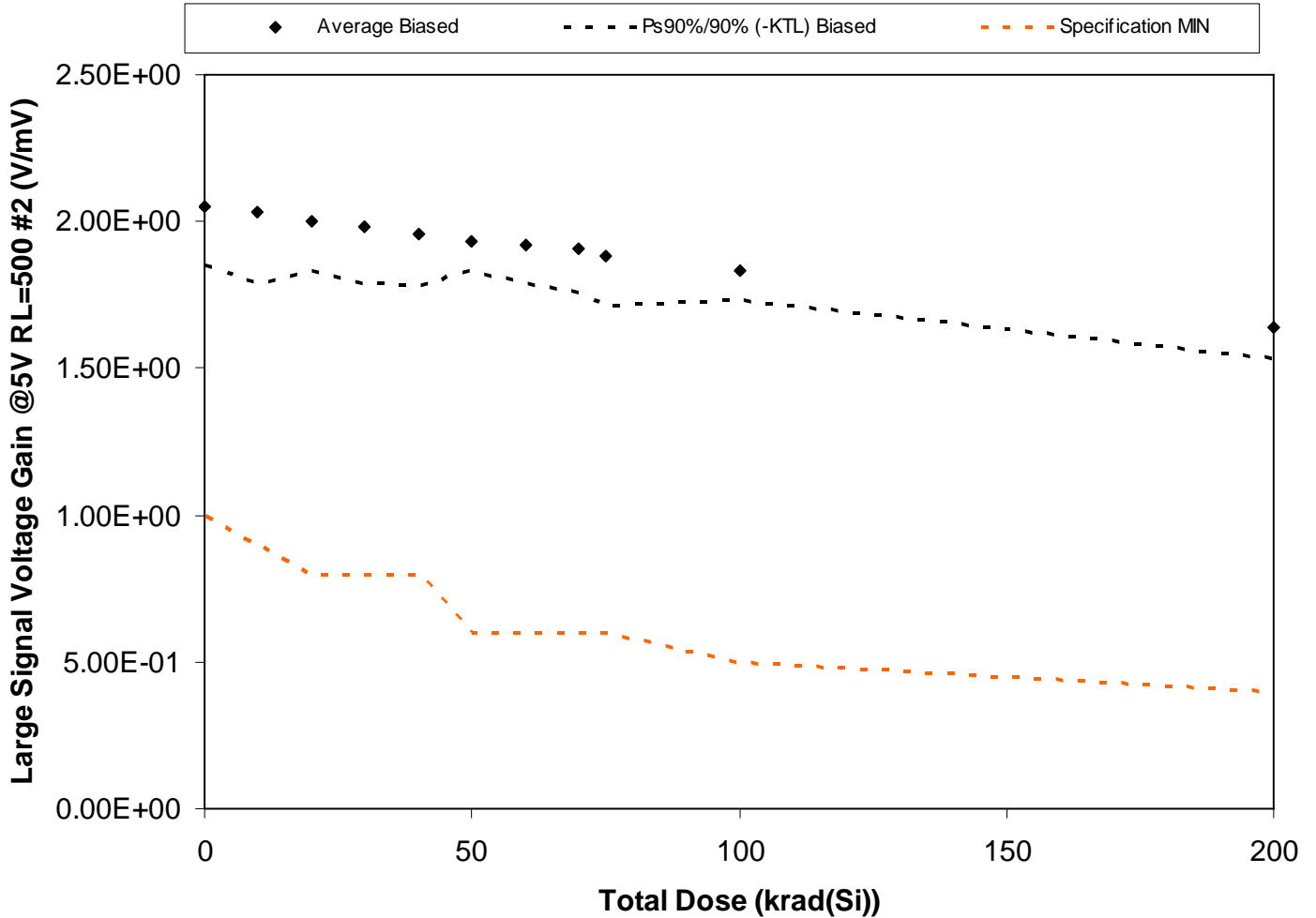

Figure 5.102. Plot of Large Signal Voltage Gain @5V RL=500 #2 (V/mV) versus total dose. The solid diamonds are the average of the measured data points for the samples irradiated under electrical bias and the black lines (solid and/or dashed) are the average of the data points after application of the KTL statistics on the samples irradiated under electrical bias. The red dotted line(s) are the pre- and/or post-irradiation minimum and/or maximum specification value as defined in the datasheet and/or test plan.



**RLAT Report
10-326 100808 R1.0**

**Radiation Assured Devices
5017 N. 30th Street
Colorado Springs, CO 80919
(719) 531-0800**

Table 5.102. Raw data for Large Signal Voltage Gain @5V RL=500 #2 (V/mV) versus total dose, including the statistical analysis, specification and the status of the testing (pass/fail).

Large Signal Voltage Gain @5V RL=500 #2 (V/mV)	Total Dose (krad(Si))											
	0	10	20	30	40	50	60	70	75	100	200	
Device												
1245	2.10E+00	2.10E+00	2.10E+00	2.10E+00	2.00E+00	2.00E+00	2.00E+00	2.00E+00	1.90E+00	1.90E+00	1.70E+00	
1246	2.00E+00	1.90E+00	1.90E+00	1.90E+00	1.90E+00	1.90E+00	1.90E+00	1.90E+00	1.80E+00	1.80E+00	1.60E+00	
1247	2.10E+00	2.10E+00	2.00E+00	2.00E+00	2.00E+00	1.90E+00	1.90E+00	1.90E+00	1.90E+00	1.80E+00	1.70E+00	
1248	2.20E+00	2.20E+00	2.10E+00	2.10E+00	2.10E+00	2.00E+00	2.00E+00	2.00E+00	2.00E+00	1.90E+00	1.70E+00	
1249	2.20E+00	2.20E+00	2.10E+00	2.10E+00	2.10E+00	2.00E+00	2.00E+00	2.00E+00	2.00E+00	1.90E+00	1.70E+00	
1250	2.00E+00	2.00E+00	2.00E+00	2.00E+00	1.90E+00	1.90E+00	1.90E+00	1.90E+00	1.90E+00	1.80E+00	1.60E+00	
1251	2.00E+00	2.00E+00	2.00E+00	1.90E+00	1.90E+00	1.90E+00	1.90E+00	1.90E+00	1.80E+00	1.80E+00	1.60E+00	
1261	2.00E+00	1.90E+00	1.90E+00	1.90E+00	1.90E+00	1.90E+00	1.80E+00	1.80E+00	1.80E+00	1.80E+00	1.60E+00	
1262	1.90E+00	1.90E+00	1.90E+00	1.90E+00	1.90E+00	1.90E+00	1.90E+00	1.90E+00	1.90E+00	1.80E+00	1.60E+00	
1263	2.00E+00	2.00E+00	2.00E+00	1.90E+00	1.90E+00	1.90E+00	1.90E+00	1.80E+00	1.80E+00	1.80E+00	1.60E+00	
1264	2.20E+00	2.10E+00	2.10E+00	2.10E+00	2.10E+00	2.10E+00	2.20E+00	2.10E+00	2.10E+00	2.20E+00	2.10E+00	
1265	2.10E+00	2.10E+00	2.10E+00	2.10E+00	2.10E+00	2.10E+00	2.10E+00	2.10E+00	2.10E+00	2.10E+00	2.10E+00	
Biased Statistics												
Average Biased	2.05E+00	2.03E+00	2.00E+00	1.98E+00	1.96E+00	1.93E+00	1.92E+00	1.91E+00	1.88E+00	1.83E+00	1.64E+00	
Std Dev Biased	9.72E-02	1.16E-01	8.16E-02	9.19E-02	8.43E-02	4.83E-02	6.32E-02	7.38E-02	7.89E-02	4.83E-02	5.16E-02	
Ps90%/90% (+KTL) Biased	2.25E+00	2.27E+00	2.17E+00	2.17E+00	2.13E+00	2.03E+00	2.05E+00	2.06E+00	2.04E+00	1.93E+00	1.75E+00	
Ps90%/90% (-KTL) Biased	1.85E+00	1.79E+00	1.83E+00	1.79E+00	1.79E+00	1.83E+00	1.79E+00	1.76E+00	1.72E+00	1.73E+00	1.53E+00	
Specification MIN	1.00E+00	9.00E-01	8.00E-01	8.00E-01	8.00E-01	6.00E-01	6.00E-01	6.00E-01	6.00E-01	5.00E-01	4.00E-01	
Status	PASS	PASS	PASS	PASS	PASS	PASS	PASS	PASS	PASS	PASS	PASS	

An ISO 9001:2008 and DSCC Certified Company

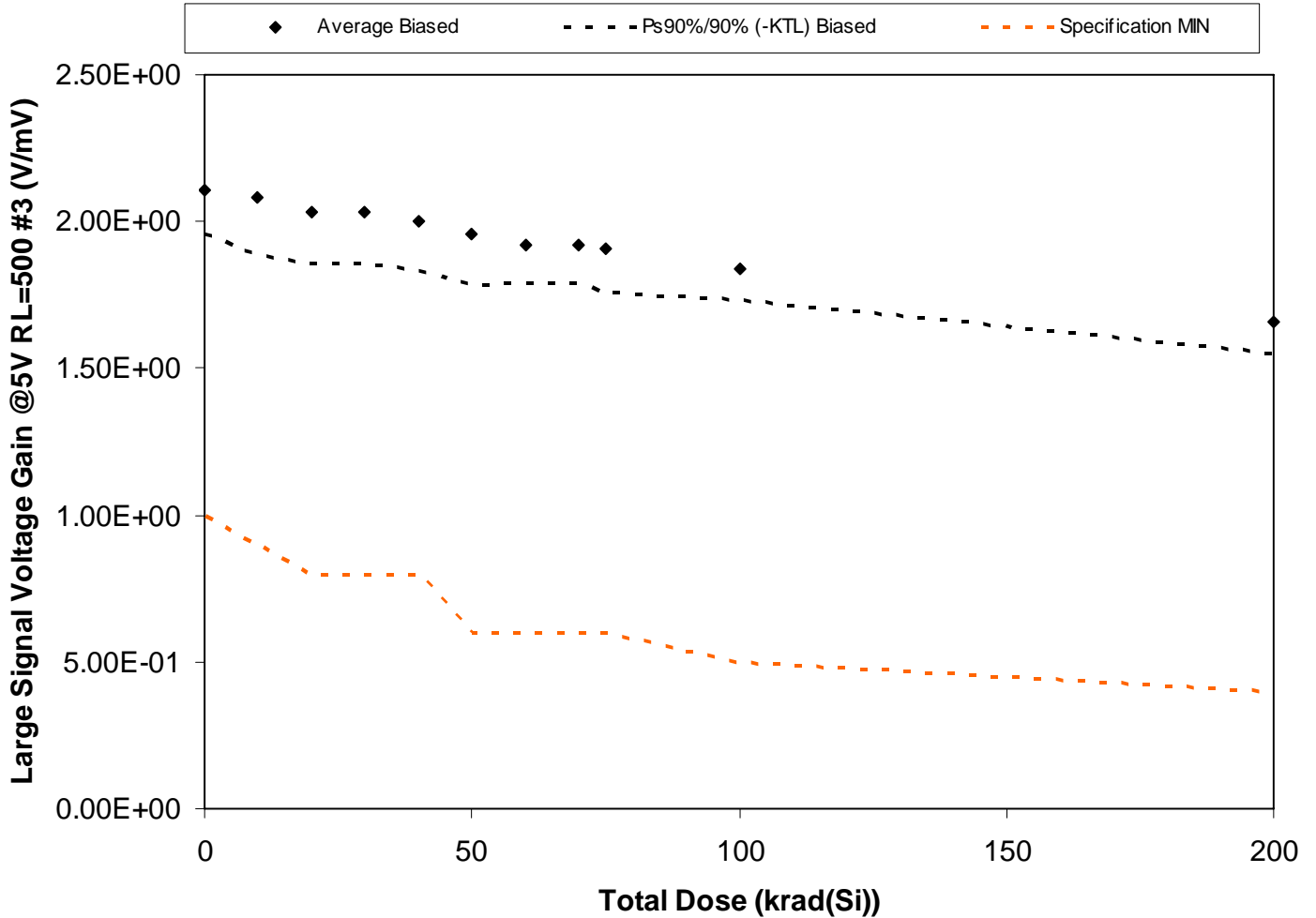

Figure 5.103. Plot of Large Signal Voltage Gain @5V RL=500 #3 (V/mV) versus total dose. The solid diamonds are the average of the measured data points for the samples irradiated under electrical bias and the black lines (solid and/or dashed) are the average of the data points after application of the KTL statistics on the samples irradiated under electrical bias. The red dotted line(s) are the pre- and/or post-irradiation minimum and/or maximum specification value as defined in the datasheet and/or test plan.



**RLAT Report
10-326 100808 R1.0**

**Radiation Assured Devices
5017 N. 30th Street
Colorado Springs, CO 80919
(719) 531-0800**

Table 5.103. Raw data for Large Signal Voltage Gain @5V RL=500 #3 (V/mV) versus total dose, including the statistical analysis, specification and the status of the testing (pass/fail).

Large Signal Voltage Gain @5V RL=500 #3 (V/mV)	Total Dose (krad(Si))											
	0	10	20	30	40	50	60	70	75	100	200	
Device												
1245	2.20E+00	2.10E+00	2.10E+00	2.10E+00	2.10E+00	2.00E+00	2.00E+00	2.00E+00	2.00E+00	1.90E+00	1.70E+00	
1246	2.00E+00	2.00E+00	2.00E+00	2.00E+00	1.90E+00	1.90E+00	1.90E+00	1.90E+00	1.80E+00	1.80E+00	1.60E+00	
1247	2.10E+00	2.10E+00	2.00E+00	2.00E+00	2.00E+00	2.00E+00	1.90E+00	1.90E+00	1.90E+00	1.80E+00	1.60E+00	
1248	2.20E+00	2.20E+00	2.20E+00	2.20E+00	2.10E+00	2.10E+00	2.00E+00	2.00E+00	2.00E+00	1.90E+00	1.70E+00	
1249	2.20E+00	2.20E+00	2.10E+00	2.10E+00	2.10E+00	2.00E+00	2.00E+00	2.00E+00	2.00E+00	1.90E+00	1.70E+00	
1250	2.10E+00	2.10E+00	2.00E+00	2.00E+00	2.00E+00	2.00E+00	1.90E+00	1.90E+00	1.90E+00	1.80E+00	1.70E+00	
1251	2.10E+00	2.10E+00	2.00E+00	2.00E+00	2.00E+00	1.90E+00	1.90E+00	1.90E+00	1.90E+00	1.80E+00	1.70E+00	
1261	2.00E+00	1.90E+00	1.90E+00	1.90E+00	1.90E+00	1.80E+00	1.80E+00	1.80E+00	1.80E+00	1.80E+00	1.60E+00	
1262	2.10E+00	2.10E+00	2.00E+00	2.00E+00	2.00E+00	2.00E+00	1.90E+00	1.90E+00	1.90E+00	1.90E+00	1.70E+00	
1263	2.10E+00	2.00E+00	2.00E+00	2.00E+00	1.90E+00	1.90E+00	1.90E+00	1.90E+00	1.90E+00	1.80E+00	1.60E+00	
1264	2.10E+00	2.10E+00	2.10E+00	2.10E+00	2.10E+00	2.10E+00	2.10E+00	2.10E+00	2.10E+00	2.10E+00	2.10E+00	
1265	2.10E+00	2.10E+00	2.10E+00	2.10E+00	2.10E+00	2.10E+00	2.10E+00	2.10E+00	2.10E+00	2.10E+00	2.10E+00	
Biased Statistics												
Average Biased	2.11E+00	2.08E+00	2.03E+00	2.03E+00	2.00E+00	1.96E+00	1.92E+00	1.92E+00	1.91E+00	1.84E+00	1.66E+00	
Std Dev Biased	7.38E-02	9.19E-02	8.23E-02	8.23E-02	8.16E-02	8.43E-02	6.32E-02	6.32E-02	7.38E-02	5.16E-02	5.16E-02	
Ps90%/90% (+KTL) Biased	2.26E+00	2.27E+00	2.20E+00	2.20E+00	2.17E+00	2.13E+00	2.05E+00	2.05E+00	2.06E+00	1.95E+00	1.77E+00	
Ps90%/90% (-KTL) Biased	1.96E+00	1.89E+00	1.86E+00	1.86E+00	1.83E+00	1.79E+00	1.79E+00	1.79E+00	1.76E+00	1.73E+00	1.55E+00	
Specification MIN	1.00E+00	9.00E-01	8.00E-01	8.00E-01	8.00E-01	6.00E-01	6.00E-01	6.00E-01	6.00E-01	5.00E-01	4.00E-01	
Status	PASS	PASS	PASS	PASS	PASS	PASS	PASS	PASS	PASS	PASS	PASS	

An ISO 9001:2008 and DSCC Certified Company

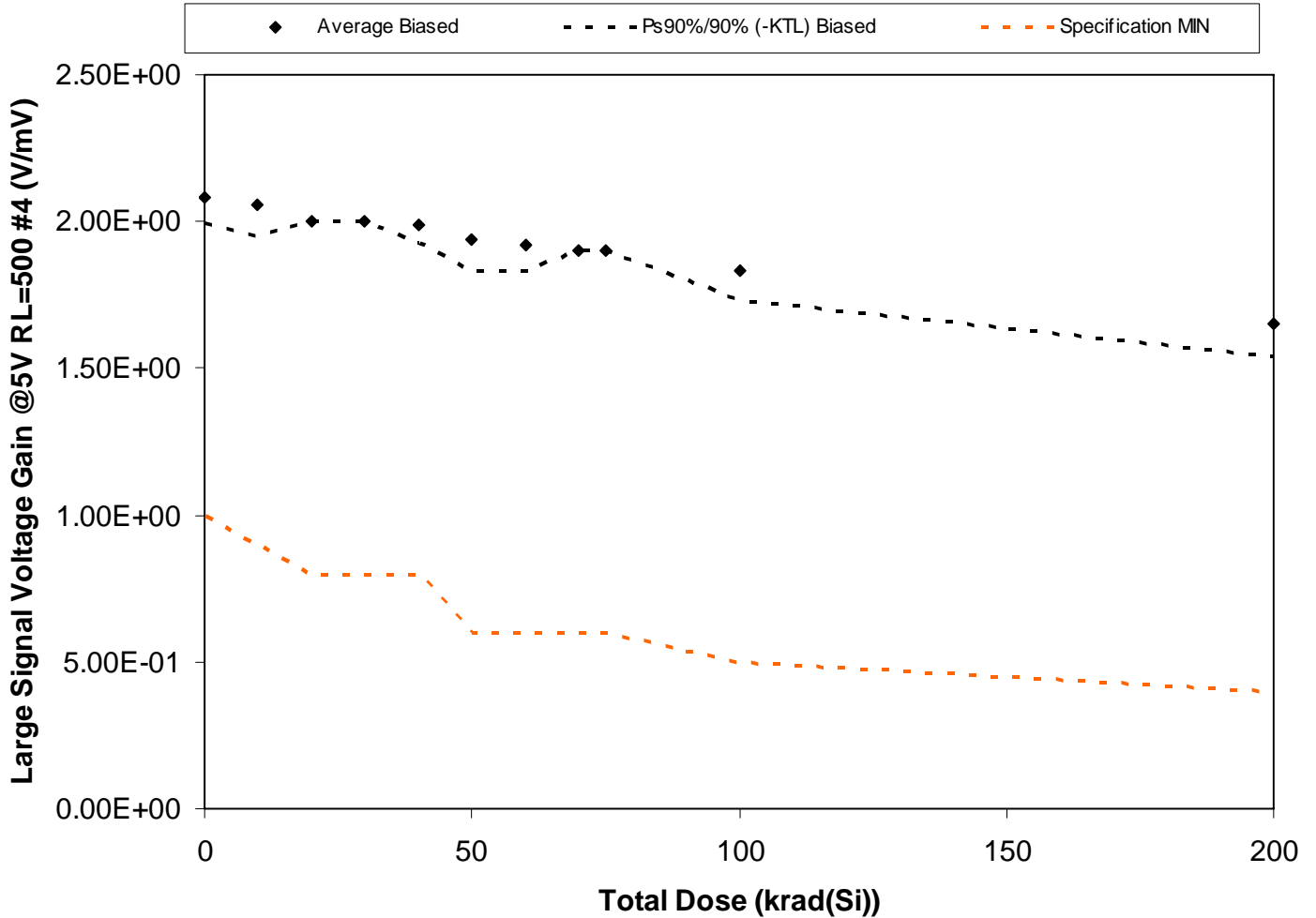

Figure 5.104. Plot of Large Signal Voltage Gain @5V RL=500 #4 (V/mV) versus total dose. The solid diamonds are the average of the measured data points for the samples irradiated under electrical bias and the black lines (solid and/or dashed) are the average of the data points after application of the KTL statistics on the samples irradiated under electrical bias. The red dotted line(s) are the pre- and/or post-irradiation minimum and/or maximum specification value as defined in the datasheet and/or test plan.



**RLAT Report
10-326 100808 R1.0**

**Radiation Assured Devices
5017 N. 30th Street
Colorado Springs, CO 80919
(719) 531-0800**

Table 5.104. Raw data for Large Signal Voltage Gain @5V RL=500 #4 (V/mV) versus total dose, including the statistical analysis, specification and the status of the testing (pass/fail).

Large Signal Voltage Gain @5V RL=500 #4 (V/mV)	Total Dose (krad(Si))											
	0	10	20	30	40	50	60	70	75	100	200	
Device												
1245	2.10E+00	2.10E+00	2.00E+00	2.00E+00	2.00E+00	2.00E+00	1.90E+00	1.90E+00	1.90E+00	1.80E+00	1.70E+00	
1246	2.10E+00	2.00E+00	2.00E+00	2.00E+00	2.00E+00	1.90E+00	1.90E+00	1.90E+00	1.90E+00	1.80E+00	1.60E+00	
1247	2.10E+00	2.10E+00	2.00E+00	2.00E+00	2.00E+00	2.00E+00	2.00E+00	1.90E+00	1.90E+00	1.90E+00	1.70E+00	
1248	2.00E+00	2.00E+00	2.00E+00	2.00E+00	2.00E+00	1.90E+00	1.90E+00	1.90E+00	1.90E+00	1.80E+00	1.60E+00	
1249	2.00E+00	2.00E+00	2.00E+00	2.00E+00	2.00E+00	1.90E+00	1.90E+00	1.90E+00	1.90E+00	1.80E+00	1.70E+00	
1250	2.10E+00	2.10E+00	2.00E+00	2.00E+00	2.00E+00	2.00E+00	1.90E+00	1.90E+00	1.90E+00	1.90E+00	1.70E+00	
1251	2.10E+00	2.10E+00	2.00E+00	2.00E+00	2.00E+00	2.00E+00	2.00E+00	1.90E+00	1.90E+00	1.90E+00	1.70E+00	
1261	2.10E+00	2.10E+00	2.00E+00	2.00E+00	2.00E+00	1.90E+00	1.90E+00	1.90E+00	1.90E+00	1.80E+00	1.60E+00	
1262	2.10E+00	2.00E+00	2.00E+00	2.00E+00	1.90E+00	1.90E+00	1.90E+00	1.90E+00	1.90E+00	1.80E+00	1.60E+00	
1263	2.10E+00	2.10E+00	2.00E+00	2.00E+00	2.00E+00	1.90E+00	1.90E+00	1.90E+00	1.90E+00	1.80E+00	1.60E+00	
1264	2.10E+00	2.10E+00	2.10E+00	2.10E+00	2.10E+00	2.10E+00	2.10E+00	2.10E+00	2.10E+00	2.10E+00	2.10E+00	
1265	2.00E+00	2.00E+00	2.00E+00	2.00E+00	2.00E+00	2.00E+00	2.00E+00	2.00E+00	2.00E+00	2.00E+00	2.00E+00	
Biased Statistics												
Average Biased	2.08E+00	2.06E+00	2.00E+00	2.00E+00	1.99E+00	1.94E+00	1.92E+00	1.90E+00	1.90E+00	1.83E+00	1.65E+00	
Std Dev Biased	4.22E-02	5.16E-02	0.00E+00	0.00E+00	3.16E-02	5.16E-02	4.22E-02	0.00E+00	0.00E+00	4.83E-02	5.27E-02	
Ps90%/90% (+KTL) Biased	2.17E+00	2.17E+00	2.00E+00	2.00E+00	2.06E+00	2.05E+00	2.01E+00	1.90E+00	1.90E+00	1.93E+00	1.76E+00	
Ps90%/90% (-KTL) Biased	1.99E+00	1.95E+00	2.00E+00	2.00E+00	1.92E+00	1.83E+00	1.83E+00	1.90E+00	1.90E+00	1.73E+00	1.54E+00	
Specification MIN	1.00E+00	9.00E-01	8.00E-01	8.00E-01	8.00E-01	6.00E-01	6.00E-01	6.00E-01	6.00E-01	5.00E-01	4.00E-01	
Status	PASS	PASS	PASS	PASS	PASS	PASS	PASS	PASS	PASS	PASS	PASS	

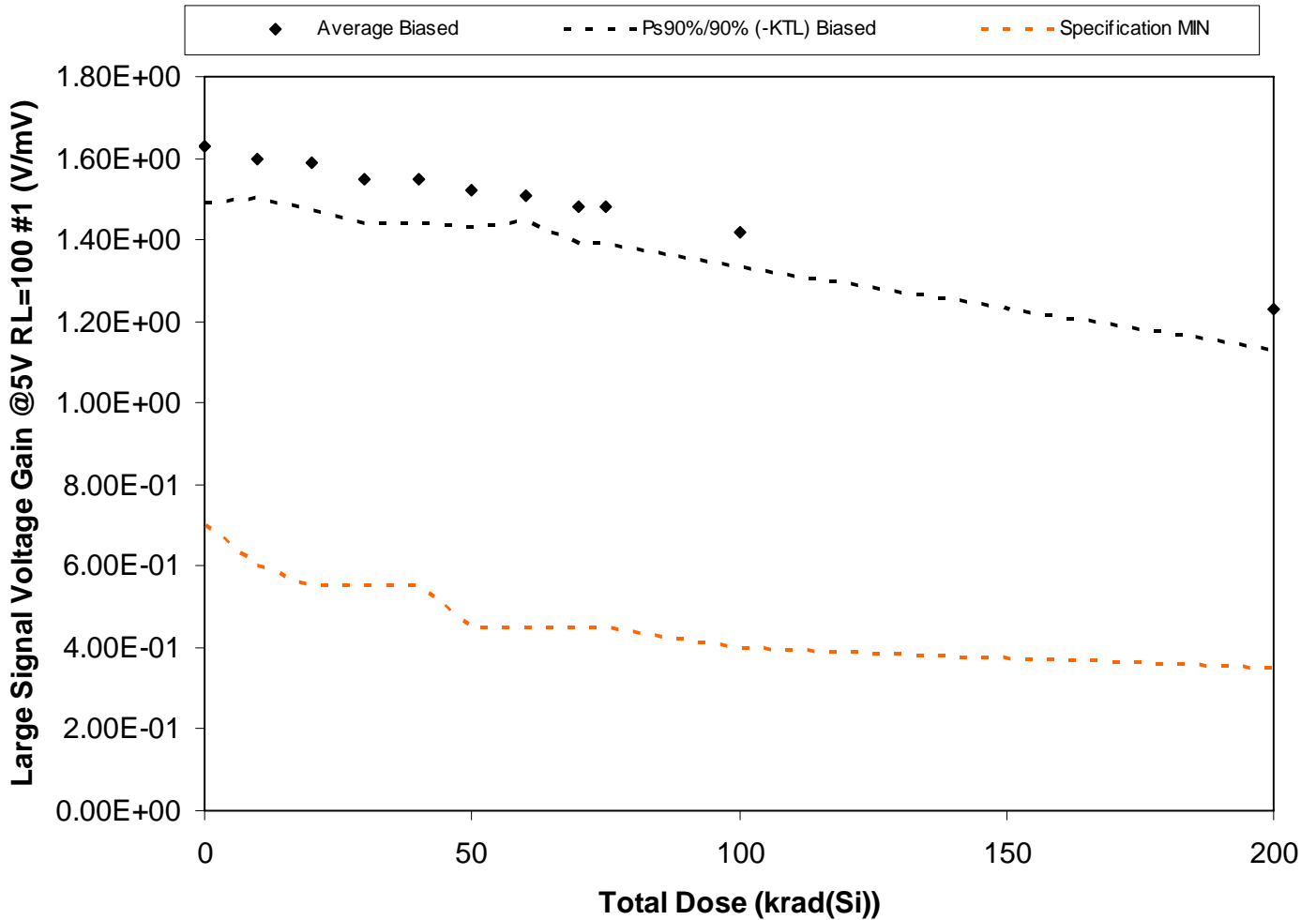

Figure 5.105. Plot of Large Signal Voltage Gain @5V RL=100 #1 (V/mV) versus total dose. The solid diamonds are the average of the measured data points for the samples irradiated under electrical bias and the black lines (solid and/or dashed) are the average of the data points after application of the KTL statistics on the samples irradiated under electrical bias. The red dotted line(s) are the pre- and/or post-irradiation minimum and/or maximum specification value as defined in the datasheet and/or test plan.



**RLAT Report
10-326 100808 R1.0**

**Radiation Assured Devices
5017 N. 30th Street
Colorado Springs, CO 80919
(719) 531-0800**

Table 5.105. Raw data for Large Signal Voltage Gain @5V RL=100 #1 (V/mV) versus total dose, including the statistical analysis, specification and the status of the testing (pass/fail).

Large Signal Voltage Gain @5V RL=100 #1 (V/mV)	Total Dose (krad(Si))											
	0	10	20	30	40	50	60	70	75	100	200	
Device												
1245	1.50E+00	1.60E+00	1.60E+00	1.60E+00	1.60E+00	1.50E+00	1.50E+00	1.50E+00	1.50E+00	1.50E+00	1.50E+00	1.30E+00
1246	1.70E+00	1.60E+00	1.50E+00	1.50E+00	1.50E+00	1.50E+00	1.50E+00	1.40E+00	1.40E+00	1.40E+00	1.40E+00	1.20E+00
1247	1.60E+00	1.50E+00	1.50E+00	1.50E+00	1.50E+00	1.50E+00	1.50E+00	1.40E+00	1.40E+00	1.40E+00	1.40E+00	1.20E+00
1248	1.60E+00	1.70E+00	1.70E+00	1.60E+00	1.60E+00	1.60E+00	1.50E+00	1.50E+00	1.50E+00	1.40E+00	1.40E+00	1.20E+00
1249	1.60E+00	1.60E+00	1.60E+00	1.60E+00	1.60E+00	1.60E+00	1.60E+00	1.50E+00	1.50E+00	1.50E+00	1.50E+00	1.30E+00
1250	1.70E+00	1.60E+00	1.60E+00	1.50E+00	1.50E+00	1.50E+00	1.50E+00	1.50E+00	1.50E+00	1.40E+00	1.20E+00	
1251	1.70E+00	1.60E+00	1.60E+00	1.60E+00	1.60E+00	1.50E+00	1.50E+00	1.50E+00	1.50E+00	1.40E+00	1.30E+00	
1261	1.60E+00	1.60E+00	1.60E+00	1.50E+00	1.50E+00	1.50E+00	1.50E+00	1.50E+00	1.50E+00	1.40E+00	1.20E+00	
1262	1.60E+00	1.60E+00	1.60E+00	1.50E+00	1.50E+00	1.50E+00	1.50E+00	1.50E+00	1.50E+00	1.40E+00	1.20E+00	
1263	1.70E+00	1.60E+00	1.60E+00	1.60E+00	1.60E+00	1.50E+00	1.50E+00	1.50E+00	1.50E+00	1.40E+00	1.20E+00	
1264	1.70E+00	1.70E+00	1.70E+00	1.70E+00	1.70E+00	1.70E+00	1.70E+00	1.70E+00	1.70E+00	1.70E+00	1.70E+00	
1265	1.60E+00	1.60E+00	1.60E+00	1.60E+00	1.60E+00	1.60E+00	1.60E+00	1.60E+00	1.60E+00	1.60E+00	1.60E+00	
Biased Statistics												
Average Biased	1.63E+00	1.60E+00	1.59E+00	1.55E+00	1.55E+00	1.52E+00	1.51E+00	1.48E+00	1.48E+00	1.42E+00	1.23E+00	
Std Dev Biased	6.75E-02	4.71E-02	5.68E-02	5.27E-02	5.27E-02	4.22E-02	3.16E-02	4.22E-02	4.22E-02	4.22E-02	4.83E-02	
Ps90%/90% (+KTL) Biased	1.77E+00	1.70E+00	1.71E+00	1.66E+00	1.66E+00	1.61E+00	1.58E+00	1.57E+00	1.57E+00	1.51E+00	1.33E+00	
Ps90%/90% (-KTL) Biased	1.49E+00	1.50E+00	1.47E+00	1.44E+00	1.44E+00	1.43E+00	1.44E+00	1.39E+00	1.39E+00	1.33E+00	1.13E+00	
Specification MIN	7.00E-01	6.00E-01	5.50E-01	5.50E-01	5.50E-01	4.50E-01	4.50E-01	4.50E-01	4.50E-01	4.00E-01	3.50E-01	
Status	PASS	PASS	PASS	PASS	PASS	PASS	PASS	PASS	PASS	PASS	PASS	

An ISO 9001:2008 and DSCC Certified Company

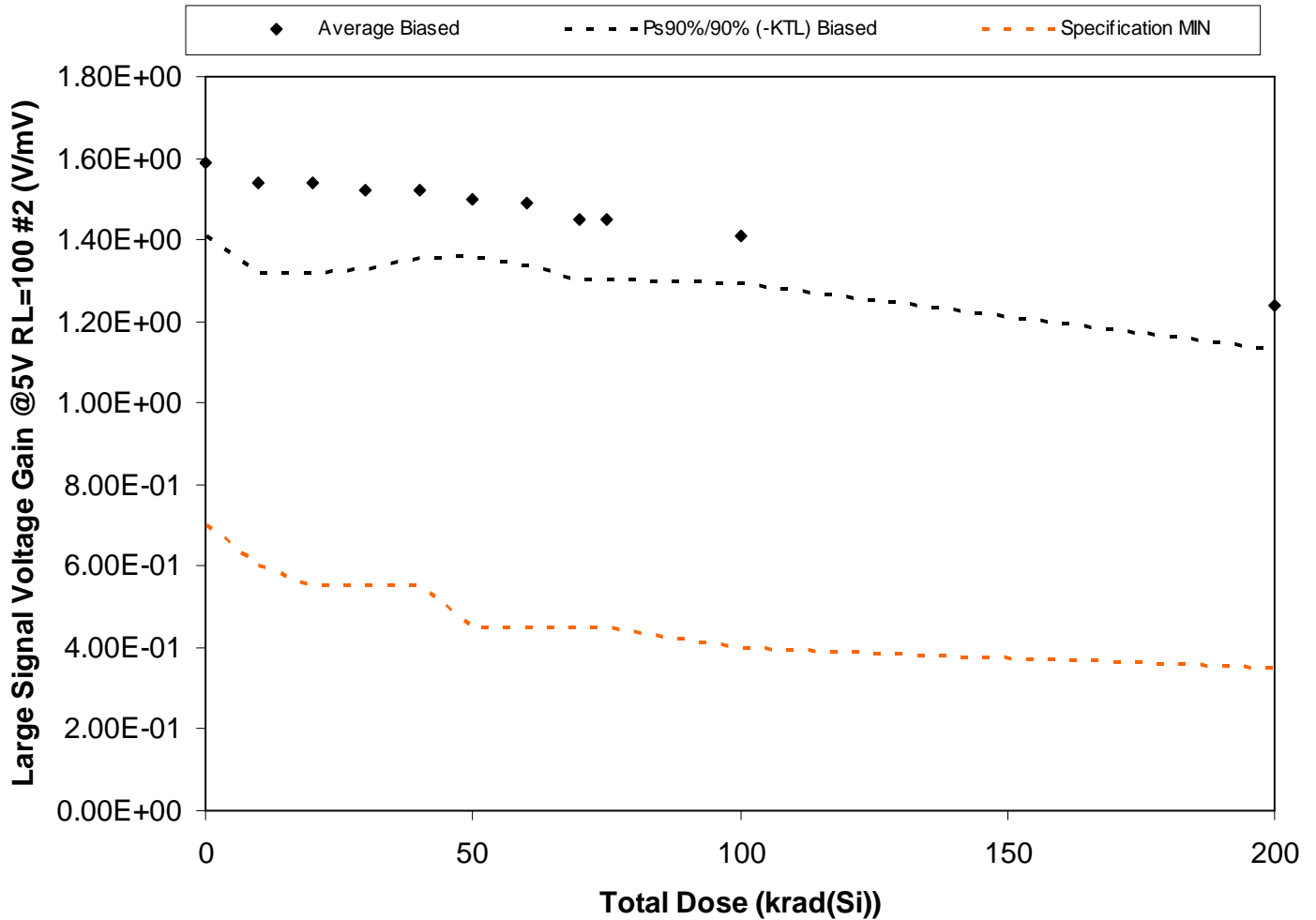

Figure 5.106. Plot of Large Signal Voltage Gain @5V RL=100 #2 (V/mV) versus total dose. The solid diamonds are the average of the measured data points for the samples irradiated under electrical bias and the black lines (solid and/or dashed) are the average of the data points after application of the KTL statistics on the samples irradiated under electrical bias. The red dotted line(s) are the pre- and/or post-irradiation minimum and/or maximum specification value as defined in the datasheet and/or test plan.



**RLAT Report
10-326 100808 R1.0**

**Radiation Assured Devices
5017 N. 30th Street
Colorado Springs, CO 80919
(719) 531-0800**

Table 5.106. Raw data for Large Signal Voltage Gain @5V RL=100 #2 (V/mV) versus total dose, including the statistical analysis, specification and the status of the testing (pass/fail).

Large Signal Voltage Gain @5V RL=100 #2 (V/mV)	Total Dose (krad(Si))											
	0	10	20	30	40	50	60	70	75	100	200	
Device												
1245	1.70E+00	1.60E+00	1.60E+00	1.60E+00	1.50E+00	1.50E+00	1.50E+00	1.50E+00	1.50E+00	1.40E+00	1.30E+00	
1246	1.50E+00	1.40E+00	1.40E+00	1.40E+00	1.50E+00	1.50E+00	1.40E+00	1.40E+00	1.40E+00	1.40E+00	1.20E+00	
1247	1.60E+00	1.60E+00	1.60E+00	1.50E+00	1.50E+00	1.50E+00	1.50E+00	1.50E+00	1.50E+00	1.40E+00	1.30E+00	
1248	1.70E+00	1.70E+00	1.70E+00	1.70E+00	1.70E+00	1.60E+00	1.60E+00	1.60E+00	1.60E+00	1.50E+00	1.30E+00	
1249	1.70E+00	1.70E+00	1.70E+00	1.60E+00	1.60E+00	1.60E+00	1.60E+00	1.50E+00	1.50E+00	1.50E+00	1.30E+00	
1250	1.50E+00	1.50E+00	1.50E+00	1.50E+00	1.50E+00	1.50E+00	1.50E+00	1.40E+00	1.40E+00	1.40E+00	1.20E+00	
1251	1.60E+00	1.50E+00	1.50E+00	1.50E+00	1.50E+00	1.40E+00	1.40E+00	1.40E+00	1.40E+00	1.40E+00	1.20E+00	
1261	1.60E+00	1.50E+00	1.50E+00	1.40E+00	1.40E+00	1.40E+00	1.40E+00	1.40E+00	1.40E+00	1.30E+00	1.20E+00	
1262	1.50E+00	1.40E+00	1.40E+00	1.50E+00	1.50E+00	1.50E+00	1.50E+00	1.40E+00	1.40E+00	1.40E+00	1.20E+00	
1263	1.50E+00	1.50E+00	1.50E+00	1.50E+00	1.50E+00	1.50E+00	1.50E+00	1.40E+00	1.40E+00	1.40E+00	1.20E+00	
1264	1.70E+00	1.70E+00	1.70E+00	1.70E+00	1.70E+00	1.70E+00	1.70E+00	1.70E+00	1.70E+00	1.70E+00	1.70E+00	
1265	1.70E+00	1.70E+00	1.70E+00	1.70E+00	1.70E+00	1.70E+00	1.70E+00	1.70E+00	1.70E+00	1.70E+00	1.70E+00	
Biased Statistics												
Average Biased	1.59E+00	1.54E+00	1.54E+00	1.52E+00	1.52E+00	1.50E+00	1.49E+00	1.45E+00	1.45E+00	1.41E+00	1.24E+00	
Std Dev Biased	8.76E-02	1.07E-01	1.07E-01	9.19E-02	7.89E-02	6.67E-02	7.38E-02	7.07E-02	7.07E-02	5.68E-02	5.16E-02	
Ps90%/90% (+KTL) Biased	1.77E+00	1.76E+00	1.76E+00	1.71E+00	1.68E+00	1.64E+00	1.64E+00	1.60E+00	1.60E+00	1.53E+00	1.35E+00	
Ps90%/90% (-KTL) Biased	1.41E+00	1.32E+00	1.32E+00	1.33E+00	1.36E+00	1.36E+00	1.34E+00	1.30E+00	1.30E+00	1.29E+00	1.13E+00	
Specification MIN	7.00E-01	6.00E-01	5.50E-01	5.50E-01	5.50E-01	4.50E-01	4.50E-01	4.50E-01	4.50E-01	4.00E-01	3.50E-01	
Status	PASS	PASS	PASS	PASS	PASS	PASS	PASS	PASS	PASS	PASS	PASS	

An ISO 9001:2008 and DSCC Certified Company

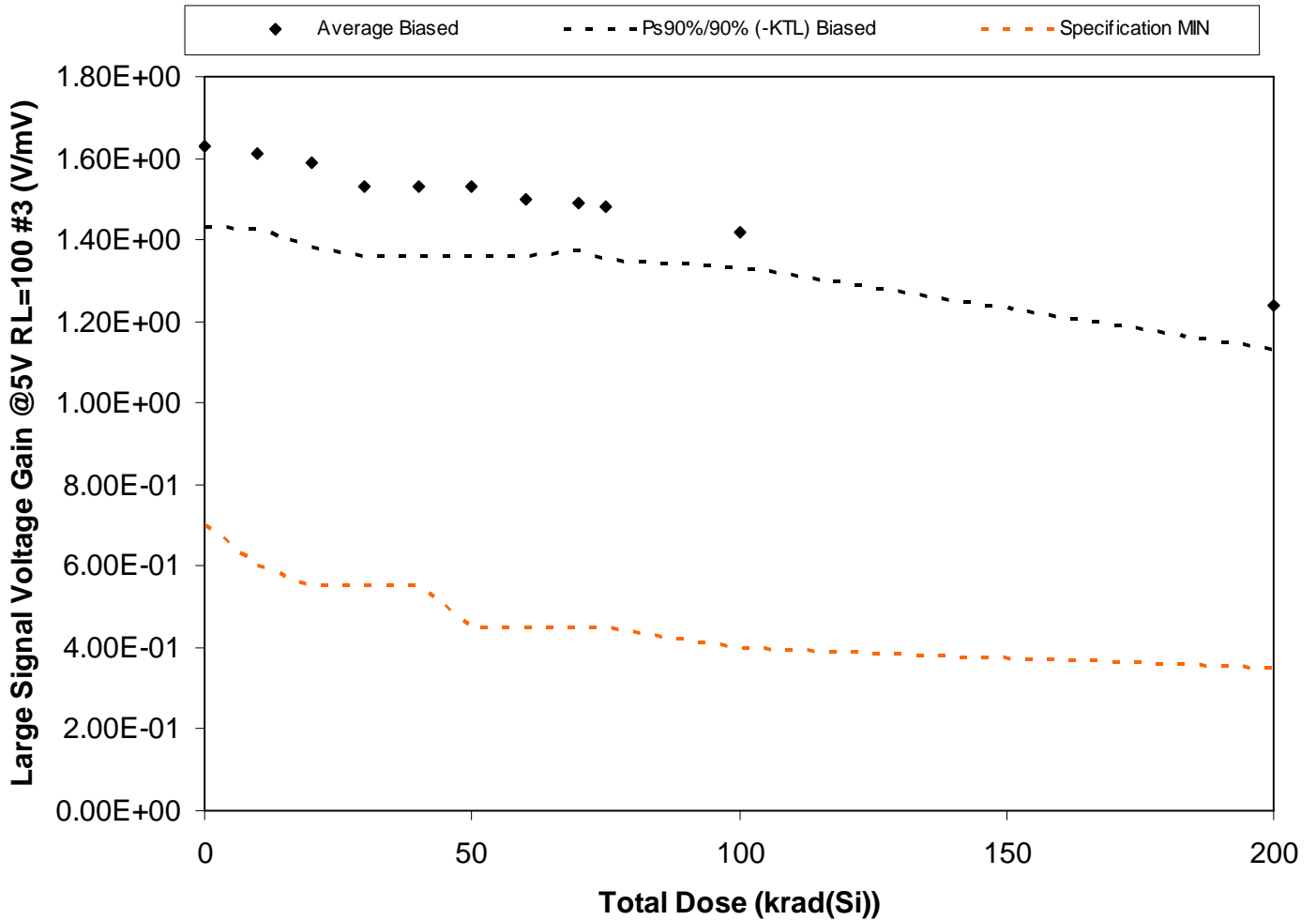

Figure 5.107. Plot of Large Signal Voltage Gain @5V RL=100 #3 (V/mV) versus total dose. The solid diamonds are the average of the measured data points for the samples irradiated under electrical bias and the black lines (solid and/or dashed) are the average of the data points after application of the KTL statistics on the samples irradiated under electrical bias. The red dotted line(s) are the pre- and/or post-irradiation minimum and/or maximum specification value as defined in the datasheet and/or test plan.



**RLAT Report
10-326 100808 R1.0**

**Radiation Assured Devices
5017 N. 30th Street
Colorado Springs, CO 80919
(719) 531-0800**

Table 5.107. Raw data for Large Signal Voltage Gain @5V RL=100 #3 (V/mV) versus total dose, including the statistical analysis, specification and the status of the testing (pass/fail).

Large Signal Voltage Gain @5V RL=100 #3 (V/mV)	Total Dose (krad(Si))											
	0	10	20	30	40	50	60	70	75	100	200	
Device												
1245	1.70E+00	1.60E+00	1.60E+00	1.60E+00	1.60E+00	1.60E+00	1.50E+00	1.50E+00	1.50E+00	1.40E+00	1.30E+00	
1246	1.60E+00	1.50E+00	1.50E+00	1.50E+00	1.50E+00	1.50E+00	1.40E+00	1.40E+00	1.40E+00	1.40E+00	1.20E+00	
1247	1.60E+00	1.60E+00	1.60E+00	1.50E+00	1.50E+00	1.50E+00	1.50E+00	1.50E+00	1.50E+00	1.40E+00	1.20E+00	
1248	1.80E+00	1.80E+00	1.80E+00	1.70E+00	1.70E+00	1.70E+00	1.60E+00	1.60E+00	1.60E+00	1.50E+00	1.30E+00	
1249	1.70E+00	1.70E+00	1.70E+00	1.60E+00	1.60E+00	1.60E+00	1.60E+00	1.50E+00	1.50E+00	1.50E+00	1.30E+00	
1250	1.50E+00	1.60E+00	1.60E+00	1.50E+00	1.50E+00	1.50E+00	1.50E+00	1.50E+00	1.50E+00	1.40E+00	1.20E+00	
1251	1.60E+00	1.60E+00	1.50E+00	1.50E+00	1.50E+00	1.50E+00	1.50E+00	1.50E+00	1.40E+00	1.40E+00	1.20E+00	
1261	1.50E+00	1.50E+00	1.50E+00	1.40E+00	1.40E+00	1.40E+00	1.40E+00	1.40E+00	1.40E+00	1.40E+00	1.20E+00	
1262	1.70E+00	1.60E+00	1.60E+00	1.50E+00	1.50E+00	1.50E+00	1.50E+00	1.50E+00	1.50E+00	1.40E+00	1.30E+00	
1263	1.60E+00	1.60E+00	1.50E+00	1.50E+00	1.50E+00	1.50E+00	1.50E+00	1.50E+00	1.50E+00	1.40E+00	1.20E+00	
1264	1.60E+00	1.60E+00	1.60E+00	1.60E+00	1.60E+00	1.60E+00	1.60E+00	1.60E+00	1.60E+00	1.60E+00	1.60E+00	
1265	1.60E+00	1.60E+00	1.60E+00	1.60E+00	1.60E+00	1.60E+00	1.60E+00	1.60E+00	1.60E+00	1.60E+00	1.60E+00	
Biased Statistics												
Average Biased	1.63E+00	1.61E+00	1.59E+00	1.53E+00	1.53E+00	1.53E+00	1.50E+00	1.49E+00	1.48E+00	1.42E+00	1.24E+00	
Std Dev Biased	9.49E-02	8.76E-02	9.94E-02	8.23E-02	8.23E-02	8.23E-02	6.67E-02	5.68E-02	6.32E-02	4.22E-02	5.16E-02	
Ps90%/90% (+KTL) Biased	1.83E+00	1.79E+00	1.80E+00	1.70E+00	1.70E+00	1.70E+00	1.64E+00	1.61E+00	1.61E+00	1.51E+00	1.35E+00	
Ps90%/90% (-KTL) Biased	1.43E+00	1.43E+00	1.38E+00	1.36E+00	1.36E+00	1.36E+00	1.36E+00	1.37E+00	1.35E+00	1.33E+00	1.13E+00	
Specification MIN	7.00E-01	6.00E-01	5.50E-01	5.50E-01	5.50E-01	4.50E-01	4.50E-01	4.50E-01	4.50E-01	4.00E-01	3.50E-01	
Status	PASS	PASS	PASS	PASS	PASS	PASS	PASS	PASS	PASS	PASS	PASS	

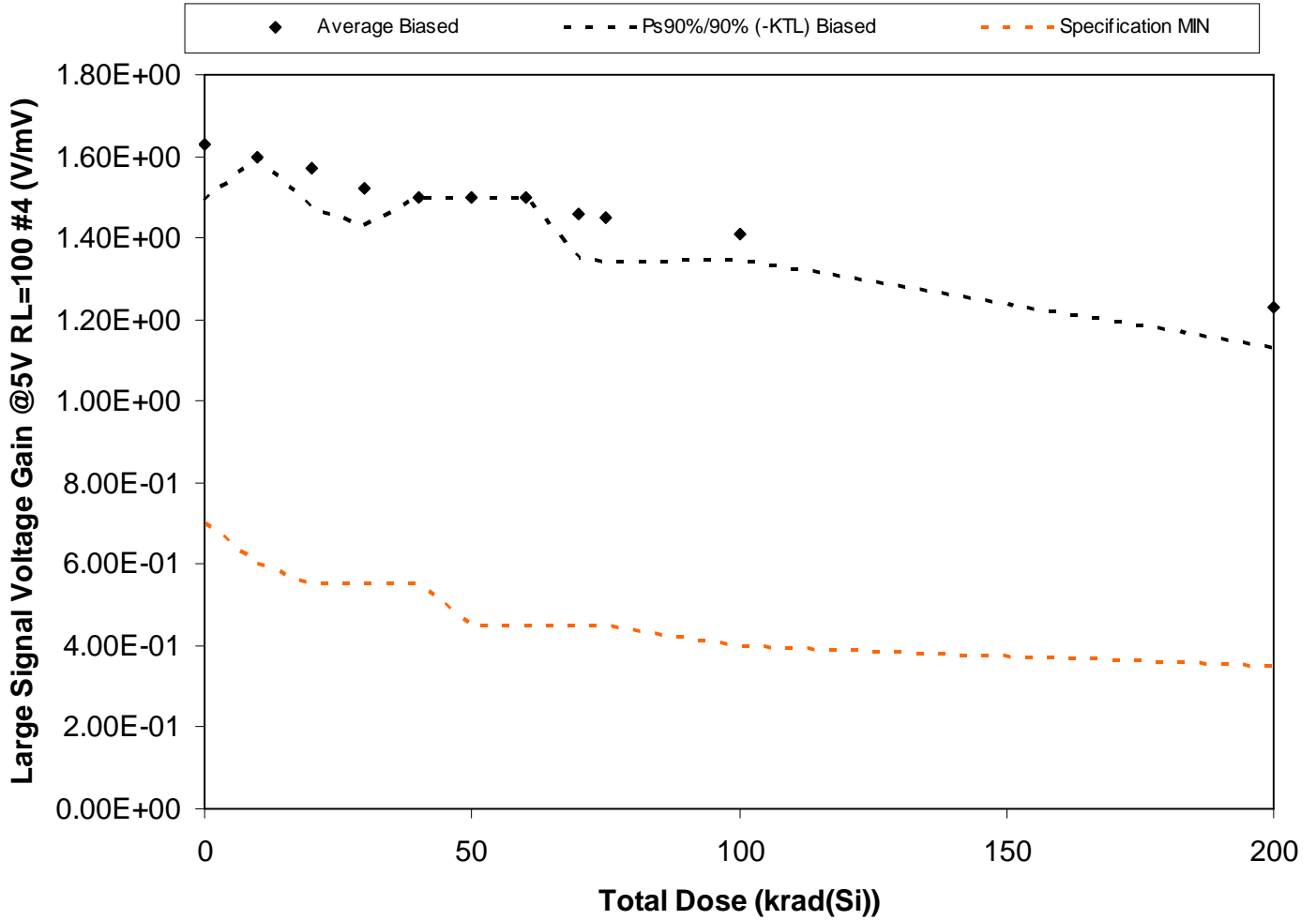

Figure 5.108. Plot of Large Signal Voltage Gain @5V RL=100 #4 (V/mV) versus total dose. The solid diamonds are the average of the measured data points for the samples irradiated under electrical bias and the black lines (solid and/or dashed) are the average of the data points after application of the KTL statistics on the samples irradiated under electrical bias. The red dotted line(s) are the pre- and/or post-irradiation minimum and/or maximum specification value as defined in the datasheet and/or test plan.



**RLAT Report
10-326 100808 R1.0**

**Radiation Assured Devices
5017 N. 30th Street
Colorado Springs, CO 80919
(719) 531-0800**

Table 5.108. Raw data for Large Signal Voltage Gain @5V RL=100 #4 (V/mV) versus total dose, including the statistical analysis, specification and the status of the testing (pass/fail).

Large Signal Voltage Gain @5V RL=100 #4 (V/mV)	Total Dose (krad(Si))											
	0	10	20	30	40	50	60	70	75	100	200	
Device												
1245	1.60E+00	1.60E+00	1.60E+00	1.50E+00	1.50E+00	1.50E+00	1.50E+00	1.50E+00	1.50E+00	1.40E+00	1.20E+00	
1246	1.60E+00	1.60E+00	1.50E+00	1.50E+00	1.50E+00	1.50E+00	1.50E+00	1.40E+00	1.40E+00	1.40E+00	1.20E+00	
1247	1.70E+00	1.60E+00	1.60E+00	1.50E+00	1.50E+00	1.50E+00	1.50E+00	1.50E+00	1.50E+00	1.50E+00	1.30E+00	
1248	1.50E+00	1.60E+00	1.60E+00	1.60E+00	1.50E+00	1.50E+00	1.50E+00	1.50E+00	1.40E+00	1.40E+00	1.20E+00	
1249	1.60E+00	1.60E+00	1.60E+00	1.50E+00	1.50E+00	1.50E+00	1.50E+00	1.50E+00	1.50E+00	1.40E+00	1.30E+00	
1250	1.70E+00	1.60E+00	1.60E+00	1.50E+00	1.50E+00	1.50E+00	1.50E+00	1.50E+00	1.50E+00	1.40E+00	1.20E+00	
1251	1.70E+00	1.60E+00	1.60E+00	1.60E+00	1.50E+00	1.50E+00	1.50E+00	1.50E+00	1.50E+00	1.40E+00	1.30E+00	
1261	1.60E+00	1.60E+00	1.50E+00	1.50E+00	1.50E+00	1.50E+00	1.50E+00	1.40E+00	1.40E+00	1.40E+00	1.20E+00	
1262	1.60E+00	1.60E+00	1.50E+00	1.50E+00	1.50E+00	1.50E+00	1.50E+00	1.40E+00	1.40E+00	1.40E+00	1.20E+00	
1263	1.70E+00	1.60E+00	1.60E+00	1.50E+00	1.50E+00	1.50E+00	1.50E+00	1.40E+00	1.40E+00	1.40E+00	1.20E+00	
1264	1.70E+00	1.70E+00	1.70E+00	1.70E+00	1.70E+00	1.70E+00	1.70E+00	1.70E+00	1.70E+00	1.70E+00	1.70E+00	
1265	1.60E+00	1.60E+00	1.60E+00	1.60E+00	1.60E+00	1.60E+00	1.60E+00	1.60E+00	1.60E+00	1.60E+00	1.60E+00	
Biased Statistics												
Average Biased	1.63E+00	1.60E+00	1.57E+00	1.52E+00	1.50E+00	1.50E+00	1.50E+00	1.46E+00	1.45E+00	1.41E+00	1.23E+00	
Std Dev Biased	6.75E-02	2.34E-16	4.83E-02	4.22E-02	0.00E+00	0.00E+00	0.00E+00	5.16E-02	5.27E-02	3.16E-02	4.83E-02	
Ps90%/90% (+KTL) Biased	1.77E+00	1.60E+00	1.67E+00	1.61E+00	1.50E+00	1.50E+00	1.50E+00	1.57E+00	1.56E+00	1.48E+00	1.33E+00	
Ps90%/90% (-KTL) Biased	1.49E+00	1.60E+00	1.47E+00	1.43E+00	1.50E+00	1.50E+00	1.50E+00	1.35E+00	1.34E+00	1.34E+00	1.13E+00	
Specification MIN	7.00E-01	6.00E-01	5.50E-01	5.50E-01	5.50E-01	4.50E-01	4.50E-01	4.50E-01	4.50E-01	4.00E-01	3.50E-01	
Status	PASS	PASS	PASS	PASS	PASS	PASS	PASS	PASS	PASS	PASS	PASS	

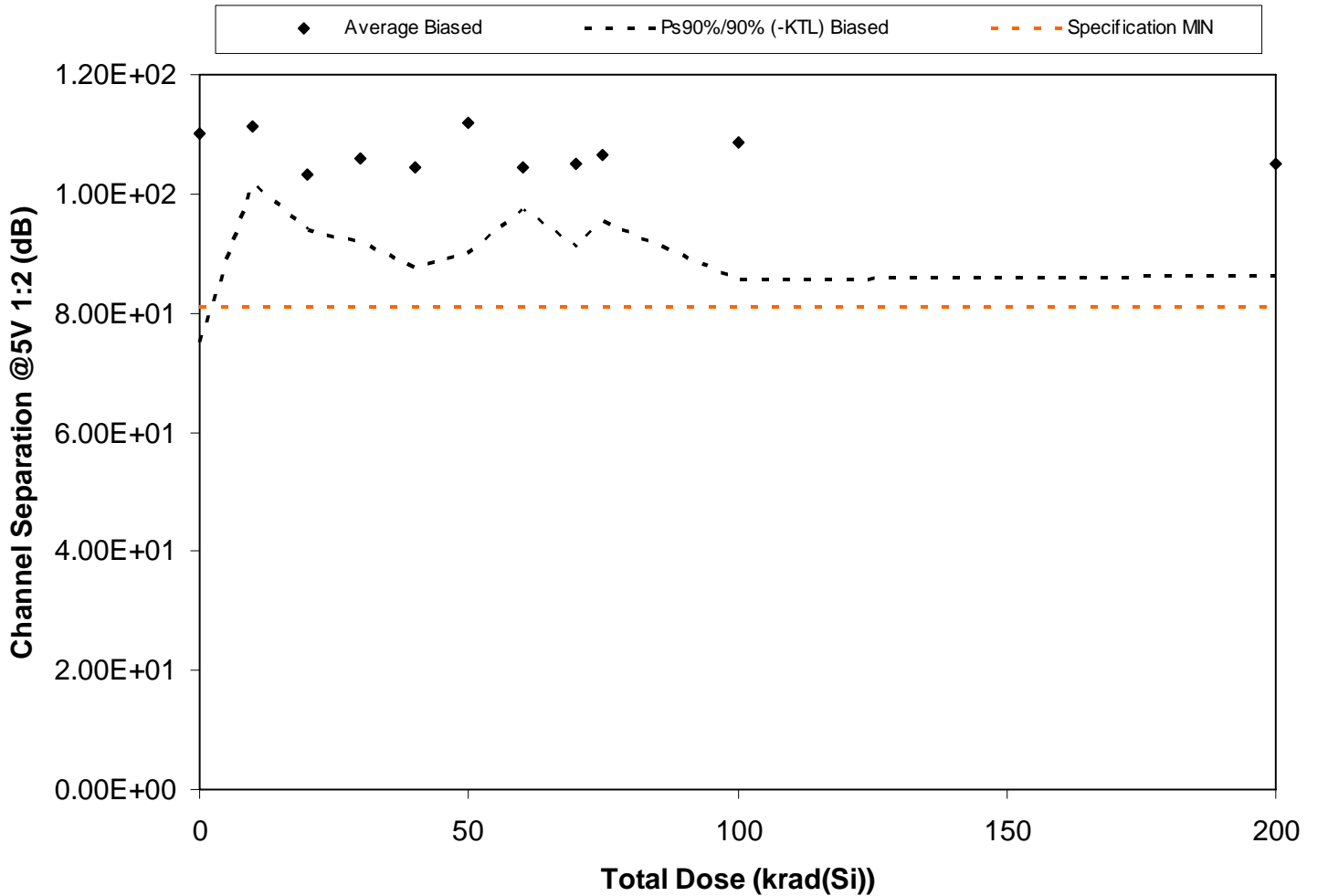

Figure 5.109. Plot of Channel Separation @5V 1:2 (dB) versus total dose. The solid diamonds are the average of the measured data points for the samples irradiated under electrical bias and the black lines (solid and/or dashed) are the average of the data points after application of the KTL statistics on the samples irradiated under electrical bias. The red dotted line(s) are the pre- and/or post-irradiation minimum and/or maximum specification value as defined in the datasheet and/or test plan.



**RLAT Report
10-326 100808 R1.0**

**Radiation Assured Devices
5017 N. 30th Street
Colorado Springs, CO 80919
(719) 531-0800**

Table 5.109. Raw data for Channel Separation @5V 1:2 (dB) versus total dose, including the statistical analysis, specification and the status of the testing (pass/fail).

Channel Separation @5V 1:2 (dB)	Total Dose (krad(Si))											
	0	10	20	30	40	50	60	70	75	100	200	
Device												
1245	1.08E+02	1.17E+02	1.09E+02	1.11E+02	9.50E+01	1.26E+02	1.05E+02	1.18E+02	1.12E+02	1.13E+02	9.72E+01	
1246	1.02E+02	1.18E+02	1.05E+02	9.41E+01	1.19E+02	1.07E+02	1.04E+02	1.09E+02	1.07E+02	9.69E+01	1.02E+02	
1247	1.55E+02	1.04E+02	1.03E+02	1.10E+02	9.66E+01	1.28E+02	1.01E+02	9.96E+01	1.13E+02	1.16E+02	1.18E+02	
1248	1.18E+02	1.14E+02	1.04E+02	1.03E+02	1.06E+02	1.07E+02	1.08E+02	1.06E+02	9.84E+01	1.09E+02	1.05E+02	
1249	9.80E+01	1.04E+02	1.10E+02	1.08E+02	1.05E+02	1.13E+02	9.95E+01	9.89E+01	1.07E+02	9.64E+01	1.05E+02	
1250	1.11E+02	1.13E+02	9.93E+01	1.08E+02	9.74E+01	1.04E+02	1.02E+02	1.12E+02	1.06E+02	1.15E+02	9.94E+01	
1251	9.63E+01	1.10E+02	1.05E+02	9.67E+01	1.07E+02	1.02E+02	1.04E+02	1.03E+02	9.92E+01	1.11E+02	1.09E+02	
1261	1.07E+02	1.10E+02	1.03E+02	1.02E+02	9.66E+01	1.02E+02	1.09E+02	9.94E+01	1.08E+02	1.30E+02	1.23E+02	
1262	1.04E+02	1.13E+02	9.75E+01	1.16E+02	1.06E+02	1.07E+02	1.09E+02	9.62E+01	1.13E+02	1.03E+02	9.74E+01	
1263	1.03E+02	1.10E+02	9.70E+01	1.10E+02	1.15E+02	1.26E+02	1.02E+02	1.08E+02	1.02E+02	9.47E+01	9.56E+01	
1264	1.11E+02	1.10E+02	1.14E+02	1.09E+02	1.10E+02	1.47E+02	1.09E+02	1.17E+02	1.20E+02	1.02E+02	1.07E+02	
1265	1.06E+02	1.01E+02	1.13E+02	1.30E+02	1.18E+02	1.17E+02	1.07E+02	1.02E+02	1.05E+02	1.11E+02	1.05E+02	
Biased Statistics												
Average Biased	1.10E+02	1.11E+02	1.03E+02	1.06E+02	1.04E+02	1.12E+02	1.04E+02	1.05E+02	1.06E+02	1.09E+02	1.05E+02	
Std Dev Biased	1.70E+01	4.66E+00	4.43E+00	6.80E+00	8.09E+00	1.06E+01	3.44E+00	6.78E+00	5.29E+00	1.11E+01	9.22E+00	
Ps90%/90% (+KTL) Biased	1.45E+02	1.21E+02	1.12E+02	1.20E+02	1.21E+02	1.34E+02	1.11E+02	1.19E+02	1.17E+02	1.32E+02	1.24E+02	
Ps90%/90% (-KTL) Biased	7.51E+01	1.02E+02	9.40E+01	9.18E+01	8.76E+01	9.01E+01	9.73E+01	9.10E+01	9.55E+01	8.57E+01	8.61E+01	
Specification MIN	8.10E+01	8.10E+01	8.10E+01	8.10E+01	8.10E+01	8.10E+01	8.10E+01	8.10E+01	8.10E+01	8.10E+01	8.10E+01	
Status	PASS	PASS	PASS	PASS	PASS	PASS	PASS	PASS	PASS	PASS	PASS	

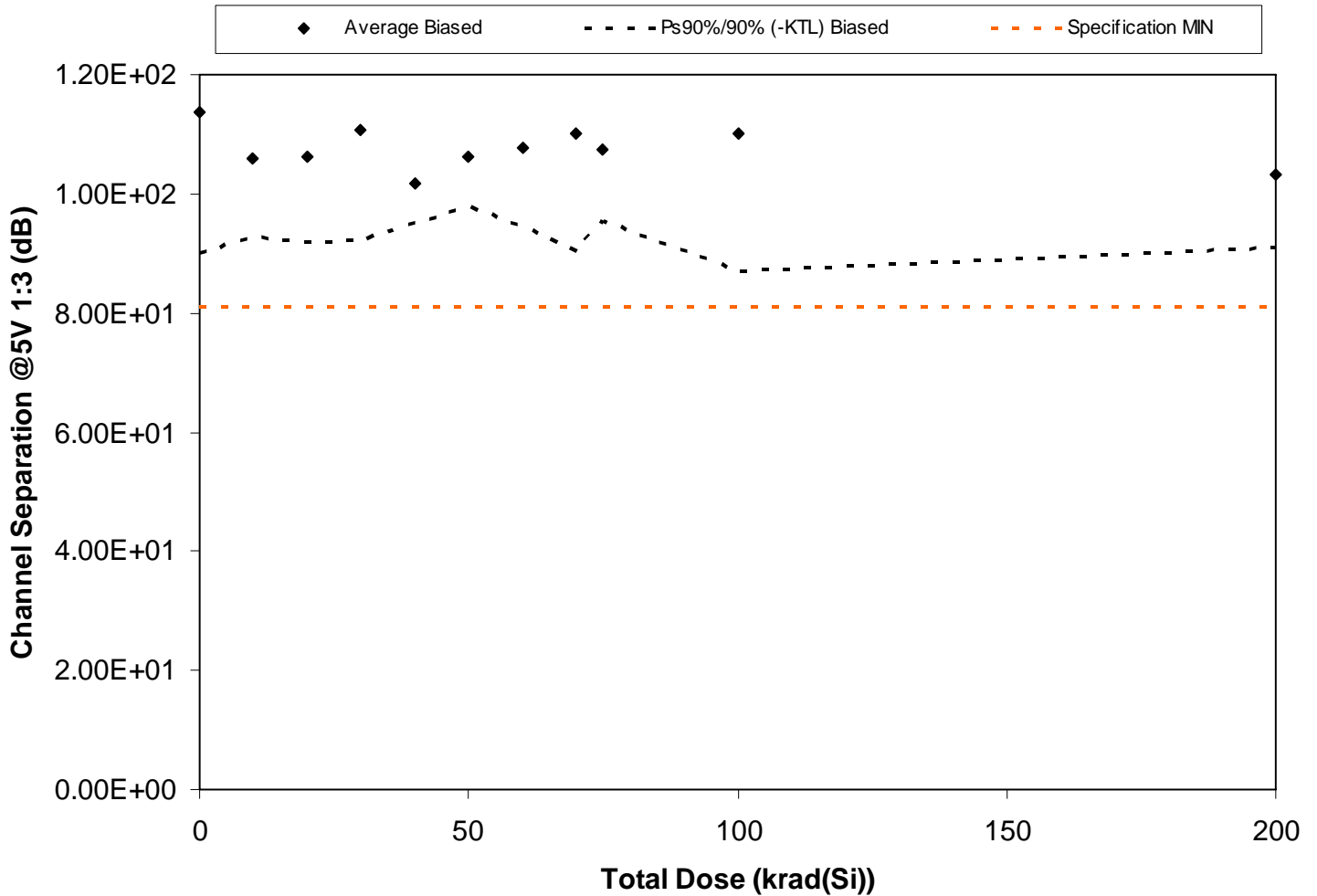

Figure 5.110. Plot of Channel Separation @5V 1:3 (dB) versus total dose. The solid diamonds are the average of the measured data points for the samples irradiated under electrical bias and the black lines (solid and/or dashed) are the average of the data points after application of the KTL statistics on the samples irradiated under electrical bias. The red dotted line(s) are the pre- and/or post-irradiation minimum and/or maximum specification value as defined in the datasheet and/or test plan.



**RLAT Report
10-326 100808 R1.0**

**Radiation Assured Devices
5017 N. 30th Street
Colorado Springs, CO 80919
(719) 531-0800**

Table 5.110. Raw data for Channel Separation @5V 1:3 (dB) versus total dose, including the statistical analysis, specification and the status of the testing (pass/fail).

Channel Separation @5V 1:3 (dB)	Total Dose (krad(Si))											
	0	10	20	30	40	50	60	70	75	100	200	
Device												
1245	1.16E+02	1.20E+02	9.27E+01	1.07E+02	9.88E+01	1.05E+02	1.14E+02	1.06E+02	1.16E+02	1.26E+02	9.83E+01	
1246	1.08E+02	1.13E+02	1.10E+02	1.05E+02	1.03E+02	1.14E+02	1.03E+02	1.25E+02	1.02E+02	1.15E+02	9.88E+01	
1247	1.08E+02	1.07E+02	1.09E+02	1.09E+02	1.04E+02	1.02E+02	1.04E+02	1.23E+02	1.16E+02	1.02E+02	1.03E+02	
1248	1.18E+02	1.04E+02	1.12E+02	1.06E+02	1.02E+02	1.07E+02	1.06E+02	1.03E+02	1.12E+02	9.32E+01	9.35E+01	
1249	1.17E+02	1.07E+02	1.15E+02	1.03E+02	1.08E+02	1.09E+02	1.18E+02	1.20E+02	1.08E+02	1.22E+02	9.88E+01	
1250	1.03E+02	1.02E+02	1.04E+02	1.16E+02	1.02E+02	1.03E+02	1.10E+02	9.90E+01	1.09E+02	1.08E+02	1.11E+02	
1251	9.79E+01	1.02E+02	9.99E+01	1.05E+02	1.00E+02	1.04E+02	9.83E+01	1.16E+02	1.00E+02	9.90E+01	1.06E+02	
1261	1.35E+02	9.80E+01	1.12E+02	1.26E+02	1.06E+02	1.03E+02	1.14E+02	1.02E+02	1.04E+02	1.06E+02	1.12E+02	
1262	1.06E+02	1.02E+02	1.04E+02	1.26E+02	9.75E+01	1.04E+02	1.08E+02	1.05E+02	1.02E+02	1.24E+02	1.08E+02	
1263	1.28E+02	1.06E+02	1.03E+02	1.04E+02	9.90E+01	1.12E+02	1.01E+02	1.05E+02	1.05E+02	1.08E+02	1.05E+02	
1264	1.14E+02	1.08E+02	1.06E+02	1.04E+02	1.18E+02	1.10E+02	1.01E+02	1.09E+02	1.05E+02	1.04E+02	1.01E+02	
1265	1.10E+02	1.13E+02	1.23E+02	9.89E+01	1.10E+02	9.73E+01	9.72E+01	9.78E+01	1.14E+02	1.06E+02	1.09E+02	
Biased Statistics												
Average Biased	1.14E+02	1.06E+02	1.06E+02	1.11E+02	1.02E+02	1.06E+02	1.08E+02	1.10E+02	1.07E+02	1.10E+02	1.03E+02	
Std Dev Biased	1.14E+01	6.34E+00	6.85E+00	8.94E+00	3.21E+00	4.02E+00	6.27E+00	9.59E+00	5.79E+00	1.12E+01	5.98E+00	
Ps90%/90% (+KTL) Biased	1.37E+02	1.19E+02	1.20E+02	1.29E+02	1.08E+02	1.15E+02	1.21E+02	1.30E+02	1.19E+02	1.33E+02	1.16E+02	
Ps90%/90% (-KTL) Biased	9.01E+01	9.29E+01	9.20E+01	9.22E+01	9.52E+01	9.80E+01	9.46E+01	9.04E+01	9.54E+01	8.71E+01	9.10E+01	
Specification MIN	8.10E+01	8.10E+01	8.10E+01	8.10E+01	8.10E+01	8.10E+01	8.10E+01	8.10E+01	8.10E+01	8.10E+01	8.10E+01	
Status	PASS	PASS	PASS	PASS	PASS	PASS	PASS	PASS	PASS	PASS	PASS	

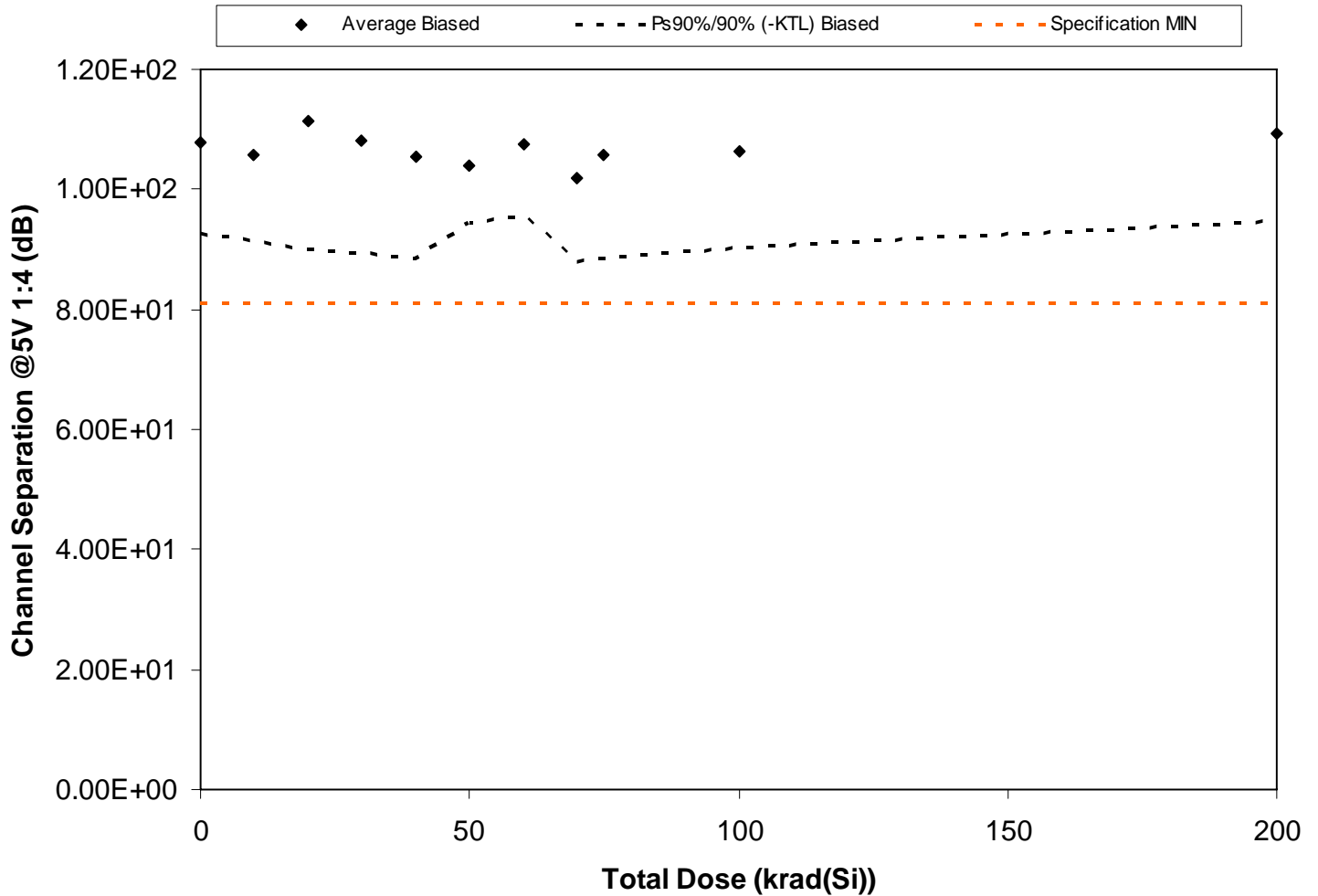

Figure 5.111. Plot of Channel Separation @5V 1:4 (dB) versus total dose. The solid diamonds are the average of the measured data points for the samples irradiated under electrical bias and the black lines (solid and/or dashed) are the average of the data points after application of the KTL statistics on the samples irradiated under electrical bias. The red dotted line(s) are the pre- and/or post-irradiation minimum and/or maximum specification value as defined in the datasheet and/or test plan.



**RLAT Report
10-326 100808 R1.0**

**Radiation Assured Devices
5017 N. 30th Street
Colorado Springs, CO 80919
(719) 531-0800**

Table 5.111. Raw data for Channel Separation @5V 1:4 (dB) versus total dose, including the statistical analysis, specification and the status of the testing (pass/fail).

Channel Separation @5V 1:4 (dB)	Total Dose (krad(Si))											
	0	10	20	30	40	50	60	70	75	100	200	
Device												
1245	1.11E+02	1.01E+02	1.21E+02	1.11E+02	1.01E+02	1.08E+02	1.04E+02	9.81E+01	9.69E+01	1.13E+02	1.12E+02	
1246	1.22E+02	1.23E+02	1.02E+02	1.01E+02	9.64E+01	1.11E+02	1.08E+02	9.38E+01	9.96E+01	9.38E+01	1.02E+02	
1247	1.02E+02	1.04E+02	1.04E+02	1.16E+02	1.15E+02	1.01E+02	9.91E+01	1.15E+02	1.10E+02	9.61E+01	1.17E+02	
1248	1.15E+02	1.09E+02	1.11E+02	1.01E+02	9.91E+01	9.96E+01	1.13E+02	9.90E+01	1.19E+02	1.12E+02	1.23E+02	
1249	1.15E+02	1.01E+02	1.24E+02	1.13E+02	1.20E+02	1.05E+02	1.08E+02	1.04E+02	9.94E+01	1.06E+02	1.07E+02	
1250	1.05E+02	1.08E+02	1.00E+02	1.28E+02	1.09E+02	1.07E+02	1.19E+02	9.56E+01	1.08E+02	1.04E+02	1.13E+02	
1251	1.03E+02	1.07E+02	1.20E+02	1.02E+02	1.13E+02	1.05E+02	1.04E+02	1.07E+02	1.00E+02	1.01E+02	1.02E+02	
1261	9.94E+01	1.04E+02	1.03E+02	1.07E+02	1.05E+02	1.01E+02	1.11E+02	9.58E+01	9.64E+01	1.13E+02	1.10E+02	
1262	9.97E+01	1.03E+02	1.26E+02	1.02E+02	1.02E+02	1.07E+02	1.05E+02	1.02E+02	1.18E+02	1.17E+02	1.09E+02	
1263	1.09E+02	9.75E+01	1.03E+02	1.00E+02	9.58E+01	9.58E+01	1.04E+02	1.10E+02	1.08E+02	1.07E+02	1.00E+02	
1264	1.03E+02	1.04E+02	9.76E+01	1.16E+02	1.08E+02	1.08E+02	1.01E+02	1.02E+02	1.03E+02	1.03E+02	1.59E+02	
1265	1.01E+02	9.53E+01	1.09E+02	1.02E+02	1.36E+02	9.48E+01	1.14E+02	1.17E+02	1.04E+02	9.98E+01	1.01E+02	
Biased Statistics												
Average Biased	1.08E+02	1.06E+02	1.12E+02	1.08E+02	1.06E+02	1.04E+02	1.07E+02	1.02E+02	1.06E+02	1.06E+02	1.09E+02	
Std Dev Biased	7.43E+00	6.94E+00	1.04E+01	9.06E+00	8.32E+00	4.64E+00	5.79E+00	6.84E+00	8.34E+00	7.66E+00	7.12E+00	
Ps90%/90% (+KTL) Biased	1.23E+02	1.20E+02	1.33E+02	1.27E+02	1.23E+02	1.14E+02	1.19E+02	1.16E+02	1.23E+02	1.22E+02	1.24E+02	
Ps90%/90% (-KTL) Biased	9.26E+01	9.14E+01	9.01E+01	8.94E+01	8.84E+01	9.44E+01	9.55E+01	8.78E+01	8.84E+01	9.04E+01	9.46E+01	
Specification MIN	8.10E+01	8.10E+01	8.10E+01	8.10E+01	8.10E+01	8.10E+01	8.10E+01	8.10E+01	8.10E+01	8.10E+01	8.10E+01	
Status	PASS	PASS	PASS	PASS	PASS	PASS	PASS	PASS	PASS	PASS	PASS	

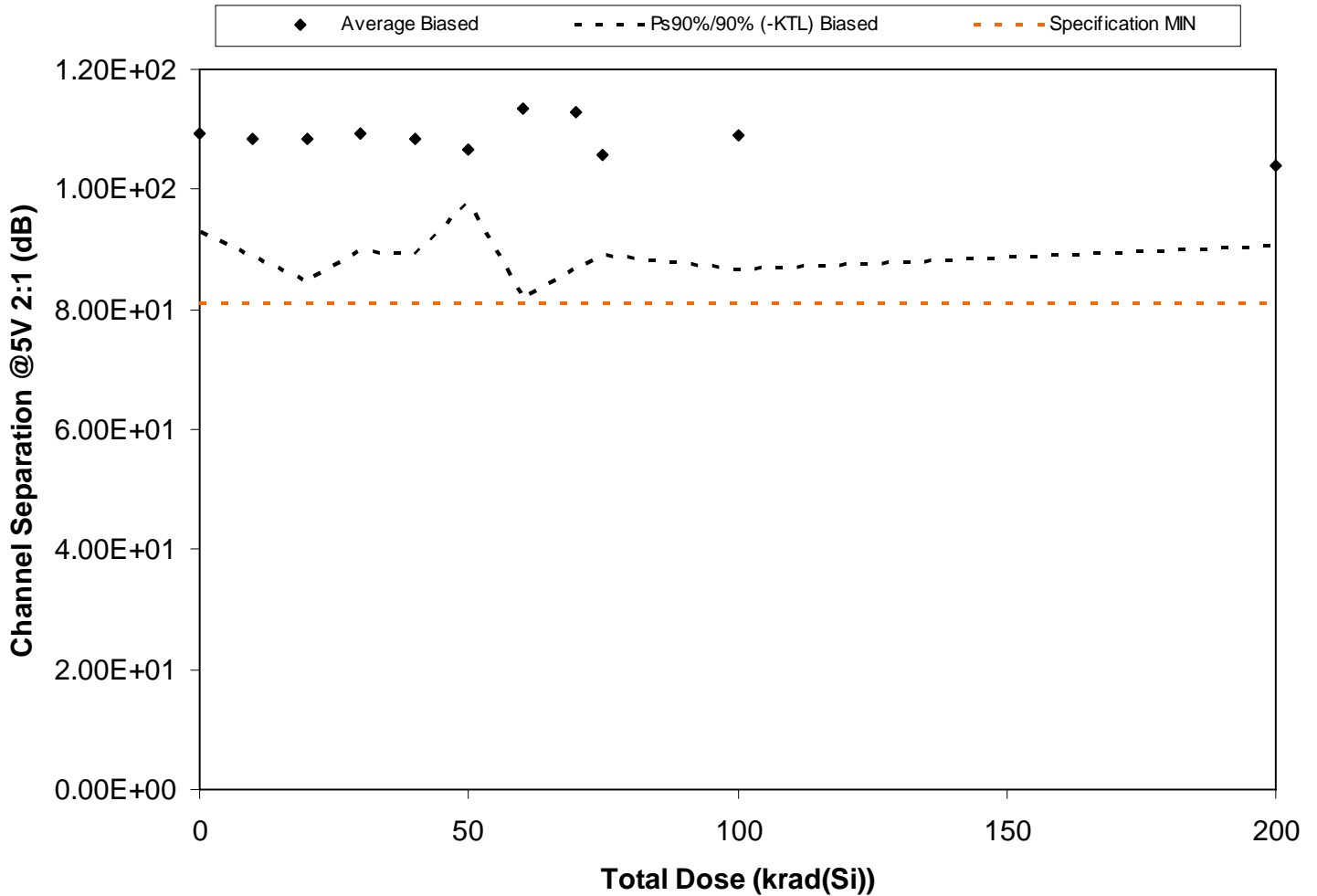

Figure 5.112. Plot of Channel Separation @5V 2:1 (dB) versus total dose. The solid diamonds are the average of the measured data points for the samples irradiated under electrical bias and the black lines (solid and/or dashed) are the average of the data points after application of the KTL statistics on the samples irradiated under electrical bias. The red dotted line(s) are the pre- and/or post-irradiation minimum and/or maximum specification value as defined in the datasheet and/or test plan.



**RLAT Report
10-326 100808 R1.0**

**Radiation Assured Devices
5017 N. 30th Street
Colorado Springs, CO 80919
(719) 531-0800**

Table 5.112. Raw data for Channel Separation @5V 2:1 (dB) versus total dose, including the statistical analysis, specification and the status of the testing (pass/fail).

Channel Separation @5V 2:1 (dB)	Total Dose (krad(Si))											
	0	10	20	30	40	50	60	70	75	100	200	
Device												
1245	1.09E+02	1.26E+02	1.36E+02	1.23E+02	1.13E+02	1.12E+02	1.06E+02	1.17E+02	1.07E+02	9.81E+01	1.12E+02	
1246	1.26E+02	9.98E+01	1.00E+02	1.04E+02	1.01E+02	1.05E+02	1.15E+02	1.08E+02	1.00E+02	1.25E+02	9.80E+01	
1247	1.14E+02	9.80E+01	9.90E+01	1.12E+02	1.10E+02	1.09E+02	1.13E+02	1.07E+02	1.06E+02	9.98E+01	9.81E+01	
1248	1.08E+02	1.14E+02	1.00E+02	9.68E+01	1.08E+02	1.05E+02	1.08E+02	1.04E+02	1.05E+02	9.91E+01	1.01E+02	
1249	1.16E+02	1.04E+02	1.14E+02	1.14E+02	1.09E+02	1.01E+02	1.11E+02	1.00E+02	1.02E+02	1.28E+02	1.13E+02	
1250	1.10E+02	1.24E+02	1.02E+02	9.97E+01	9.81E+01	1.09E+02	1.12E+02	1.24E+02	1.05E+02	1.03E+02	1.01E+02	
1251	9.77E+01	1.02E+02	1.08E+02	1.20E+02	9.80E+01	1.04E+02	1.10E+02	1.16E+02	1.24E+02	1.07E+02	1.12E+02	
1261	1.08E+02	1.04E+02	1.18E+02	1.17E+02	1.30E+02	1.01E+02	1.01E+02	1.07E+02	1.14E+02	1.02E+02	9.57E+01	
1262	1.00E+02	1.07E+02	1.05E+02	1.08E+02	1.06E+02	1.06E+02	1.03E+02	1.42E+02	9.49E+01	1.13E+02	1.06E+02	
1263	1.06E+02	1.07E+02	1.03E+02	9.76E+01	1.10E+02	1.14E+02	1.55E+02	1.03E+02	1.02E+02	1.17E+02	1.02E+02	
1264	1.12E+02	1.03E+02	1.50E+02	9.85E+01	9.63E+01	1.21E+02	1.23E+02	1.14E+02	1.03E+02	1.16E+02	1.13E+02	
1265	1.21E+02	1.09E+02	1.09E+02	1.01E+02	1.02E+02	1.05E+02	1.08E+02	1.01E+02	1.06E+02	1.11E+02	1.05E+02	
Biased Statistics												
Average Biased	1.09E+02	1.09E+02	1.09E+02	1.09E+02	1.08E+02	1.07E+02	1.13E+02	1.13E+02	1.06E+02	1.09E+02	1.04E+02	
Std Dev Biased	7.98E+00	9.56E+00	1.16E+01	9.47E+00	9.26E+00	4.32E+00	1.54E+01	1.26E+01	8.05E+00	1.08E+01	6.47E+00	
Ps90%/90% (+KTL) Biased	1.26E+02	1.28E+02	1.32E+02	1.29E+02	1.27E+02	1.16E+02	1.45E+02	1.39E+02	1.22E+02	1.31E+02	1.17E+02	
Ps90%/90% (-KTL) Biased	9.29E+01	8.88E+01	8.46E+01	8.97E+01	8.92E+01	9.77E+01	8.16E+01	8.68E+01	8.92E+01	8.67E+01	9.06E+01	
Specification MIN	8.10E+01	8.10E+01	8.10E+01	8.10E+01	8.10E+01	8.10E+01	8.10E+01	8.10E+01	8.10E+01	8.10E+01	8.10E+01	
Status	PASS	PASS	PASS	PASS	PASS	PASS	PASS	PASS	PASS	PASS	PASS	

An ISO 9001:2008 and DSCC Certified Company

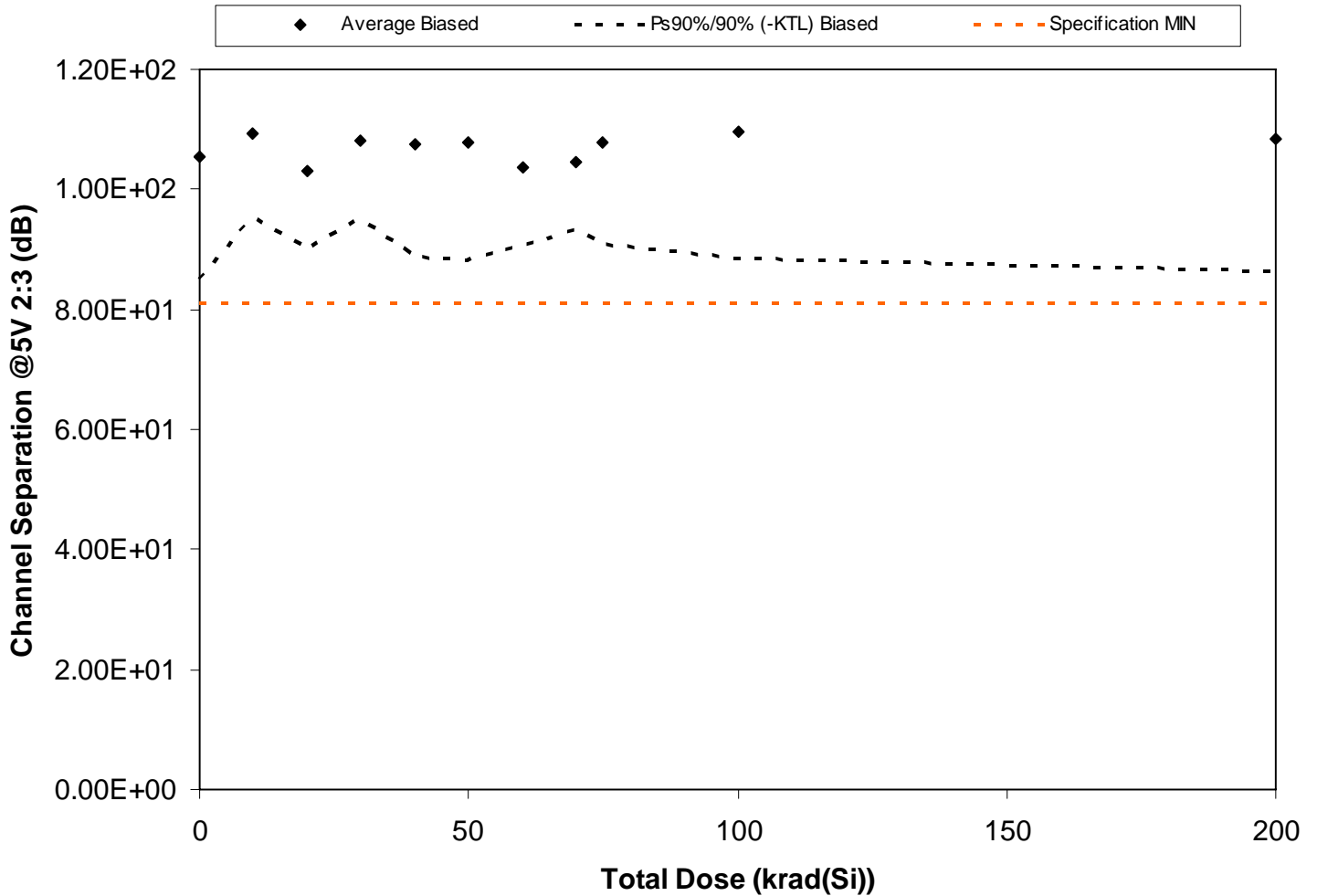

Figure 5.113. Plot of Channel Separation @5V 2:3 (dB) versus total dose. The solid diamonds are the average of the measured data points for the samples irradiated under electrical bias and the black lines (solid and/or dashed) are the average of the data points after application of the KTL statistics on the samples irradiated under electrical bias. The red dotted line(s) are the pre- and/or post-irradiation minimum and/or maximum specification value as defined in the datasheet and/or test plan.



**RLAT Report
10-326 100808 R1.0**

**Radiation Assured Devices
5017 N. 30th Street
Colorado Springs, CO 80919
(719) 531-0800**

Table 5.113. Raw data for Channel Separation @5V 2:3 (dB) versus total dose, including the statistical analysis, specification and the status of the testing (pass/fail).

Channel Separation @5V 2:3 (dB)	Total Dose (krad(Si))											
	0	10	20	30	40	50	60	70	75	100	200	
Device												
1245	1.04E+02	1.13E+02	1.13E+02	1.12E+02	1.01E+02	9.82E+01	1.01E+02	1.03E+02	1.13E+02	1.00E+02	1.03E+02	
1246	1.03E+02	1.12E+02	9.88E+01	1.04E+02	9.99E+01	1.07E+02	1.06E+02	1.12E+02	1.04E+02	1.15E+02	9.51E+01	
1247	1.02E+02	1.08E+02	1.06E+02	1.02E+02	9.82E+01	1.26E+02	1.07E+02	1.10E+02	1.03E+02	1.13E+02	1.04E+02	
1248	1.06E+02	9.69E+01	9.79E+01	1.03E+02	1.27E+02	1.16E+02	1.17E+02	1.11E+02	1.16E+02	1.20E+02	9.76E+01	
1249	1.03E+02	1.14E+02	9.66E+01	1.06E+02	1.07E+02	1.05E+02	9.70E+01	9.86E+01	9.92E+01	1.02E+02	1.15E+02	
1250	1.07E+02	1.00E+02	9.64E+01	1.05E+02	1.08E+02	1.08E+02	1.10E+02	1.00E+02	1.20E+02	1.12E+02	1.08E+02	
1251	9.66E+01	1.08E+02	1.09E+02	1.15E+02	1.16E+02	1.00E+02	1.01E+02	1.02E+02	9.93E+01	1.01E+02	1.34E+02	
1261	1.07E+02	1.20E+02	1.12E+02	1.21E+02	1.14E+02	1.18E+02	1.04E+02	1.06E+02	1.17E+02	1.29E+02	1.09E+02	
1262	1.32E+02	1.13E+02	1.00E+02	1.12E+02	1.00E+02	1.02E+02	9.62E+01	1.07E+02	9.93E+01	1.13E+02	1.09E+02	
1263	9.58E+01	1.09E+02	1.00E+02	1.02E+02	1.05E+02	9.73E+01	9.81E+01	9.60E+01	1.06E+02	9.49E+01	1.10E+02	
1264	1.21E+02	1.07E+02	1.16E+02	1.18E+02	9.57E+01	1.09E+02	1.23E+02	1.29E+02	1.22E+02	9.71E+01	1.01E+02	
1265	9.85E+01	1.25E+02	1.19E+02	1.09E+02	1.10E+02	1.35E+02	1.39E+02	1.17E+02	1.06E+02	1.36E+02	1.01E+02	
Biased Statistics												
Average Biased	1.06E+02	1.09E+02	1.03E+02	1.08E+02	1.07E+02	1.08E+02	1.04E+02	1.05E+02	1.08E+02	1.10E+02	1.08E+02	
Std Dev Biased	9.94E+00	6.72E+00	6.35E+00	6.37E+00	9.06E+00	9.50E+00	6.44E+00	5.48E+00	8.11E+00	1.03E+01	1.06E+01	
Ps90%/90% (+KTL) Biased	1.26E+02	1.23E+02	1.16E+02	1.21E+02	1.26E+02	1.27E+02	1.17E+02	1.16E+02	1.25E+02	1.31E+02	1.30E+02	
Ps90%/90% (-KTL) Biased	8.51E+01	9.54E+01	8.99E+01	9.51E+01	8.87E+01	8.82E+01	9.04E+01	9.32E+01	9.10E+01	8.85E+01	8.64E+01	
Specification MIN	8.10E+01	8.10E+01	8.10E+01	8.10E+01	8.10E+01	8.10E+01	8.10E+01	8.10E+01	8.10E+01	8.10E+01	8.10E+01	
Status	PASS	PASS	PASS	PASS	PASS	PASS	PASS	PASS	PASS	PASS	PASS	

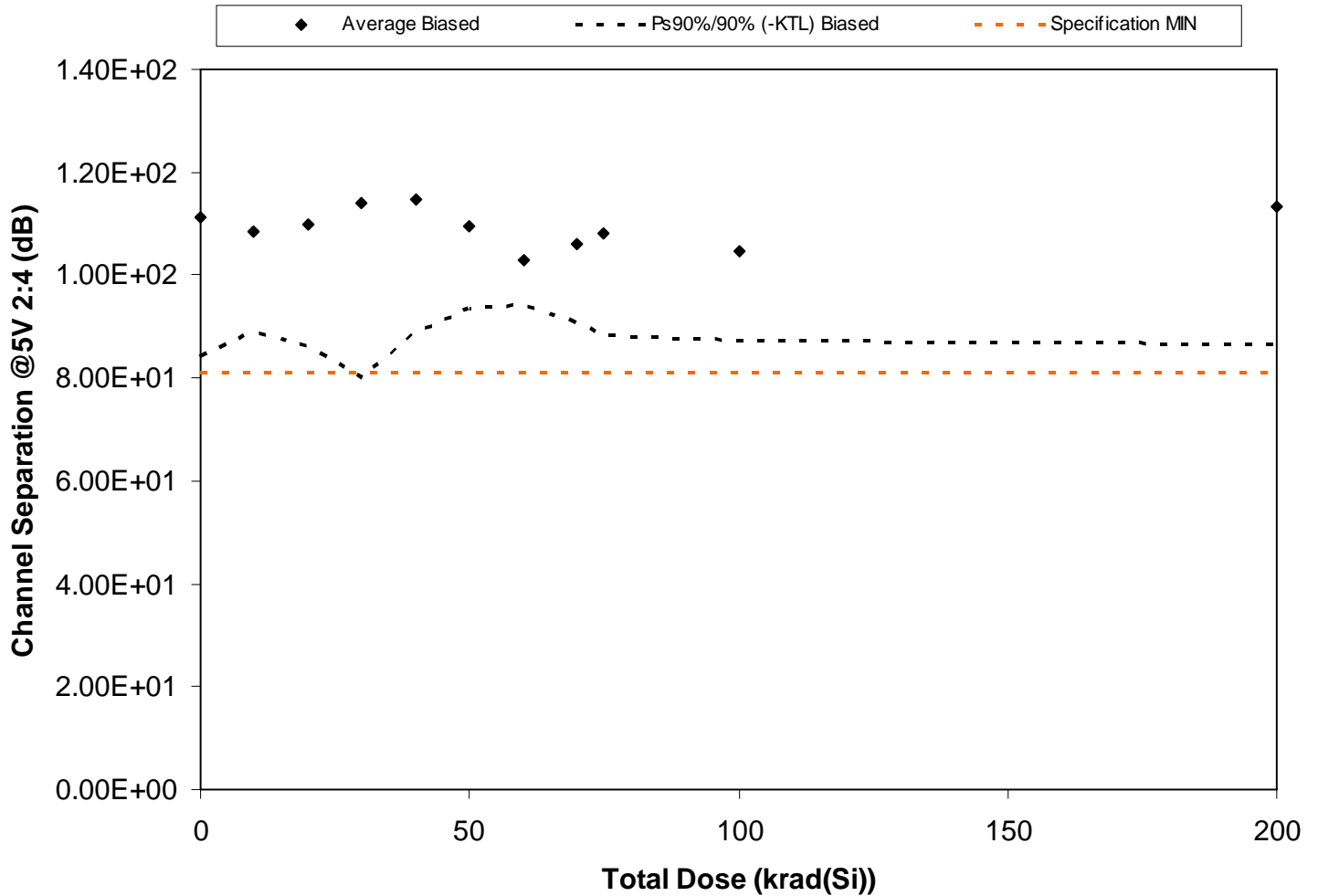

Figure 5.114. Plot of Channel Separation @5V 2:4 (dB) versus total dose. The solid diamonds are the average of the measured data points for the samples irradiated under electrical bias and the black lines (solid and/or dashed) are the average of the data points after application of the KTL statistics on the samples irradiated under electrical bias. The red dotted line(s) are the pre- and/or post-irradiation minimum and/or maximum specification value as defined in the datasheet and/or test plan.



Table 5.114. Raw data for Channel Separation @5V 2:4 (dB) versus total dose, including the statistical analysis, specification and the status of the testing (pass/fail).

Channel Separation @5V 2:4 (dB)	Total Dose (krad(Si))											
	0	10	20	30	40	50	60	70	75	100	200	
Device												
1245	1.01E+02	1.07E+02	1.19E+02	1.06E+02	1.19E+02	1.17E+02	1.02E+02	1.01E+02	9.33E+01	1.07E+02	1.30E+02	
1246	1.39E+02	1.01E+02	1.02E+02	1.11E+02	1.24E+02	1.16E+02	1.01E+02	1.12E+02	1.13E+02	9.64E+01	9.87E+01	
1247	1.03E+02	1.17E+02	1.02E+02	9.83E+01	1.29E+02	1.15E+02	1.06E+02	1.10E+02	1.01E+02	1.00E+02	1.21E+02	
1248	1.02E+02	9.38E+01	1.34E+02	1.04E+02	1.07E+02	1.01E+02	1.02E+02	1.01E+02	1.00E+02	9.68E+01	1.22E+02	
1249	1.04E+02	1.07E+02	9.84E+01	9.85E+01	9.80E+01	1.12E+02	1.10E+02	1.20E+02	9.94E+01	9.86E+01	1.27E+02	
1250	1.13E+02	1.13E+02	1.13E+02	1.42E+02	1.34E+02	1.15E+02	9.89E+01	1.09E+02	1.18E+02	1.02E+02	1.04E+02	
1251	1.01E+02	1.26E+02	1.05E+02	1.43E+02	1.06E+02	1.10E+02	1.07E+02	9.83E+01	1.24E+02	1.12E+02	1.07E+02	
1261	1.27E+02	1.02E+02	1.15E+02	1.20E+02	1.02E+02	1.09E+02	1.07E+02	9.80E+01	1.06E+02	1.24E+02	9.99E+01	
1262	1.03E+02	1.14E+02	9.71E+01	1.07E+02	1.24E+02	9.29E+01	9.68E+01	1.00E+02	1.11E+02	1.04E+02	9.86E+01	
1263	1.17E+02	1.04E+02	1.12E+02	1.10E+02	1.06E+02	1.07E+02	9.98E+01	1.11E+02	1.15E+02	1.06E+02	1.26E+02	
1264	1.34E+02	1.11E+02	9.95E+01	1.14E+02	9.72E+01	9.86E+01	1.09E+02	1.11E+02	1.07E+02	9.93E+01	1.00E+02	
1265	1.08E+02	1.01E+02	1.07E+02	1.29E+02	1.05E+02	1.03E+02	1.08E+02	9.68E+01	9.76E+01	1.12E+02	1.11E+02	
Biased Statistics												
Average Biased	1.11E+02	1.08E+02	1.10E+02	1.14E+02	1.15E+02	1.09E+02	1.03E+02	1.06E+02	1.08E+02	1.05E+02	1.13E+02	
Std Dev Biased	1.31E+01	9.30E+00	1.13E+01	1.64E+01	1.25E+01	7.69E+00	4.21E+00	7.42E+00	9.59E+00	8.38E+00	1.30E+01	
Ps90%/90% (+KTL) Biased	1.38E+02	1.28E+02	1.33E+02	1.48E+02	1.41E+02	1.25E+02	1.12E+02	1.21E+02	1.28E+02	1.22E+02	1.40E+02	
Ps90%/90% (-KTL) Biased	8.40E+01	8.92E+01	8.63E+01	8.00E+01	8.89E+01	9.36E+01	9.43E+01	9.07E+01	8.82E+01	8.75E+01	8.67E+01	
Specification MIN	8.10E+01	8.10E+01	8.10E+01	8.10E+01	8.10E+01	8.10E+01	8.10E+01	8.10E+01	8.10E+01	8.10E+01	8.10E+01	
Status	PASS	PASS	PASS	PASS	PASS	PASS	PASS	PASS	PASS	PASS	PASS	

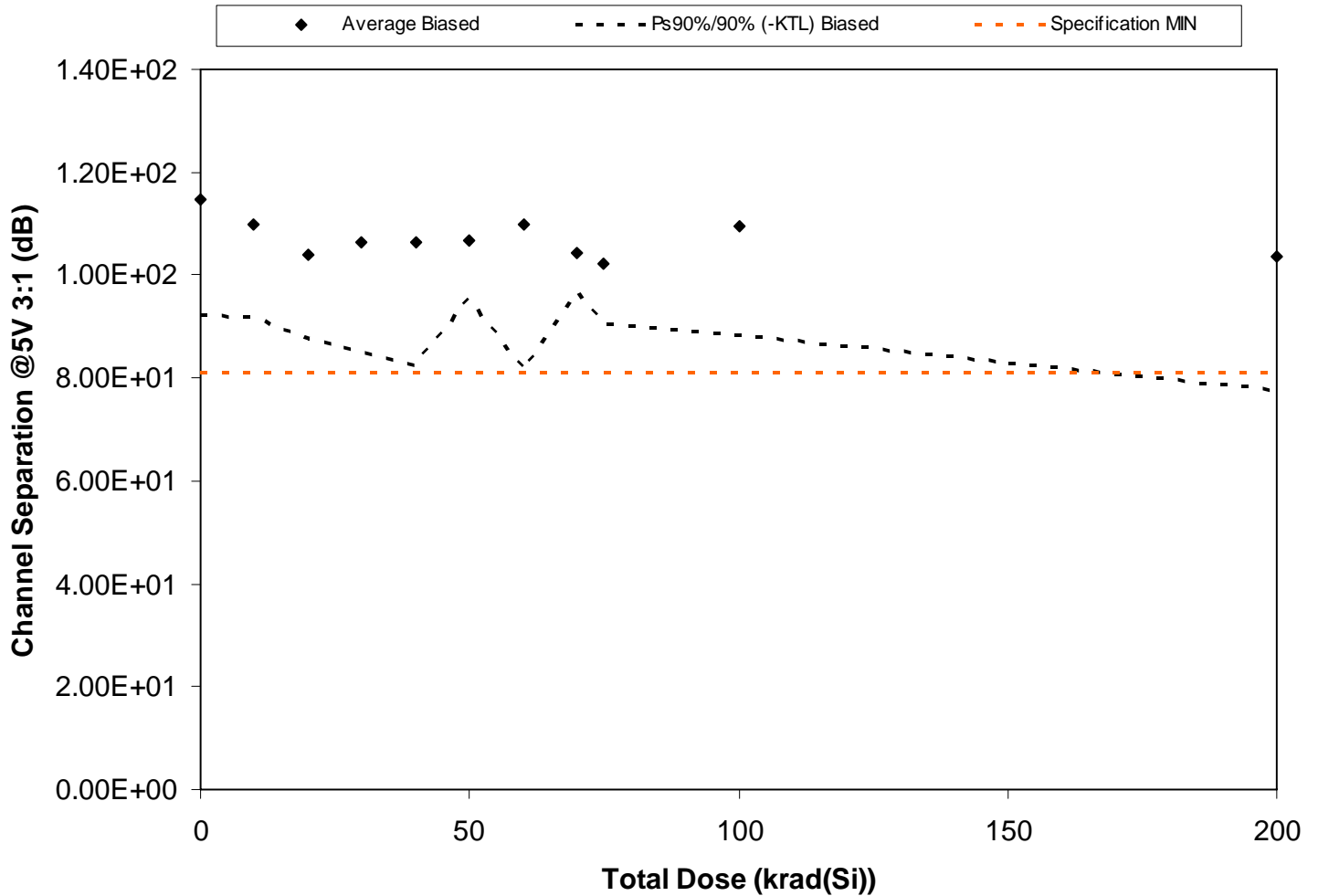

Figure 5.115. Plot of Channel Separation @5V 3:1 (dB) versus total dose. The solid diamonds are the average of the measured data points for the samples irradiated under electrical bias and the black lines (solid and/or dashed) are the average of the data points after application of the KTL statistics on the samples irradiated under electrical bias. The red dotted line(s) are the pre- and/or post-irradiation minimum and/or maximum specification value as defined in the datasheet and/or test plan.



**RLAT Report
10-326 100808 R1.0**

**Radiation Assured Devices
5017 N. 30th Street
Colorado Springs, CO 80919
(719) 531-0800**

Table 5.115. Raw data for Channel Separation @5V 3:1 (dB) versus total dose, including the statistical analysis, specification and the status of the testing (pass/fail).

Channel Separation @5V 3:1 (dB)	Total Dose (krad(Si))											
	0	10	20	30	40	50	60	70	75	100	200	
Device												
1245	1.09E+02	1.07E+02	1.14E+02	9.93E+01	9.91E+01	1.02E+02	9.70E+01	1.04E+02	1.02E+02	1.31E+02	1.34E+02	
1246	1.14E+02	1.14E+02	1.03E+02	9.82E+01	1.01E+02	1.16E+02	1.34E+02	9.66E+01	1.10E+02	1.16E+02	9.53E+01	
1247	1.24E+02	1.10E+02	9.47E+01	9.66E+01	1.12E+02	1.02E+02	1.20E+02	1.02E+02	1.01E+02	1.00E+02	1.09E+02	
1248	1.18E+02	1.12E+02	1.07E+02	1.05E+02	1.18E+02	1.13E+02	9.37E+01	1.09E+02	9.45E+01	1.04E+02	9.92E+01	
1249	1.39E+02	1.04E+02	9.96E+01	1.27E+02	9.39E+01	1.10E+02	1.04E+02	1.04E+02	1.02E+02	9.95E+01	9.38E+01	
1250	1.15E+02	1.03E+02	9.92E+01	1.06E+02	1.29E+02	1.00E+02	1.06E+02	1.03E+02	9.78E+01	1.01E+02	9.33E+01	
1251	1.11E+02	1.03E+02	1.20E+02	1.02E+02	9.69E+01	1.07E+02	9.84E+01	1.09E+02	9.61E+01	1.08E+02	1.01E+02	
1261	1.10E+02	1.28E+02	9.69E+01	1.00E+02	1.16E+02	1.04E+02	1.04E+02	1.07E+02	1.06E+02	1.17E+02	9.99E+01	
1262	1.06E+02	9.92E+01	1.00E+02	1.07E+02	9.63E+01	1.10E+02	1.12E+02	1.06E+02	1.03E+02	1.03E+02	9.79E+01	
1263	1.01E+02	1.19E+02	1.05E+02	1.22E+02	1.03E+02	1.02E+02	1.28E+02	1.03E+02	1.12E+02	1.17E+02	1.15E+02	
1264	1.05E+02	9.56E+01	1.07E+02	1.13E+02	9.86E+01	1.08E+02	1.00E+02	9.70E+01	9.92E+01	1.05E+02	9.76E+01	
1265	9.59E+01	1.01E+02	1.04E+02	1.02E+02	1.08E+02	1.11E+02	1.14E+02	1.06E+02	1.09E+02	1.10E+02	1.01E+02	
Biased Statistics												
Average Biased	1.15E+02	1.10E+02	1.04E+02	1.06E+02	1.06E+02	1.07E+02	1.10E+02	1.04E+02	1.02E+02	1.10E+02	1.04E+02	
Std Dev Biased	1.08E+01	8.75E+00	7.82E+00	1.04E+01	1.15E+01	5.52E+00	1.36E+01	3.64E+00	5.72E+00	1.03E+01	1.26E+01	
Ps90%/90% (+KTL) Biased	1.37E+02	1.28E+02	1.20E+02	1.28E+02	1.30E+02	1.18E+02	1.38E+02	1.12E+02	1.14E+02	1.31E+02	1.30E+02	
Ps90%/90% (-KTL) Biased	9.22E+01	9.18E+01	8.77E+01	8.49E+01	8.26E+01	9.53E+01	8.16E+01	9.68E+01	9.06E+01	8.83E+01	7.77E+01	
Specification MIN	8.10E+01	8.10E+01	8.10E+01	8.10E+01	8.10E+01	8.10E+01	8.10E+01	8.10E+01	8.10E+01	8.10E+01	8.10E+01	
Status	PASS	PASS	PASS	PASS	PASS	PASS	PASS	PASS	PASS	PASS	PASS	

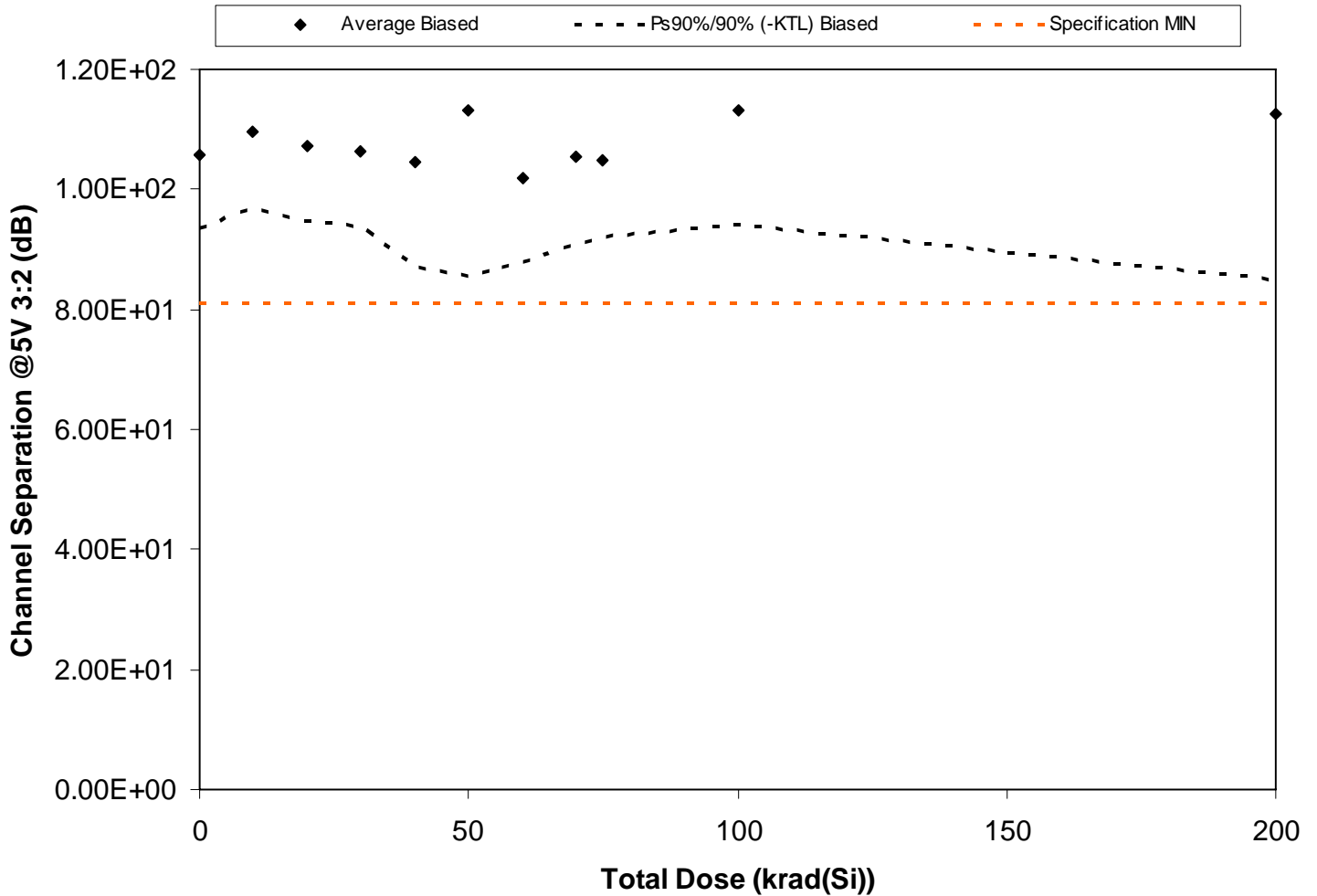

Figure 5.116. Plot of Channel Separation @5V 3:2 (dB) versus total dose. The solid diamonds are the average of the measured data points for the samples irradiated under electrical bias and the black lines (solid and/or dashed) are the average of the data points after application of the KTL statistics on the samples irradiated under electrical bias. The red dotted line(s) are the pre- and/or post-irradiation minimum and/or maximum specification value as defined in the datasheet and/or test plan.



**RLAT Report
10-326 100808 R1.0**

**Radiation Assured Devices
5017 N. 30th Street
Colorado Springs, CO 80919
(719) 531-0800**

Table 5.116. Raw data for Channel Separation @5V 3:2 (dB) versus total dose, including the statistical analysis, specification and the status of the testing (pass/fail).

Channel Separation @5V 3:2 (dB)	Total Dose (krad(Si))											
	0	10	20	30	40	50	60	70	75	100	200	
Device												
1245	1.07E+02	1.01E+02	9.81E+01	1.20E+02	9.95E+01	1.07E+02	9.41E+01	1.03E+02	1.06E+02	1.22E+02	1.02E+02	
1246	1.14E+02	1.07E+02	1.12E+02	1.03E+02	9.42E+01	1.16E+02	1.02E+02	1.07E+02	1.05E+02	1.19E+02	1.03E+02	
1247	9.98E+01	1.03E+02	1.09E+02	1.04E+02	9.76E+01	1.09E+02	1.11E+02	9.50E+01	1.01E+02	1.09E+02	1.28E+02	
1248	1.17E+02	1.13E+02	1.02E+02	1.10E+02	1.14E+02	1.36E+02	1.03E+02	1.21E+02	1.14E+02	1.10E+02	1.42E+02	
1249	1.03E+02	1.09E+02	1.10E+02	1.08E+02	1.04E+02	1.15E+02	1.01E+02	1.08E+02	1.02E+02	1.11E+02	1.12E+02	
1250	1.04E+02	1.16E+02	1.09E+02	1.00E+02	9.83E+01	1.05E+02	1.12E+02	1.07E+02	1.13E+02	1.08E+02	1.04E+02	
1251	1.02E+02	1.09E+02	1.06E+02	1.08E+02	1.09E+02	1.02E+02	9.52E+01	1.10E+02	1.11E+02	1.30E+02	1.11E+02	
1261	9.87E+01	1.04E+02	1.01E+02	1.01E+02	1.22E+02	1.37E+02	1.06E+02	1.01E+02	1.02E+02	9.63E+01	1.00E+02	
1262	1.03E+02	1.13E+02	1.08E+02	1.09E+02	1.01E+02	9.98E+01	9.21E+01	9.98E+01	9.66E+01	1.11E+02	1.06E+02	
1263	1.08E+02	1.21E+02	1.20E+02	1.01E+02	1.06E+02	1.04E+02	1.02E+02	1.02E+02	9.85E+01	1.19E+02	1.18E+02	
1264	1.02E+02	1.11E+02	1.01E+02	1.14E+02	1.05E+02	1.03E+02	1.07E+02	9.55E+01	1.15E+02	1.04E+02	1.04E+02	
1265	9.99E+01	1.00E+02	1.11E+02	1.25E+02	9.70E+01	1.15E+02	1.03E+02	1.10E+02	9.83E+01	1.16E+02	1.07E+02	
Biased Statistics												
Average Biased	1.06E+02	1.10E+02	1.07E+02	1.06E+02	1.05E+02	1.13E+02	1.02E+02	1.05E+02	1.05E+02	1.13E+02	1.13E+02	
Std Dev Biased	5.90E+00	6.25E+00	6.10E+00	6.10E+00	8.42E+00	1.34E+01	6.80E+00	7.06E+00	6.10E+00	9.28E+00	1.33E+01	
Ps90%/90% (+KTL) Biased	1.18E+02	1.23E+02	1.20E+02	1.19E+02	1.22E+02	1.41E+02	1.16E+02	1.20E+02	1.17E+02	1.32E+02	1.40E+02	
Ps90%/90% (-KTL) Biased	9.35E+01	9.67E+01	9.47E+01	9.38E+01	8.71E+01	8.55E+01	8.78E+01	9.08E+01	9.22E+01	9.41E+01	8.50E+01	
Specification MIN	8.10E+01	8.10E+01	8.10E+01	8.10E+01	8.10E+01	8.10E+01	8.10E+01	8.10E+01	8.10E+01	8.10E+01	8.10E+01	
Status	PASS	PASS	PASS	PASS	PASS	PASS	PASS	PASS	PASS	PASS	PASS	

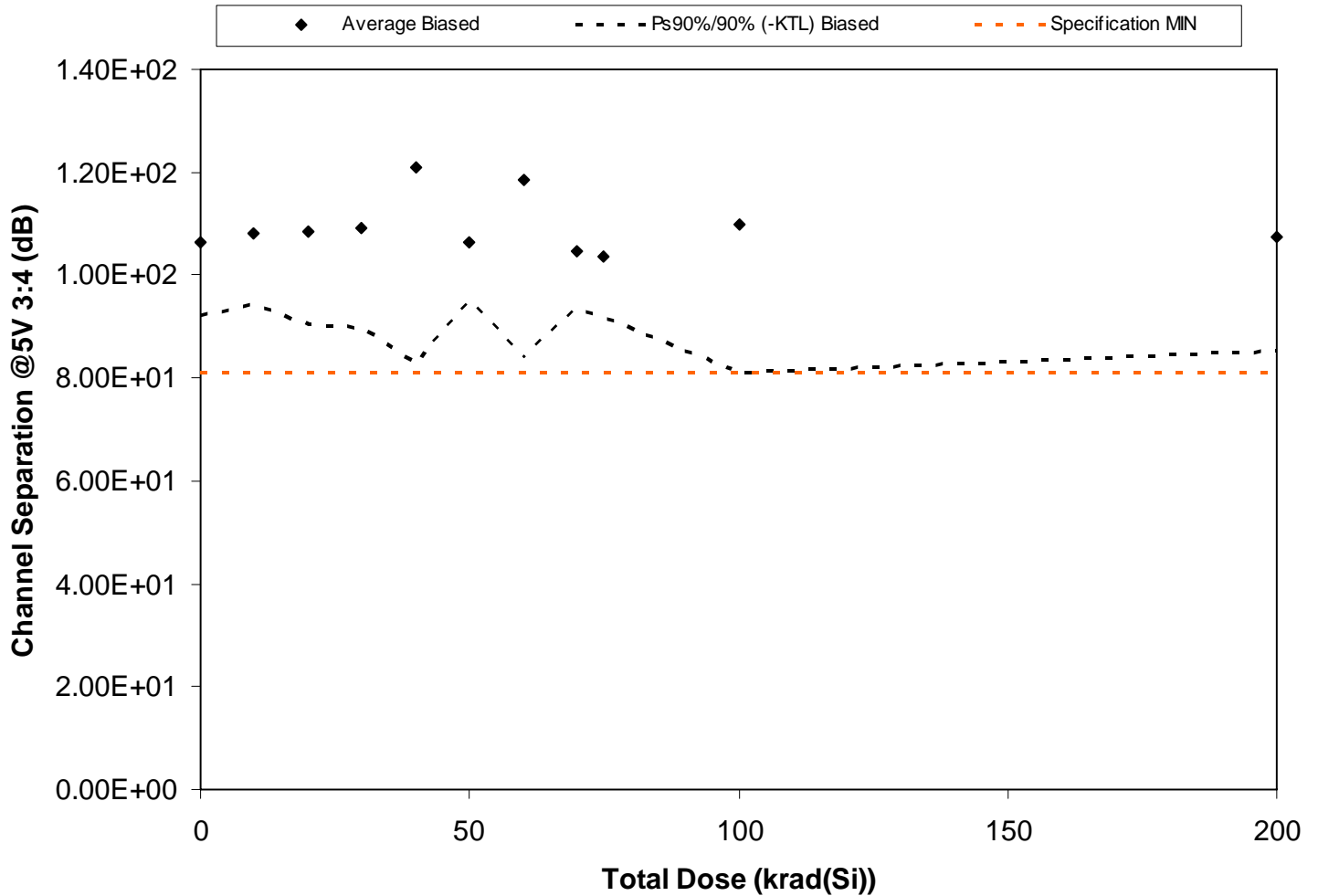

Figure 5.117. Plot of Channel Separation @5V 3:4 (dB) versus total dose. The solid diamonds are the average of the measured data points for the samples irradiated under electrical bias and the black lines (solid and/or dashed) are the average of the data points after application of the KTL statistics on the samples irradiated under electrical bias. The red dotted line(s) are the pre- and/or post-irradiation minimum and/or maximum specification value as defined in the datasheet and/or test plan.



**RLAT Report
10-326 100808 R1.0**

**Radiation Assured Devices
5017 N. 30th Street
Colorado Springs, CO 80919
(719) 531-0800**

Table 5.117. Raw data for Channel Separation @5V 3:4 (dB) versus total dose, including the statistical analysis, specification and the status of the testing (pass/fail).

Channel Separation @5V 3:4 (dB)	Total Dose (krad(Si))											
	0	10	20	30	40	50	60	70	75	100	200	
Device												
1245	1.16E+02	1.02E+02	1.13E+02	1.15E+02	1.58E+02	1.15E+02	1.20E+02	9.82E+01	1.02E+02	9.75E+01	1.10E+02	
1246	9.82E+01	1.18E+02	1.25E+02	1.04E+02	1.23E+02	9.91E+01	1.02E+02	1.10E+02	1.05E+02	1.37E+02	9.34E+01	
1247	1.15E+02	1.01E+02	9.89E+01	9.93E+01	1.14E+02	1.11E+02	1.31E+02	1.04E+02	1.13E+02	1.02E+02	1.31E+02	
1248	1.14E+02	1.10E+02	1.19E+02	1.27E+02	1.01E+02	1.04E+02	9.97E+01	9.97E+01	9.87E+01	1.01E+02	9.50E+01	
1249	1.09E+02	1.02E+02	1.06E+02	1.06E+02	1.49E+02	1.02E+02	1.18E+02	1.16E+02	1.01E+02	1.26E+02	1.01E+02	
1250	1.08E+02	1.07E+02	9.79E+01	1.21E+02	1.20E+02	1.09E+02	1.09E+02	1.01E+02	1.06E+02	1.03E+02	1.13E+02	
1251	9.80E+01	1.02E+02	1.06E+02	1.10E+02	1.06E+02	1.13E+02	1.31E+02	1.07E+02	1.13E+02	9.96E+01	1.03E+02	
1261	1.02E+02	1.13E+02	1.02E+02	9.67E+01	1.16E+02	9.90E+01	1.38E+02	1.01E+02	9.65E+01	1.25E+02	1.14E+02	
1262	1.05E+02	1.18E+02	1.04E+02	1.05E+02	1.09E+02	1.06E+02	9.42E+01	1.03E+02	1.05E+02	1.04E+02	1.11E+02	
1263	1.00E+02	1.07E+02	1.13E+02	1.08E+02	1.14E+02	1.08E+02	1.42E+02	1.07E+02	9.70E+01	1.03E+02	1.06E+02	
1264	1.06E+02	1.06E+02	1.23E+02	9.27E+01	1.04E+02	9.43E+01	1.15E+02	1.06E+02	1.13E+02	1.35E+02	9.88E+01	
1265	1.15E+02	9.55E+01	1.02E+02	1.23E+02	1.05E+02	1.17E+02	1.12E+02	9.90E+01	1.34E+02	1.03E+02	1.17E+02	
Biased Statistics												
Average Biased	1.06E+02	1.08E+02	1.08E+02	1.09E+02	1.21E+02	1.07E+02	1.19E+02	1.05E+02	1.04E+02	1.10E+02	1.08E+02	
Std Dev Biased	6.93E+00	6.63E+00	8.69E+00	9.49E+00	1.84E+01	5.54E+00	1.69E+01	5.43E+00	5.83E+00	1.38E+01	1.08E+01	
Ps90%/90% (+KTL) Biased	1.21E+02	1.22E+02	1.26E+02	1.29E+02	1.59E+02	1.18E+02	1.53E+02	1.16E+02	1.16E+02	1.38E+02	1.30E+02	
Ps90%/90% (-KTL) Biased	9.21E+01	9.43E+01	9.05E+01	8.96E+01	8.30E+01	9.51E+01	8.37E+01	9.35E+01	9.17E+01	8.11E+01	8.53E+01	
Specification MIN	8.10E+01	8.10E+01	8.10E+01	8.10E+01	8.10E+01	8.10E+01	8.10E+01	8.10E+01	8.10E+01	8.10E+01	8.10E+01	
Status	PASS	PASS	PASS	PASS	PASS	PASS	PASS	PASS	PASS	PASS	PASS	

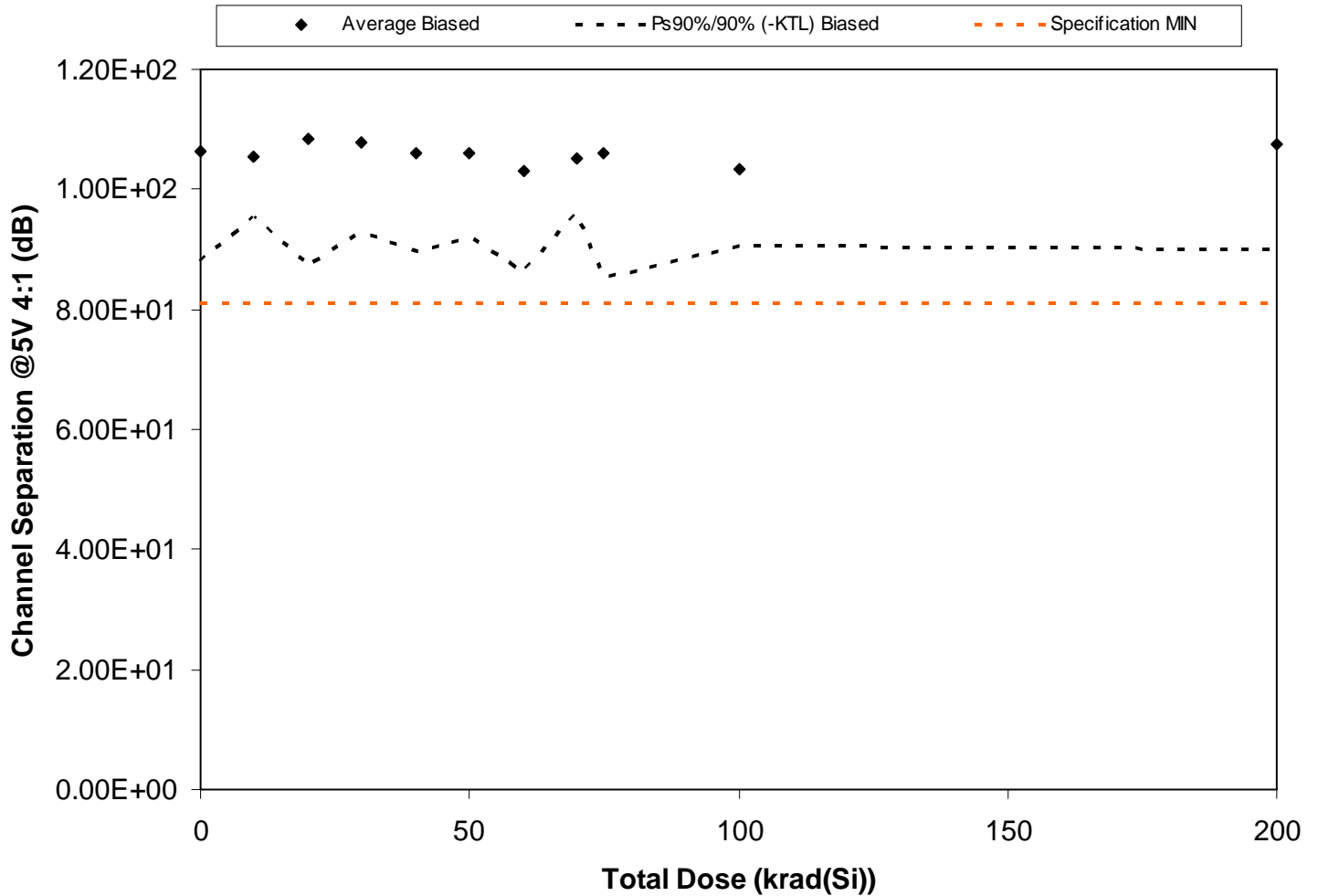

Figure 5.118. Plot of Channel Separation @5V 4:1 (dB) versus total dose. The solid diamonds are the average of the measured data points for the samples irradiated under electrical bias and the black lines (solid and/or dashed) are the average of the data points after application of the KTL statistics on the samples irradiated under electrical bias. The red dotted line(s) are the pre- and/or post-irradiation minimum and/or maximum specification value as defined in the datasheet and/or test plan.



Table 5.118. Raw data for Channel Separation @5V 4:1 (dB) versus total dose, including the statistical analysis, specification and the status of the testing (pass/fail).

Channel Separation @5V 4:1 (dB)	Total Dose (krad(Si))											
	0	10	20	30	40	50	60	70	75	100	200	
Device												
1245	1.05E+02	9.84E+01	1.10E+02	9.83E+01	1.09E+02	1.06E+02	1.02E+02	1.11E+02	9.72E+01	9.78E+01	1.12E+02	
1246	9.88E+01	1.12E+02	1.01E+02	9.99E+01	1.03E+02	1.03E+02	9.91E+01	1.02E+02	1.02E+02	1.05E+02	1.14E+02	
1247	1.01E+02	1.09E+02	1.02E+02	1.10E+02	1.15E+02	1.00E+02	1.06E+02	9.92E+01	1.15E+02	9.47E+01	1.01E+02	
1248	1.09E+02	1.07E+02	1.05E+02	1.17E+02	9.69E+01	1.19E+02	1.13E+02	1.06E+02	1.25E+02	9.85E+01	1.06E+02	
1249	1.13E+02	1.10E+02	1.15E+02	1.03E+02	1.22E+02	1.13E+02	9.64E+01	1.10E+02	1.10E+02	1.01E+02	1.01E+02	
1250	1.28E+02	9.92E+01	1.08E+02	1.05E+02	9.71E+01	1.12E+02	1.12E+02	1.04E+02	9.31E+01	1.17E+02	1.02E+02	
1251	1.02E+02	1.02E+02	1.14E+02	1.13E+02	1.07E+02	1.01E+02	9.79E+01	1.08E+02	1.01E+02	1.03E+02	1.28E+02	
1261	1.01E+02	1.04E+02	1.05E+02	1.20E+02	1.07E+02	9.63E+01	1.16E+02	1.09E+02	1.09E+02	1.06E+02	1.01E+02	
1262	1.05E+02	1.11E+02	1.32E+02	1.06E+02	1.06E+02	1.07E+02	9.90E+01	1.00E+02	9.55E+01	1.05E+02	1.06E+02	
1263	9.96E+01	1.03E+02	9.37E+01	1.07E+02	9.81E+01	1.05E+02	9.06E+01	1.01E+02	1.13E+02	1.06E+02	1.05E+02	
1264	1.02E+02	1.12E+02	1.19E+02	1.17E+02	1.01E+02	1.29E+02	1.02E+02	1.24E+02	9.76E+01	9.76E+01	1.15E+02	
1265	1.09E+02	1.09E+02	1.24E+02	1.07E+02	1.14E+02	1.12E+02	1.13E+02	1.15E+02	1.22E+02	1.14E+02	9.73E+01	
Biased Statistics												
Average Biased	1.06E+02	1.06E+02	1.08E+02	1.08E+02	1.06E+02	1.06E+02	1.03E+02	1.05E+02	1.06E+02	1.03E+02	1.08E+02	
Std Dev Biased	8.86E+00	4.97E+00	1.02E+01	7.09E+00	7.97E+00	6.77E+00	8.22E+00	4.39E+00	1.00E+01	6.16E+00	8.47E+00	
Ps90%/90% (+KTL) Biased	1.24E+02	1.16E+02	1.30E+02	1.22E+02	1.23E+02	1.20E+02	1.20E+02	1.14E+02	1.27E+02	1.16E+02	1.25E+02	
Ps90%/90% (-KTL) Biased	8.79E+01	9.52E+01	8.73E+01	9.31E+01	8.96E+01	9.21E+01	8.61E+01	9.59E+01	8.54E+01	9.07E+01	9.01E+01	
Specification MIN	8.10E+01	8.10E+01	8.10E+01	8.10E+01	8.10E+01	8.10E+01	8.10E+01	8.10E+01	8.10E+01	8.10E+01	8.10E+01	
Status	PASS	PASS	PASS	PASS	PASS	PASS	PASS	PASS	PASS	PASS	PASS	

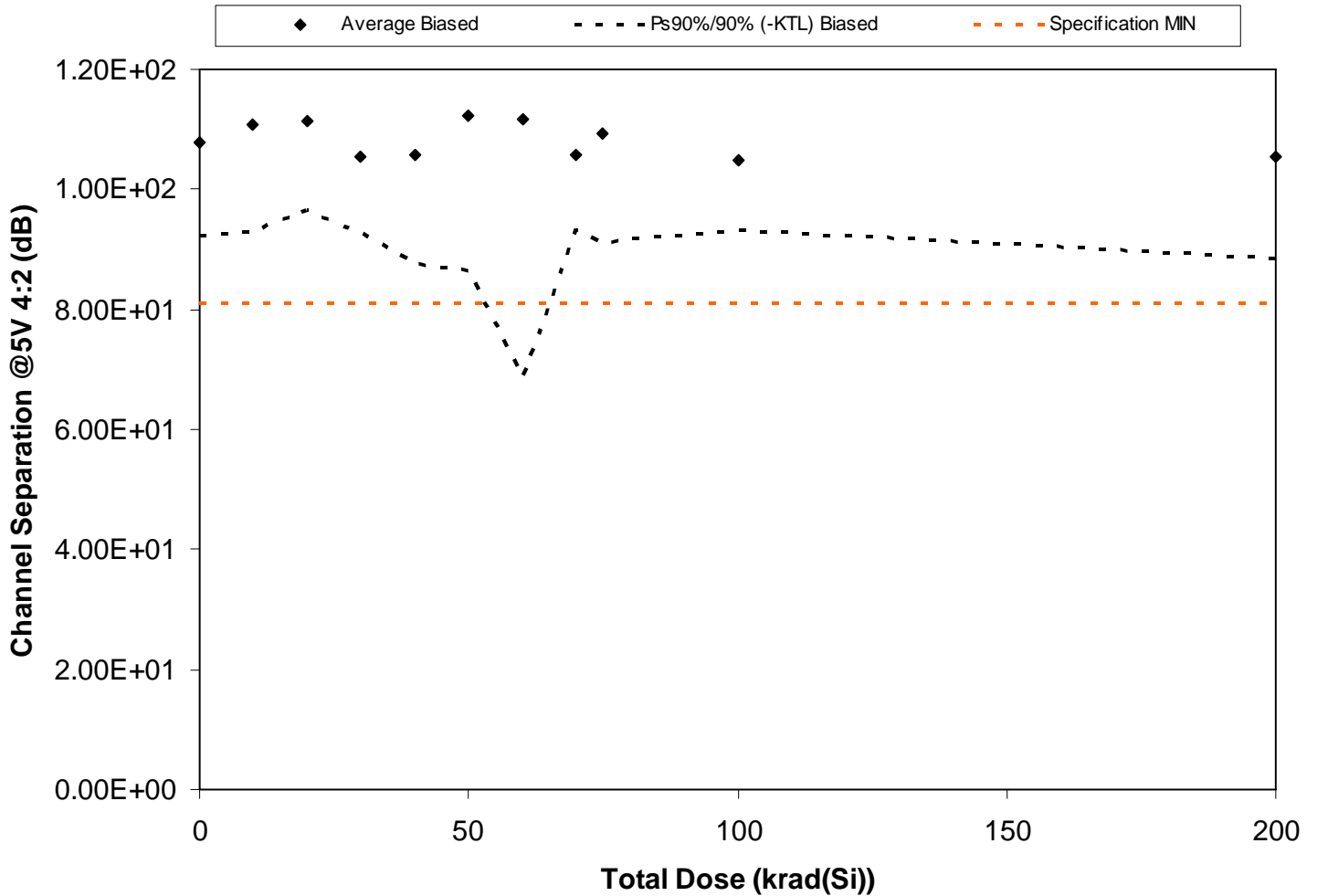

Figure 5.119. Plot of Channel Separation @5V 4:2 (dB) versus total dose. The solid diamonds are the average of the measured data points for the samples irradiated under electrical bias and the black lines (solid and/or dashed) are the average of the data points after application of the KTL statistics on the samples irradiated under electrical bias. The red dotted line(s) are the pre- and/or post-irradiation minimum and/or maximum specification value as defined in the datasheet and/or test plan.



**RLAT Report
10-326 100808 R1.0**

**Radiation Assured Devices
5017 N. 30th Street
Colorado Springs, CO 80919
(719) 531-0800**

Table 5.119. Raw data for Channel Separation @5V 4:2 (dB) versus total dose, including the statistical analysis, specification and the status of the testing (pass/fail).

Channel Separation @5V 4:2 (dB)	Total Dose (krad(Si))											
	0	10	20	30	40	50	60	70	75	100	200	
Device												
1245	1.06E+02	1.04E+02	1.08E+02	1.03E+02	1.04E+02	1.13E+02	1.67E+02	1.05E+02	1.14E+02	1.04E+02	9.44E+01	
1246	1.25E+02	1.03E+02	1.05E+02	1.08E+02	1.08E+02	1.09E+02	9.78E+01	1.13E+02	9.68E+01	1.09E+02	9.98E+01	
1247	1.15E+02	1.09E+02	1.16E+02	1.03E+02	9.68E+01	1.43E+02	1.03E+02	9.98E+01	1.10E+02	1.06E+02	1.04E+02	
1248	1.02E+02	1.26E+02	1.20E+02	1.03E+02	1.06E+02	1.05E+02	1.22E+02	1.02E+02	9.98E+01	1.01E+02	1.05E+02	
1249	1.04E+02	1.20E+02	1.04E+02	1.18E+02	1.23E+02	1.24E+02	1.12E+02	1.01E+02	1.13E+02	9.47E+01	1.08E+02	
1250	1.07E+02	1.19E+02	1.06E+02	9.45E+01	9.40E+01	1.07E+02	9.54E+01	1.03E+02	1.26E+02	9.91E+01	1.17E+02	
1251	1.00E+02	1.07E+02	1.03E+02	1.01E+02	1.05E+02	1.11E+02	1.04E+02	1.08E+02	1.03E+02	1.13E+02	1.17E+02	
1261	1.09E+02	1.02E+02	1.13E+02	1.05E+02	1.18E+02	1.08E+02	1.11E+02	1.14E+02	1.02E+02	1.11E+02	1.11E+02	
1262	1.02E+02	1.03E+02	1.24E+02	1.08E+02	1.00E+02	9.98E+01	1.00E+02	1.15E+02	1.12E+02	1.05E+02	9.51E+01	
1263	1.07E+02	1.15E+02	1.16E+02	1.09E+02	1.04E+02	1.05E+02	1.05E+02	9.84E+01	1.16E+02	1.06E+02	1.01E+02	
1264	1.04E+02	1.00E+02	1.13E+02	1.04E+02	1.05E+02	1.15E+02	1.12E+02	1.05E+02	1.06E+02	1.04E+02	1.01E+02	
1265	1.06E+02	1.00E+02	1.17E+02	1.01E+02	1.04E+02	1.20E+02	1.14E+02	1.02E+02	1.16E+02	9.90E+01	1.23E+02	
Biased Statistics												
Average Biased	1.08E+02	1.11E+02	1.12E+02	1.05E+02	1.06E+02	1.12E+02	1.12E+02	1.06E+02	1.09E+02	1.05E+02	1.05E+02	
Std Dev Biased	7.40E+00	8.65E+00	7.24E+00	6.17E+00	8.81E+00	1.25E+01	2.09E+01	6.11E+00	8.77E+00	5.53E+00	8.09E+00	
Ps90%/90% (+KTL) Biased	1.23E+02	1.29E+02	1.26E+02	1.18E+02	1.24E+02	1.38E+02	1.55E+02	1.18E+02	1.27E+02	1.16E+02	1.22E+02	
Ps90%/90% (-KTL) Biased	9.25E+01	9.28E+01	9.66E+01	9.26E+01	8.75E+01	8.66E+01	6.86E+01	9.33E+01	9.11E+01	9.34E+01	8.86E+01	
Specification MIN	8.10E+01	8.10E+01	8.10E+01	8.10E+01	8.10E+01	8.10E+01	8.10E+01	8.10E+01	8.10E+01	8.10E+01	8.10E+01	
Status	PASS	PASS	PASS	PASS	PASS	PASS	PASS	PASS	PASS	PASS	PASS	

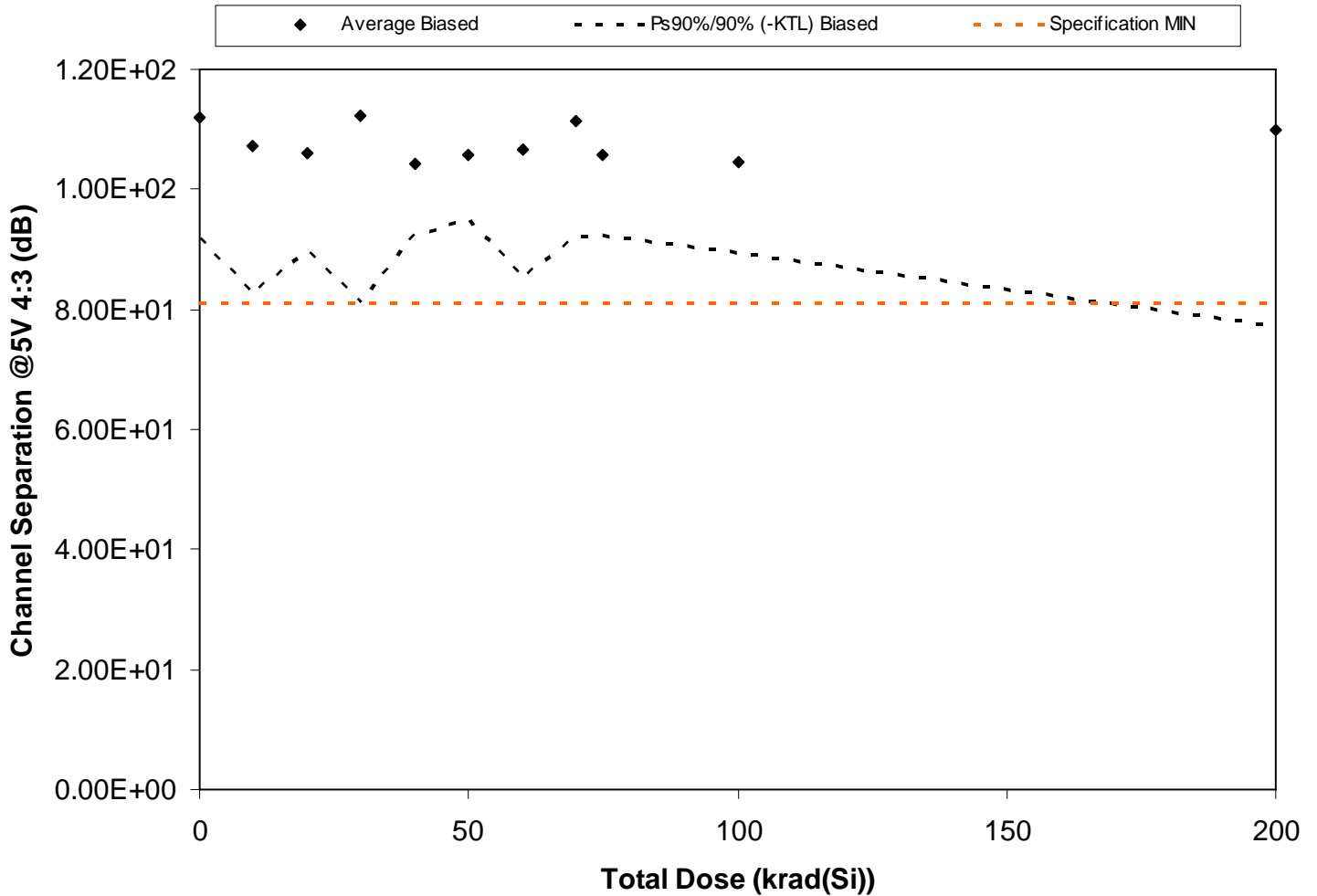

Figure 5.120. Plot of Channel Separation @5V 4:3 (dB) versus total dose. The solid diamonds are the average of the measured data points for the samples irradiated under electrical bias and the black lines (solid and/or dashed) are the average of the data points after application of the KTL statistics on the samples irradiated under electrical bias. The red dotted line(s) are the pre- and/or post-irradiation minimum and/or maximum specification value as defined in the datasheet and/or test plan.



**RLAT Report
10-326 100808 R1.0**

**Radiation Assured Devices
5017 N. 30th Street
Colorado Springs, CO 80919
(719) 531-0800**

Table 5.120. Raw data for Channel Separation @5V 4:3 (dB) versus total dose, including the statistical analysis, specification and the status of the testing (pass/fail).

Channel Separation @5V 4:3 (dB)	Total Dose (krad(Si))											
	0	10	20	30	40	50	60	70	75	100	200	
Device												
1245	1.10E+02	1.08E+02	9.92E+01	1.05E+02	9.91E+01	1.07E+02	1.07E+02	1.13E+02	1.13E+02	1.01E+02	9.89E+01	
1246	1.19E+02	1.25E+02	1.16E+02	1.09E+02	9.71E+01	1.01E+02	1.00E+02	1.05E+02	9.66E+01	1.02E+02	9.19E+01	
1247	1.26E+02	9.97E+01	1.01E+02	1.04E+02	1.07E+02	1.03E+02	1.08E+02	1.03E+02	1.05E+02	1.04E+02	1.05E+02	
1248	9.75E+01	1.04E+02	1.10E+02	1.09E+02	9.88E+01	9.77E+01	9.42E+01	1.18E+02	1.13E+02	9.96E+01	1.46E+02	
1249	1.09E+02	1.03E+02	1.04E+02	1.41E+02	1.03E+02	1.13E+02	1.08E+02	1.09E+02	1.07E+02	8.91E+01	1.04E+02	
1250	1.00E+02	1.33E+02	1.23E+02	9.77E+01	1.03E+02	1.03E+02	1.01E+02	1.11E+02	1.07E+02	1.09E+02	1.02E+02	
1251	1.24E+02	1.01E+02	9.74E+01	1.09E+02	1.08E+02	1.03E+02	1.28E+02	1.02E+02	9.78E+01	1.16E+02	1.12E+02	
1261	1.22E+02	9.88E+01	1.03E+02	1.01E+02	1.06E+02	1.08E+02	1.15E+02	1.34E+02	1.15E+02	1.10E+02	1.06E+02	
1262	1.11E+02	1.03E+02	1.05E+02	1.38E+02	1.17E+02	1.10E+02	1.13E+02	1.10E+02	1.02E+02	1.08E+02	1.04E+02	
1263	1.05E+02	9.82E+01	1.04E+02	1.08E+02	1.04E+02	1.13E+02	9.33E+01	1.12E+02	1.01E+02	1.07E+02	1.29E+02	
1264	1.27E+02	1.09E+02	1.17E+02	1.15E+02	1.15E+02	1.20E+02	1.08E+02	1.17E+02	1.02E+02	1.05E+02	1.12E+02	
1265	1.35E+02	9.73E+01	1.29E+02	1.03E+02	1.04E+02	1.41E+02	9.83E+01	1.15E+02	9.88E+01	1.02E+02	1.12E+02	
Biased Statistics												
Average Biased	1.12E+02	1.07E+02	1.06E+02	1.12E+02	1.04E+02	1.06E+02	1.07E+02	1.12E+02	1.06E+02	1.04E+02	1.10E+02	
Std Dev Biased	9.86E+00	1.20E+01	7.94E+00	1.51E+01	5.76E+00	5.15E+00	1.05E+01	9.44E+00	6.37E+00	7.28E+00	1.58E+01	
Ps90%/90% (+KTL) Biased	1.32E+02	1.32E+02	1.23E+02	1.43E+02	1.16E+02	1.16E+02	1.28E+02	1.31E+02	1.19E+02	1.19E+02	1.43E+02	
Ps90%/90% (-KTL) Biased	9.17E+01	8.25E+01	8.98E+01	8.11E+01	9.24E+01	9.52E+01	8.51E+01	9.20E+01	9.25E+01	8.94E+01	7.72E+01	
Specification MIN	8.10E+01	8.10E+01	8.10E+01	8.10E+01	8.10E+01	8.10E+01	8.10E+01	8.10E+01	8.10E+01	8.10E+01	8.10E+01	
Status	PASS	PASS	PASS	PASS	PASS	PASS	PASS	PASS	PASS	PASS	PASS	

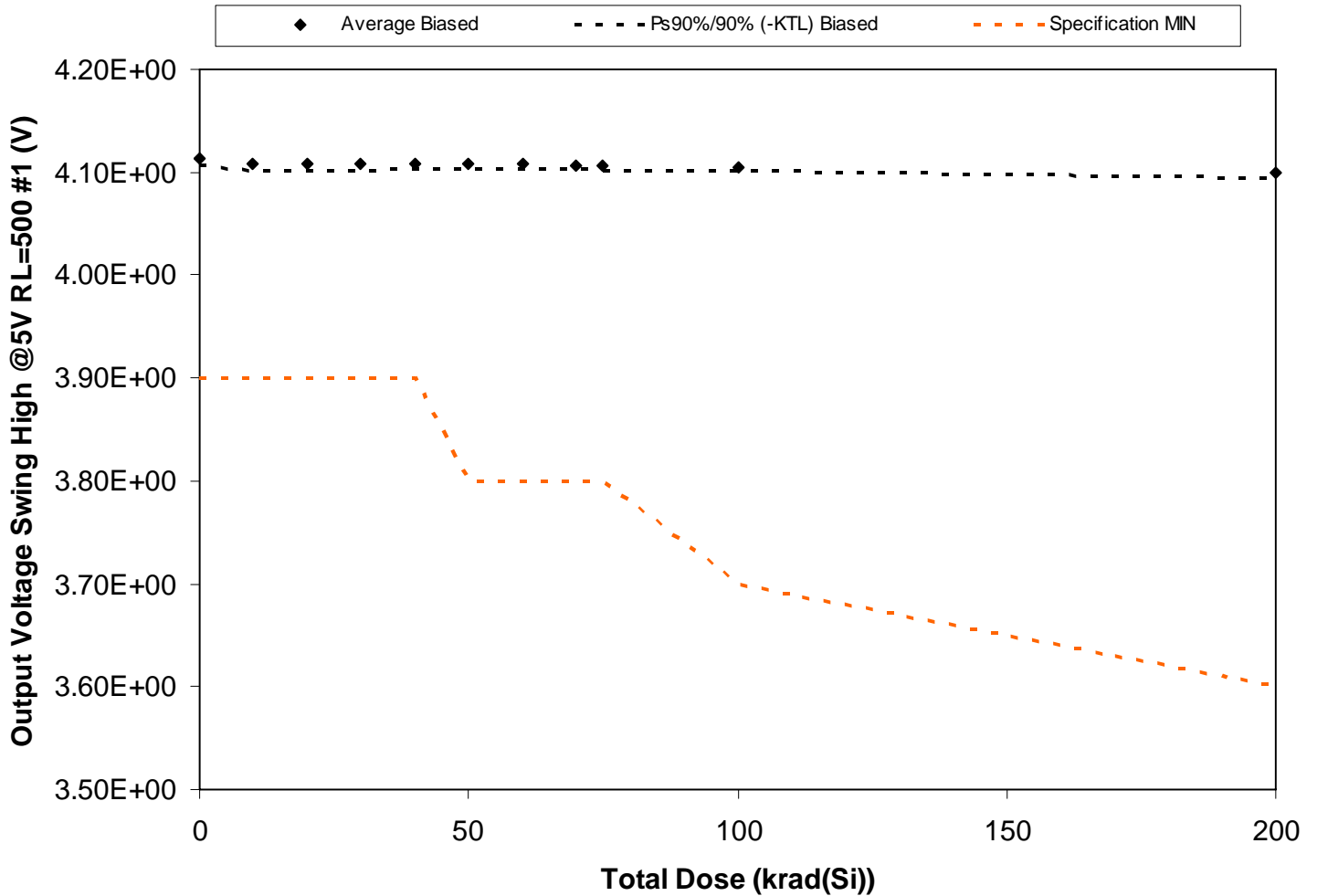

Figure 5.121. Plot of Output Voltage Swing High @5V RL=500 #1 (V) versus total dose. The solid diamonds are the average of the measured data points for the samples irradiated under electrical bias and the black lines (solid and/or dashed) are the average of the data points after application of the KTL statistics on the samples irradiated under electrical bias. The red dotted line(s) are the pre- and/or post-irradiation minimum and/or maximum specification value as defined in the datasheet and/or test plan.



**RLAT Report
10-326 100808 R1.0**

**Radiation Assured Devices
5017 N. 30th Street
Colorado Springs, CO 80919
(719) 531-0800**

Table 5.121. Raw data for Output Voltage Swing High @5V RL=500 #1 (V) versus total dose, including the statistical analysis, specification and the status of the testing (pass/fail).

Output Voltage Swing High @5V RL=500 #1 (V)	Total Dose (krad(Si))											
	0	10	20	30	40	50	60	70	75	100	200	
Device												
1245	4.11E+00	4.10E+00	4.10E+00	4.10E+00	4.10E+00	4.10E+00	4.10E+00	4.10E+00	4.10E+00	4.10E+00	4.10E+00	4.10E+00
1246	4.11E+00	4.11E+00	4.11E+00	4.11E+00	4.11E+00	4.11E+00	4.11E+00	4.11E+00	4.11E+00	4.11E+00	4.11E+00	4.10E+00
1247	4.12E+00	4.11E+00	4.11E+00	4.11E+00	4.11E+00	4.11E+00	4.11E+00	4.11E+00	4.11E+00	4.11E+00	4.11E+00	4.10E+00
1248	4.12E+00	4.11E+00	4.11E+00	4.11E+00	4.11E+00	4.11E+00	4.11E+00	4.11E+00	4.11E+00	4.11E+00	4.11E+00	4.10E+00
1249	4.11E+00	4.11E+00	4.11E+00	4.11E+00	4.11E+00	4.11E+00	4.11E+00	4.11E+00	4.11E+00	4.11E+00	4.11E+00	4.10E+00
1250	4.11E+00	4.11E+00	4.11E+00	4.11E+00	4.11E+00	4.11E+00	4.11E+00	4.11E+00	4.11E+00	4.11E+00	4.10E+00	4.10E+00
1251	4.11E+00	4.11E+00	4.11E+00	4.11E+00	4.11E+00	4.11E+00	4.11E+00	4.11E+00	4.11E+00	4.10E+00	4.10E+00	4.10E+00
1261	4.12E+00	4.11E+00	4.11E+00	4.11E+00	4.11E+00	4.11E+00	4.11E+00	4.11E+00	4.11E+00	4.11E+00	4.11E+00	4.10E+00
1262	4.11E+00	4.11E+00	4.11E+00	4.11E+00	4.11E+00	4.11E+00	4.11E+00	4.11E+00	4.11E+00	4.11E+00	4.11E+00	4.10E+00
1263	4.11E+00	4.10E+00	4.10E+00	4.11E+00	4.11E+00	4.11E+00	4.11E+00	4.11E+00	4.11E+00	4.11E+00	4.10E+00	4.10E+00
1264	4.11E+00	4.11E+00	4.11E+00	4.11E+00	4.11E+00	4.11E+00	4.11E+00	4.11E+00	4.11E+00	4.11E+00	4.11E+00	4.11E+00
1265	4.12E+00	4.11E+00	4.11E+00	4.11E+00	4.11E+00	4.11E+00	4.11E+00	4.11E+00	4.11E+00	4.11E+00	4.11E+00	4.11E+00
Biased Statistics												
Average Biased	4.11E+00	4.11E+00	4.11E+00	4.11E+00	4.11E+00	4.11E+00	4.11E+00	4.11E+00	4.11E+00	4.11E+00	4.11E+00	4.10E+00
Std Dev Biased	2.85E-03	3.35E-03	3.34E-03	3.14E-03	2.69E-03	2.46E-03	2.55E-03	2.25E-03	2.62E-03	2.22E-03	2.08E-03	
Ps90%/90% (+KTL) Biased	4.12E+00	4.11E+00	4.11E+00	4.11E+00	4.11E+00	4.11E+00	4.11E+00	4.11E+00	4.11E+00	4.11E+00	4.11E+00	4.10E+00
Ps90%/90% (-KTL) Biased	4.11E+00	4.10E+00	4.10E+00	4.10E+00	4.10E+00	4.10E+00	4.10E+00	4.10E+00	4.10E+00	4.10E+00	4.10E+00	4.09E+00
Specification MIN	3.90E+00	3.90E+00	3.90E+00	3.90E+00	3.90E+00	3.80E+00	3.80E+00	3.80E+00	3.80E+00	3.80E+00	3.70E+00	3.60E+00
Status	PASS	PASS	PASS	PASS	PASS	PASS	PASS	PASS	PASS	PASS	PASS	PASS

An ISO 9001:2008 and DSCC Certified Company

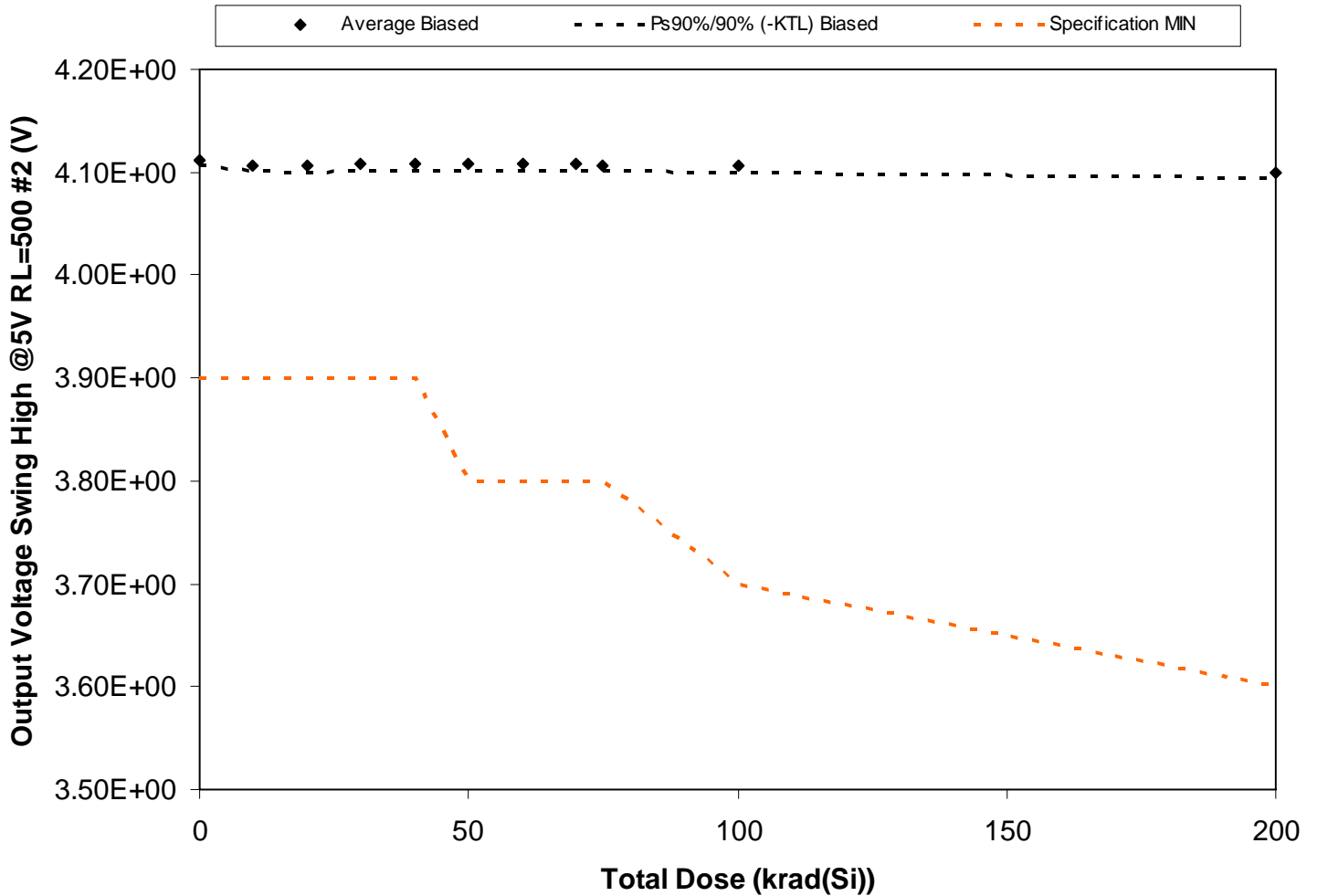

Figure 5.122. Plot of Output Voltage Swing High @5V RL=500 #2 (V) versus total dose. The solid diamonds are the average of the measured data points for the samples irradiated under electrical bias and the black lines (solid and/or dashed) are the average of the data points after application of the KTL statistics on the samples irradiated under electrical bias. The red dotted line(s) are the pre- and/or post-irradiation minimum and/or maximum specification value as defined in the datasheet and/or test plan.



**RLAT Report
10-326 100808 R1.0**

**Radiation Assured Devices
5017 N. 30th Street
Colorado Springs, CO 80919
(719) 531-0800**

Table 5.122. Raw data for Output Voltage Swing High @5V RL=500 #2 (V) versus total dose, including the statistical analysis, specification and the status of the testing (pass/fail).

Output Voltage Swing High @5V RL=500 #2 (V)	Total Dose (krad(Si))											
	0	10	20	30	40	50	60	70	75	100	200	
Device												
1245	4.11E+00	4.11E+00	4.10E+00	4.10E+00	4.10E+00	4.10E+00	4.10E+00	4.10E+00	4.10E+00	4.10E+00	4.10E+00	4.09E+00
1246	4.11E+00	4.11E+00	4.11E+00	4.11E+00	4.11E+00	4.11E+00	4.11E+00	4.11E+00	4.11E+00	4.11E+00	4.11E+00	4.10E+00
1247	4.11E+00	4.11E+00	4.11E+00	4.11E+00	4.11E+00	4.11E+00	4.11E+00	4.11E+00	4.11E+00	4.11E+00	4.11E+00	4.10E+00
1248	4.11E+00	4.11E+00	4.11E+00	4.11E+00	4.11E+00	4.11E+00	4.11E+00	4.11E+00	4.11E+00	4.11E+00	4.11E+00	4.11E+00
1249	4.11E+00	4.10E+00	4.10E+00	4.11E+00	4.11E+00	4.11E+00	4.11E+00	4.11E+00	4.11E+00	4.11E+00	4.10E+00	4.10E+00
1250	4.11E+00	4.10E+00	4.10E+00	4.10E+00	4.10E+00	4.10E+00	4.11E+00	4.10E+00	4.11E+00	4.10E+00	4.10E+00	4.10E+00
1251	4.11E+00	4.11E+00	4.11E+00	4.11E+00	4.11E+00	4.11E+00	4.11E+00	4.11E+00	4.11E+00	4.11E+00	4.11E+00	4.10E+00
1261	4.11E+00	4.11E+00	4.11E+00	4.11E+00	4.11E+00	4.11E+00	4.11E+00	4.11E+00	4.11E+00	4.11E+00	4.11E+00	4.10E+00
1262	4.11E+00	4.11E+00	4.11E+00	4.11E+00	4.11E+00	4.11E+00	4.11E+00	4.11E+00	4.11E+00	4.11E+00	4.11E+00	4.10E+00
1263	4.11E+00	4.11E+00	4.11E+00	4.11E+00	4.11E+00	4.11E+00	4.11E+00	4.11E+00	4.11E+00	4.11E+00	4.11E+00	4.10E+00
1264	4.11E+00	4.11E+00	4.11E+00	4.11E+00	4.11E+00	4.11E+00	4.11E+00	4.11E+00	4.11E+00	4.11E+00	4.11E+00	4.11E+00
1265	4.11E+00	4.11E+00	4.11E+00	4.11E+00	4.11E+00	4.11E+00	4.11E+00	4.11E+00	4.11E+00	4.11E+00	4.11E+00	4.11E+00
Biased Statistics												
Average Biased	4.11E+00	4.11E+00	4.11E+00	4.11E+00	4.11E+00	4.11E+00	4.11E+00	4.11E+00	4.11E+00	4.11E+00	4.11E+00	4.10E+00
Std Dev Biased	2.69E-03	3.14E-03	3.41E-03	3.24E-03	3.03E-03	2.91E-03	2.78E-03	2.88E-03	2.98E-03	2.78E-03	2.82E-03	2.82E-03
Ps90%/90% (+KTL) Biased	4.12E+00	4.11E+00	4.11E+00	4.11E+00	4.11E+00	4.11E+00	4.11E+00	4.11E+00	4.11E+00	4.11E+00	4.11E+00	4.11E+00
Ps90%/90% (-KTL) Biased	4.11E+00	4.10E+00	4.10E+00	4.10E+00	4.10E+00	4.10E+00	4.10E+00	4.10E+00	4.10E+00	4.10E+00	4.10E+00	4.09E+00
Specification MIN	3.90E+00	3.90E+00	3.90E+00	3.90E+00	3.90E+00	3.80E+00	3.80E+00	3.80E+00	3.80E+00	3.70E+00	3.60E+00	3.60E+00
Status	PASS	PASS	PASS	PASS	PASS	PASS	PASS	PASS	PASS	PASS	PASS	PASS

An ISO 9001:2008 and DSCC Certified Company

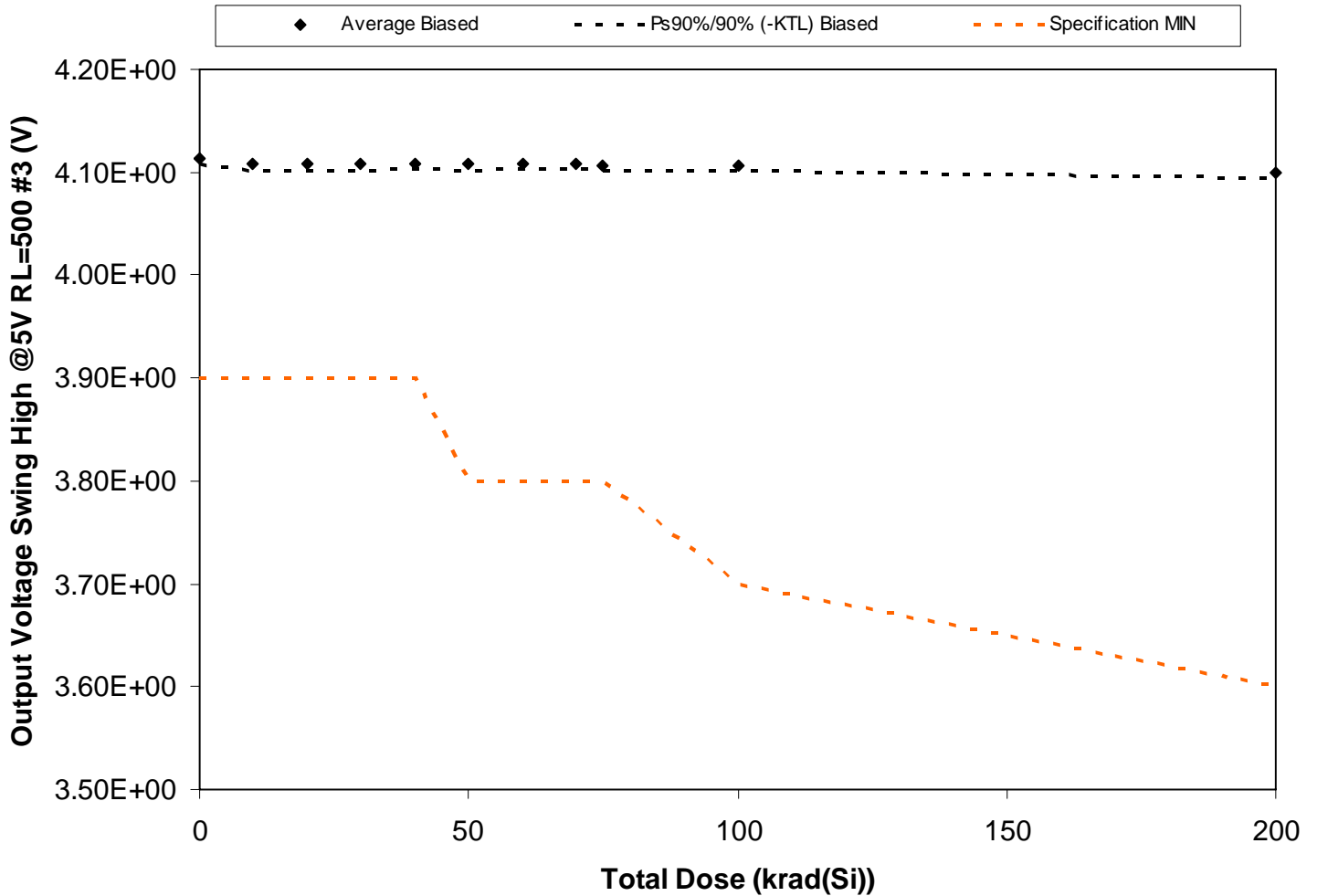

Figure 5.123. Plot of Output Voltage Swing High @5V RL=500 #3 (V) versus total dose. The solid diamonds are the average of the measured data points for the samples irradiated under electrical bias and the black lines (solid and/or dashed) are the average of the data points after application of the KTL statistics on the samples irradiated under electrical bias. The red dotted line(s) are the pre- and/or post-irradiation minimum and/or maximum specification value as defined in the datasheet and/or test plan.



**RLAT Report
10-326 100808 R1.0**

**Radiation Assured Devices
5017 N. 30th Street
Colorado Springs, CO 80919
(719) 531-0800**

Table 5.123. Raw data for Output Voltage Swing High @5V RL=500 #3 (V) versus total dose, including the statistical analysis, specification and the status of the testing (pass/fail).

Output Voltage Swing High @5V RL=500 #3 (V)	Total Dose (krad(Si))											
	0	10	20	30	40	50	60	70	75	100	200	
Device												
1245	4.11E+00	4.10E+00	4.10E+00	4.10E+00	4.11E+00	4.10E+00	4.10E+00	4.10E+00	4.10E+00	4.10E+00	4.10E+00	4.10E+00
1246	4.11E+00	4.11E+00	4.11E+00	4.11E+00	4.11E+00	4.11E+00	4.11E+00	4.11E+00	4.11E+00	4.11E+00	4.11E+00	4.10E+00
1247	4.11E+00	4.11E+00	4.11E+00	4.11E+00	4.11E+00	4.11E+00	4.11E+00	4.11E+00	4.11E+00	4.11E+00	4.11E+00	4.10E+00
1248	4.12E+00	4.11E+00	4.11E+00	4.11E+00	4.11E+00	4.11E+00	4.11E+00	4.11E+00	4.11E+00	4.11E+00	4.11E+00	4.10E+00
1249	4.11E+00	4.11E+00	4.11E+00	4.11E+00	4.11E+00	4.11E+00	4.11E+00	4.11E+00	4.11E+00	4.11E+00	4.11E+00	4.10E+00
1250	4.11E+00	4.10E+00	4.10E+00	4.10E+00	4.10E+00	4.10E+00	4.10E+00	4.10E+00	4.10E+00	4.10E+00	4.10E+00	4.10E+00
1251	4.12E+00	4.11E+00	4.11E+00	4.11E+00	4.11E+00	4.11E+00	4.11E+00	4.11E+00	4.11E+00	4.11E+00	4.11E+00	4.10E+00
1261	4.11E+00	4.11E+00	4.11E+00	4.11E+00	4.11E+00	4.11E+00	4.11E+00	4.11E+00	4.11E+00	4.11E+00	4.11E+00	4.10E+00
1262	4.12E+00	4.11E+00	4.11E+00	4.11E+00	4.11E+00	4.11E+00	4.11E+00	4.11E+00	4.11E+00	4.11E+00	4.11E+00	4.10E+00
1263	4.12E+00	4.11E+00	4.11E+00	4.11E+00	4.11E+00	4.11E+00	4.11E+00	4.11E+00	4.11E+00	4.11E+00	4.11E+00	4.10E+00
1264	4.11E+00	4.11E+00	4.11E+00	4.11E+00	4.11E+00	4.11E+00	4.11E+00	4.11E+00	4.11E+00	4.11E+00	4.11E+00	4.11E+00
1265	4.11E+00	4.11E+00	4.11E+00	4.11E+00	4.11E+00	4.11E+00	4.11E+00	4.11E+00	4.11E+00	4.11E+00	4.11E+00	4.11E+00
Biased Statistics												
Average Biased	4.11E+00	4.11E+00	4.11E+00	4.11E+00	4.11E+00	4.11E+00	4.11E+00	4.11E+00	4.11E+00	4.11E+00	4.11E+00	4.10E+00
Std Dev Biased	2.41E-03	3.33E-03	3.07E-03	3.03E-03	2.86E-03	2.91E-03	2.69E-03	2.41E-03	2.40E-03	2.41E-03	2.46E-03	
Ps90%/90% (+KTL) Biased	4.12E+00	4.12E+00	4.11E+00	4.11E+00	4.11E+00	4.11E+00	4.11E+00	4.11E+00	4.11E+00	4.11E+00	4.10E+00	4.09E+00
Ps90%/90% (-KTL) Biased	4.11E+00	4.10E+00	4.10E+00	4.10E+00	4.10E+00	4.10E+00	4.10E+00	4.10E+00	4.10E+00	4.10E+00	4.10E+00	4.09E+00
Specification MIN	3.90E+00	3.90E+00	3.90E+00	3.90E+00	3.90E+00	3.80E+00	3.80E+00	3.80E+00	3.80E+00	3.70E+00	3.60E+00	
Status	PASS	PASS	PASS	PASS	PASS	PASS	PASS	PASS	PASS	PASS	PASS	PASS

An ISO 9001:2008 and DSCC Certified Company

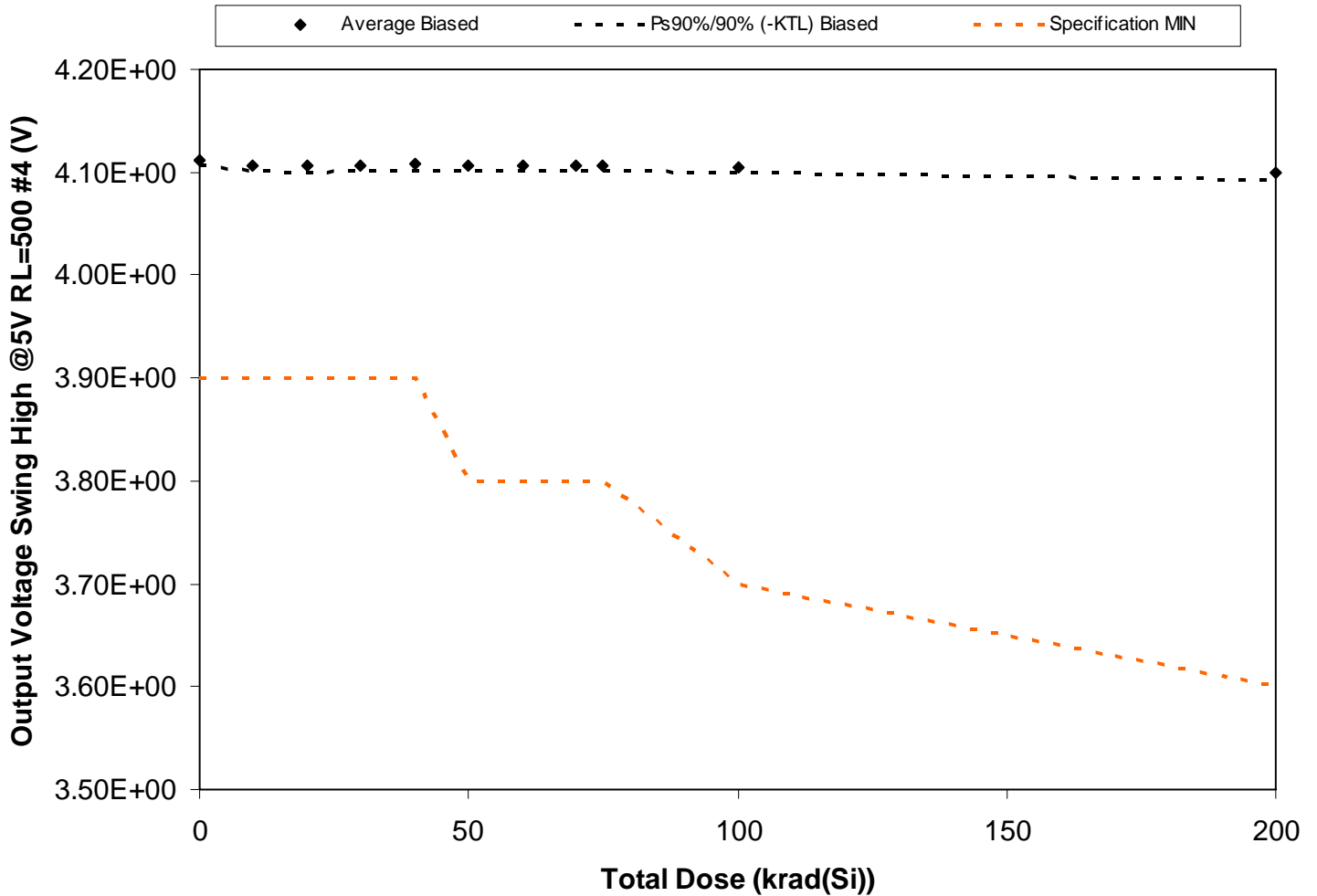

Figure 5.124. Plot of Output Voltage Swing High @5V RL=500 #4 (V) versus total dose. The solid diamonds are the average of the measured data points for the samples irradiated under electrical bias and the black lines (solid and/or dashed) are the average of the data points after application of the KTL statistics on the samples irradiated under electrical bias. The red dotted line(s) are the pre- and/or post-irradiation minimum and/or maximum specification value as defined in the datasheet and/or test plan.



**RLAT Report
10-326 100808 R1.0**

**Radiation Assured Devices
5017 N. 30th Street
Colorado Springs, CO 80919
(719) 531-0800**

Table 5.124. Raw data for Output Voltage Swing High @5V RL=500 #4 (V) versus total dose, including the statistical analysis, specification and the status of the testing (pass/fail).

Output Voltage Swing High @5V RL=500 #4 (V)	Total Dose (krad(Si))											
	0	10	20	30	40	50	60	70	75	100	200	
Device												
1245	4.11E+00	4.10E+00	4.10E+00	4.10E+00	4.11E+00	4.10E+00	4.10E+00	4.10E+00	4.10E+00	4.10E+00	4.10E+00	4.10E+00
1246	4.11E+00	4.11E+00	4.11E+00	4.11E+00	4.11E+00	4.11E+00	4.11E+00	4.11E+00	4.11E+00	4.11E+00	4.10E+00	4.10E+00
1247	4.11E+00	4.11E+00	4.11E+00	4.11E+00	4.11E+00	4.11E+00	4.11E+00	4.11E+00	4.11E+00	4.11E+00	4.11E+00	4.10E+00
1248	4.11E+00	4.11E+00	4.11E+00	4.11E+00	4.11E+00	4.11E+00	4.11E+00	4.11E+00	4.11E+00	4.11E+00	4.11E+00	4.10E+00
1249	4.11E+00	4.11E+00	4.11E+00	4.11E+00	4.11E+00	4.11E+00	4.11E+00	4.11E+00	4.11E+00	4.11E+00	4.11E+00	4.10E+00
1250	4.11E+00	4.11E+00	4.10E+00	4.11E+00	4.11E+00	4.11E+00	4.11E+00	4.11E+00	4.11E+00	4.11E+00	4.10E+00	4.10E+00
1251	4.11E+00	4.11E+00	4.11E+00	4.11E+00	4.11E+00	4.11E+00	4.11E+00	4.11E+00	4.11E+00	4.11E+00	4.11E+00	4.10E+00
1261	4.12E+00	4.11E+00	4.11E+00	4.11E+00	4.11E+00	4.11E+00	4.11E+00	4.11E+00	4.11E+00	4.11E+00	4.11E+00	4.10E+00
1262	4.11E+00	4.11E+00	4.11E+00	4.11E+00	4.11E+00	4.11E+00	4.11E+00	4.11E+00	4.11E+00	4.11E+00	4.11E+00	4.10E+00
1263	4.11E+00	4.10E+00	4.10E+00	4.10E+00	4.10E+00	4.10E+00	4.10E+00	4.10E+00	4.10E+00	4.10E+00	4.10E+00	4.10E+00
1264	4.11E+00	4.11E+00	4.11E+00	4.11E+00	4.11E+00	4.11E+00	4.11E+00	4.11E+00	4.11E+00	4.11E+00	4.11E+00	4.11E+00
1265	4.12E+00	4.11E+00	4.11E+00	4.11E+00	4.11E+00	4.11E+00	4.11E+00	4.11E+00	4.11E+00	4.11E+00	4.11E+00	4.11E+00
Biased Statistics												
Average Biased	4.11E+00	4.11E+00	4.11E+00	4.11E+00	4.11E+00	4.11E+00	4.11E+00	4.11E+00	4.11E+00	4.11E+00	4.11E+00	4.10E+00
Std Dev Biased	2.49E-03	2.88E-03	3.12E-03	3.16E-03	2.99E-03	2.62E-03	2.69E-03	2.45E-03	2.40E-03	2.54E-03	2.91E-03	
Ps90%/90% (+KTL) Biased	4.12E+00	4.11E+00	4.11E+00	4.11E+00	4.11E+00	4.11E+00	4.11E+00	4.11E+00	4.11E+00	4.11E+00	4.10E+00	4.10E+00
Ps90%/90% (-KTL) Biased	4.11E+00	4.10E+00	4.10E+00	4.10E+00	4.10E+00	4.10E+00	4.10E+00	4.10E+00	4.10E+00	4.10E+00	4.10E+00	4.09E+00
Specification MIN	3.90E+00	3.90E+00	3.90E+00	3.90E+00	3.90E+00	3.80E+00	3.80E+00	3.80E+00	3.80E+00	3.70E+00	3.60E+00	
Status	PASS	PASS	PASS	PASS	PASS	PASS	PASS	PASS	PASS	PASS	PASS	PASS

An ISO 9001:2008 and DSCC Certified Company

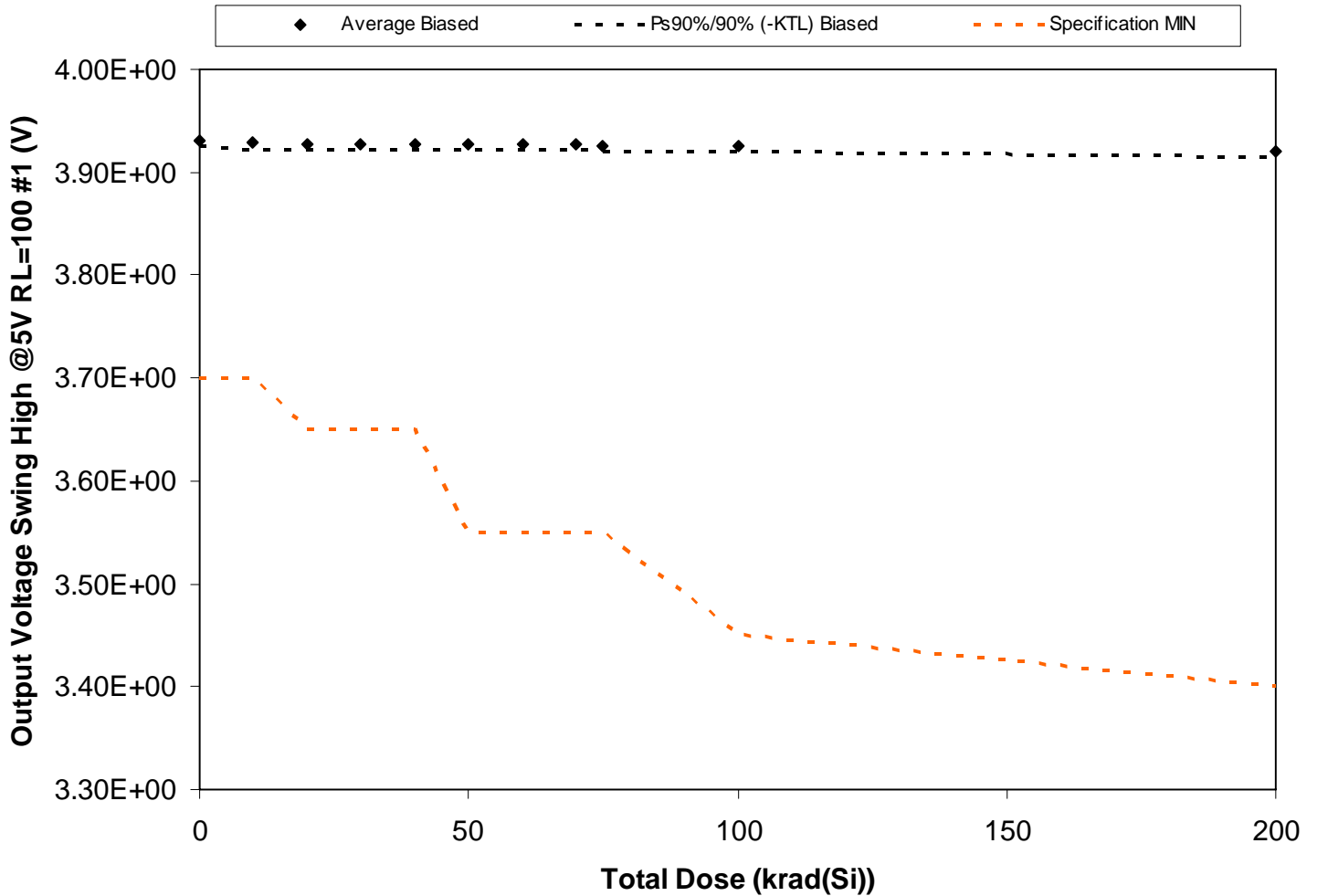

Figure 5.125. Plot of Output Voltage Swing High @5V RL=100 #1 (V) versus total dose. The solid diamonds are the average of the measured data points for the samples irradiated under electrical bias and the black lines (solid and/or dashed) are the average of the data points after application of the KTL statistics on the samples irradiated under electrical bias. The red dotted line(s) are the pre- and/or post-irradiation minimum and/or maximum specification value as defined in the datasheet and/or test plan.



**RLAT Report
10-326 100808 R1.0**

**Radiation Assured Devices
5017 N. 30th Street
Colorado Springs, CO 80919
(719) 531-0800**

Table 5.125. Raw data for Output Voltage Swing High @5V RL=100 #1 (V) versus total dose, including the statistical analysis, specification and the status of the testing (pass/fail).

Output Voltage Swing High @5V RL=100 #1 (V)	Total Dose (krad(Si))											
	0	10	20	30	40	50	60	70	75	100	200	
Device												
1245	3.93E+00	3.93E+00	3.93E+00	3.93E+00	3.93E+00	3.93E+00	3.93E+00	3.93E+00	3.93E+00	3.93E+00	3.92E+00	3.92E+00
1246	3.93E+00	3.93E+00	3.93E+00	3.93E+00	3.93E+00	3.93E+00	3.93E+00	3.93E+00	3.93E+00	3.93E+00	3.93E+00	3.92E+00
1247	3.94E+00	3.93E+00	3.93E+00	3.93E+00	3.93E+00	3.93E+00	3.93E+00	3.93E+00	3.93E+00	3.93E+00	3.93E+00	3.92E+00
1248	3.93E+00	3.93E+00	3.93E+00	3.93E+00	3.93E+00	3.93E+00	3.93E+00	3.93E+00	3.93E+00	3.93E+00	3.93E+00	3.92E+00
1249	3.94E+00	3.93E+00	3.93E+00	3.93E+00	3.93E+00	3.93E+00	3.93E+00	3.93E+00	3.93E+00	3.93E+00	3.93E+00	3.92E+00
1250	3.93E+00	3.93E+00	3.93E+00	3.93E+00	3.93E+00	3.93E+00	3.93E+00	3.93E+00	3.93E+00	3.92E+00	3.92E+00	3.92E+00
1251	3.93E+00	3.93E+00	3.93E+00	3.93E+00	3.93E+00	3.92E+00	3.92E+00	3.92E+00	3.92E+00	3.92E+00	3.92E+00	3.92E+00
1261	3.93E+00	3.93E+00	3.93E+00	3.93E+00	3.93E+00	3.93E+00	3.93E+00	3.93E+00	3.93E+00	3.93E+00	3.93E+00	3.92E+00
1262	3.93E+00	3.93E+00	3.93E+00	3.93E+00	3.93E+00	3.93E+00	3.93E+00	3.93E+00	3.93E+00	3.93E+00	3.93E+00	3.92E+00
1263	3.93E+00	3.93E+00	3.92E+00	3.93E+00	3.92E+00	3.92E+00	3.92E+00	3.92E+00	3.92E+00	3.92E+00	3.92E+00	3.92E+00
1264	3.93E+00	3.93E+00	3.93E+00	3.93E+00	3.93E+00	3.93E+00	3.93E+00	3.93E+00	3.93E+00	3.93E+00	3.93E+00	3.93E+00
1265	3.93E+00	3.93E+00	3.93E+00	3.93E+00	3.93E+00	3.93E+00	3.93E+00	3.93E+00	3.93E+00	3.93E+00	3.93E+00	3.93E+00
Biased Statistics												
Average Biased	3.93E+00	3.93E+00	3.93E+00	3.93E+00	3.93E+00	3.93E+00	3.93E+00	3.93E+00	3.93E+00	3.93E+00	3.93E+00	3.92E+00
Std Dev Biased	2.88E-03	2.96E-03	3.06E-03	3.03E-03	2.72E-03	2.79E-03	2.62E-03	2.62E-03	2.83E-03	2.58E-03	2.32E-03	
Ps90%/90% (+KTL) Biased	3.94E+00	3.93E+00	3.93E+00	3.93E+00	3.93E+00	3.93E+00	3.93E+00	3.93E+00	3.93E+00	3.93E+00	3.93E+00	3.93E+00
Ps90%/90% (-KTL) Biased	3.93E+00	3.92E+00	3.92E+00	3.92E+00	3.92E+00	3.92E+00	3.92E+00	3.92E+00	3.92E+00	3.92E+00	3.92E+00	3.92E+00
Specification MIN	3.70E+00	3.70E+00	3.65E+00	3.65E+00	3.65E+00	3.55E+00	3.55E+00	3.55E+00	3.55E+00	3.45E+00	3.40E+00	
Status	PASS	PASS	PASS	PASS	PASS	PASS	PASS	PASS	PASS	PASS	PASS	PASS

An ISO 9001:2008 and DSCC Certified Company

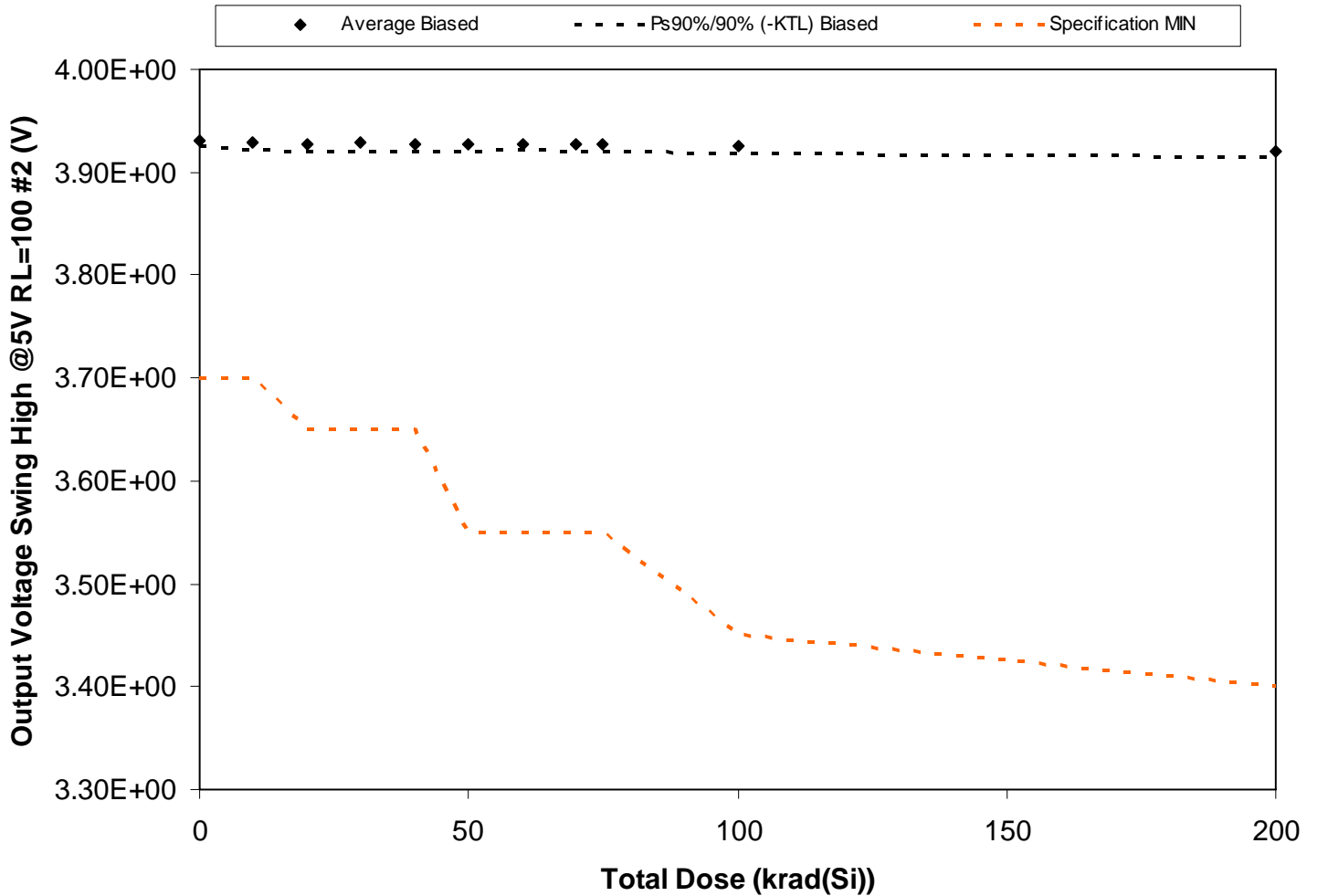

Figure 5.126. Plot of Output Voltage Swing High @5V RL=100 #2 (V) versus total dose. The solid diamonds are the average of the measured data points for the samples irradiated under electrical bias and the black lines (solid and/or dashed) are the average of the data points after application of the KTL statistics on the samples irradiated under electrical bias. The red dotted line(s) are the pre- and/or post-irradiation minimum and/or maximum specification value as defined in the datasheet and/or test plan.



**RLAT Report
10-326 100808 R1.0**

**Radiation Assured Devices
5017 N. 30th Street
Colorado Springs, CO 80919
(719) 531-0800**

Table 5.126. Raw data for Output Voltage Swing High @5V RL=100 #2 (V) versus total dose, including the statistical analysis, specification and the status of the testing (pass/fail).

Output Voltage Swing High @5V RL=100 #2 (V)	Total Dose (krad(Si))											
	0	10	20	30	40	50	60	70	75	100	200	
Device												
1245	3.93E+00	3.92E+00	3.92E+00	3.92E+00	3.92E+00	3.92E+00	3.92E+00	3.92E+00	3.92E+00	3.92E+00	3.92E+00	3.92E+00
1246	3.93E+00	3.93E+00	3.93E+00	3.93E+00	3.93E+00	3.93E+00	3.93E+00	3.93E+00	3.93E+00	3.93E+00	3.92E+00	3.92E+00
1247	3.93E+00	3.93E+00	3.93E+00	3.93E+00	3.93E+00	3.93E+00	3.93E+00	3.93E+00	3.93E+00	3.93E+00	3.93E+00	3.92E+00
1248	3.94E+00	3.93E+00	3.93E+00	3.94E+00	3.93E+00	3.93E+00	3.93E+00	3.93E+00	3.93E+00	3.93E+00	3.93E+00	3.93E+00
1249	3.93E+00	3.93E+00	3.93E+00	3.93E+00	3.93E+00	3.93E+00	3.93E+00	3.93E+00	3.93E+00	3.93E+00	3.93E+00	3.92E+00
1250	3.93E+00	3.93E+00	3.93E+00	3.93E+00	3.93E+00	3.93E+00	3.93E+00	3.93E+00	3.93E+00	3.93E+00	3.92E+00	3.92E+00
1251	3.93E+00	3.93E+00	3.93E+00	3.93E+00	3.93E+00	3.93E+00	3.93E+00	3.93E+00	3.93E+00	3.93E+00	3.93E+00	3.92E+00
1261	3.93E+00	3.93E+00	3.93E+00	3.93E+00	3.93E+00	3.93E+00	3.93E+00	3.93E+00	3.93E+00	3.93E+00	3.93E+00	3.92E+00
1262	3.93E+00	3.93E+00	3.93E+00	3.93E+00	3.93E+00	3.93E+00	3.93E+00	3.93E+00	3.93E+00	3.93E+00	3.93E+00	3.92E+00
1263	3.94E+00	3.93E+00	3.93E+00	3.93E+00	3.93E+00	3.93E+00	3.93E+00	3.93E+00	3.93E+00	3.93E+00	3.93E+00	3.93E+00
1264	3.93E+00	3.93E+00	3.93E+00	3.93E+00	3.93E+00	3.93E+00	3.93E+00	3.93E+00	3.93E+00	3.93E+00	3.93E+00	3.93E+00
1265	3.93E+00	3.93E+00	3.93E+00	3.93E+00	3.93E+00	3.93E+00	3.93E+00	3.93E+00	3.93E+00	3.93E+00	3.93E+00	3.93E+00
Biased Statistics												
Average Biased	3.93E+00	3.93E+00	3.93E+00	3.93E+00	3.93E+00	3.93E+00	3.93E+00	3.93E+00	3.93E+00	3.93E+00	3.93E+00	3.92E+00
Std Dev Biased	2.84E-03	3.14E-03	3.24E-03	3.51E-03	3.39E-03	3.13E-03	3.03E-03	3.25E-03	3.19E-03	3.30E-03	3.28E-03	
Ps90%/90% (+KTL) Biased	3.94E+00	3.93E+00	3.93E+00	3.94E+00	3.93E+00	3.93E+00	3.93E+00	3.93E+00	3.93E+00	3.93E+00	3.93E+00	3.93E+00
Ps90%/90% (-KTL) Biased	3.93E+00	3.92E+00	3.92E+00	3.92E+00	3.92E+00	3.92E+00	3.92E+00	3.92E+00	3.92E+00	3.92E+00	3.92E+00	3.91E+00
Specification MIN	3.70E+00	3.70E+00	3.65E+00	3.65E+00	3.65E+00	3.55E+00	3.55E+00	3.55E+00	3.55E+00	3.45E+00	3.40E+00	
Status	PASS	PASS	PASS	PASS	PASS	PASS	PASS	PASS	PASS	PASS	PASS	PASS

An ISO 9001:2008 and DSCC Certified Company

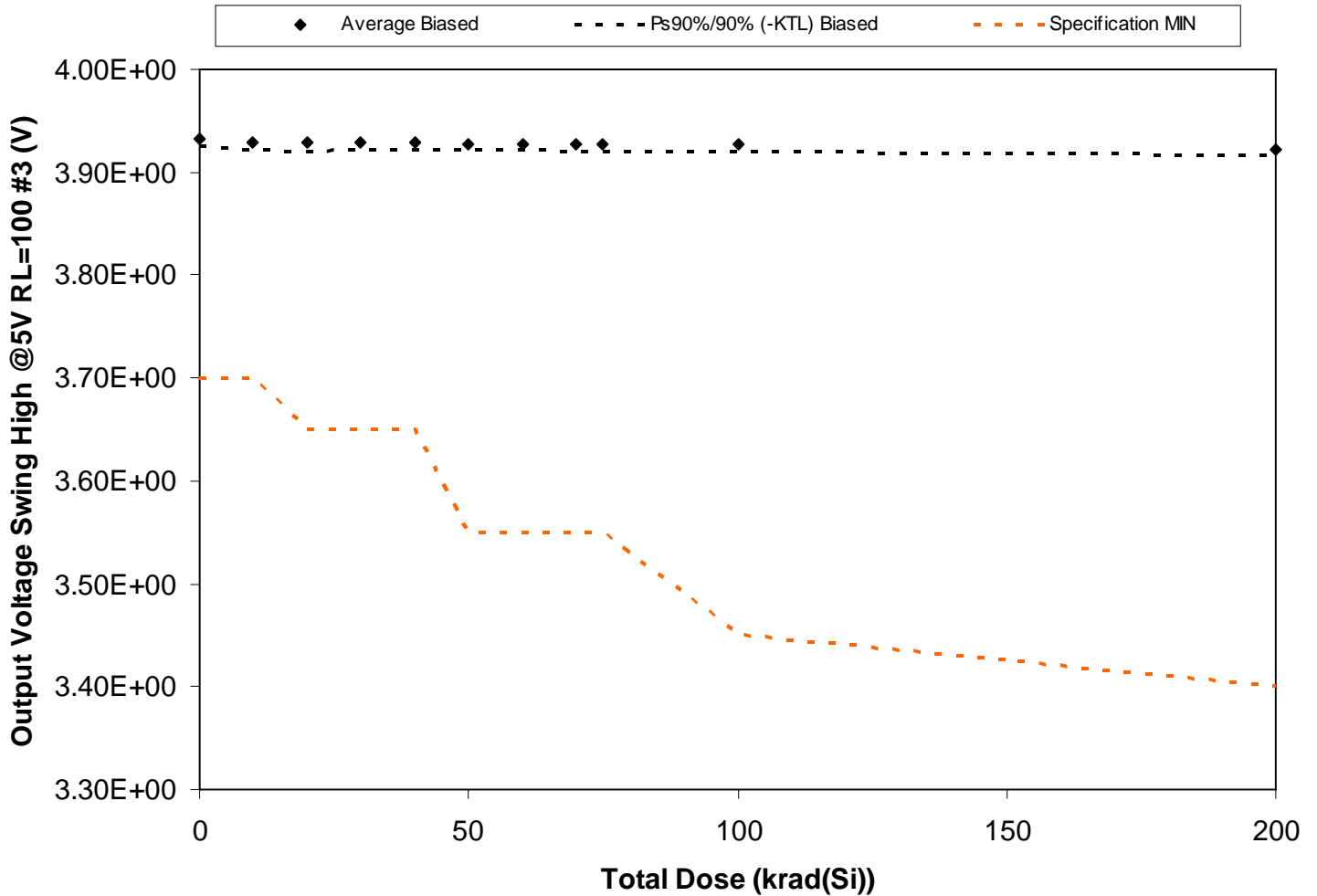

Figure 5.127. Plot of Output Voltage Swing High @5V RL=100 #3 (V) versus total dose. The solid diamonds are the average of the measured data points for the samples irradiated under electrical bias and the black lines (solid and/or dashed) are the average of the data points after application of the KTL statistics on the samples irradiated under electrical bias. The red dotted line(s) are the pre- and/or post-irradiation minimum and/or maximum specification value as defined in the datasheet and/or test plan.



**RLAT Report
10-326 100808 R1.0**

**Radiation Assured Devices
5017 N. 30th Street
Colorado Springs, CO 80919
(719) 531-0800**

Table 5.127. Raw data for Output Voltage Swing High @5V RL=100 #3 (V) versus total dose, including the statistical analysis, specification and the status of the testing (pass/fail).

Output Voltage Swing High @5V RL=100 #3 (V)	Total Dose (krad(Si))											
	0	10	20	30	40	50	60	70	75	100	200	
Device												
1245	3.93E+00	3.92E+00	3.92E+00	3.92E+00	3.92E+00	3.92E+00	3.92E+00	3.92E+00	3.92E+00	3.92E+00	3.92E+00	3.92E+00
1246	3.93E+00	3.93E+00	3.93E+00	3.93E+00	3.93E+00	3.93E+00	3.93E+00	3.93E+00	3.93E+00	3.93E+00	3.93E+00	3.92E+00
1247	3.93E+00	3.93E+00	3.93E+00	3.93E+00	3.93E+00	3.93E+00	3.93E+00	3.93E+00	3.93E+00	3.93E+00	3.93E+00	3.92E+00
1248	3.94E+00	3.94E+00	3.94E+00	3.94E+00	3.94E+00	3.93E+00	3.93E+00	3.93E+00	3.93E+00	3.93E+00	3.93E+00	3.93E+00
1249	3.93E+00	3.93E+00	3.93E+00	3.93E+00	3.93E+00	3.93E+00	3.93E+00	3.93E+00	3.93E+00	3.93E+00	3.93E+00	3.92E+00
1250	3.93E+00	3.93E+00	3.93E+00	3.93E+00	3.93E+00	3.93E+00	3.93E+00	3.93E+00	3.93E+00	3.93E+00	3.92E+00	3.92E+00
1251	3.93E+00	3.93E+00	3.93E+00	3.93E+00	3.93E+00	3.93E+00	3.93E+00	3.93E+00	3.93E+00	3.93E+00	3.93E+00	3.92E+00
1261	3.93E+00	3.93E+00	3.93E+00	3.93E+00	3.93E+00	3.93E+00	3.93E+00	3.93E+00	3.93E+00	3.93E+00	3.93E+00	3.92E+00
1262	3.93E+00	3.93E+00	3.93E+00	3.93E+00	3.93E+00	3.93E+00	3.93E+00	3.93E+00	3.93E+00	3.93E+00	3.93E+00	3.92E+00
1263	3.94E+00	3.94E+00	3.93E+00	3.93E+00	3.93E+00	3.93E+00	3.93E+00	3.93E+00	3.93E+00	3.93E+00	3.93E+00	3.93E+00
1264	3.93E+00	3.93E+00	3.93E+00	3.93E+00	3.93E+00	3.93E+00	3.93E+00	3.93E+00	3.93E+00	3.93E+00	3.93E+00	3.93E+00
1265	3.93E+00	3.93E+00	3.93E+00	3.93E+00	3.93E+00	3.93E+00	3.93E+00	3.93E+00	3.93E+00	3.93E+00	3.93E+00	3.93E+00
Biased Statistics												
Average Biased	3.93E+00	3.93E+00	3.93E+00	3.93E+00	3.93E+00	3.93E+00	3.93E+00	3.93E+00	3.93E+00	3.93E+00	3.93E+00	3.92E+00
Std Dev Biased	3.53E-03	3.68E-03	3.77E-03	3.57E-03	3.41E-03	3.27E-03	3.11E-03	3.35E-03	3.02E-03	3.03E-03	2.81E-03	
Ps90%/90% (+KTL) Biased	3.94E+00	3.94E+00	3.94E+00	3.94E+00	3.94E+00	3.93E+00	3.93E+00	3.93E+00	3.93E+00	3.93E+00	3.93E+00	3.93E+00
Ps90%/90% (-KTL) Biased	3.93E+00	3.92E+00	3.92E+00	3.92E+00	3.92E+00	3.92E+00	3.92E+00	3.92E+00	3.92E+00	3.92E+00	3.92E+00	3.92E+00
Specification MIN	3.70E+00	3.70E+00	3.65E+00	3.65E+00	3.65E+00	3.55E+00	3.55E+00	3.55E+00	3.55E+00	3.45E+00	3.40E+00	
Status	PASS	PASS	PASS	PASS	PASS	PASS	PASS	PASS	PASS	PASS	PASS	PASS

An ISO 9001:2008 and DSCC Certified Company

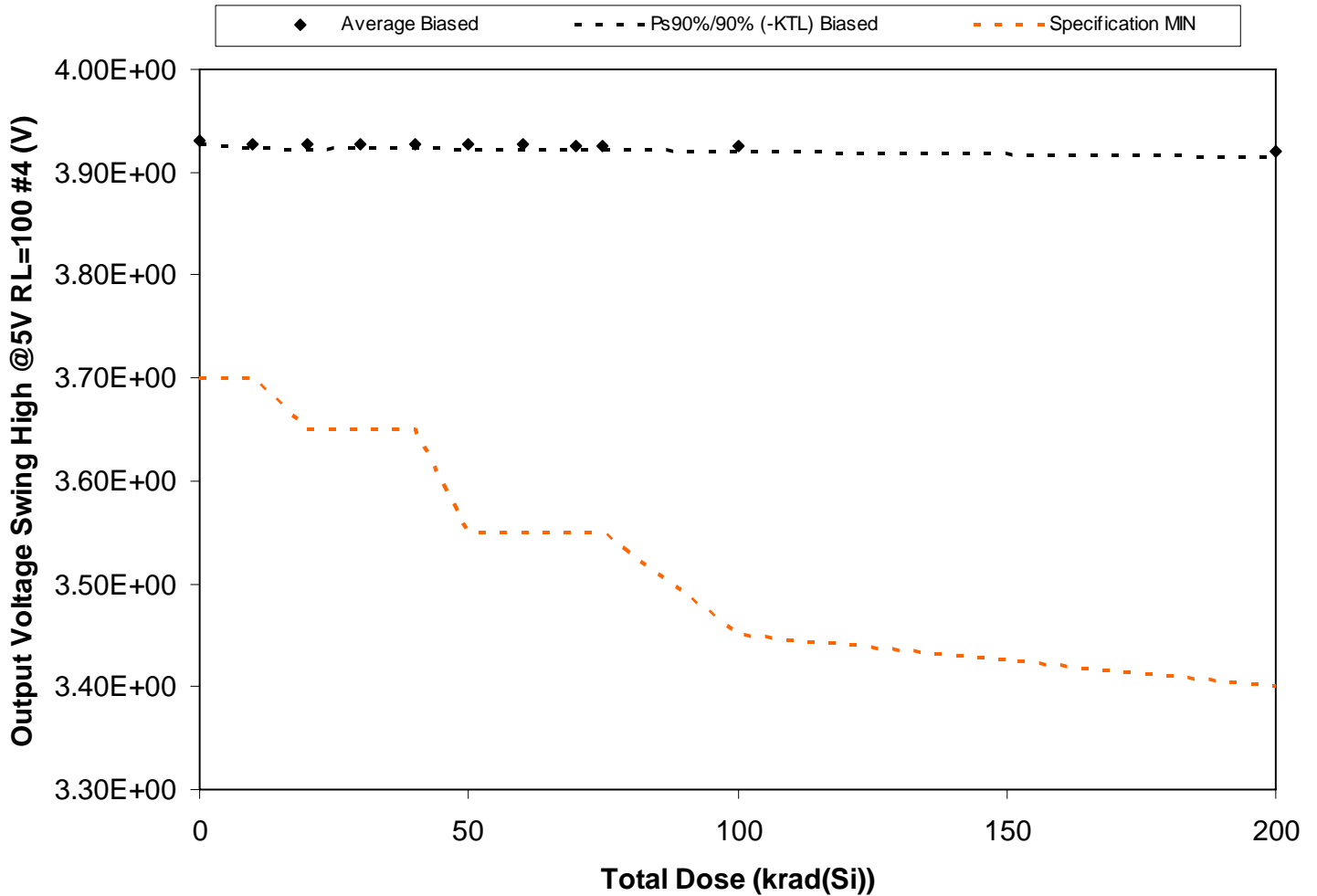

Figure 5.128. Plot of Output Voltage Swing High @5V RL=100 #4 (V) versus total dose. The solid diamonds are the average of the measured data points for the samples irradiated under electrical bias and the black lines (solid and/or dashed) are the average of the data points after application of the KTL statistics on the samples irradiated under electrical bias. The red dotted line(s) are the pre- and/or post-irradiation minimum and/or maximum specification value as defined in the datasheet and/or test plan.



**RLAT Report
10-326 100808 R1.0**

**Radiation Assured Devices
5017 N. 30th Street
Colorado Springs, CO 80919
(719) 531-0800**

Table 5.128. Raw data for Output Voltage Swing High @5V RL=100 #4 (V) versus total dose, including the statistical analysis, specification and the status of the testing (pass/fail).

Output Voltage Swing High @5V RL=100 #4 (V)	Total Dose (krad(Si))											
	0	10	20	30	40	50	60	70	75	100	200	
Device												
1245	3.93E+00	3.93E+00	3.93E+00	3.93E+00	3.93E+00	3.93E+00	3.93E+00	3.93E+00	3.92E+00	3.92E+00	3.92E+00	3.92E+00
1246	3.93E+00	3.93E+00	3.93E+00	3.93E+00	3.93E+00	3.93E+00	3.93E+00	3.93E+00	3.93E+00	3.93E+00	3.93E+00	3.92E+00
1247	3.93E+00	3.93E+00	3.93E+00	3.93E+00	3.93E+00	3.93E+00	3.93E+00	3.93E+00	3.93E+00	3.93E+00	3.93E+00	3.92E+00
1248	3.93E+00	3.93E+00	3.93E+00	3.93E+00	3.93E+00	3.93E+00	3.93E+00	3.93E+00	3.93E+00	3.93E+00	3.93E+00	3.92E+00
1249	3.93E+00	3.93E+00	3.93E+00	3.93E+00	3.93E+00	3.93E+00	3.93E+00	3.93E+00	3.93E+00	3.93E+00	3.93E+00	3.92E+00
1250	3.93E+00	3.93E+00	3.93E+00	3.93E+00	3.93E+00	3.93E+00	3.93E+00	3.93E+00	3.92E+00	3.92E+00	3.92E+00	3.92E+00
1251	3.93E+00	3.93E+00	3.93E+00	3.93E+00	3.93E+00	3.93E+00	3.93E+00	3.93E+00	3.93E+00	3.93E+00	3.92E+00	3.92E+00
1261	3.93E+00	3.93E+00	3.93E+00	3.93E+00	3.93E+00	3.93E+00	3.93E+00	3.93E+00	3.93E+00	3.93E+00	3.93E+00	3.92E+00
1262	3.93E+00	3.93E+00	3.93E+00	3.93E+00	3.93E+00	3.93E+00	3.93E+00	3.93E+00	3.93E+00	3.93E+00	3.93E+00	3.92E+00
1263	3.93E+00	3.93E+00	3.93E+00	3.93E+00	3.93E+00	3.93E+00	3.92E+00	3.92E+00	3.92E+00	3.92E+00	3.92E+00	3.92E+00
1264	3.93E+00	3.93E+00	3.93E+00	3.93E+00	3.93E+00	3.93E+00	3.93E+00	3.93E+00	3.93E+00	3.93E+00	3.93E+00	3.93E+00
1265	3.93E+00	3.93E+00	3.93E+00	3.93E+00	3.93E+00	3.93E+00	3.93E+00	3.93E+00	3.93E+00	3.93E+00	3.93E+00	3.93E+00
Biased Statistics												
Average Biased	3.93E+00	3.93E+00	3.93E+00	3.93E+00	3.93E+00	3.93E+00	3.93E+00	3.93E+00	3.93E+00	3.93E+00	3.93E+00	3.92E+00
Std Dev Biased	1.79E-03	1.75E-03	2.15E-03	1.96E-03	2.17E-03	2.11E-03	2.16E-03	2.16E-03	2.16E-03	2.16E-03	2.05E-03	2.21E-03
Ps90%/90% (+KTL) Biased	3.93E+00	3.93E+00	3.93E+00	3.93E+00	3.93E+00	3.93E+00	3.93E+00	3.93E+00	3.93E+00	3.93E+00	3.93E+00	3.92E+00
Ps90%/90% (-KTL) Biased	3.93E+00	3.92E+00	3.92E+00	3.92E+00	3.92E+00	3.92E+00	3.92E+00	3.92E+00	3.92E+00	3.92E+00	3.92E+00	3.92E+00
Specification MIN	3.70E+00	3.70E+00	3.65E+00	3.65E+00	3.65E+00	3.55E+00	3.55E+00	3.55E+00	3.55E+00	3.55E+00	3.45E+00	3.40E+00
Status	PASS	PASS	PASS	PASS	PASS	PASS	PASS	PASS	PASS	PASS	PASS	PASS

An ISO 9001:2008 and DSCC Certified Company

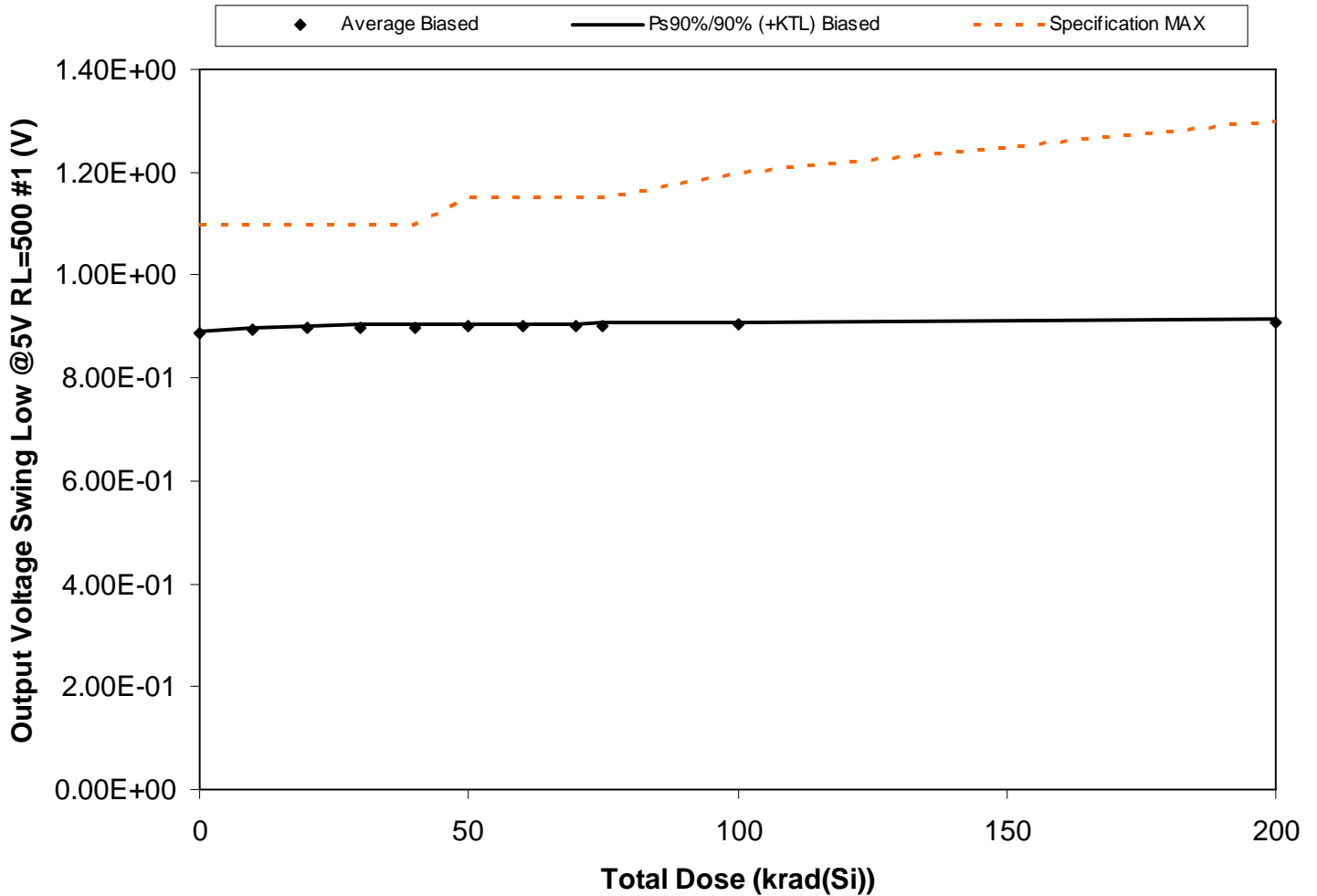

Figure 5.129. Plot of Output Voltage Swing Low @5V RL=500 #1 (V) versus total dose. The solid diamonds are the average of the measured data points for the samples irradiated under electrical bias and the black lines (solid and/or dashed) are the average of the data points after application of the KTL statistics on the samples irradiated under electrical bias. The red dotted line(s) are the pre- and/or post-irradiation minimum and/or maximum specification value as defined in the datasheet and/or test plan.



**RLAT Report
10-326 100808 R1.0**

**Radiation Assured Devices
5017 N. 30th Street
Colorado Springs, CO 80919
(719) 531-0800**

Table 5.129. Raw data for Output Voltage Swing Low @5V RL=500 #1 (V) versus total dose, including the statistical analysis, specification and the status of the testing (pass/fail).

Output Voltage Swing Low @5V RL=500 #1 (V)	Total Dose (krad(Si))											
	0	10	20	30	40	50	60	70	75	100	200	
Device												
1245	8.90E-01	8.94E-01	8.96E-01	8.98E-01	8.99E-01	8.99E-01	9.00E-01	9.00E-01	9.01E-01	9.02E-01	9.04E-01	
1246	8.90E-01	8.96E-01	8.99E-01	9.01E-01	9.01E-01	9.02E-01	9.03E-01	9.03E-01	9.04E-01	9.06E-01	9.10E-01	
1247	8.87E-01	8.94E-01	8.97E-01	8.98E-01	9.00E-01	9.00E-01	9.01E-01	9.02E-01	9.02E-01	9.05E-01	9.10E-01	
1248	8.86E-01	8.90E-01	8.92E-01	8.92E-01	8.94E-01	8.96E-01	8.96E-01	8.98E-01	8.99E-01	9.01E-01	9.07E-01	
1249	8.86E-01	8.93E-01	8.95E-01	8.96E-01	8.96E-01	8.96E-01	8.97E-01	8.97E-01	8.97E-01	8.99E-01	9.03E-01	
1250	8.89E-01	8.96E-01	8.99E-01	8.99E-01	9.00E-01	9.01E-01	9.01E-01	9.02E-01	9.02E-01	9.03E-01	9.06E-01	
1251	8.89E-01	8.95E-01	8.97E-01	8.99E-01	8.99E-01	9.00E-01	9.00E-01	9.00E-01	9.01E-01	9.03E-01	9.06E-01	
1261	8.86E-01	8.93E-01	8.96E-01	8.97E-01	8.98E-01	8.99E-01	9.00E-01	9.00E-01	9.00E-01	9.03E-01	9.08E-01	
1262	8.86E-01	8.93E-01	8.96E-01	8.98E-01	8.99E-01	8.99E-01	9.00E-01	9.01E-01	9.01E-01	9.04E-01	9.11E-01	
1263	8.90E-01	8.96E-01	8.99E-01	9.01E-01	9.02E-01	9.04E-01	9.04E-01	9.06E-01	9.06E-01	9.08E-01	9.13E-01	
1264	8.87E-01	8.89E-01	8.89E-01	8.89E-01	8.89E-01	8.89E-01	8.89E-01	8.88E-01	8.89E-01	8.89E-01	8.88E-01	
1265	8.92E-01	8.95E-01	8.95E-01	8.94E-01	8.94E-01	8.94E-01	8.94E-01	8.94E-01	8.94E-01	8.94E-01	8.93E-01	
Biased Statistics												
Average Biased	8.88E-01	8.94E-01	8.97E-01	8.98E-01	8.99E-01	9.00E-01	9.00E-01	9.01E-01	9.01E-01	9.03E-01	9.08E-01	
Std Dev Biased	1.85E-03	1.89E-03	2.17E-03	2.60E-03	2.35E-03	2.46E-03	2.39E-03	2.56E-03	2.50E-03	2.55E-03	3.19E-03	
Ps90%/90% (+KTL) Biased	8.92E-01	8.98E-01	9.01E-01	9.03E-01	9.04E-01	9.05E-01	9.05E-01	9.06E-01	9.06E-01	9.09E-01	9.14E-01	
Ps90%/90% (-KTL) Biased	8.84E-01	8.90E-01	8.92E-01	8.93E-01	8.94E-01	8.95E-01	8.95E-01	8.96E-01	8.96E-01	8.98E-01	9.01E-01	
Specification MAX	1.10E+00	1.10E+00	1.10E+00	1.10E+00	1.10E+00	1.15E+00	1.15E+00	1.15E+00	1.15E+00	1.20E+00	1.30E+00	
Status	PASS	PASS	PASS	PASS	PASS	PASS	PASS	PASS	PASS	PASS	PASS	

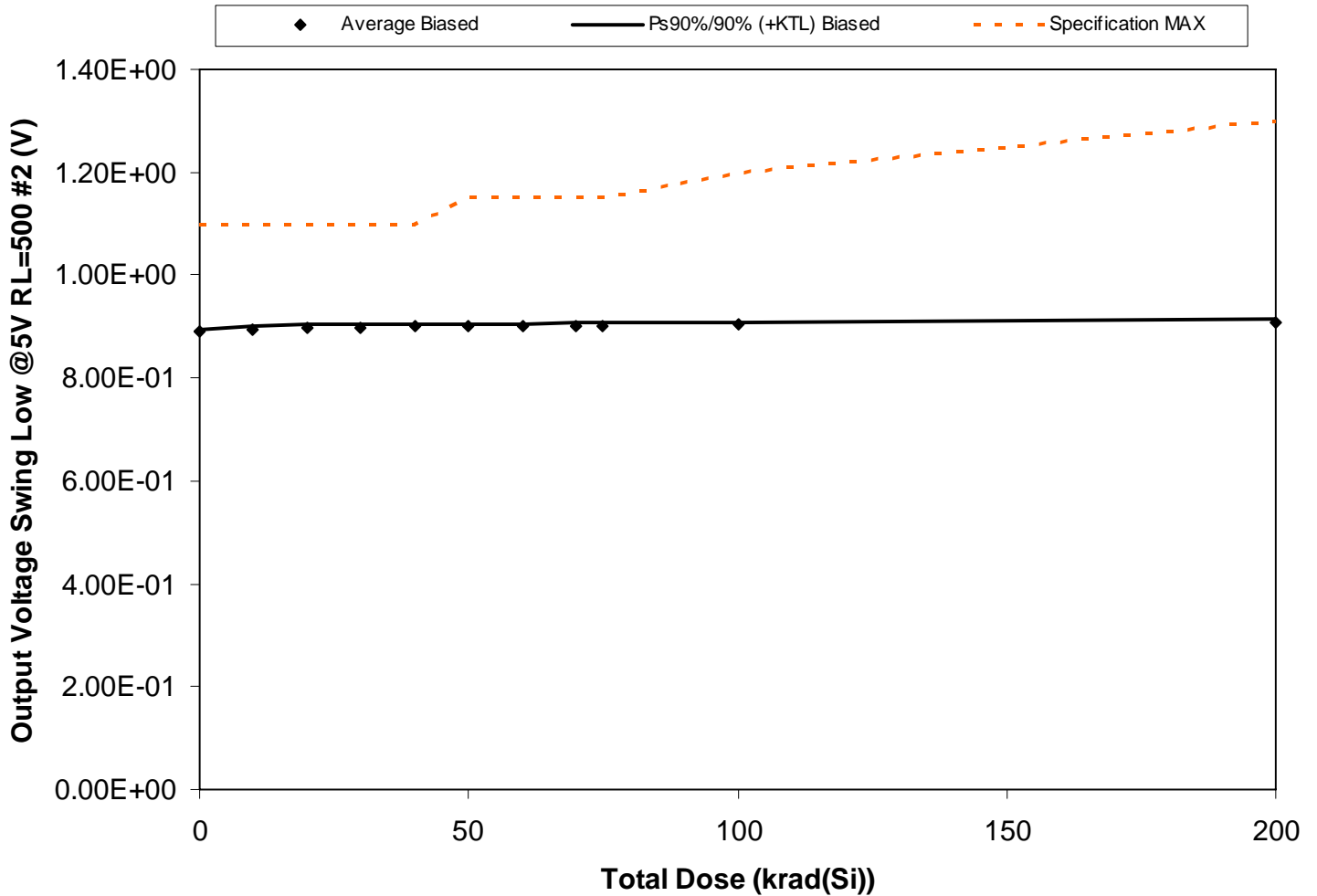

Figure 5.130. Plot of Output Voltage Swing Low @5V RL=500 #2 (V) versus total dose. The solid diamonds are the average of the measured data points for the samples irradiated under electrical bias and the black lines (solid and/or dashed) are the average of the data points after application of the KTL statistics on the samples irradiated under electrical bias. The red dotted line(s) are the pre- and/or post-irradiation minimum and/or maximum specification value as defined in the datasheet and/or test plan.



**RLAT Report
10-326 100808 R1.0**

**Radiation Assured Devices
5017 N. 30th Street
Colorado Springs, CO 80919
(719) 531-0800**

Table 5.130. Raw data for Output Voltage Swing Low @5V RL=500 #2 (V) versus total dose, including the statistical analysis, specification and the status of the testing (pass/fail).

Output Voltage Swing Low @5V RL=500 #2 (V)	Total Dose (krad(Si))											
	0	10	20	30	40	50	60	70	75	100	200	
Device												
1245	8.92E-01	8.97E-01	9.00E-01	9.01E-01	9.01E-01	9.02E-01	9.02E-01	9.03E-01	9.02E-01	9.04E-01	9.06E-01	
1246	8.92E-01	8.98E-01	9.00E-01	9.01E-01	9.01E-01	9.02E-01	9.02E-01	9.03E-01	9.03E-01	9.05E-01	9.12E-01	
1247	8.88E-01	8.93E-01	8.97E-01	8.98E-01	8.99E-01	9.00E-01	9.00E-01	9.01E-01	9.01E-01	9.04E-01	9.09E-01	
1248	8.86E-01	8.89E-01	8.91E-01	8.93E-01	8.94E-01	8.95E-01	8.97E-01	8.98E-01	8.99E-01	9.02E-01	9.10E-01	
1249	8.89E-01	8.95E-01	8.97E-01	8.99E-01	9.00E-01	9.01E-01	9.02E-01	9.03E-01	9.03E-01	9.05E-01	9.11E-01	
1250	8.90E-01	8.97E-01	8.99E-01	9.02E-01	9.03E-01	9.04E-01	9.04E-01	9.05E-01	9.06E-01	9.08E-01	9.13E-01	
1251	8.89E-01	8.96E-01	8.98E-01	9.00E-01	9.01E-01	9.01E-01	9.02E-01	9.02E-01	9.03E-01	9.05E-01	9.11E-01	
1261	8.87E-01	8.93E-01	8.97E-01	8.98E-01	8.99E-01	8.99E-01	9.00E-01	9.01E-01	9.02E-01	9.03E-01	9.10E-01	
1262	8.92E-01	8.97E-01	9.00E-01	9.00E-01	9.00E-01	9.01E-01	9.00E-01	9.01E-01	9.02E-01	9.03E-01	9.09E-01	
1263	8.86E-01	8.92E-01	8.94E-01	8.95E-01	8.96E-01	8.97E-01	8.97E-01	8.97E-01	8.97E-01	8.98E-01	9.02E-01	
1264	8.88E-01	8.91E-01	8.91E-01	8.90E-01	8.90E-01	8.90E-01	8.90E-01	8.90E-01	8.90E-01	8.90E-01	8.90E-01	
1265	8.92E-01	8.94E-01	8.94E-01	8.94E-01	8.94E-01	8.94E-01	8.94E-01	8.93E-01	8.93E-01	8.94E-01	8.93E-01	
Biased Statistics												
Average Biased	8.89E-01	8.95E-01	8.97E-01	8.99E-01	8.99E-01	9.00E-01	9.01E-01	9.01E-01	9.02E-01	9.04E-01	9.09E-01	
Std Dev Biased	2.38E-03	2.87E-03	2.91E-03	2.83E-03	2.63E-03	2.62E-03	2.27E-03	2.41E-03	2.44E-03	2.58E-03	3.20E-03	
Ps90%/90% (+KTL) Biased	8.94E-01	9.01E-01	9.03E-01	9.05E-01	9.05E-01	9.06E-01	9.05E-01	9.06E-01	9.07E-01	9.09E-01	9.16E-01	
Ps90%/90% (-KTL) Biased	8.84E-01	8.89E-01	8.91E-01	8.93E-01	8.94E-01	8.95E-01	8.96E-01	8.96E-01	8.97E-01	8.98E-01	9.03E-01	
Specification MAX	1.10E+00	1.10E+00	1.10E+00	1.10E+00	1.10E+00	1.15E+00	1.15E+00	1.15E+00	1.15E+00	1.20E+00	1.30E+00	
Status	PASS	PASS	PASS	PASS	PASS	PASS	PASS	PASS	PASS	PASS	PASS	

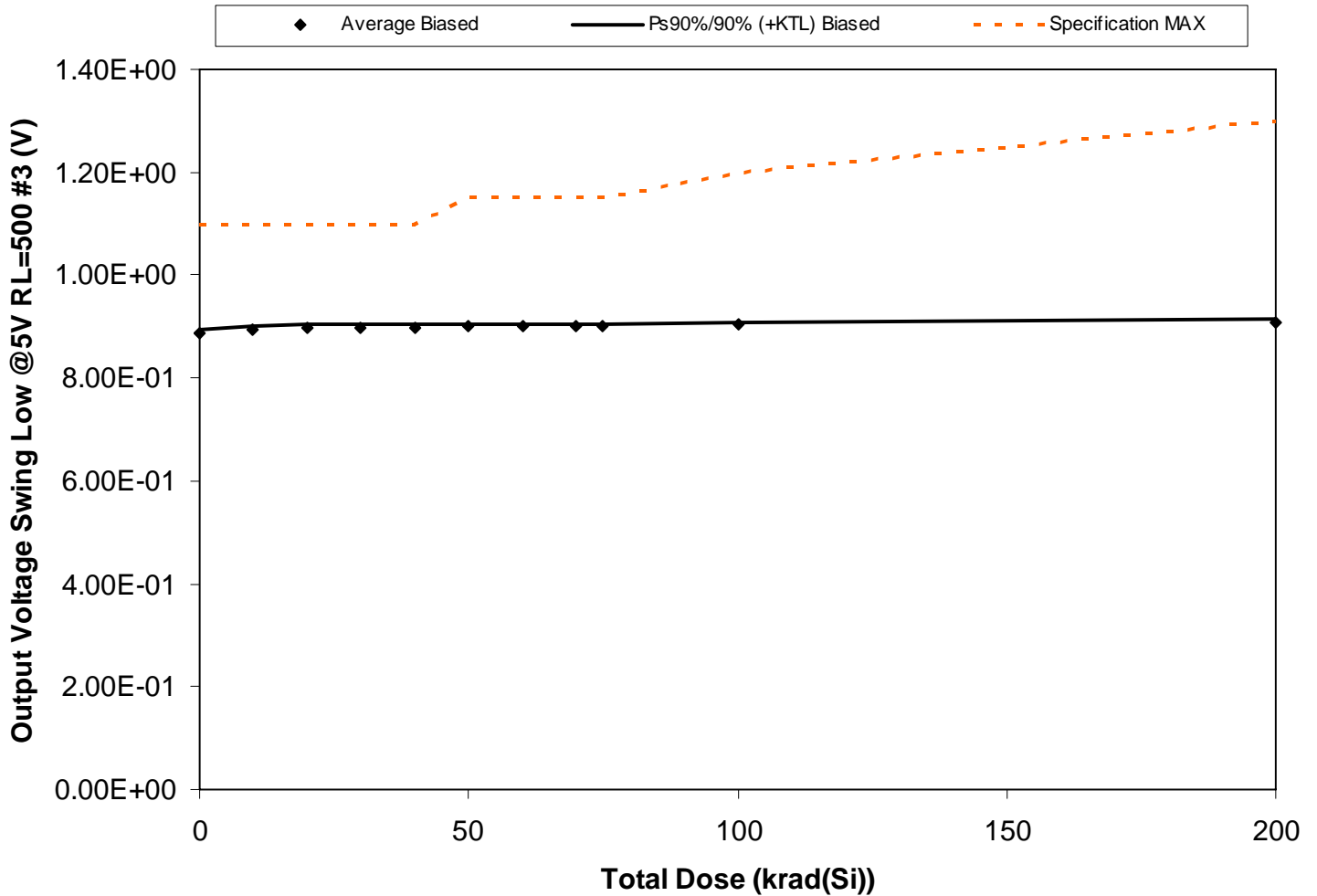

Figure 5.131. Plot of Output Voltage Swing Low @5V RL=500 #3 (V) versus total dose. The solid diamonds are the average of the measured data points for the samples irradiated under electrical bias and the black lines (solid and/or dashed) are the average of the data points after application of the KTL statistics on the samples irradiated under electrical bias. The red dotted line(s) are the pre- and/or post-irradiation minimum and/or maximum specification value as defined in the datasheet and/or test plan.



**RLAT Report
10-326 100808 R1.0**

**Radiation Assured Devices
5017 N. 30th Street
Colorado Springs, CO 80919
(719) 531-0800**

Table 5.131. Raw data for Output Voltage Swing Low @5V RL=500 #3 (V) versus total dose, including the statistical analysis, specification and the status of the testing (pass/fail).

Output Voltage Swing Low @5V RL=500 #3 (V)	Total Dose (krad(Si))											
	0	10	20	30	40	50	60	70	75	100	200	
Device												
1245	8.92E-01	8.98E-01	9.00E-01	9.00E-01	9.01E-01	9.01E-01	9.01E-01	9.01E-01	9.02E-01	9.04E-01	9.08E-01	
1246	8.90E-01	8.97E-01	9.00E-01	9.01E-01	9.01E-01	9.03E-01	9.03E-01	9.04E-01	9.04E-01	9.07E-01	9.12E-01	
1247	8.88E-01	8.95E-01	8.98E-01	8.99E-01	9.00E-01	9.02E-01	9.02E-01	9.02E-01	9.03E-01	9.05E-01	9.11E-01	
1248	8.85E-01	8.89E-01	8.91E-01	8.92E-01	8.94E-01	8.95E-01	8.96E-01	8.98E-01	8.99E-01	9.02E-01	9.09E-01	
1249	8.89E-01	8.96E-01	8.98E-01	9.00E-01	9.00E-01	9.02E-01	9.02E-01	9.03E-01	9.04E-01	9.06E-01	9.12E-01	
1250	8.91E-01	8.97E-01	8.99E-01	9.01E-01	9.01E-01	9.02E-01	9.02E-01	9.02E-01	9.03E-01	9.04E-01	9.07E-01	
1251	8.86E-01	8.93E-01	8.96E-01	8.97E-01	8.98E-01	8.99E-01	8.99E-01	8.99E-01	9.00E-01	9.01E-01	9.07E-01	
1261	8.88E-01	8.94E-01	8.97E-01	8.98E-01	8.98E-01	8.99E-01	8.98E-01	8.98E-01	8.99E-01	9.00E-01	9.02E-01	
1262	8.87E-01	8.93E-01	8.96E-01	8.97E-01	8.98E-01	8.98E-01	8.98E-01	8.99E-01	8.99E-01	9.01E-01	9.04E-01	
1263	8.85E-01	8.91E-01	8.93E-01	8.95E-01	8.95E-01	8.96E-01	8.96E-01	8.96E-01	8.97E-01	8.98E-01	9.03E-01	
1264	8.88E-01	8.90E-01	8.90E-01	8.90E-01	8.90E-01	8.90E-01	8.89E-01	8.89E-01	8.89E-01	8.90E-01	8.89E-01	
1265	8.92E-01	8.95E-01	8.94E-01	8.94E-01	8.94E-01	8.94E-01	8.94E-01	8.94E-01	8.93E-01	8.93E-01	8.94E-01	
Biased Statistics												
Average Biased	8.88E-01	8.94E-01	8.97E-01	8.98E-01	8.99E-01	9.00E-01	9.00E-01	9.00E-01	9.01E-01	9.03E-01	9.08E-01	
Std Dev Biased	2.42E-03	2.87E-03	2.94E-03	2.87E-03	2.50E-03	2.75E-03	2.63E-03	2.57E-03	2.49E-03	2.86E-03	3.63E-03	
Ps90%/90% (+KTL) Biased	8.93E-01	9.00E-01	9.03E-01	9.04E-01	9.04E-01	9.05E-01	9.05E-01	9.06E-01	9.06E-01	9.09E-01	9.15E-01	
Ps90%/90% (-KTL) Biased	8.83E-01	8.88E-01	8.91E-01	8.92E-01	8.93E-01	8.94E-01	8.94E-01	8.95E-01	8.96E-01	8.97E-01	9.00E-01	
Specification MAX	1.10E+00	1.10E+00	1.10E+00	1.10E+00	1.10E+00	1.15E+00	1.15E+00	1.15E+00	1.15E+00	1.20E+00	1.30E+00	
Status	PASS	PASS	PASS	PASS	PASS	PASS	PASS	PASS	PASS	PASS	PASS	

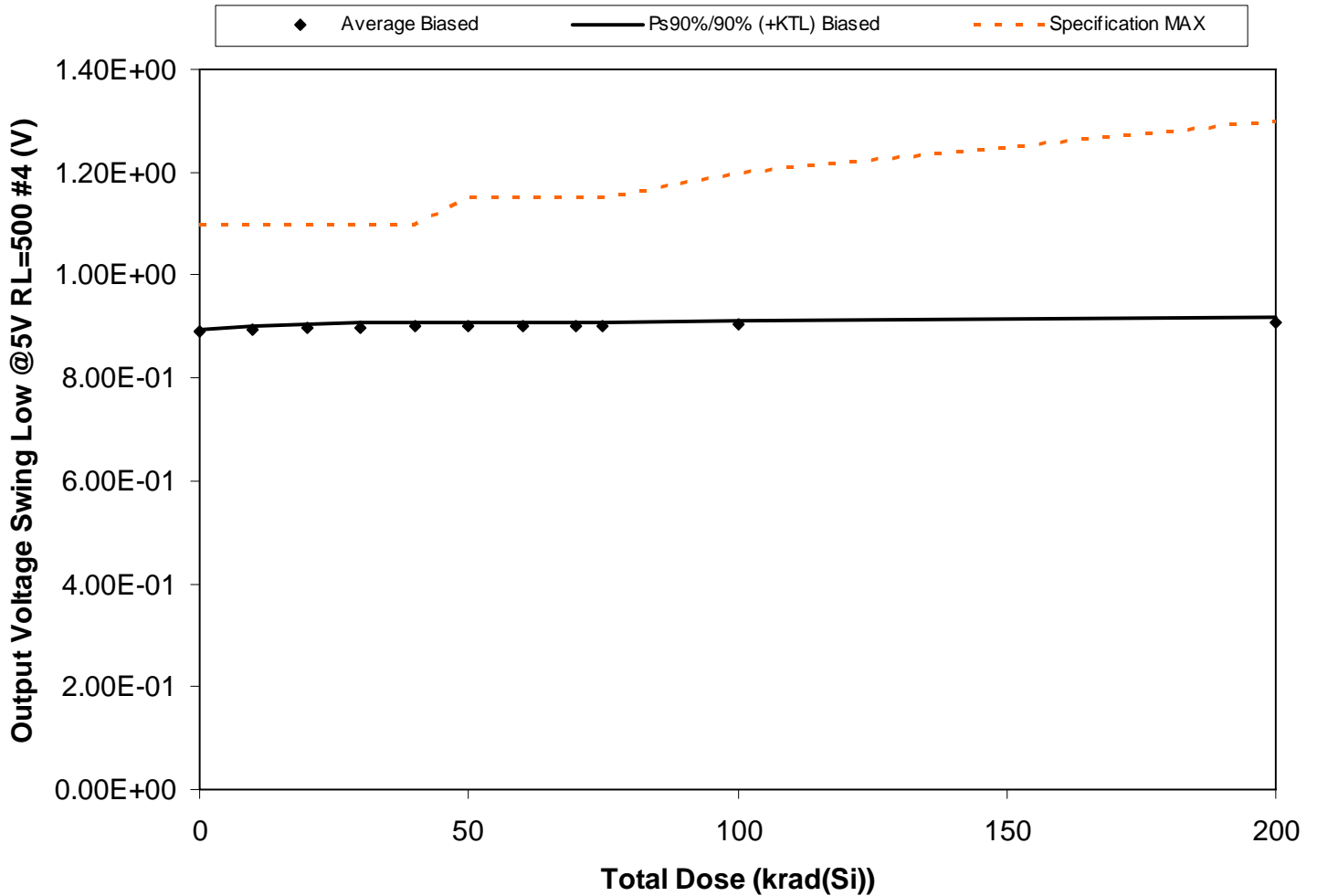

Figure 5.132. Plot of Output Voltage Swing Low @5V RL=500 #4 (V) versus total dose. The solid diamonds are the average of the measured data points for the samples irradiated under electrical bias and the black lines (solid and/or dashed) are the average of the data points after application of the KTL statistics on the samples irradiated under electrical bias. The red dotted line(s) are the pre- and/or post-irradiation minimum and/or maximum specification value as defined in the datasheet and/or test plan.



**RLAT Report
10-326 100808 R1.0**

**Radiation Assured Devices
5017 N. 30th Street
Colorado Springs, CO 80919
(719) 531-0800**

Table 5.132. Raw data for Output Voltage Swing Low @5V RL=500 #4 (V) versus total dose, including the statistical analysis, specification and the status of the testing (pass/fail).

Output Voltage Swing Low @5V RL=500 #4 (V)	Total Dose (krad(Si))											
	0	10	20	30	40	50	60	70	75	100	200	
Device												
1245	8.94E-01	8.98E-01	9.00E-01	9.02E-01	9.03E-01	9.04E-01	9.04E-01	9.04E-01	9.05E-01	9.06E-01	9.08E-01	
1246	8.89E-01	8.95E-01	8.98E-01	8.98E-01	8.99E-01	9.00E-01	9.00E-01	9.01E-01	9.02E-01	9.03E-01	9.06E-01	
1247	8.87E-01	8.93E-01	8.96E-01	8.97E-01	8.98E-01	8.98E-01	8.98E-01	8.99E-01	9.00E-01	9.02E-01	9.05E-01	
1248	8.85E-01	8.88E-01	8.90E-01	8.90E-01	8.92E-01	8.93E-01	8.94E-01	8.95E-01	8.96E-01	8.99E-01	9.03E-01	
1249	8.87E-01	8.92E-01	8.95E-01	8.97E-01	8.98E-01	8.98E-01	8.99E-01	8.99E-01	9.00E-01	9.01E-01	9.07E-01	
1250	8.90E-01	8.96E-01	8.98E-01	8.99E-01	9.00E-01	9.01E-01	9.01E-01	9.01E-01	9.02E-01	9.03E-01	9.06E-01	
1251	8.90E-01	8.97E-01	9.00E-01	9.01E-01	9.02E-01	9.02E-01	9.03E-01	9.04E-01	9.05E-01	9.06E-01	9.11E-01	
1261	8.88E-01	8.95E-01	8.98E-01	9.00E-01	9.01E-01	9.02E-01	9.03E-01	9.04E-01	9.05E-01	9.07E-01	9.16E-01	
1262	8.87E-01	8.93E-01	8.96E-01	8.98E-01	8.99E-01	9.00E-01	9.01E-01	9.01E-01	9.01E-01	9.04E-01	9.10E-01	
1263	8.92E-01	8.97E-01	9.02E-01	9.04E-01	9.04E-01	9.04E-01	9.06E-01	9.06E-01	9.07E-01	9.09E-01	9.14E-01	
1264	8.88E-01	8.90E-01	8.90E-01	8.90E-01	8.90E-01	8.89E-01	8.89E-01	8.89E-01	8.89E-01	8.89E-01	8.89E-01	
1265	8.90E-01	8.92E-01	8.92E-01	8.92E-01	8.92E-01	8.91E-01	8.91E-01	8.91E-01	8.91E-01	8.91E-01	8.91E-01	
Biased Statistics												
Average Biased	8.89E-01	8.94E-01	8.97E-01	8.99E-01	9.00E-01	9.00E-01	9.01E-01	9.01E-01	9.02E-01	9.04E-01	9.09E-01	
Std Dev Biased	2.69E-03	2.99E-03	3.33E-03	3.78E-03	3.37E-03	3.29E-03	3.41E-03	3.24E-03	3.27E-03	3.02E-03	4.12E-03	
Ps90%/90% (+KTL) Biased	8.94E-01	9.01E-01	9.04E-01	9.06E-01	9.07E-01	9.07E-01	9.08E-01	9.08E-01	9.09E-01	9.10E-01	9.17E-01	
Ps90%/90% (-KTL) Biased	8.83E-01	8.88E-01	8.90E-01	8.91E-01	8.93E-01	8.93E-01	8.94E-01	8.95E-01	8.96E-01	8.98E-01	9.00E-01	
Specification MAX	1.10E+00	1.10E+00	1.10E+00	1.10E+00	1.10E+00	1.15E+00	1.15E+00	1.15E+00	1.15E+00	1.20E+00	1.30E+00	
Status	PASS	PASS	PASS	PASS	PASS	PASS	PASS	PASS	PASS	PASS	PASS	

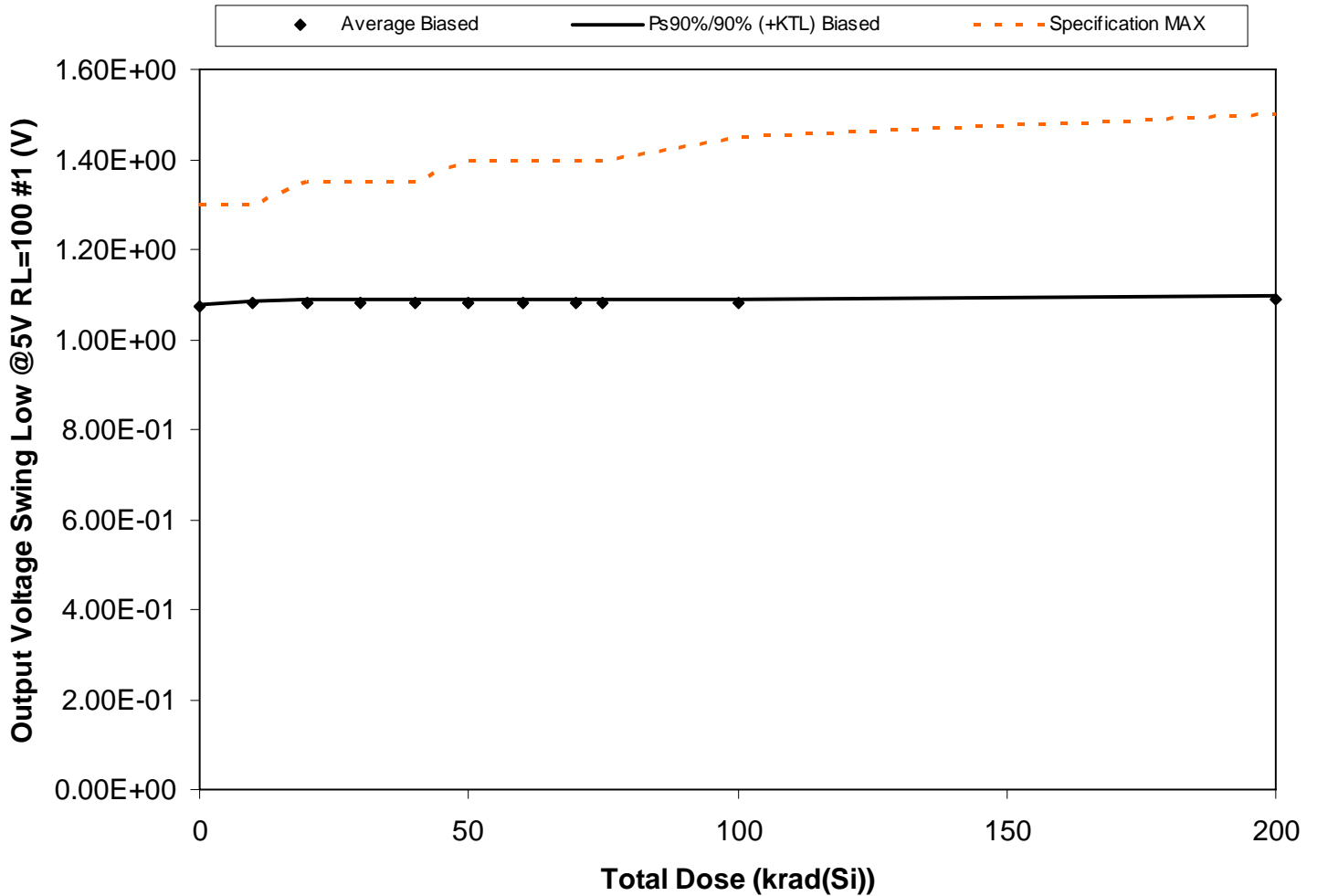

Figure 5.133. Plot of Output Voltage Swing Low @5V RL=100 #1 (V) versus total dose. The solid diamonds are the average of the measured data points for the samples irradiated under electrical bias and the black lines (solid and/or dashed) are the average of the data points after application of the KTL statistics on the samples irradiated under electrical bias. The red dotted line(s) are the pre- and/or post-irradiation minimum and/or maximum specification value as defined in the datasheet and/or test plan.



**RLAT Report
10-326 100808 R1.0**

**Radiation Assured Devices
5017 N. 30th Street
Colorado Springs, CO 80919
(719) 531-0800**

Table 5.133. Raw data for Output Voltage Swing Low @5V RL=100 #1 (V) versus total dose, including the statistical analysis, specification and the status of the testing (pass/fail).

Output Voltage Swing Low @5V RL=100 #1 (V)	Total Dose (krad(Si))											
	0	10	20	30	40	50	60	70	75	100	200	
Device												
1245	1.08E+00	1.08E+00	1.08E+00	1.08E+00	1.08E+00	1.08E+00	1.08E+00	1.08E+00	1.08E+00	1.08E+00	1.08E+00	1.09E+00
1246	1.08E+00	1.08E+00	1.08E+00	1.08E+00	1.08E+00	1.08E+00	1.08E+00	1.08E+00	1.08E+00	1.08E+00	1.09E+00	1.09E+00
1247	1.07E+00	1.08E+00	1.08E+00	1.08E+00	1.08E+00	1.08E+00	1.08E+00	1.08E+00	1.08E+00	1.08E+00	1.08E+00	1.09E+00
1248	1.07E+00	1.07E+00	1.07E+00	1.07E+00	1.07E+00	1.07E+00	1.07E+00	1.07E+00	1.08E+00	1.08E+00	1.08E+00	1.09E+00
1249	1.07E+00	1.08E+00	1.08E+00	1.08E+00	1.08E+00	1.08E+00	1.08E+00	1.08E+00	1.08E+00	1.08E+00	1.08E+00	1.08E+00
1250	1.08E+00	1.08E+00	1.08E+00	1.08E+00	1.08E+00	1.08E+00	1.08E+00	1.08E+00	1.08E+00	1.08E+00	1.08E+00	1.09E+00
1251	1.08E+00	1.08E+00	1.09E+00	1.09E+00	1.08E+00	1.08E+00	1.08E+00	1.08E+00	1.08E+00	1.08E+00	1.09E+00	1.09E+00
1261	1.07E+00	1.08E+00	1.08E+00	1.08E+00	1.08E+00	1.08E+00	1.08E+00	1.08E+00	1.08E+00	1.08E+00	1.09E+00	1.09E+00
1262	1.07E+00	1.08E+00	1.08E+00	1.08E+00	1.08E+00	1.08E+00	1.08E+00	1.08E+00	1.08E+00	1.08E+00	1.08E+00	1.09E+00
1263	1.08E+00	1.08E+00	1.08E+00	1.08E+00	1.08E+00	1.08E+00	1.08E+00	1.08E+00	1.09E+00	1.09E+00	1.09E+00	1.09E+00
1264	1.07E+00	1.08E+00	1.08E+00	1.08E+00	1.08E+00	1.08E+00	1.08E+00	1.08E+00	1.08E+00	1.08E+00	1.08E+00	1.07E+00
1265	1.08E+00	1.08E+00	1.08E+00	1.08E+00	1.08E+00	1.08E+00	1.08E+00	1.08E+00	1.08E+00	1.08E+00	1.08E+00	1.08E+00
Biased Statistics												
Average Biased	1.07E+00	1.08E+00	1.08E+00	1.08E+00	1.08E+00	1.08E+00	1.08E+00	1.08E+00	1.08E+00	1.08E+00	1.08E+00	1.09E+00
Std Dev Biased	2.45E-03	3.47E-03	4.14E-03	4.17E-03	4.02E-03	3.60E-03	3.47E-03	3.20E-03	3.37E-03	3.27E-03	3.52E-03	
Ps90%/90% (+KTL) Biased	1.08E+00	1.09E+00	1.09E+00	1.09E+00	1.09E+00	1.09E+00	1.09E+00	1.09E+00	1.09E+00	1.09E+00	1.09E+00	1.10E+00
Ps90%/90% (-KTL) Biased	1.07E+00	1.07E+00	1.07E+00	1.07E+00	1.07E+00	1.07E+00	1.07E+00	1.07E+00	1.07E+00	1.07E+00	1.08E+00	1.08E+00
Specification MAX	1.30E+00	1.30E+00	1.35E+00	1.35E+00	1.35E+00	1.40E+00	1.40E+00	1.40E+00	1.40E+00	1.45E+00	1.50E+00	
Status	PASS	PASS	PASS	PASS	PASS	PASS	PASS	PASS	PASS	PASS	PASS	PASS

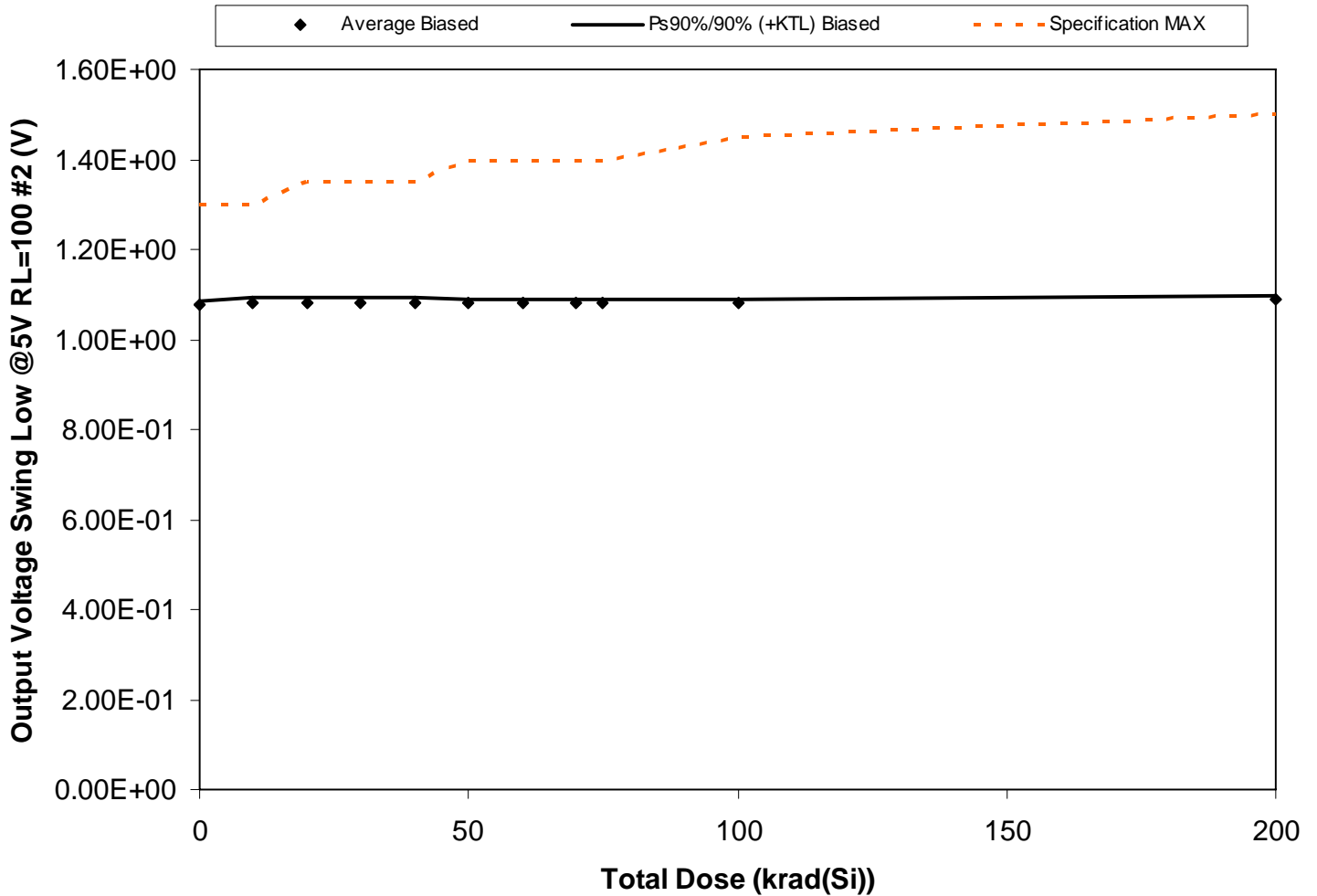

Figure 5.134. Plot of Output Voltage Swing Low @5V RL=100 #2 (V) versus total dose. The solid diamonds are the average of the measured data points for the samples irradiated under electrical bias and the black lines (solid and/or dashed) are the average of the data points after application of the KTL statistics on the samples irradiated under electrical bias. The red dotted line(s) are the pre- and/or post-irradiation minimum and/or maximum specification value as defined in the datasheet and/or test plan.



**RLAT Report
10-326 100808 R1.0**

**Radiation Assured Devices
5017 N. 30th Street
Colorado Springs, CO 80919
(719) 531-0800**

Table 5.134. Raw data for Output Voltage Swing Low @5V RL=100 #2 (V) versus total dose, including the statistical analysis, specification and the status of the testing (pass/fail).

Output Voltage Swing Low @5V RL=100 #2 (V)	Total Dose (krad(Si))											
	0	10	20	30	40	50	60	70	75	100	200	
Device												
1245	1.08E+00	1.09E+00	1.09E+00	1.09E+00	1.09E+00	1.09E+00	1.09E+00	1.09E+00	1.09E+00	1.09E+00	1.09E+00	1.09E+00
1246	1.08E+00	1.09E+00	1.09E+00	1.08E+00	1.08E+00	1.08E+00	1.08E+00	1.08E+00	1.08E+00	1.08E+00	1.08E+00	1.09E+00
1247	1.07E+00	1.08E+00	1.08E+00	1.08E+00	1.08E+00	1.08E+00	1.08E+00	1.08E+00	1.08E+00	1.08E+00	1.08E+00	1.09E+00
1248	1.07E+00	1.07E+00	1.07E+00	1.07E+00	1.07E+00	1.07E+00	1.07E+00	1.07E+00	1.07E+00	1.07E+00	1.08E+00	1.09E+00
1249	1.07E+00	1.08E+00	1.08E+00	1.08E+00	1.08E+00	1.08E+00	1.08E+00	1.08E+00	1.08E+00	1.08E+00	1.08E+00	1.09E+00
1250	1.08E+00	1.08E+00	1.08E+00	1.09E+00	1.09E+00	1.09E+00	1.09E+00	1.09E+00	1.09E+00	1.09E+00	1.09E+00	1.09E+00
1251	1.08E+00	1.08E+00	1.08E+00	1.08E+00	1.08E+00	1.08E+00	1.08E+00	1.08E+00	1.08E+00	1.08E+00	1.08E+00	1.09E+00
1261	1.07E+00	1.08E+00	1.08E+00	1.08E+00	1.08E+00	1.08E+00	1.08E+00	1.08E+00	1.08E+00	1.08E+00	1.08E+00	1.09E+00
1262	1.08E+00	1.09E+00	1.09E+00	1.08E+00	1.08E+00	1.08E+00	1.08E+00	1.08E+00	1.08E+00	1.08E+00	1.08E+00	1.09E+00
1263	1.07E+00	1.07E+00	1.08E+00	1.08E+00	1.08E+00	1.08E+00	1.08E+00	1.08E+00	1.08E+00	1.08E+00	1.08E+00	1.08E+00
1264	1.08E+00	1.08E+00	1.08E+00	1.08E+00	1.08E+00	1.08E+00	1.08E+00	1.08E+00	1.08E+00	1.08E+00	1.08E+00	1.08E+00
1265	1.08E+00	1.08E+00	1.08E+00	1.08E+00	1.08E+00	1.08E+00	1.08E+00	1.08E+00	1.08E+00	1.08E+00	1.08E+00	1.08E+00
Biased Statistics												
Average Biased	1.08E+00	1.08E+00	1.08E+00	1.08E+00	1.08E+00	1.08E+00	1.08E+00	1.08E+00	1.08E+00	1.08E+00	1.08E+00	1.09E+00
Std Dev Biased	4.50E-03	5.30E-03	5.33E-03	5.13E-03	4.79E-03	4.42E-03	4.24E-03	3.79E-03	4.10E-03	3.63E-03	3.75E-03	
Ps90%/90% (+KTL) Biased	1.08E+00	1.09E+00	1.09E+00	1.09E+00	1.09E+00	1.09E+00	1.09E+00	1.09E+00	1.09E+00	1.09E+00	1.09E+00	1.10E+00
Ps90%/90% (-KTL) Biased	1.07E+00	1.07E+00	1.07E+00	1.07E+00	1.07E+00	1.07E+00	1.07E+00	1.07E+00	1.07E+00	1.07E+00	1.07E+00	1.08E+00
Specification MAX	1.30E+00	1.30E+00	1.35E+00	1.35E+00	1.35E+00	1.40E+00	1.40E+00	1.40E+00	1.40E+00	1.45E+00	1.50E+00	
Status	PASS	PASS	PASS	PASS	PASS	PASS	PASS	PASS	PASS	PASS	PASS	PASS

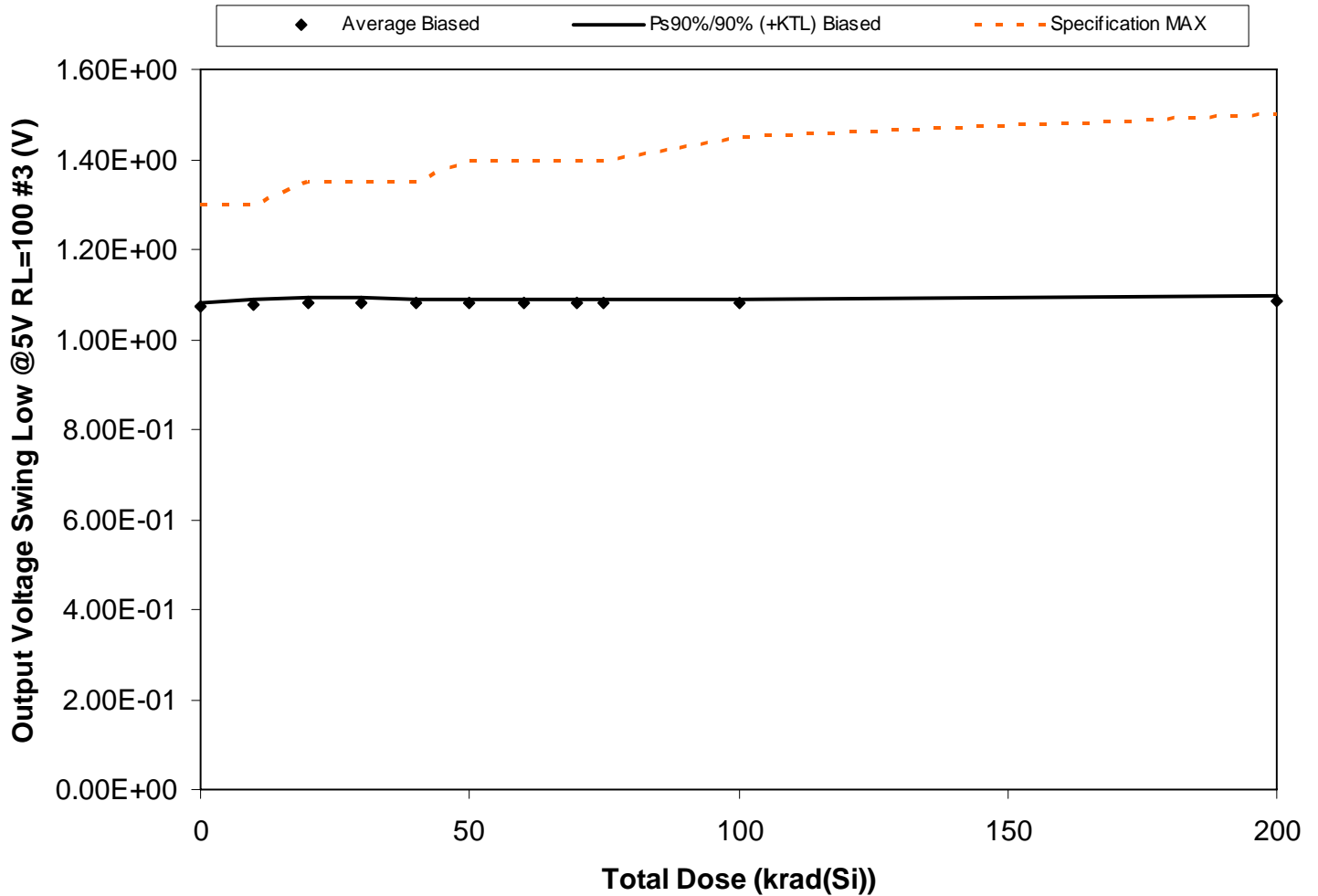

Figure 5.135. Plot of Output Voltage Swing Low @5V RL=100 #3 (V) versus total dose. The solid diamonds are the average of the measured data points for the samples irradiated under electrical bias and the black lines (solid and/or dashed) are the average of the data points after application of the KTL statistics on the samples irradiated under electrical bias. The red dotted line(s) are the pre- and/or post-irradiation minimum and/or maximum specification value as defined in the datasheet and/or test plan.



**RLAT Report
10-326 100808 R1.0**

**Radiation Assured Devices
5017 N. 30th Street
Colorado Springs, CO 80919
(719) 531-0800**

Table 5.135. Raw data for Output Voltage Swing Low @5V RL=100 #3 (V) versus total dose, including the statistical analysis, specification and the status of the testing (pass/fail).

Output Voltage Swing Low @5V RL=100 #3 (V)	Total Dose (krad(Si))											
	0	10	20	30	40	50	60	70	75	100	200	
Device												
1245	1.08E+00	1.09E+00	1.09E+00	1.09E+00	1.09E+00	1.09E+00	1.09E+00	1.09E+00	1.09E+00	1.09E+00	1.09E+00	1.09E+00
1246	1.07E+00	1.08E+00	1.08E+00	1.08E+00	1.08E+00	1.08E+00	1.08E+00	1.08E+00	1.08E+00	1.08E+00	1.08E+00	1.09E+00
1247	1.07E+00	1.08E+00	1.08E+00	1.08E+00	1.08E+00	1.08E+00	1.08E+00	1.08E+00	1.08E+00	1.08E+00	1.08E+00	1.09E+00
1248	1.07E+00	1.07E+00	1.07E+00	1.07E+00	1.07E+00	1.07E+00	1.07E+00	1.07E+00	1.07E+00	1.07E+00	1.08E+00	1.08E+00
1249	1.07E+00	1.08E+00	1.08E+00	1.08E+00	1.08E+00	1.08E+00	1.08E+00	1.08E+00	1.08E+00	1.08E+00	1.08E+00	1.09E+00
1250	1.08E+00	1.08E+00	1.08E+00	1.08E+00	1.08E+00	1.08E+00	1.08E+00	1.08E+00	1.08E+00	1.08E+00	1.08E+00	1.09E+00
1251	1.07E+00	1.08E+00	1.08E+00	1.08E+00	1.08E+00	1.08E+00	1.08E+00	1.08E+00	1.08E+00	1.08E+00	1.08E+00	1.09E+00
1261	1.07E+00	1.08E+00	1.08E+00	1.08E+00	1.08E+00	1.08E+00	1.08E+00	1.08E+00	1.08E+00	1.08E+00	1.08E+00	1.08E+00
1262	1.07E+00	1.08E+00	1.08E+00	1.08E+00	1.08E+00	1.08E+00	1.08E+00	1.08E+00	1.08E+00	1.08E+00	1.08E+00	1.09E+00
1263	1.07E+00	1.07E+00	1.08E+00	1.08E+00	1.08E+00	1.08E+00	1.08E+00	1.07E+00	1.07E+00	1.07E+00	1.08E+00	1.08E+00
1264	1.07E+00	1.08E+00	1.08E+00	1.08E+00	1.08E+00	1.08E+00	1.08E+00	1.08E+00	1.07E+00	1.08E+00	1.08E+00	1.07E+00
1265	1.08E+00	1.08E+00	1.08E+00	1.08E+00	1.08E+00	1.08E+00	1.08E+00	1.08E+00	1.08E+00	1.08E+00	1.08E+00	1.08E+00
Biased Statistics												
Average Biased	1.07E+00	1.08E+00	1.08E+00	1.08E+00	1.08E+00	1.08E+00	1.08E+00	1.08E+00	1.08E+00	1.08E+00	1.08E+00	1.09E+00
Std Dev Biased	3.77E-03	5.28E-03	5.42E-03	5.52E-03	4.80E-03	4.48E-03	4.21E-03	4.01E-03	3.89E-03	3.98E-03	4.01E-03	
Ps90%/90% (+KTL) Biased	1.08E+00	1.09E+00	1.09E+00	1.09E+00	1.09E+00	1.09E+00	1.09E+00	1.09E+00	1.09E+00	1.09E+00	1.09E+00	1.10E+00
Ps90%/90% (-KTL) Biased	1.07E+00	1.07E+00	1.07E+00	1.07E+00	1.07E+00	1.07E+00	1.07E+00	1.07E+00	1.07E+00	1.07E+00	1.07E+00	1.08E+00
Specification MAX	1.30E+00	1.30E+00	1.35E+00	1.35E+00	1.35E+00	1.40E+00	1.40E+00	1.40E+00	1.40E+00	1.45E+00	1.50E+00	
Status	PASS	PASS	PASS	PASS	PASS	PASS	PASS	PASS	PASS	PASS	PASS	PASS

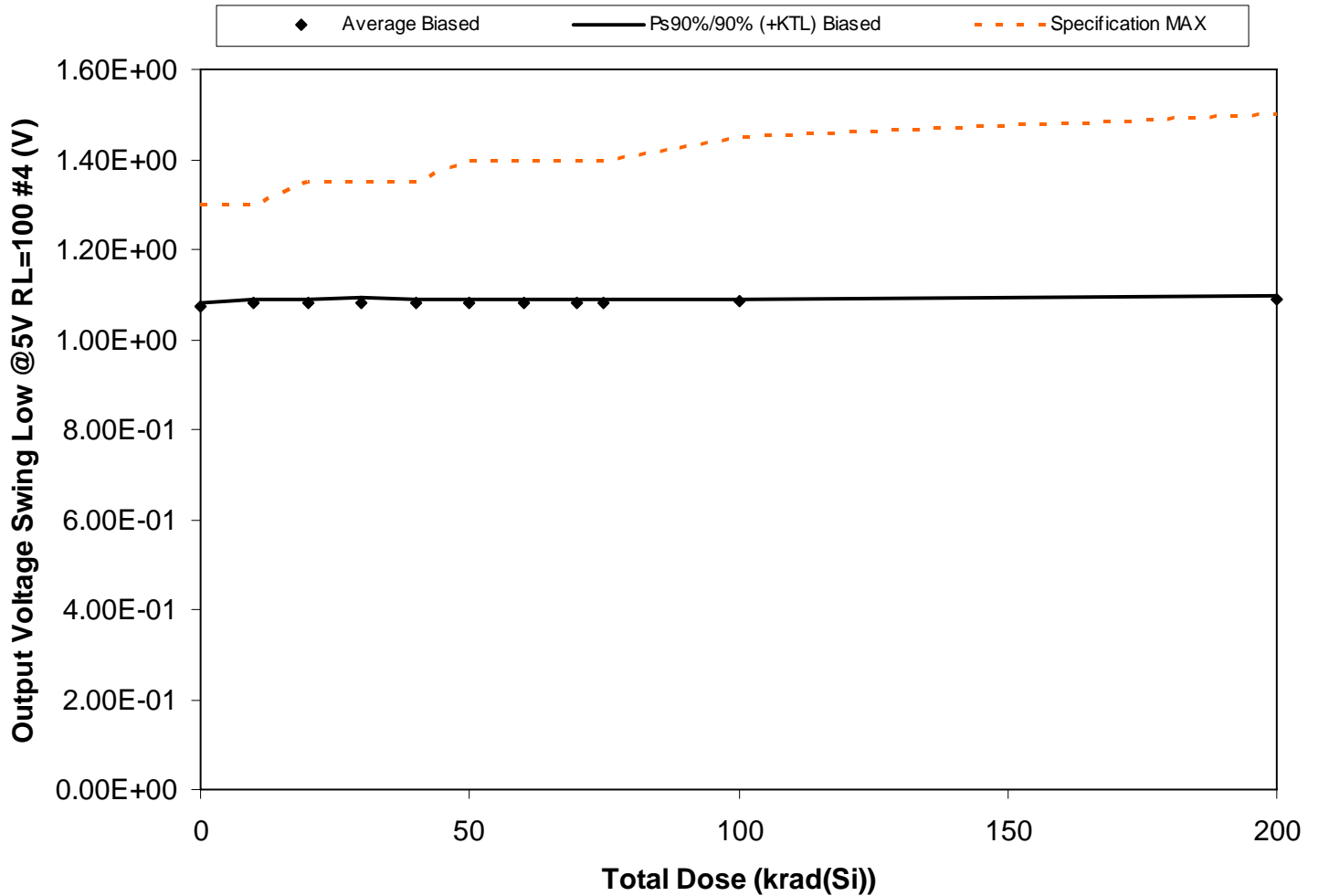

Figure 5.136. Plot of Output Voltage Swing Low @5V RL=100 #4 (V) versus total dose. The solid diamonds are the average of the measured data points for the samples irradiated under electrical bias and the black lines (solid and/or dashed) are the average of the data points after application of the KTL statistics on the samples irradiated under electrical bias. The red dotted line(s) are the pre- and/or post-irradiation minimum and/or maximum specification value as defined in the datasheet and/or test plan.



**RLAT Report
10-326 100808 R1.0**

**Radiation Assured Devices
5017 N. 30th Street
Colorado Springs, CO 80919
(719) 531-0800**

Table 5.136. Raw data for Output Voltage Swing Low @5V RL=100 #4 (V) versus total dose, including the statistical analysis, specification and the status of the testing (pass/fail).

Output Voltage Swing Low @5V RL=100 #4 (V)	Total Dose (krad(Si))											
	0	10	20	30	40	50	60	70	75	100	200	
Device												
1245	1.08E+00	1.08E+00	1.08E+00	1.08E+00	1.08E+00	1.08E+00	1.08E+00	1.08E+00	1.08E+00	1.08E+00	1.09E+00	1.09E+00
1246	1.08E+00	1.08E+00	1.08E+00	1.08E+00	1.08E+00	1.08E+00	1.08E+00	1.08E+00	1.08E+00	1.08E+00	1.08E+00	1.09E+00
1247	1.07E+00	1.08E+00	1.08E+00	1.08E+00	1.08E+00	1.08E+00	1.08E+00	1.08E+00	1.08E+00	1.08E+00	1.08E+00	1.09E+00
1248	1.07E+00	1.07E+00	1.07E+00	1.07E+00	1.07E+00	1.07E+00	1.07E+00	1.08E+00	1.08E+00	1.08E+00	1.08E+00	1.09E+00
1249	1.07E+00	1.07E+00	1.08E+00	1.08E+00	1.08E+00	1.08E+00	1.08E+00	1.08E+00	1.08E+00	1.08E+00	1.08E+00	1.09E+00
1250	1.08E+00	1.08E+00	1.08E+00	1.09E+00	1.09E+00	1.09E+00	1.09E+00	1.09E+00	1.08E+00	1.08E+00	1.09E+00	1.09E+00
1251	1.08E+00	1.08E+00	1.09E+00	1.09E+00	1.09E+00	1.09E+00	1.09E+00	1.09E+00	1.09E+00	1.09E+00	1.09E+00	1.09E+00
1261	1.08E+00	1.08E+00	1.08E+00	1.08E+00	1.08E+00	1.08E+00	1.08E+00	1.08E+00	1.08E+00	1.09E+00	1.09E+00	1.09E+00
1262	1.08E+00	1.08E+00	1.08E+00	1.08E+00	1.08E+00	1.08E+00	1.08E+00	1.08E+00	1.08E+00	1.08E+00	1.08E+00	1.09E+00
1263	1.08E+00	1.08E+00	1.09E+00	1.09E+00	1.09E+00	1.09E+00	1.09E+00	1.09E+00	1.09E+00	1.09E+00	1.09E+00	1.09E+00
1264	1.07E+00	1.08E+00	1.08E+00	1.07E+00	1.08E+00	1.08E+00	1.07E+00	1.07E+00	1.08E+00	1.07E+00	1.07E+00	1.07E+00
1265	1.08E+00	1.08E+00	1.08E+00	1.08E+00	1.08E+00	1.08E+00	1.08E+00	1.08E+00	1.08E+00	1.08E+00	1.08E+00	1.08E+00
Biased Statistics												
Average Biased	1.07E+00	1.08E+00	1.08E+00	1.08E+00	1.08E+00	1.08E+00	1.08E+00	1.08E+00	1.08E+00	1.08E+00	1.08E+00	1.09E+00
Std Dev Biased	2.54E-03	3.63E-03	4.31E-03	4.43E-03	4.24E-03	3.86E-03	3.60E-03	3.47E-03	3.45E-03	3.49E-03	3.48E-03	3.48E-03
Ps90%/90% (+KTL) Biased	1.08E+00	1.09E+00	1.09E+00	1.09E+00	1.09E+00	1.09E+00	1.09E+00	1.09E+00	1.09E+00	1.09E+00	1.09E+00	1.10E+00
Ps90%/90% (-KTL) Biased	1.07E+00	1.07E+00	1.07E+00	1.07E+00	1.07E+00	1.07E+00	1.07E+00	1.07E+00	1.07E+00	1.07E+00	1.08E+00	1.08E+00
Specification MAX	1.30E+00	1.30E+00	1.35E+00	1.35E+00	1.35E+00	1.40E+00	1.40E+00	1.40E+00	1.40E+00	1.45E+00	1.50E+00	1.50E+00
Status	PASS	PASS	PASS	PASS	PASS	PASS	PASS	PASS	PASS	PASS	PASS	PASS

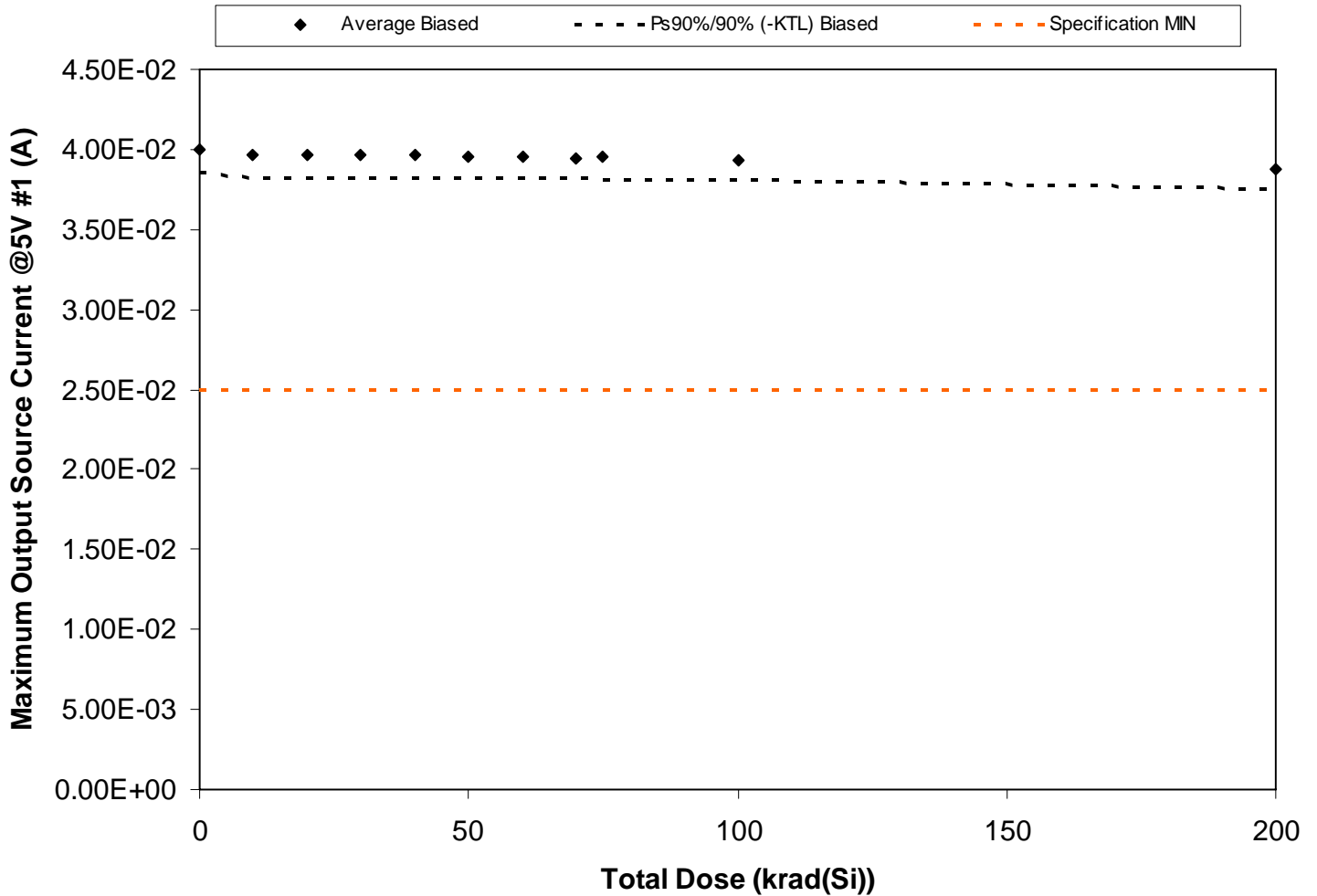

Figure 5.137. Plot of Maximum Output Source Current @5V #1 (A) versus total dose. The solid diamonds are the average of the measured data points for the samples irradiated under electrical bias and the black lines (solid and/or dashed) are the average of the data points after application of the KTL statistics on the samples irradiated under electrical bias. The red dotted line(s) are the pre- and/or post-irradiation minimum and/or maximum specification value as defined in the datasheet and/or test plan.



**RLAT Report
10-326 100808 R1.0**

**Radiation Assured Devices
5017 N. 30th Street
Colorado Springs, CO 80919
(719) 531-0800**

Table 5.137. Raw data for Maximum Output Source Current @5V #1 (A) versus total dose, including the statistical analysis, specification and the status of the testing (pass/fail).

Maximum Output Source Current @5V #1 (A)	Total Dose (krad(Si))											
	0	10	20	30	40	50	60	70	75	100	200	
Device												
1245	3.93E-02	3.90E-02	3.90E-02	3.90E-02	3.90E-02	3.90E-02	3.90E-02	3.90E-02	3.90E-02	3.89E-02	3.83E-02	
1246	4.02E-02	3.98E-02	3.97E-02	3.96E-02	3.96E-02	3.96E-02	3.96E-02	3.95E-02	3.95E-02	3.94E-02	3.88E-02	
1247	4.07E-02	4.02E-02	4.02E-02	4.02E-02	4.02E-02	4.02E-02	4.01E-02	4.01E-02	4.01E-02	4.00E-02	3.95E-02	
1248	4.09E-02	4.06E-02	4.06E-02	4.06E-02	4.05E-02	4.05E-02	4.04E-02	4.02E-02	4.04E-02	4.01E-02	3.94E-02	
1249	4.12E-02	4.09E-02	4.08E-02	4.08E-02	4.08E-02	4.07E-02	4.07E-02	4.06E-02	4.07E-02	4.05E-02	3.98E-02	
1250	3.95E-02	3.91E-02	3.91E-02	3.91E-02	3.90E-02	3.90E-02	3.90E-02	3.89E-02	3.89E-02	3.88E-02	3.83E-02	
1251	3.94E-02	3.90E-02	3.89E-02	3.89E-02	3.89E-02	3.89E-02	3.88E-02	3.88E-02	3.88E-02	3.87E-02	3.79E-02	
1261	3.97E-02	3.94E-02	3.94E-02	3.94E-02	3.94E-02	3.93E-02	3.93E-02	3.92E-02	3.93E-02	3.91E-02	3.86E-02	
1262	3.99E-02	3.96E-02	3.95E-02	3.95E-02	3.95E-02	3.95E-02	3.95E-02	3.95E-02	3.95E-02	3.94E-02	3.89E-02	
1263	3.94E-02	3.90E-02	3.90E-02	3.90E-02	3.90E-02	3.90E-02	3.90E-02	3.89E-02	3.89E-02	3.88E-02	3.83E-02	
1264	4.01E-02	3.99E-02	3.99E-02	3.99E-02	3.99E-02	3.99E-02	4.00E-02	4.00E-02	4.00E-02	4.00E-02	4.00E-02	
1265	4.02E-02	4.00E-02	4.00E-02	4.00E-02	4.01E-02	4.01E-02	4.01E-02	4.01E-02	4.01E-02	4.01E-02	4.01E-02	
Biased Statistics												
Average Biased	4.00E-02	3.97E-02	3.96E-02	3.96E-02	3.96E-02	3.96E-02	3.95E-02	3.95E-02	3.95E-02	3.94E-02	3.88E-02	
Std Dev Biased	6.99E-04	6.97E-04	6.97E-04	7.01E-04	6.86E-04	6.60E-04	6.67E-04	6.36E-04	6.71E-04	6.36E-04	6.19E-04	
Ps90%/90% (+KTL) Biased	4.15E-02	4.11E-02	4.11E-02	4.11E-02	4.10E-02	4.10E-02	4.09E-02	4.08E-02	4.09E-02	4.07E-02	4.01E-02	
Ps90%/90% (-KTL) Biased	3.86E-02	3.82E-02	3.82E-02	3.82E-02	3.82E-02	3.82E-02	3.82E-02	3.82E-02	3.81E-02	3.81E-02	3.75E-02	
Specification MIN	2.50E-02	2.50E-02	2.50E-02	2.50E-02	2.50E-02	2.50E-02	2.50E-02	2.50E-02	2.50E-02	2.50E-02	2.50E-02	
Status	PASS	PASS	PASS	PASS	PASS	PASS	PASS	PASS	PASS	PASS	PASS	

An ISO 9001:2008 and DSCC Certified Company

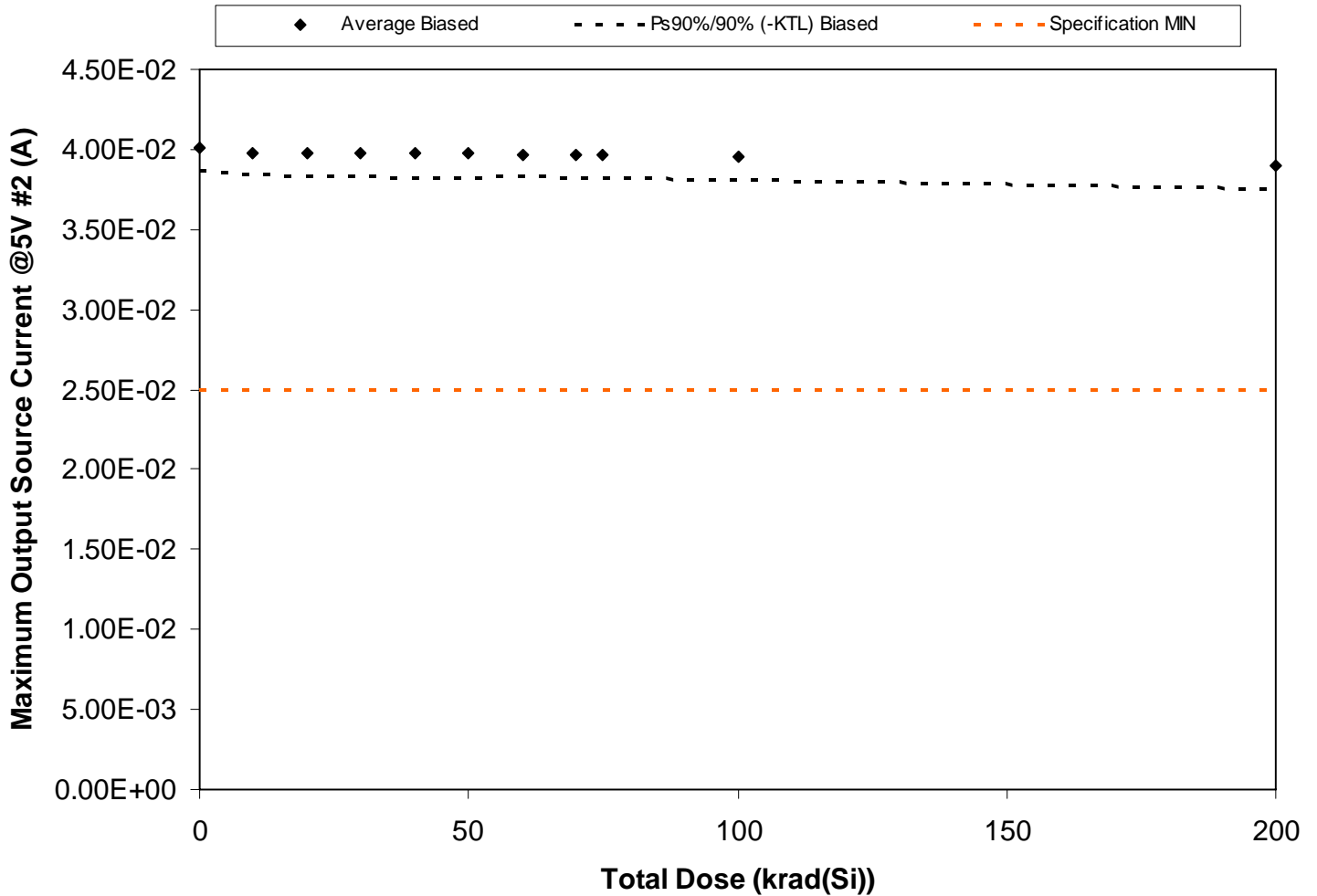

Figure 5.138. Plot of Maximum Output Source Current @5V #2 (A) versus total dose. The solid diamonds are the average of the measured data points for the samples irradiated under electrical bias and the black lines (solid and/or dashed) are the average of the data points after application of the KTL statistics on the samples irradiated under electrical bias. The red dotted line(s) are the pre- and/or post-irradiation minimum and/or maximum specification value as defined in the datasheet and/or test plan.



**RLAT Report
10-326 100808 R1.0**

**Radiation Assured Devices
5017 N. 30th Street
Colorado Springs, CO 80919
(719) 531-0800**

Table 5.138. Raw data for Maximum Output Source Current @5V #2 (A) versus total dose, including the statistical analysis, specification and the status of the testing (pass/fail).

Maximum Output Source Current @5V #2 (A)	Total Dose (krad(Si))											
	0	10	20	30	40	50	60	70	75	100	200	
Device												
1245	3.91E-02	3.89E-02	3.88E-02	3.88E-02	3.87E-02	3.87E-02	3.87E-02	3.85E-02	3.85E-02	3.84E-02	3.78E-02	
1246	4.00E-02	3.96E-02	3.96E-02	3.96E-02	3.95E-02	3.95E-02	3.95E-02	3.95E-02	3.95E-02	3.93E-02	3.88E-02	
1247	3.99E-02	3.96E-02	3.95E-02	3.95E-02	3.95E-02	3.95E-02	3.95E-02	3.95E-02	3.95E-02	3.94E-02	3.89E-02	
1248	4.13E-02	4.11E-02	4.11E-02	4.11E-02	4.11E-02	4.11E-02	4.10E-02	4.10E-02	4.10E-02	4.08E-02	4.04E-02	
1249	4.00E-02	3.98E-02	3.96E-02	3.96E-02	3.96E-02	3.96E-02	3.95E-02	3.95E-02	3.95E-02	3.94E-02	3.89E-02	
1250	3.93E-02	3.90E-02	3.90E-02	3.90E-02	3.90E-02	3.90E-02	3.90E-02	3.89E-02	3.89E-02	3.88E-02	3.84E-02	
1251	4.00E-02	3.96E-02	3.96E-02	3.95E-02	3.95E-02	3.95E-02	3.95E-02	3.94E-02	3.94E-02	3.93E-02	3.88E-02	
1261	4.02E-02	3.99E-02	3.98E-02	3.97E-02	3.98E-02	3.97E-02	3.97E-02	3.96E-02	3.96E-02	3.95E-02	3.90E-02	
1262	4.02E-02	3.99E-02	3.98E-02	3.99E-02	3.98E-02	3.98E-02	3.98E-02	3.97E-02	3.97E-02	3.96E-02	3.91E-02	
1263	4.11E-02	4.08E-02	4.07E-02	4.07E-02	4.07E-02	4.07E-02	4.06E-02	4.06E-02	4.06E-02	4.04E-02	3.98E-02	
1264	3.96E-02	3.94E-02	3.95E-02	3.95E-02	3.95E-02	3.95E-02	3.95E-02	3.95E-02	3.95E-02	3.95E-02	3.95E-02	
1265	3.92E-02	3.90E-02	3.90E-02	3.90E-02	3.91E-02	3.90E-02	3.91E-02	3.91E-02	3.92E-02	3.91E-02	3.91E-02	
Biased Statistics												
Average Biased	4.01E-02	3.98E-02	3.98E-02	3.97E-02	3.97E-02	3.97E-02	3.97E-02	3.96E-02	3.96E-02	3.95E-02	3.90E-02	
Std Dev Biased	6.83E-04	6.72E-04	6.92E-04	6.95E-04	7.17E-04	7.14E-04	6.76E-04	7.10E-04	7.13E-04	7.01E-04	6.92E-04	
Ps90%/90% (+KTL) Biased	4.15E-02	4.12E-02	4.12E-02	4.12E-02	4.12E-02	4.12E-02	4.11E-02	4.11E-02	4.11E-02	4.10E-02	4.04E-02	
Ps90%/90% (-KTL) Biased	3.87E-02	3.84E-02	3.83E-02	3.83E-02	3.82E-02	3.82E-02	3.83E-02	3.82E-02	3.82E-02	3.81E-02	3.76E-02	
Specification MIN	2.50E-02	2.50E-02	2.50E-02	2.50E-02	2.50E-02	2.50E-02	2.50E-02	2.50E-02	2.50E-02	2.50E-02	2.50E-02	
Status	PASS	PASS	PASS	PASS	PASS	PASS	PASS	PASS	PASS	PASS	PASS	

An ISO 9001:2008 and DSCC Certified Company

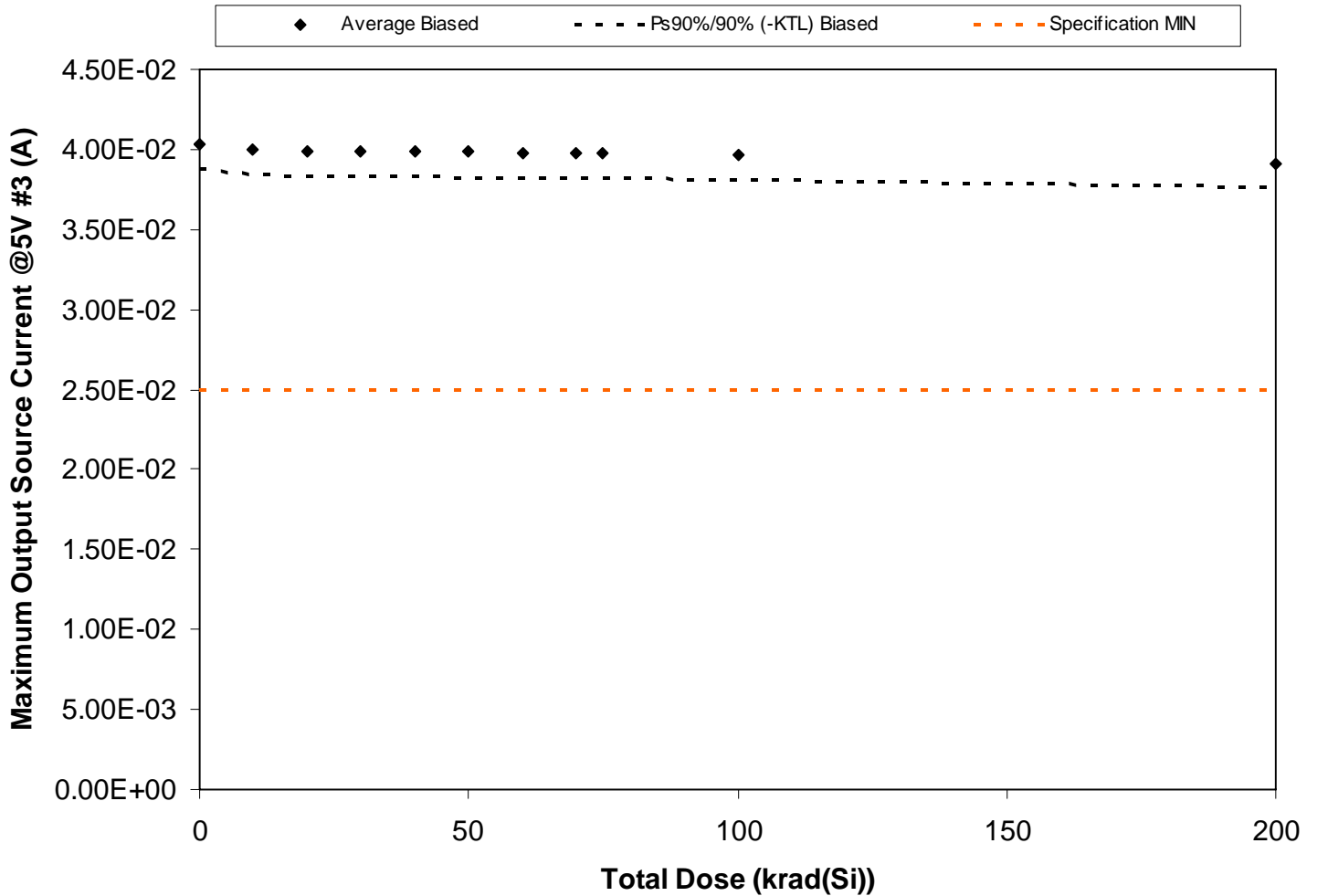

Figure 5.139. Plot of Maximum Output Source Current @5V #3 (A) versus total dose. The solid diamonds are the average of the measured data points for the samples irradiated under electrical bias and the black lines (solid and/or dashed) are the average of the data points after application of the KTL statistics on the samples irradiated under electrical bias. The red dotted line(s) are the pre- and/or post-irradiation minimum and/or maximum specification value as defined in the datasheet and/or test plan.



Table 5.139. Raw data for Maximum Output Source Current @5V #3 (A) versus total dose, including the statistical analysis, specification and the status of the testing (pass/fail).

Maximum Output Source Current @5V #3 (A)	Total Dose (krad(Si))											
	0	10	20	30	40	50	60	70	75	100	200	
Device												
1245	3.91E-02	3.89E-02	3.88E-02	3.88E-02	3.88E-02	3.87E-02	3.87E-02	3.87E-02	3.87E-02	3.85E-02	3.81E-02	
1246	4.02E-02	3.99E-02	3.97E-02	3.97E-02	3.98E-02	3.97E-02	3.96E-02	3.96E-02	3.96E-02	3.95E-02	3.89E-02	
1247	4.01E-02	3.98E-02	3.97E-02	3.97E-02	3.96E-02	3.96E-02	3.96E-02	3.96E-02	3.95E-02	3.95E-02	3.89E-02	
1248	4.18E-02	4.15E-02	4.14E-02	4.14E-02	4.13E-02	4.13E-02	4.12E-02	4.12E-02	4.12E-02	4.10E-02	4.04E-02	
1249	4.01E-02	3.98E-02	3.97E-02	3.97E-02	3.96E-02	3.96E-02	3.96E-02	3.96E-02	3.95E-02	3.95E-02	3.90E-02	
1250	3.94E-02	3.92E-02	3.92E-02	3.91E-02	3.91E-02	3.91E-02	3.90E-02	3.90E-02	3.90E-02	3.88E-02	3.83E-02	
1251	4.02E-02	3.99E-02	3.98E-02	3.97E-02	3.98E-02	3.98E-02	3.97E-02	3.96E-02	3.96E-02	3.95E-02	3.90E-02	
1261	4.05E-02	4.00E-02	4.00E-02	4.00E-02	4.00E-02	4.00E-02	3.99E-02	3.99E-02	3.99E-02	3.98E-02	3.92E-02	
1262	4.04E-02	4.00E-02	3.99E-02	3.99E-02	3.99E-02	3.99E-02	3.98E-02	3.97E-02	3.98E-02	3.96E-02	3.90E-02	
1263	4.13E-02	4.10E-02	4.10E-02	4.08E-02	4.08E-02	4.08E-02	4.07E-02	4.07E-02	4.07E-02	4.05E-02	3.99E-02	
1264	3.99E-02	3.96E-02	3.96E-02	3.96E-02	3.96E-02	3.97E-02	3.97E-02	3.97E-02	3.97E-02	3.98E-02	3.98E-02	
1265	3.92E-02	3.90E-02	3.90E-02	3.90E-02	3.90E-02	3.90E-02	3.90E-02	3.90E-02	3.91E-02	3.90E-02	3.90E-02	
Biased Statistics												
Average Biased	4.03E-02	4.00E-02	3.99E-02	3.99E-02	3.99E-02	3.98E-02	3.98E-02	3.98E-02	3.98E-02	3.96E-02	3.91E-02	
Std Dev Biased	7.76E-04	7.47E-04	7.78E-04	7.63E-04	7.41E-04	7.71E-04	7.40E-04	7.36E-04	7.40E-04	7.08E-04	6.68E-04	
Ps90%/90% (+KTL) Biased	4.19E-02	4.15E-02	4.15E-02	4.15E-02	4.14E-02	4.14E-02	4.13E-02	4.13E-02	4.13E-02	4.11E-02	4.04E-02	
Ps90%/90% (-KTL) Biased	3.87E-02	3.84E-02	3.83E-02	3.83E-02	3.83E-02	3.83E-02	3.83E-02	3.82E-02	3.82E-02	3.81E-02	3.77E-02	
Specification MIN	2.50E-02	2.50E-02	2.50E-02	2.50E-02	2.50E-02	2.50E-02	2.50E-02	2.50E-02	2.50E-02	2.50E-02	2.50E-02	
Status	PASS	PASS	PASS	PASS	PASS	PASS	PASS	PASS	PASS	PASS	PASS	

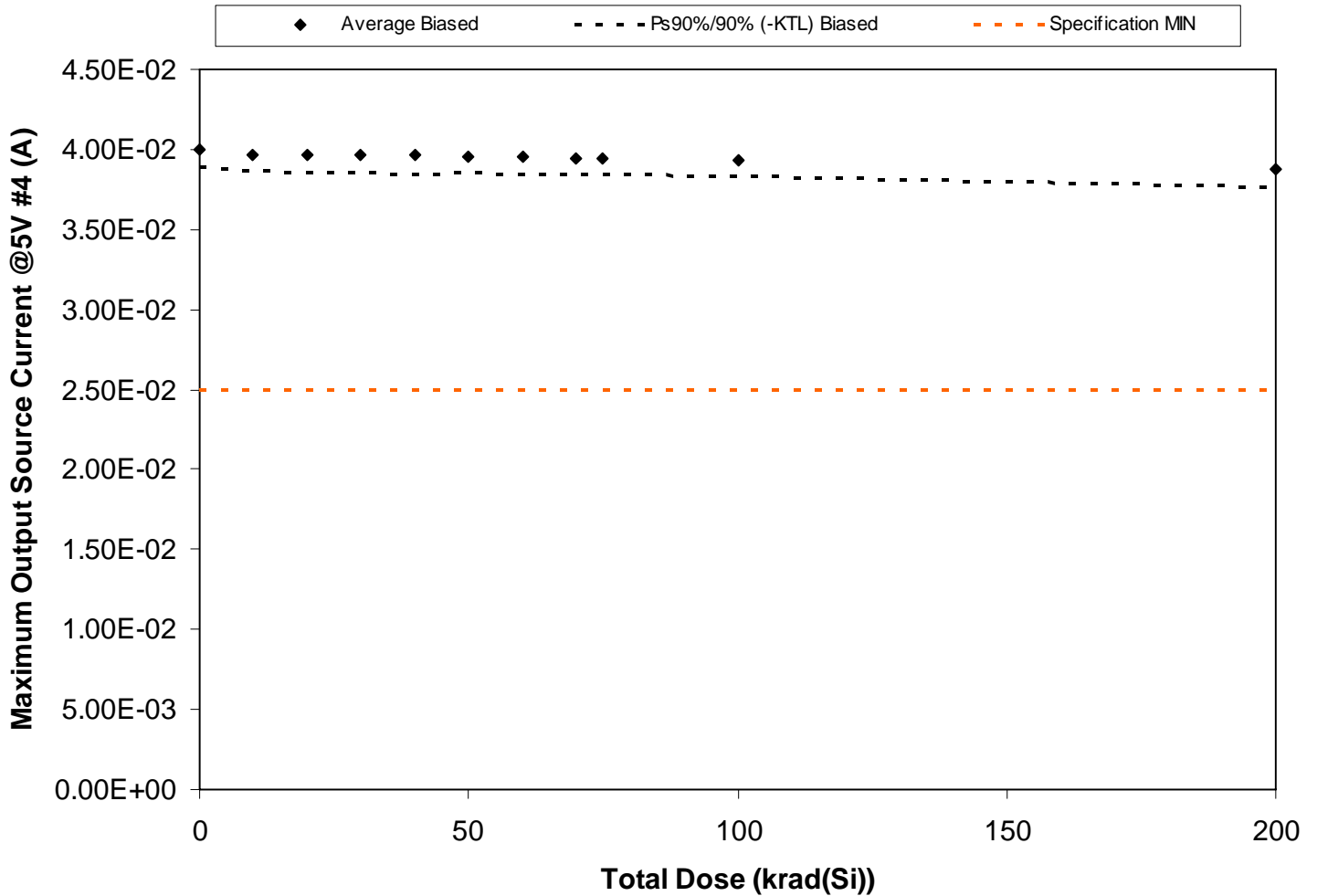

Figure 5.140. Plot of Maximum Output Source Current @5V #4 (A) versus total dose. The solid diamonds are the average of the measured data points for the samples irradiated under electrical bias and the black lines (solid and/or dashed) are the average of the data points after application of the KTL statistics on the samples irradiated under electrical bias. The red dotted line(s) are the pre- and/or post-irradiation minimum and/or maximum specification value as defined in the datasheet and/or test plan.



**RLAT Report
10-326 100808 R1.0**

**Radiation Assured Devices
5017 N. 30th Street
Colorado Springs, CO 80919
(719) 531-0800**

Table 5.140. Raw data for Maximum Output Source Current @5V #4 (A) versus total dose, including the statistical analysis, specification and the status of the testing (pass/fail).

Maximum Output Source Current @5V #4 (A)	Total Dose (krad(Si))											
	0	10	20	30	40	50	60	70	75	100	200	
Device												
1245	3.95E-02	3.93E-02	3.93E-02	3.92E-02	3.91E-02	3.91E-02	3.91E-02	3.90E-02	3.90E-02	3.89E-02	3.83E-02	
1246	4.01E-02	3.98E-02	3.97E-02	3.97E-02	3.96E-02	3.96E-02	3.96E-02	3.95E-02	3.95E-02	3.94E-02	3.88E-02	
1247	4.05E-02	4.01E-02	4.01E-02	4.01E-02	4.01E-02	4.01E-02	4.00E-02	4.00E-02	4.00E-02	3.99E-02	3.94E-02	
1248	4.06E-02	4.04E-02	4.04E-02	4.03E-02	4.02E-02	4.01E-02	4.01E-02	4.00E-02	4.00E-02	3.98E-02	3.90E-02	
1249	4.10E-02	4.07E-02	4.06E-02	4.06E-02	4.06E-02	4.05E-02	4.05E-02	4.04E-02	4.04E-02	4.02E-02	3.96E-02	
1250	3.96E-02	3.93E-02	3.92E-02	3.91E-02	3.91E-02	3.90E-02	3.90E-02	3.89E-02	3.89E-02	3.88E-02	3.81E-02	
1251	3.95E-02	3.93E-02	3.91E-02	3.91E-02	3.91E-02	3.92E-02	3.90E-02	3.90E-02	3.90E-02	3.89E-02	3.84E-02	
1261	3.97E-02	3.95E-02	3.95E-02	3.94E-02	3.94E-02	3.94E-02	3.94E-02	3.94E-02	3.94E-02	3.93E-02	3.89E-02	
1262	4.00E-02	3.96E-02	3.96E-02	3.96E-02	3.95E-02	3.95E-02	3.95E-02	3.94E-02	3.94E-02	3.93E-02	3.88E-02	
1263	3.95E-02	3.92E-02	3.91E-02	3.91E-02	3.90E-02	3.90E-02	3.90E-02	3.89E-02	3.89E-02	3.88E-02	3.82E-02	
1264	4.01E-02	3.99E-02	3.99E-02	3.99E-02	4.00E-02	4.00E-02	4.00E-02	4.00E-02	4.00E-02	4.00E-02	4.00E-02	
1265	4.04E-02	4.00E-02	4.01E-02	4.01E-02	4.01E-02	4.01E-02	4.01E-02	4.01E-02	4.01E-02	4.01E-02	4.02E-02	
Biased Statistics												
Average Biased	4.00E-02	3.97E-02	3.97E-02	3.96E-02	3.96E-02	3.96E-02	3.95E-02	3.95E-02	3.95E-02	3.93E-02	3.87E-02	
Std Dev Biased	5.17E-04	5.30E-04	5.31E-04	5.42E-04	5.44E-04	5.22E-04	5.26E-04	5.20E-04	5.14E-04	5.10E-04	5.18E-04	
Ps90%/90% (+KTL) Biased	4.11E-02	4.08E-02	4.08E-02	4.07E-02	4.07E-02	4.06E-02	4.06E-02	4.05E-02	4.05E-02	4.04E-02	3.98E-02	
Ps90%/90% (-KTL) Biased	3.89E-02	3.86E-02	3.86E-02	3.85E-02	3.85E-02	3.85E-02	3.84E-02	3.84E-02	3.84E-02	3.83E-02	3.77E-02	
Specification MIN	2.50E-02	2.50E-02	2.50E-02	2.50E-02	2.50E-02	2.50E-02	2.50E-02	2.50E-02	2.50E-02	2.50E-02	2.50E-02	
Status	PASS	PASS	PASS	PASS	PASS	PASS	PASS	PASS	PASS	PASS	PASS	

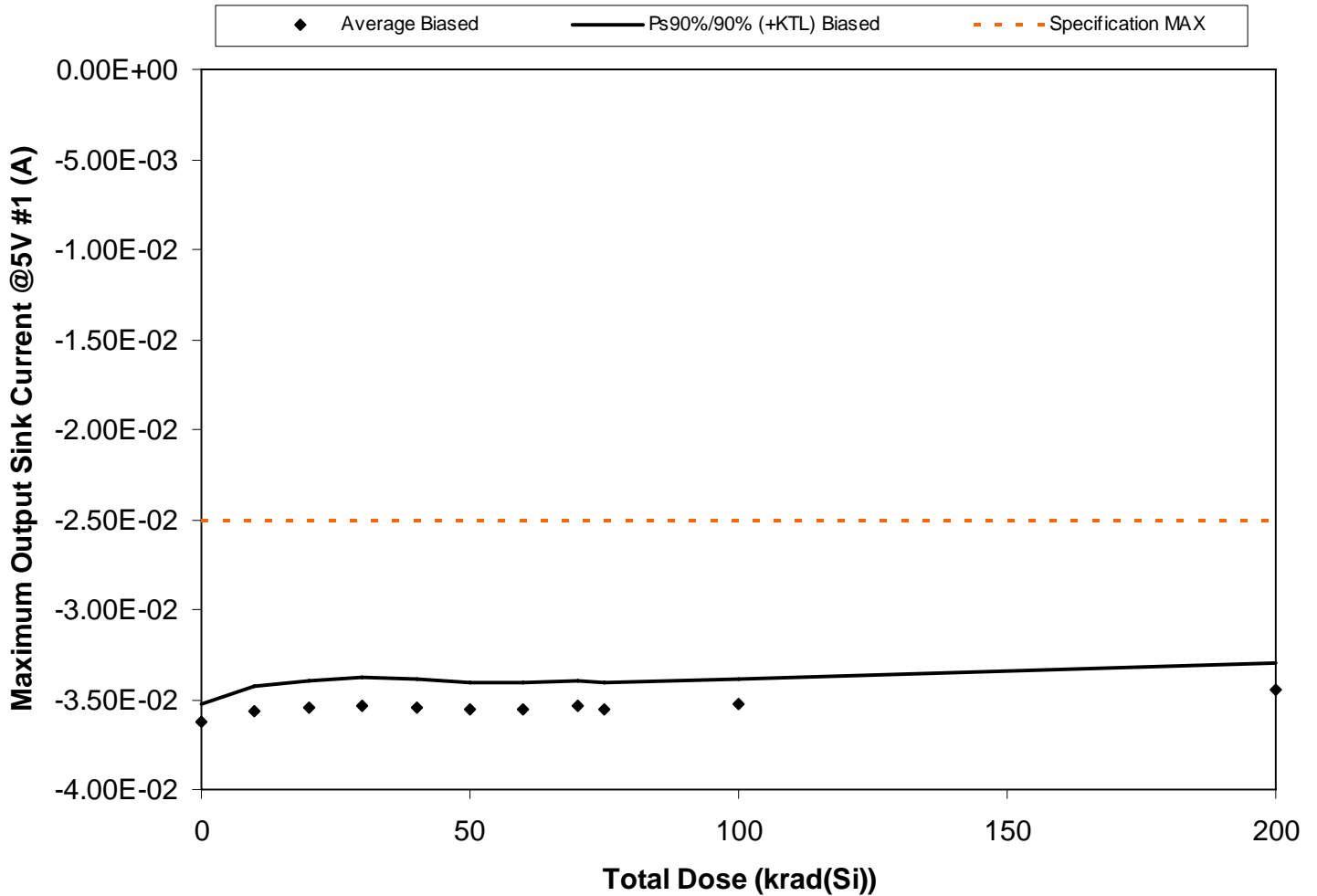

Figure 5.141. Plot of Maximum Output Sink Current @5V #1 (A) versus total dose. The solid diamonds are the average of the measured data points for the samples irradiated under electrical bias and the black lines (solid and/or dashed) are the average of the data points after application of the KTL statistics on the samples irradiated under electrical bias. The red dotted line(s) are the pre- and/or post-irradiation minimum and/or maximum specification value as defined in the datasheet and/or test plan.



**RLAT Report
10-326 100808 R1.0**

**Radiation Assured Devices
5017 N. 30th Street
Colorado Springs, CO 80919
(719) 531-0800**

Table 5.141. Raw data for Maximum Output Sink Current @5V #1 (A) versus total dose, including the statistical analysis, specification and the status of the testing (pass/fail).

Maximum Output Sink Current @5V #1 (A)	Total Dose (krad(Si))											
	0	10	20	30	40	50	60	70	75	100	200	
Device												
1245	-3.59E-02	-3.56E-02	-3.54E-02	-3.52E-02	-3.52E-02	-3.53E-02	-3.53E-02	-3.52E-02	-3.53E-02	-3.51E-02	-3.45E-02	
1246	-3.60E-02	-3.53E-02	-3.50E-02	-3.50E-02	-3.51E-02	-3.53E-02	-3.53E-02	-3.52E-02	-3.53E-02	-3.50E-02	-3.42E-02	
1247	-3.65E-02	-3.59E-02	-3.57E-02	-3.56E-02	-3.57E-02	-3.59E-02	-3.59E-02	-3.58E-02	-3.59E-02	-3.57E-02	-3.50E-02	
1248	-3.68E-02	-3.69E-02	-3.68E-02	-3.68E-02	-3.68E-02	-3.68E-02	-3.66E-02	-3.63E-02	-3.65E-02	-3.60E-02	-3.50E-02	
1249	-3.72E-02	-3.67E-02	-3.65E-02	-3.65E-02	-3.68E-02	-3.69E-02	-3.69E-02	-3.68E-02	-3.69E-02	-3.66E-02	-3.59E-02	
1250	-3.59E-02	-3.51E-02	-3.48E-02	-3.49E-02	-3.50E-02	-3.51E-02	-3.51E-02	-3.50E-02	-3.51E-02	-3.49E-02	-3.42E-02	
1251	-3.57E-02	-3.51E-02	-3.47E-02	-3.46E-02	-3.47E-02	-3.48E-02	-3.48E-02	-3.47E-02	-3.48E-02	-3.46E-02	-3.37E-02	
1261	-3.59E-02	-3.52E-02	-3.49E-02	-3.48E-02	-3.49E-02	-3.51E-02	-3.51E-02	-3.49E-02	-3.50E-02	-3.47E-02	-3.38E-02	
1262	-3.61E-02	-3.54E-02	-3.51E-02	-3.51E-02	-3.51E-02	-3.53E-02	-3.53E-02	-3.52E-02	-3.52E-02	-3.50E-02	-3.41E-02	
1263	-3.59E-02	-3.54E-02	-3.51E-02	-3.50E-02	-3.50E-02	-3.51E-02	-3.51E-02	-3.48E-02	-3.50E-02	-3.46E-02	-3.36E-02	
1264	-3.62E-02	-3.60E-02	-3.60E-02	-3.61E-02	-3.62E-02	-3.63E-02	-3.63E-02	-3.62E-02	-3.63E-02	-3.62E-02	-3.62E-02	
1265	-3.60E-02	-3.59E-02	-3.59E-02	-3.59E-02	-3.59E-02	-3.61E-02	-3.61E-02	-3.60E-02	-3.62E-02	-3.60E-02	-3.60E-02	
Biased Statistics												
Average Biased	-3.62E-02	-3.56E-02	-3.54E-02	-3.53E-02	-3.54E-02	-3.56E-02	-3.55E-02	-3.54E-02	-3.55E-02	-3.52E-02	-3.44E-02	
Std Dev Biased	4.71E-04	6.51E-04	7.23E-04	7.46E-04	7.47E-04	7.27E-04	7.02E-04	6.80E-04	7.09E-04	6.83E-04	7.14E-04	
Ps90%/90% (+KTL) Biased	-3.52E-02	-3.43E-02	-3.39E-02	-3.38E-02	-3.39E-02	-3.41E-02	-3.41E-02	-3.40E-02	-3.40E-02	-3.38E-02	-3.29E-02	
Ps90%/90% (-KTL) Biased	-3.72E-02	-3.70E-02	-3.69E-02	-3.69E-02	-3.70E-02	-3.71E-02	-3.70E-02	-3.68E-02	-3.70E-02	-3.66E-02	-3.59E-02	
Specification MAX	-2.50E-02	-2.50E-02	-2.50E-02	-2.50E-02	-2.50E-02	-2.50E-02	-2.50E-02	-2.50E-02	-2.50E-02	-2.50E-02	-2.50E-02	
Status	PASS	PASS	PASS	PASS	PASS	PASS	PASS	PASS	PASS	PASS	PASS	

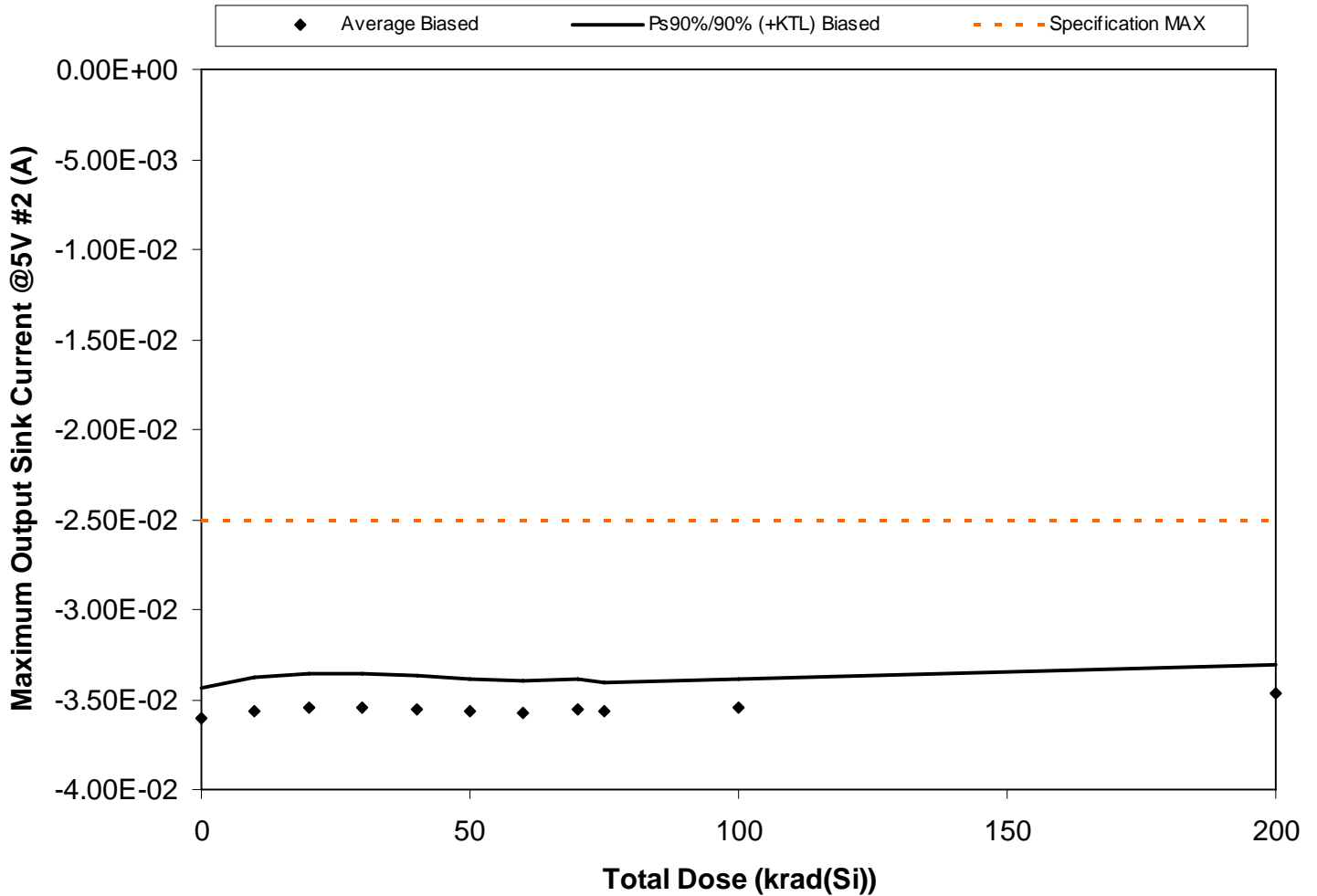

Figure 5.142. Plot of Maximum Output Sink Current @5V #2 (A) versus total dose. The solid diamonds are the average of the measured data points for the samples irradiated under electrical bias and the black lines (solid and/or dashed) are the average of the data points after application of the KTL statistics on the samples irradiated under electrical bias. The red dotted line(s) are the pre- and/or post-irradiation minimum and/or maximum specification value as defined in the datasheet and/or test plan.



**RLAT Report
10-326 100808 R1.0**

**Radiation Assured Devices
5017 N. 30th Street
Colorado Springs, CO 80919
(719) 531-0800**

Table 5.142. Raw data for Maximum Output Sink Current @5V #2 (A) versus total dose, including the statistical analysis, specification and the status of the testing (pass/fail).

Maximum Output Sink Current @5V #2 (A)	Total Dose (krad(Si))											
	0	10	20	30	40	50	60	70	75	100	200	
Device												
1245	-3.53E-02	-3.46E-02	-3.43E-02	-3.43E-02	-3.44E-02	-3.45E-02	-3.46E-02	-3.45E-02	-3.46E-02	-3.44E-02	-3.37E-02	
1246	-3.53E-02	-3.48E-02	-3.48E-02	-3.50E-02	-3.52E-02	-3.54E-02	-3.54E-02	-3.53E-02	-3.54E-02	-3.52E-02	-3.43E-02	
1247	-3.62E-02	-3.57E-02	-3.53E-02	-3.52E-02	-3.53E-02	-3.54E-02	-3.54E-02	-3.54E-02	-3.55E-02	-3.53E-02	-3.45E-02	
1248	-3.76E-02	-3.76E-02	-3.75E-02	-3.75E-02	-3.74E-02	-3.75E-02	-3.74E-02	-3.71E-02	-3.71E-02	-3.68E-02	-3.58E-02	
1249	-3.64E-02	-3.60E-02	-3.57E-02	-3.56E-02	-3.56E-02	-3.57E-02	-3.57E-02	-3.56E-02	-3.56E-02	-3.54E-02	-3.46E-02	
1250	-3.56E-02	-3.52E-02	-3.51E-02	-3.48E-02	-3.48E-02	-3.50E-02	-3.50E-02	-3.48E-02	-3.48E-02	-3.46E-02	-3.37E-02	
1251	-3.59E-02	-3.53E-02	-3.51E-02	-3.51E-02	-3.51E-02	-3.53E-02	-3.54E-02	-3.53E-02	-3.53E-02	-3.52E-02	-3.45E-02	
1261	-3.62E-02	-3.57E-02	-3.54E-02	-3.54E-02	-3.55E-02	-3.57E-02	-3.58E-02	-3.56E-02	-3.57E-02	-3.56E-02	-3.49E-02	
1262	-3.51E-02	-3.50E-02	-3.50E-02	-3.51E-02	-3.53E-02	-3.55E-02	-3.56E-02	-3.54E-02	-3.56E-02	-3.54E-02	-3.46E-02	
1263	-3.71E-02	-3.68E-02	-3.67E-02	-3.66E-02	-3.66E-02	-3.68E-02	-3.69E-02	-3.68E-02	-3.69E-02	-3.68E-02	-3.63E-02	
1264	-3.58E-02	-3.57E-02	-3.57E-02	-3.58E-02	-3.58E-02	-3.59E-02	-3.59E-02	-3.58E-02	-3.59E-02	-3.58E-02	-3.58E-02	
1265	-3.54E-02	-3.54E-02	-3.54E-02	-3.54E-02	-3.54E-02	-3.56E-02	-3.56E-02	-3.55E-02	-3.56E-02	-3.55E-02	-3.54E-02	
Biased Statistics												
Average Biased	-3.61E-02	-3.57E-02	-3.55E-02	-3.55E-02	-3.55E-02	-3.57E-02	-3.57E-02	-3.56E-02	-3.57E-02	-3.55E-02	-3.47E-02	
Std Dev Biased	8.12E-04	9.38E-04	9.35E-04	9.25E-04	8.75E-04	8.67E-04	8.40E-04	8.12E-04	7.99E-04	7.90E-04	8.05E-04	
Ps90%/90% (+KTL) Biased	-3.44E-02	-3.37E-02	-3.36E-02	-3.35E-02	-3.37E-02	-3.39E-02	-3.40E-02	-3.39E-02	-3.40E-02	-3.38E-02	-3.30E-02	
Ps90%/90% (-KTL) Biased	-3.78E-02	-3.76E-02	-3.74E-02	-3.74E-02	-3.73E-02	-3.75E-02	-3.74E-02	-3.72E-02	-3.73E-02	-3.71E-02	-3.64E-02	
Specification MAX	-2.50E-02	-2.50E-02	-2.50E-02	-2.50E-02	-2.50E-02	-2.50E-02	-2.50E-02	-2.50E-02	-2.50E-02	-2.50E-02	-2.50E-02	
Status	PASS	PASS	PASS	PASS	PASS	PASS	PASS	PASS	PASS	PASS	PASS	

An ISO 9001:2008 and DSCC Certified Company

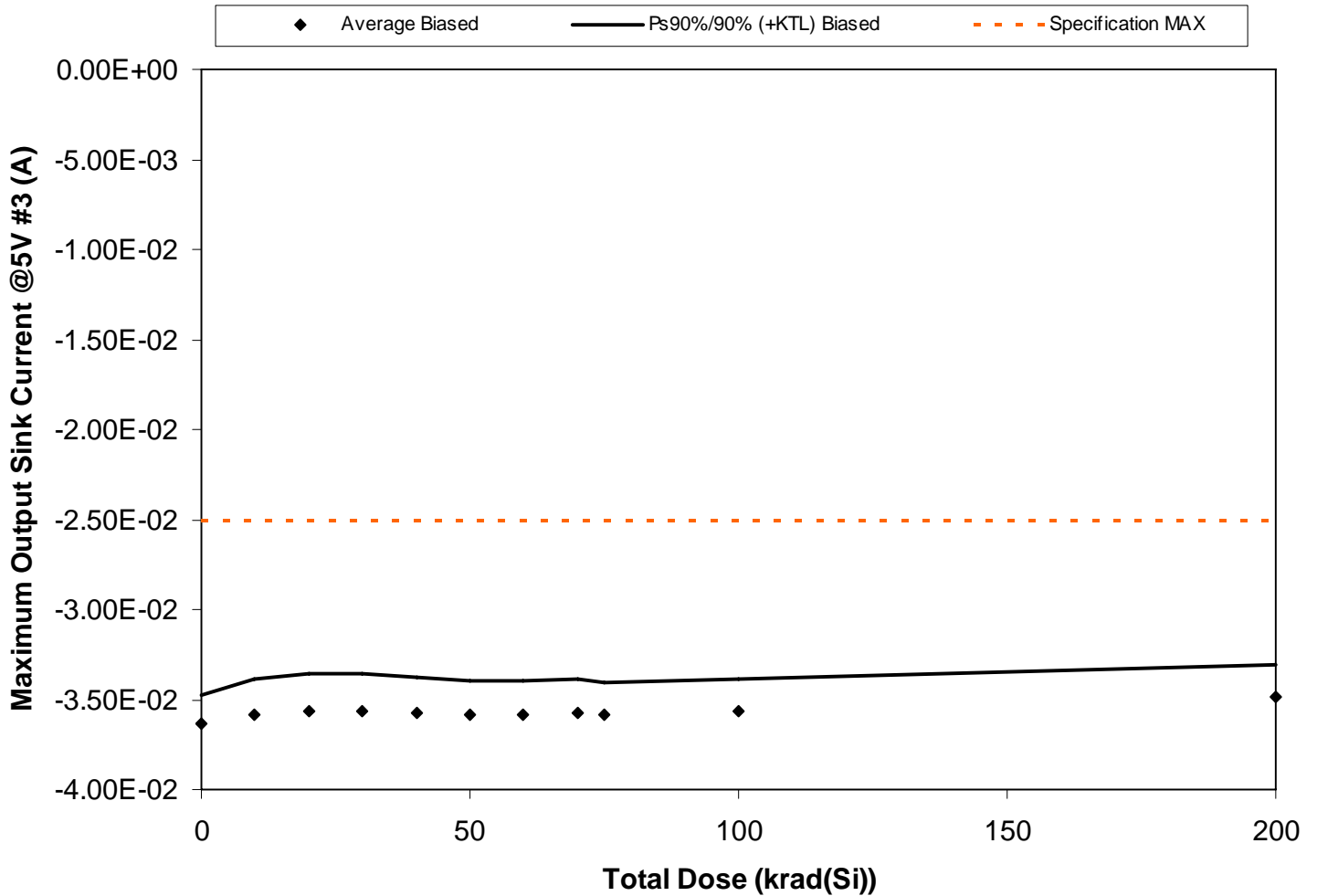

Figure 5.143. Plot of Maximum Output Sink Current @5V #3 (A) versus total dose. The solid diamonds are the average of the measured data points for the samples irradiated under electrical bias and the black lines (solid and/or dashed) are the average of the data points after application of the KTL statistics on the samples irradiated under electrical bias. The red dotted line(s) are the pre- and/or post-irradiation minimum and/or maximum specification value as defined in the datasheet and/or test plan.



**RLAT Report
10-326 100808 R1.0**

**Radiation Assured Devices
5017 N. 30th Street
Colorado Springs, CO 80919
(719) 531-0800**

Table 5.143. Raw data for Maximum Output Sink Current @5V #3 (A) versus total dose, including the statistical analysis, specification and the status of the testing (pass/fail).

Maximum Output Sink Current @5V #3 (A)	Total Dose (krad(Si))											
	0	10	20	30	40	50	60	70	75	100	200	
Device												
1245	-3.50E-02	-3.42E-02	-3.41E-02	-3.42E-02	-3.45E-02	-3.46E-02	-3.47E-02	-3.45E-02	-3.46E-02	-3.43E-02	-3.36E-02	
1246	-3.63E-02	-3.56E-02	-3.53E-02	-3.53E-02	-3.54E-02	-3.56E-02	-3.56E-02	-3.54E-02	-3.56E-02	-3.53E-02	-3.46E-02	
1247	-3.62E-02	-3.56E-02	-3.52E-02	-3.52E-02	-3.53E-02	-3.55E-02	-3.54E-02	-3.53E-02	-3.54E-02	-3.52E-02	-3.42E-02	
1248	-3.79E-02	-3.80E-02	-3.79E-02	-3.79E-02	-3.78E-02	-3.79E-02	-3.77E-02	-3.75E-02	-3.75E-02	-3.71E-02	-3.62E-02	
1249	-3.65E-02	-3.59E-02	-3.57E-02	-3.56E-02	-3.57E-02	-3.58E-02	-3.57E-02	-3.56E-02	-3.57E-02	-3.54E-02	-3.45E-02	
1250	-3.57E-02	-3.53E-02	-3.52E-02	-3.51E-02	-3.51E-02	-3.53E-02	-3.53E-02	-3.52E-02	-3.53E-02	-3.51E-02	-3.45E-02	
1251	-3.62E-02	-3.54E-02	-3.52E-02	-3.51E-02	-3.52E-02	-3.53E-02	-3.54E-02	-3.53E-02	-3.54E-02	-3.52E-02	-3.45E-02	
1261	-3.64E-02	-3.59E-02	-3.57E-02	-3.56E-02	-3.57E-02	-3.58E-02	-3.59E-02	-3.58E-02	-3.59E-02	-3.58E-02	-3.54E-02	
1262	-3.64E-02	-3.58E-02	-3.56E-02	-3.56E-02	-3.56E-02	-3.58E-02	-3.58E-02	-3.57E-02	-3.58E-02	-3.57E-02	-3.51E-02	
1263	-3.74E-02	-3.69E-02	-3.68E-02	-3.68E-02	-3.68E-02	-3.70E-02	-3.71E-02	-3.70E-02	-3.71E-02	-3.69E-02	-3.64E-02	
1264	-3.62E-02	-3.62E-02	-3.62E-02	-3.62E-02	-3.62E-02	-3.63E-02	-3.63E-02	-3.62E-02	-3.63E-02	-3.62E-02	-3.63E-02	
1265	-3.57E-02	-3.56E-02	-3.57E-02	-3.57E-02	-3.57E-02	-3.58E-02	-3.58E-02	-3.57E-02	-3.58E-02	-3.57E-02	-3.57E-02	
Biased Statistics												
Average Biased	-3.64E-02	-3.59E-02	-3.57E-02	-3.56E-02	-3.57E-02	-3.59E-02	-3.59E-02	-3.57E-02	-3.58E-02	-3.56E-02	-3.49E-02	
Std Dev Biased	8.02E-04	9.90E-04	1.01E-03	1.01E-03	9.30E-04	9.30E-04	9.04E-04	8.85E-04	8.70E-04	8.44E-04	8.87E-04	
Ps90%/90% (+KTL) Biased	-3.47E-02	-3.38E-02	-3.36E-02	-3.35E-02	-3.38E-02	-3.39E-02	-3.40E-02	-3.39E-02	-3.41E-02	-3.39E-02	-3.31E-02	
Ps90%/90% (-KTL) Biased	-3.80E-02	-3.79E-02	-3.77E-02	-3.77E-02	-3.76E-02	-3.78E-02	-3.77E-02	-3.76E-02	-3.76E-02	-3.73E-02	-3.67E-02	
Specification MAX	-2.50E-02	-2.50E-02	-2.50E-02	-2.50E-02	-2.50E-02	-2.50E-02	-2.50E-02	-2.50E-02	-2.50E-02	-2.50E-02	-2.50E-02	
Status	PASS	PASS	PASS	PASS	PASS	PASS	PASS	PASS	PASS	PASS	PASS	

An ISO 9001:2008 and DSCC Certified Company

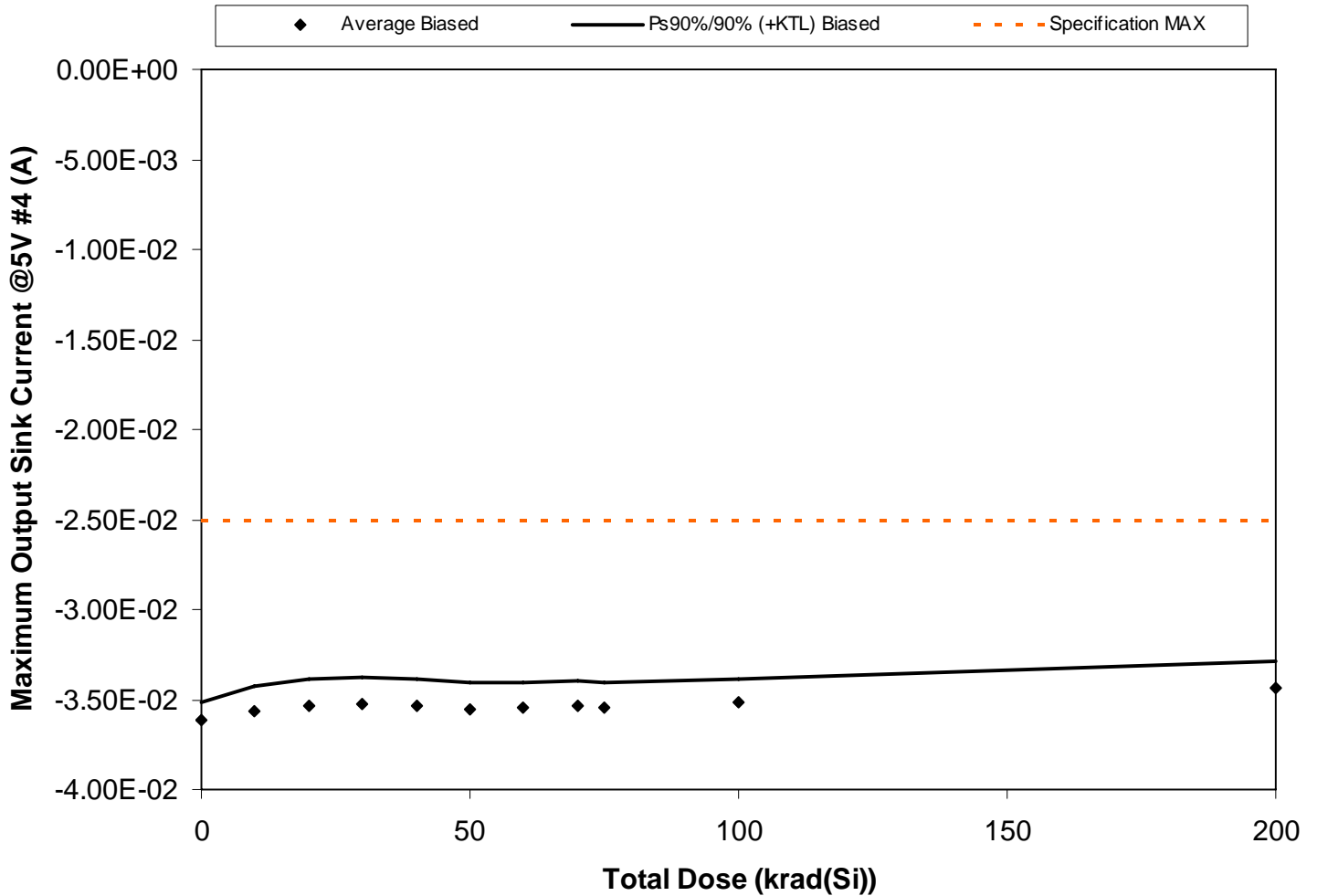

Figure 5.144. Plot of Maximum Output Sink Current @5V #4 (A) versus total dose. The solid diamonds are the average of the measured data points for the samples irradiated under electrical bias and the black lines (solid and/or dashed) are the average of the data points after application of the KTL statistics on the samples irradiated under electrical bias. The red dotted line(s) are the pre- and/or post-irradiation minimum and/or maximum specification value as defined in the datasheet and/or test plan.



**RLAT Report
10-326 100808 R1.0**

**Radiation Assured Devices
5017 N. 30th Street
Colorado Springs, CO 80919
(719) 531-0800**

Table 5.144. Raw data for Maximum Output Sink Current @5V #4 (A) versus total dose, including the statistical analysis, specification and the status of the testing (pass/fail).

Maximum Output Sink Current @5V #4 (A)	Total Dose (krad(Si))											
	0	10	20	30	40	50	60	70	75	100	200	
Device												
1245	-3.59E-02	-3.56E-02	-3.52E-02	-3.51E-02	-3.51E-02	-3.53E-02	-3.53E-02	-3.52E-02	-3.53E-02	-3.51E-02	-3.45E-02	
1246	-3.62E-02	-3.54E-02	-3.52E-02	-3.52E-02	-3.53E-02	-3.54E-02	-3.54E-02	-3.53E-02	-3.55E-02	-3.52E-02	-3.46E-02	
1247	-3.65E-02	-3.61E-02	-3.58E-02	-3.57E-02	-3.58E-02	-3.61E-02	-3.62E-02	-3.59E-02	-3.61E-02	-3.59E-02	-3.54E-02	
1248	-3.67E-02	-3.68E-02	-3.67E-02	-3.67E-02	-3.67E-02	-3.67E-02	-3.65E-02	-3.63E-02	-3.64E-02	-3.61E-02	-3.51E-02	
1249	-3.71E-02	-3.68E-02	-3.65E-02	-3.64E-02	-3.64E-02	-3.66E-02	-3.65E-02	-3.64E-02	-3.65E-02	-3.63E-02	-3.54E-02	
1250	-3.59E-02	-3.52E-02	-3.49E-02	-3.48E-02	-3.48E-02	-3.49E-02	-3.49E-02	-3.48E-02	-3.50E-02	-3.47E-02	-3.40E-02	
1251	-3.57E-02	-3.50E-02	-3.46E-02	-3.45E-02	-3.46E-02	-3.47E-02	-3.47E-02	-3.46E-02	-3.47E-02	-3.45E-02	-3.36E-02	
1261	-3.58E-02	-3.51E-02	-3.48E-02	-3.47E-02	-3.47E-02	-3.50E-02	-3.49E-02	-3.48E-02	-3.48E-02	-3.46E-02	-3.35E-02	
1262	-3.59E-02	-3.54E-02	-3.51E-02	-3.50E-02	-3.50E-02	-3.52E-02	-3.52E-02	-3.51E-02	-3.52E-02	-3.50E-02	-3.42E-02	
1263	-3.59E-02	-3.52E-02	-3.49E-02	-3.48E-02	-3.50E-02	-3.51E-02	-3.50E-02	-3.49E-02	-3.50E-02	-3.46E-02	-3.37E-02	
1264	-3.64E-02	-3.64E-02	-3.64E-02	-3.64E-02	-3.64E-02	-3.65E-02	-3.65E-02	-3.64E-02	-3.65E-02	-3.64E-02	-3.64E-02	
1265	-3.57E-02	-3.57E-02	-3.57E-02	-3.57E-02	-3.57E-02	-3.58E-02	-3.58E-02	-3.57E-02	-3.58E-02	-3.57E-02	-3.57E-02	
Biased Statistics												
Average Biased	-3.62E-02	-3.57E-02	-3.54E-02	-3.53E-02	-3.53E-02	-3.55E-02	-3.55E-02	-3.53E-02	-3.55E-02	-3.52E-02	-3.44E-02	
Std Dev Biased	4.69E-04	6.67E-04	7.32E-04	7.39E-04	7.22E-04	7.06E-04	6.79E-04	6.49E-04	6.68E-04	6.66E-04	7.28E-04	
Ps90%/90% (+KTL) Biased	-3.52E-02	-3.43E-02	-3.39E-02	-3.38E-02	-3.38E-02	-3.40E-02	-3.41E-02	-3.40E-02	-3.41E-02	-3.38E-02	-3.29E-02	
Ps90%/90% (-KTL) Biased	-3.71E-02	-3.70E-02	-3.69E-02	-3.68E-02	-3.68E-02	-3.70E-02	-3.69E-02	-3.67E-02	-3.68E-02	-3.66E-02	-3.59E-02	
Specification MAX	-2.50E-02	-2.50E-02	-2.50E-02	-2.50E-02	-2.50E-02	-2.50E-02	-2.50E-02	-2.50E-02	-2.50E-02	-2.50E-02	-2.50E-02	
Status	PASS	PASS	PASS	PASS	PASS	PASS	PASS	PASS	PASS	PASS	PASS	

An ISO 9001:2008 and DSCC Certified Company

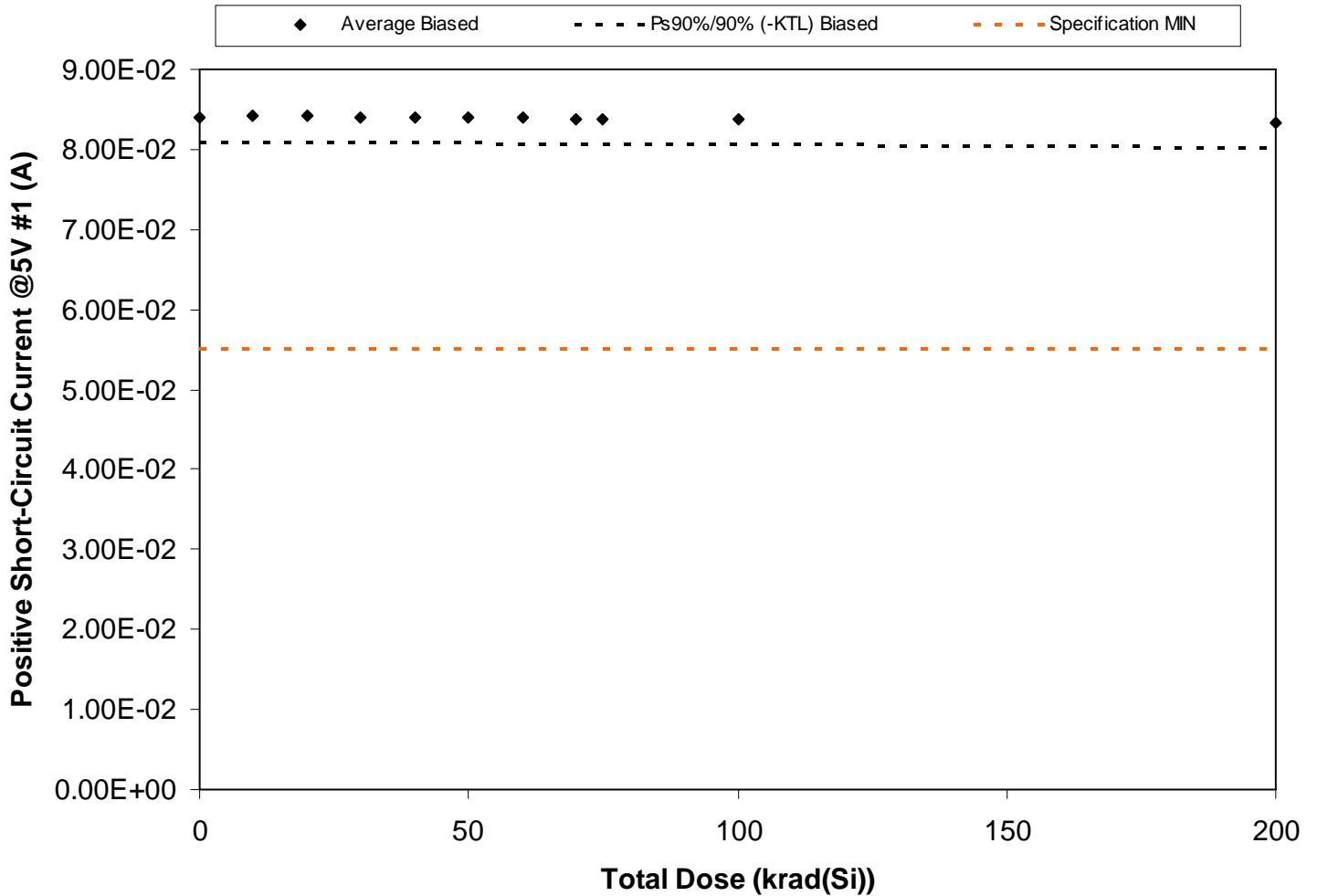

Figure 5.145. Plot of Positive Short-Circuit Current @5V #1 (A) versus total dose. The solid diamonds are the average of the measured data points for the samples irradiated under electrical bias and the black lines (solid and/or dashed) are the average of the data points after application of the KTL statistics on the samples irradiated under electrical bias. The red dotted line(s) are the pre- and/or post-irradiation minimum and/or maximum specification value as defined in the datasheet and/or test plan.



**RLAT Report
10-326 100808 R1.0**

**Radiation Assured Devices
5017 N. 30th Street
Colorado Springs, CO 80919
(719) 531-0800**

Table 5.145. Raw data for Positive Short-Circuit Current @5V #1 (A) versus total dose, including the statistical analysis, specification and the status of the testing (pass/fail).

Positive Short-Circuit Current @5V #1 (A)	Total Dose (krad(Si))											
	0	10	20	30	40	50	60	70	75	100	200	
Device												
1245	8.28E-02	8.28E-02	8.28E-02	8.27E-02	8.26E-02	8.26E-02	8.26E-02	8.25E-02	8.25E-02	8.24E-02	8.22E-02	
1246	8.42E-02	8.44E-02	8.43E-02	8.42E-02	8.41E-02	8.41E-02	8.40E-02	8.39E-02	8.39E-02	8.38E-02	8.34E-02	
1247	8.48E-02	8.49E-02	8.49E-02	8.48E-02	8.47E-02	8.47E-02	8.46E-02	8.46E-02	8.45E-02	8.44E-02	8.41E-02	
1248	8.65E-02	8.67E-02	8.66E-02	8.64E-02	8.64E-02	8.63E-02	8.63E-02	8.62E-02	8.62E-02	8.61E-02	8.57E-02	
1249	8.68E-02	8.69E-02	8.69E-02	8.68E-02	8.67E-02	8.67E-02	8.66E-02	8.65E-02	8.66E-02	8.64E-02	8.61E-02	
1250	8.27E-02	8.28E-02	8.28E-02	8.27E-02	8.27E-02	8.27E-02	8.26E-02	8.25E-02	8.25E-02	8.24E-02	8.22E-02	
1251	8.26E-02	8.27E-02	8.27E-02	8.25E-02	8.25E-02	8.24E-02	8.24E-02	8.23E-02	8.23E-02	8.22E-02	8.18E-02	
1261	8.35E-02	8.37E-02	8.36E-02	8.36E-02	8.35E-02	8.35E-02	8.34E-02	8.34E-02	8.33E-02	8.33E-02	8.29E-02	
1262	8.40E-02	8.42E-02	8.41E-02	8.41E-02	8.40E-02	8.40E-02	8.39E-02	8.39E-02	8.39E-02	8.38E-02	8.34E-02	
1263	8.27E-02	8.28E-02	8.28E-02	8.27E-02	8.26E-02	8.26E-02	8.25E-02	8.24E-02	8.24E-02	8.23E-02	8.21E-02	
1264	8.41E-02	8.43E-02	8.43E-02	8.43E-02	8.43E-02	8.43E-02	8.42E-02	8.42E-02	8.43E-02	8.42E-02	8.42E-02	
1265	8.45E-02	8.47E-02	8.47E-02	8.47E-02	8.47E-02	8.47E-02	8.47E-02	8.46E-02	8.47E-02	8.47E-02	8.46E-02	
Biased Statistics												
Average Biased	8.41E-02	8.42E-02	8.41E-02	8.40E-02	8.40E-02	8.40E-02	8.39E-02	8.38E-02	8.38E-02	8.37E-02	8.34E-02	
Std Dev Biased	1.57E-03	1.58E-03	1.55E-03	1.56E-03	1.55E-03	1.55E-03	1.55E-03	1.55E-03	1.55E-03	1.53E-03	1.51E-03	
Ps90%/90% (+KTL) Biased	8.73E-02	8.74E-02	8.73E-02	8.72E-02	8.72E-02	8.72E-02	8.71E-02	8.70E-02	8.70E-02	8.69E-02	8.65E-02	
Ps90%/90% (-KTL) Biased	8.08E-02	8.09E-02	8.09E-02	8.08E-02	8.08E-02	8.08E-02	8.07E-02	8.06E-02	8.06E-02	8.05E-02	8.03E-02	
Specification MIN	5.50E-02	5.50E-02	5.50E-02	5.50E-02	5.50E-02	5.50E-02	5.50E-02	5.50E-02	5.50E-02	5.50E-02	5.50E-02	
Status	PASS	PASS	PASS	PASS	PASS	PASS	PASS	PASS	PASS	PASS	PASS	

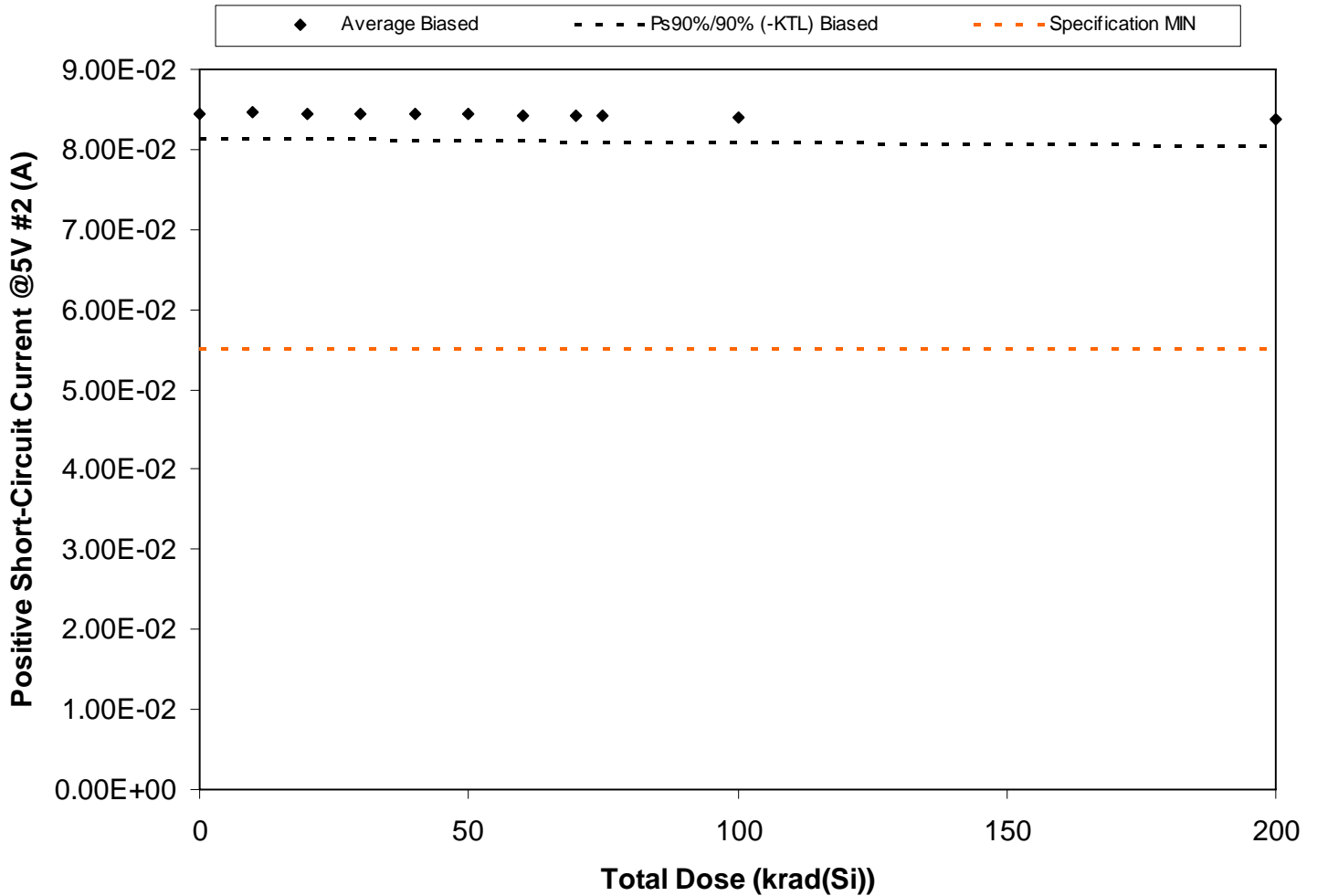

Figure 5.146. Plot of Positive Short-Circuit Current @5V #2 (A) versus total dose. The solid diamonds are the average of the measured data points for the samples irradiated under electrical bias and the black lines (solid and/or dashed) are the average of the data points after application of the KTL statistics on the samples irradiated under electrical bias. The red dotted line(s) are the pre- and/or post-irradiation minimum and/or maximum specification value as defined in the datasheet and/or test plan.



**RLAT Report
10-326 100808 R1.0**

**Radiation Assured Devices
5017 N. 30th Street
Colorado Springs, CO 80919
(719) 531-0800**

Table 5.146. Raw data for Positive Short-Circuit Current @5V #2 (A) versus total dose, including the statistical analysis, specification and the status of the testing (pass/fail).

Positive Short-Circuit Current @5V #2 (A)	Total Dose (krad(Si))											
	0	10	20	30	40	50	60	70	75	100	200	
Device												
1245	8.24E-02	8.24E-02	8.24E-02	8.23E-02	8.23E-02	8.22E-02	8.21E-02	8.20E-02	8.21E-02	8.19E-02	8.16E-02	
1246	8.44E-02	8.45E-02	8.44E-02	8.43E-02	8.42E-02	8.42E-02	8.41E-02	8.40E-02	8.40E-02	8.39E-02	8.35E-02	
1247	8.37E-02	8.39E-02	8.38E-02	8.37E-02	8.37E-02	8.37E-02	8.36E-02	8.35E-02	8.35E-02	8.34E-02	8.32E-02	
1248	8.72E-02	8.73E-02	8.73E-02	8.72E-02	8.72E-02	8.72E-02	8.71E-02	8.71E-02	8.71E-02	8.70E-02	8.68E-02	
1249	8.39E-02	8.40E-02	8.39E-02	8.38E-02	8.37E-02	8.37E-02	8.36E-02	8.35E-02	8.35E-02	8.34E-02	8.30E-02	
1250	8.27E-02	8.28E-02	8.27E-02	8.26E-02	8.25E-02	8.26E-02	8.24E-02	8.24E-02	8.24E-02	8.22E-02	8.20E-02	
1251	8.42E-02	8.43E-02	8.42E-02	8.41E-02	8.41E-02	8.40E-02	8.40E-02	8.39E-02	8.39E-02	8.38E-02	8.35E-02	
1261	8.48E-02	8.50E-02	8.49E-02	8.48E-02	8.47E-02	8.47E-02	8.46E-02	8.46E-02	8.46E-02	8.45E-02	8.41E-02	
1262	8.45E-02	8.47E-02	8.46E-02	8.46E-02	8.45E-02	8.45E-02	8.44E-02	8.44E-02	8.44E-02	8.42E-02	8.40E-02	
1263	8.66E-02	8.67E-02	8.67E-02	8.66E-02	8.65E-02	8.65E-02	8.64E-02	8.64E-02	8.64E-02	8.63E-02	8.59E-02	
1264	8.33E-02	8.35E-02	8.35E-02	8.35E-02	8.35E-02	8.35E-02	8.35E-02	8.34E-02	8.35E-02	8.35E-02	8.34E-02	
1265	8.23E-02	8.25E-02	8.26E-02	8.25E-02	8.25E-02	8.25E-02	8.25E-02	8.25E-02	8.25E-02	8.25E-02	8.24E-02	
Biased Statistics												
Average Biased	8.44E-02	8.46E-02	8.45E-02	8.44E-02	8.43E-02	8.43E-02	8.42E-02	8.42E-02	8.42E-02	8.41E-02	8.38E-02	
Std Dev Biased	1.52E-03	1.52E-03	1.54E-03	1.54E-03	1.55E-03	1.55E-03	1.56E-03	1.56E-03	1.56E-03	1.59E-03	1.60E-03	
Ps90%/90% (+KTL) Biased	8.76E-02	8.77E-02	8.77E-02	8.76E-02	8.75E-02	8.75E-02	8.75E-02	8.74E-02	8.74E-02	8.73E-02	8.71E-02	
Ps90%/90% (-KTL) Biased	8.13E-02	8.14E-02	8.13E-02	8.12E-02	8.12E-02	8.11E-02	8.10E-02	8.10E-02	8.10E-02	8.08E-02	8.05E-02	
Specification MIN	5.50E-02	5.50E-02	5.50E-02	5.50E-02	5.50E-02	5.50E-02	5.50E-02	5.50E-02	5.50E-02	5.50E-02	5.50E-02	
Status	PASS	PASS	PASS	PASS	PASS	PASS	PASS	PASS	PASS	PASS	PASS	

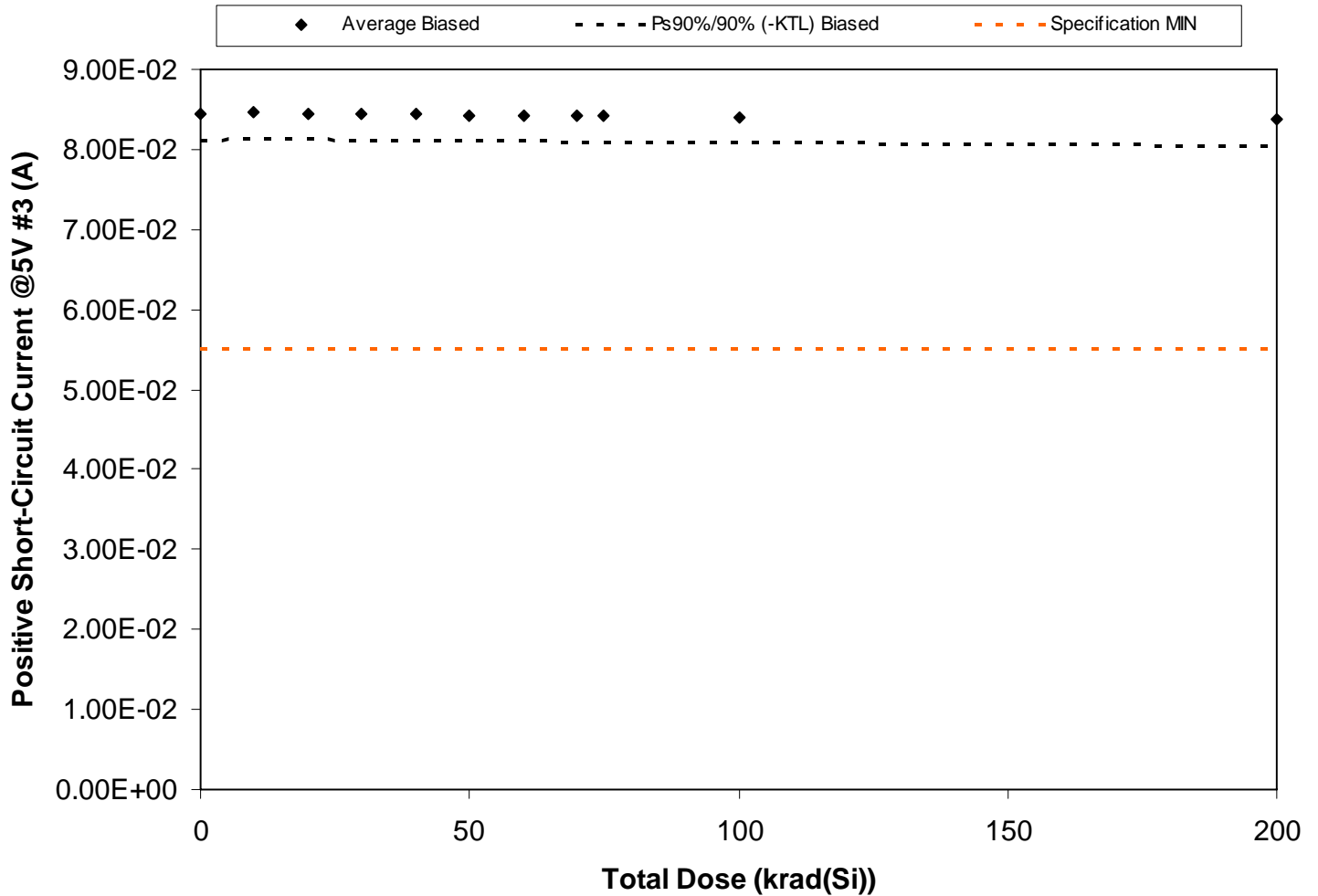

Figure 5.147. Plot of Positive Short-Circuit Current @5V #3 (A) versus total dose. The solid diamonds are the average of the measured data points for the samples irradiated under electrical bias and the black lines (solid and/or dashed) are the average of the data points after application of the KTL statistics on the samples irradiated under electrical bias. The red dotted line(s) are the pre- and/or post-irradiation minimum and/or maximum specification value as defined in the datasheet and/or test plan.



**RLAT Report
10-326 100808 R1.0**

**Radiation Assured Devices
5017 N. 30th Street
Colorado Springs, CO 80919
(719) 531-0800**

Table 5.147. Raw data for Positive Short-Circuit Current @5V #3 (A) versus total dose, including the statistical analysis, specification and the status of the testing (pass/fail).

Positive Short-Circuit Current @5V #3 (A)	Total Dose (krad(Si))											
	0	10	20	30	40	50	60	70	75	100	200	
Device												
1245	8.23E-02	8.23E-02	8.23E-02	8.22E-02	8.22E-02	8.21E-02	8.21E-02	8.20E-02	8.20E-02	8.19E-02	8.16E-02	
1246	8.45E-02	8.46E-02	8.45E-02	8.44E-02	8.44E-02	8.43E-02	8.42E-02	8.41E-02	8.41E-02	8.40E-02	8.36E-02	
1247	8.39E-02	8.40E-02	8.40E-02	8.39E-02	8.39E-02	8.38E-02	8.38E-02	8.37E-02	8.37E-02	8.35E-02	8.32E-02	
1248	8.74E-02	8.75E-02	8.74E-02	8.73E-02	8.73E-02	8.72E-02	8.71E-02	8.70E-02	8.70E-02	8.69E-02	8.66E-02	
1249	8.35E-02	8.36E-02	8.36E-02	8.35E-02	8.34E-02	8.34E-02	8.33E-02	8.33E-02	8.33E-02	8.32E-02	8.29E-02	
1250	8.25E-02	8.27E-02	8.25E-02	8.25E-02	8.24E-02	8.24E-02	8.23E-02	8.22E-02	8.22E-02	8.21E-02	8.17E-02	
1251	8.46E-02	8.47E-02	8.47E-02	8.46E-02	8.45E-02	8.45E-02	8.44E-02	8.44E-02	8.44E-02	8.42E-02	8.39E-02	
1261	8.48E-02	8.51E-02	8.50E-02	8.50E-02	8.49E-02	8.49E-02	8.48E-02	8.47E-02	8.47E-02	8.46E-02	8.44E-02	
1262	8.45E-02	8.46E-02	8.46E-02	8.45E-02	8.44E-02	8.44E-02	8.44E-02	8.43E-02	8.44E-02	8.42E-02	8.39E-02	
1263	8.65E-02	8.66E-02	8.66E-02	8.64E-02	8.64E-02	8.63E-02	8.63E-02	8.62E-02	8.62E-02	8.61E-02	8.57E-02	
1264	8.34E-02	8.36E-02	8.36E-02	8.36E-02	8.36E-02	8.36E-02	8.36E-02	8.35E-02	8.35E-02	8.35E-02	8.35E-02	
1265	8.21E-02	8.23E-02	8.23E-02	8.23E-02	8.23E-02	8.22E-02	8.22E-02	8.22E-02	8.22E-02	8.22E-02	8.22E-02	
Biased Statistics												
Average Biased	8.45E-02	8.46E-02	8.45E-02	8.44E-02	8.44E-02	8.43E-02	8.43E-02	8.42E-02	8.42E-02	8.41E-02	8.37E-02	
Std Dev Biased	1.58E-03	1.60E-03	1.59E-03	1.57E-03	1.58E-03	1.57E-03	1.59E-03	1.58E-03	1.59E-03	1.58E-03	1.57E-03	
Ps90%/90% (+KTL) Biased	8.77E-02	8.79E-02	8.78E-02	8.77E-02	8.76E-02	8.76E-02	8.75E-02	8.74E-02	8.75E-02	8.73E-02	8.70E-02	
Ps90%/90% (-KTL) Biased	8.12E-02	8.13E-02	8.12E-02	8.12E-02	8.11E-02	8.11E-02	8.10E-02	8.09E-02	8.09E-02	8.08E-02	8.05E-02	
Specification MIN	5.50E-02	5.50E-02	5.50E-02	5.50E-02	5.50E-02	5.50E-02	5.50E-02	5.50E-02	5.50E-02	5.50E-02	5.50E-02	
Status	PASS	PASS	PASS	PASS	PASS	PASS	PASS	PASS	PASS	PASS	PASS	

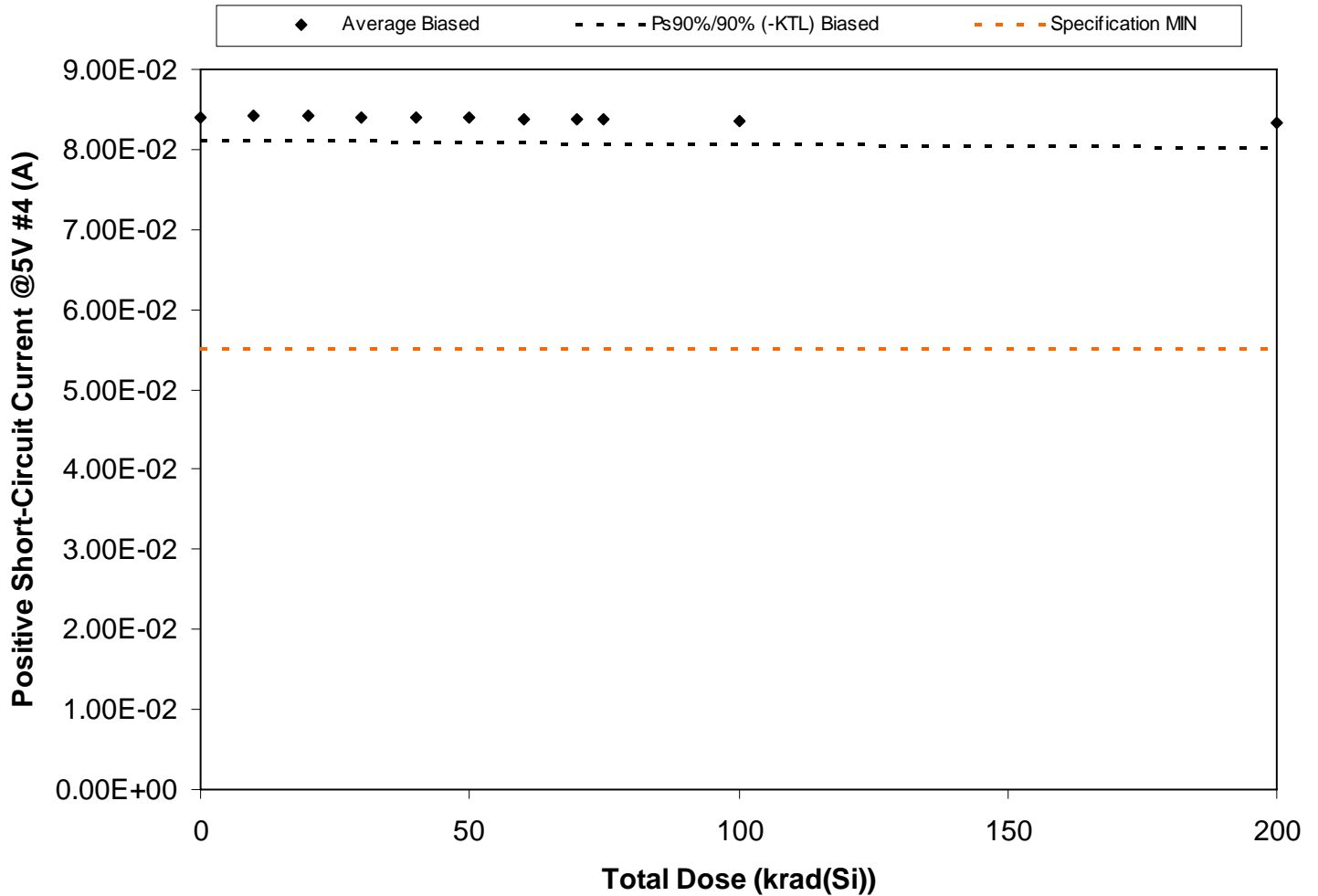

Figure 5.148. Plot of Positive Short-Circuit Current @5V #4 (A) versus total dose. The solid diamonds are the average of the measured data points for the samples irradiated under electrical bias and the black lines (solid and/or dashed) are the average of the data points after application of the KTL statistics on the samples irradiated under electrical bias. The red dotted line(s) are the pre- and/or post-irradiation minimum and/or maximum specification value as defined in the datasheet and/or test plan.



**RLAT Report
10-326 100808 R1.0**

**Radiation Assured Devices
5017 N. 30th Street
Colorado Springs, CO 80919
(719) 531-0800**

Table 5.148. Raw data for Positive Short-Circuit Current @5V #4 (A) versus total dose, including the statistical analysis, specification and the status of the testing (pass/fail).

Positive Short-Circuit Current @5V #4 (A)	Total Dose (krad(Si))											
	0	10	20	30	40	50	60	70	75	100	200	
Device												
1245	8.29E-02	8.29E-02	8.29E-02	8.28E-02	8.27E-02	8.27E-02	8.26E-02	8.25E-02	8.25E-02	8.24E-02	8.21E-02	
1246	8.41E-02	8.43E-02	8.42E-02	8.41E-02	8.41E-02	8.40E-02	8.39E-02	8.39E-02	8.39E-02	8.38E-02	8.35E-02	
1247	8.47E-02	8.49E-02	8.49E-02	8.48E-02	8.47E-02	8.47E-02	8.47E-02	8.46E-02	8.46E-02	8.45E-02	8.43E-02	
1248	8.63E-02	8.64E-02	8.63E-02	8.62E-02	8.62E-02	8.61E-02	8.61E-02	8.59E-02	8.60E-02	8.58E-02	8.55E-02	
1249	8.65E-02	8.67E-02	8.66E-02	8.65E-02	8.64E-02	8.64E-02	8.63E-02	8.63E-02	8.63E-02	8.62E-02	8.58E-02	
1250	8.28E-02	8.29E-02	8.29E-02	8.28E-02	8.27E-02	8.27E-02	8.26E-02	8.25E-02	8.25E-02	8.23E-02	8.20E-02	
1251	8.28E-02	8.29E-02	8.29E-02	8.28E-02	8.27E-02	8.27E-02	8.27E-02	8.26E-02	8.26E-02	8.24E-02	8.22E-02	
1261	8.34E-02	8.36E-02	8.36E-02	8.35E-02	8.35E-02	8.34E-02	8.34E-02	8.33E-02	8.33E-02	8.32E-02	8.29E-02	
1262	8.39E-02	8.40E-02	8.40E-02	8.39E-02	8.38E-02	8.38E-02	8.36E-02	8.36E-02	8.37E-02	8.35E-02	8.31E-02	
1263	8.26E-02	8.27E-02	8.27E-02	8.25E-02	8.24E-02	8.24E-02	8.23E-02	8.22E-02	8.22E-02	8.21E-02	8.17E-02	
1264	8.41E-02	8.43E-02	8.43E-02	8.43E-02	8.42E-02	8.43E-02	8.42E-02	8.42E-02	8.43E-02	8.42E-02	8.42E-02	
1265	8.46E-02	8.48E-02	8.48E-02	8.47E-02	8.47E-02	8.47E-02	8.47E-02	8.47E-02	8.47E-02	8.47E-02	8.47E-02	
Biased Statistics												
Average Biased	8.40E-02	8.41E-02	8.41E-02	8.40E-02	8.39E-02	8.39E-02	8.38E-02	8.37E-02	8.38E-02	8.36E-02	8.33E-02	
Std Dev Biased	1.45E-03	1.46E-03	1.43E-03	1.44E-03	1.45E-03	1.45E-03	1.46E-03	1.45E-03	1.46E-03	1.47E-03	1.47E-03	
Ps90%/90% (+KTL) Biased	8.70E-02	8.71E-02	8.71E-02	8.70E-02	8.69E-02	8.69E-02	8.68E-02	8.67E-02	8.68E-02	8.66E-02	8.63E-02	
Ps90%/90% (-KTL) Biased	8.10E-02	8.11E-02	8.12E-02	8.10E-02	8.09E-02	8.09E-02	8.08E-02	8.07E-02	8.07E-02	8.06E-02	8.03E-02	
Specification MIN	5.50E-02	5.50E-02	5.50E-02	5.50E-02	5.50E-02	5.50E-02	5.50E-02	5.50E-02	5.50E-02	5.50E-02	5.50E-02	
Status	PASS	PASS	PASS	PASS	PASS	PASS	PASS	PASS	PASS	PASS	PASS	

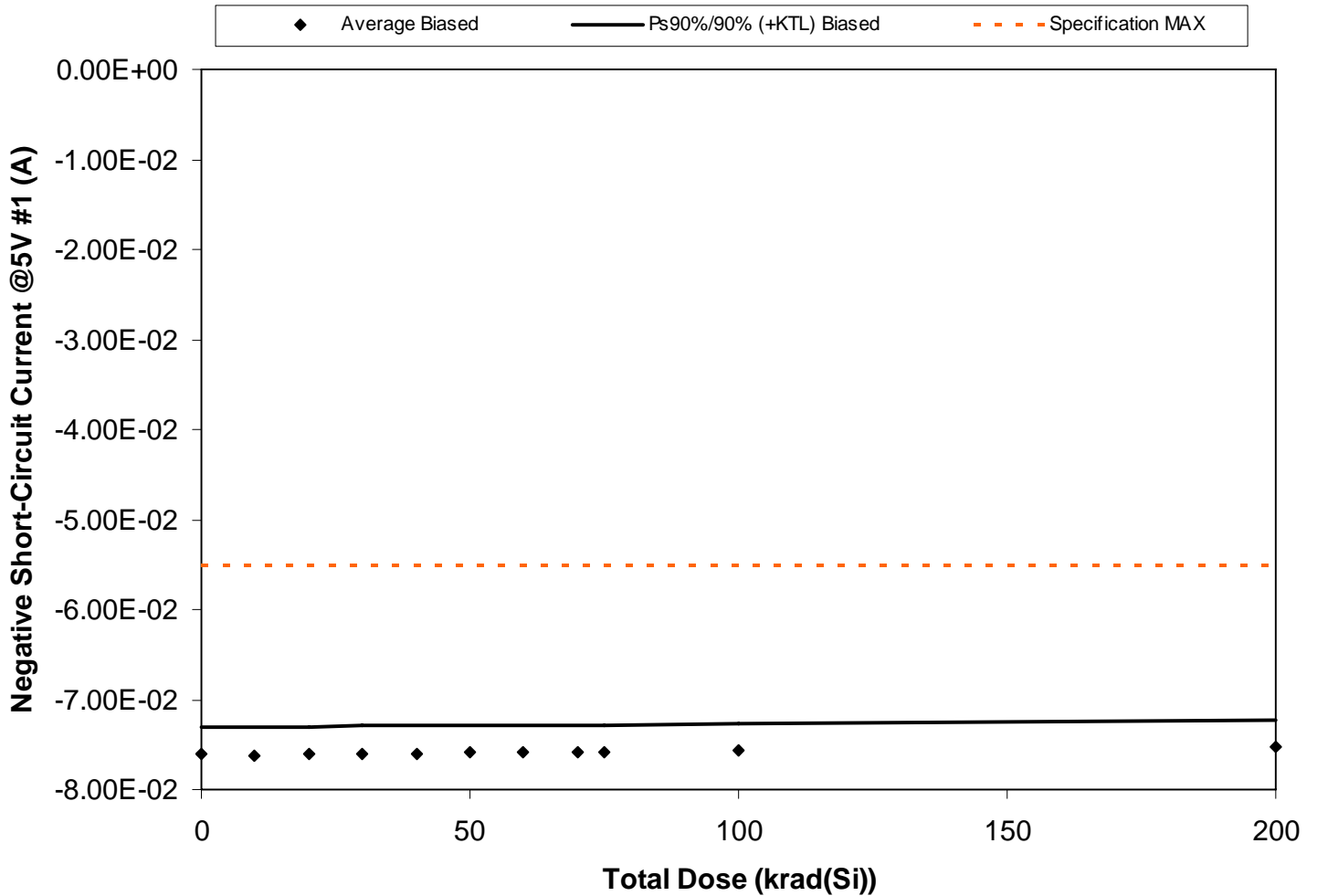

Figure 5.149. Plot of Negative Short-Circuit Current @5V #1 (A) versus total dose. The solid diamonds are the average of the measured data points for the samples irradiated under electrical bias and the black lines (solid and/or dashed) are the average of the data points after application of the KTL statistics on the samples irradiated under electrical bias. The red dotted line(s) are the pre- and/or post-irradiation minimum and/or maximum specification value as defined in the datasheet and/or test plan.



**RLAT Report
10-326 100808 R1.0**

**Radiation Assured Devices
5017 N. 30th Street
Colorado Springs, CO 80919
(719) 531-0800**

Table 5.149. Raw data for Negative Short-Circuit Current @5V #1 (A) versus total dose, including the statistical analysis, specification and the status of the testing (pass/fail).

Negative Short-Circuit Current @5V #1 (A)	Total Dose (krad(Si))											
	0	10	20	30	40	50	60	70	75	100	200	
Device												
1245	-7.50E-02	-7.50E-02	-7.50E-02	-7.49E-02	-7.48E-02	-7.49E-02	-7.48E-02	-7.47E-02	-7.48E-02	-7.46E-02	-7.44E-02	
1246	-7.59E-02	-7.60E-02	-7.59E-02	-7.58E-02	-7.58E-02	-7.57E-02	-7.57E-02	-7.57E-02	-7.56E-02	-7.55E-02	-7.52E-02	
1247	-7.69E-02	-7.69E-02	-7.69E-02	-7.68E-02	-7.68E-02	-7.68E-02	-7.67E-02	-7.67E-02	-7.67E-02	-7.65E-02	-7.62E-02	
1248	-7.84E-02	-7.85E-02	-7.84E-02	-7.83E-02	-7.81E-02	-7.81E-02	-7.80E-02	-7.79E-02	-7.79E-02	-7.78E-02	-7.73E-02	
1249	-7.88E-02	-7.89E-02	-7.87E-02	-7.87E-02	-7.86E-02	-7.86E-02	-7.86E-02	-7.85E-02	-7.84E-02	-7.83E-02	-7.79E-02	
1250	-7.48E-02	-7.49E-02	-7.49E-02	-7.47E-02	-7.47E-02	-7.48E-02	-7.47E-02	-7.46E-02	-7.46E-02	-7.45E-02	-7.41E-02	
1251	-7.47E-02	-7.49E-02	-7.47E-02	-7.46E-02	-7.46E-02	-7.45E-02	-7.45E-02	-7.44E-02	-7.44E-02	-7.43E-02	-7.39E-02	
1261	-7.53E-02	-7.55E-02	-7.54E-02	-7.53E-02	-7.52E-02	-7.52E-02	-7.51E-02	-7.50E-02	-7.50E-02	-7.48E-02	-7.44E-02	
1262	-7.61E-02	-7.62E-02	-7.61E-02	-7.61E-02	-7.60E-02	-7.60E-02	-7.59E-02	-7.58E-02	-7.58E-02	-7.57E-02	-7.53E-02	
1263	-7.48E-02	-7.50E-02	-7.50E-02	-7.49E-02	-7.48E-02	-7.47E-02	-7.47E-02	-7.46E-02	-7.46E-02	-7.45E-02	-7.41E-02	
1264	-7.63E-02	-7.65E-02	-7.65E-02	-7.65E-02	-7.65E-02	-7.66E-02	-7.65E-02	-7.65E-02	-7.66E-02	-7.66E-02	-7.65E-02	
1265	-7.63E-02	-7.64E-02	-7.64E-02	-7.64E-02	-7.64E-02	-7.64E-02	-7.64E-02	-7.64E-02	-7.64E-02	-7.64E-02	-7.64E-02	
Biased Statistics												
Average Biased	-7.61E-02	-7.62E-02	-7.61E-02	-7.60E-02	-7.60E-02	-7.59E-02	-7.59E-02	-7.58E-02	-7.58E-02	-7.57E-02	-7.53E-02	
Std Dev Biased	1.48E-03	1.48E-03	1.46E-03	1.47E-03	1.45E-03	1.47E-03	1.44E-03	1.45E-03	1.44E-03	1.43E-03	1.41E-03	
Ps90%/90% (+KTL) Biased	-7.30E-02	-7.31E-02	-7.31E-02	-7.30E-02	-7.30E-02	-7.29E-02	-7.29E-02	-7.28E-02	-7.28E-02	-7.27E-02	-7.24E-02	
Ps90%/90% (-KTL) Biased	-7.91E-02	-7.92E-02	-7.91E-02	-7.90E-02	-7.90E-02	-7.90E-02	-7.88E-02	-7.88E-02	-7.88E-02	-7.86E-02	-7.82E-02	
Specification MAX	-5.50E-02	-5.50E-02	-5.50E-02	-5.50E-02	-5.50E-02	-5.50E-02	-5.50E-02	-5.50E-02	-5.50E-02	-5.50E-02	-5.50E-02	
Status	PASS	PASS	PASS	PASS	PASS	PASS	PASS	PASS	PASS	PASS	PASS	

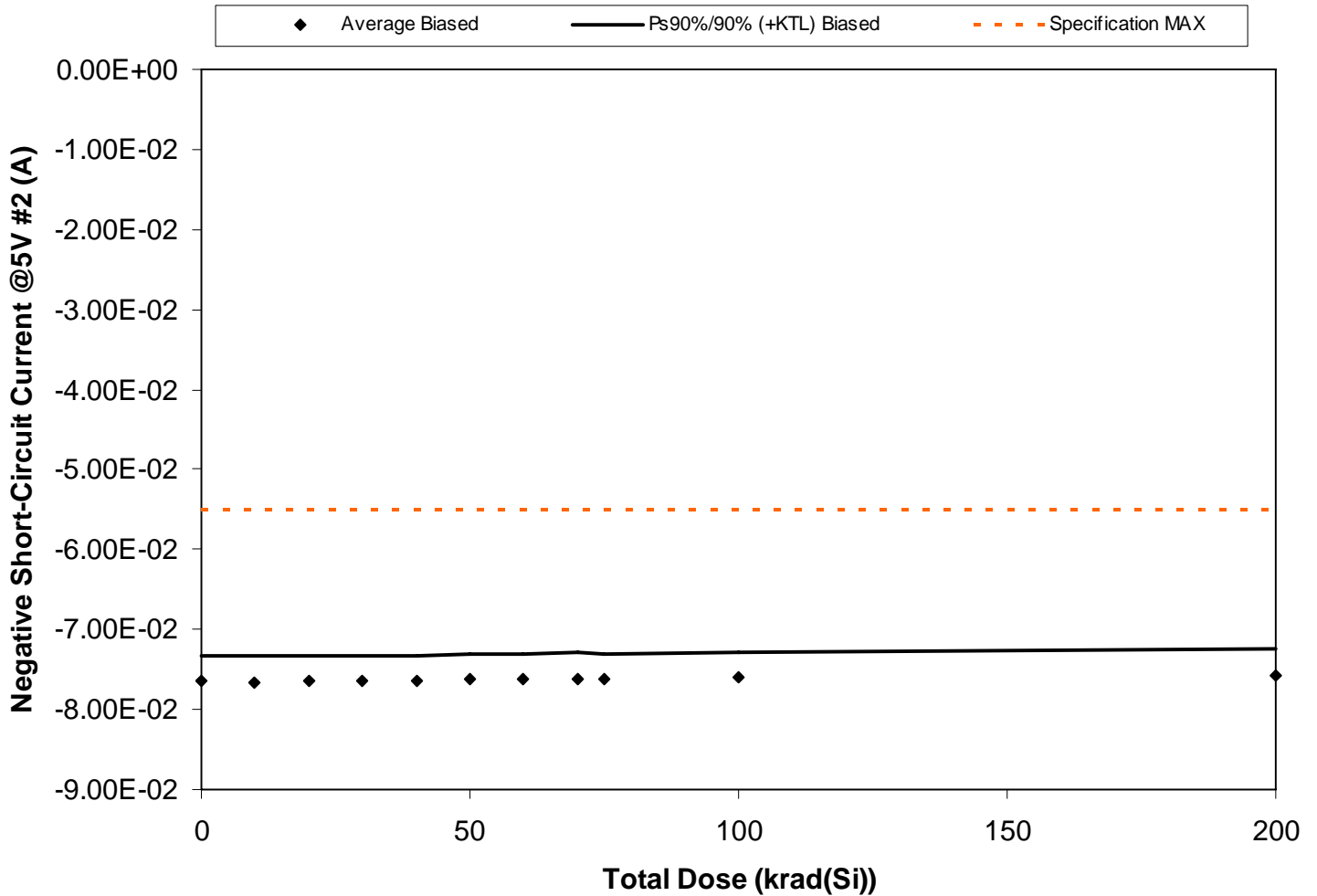

Figure 5.150. Plot of Negative Short-Circuit Current @5V #2 (A) versus total dose. The solid diamonds are the average of the measured data points for the samples irradiated under electrical bias and the black lines (solid and/or dashed) are the average of the data points after application of the KTL statistics on the samples irradiated under electrical bias. The red dotted line(s) are the pre- and/or post-irradiation minimum and/or maximum specification value as defined in the datasheet and/or test plan.



**RLAT Report
10-326 100808 R1.0**

**Radiation Assured Devices
5017 N. 30th Street
Colorado Springs, CO 80919
(719) 531-0800**

Table 5.150. Raw data for Negative Short-Circuit Current @5V #2 (A) versus total dose, including the statistical analysis, specification and the status of the testing (pass/fail).

Negative Short-Circuit Current @5V #2 (A)	Total Dose (krad(Si))											
	0	10	20	30	40	50	60	70	75	100	200	
Device												
1245	-7.44E-02	-7.44E-02	-7.44E-02	-7.42E-02	-7.43E-02	-7.41E-02	-7.41E-02	-7.40E-02	-7.40E-02	-7.39E-02	-7.35E-02	
1246	-7.63E-02	-7.64E-02	-7.63E-02	-7.62E-02	-7.62E-02	-7.61E-02	-7.61E-02	-7.59E-02	-7.60E-02	-7.58E-02	-7.55E-02	
1247	-7.58E-02	-7.60E-02	-7.59E-02	-7.58E-02	-7.57E-02	-7.57E-02	-7.57E-02	-7.56E-02	-7.56E-02	-7.55E-02	-7.52E-02	
1248	-7.91E-02	-7.92E-02	-7.92E-02	-7.91E-02	-7.90E-02	-7.90E-02	-7.89E-02	-7.88E-02	-7.88E-02	-7.86E-02	-7.82E-02	
1249	-7.59E-02	-7.61E-02	-7.61E-02	-7.59E-02	-7.59E-02	-7.58E-02	-7.58E-02	-7.57E-02	-7.57E-02	-7.56E-02	-7.52E-02	
1250	-7.47E-02	-7.48E-02	-7.47E-02	-7.46E-02	-7.46E-02	-7.45E-02	-7.44E-02	-7.44E-02	-7.43E-02	-7.42E-02	-7.38E-02	
1251	-7.61E-02	-7.62E-02	-7.62E-02	-7.61E-02	-7.60E-02	-7.60E-02	-7.59E-02	-7.59E-02	-7.58E-02	-7.58E-02	-7.55E-02	
1261	-7.67E-02	-7.68E-02	-7.67E-02	-7.67E-02	-7.66E-02	-7.66E-02	-7.65E-02	-7.65E-02	-7.64E-02	-7.64E-02	-7.61E-02	
1262	-7.65E-02	-7.66E-02	-7.66E-02	-7.65E-02	-7.64E-02	-7.64E-02	-7.63E-02	-7.63E-02	-7.62E-02	-7.62E-02	-7.57E-02	
1263	-7.88E-02	-7.89E-02	-7.89E-02	-7.87E-02	-7.87E-02	-7.86E-02	-7.86E-02	-7.86E-02	-7.86E-02	-7.85E-02	-7.81E-02	
1264	-7.55E-02	-7.56E-02	-7.56E-02	-7.56E-02	-7.56E-02	-7.56E-02	-7.56E-02	-7.56E-02	-7.56E-02	-7.56E-02	-7.56E-02	
1265	-7.44E-02	-7.46E-02	-7.46E-02	-7.46E-02	-7.46E-02	-7.45E-02	-7.45E-02	-7.45E-02	-7.45E-02	-7.45E-02	-7.45E-02	
Biased Statistics												
Average Biased	-7.64E-02	-7.65E-02	-7.65E-02	-7.64E-02	-7.63E-02	-7.63E-02	-7.62E-02	-7.62E-02	-7.61E-02	-7.61E-02	-7.57E-02	
Std Dev Biased	1.51E-03	1.52E-03	1.54E-03	1.54E-03	1.53E-03	1.54E-03	1.53E-03	1.56E-03	1.53E-03	1.54E-03	1.55E-03	
Ps90%/90% (+KTL) Biased	-7.33E-02	-7.34E-02	-7.33E-02	-7.32E-02	-7.32E-02	-7.31E-02	-7.31E-02	-7.29E-02	-7.30E-02	-7.29E-02	-7.25E-02	
Ps90%/90% (-KTL) Biased	-7.95E-02	-7.97E-02	-7.97E-02	-7.96E-02	-7.95E-02	-7.95E-02	-7.94E-02	-7.94E-02	-7.93E-02	-7.92E-02	-7.89E-02	
Specification MAX	-5.50E-02	-5.50E-02	-5.50E-02	-5.50E-02	-5.50E-02	-5.50E-02	-5.50E-02	-5.50E-02	-5.50E-02	-5.50E-02	-5.50E-02	
Status	PASS	PASS	PASS	PASS	PASS	PASS	PASS	PASS	PASS	PASS	PASS	

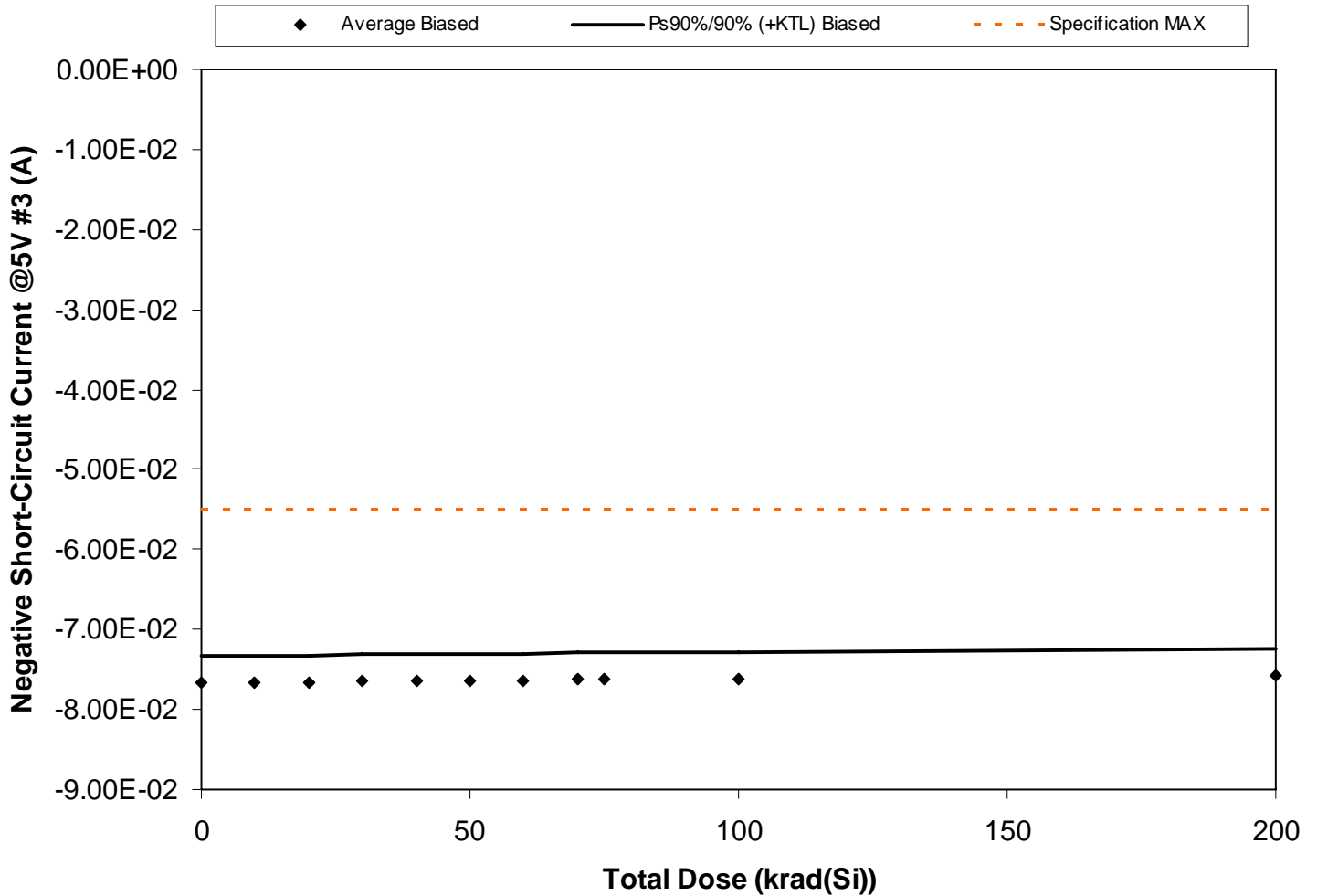

Figure 5.151. Plot of Negative Short-Circuit Current @5V #3 (A) versus total dose. The solid diamonds are the average of the measured data points for the samples irradiated under electrical bias and the black lines (solid and/or dashed) are the average of the data points after application of the KTL statistics on the samples irradiated under electrical bias. The red dotted line(s) are the pre- and/or post-irradiation minimum and/or maximum specification value as defined in the datasheet and/or test plan.



**RLAT Report
10-326 100808 R1.0**

**Radiation Assured Devices
5017 N. 30th Street
Colorado Springs, CO 80919
(719) 531-0800**

Table 5.151. Raw data for Negative Short-Circuit Current @5V #3 (A) versus total dose, including the statistical analysis, specification and the status of the testing (pass/fail).

Negative Short-Circuit Current @5V #3 (A)	Total Dose (krad(Si))											
	0	10	20	30	40	50	60	70	75	100	200	
Device												
1245	-7.44E-02	-7.44E-02	-7.44E-02	-7.42E-02	-7.41E-02	-7.41E-02	-7.40E-02	-7.39E-02	-7.39E-02	-7.38E-02	-7.34E-02	
1246	-7.63E-02	-7.64E-02	-7.64E-02	-7.63E-02	-7.63E-02	-7.62E-02	-7.62E-02	-7.61E-02	-7.61E-02	-7.59E-02	-7.56E-02	
1247	-7.60E-02	-7.61E-02	-7.61E-02	-7.59E-02	-7.60E-02	-7.58E-02	-7.58E-02	-7.57E-02	-7.57E-02	-7.56E-02	-7.52E-02	
1248	-7.96E-02	-7.97E-02	-7.97E-02	-7.95E-02	-7.95E-02	-7.94E-02	-7.93E-02	-7.92E-02	-7.92E-02	-7.91E-02	-7.86E-02	
1249	-7.58E-02	-7.59E-02	-7.58E-02	-7.57E-02	-7.57E-02	-7.56E-02	-7.56E-02	-7.55E-02	-7.55E-02	-7.53E-02	-7.49E-02	
1250	-7.47E-02	-7.49E-02	-7.49E-02	-7.47E-02	-7.46E-02	-7.46E-02	-7.46E-02	-7.45E-02	-7.45E-02	-7.44E-02	-7.40E-02	
1251	-7.65E-02	-7.67E-02	-7.66E-02	-7.66E-02	-7.64E-02	-7.65E-02	-7.64E-02	-7.63E-02	-7.63E-02	-7.63E-02	-7.59E-02	
1261	-7.68E-02	-7.69E-02	-7.69E-02	-7.68E-02	-7.68E-02	-7.67E-02	-7.67E-02	-7.67E-02	-7.67E-02	-7.65E-02	-7.62E-02	
1262	-7.65E-02	-7.67E-02	-7.66E-02	-7.65E-02	-7.64E-02	-7.64E-02	-7.64E-02	-7.63E-02	-7.63E-02	-7.62E-02	-7.59E-02	
1263	-7.90E-02	-7.91E-02	-7.90E-02	-7.89E-02	-7.89E-02	-7.89E-02	-7.87E-02	-7.87E-02	-7.88E-02	-7.86E-02	-7.83E-02	
1264	-7.58E-02	-7.60E-02	-7.61E-02	-7.60E-02	-7.60E-02	-7.60E-02	-7.59E-02	-7.59E-02	-7.60E-02	-7.60E-02	-7.59E-02	
1265	-7.44E-02	-7.46E-02	-7.46E-02	-7.45E-02	-7.46E-02	-7.45E-02	-7.45E-02	-7.45E-02	-7.45E-02	-7.45E-02	-7.45E-02	
Biased Statistics												
Average Biased	-7.66E-02	-7.67E-02	-7.66E-02	-7.65E-02	-7.65E-02	-7.64E-02	-7.64E-02	-7.63E-02	-7.63E-02	-7.62E-02	-7.58E-02	
Std Dev Biased	1.64E-03	1.65E-03	1.64E-03	1.63E-03	1.65E-03	1.64E-03	1.64E-03	1.65E-03	1.66E-03	1.66E-03	1.65E-03	
Ps90%/90% (+KTL) Biased	-7.32E-02	-7.33E-02	-7.32E-02	-7.32E-02	-7.31E-02	-7.30E-02	-7.30E-02	-7.29E-02	-7.29E-02	-7.27E-02	-7.24E-02	
Ps90%/90% (-KTL) Biased	-7.99E-02	-8.01E-02	-8.00E-02	-7.99E-02	-7.99E-02	-7.98E-02	-7.98E-02	-7.97E-02	-7.97E-02	-7.96E-02	-7.92E-02	
Specification MAX	-5.50E-02	-5.50E-02	-5.50E-02	-5.50E-02	-5.50E-02	-5.50E-02	-5.50E-02	-5.50E-02	-5.50E-02	-5.50E-02	-5.50E-02	
Status	PASS	PASS	PASS	PASS	PASS	PASS	PASS	PASS	PASS	PASS	PASS	

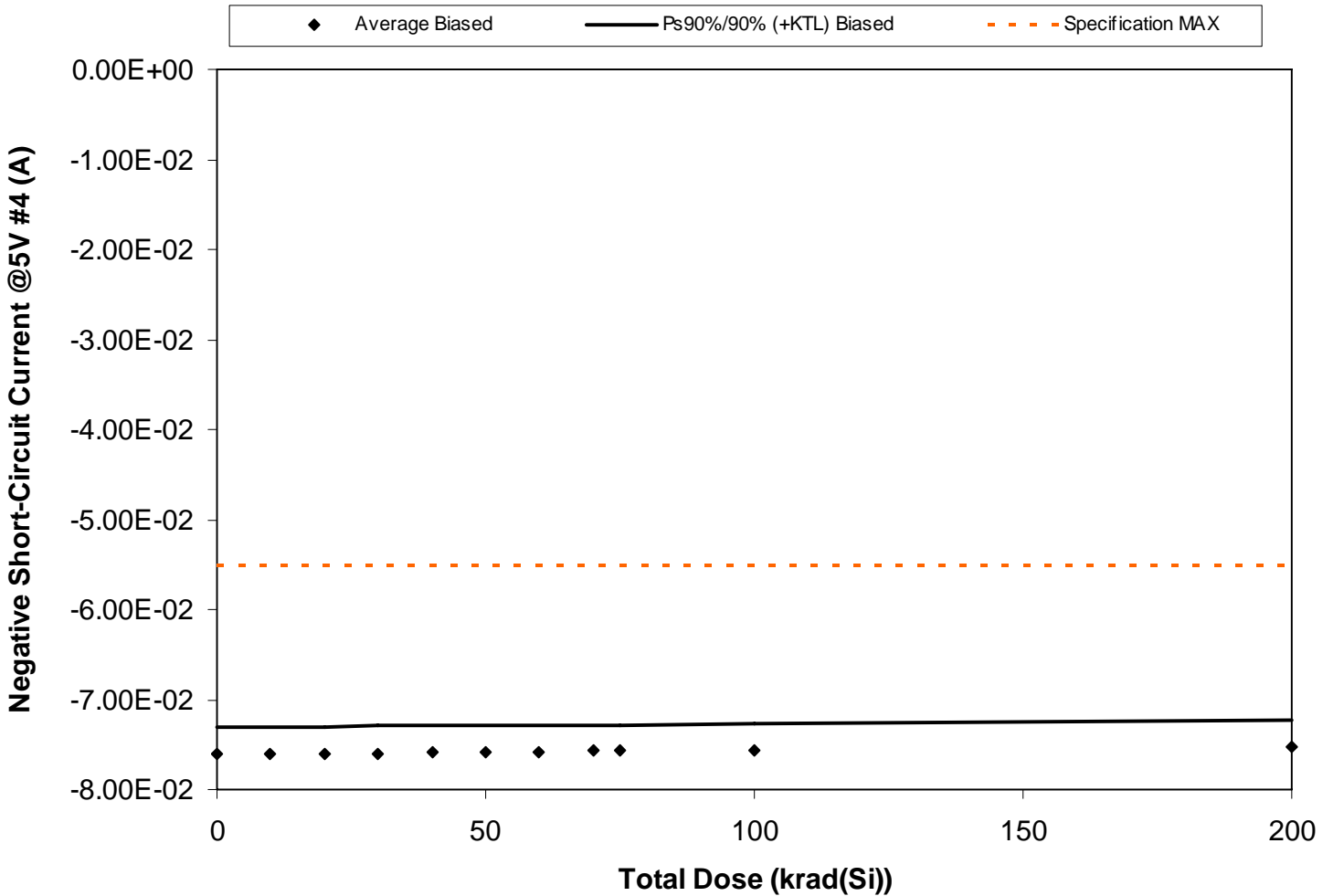

Figure 5.152. Plot of Negative Short-Circuit Current @5V #4 (A) versus total dose. The solid diamonds are the average of the measured data points for the samples irradiated under electrical bias and the black lines (solid and/or dashed) are the average of the data points after application of the KTL statistics on the samples irradiated under electrical bias. The red dotted line(s) are the pre- and/or post-irradiation minimum and/or maximum specification value as defined in the datasheet and/or test plan.



**RLAT Report
10-326 100808 R1.0**

**Radiation Assured Devices
5017 N. 30th Street
Colorado Springs, CO 80919
(719) 531-0800**

Table 5.152. Raw data for Negative Short-Circuit Current @5V #4 (A) versus total dose, including the statistical analysis, specification and the status of the testing (pass/fail).

Negative Short-Circuit Current @5V #4 (A)	Total Dose (krad(Si))											
	0	10	20	30	40	50	60	70	75	100	200	
Device												
1245	-7.50E-02	-7.50E-02	-7.50E-02	-7.49E-02	-7.48E-02	-7.48E-02	-7.47E-02	-7.46E-02	-7.46E-02	-7.45E-02	-7.41E-02	
1246	-7.60E-02	-7.62E-02	-7.61E-02	-7.60E-02	-7.59E-02	-7.60E-02	-7.58E-02	-7.58E-02	-7.58E-02	-7.57E-02	-7.53E-02	
1247	-7.70E-02	-7.72E-02	-7.71E-02	-7.70E-02	-7.69E-02	-7.69E-02	-7.69E-02	-7.68E-02	-7.68E-02	-7.67E-02	-7.64E-02	
1248	-7.83E-02	-7.84E-02	-7.84E-02	-7.82E-02	-7.81E-02	-7.81E-02	-7.80E-02	-7.79E-02	-7.79E-02	-7.77E-02	-7.73E-02	
1249	-7.85E-02	-7.85E-02	-7.85E-02	-7.84E-02	-7.83E-02	-7.83E-02	-7.81E-02	-7.81E-02	-7.80E-02	-7.79E-02	-7.75E-02	
1250	-7.47E-02	-7.48E-02	-7.47E-02	-7.46E-02	-7.46E-02	-7.46E-02	-7.45E-02	-7.44E-02	-7.44E-02	-7.43E-02	-7.40E-02	
1251	-7.47E-02	-7.48E-02	-7.47E-02	-7.46E-02	-7.45E-02	-7.45E-02	-7.45E-02	-7.44E-02	-7.44E-02	-7.43E-02	-7.39E-02	
1261	-7.53E-02	-7.56E-02	-7.55E-02	-7.53E-02	-7.53E-02	-7.53E-02	-7.52E-02	-7.52E-02	-7.51E-02	-7.50E-02	-7.46E-02	
1262	-7.59E-02	-7.61E-02	-7.60E-02	-7.59E-02	-7.58E-02	-7.58E-02	-7.57E-02	-7.57E-02	-7.57E-02	-7.56E-02	-7.52E-02	
1263	-7.47E-02	-7.48E-02	-7.47E-02	-7.47E-02	-7.46E-02	-7.46E-02	-7.45E-02	-7.44E-02	-7.44E-02	-7.43E-02	-7.39E-02	
1264	-7.62E-02	-7.64E-02	-7.64E-02	-7.64E-02	-7.63E-02	-7.63E-02	-7.63E-02	-7.63E-02	-7.63E-02	-7.63E-02	-7.63E-02	
1265	-7.67E-02	-7.69E-02	-7.69E-02	-7.69E-02	-7.69E-02	-7.68E-02	-7.68E-02	-7.68E-02	-7.68E-02	-7.68E-02	-7.68E-02	
Biased Statistics												
Average Biased	-7.60E-02	-7.61E-02	-7.61E-02	-7.60E-02	-7.59E-02	-7.59E-02	-7.58E-02	-7.57E-02	-7.57E-02	-7.56E-02	-7.52E-02	
Std Dev Biased	1.45E-03	1.45E-03	1.46E-03	1.45E-03	1.43E-03	1.44E-03	1.43E-03	1.43E-03	1.42E-03	1.41E-03	1.40E-03	
Ps90%/90% (+KTL) Biased	-7.30E-02	-7.31E-02	-7.31E-02	-7.30E-02	-7.29E-02	-7.29E-02	-7.29E-02	-7.28E-02	-7.28E-02	-7.27E-02	-7.23E-02	
Ps90%/90% (-KTL) Biased	-7.90E-02	-7.91E-02	-7.91E-02	-7.89E-02	-7.88E-02	-7.88E-02	-7.87E-02	-7.87E-02	-7.87E-02	-7.85E-02	-7.81E-02	
Specification MAX	-5.50E-02	-5.50E-02	-5.50E-02	-5.50E-02	-5.50E-02	-5.50E-02	-5.50E-02	-5.50E-02	-5.50E-02	-5.50E-02	-5.50E-02	
Status	PASS	PASS	PASS	PASS	PASS	PASS	PASS	PASS	PASS	PASS	PASS	

An ISO 9001:2008 and DSCC Certified Company



6.0. Summary / Conclusions

The total ionizing dose testing described in this final report was performed using the facilities at Radiation Assured Devices' Longmire Laboratories in Colorado Springs, CO. The high dose rate total ionizing dose (TID) source is a JLSA 84-21 irradiator modified to provide a panoramic exposure. The Co-60 rods are held in the base of the irradiator heavily shielded by lead, during the radiation exposures the rod is raised by an electronic timer/controller and the exposure is performed in air. The dose rate for this irradiator in this configuration ranges from $<1\text{rad}(\text{Si})/\text{s}$ to a maximum of approximately $120\text{rad}(\text{Si})/\text{s}$, determined by the distance from the source.

The parametric data was obtained as read and record and all the raw data plus an attributes summary are contained in a separate Excel file. The attributes data contains the average, standard deviation and the average with the KTL values applied. The KTL value used in this work is 2.065 per MIL-HDBK-814 using one sided tolerance limits of 90/90 and a 10-piece sample size. The 90/90 KTL values were selected to match the statistical levels specified in the MIL-PRF-38535 sampling plan for the qualification of a radiation hardness assured (RHA) component. Note that the following criteria must be met for a device to pass the RLAT: following the radiation exposure each of the 10 pieces irradiated under electrical bias shall pass the specification value. If any of the 10 pieces irradiated under electrical bias exceed the datasheet specifications, then the lot could be logged as a failure.

Based on this criterion the RH1814MW QUAD OP AMP (from the lot date code identified on the first page of this test report) PASSED the RLAT to the maximum tested dose level of $200\text{krad}(\text{Si})$ with all parameters remaining within their datasheet specifications. The data shown in this report uses much finer dose increments at the low dose levels to better understand the low total dose performance. In previous tests (with larger dose increments) we have observed degradation of selected VOS, CMRR and PSRR parameters with the units improving with total dose, passing at the $100\text{krad}(\text{Si})$ and $200\text{krad}(\text{Si})$ dose levels. It appears that using relatively large dose increments can cause a low total dose "failure" possible due to a slightly different radiation response of matching of OpAmp input transistors. The LT1814 datasheet p.12 "Circuit Operation" discussion describes complementary NPN and PNP emitter followers buffering input transistors. Uneven gamma-induced degradation of the various input transistors could produce large voltage offsets, possibly recovering after significant charge saturation in the oxides. Figures 5.1 through 5.152 show plots of all the measured parameters versus total ionizing dose while Tables 5.1 – 5.152 show the corresponding raw data for each of these parameters.



Appendix A: Photograph of device-under-test to show part markings





Appendix B: TID Bias Connections

(Extracted from LINEAR TECHNOLOGY CORPORATION RH1814M Datasheet)

Biased Samples:

Pin	Function	Connection / Bias
1	OUT A	To Pin 2 via 10k Ω
2	-IN A	To Pin 1 via 10k Ω
3	+IN A	To 2.5V via 10k Ω Resistor
4	V+	To +5V using 0.1 μ F Decoupling to GND
5	+IN B	To 2.5V via 10k Ω Resistor
6	-IN B	To Pin 7 via 10k Ω
7	OUT B	To Pin 6 via 10k Ω
8	OUT C	To Pin 9 via 10k Ω
9	-IN C	To Pin 8 via 10k Ω
10	+IN C	To 2.5V via 10k Ω Resistor
11	V-	To -5V using 0.1 μ F Decoupling to GND
12	+IN D	To 2.5V via 10k Ω Resistor
13	-IN D	To Pin 14 via 10k Ω
14	OUT D	To Pin 13 via 10k Ω

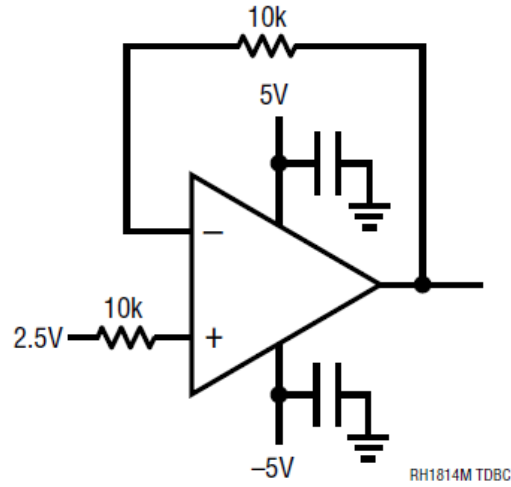

Figure B.1. Irradiation bias drawing for the units to be irradiated under electrical bias. This figure was extracted from LINEAR TECHNOLOGY CORPORATION RH1814M Datasheet.

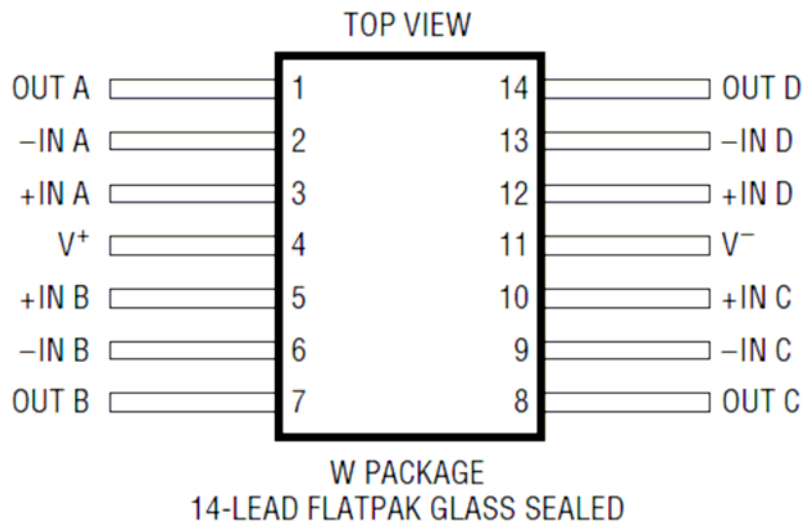

Figure B.2. W package drawing (for reference only). This figure was extracted from LINEAR TECHNOLOGY CORPORATION RH1814M Datasheet.



Appendix C: Electrical Test Parameters and Conditions

All electrical tests for this device are performed on one of Radiation Assured Device's LTS2020 Test Systems. The LTS2020 Test System is a programmable parametric tester that provides parameter measurements for a variety of digital, analog and mixed signal products including voltage regulators, voltage comparators, D to A and A to D converters. The LTS2020 Test System achieves accuracy and sensitivity through the use of software self-calibration and an internal relay matrix with separate family boards and custom personality adapter boards. The tester uses this relay matrix to connect the required test circuits, select the appropriate voltage / current sources and establish the needed measurement loops for all the tests performed. The tests will be conducted using the LTS-2101 Linear Family Board, LTS-0600 Socket Assembly and the RH1814W BGSS-080826 DUT board. The measured parameters and test conditions are shown in Tables C.1 and C.2.

A listing of the measurement precision/resolution for each parameter is shown in Tables C.3 and C.4. The precision/resolution values were obtained either from test data or from the DAC resolution of the LTS-2020. To generate the precision/resolution shown in Table C.2, one of the units-under-test was tested repetitively (a total of 10-times with re-insertion between tests) to obtain the average test value and standard deviation. Using this test data MIL-HDBK-814 90/90 KTL statistics were applied to the measured standard deviation to generate the final measurement range. This value encompasses the precision/resolution of all aspects of the test system, including the LTS2020 mainframe, family board, socket assembly and DUT board as well as insertion error. In some cases, the measurement resolution is limited by the internal DACs, which results in a measured standard deviation of zero. In these instances the precision/resolution will be reported back as the LSB of the DAC.

Note that the testing and statistics used in this document are based on an "analysis of variables" technique, which relies on small sample sizes to qualify much larger lot sizes (see MIL-HDBK-814, p. 91 for a discussion of statistical treatments). Not all measured parameters are well suited to this approach due to inherent large variations. One such parameter is pre-irradiation Large Signal Voltage Gain, where the device exhibits extreme sensitivity to input conditions, resulting in a very large standard deviation. If necessary, larger samples sizes could be used to qualify these parameters using an "attributes" approach.



Table C.1. Measured parameters and test conditions for $V_S=\pm 5V$.

TEST DESCRIPTION	TEST CONDITIONS
Positive Supply Current	$V_S=\pm 5V$
Negative Supply Current	$V_S=\pm 5V$
Input Offset Voltage (Op Amp 1-4)	$V_S=\pm 5V$
Input Offset Current (Op Amp 1-4)	$V_S=\pm 5V$
+ Input Bias Current (Op Amp 1-4)	$V_S=\pm 5V$
- Input Bias Current (Op Amp 1-4)	$V_S=\pm 5V$
CMRR (Op Amp 1-4)	$V_S=\pm 5V, V_{CM}=\pm 3.5V$
PSRR (Op Amp 1-4)	$V_S=\pm 2V$ to $\pm 5.5V$
Large Signal Voltage Gain $R_L=500$ (Op Amp 1-4)	$R_L=500\Omega, V_O=\pm 3V$
Large Signal Voltage Gain $R_L=100$ (Op Amp 1-4)	$R_L=100\Omega, V_O=\pm 3V$
Channel Separation (Op Amp 1-4, all permutations)	$R_L=100\Omega, V_O=\pm 3V$
Output Voltage Swing High $R_L=500$ (Op Amp 1-4)	$R_L=500\Omega, V_{OD}=30mV, V_S=\pm 5V$
Output Voltage Swing High $R_L=100$ (Op Amp 1-4)	$R_L=100\Omega, V_{OD}=30mV, V_S=\pm 5V$
Output Voltage Swing Low $R_L=500$ (Op Amp 1-4)	$R_L=500\Omega, V_{OD}=30mV, V_S=\pm 5V$
Output Voltage Swing Low $R_L=100$ (Op Amp 1-4)	$R_L=100\Omega, V_{OD}=30mV, V_S=\pm 5V$
Maximum Output Source Current (Op Amp 1-4)	$V_O=3V, V_{OD}=30mV, V_S=\pm 5V$
Maximum Output Sink Current (Op Amp 1-4)	$V_O=-3V, V_{OD}=30mV, V_S=\pm 5V$
Positive Short-Circuit Current (Op Amp 1-4)	$V_{OD}=1V, V_S=\pm 5V$
Negative Short-Circuit Current (Op Amp 1-4)	$V_{OD}=1V, V_S=\pm 5V$



Table C.2. Measured parameters and test conditions for $V_S=5V$.

TEST DESCRIPTION	TEST CONDITIONS
Positive Supply Current	$V_S=5V$
Negative Supply Current	$V_S=5V$
Input Offset Voltage (Op Amp 1-4)	$V_S=5V$
Input Offset Current (Op Amp 1-4)	$V_S=5V$
+ Input Bias Current (Op Amp 1-4)	$V_S=5V$
- Input Bias Current (Op Amp 1-4)	$V_S=5V$
CMRR (Op Amp 1-4)	$V_S=5V, V_{CM}=1.5V$ to $3.5V$
Large Signal Voltage Gain $R_L=500$ (Op Amp 1-4)	$R_L=500\Omega, V_O=1.5$ to $3.5V$
Large Signal Voltage Gain $R_L=100$ (Op Amp 1-4)	$R_L=100\Omega, V_O=1.5$ to $3.5V$
Channel Separation (Op Amp 1-4, all permutations)	$R_L=100\Omega, V_O=1.5$ to $3.5V$
Output Voltage Swing High $R_L=500$ (Op Amp 1-4)	$R_L=500\Omega, V_{OD}=30mV, V_S=5V$
Output Voltage Swing High $R_L=100$ (Op Amp 1-4)	$R_L=100\Omega, V_{OD}=30mV, V_S=5V$
Output Voltage Swing Low $R_L=500$ (Op Amp 1-4)	$R_L=500\Omega, V_{OD}=30mV, V_S=5V$
Output Voltage Swing Low $R_L=100$ (Op Amp 1-4)	$R_L=100\Omega, V_{OD}=30mV, V_S=5V$
Maximum Output Source Current (Op Amp 1-4)	$V_O=3.5V, V_{OD}=30mV, V_S=5V$
Maximum Output Sink Current (Op Amp 1-4)	$V_O=1.5V, V_{OD}=30mV, V_S=5V$
Positive Short-Circuit Current (Op Amp 1-4)	$V_{OD}=1V, V_S=5V$
Negative Short-Circuit Current (Op Amp 1-4)	$V_{OD}=1V, V_S=5V$



Table C.3. Measured parameters, pre-irradiation specifications, and measurement resolutions for $V_S = \pm 5V$.

Measured Parameter	Pre-Irradiation Specification	Measurement Resolution/Precision
Positive Supply Current	14.4mA	$\pm 2.50E-04A$
Negative Supply Current	-14.4mA	$\pm 2.46E-04A$
Input Offset Voltage (Op Amp 1-4)	$\pm 1.5mV$	$\pm 9.56E-06V$
Input Offset Current (Op Amp 1-4)	$\pm 400nA$	$\pm 1.07E-08A$
+ Input Bias Current (Op Amp 1-4)	$\pm 4\mu A$	$\pm 9.97E-09A$
- Input Bias Current (Op Amp 1-4)	$\pm 4\mu A$	$\pm 1.07E-08A$
CMRR (Op Amp 1-4)	75dB	$\pm 1.27E-01dB$
PSRR (Op Amp 1-4)	78dB	$\pm 2.77E-01dB$
Large Signal Voltage Gain $RL=500$ (Op Amp 1-4)	1.5V/mV	$\pm 6.53E-02V/mV$
Large Signal Voltage Gain $RL=100$ (Op Amp 1-4)	1V/mV	$\pm 9.97E-02V/mV$
Channel Separation (Op Amp 1-4, all permutations)	82dB	$\pm 3.19E+01dB$
Output Voltage Swing High $RL=500$ (Op Amp 1-4)	3.8V	$\pm 4.29E-03V$
Output Voltage Swing High $RL=100$ (Op Amp 1-4)	3.35V	$\pm 2.76E-03V$
Output Voltage Swing Low $RL=500$ (Op Amp 1-4)	-3.8V	$\pm 3.34E-03V$
Output Voltage Swing Low $RL=100$ (Op Amp 1-4)	-3.35V	$\pm 3.34E-03V$
Maximum Output Source Current (Op Amp 1-4)	40mA	$\pm 2.49E-04A$
Maximum Output Sink Current (Op Amp 1-4)	-40mA	$\pm 1.46E-04A$
Positive Short-Circuit Current (Op Amp 1-4)	75mA	$\pm 4.04E-04V$
Negative Short-Circuit Current (Op Amp 1-4)	-75mA	$\pm 4.14E-04A$



Table C.4. Measured parameters, pre-irradiation specifications, and measurement resolutions for $V_S=5V$.

Measured Parameter	Pre-Irradiation Specification	Measurement Resolution/Precision
Positive Supply Current	16mA	$\pm 1.52E-04A$
Negative Supply Current	-16mA	$\pm 1.66E-04A$
Input Offset Voltage (Op Amp 1-4)	$\pm 2mV$	$\pm 8.44E-06V$
Input Offset Current (Op Amp 1-4)	$\pm 400nA$	$\pm 1.07E-08A$
+ Input Bias Current (Op Amp 1-4)	$\pm 4\mu A$	$\pm 8.79E-09A$
- Input Bias Current (Op Amp 1-4)	$\pm 4\mu A$	$\pm 9.97E-09A$
CMRR (Op Amp 1-4)	73dB	$\pm 2.84E-01dB$
Large Signal Voltage Gain $RL=500$ (Op Amp 1-4)	1.0V/mV	$\pm 2.00E-02V/mV$
Large Signal Voltage Gain $RL=100$ (Op Amp 1-4)	0.7V/mV	$\pm 8.71E-02V/mV$
Channel Separation (Op Amp 1-4, all permutations)	81dB	$\pm 2.74E+01dB$
Output Voltage Swing High $RL=500$ (Op Amp 1-4)	3.9V	$\pm 3.38E-03V$
Output Voltage Swing High $RL=100$ (Op Amp 1-4)	3.7V	$\pm 2.47E-03V$
Output Voltage Swing Low $RL=500$ (Op Amp 1-4)	1.1V	$\pm 2.19E-03V$
Output Voltage Swing Low $RL=100$ (Op Amp 1-4)	1.3V	$\pm 2.01E-03V$
Maximum Output Source Current (Op Amp 1-4)	25mA	$\pm 1.21E-04A$
Maximum Output Sink Current (Op Amp 1-4)	-25mA	$\pm 1.27E-04A$
Positive Short-Circuit Current (Op Amp 1-4)	55mA	$\pm 2.21E-04A$
Negative Short-Circuit Current (Op Amp 1-4)	-55mA	$\pm 1.64E-04A$



Appendix D: List of Figures Used in Section 5 (RLAT Test Results)

- 5.1 Positive Supply Current @ $\pm 5V$ (A)
- 5.2 Negative Supply Current @ $\pm 5V$ (A)
- 5.3 Input Offset Voltage @ $\pm 5V$ #1 (V)
- 5.4 Input Offset Voltage @ $\pm 5V$ #2 (V)
- 5.5 Input Offset Voltage @ $\pm 5V$ #3 (V)
- 5.6 Input Offset Voltage @ $\pm 5V$ #4 (V)
- 5.7 Input Offset Current @ $\pm 5V$ #1 (A)
- 5.8 Input Offset Current @ $\pm 5V$ #2 (A)
- 5.9 Input Offset Current @ $\pm 5V$ #3 (A)
- 5.10 Input Offset Current @ $\pm 5V$ #4 (A)
- 5.11 Positive Input Bias Current @ $\pm 5V$ #1 (A)
- 5.12 Positive Input Bias Current @ $\pm 5V$ #2 (A)
- 5.13 Positive Input Bias Current @ $\pm 5V$ #3 (A)
- 5.14 Positive Input Bias Current @ $\pm 5V$ #4 (A)
- 5.15 Negative Input Bias Current @ $\pm 5V$ #1 (A)
- 5.16 Negative Input Bias Current @ $\pm 5V$ #2 (A)
- 5.17 Negative Input Bias Current @ $\pm 5V$ #3 (A)
- 5.18 Negative Input Bias Current @ $\pm 5V$ #4 (A)
- 5.19 Common Mode Rejection Ratio @ $\pm 5V$ #1 (dB)
- 5.20 Common Mode Rejection Ratio @ $\pm 5V$ #2 (dB)
- 5.21 Common Mode Rejection Ratio @ $\pm 5V$ #3 (dB)
- 5.22 Common Mode Rejection Ratio @ $\pm 5V$ #4 (dB)
- 5.23 Power Supply Rejection Ratio #1 (dB)
- 5.24 Power Supply Rejection Ratio #2 (dB)
- 5.25 Power Supply Rejection Ratio #3 (dB)
- 5.26 Power Supply Rejection Ratio #4 (dB)
- 5.27 Large Signal Voltage Gain @ $\pm 5V$ RL=500 #1 (V/mV)
- 5.28 Large Signal Voltage Gain @ $\pm 5V$ RL=500 #2 (V/mV)
- 5.29 Large Signal Voltage Gain @ $\pm 5V$ RL=500 #3 (V/mV)
- 5.30 Large Signal Voltage Gain @ $\pm 5V$ RL=500 #4 (V/mV)
- 5.31 Large Signal Voltage Gain @ $\pm 5V$ RL=100 #1 (V/mV)
- 5.32 Large Signal Voltage Gain @ $\pm 5V$ RL=100 #2 (V/mV)
- 5.33 Large Signal Voltage Gain @ $\pm 5V$ RL=100 #3 (V/mV)
- 5.34 Large Signal Voltage Gain @ $\pm 5V$ RL=100 #4 (V/mV)
- 5.35 Channel Separation @ $\pm 5V$ 1:2 (dB)
- 5.36 Channel Separation @ $\pm 5V$ 1:3 (dB)
- 5.37 Channel Separation @ $\pm 5V$ 1:4 (dB)
- 5.38 Channel Separation @ $\pm 5V$ 2:1 (dB)
- 5.39 Channel Separation @ $\pm 5V$ 2:3 (dB)



- 5.40 Channel Separation @+/-5V 2:4 (dB)
- 5.41 Channel Separation @+/-5V 3:1 (dB)
- 5.42 Channel Separation @+/-5V 3:2 (dB)
- 5.43 Channel Separation @+/-5V 3:4 (dB)
- 5.44 Channel Separation @+/-5V 4:1 (dB)
- 5.45 Channel Separation @+/-5V 4:2 (dB)
- 5.46 Channel Separation @+/-5V 4:3 (dB)
- 5.47 Output Voltage Swing High @+/-5V RL=500 #1 (V)
- 5.48 Output Voltage Swing High @+/-5V RL=500 #2 (V)
- 5.49 Output Voltage Swing High @+/-5V RL=500 #3 (V)
- 5.50 Output Voltage Swing High @+/-5V RL=500 #4 (V)
- 5.51 Output Voltage Swing High @+/-5V RL=100 #1 (V)
- 5.52 Output Voltage Swing High @+/-5V RL=100 #2 (V)
- 5.53 Output Voltage Swing High @+/-5V RL=100 #3 (V)
- 5.54 Output Voltage Swing High @+/-5V RL=100 #4 (V)
- 5.55 Output Voltage Swing Low @+/-5V RL=500 #1 (V)
- 5.56 Output Voltage Swing Low @+/-5V RL=500 #2 (V)
- 5.57 Output Voltage Swing Low @+/-5V RL=500 #3 (V)
- 5.58 Output Voltage Swing Low @+/-5V RL=500 #4 (V)
- 5.59 Output Voltage Swing Low @+/-5V RL=100 #1 (V)
- 5.60 Output Voltage Swing Low @+/-5V RL=100 #2 (V)
- 5.61 Output Voltage Swing Low @+/-5V RL=100 #3 (V)
- 5.62 Output Voltage Swing Low @+/-5V RL=100 #4 (V)
- 5.63 Maximum Output Source Current @+/-5V #1 (A)
- 5.64 Maximum Output Source Current @+/-5V #2 (A)
- 5.65 Maximum Output Source Current @+/-5V #3 (A)
- 5.66 Maximum Output Source Current @+/-5V #4 (A)
- 5.67 Maximum Output Sink Current @+/-5V #1 (A)
- 5.68 Maximum Output Sink Current @+/-5V #2 (A)
- 5.69 Maximum Output Sink Current @+/-5V #3 (A)
- 5.70 Maximum Output Sink Current @+/-5V #4 (A)
- 5.71 Positive Short-Circuit Current @+/-5V #1 (A)
- 5.72 Positive Short-Circuit Current @+/-5V #2 (A)
- 5.73 Positive Short-Circuit Current @+/-5V #3 (A)
- 5.74 Positive Short-Circuit Current @+/-5V #4 (A)
- 5.75 Negative Short-Circuit Current @+/-5V #1 (A)
- 5.76 Negative Short-Circuit Current @+/-5V #2 (A)
- 5.77 Negative Short-Circuit Current @+/-5V #3 (A)
- 5.78 Negative Short-Circuit Current @+/-5V #4 (A)
- 5.79 Positive Supply Current @5V (A)
- 5.80 Negative Supply Current @5V (A)



- 5.81 Input Offset Voltage @5V #1 (V)
- 5.82 Input Offset Voltage @5V #2 (V)
- 5.83 Input Offset Voltage @5V #3 (V)
- 5.84 Input Offset Voltage @5V #4 (V)
- 5.85 Input Offset Current @5V #1 (A)
- 5.86 Input Offset Current @5V #2 (A)
- 5.87 Input Offset Current @5V #3 (A)
- 5.88 Input Offset Current @5V #4 (A)
- 5.89 Positive Input Bias Current @5V #1 (A)
- 5.90 Positive Input Bias Current @5V #2 (A)
- 5.91 Positive Input Bias Current @5V #3 (A)
- 5.92 Positive Input Bias Current @5V #4 (A)
- 5.93 Negative Input Bias Current @5V #1 (A)
- 5.94 Negative Input Bias Current @5V #2 (A)
- 5.95 Negative Input Bias Current @5V #3 (A)
- 5.96 Negative Input Bias Current @5V #4 (A)
- 5.97 Common Mode Rejection Ratio @5V #1 (dB)
- 5.98 Common Mode Rejection Ratio @5V #2 (dB)
- 5.99 Common Mode Rejection Ratio @5V #3 (dB)
- 5.100 Common Mode Rejection Ratio @5V #4 (dB)
- 5.101 Large Signal Voltage Gain @5V RL=500 #1 (V/mV)
- 5.102 Large Signal Voltage Gain @5V RL=500 #2 (V/mV)
- 5.103 Large Signal Voltage Gain @5V RL=500 #3 (V/mV)
- 5.104 Large Signal Voltage Gain @5V RL=500 #4 (V/mV)
- 5.105 Large Signal Voltage Gain @5V RL=100 #1 (V/mV)
- 5.106 Large Signal Voltage Gain @5V RL=100 #2 (V/mV)
- 5.107 Large Signal Voltage Gain @5V RL=100 #3 (V/mV)
- 5.108 Large Signal Voltage Gain @5V RL=100 #4 (V/mV)
- 5.109 Channel Separation @5V 1:2 (dB)
- 5.110 Channel Separation @5V 1:3 (dB)
- 5.111 Channel Separation @5V 1:4 (dB)
- 5.112 Channel Separation @5V 2:1 (dB)
- 5.113 Channel Separation @5V 2:3 (dB)
- 5.114 Channel Separation @5V 2:4 (dB)
- 5.115 Channel Separation @5V 3:1 (dB)
- 5.116 Channel Separation @5V 3:2 (dB)
- 5.117 Channel Separation @5V 3:4 (dB)
- 5.118 Channel Separation @5V 4:1 (dB)
- 5.119 Channel Separation @5V 4:2 (dB)
- 5.120 Channel Separation @5V 4:3 (dB)
- 5.121 Output Voltage Swing High @5V RL=500 #1 (V)



**RLAT Report
10-326 100808 R1.0**

**Radiation Assured Devices
5017 N. 30th Street
Colorado Springs, CO 80919
(719) 531-0800**

- 5.122 Output Voltage Swing High @5V RL=500 #2 (V)
- 5.123 Output Voltage Swing High @5V RL=500 #3 (V)
- 5.124 Output Voltage Swing High @5V RL=500 #4 (V)
- 5.125 Output Voltage Swing High @5V RL=100 #1 (V)
- 5.126 Output Voltage Swing High @5V RL=100 #2 (V)
- 5.127 Output Voltage Swing High @5V RL=100 #3 (V)
- 5.128 Output Voltage Swing High @5V RL=100 #4 (V)
- 5.129 Output Voltage Swing Low @5V RL=500 #1 (V)
- 5.130 Output Voltage Swing Low @5V RL=500 #2 (V)
- 5.131 Output Voltage Swing Low @5V RL=500 #3 (V)
- 5.132 Output Voltage Swing Low @5V RL=500 #4 (V)
- 5.133 Output Voltage Swing Low @5V RL=100 #1 (V)
- 5.134 Output Voltage Swing Low @5V RL=100 #2 (V)
- 5.135 Output Voltage Swing Low @5V RL=100 #3 (V)
- 5.136 Output Voltage Swing Low @5V RL=100 #4 (V)
- 5.137 Maximum Output Source Current @5V #1 (A)
- 5.138 Maximum Output Source Current @5V #2 (A)
- 5.139 Maximum Output Source Current @5V #3 (A)
- 5.140 Maximum Output Source Current @5V #4 (A)
- 5.141 Maximum Output Sink Current @5V #1 (A)
- 5.142 Maximum Output Sink Current @5V #2 (A)
- 5.143 Maximum Output Sink Current @5V #3 (A)
- 5.144 Maximum Output Sink Current @5V #4 (A)
- 5.145 Positive Short-Circuit Current @5V #1 (A)
- 5.146 Positive Short-Circuit Current @5V #2 (A)
- 5.147 Positive Short-Circuit Current @5V #3 (A)
- 5.148 Positive Short-Circuit Current @5V #4 (A)
- 5.149 Negative Short-Circuit Current @5V #1 (A)
- 5.150 Negative Short-Circuit Current @5V #2 (A)
- 5.151 Negative Short-Circuit Current @5V #3 (A)
- 5.152 Negative Short-Circuit Current @5V #4 (A)