

Total-Ionizing Dose Test Report for the RT6804HG-1 Radiation Tolerant Multicell Battery Monitor *February 2022*



Radiation Test Report	
Product:	RT6804HG-1
Gamma:	HDR: 10kRad(Si), 15kRad(Si)
Gamma Source:	Co60/TM1019
Dose Rate:	High Dose Rate: 50 – 300 Rad(Si)/sec Low Dose Rate: 10 mRad(Si)/sec
Facilities:	Defense Micro-Electronics Activity (DMEA)
Tested:	12/03/2019 – HDR 12/09/2021 – LDR
Revision:	0

The RADTEST® DATA SERVICE is a compilation of radiation test results on Analog Devices' Space grade products. It is designed to assist customers in selecting the right product for applications where radiation is a consideration. Many products manufactured by Analog Devices, Inc. have been shown to be radiation tolerant to most tactical radiation environments. Analog Devices, Inc. does not make any claim to maintain or guarantee these levels of radiation tolerance without lot qualification test.

It is the responsibility of the Procuring Activity to screen products from Analog Devices, Inc. for compliance to Nuclear Hardness Critical Items (HCI) specifications.

Warning:

Analog Devices, Inc. does not recommend use of this data to qualify other product grades or process levels. Analog Devices, Inc. is not responsible and has no liability for any consequences, and all applicable Warranties are null and void if any Analog Devices product is modified in any way or used outside of normal environmental and operating conditions, including the parameters specified in the corresponding data sheet. Analog Devices, Inc. does not guarantee that wafer manufacturing is the same for all process levels.

I. Introduction

This is a comprehensive report summarizing the high dose rate (HDR) and low dose rate (LDR) total-ionizing dose (TID) radiation for the RT6804HG-1. The qualification tests were carried out per MIL-STD-883 TM1019 condition A at high dose rate, TM1019 condition D at low dose rate, and shipped back to Analog Device Inc. (ADI) on dry ice for electrical testing. Testing was performed on samples pulled from production lots.

II. Device Description

The RT6804HG-1 is a radiation tolerant multicell battery monitor. The RT6804HG-1 is assembled and tested following Analog Device Inc. radiation tolerant flow. This part is packaged in a 48-lead plastic SSOP. Table I displays the part and test information. Figure 1 shows the pin configuration. Refer to the online datasheet for any additional details. Figure 2 shows a photograph of a 48-lead plastic SSOP packaged test sample.

Table I

Test and part information.

Part Number:	RT6804HG-1
Manufacturer:	Analog Devices Inc.
Part Function:	Multicell Battery Monitor
Process Technology:	0.6 μ m BiCMOS
Package Type:	G 48 Lead Plastic SSOP
Sample Quantity:	5 biased for each dose step for HDR 5 biased and 5 unbiased used for all levels during LDR
Dose rate:	High dose rate: 50 – 300 Rad(Si)/sec Low dose rate: 10 mRad(Si)/sec
Test Equipment:	Teradyne ETS364 Automated Tester LTC6804 Family Board

RT6804-1

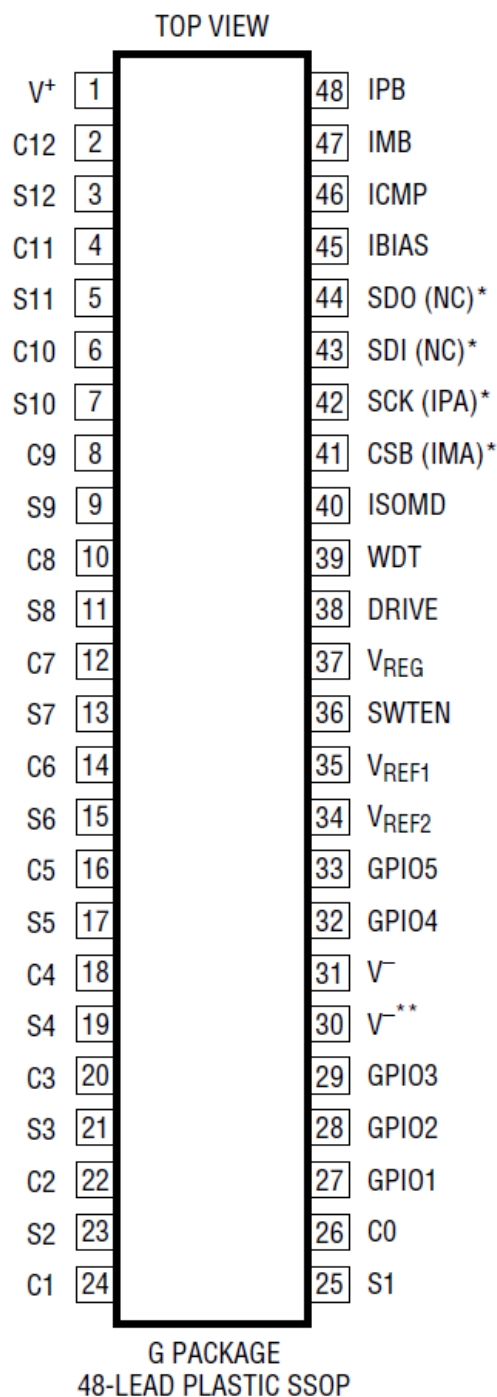

$T_{JMAX} = 150^{\circ}\text{C}$, $\theta_{JA} = 55^{\circ}\text{C/W}$

*THE FUNCTION OF THESE PINS DEPENDS ON THE CONNECTION OF ISOMD

ISOMD TIED TO V⁻: CSB, SCK, SDI, SDO

ISOMD TIED TO V_{REG}: IMA, IPA, NC, NC

**THIS PIN MUST BE CONNECTED TO V⁻

Figure 1. G Package 48 lead plastic SSOP pin configurations for the RT6804HG-1.



Figure 2. Photograph of a RT6804HG-1 G Package 48 Lead SSOP.

III. Test Method

A. Irradiation procedures

Radiation facilities: The irradiations were carried out at Defense Micro-Electronics Activity (DMEA) facility using JL Shephard ^{60}Co gamma ray sources. The device under test (DUT) were placed inside a cavity with standard Pb/Al shielding. The irradiation procedures and dosimetry requirements conform to MIL-STD-883-L TM1019.9. Dosimetry was performed using air ionization chamber.

Pre-Irradiation burn-in: The test samples were burned-in prior to irradiation at Analog Devices Inc.

Overtest: No overtest was included.

Post Irradiation Shipping: Parts shipped on dry ice to Analog Device Inc. for post irradiation testing.

Post-irradiation anneal: No annealing was performed.

Test temperature: Room temperature controlled to $24^{\circ}\text{C}\pm 4^{\circ}\text{C}$.

B. Test setup

Figure 3 shows the irradiation schematic circuit diagram for biased devices.

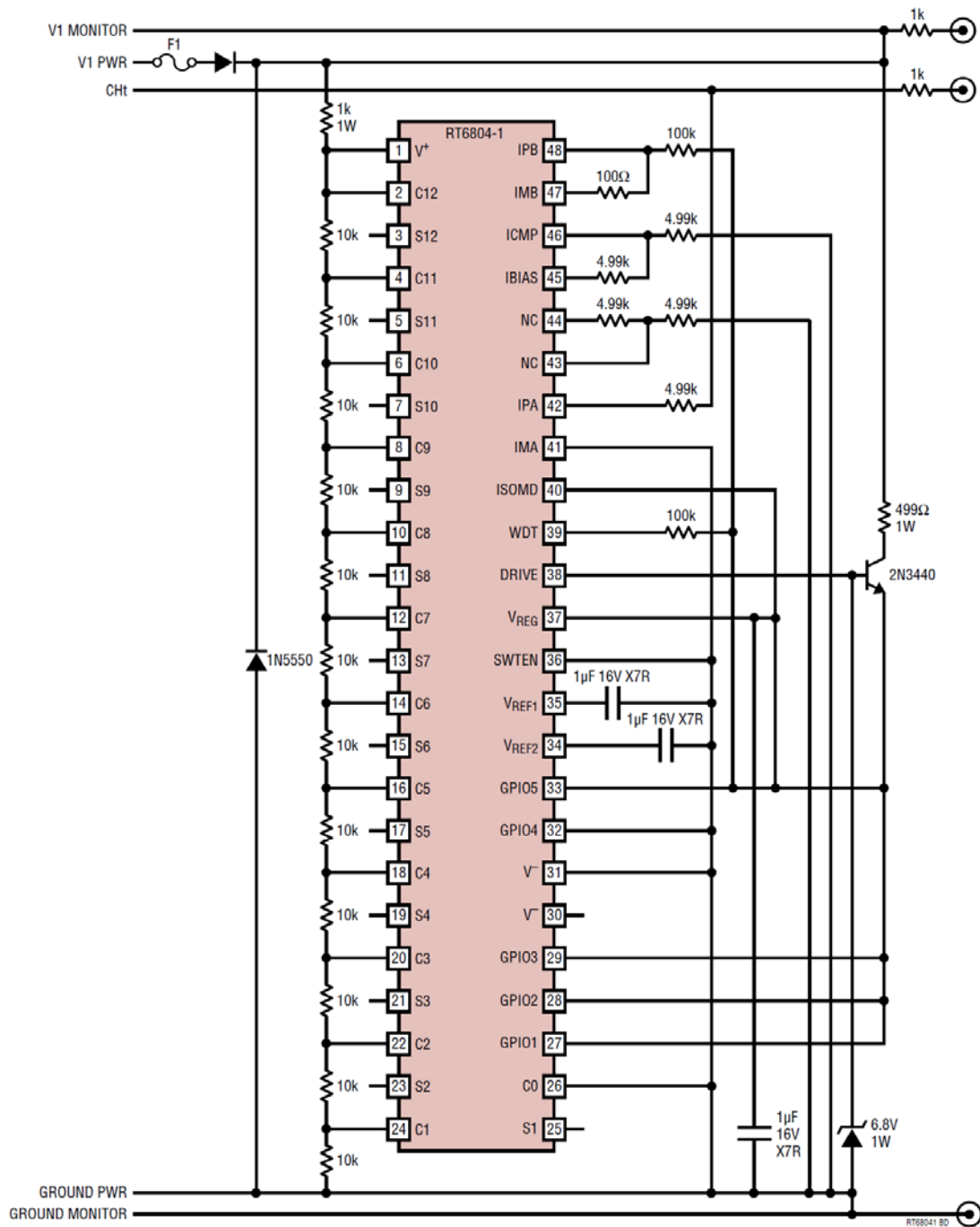

Figure 3. Bias configuration for the RT6804HG-1.

IV. Results

High dose rate and low dose rate irradiation passed post irradiation datasheet limits, at both 10kRad(Si) and 15kRad(Si). Figure A-1-1 to A-121-1, in Appendix A, shows all datasheet tested parameters versus high dose rate irradiation. Figure A-1-2 to A-121-2, in Appendix A, shows all datasheet tested parameters versus low dose rate irradiation. Table A-1-1 to A-121-1, in Appendix A, show the corresponding data for high dose rate and Table A-1-2 to A-121-2 show low dose rate data. The 3-sigma statistical analysis is included as information only.

V. References

1. MIL-STD-883-L, Test Method 1019.9, Ionizing Radiation (Total Dose) Test Procedure Sept. 16, 2019.
2. Analog Devices, Inc. (2021) "*RT6804HG-1 Radiation Tolerant Multicell Battery Monitor*" [Online]. Available: <https://www.analog.com/en/products/rt6804-1.html>, Accessed on: December 1st, 2021.

Appendix-A

Appendix-A Electrical Parameters vs Irradiation Graphs and Tables.

Figure A-1-1. Cell 1 TME, Input = 2V, Normal vs. HDR TID for the RT6804HG-1.

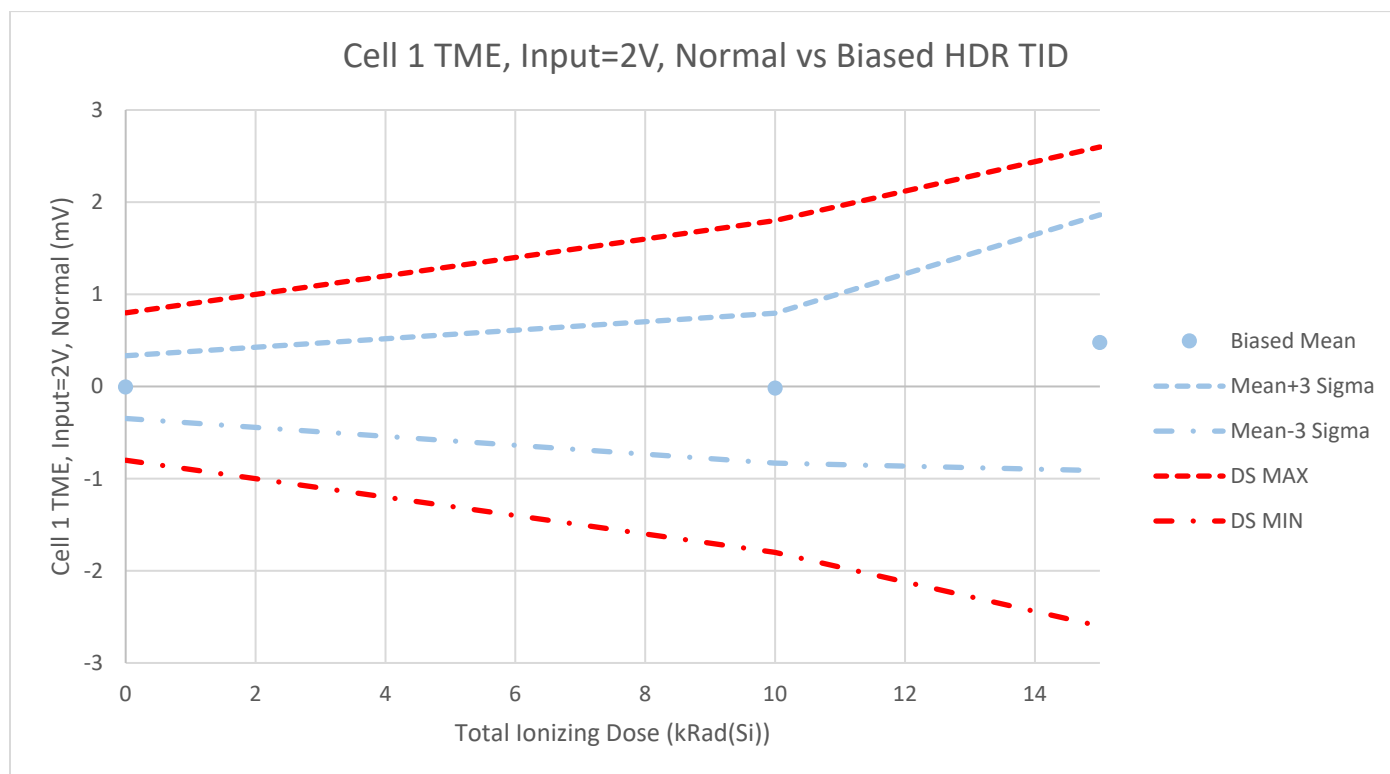

Table A-1-1. Cell 1 TME, Input = 2V, Normal vs. HDR TID for the RT6804HG-1.

HDR TID Biased				
Total Ionizing Dose (kRad(Si))	0	10	15	Units
Biased Mean	-0.0064	-0.0184	0.4759	mV
Std Dev	0.1133	0.2711	0.4627	
Biased Mean+3 σ	0.3334	0.7949	1.8639	
Biased Mean-3 σ	-0.3463	-0.8316	-0.9122	
DS MIN	-8.00E-01	-1.80E+00	-2.60E+00	mV
	PASS	PASS	PASS	
DS MAX	8.00E-01	1.80E+00	2.60E+00	mV
	PASS	PASS	PASS	

Figure A-1-2. Cell 1 TME, Input = 2V, Normal vs. LDR TID for the RT6804HG-1.

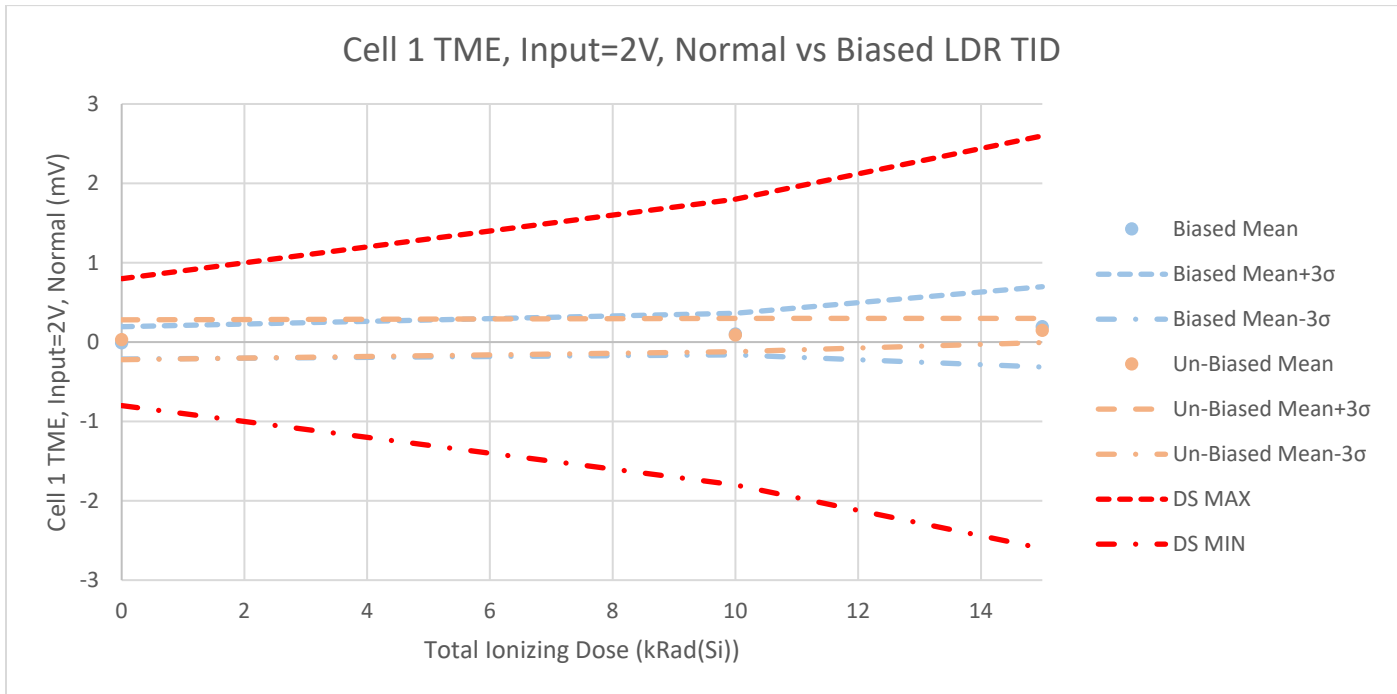

Table A-1-2. Cell 1 TME, Input = 2V, Normal vs. LDR TID for the RT6804HG-1.

Total Ionizing Dose (kRad(Si))	0	10	15	Units
LDR TID Biased				
Biased Mean	-0.0103	0.1016	0.1930	mV
Std Dev	0.0681	0.0872	0.1687	
Biased Mean+3σ	0.1940	0.3632	0.6992	
Biased Mean-3σ	-0.2146	-0.1601	-0.3132	
LDR TID Un-Biased				
Un-Biased Mean	0.0295	0.0885	0.1475	mV
Std Dev	0.0837	0.0700	0.0506	
Un-Biased Mean+3σ	0.2804	0.2985	0.2993	
Un-Biased Mean-3σ	-0.2215	-0.1215	-0.0042	
DS Limits				
DS MIN	-8.00E-01	-1.80E+00	-2.60E+00	mV
	PASS	PASS	PASS	
DS MAX	8.00E-01	1.80E+00	2.60E+00	mV
	PASS	PASS	PASS	

Figure A-2-1. Cell 2 TME, Input = 2V, Normal vs. HDR TID for the RT6804HG-1.

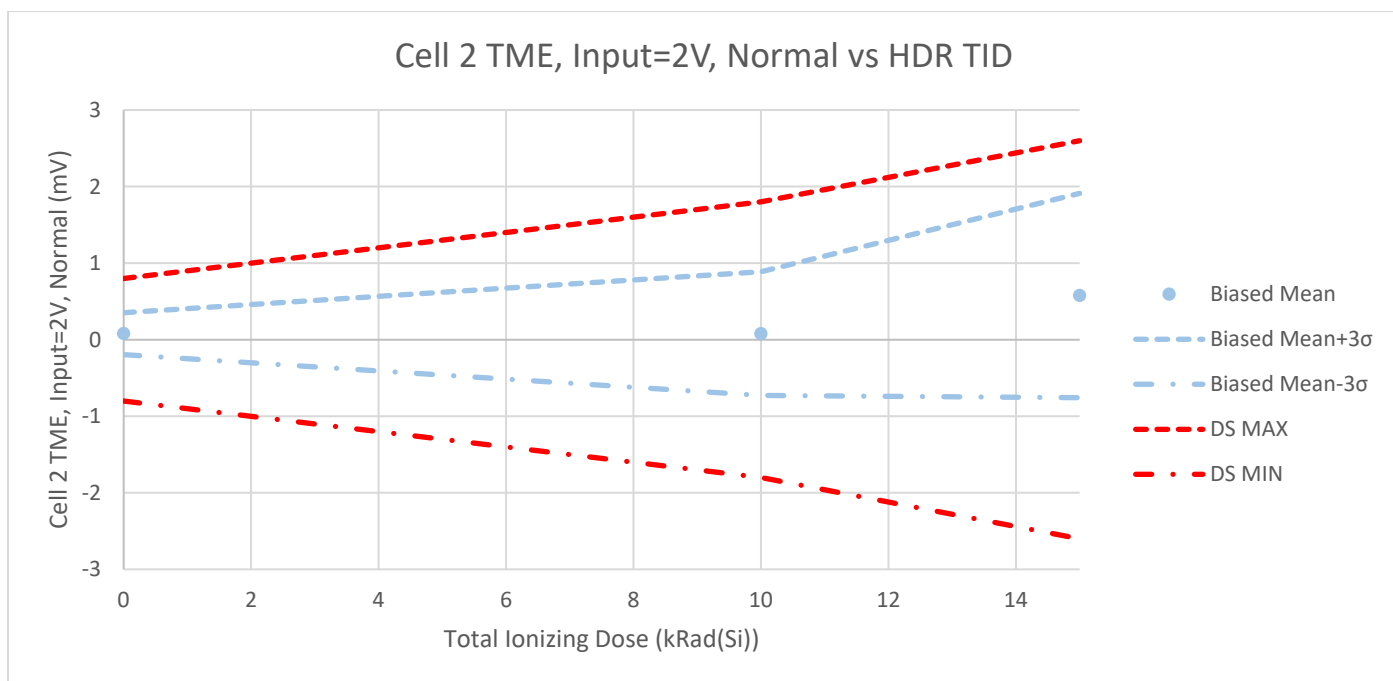

Table A-2-1. Cell 2 TME, Input = 2V, Normal vs. HDR TID for the RT6804HG-1.

HDR TID Biased				
Total Ionizing Dose (kRad(Si))	0	10	15	Units
Biased Mean	0.0802	0.0789	0.5776	mV
Std Dev	0.0912	0.2693	0.4447	
Biased Mean+3σ	0.3539	0.8866	1.9117	
Biased Mean-3σ	-0.1936	-0.7289	-0.7566	
DS MIN	-8.00E-01	-1.80E+00	-2.60E+00	mV
	PASS	PASS	PASS	
DS MAX	8.00E-01	1.80E+00	2.60E+00	mV
	PASS	PASS	PASS	

Figure A-2-2. Cell 2 TME, Input = 2V, Normal vs. LDR TID for the RT6804HG-1.

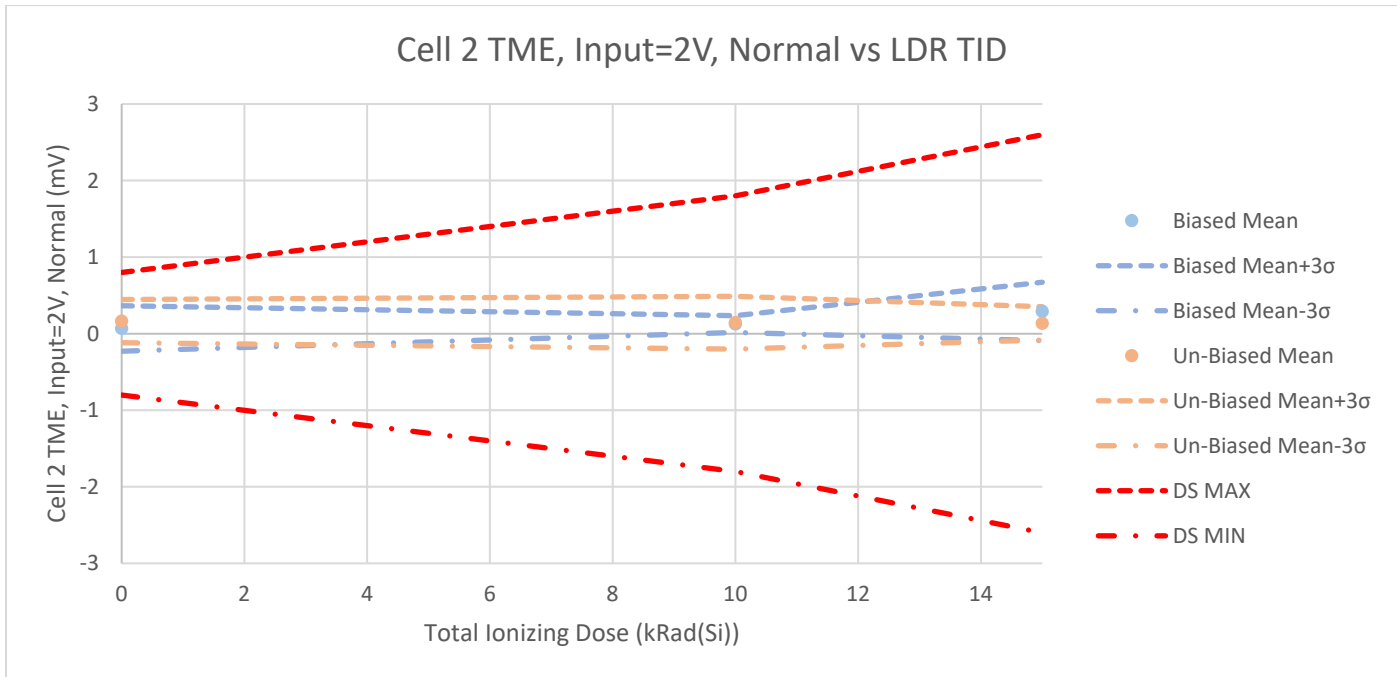

Table A-2-2. Cell 2 TME, Input = 2V, Normal vs. LDR TID for the RT6804HG-1.

Total Ionizing Dose (kRad(Si))	0	10	15	Units
LDR TID Biased				
Biased Mean	0.0687	0.1264	0.2918	mV
Std Dev	0.0987	0.0369	0.1273	
Biased Mean+3σ	0.3648	0.2370	0.6738	
Biased Mean-3σ	-0.2275	0.0159	-0.0901	
LDR TID Un-Biased				
Un-Biased Mean	0.1634	0.1442	0.1355	mV
Std Dev	0.0940	0.1150	0.0727	
Un-Biased Mean+3σ	0.4455	0.4892	0.3537	
Un-Biased Mean-3σ	-0.1188	-0.2008	-0.0826	
DS MIN	-8.00E-01	-1.80E+00	-2.60E+00	mV
	PASS	PASS	PASS	
DS MAX	8.00E-01	1.80E+00	2.60E+00	mV
	PASS	PASS	PASS	

Figure A-3-1. Cell 3 TME, Input = 2V, Normal vs. HDR TID for the RT6804HG-1.

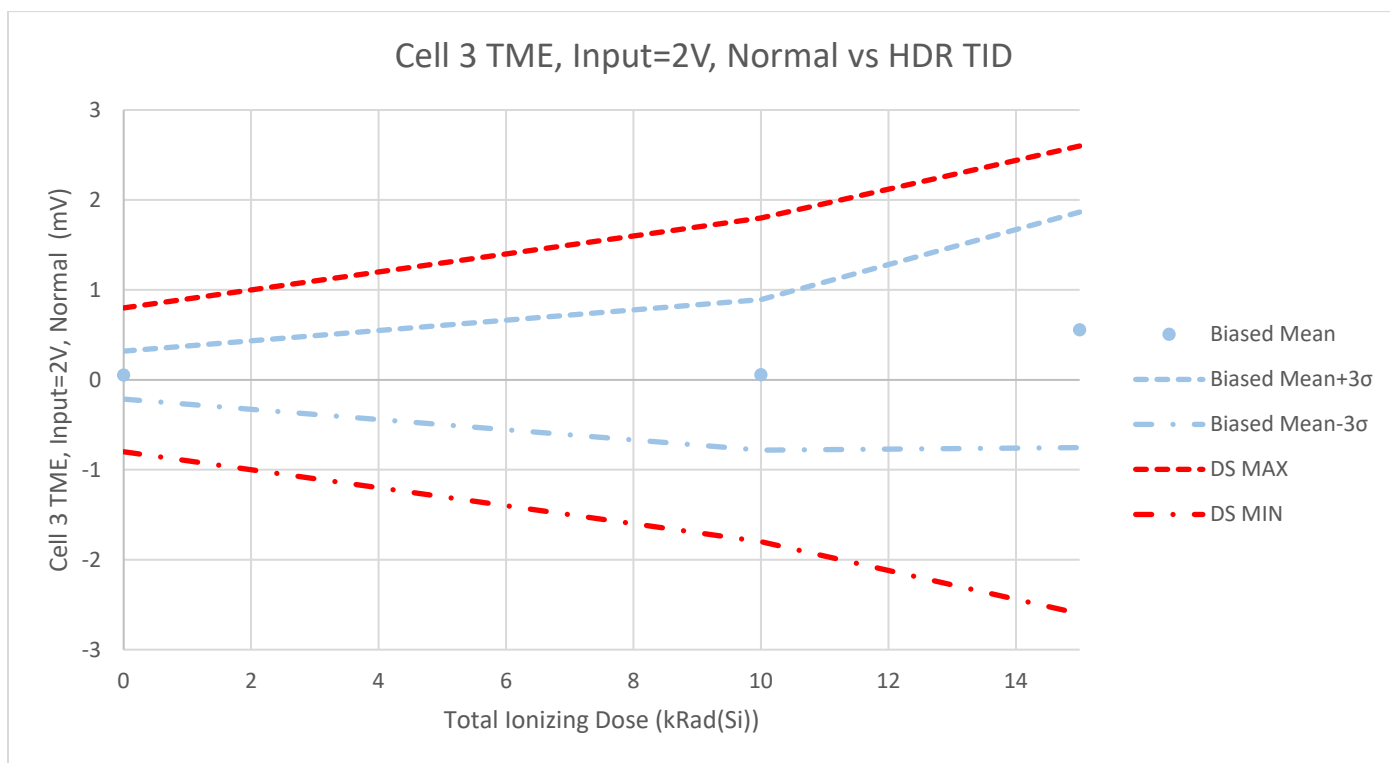

Table A-3-1. Cell 3 TME, Input = 2V, Normal vs. HDR TID for the RT6804HG-1.

HDR TID Biased				
Total Ionizing Dose (kRad(Si))	0	10	15	Units
Biased Mean	0.0529	0.0558	0.5562	mV
Std Dev	0.0889	0.2789	0.4367	
Biased Mean+3σ	0.3196	0.8924	1.8661	
Biased Mean-3σ	-0.2137	-0.7809	-0.7538	
DS MIN	-8.00E-01	-1.80E+00	-2.60E+00	mV
	PASS	PASS	PASS	
DS MAX	8.00E-01	1.80E+00	2.60E+00	mV
	PASS	PASS	PASS	

Figure A-3-2. Cell 3 TME, Input = 2V, Normal vs. LDR TID for the RT6804HG-1.

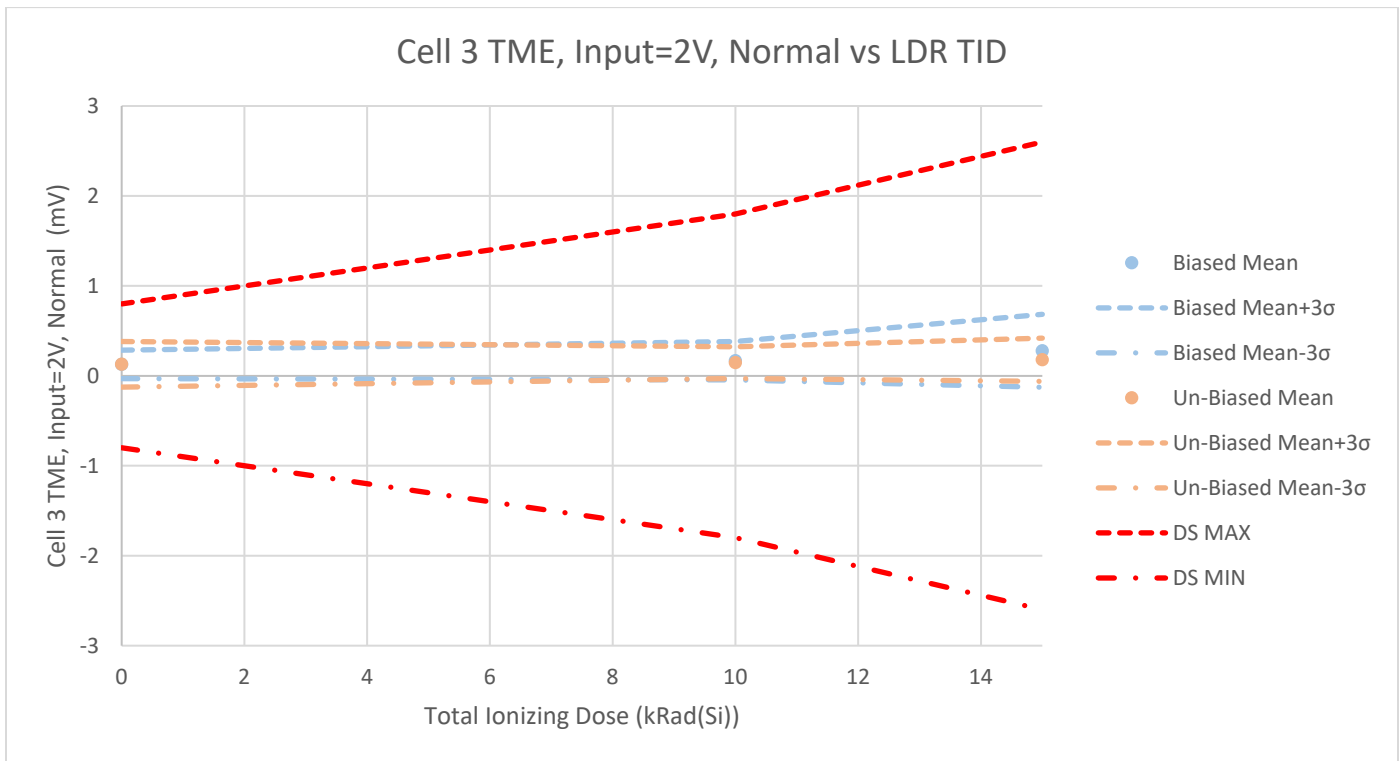

Table A-3-2. Cell 3 TME, Input = 2V, Normal vs. LDR TID for the RT6804HG-1.

Total Ionizing Dose (kRad(Si))	0	10	15	Units
LDR TID Biased				
Biased Mean	0.1276	0.1681	0.2784	mV
Std Dev	0.0526	0.0713	0.1352	
Biased Mean+3σ	0.2854	0.3821	0.6839	
Biased Mean-3σ	-0.0302	-0.0458	-0.1271	
LDR TID Un-Biased				
Un-Biased Mean	0.1284	0.1468	0.1786	mV
Std Dev	0.0841	0.0586	0.0800	
Un-Biased Mean+3σ	0.3808	0.3227	0.4186	
Un-Biased Mean-3σ	-0.1241	-0.0291	-0.0613	
DS Limits				
DS MIN	-8.00E-01	-1.80E+00	-2.60E+00	mV
	PASS	PASS	PASS	
DS MAX	8.00E-01	1.80E+00	2.60E+00	mV
	PASS	PASS	PASS	

Figure A-4-1. Cell 4 TME, Input = 2V, Normal vs. HDR TID for the RT6804HG-1.

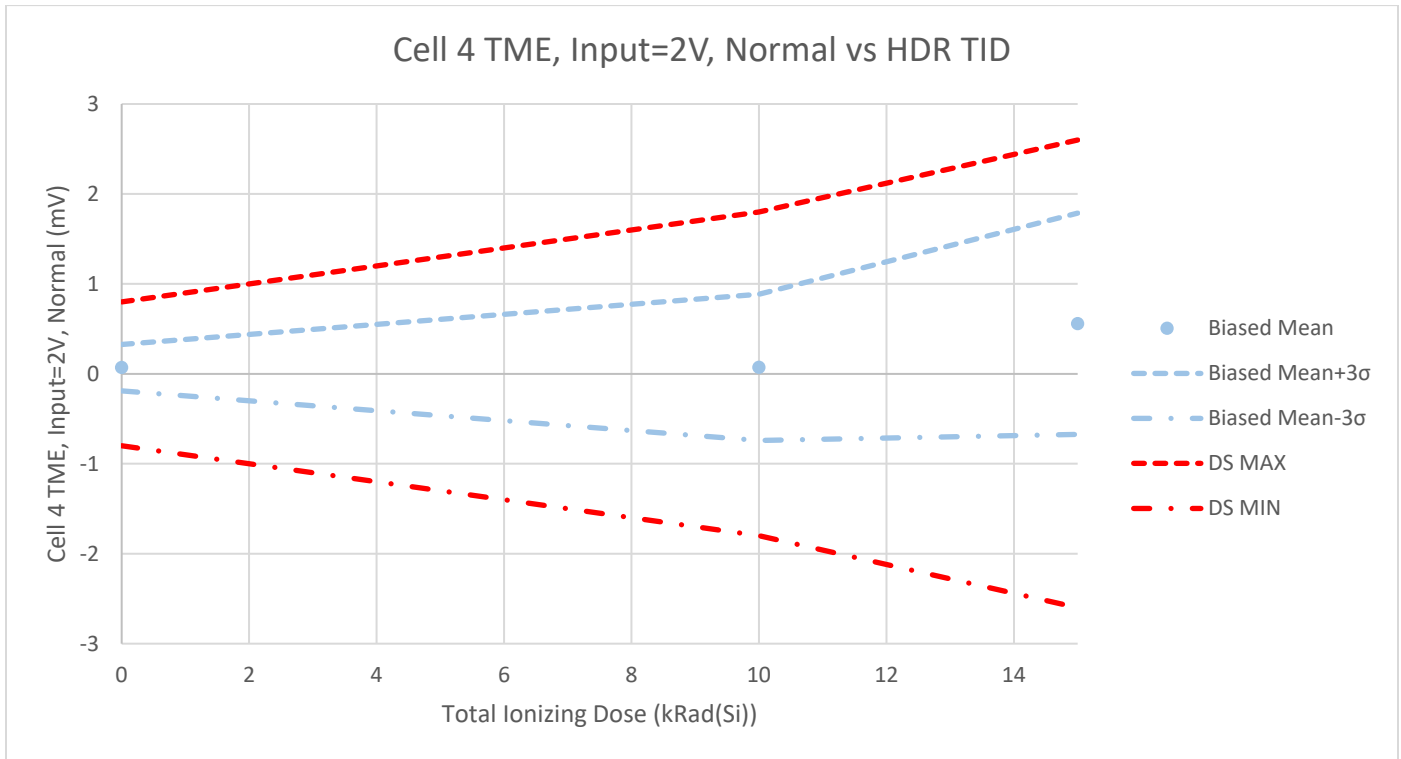

Table A-4-1. Cell 4 TME, Input = 2V, Normal vs. HDR TID for the RT6804HG-1.

HDR TID Biased				
Total Ionizing Dose (kRad(Si))	0	10	15	Units
Biased Mean	0.0691	0.0720	0.5565	mV
Std Dev	0.0859	0.2711	0.4102	
Biased Mean+3σ	0.3269	0.8854	1.7870	
Biased Mean-3σ	-0.1886	-0.7413	-0.6739	
DS MIN	-8.00E-01	-1.80E+00	-2.60E+00	mV
	PASS	PASS	PASS	
DS MAX	8.00E-01	1.80E+00	2.60E+00	mV
	PASS	PASS	PASS	

Figure A-4-2. Cell 4 TME, Input = 2V, Normal vs. LDR TID for the RT6804HG-1.

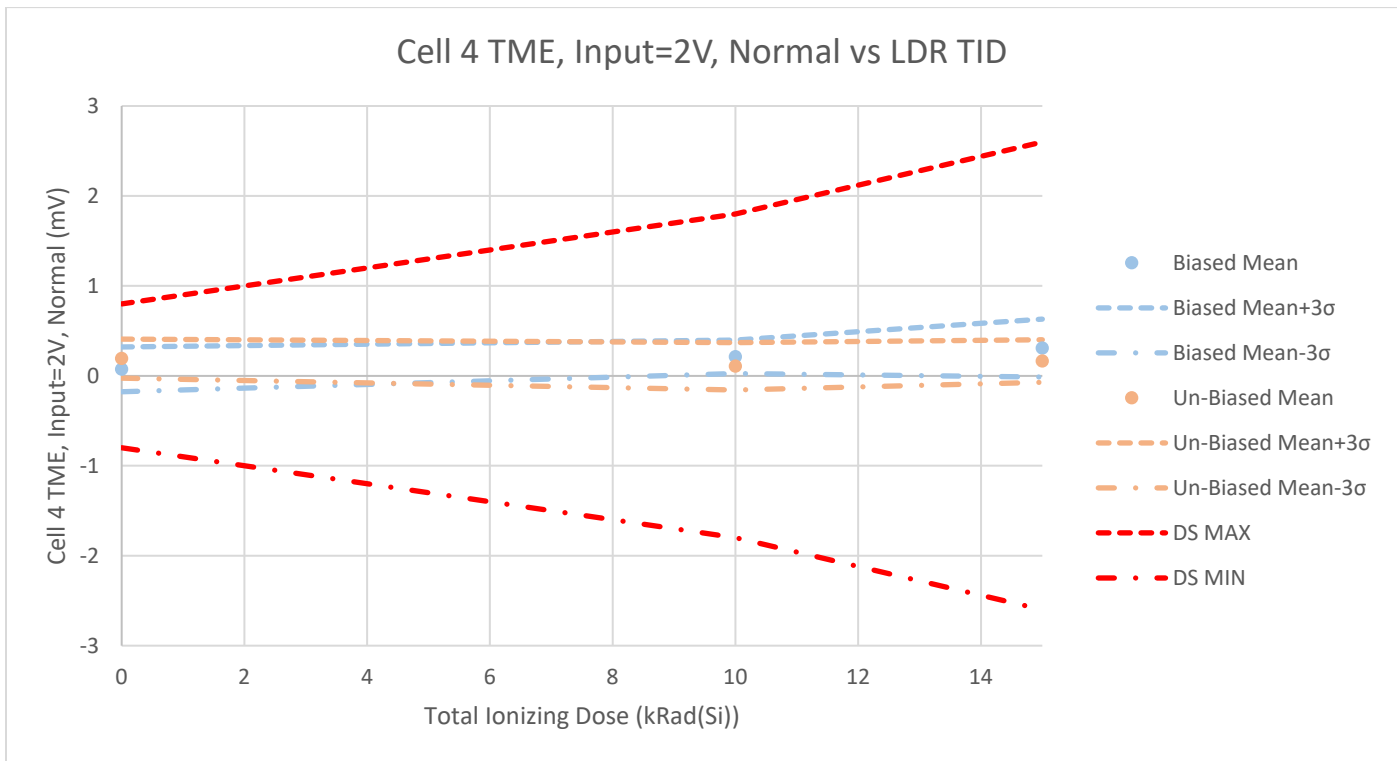

Table A-4-2. Cell 4 TME, Input = 2V, Normal vs. LDR TID for the RT6804HG-1.

Total Ionizing Dose (kRad(Si))	0	10	15	Units
LDR TID Biased				
Biased Mean	0.0727	0.2114	0.3088	mV
Std Dev	0.0832	0.0619	0.1074	
Biased Mean+3σ	0.3225	0.3972	0.6310	
Biased Mean-3σ	-0.1770	0.0256	-0.0135	
LDR TID Un-Biased				
Un-Biased Mean	0.1924	0.1065	0.1645	mV
Std Dev	0.0724	0.0876	0.0787	
Un-Biased Mean+3σ	0.4097	0.3693	0.4008	
Un-Biased Mean-3σ	-0.0248	-0.1564	-0.0717	
DS MIN	-8.00E-01	-1.80E+00	-2.60E+00	mV
	PASS	PASS	PASS	
DS MAX	8.00E-01	1.80E+00	2.60E+00	mV
	PASS	PASS	PASS	

Figure A-5-1. Cell 5 TME, Input = 2V, Normal vs. HDR TID for the RT6804HG-1.

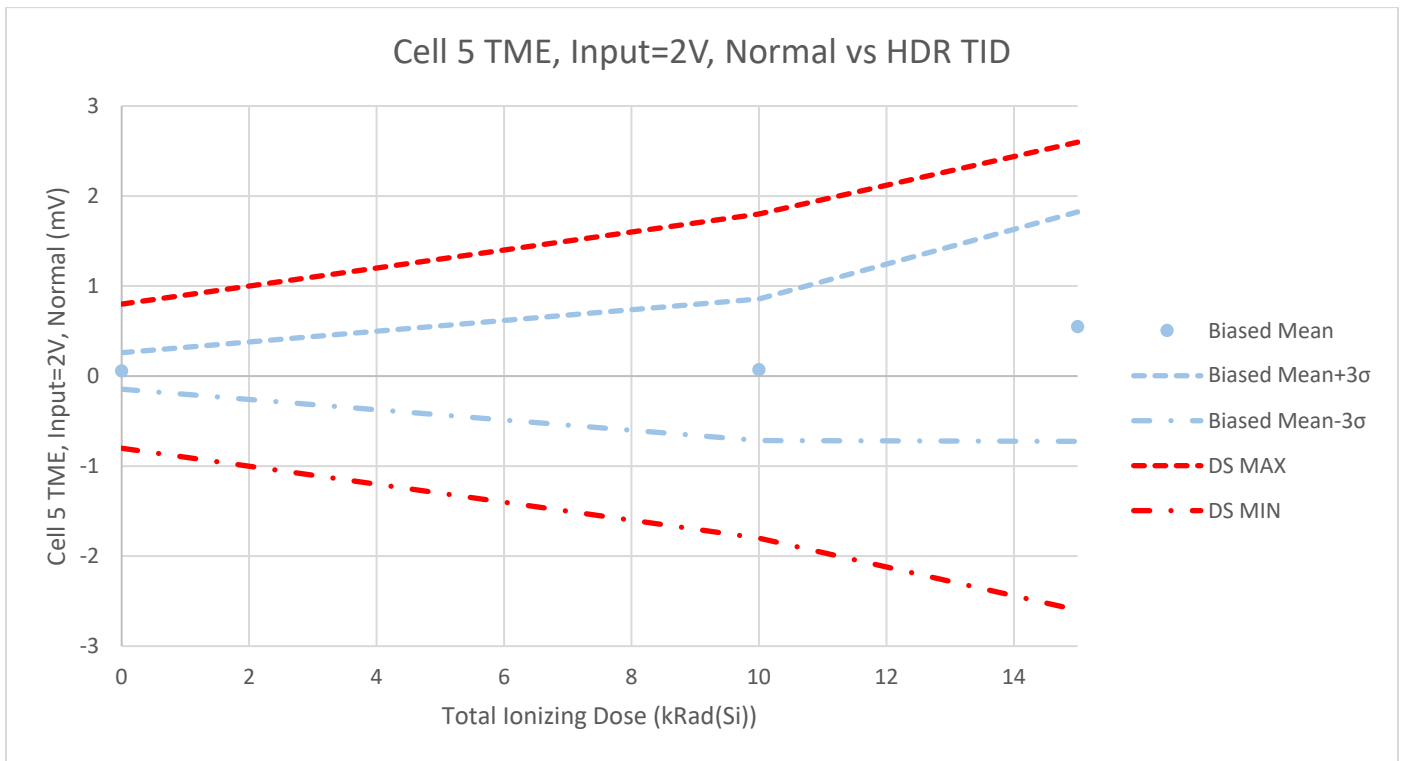

Table A-5-1. Cell 5 TME, Input = 2V, Normal vs. HDR TID for the RT6804HG-1.

HDR TID Biased				
Total Ionizing Dose (kRad(Si))	0	10	15	Units
Biased Mean	0.0576	0.0704	0.5497	mV
Std Dev	0.0673	0.2621	0.4248	
Biased Mean+3σ	0.2595	0.8566	1.8240	
Biased Mean-3σ	-0.1443	-0.7158	-0.7246	
DS MIN	-8.00E-01	-1.80E+00	-2.60E+00	mV
	PASS	PASS	PASS	
DS MAX	8.00E-01	1.80E+00	2.60E+00	mV
	PASS	PASS	PASS	

Figure A-5-1. Cell 5 TME, Input = 2V, Normal vs. LDR TID for the RT6804HG-1.

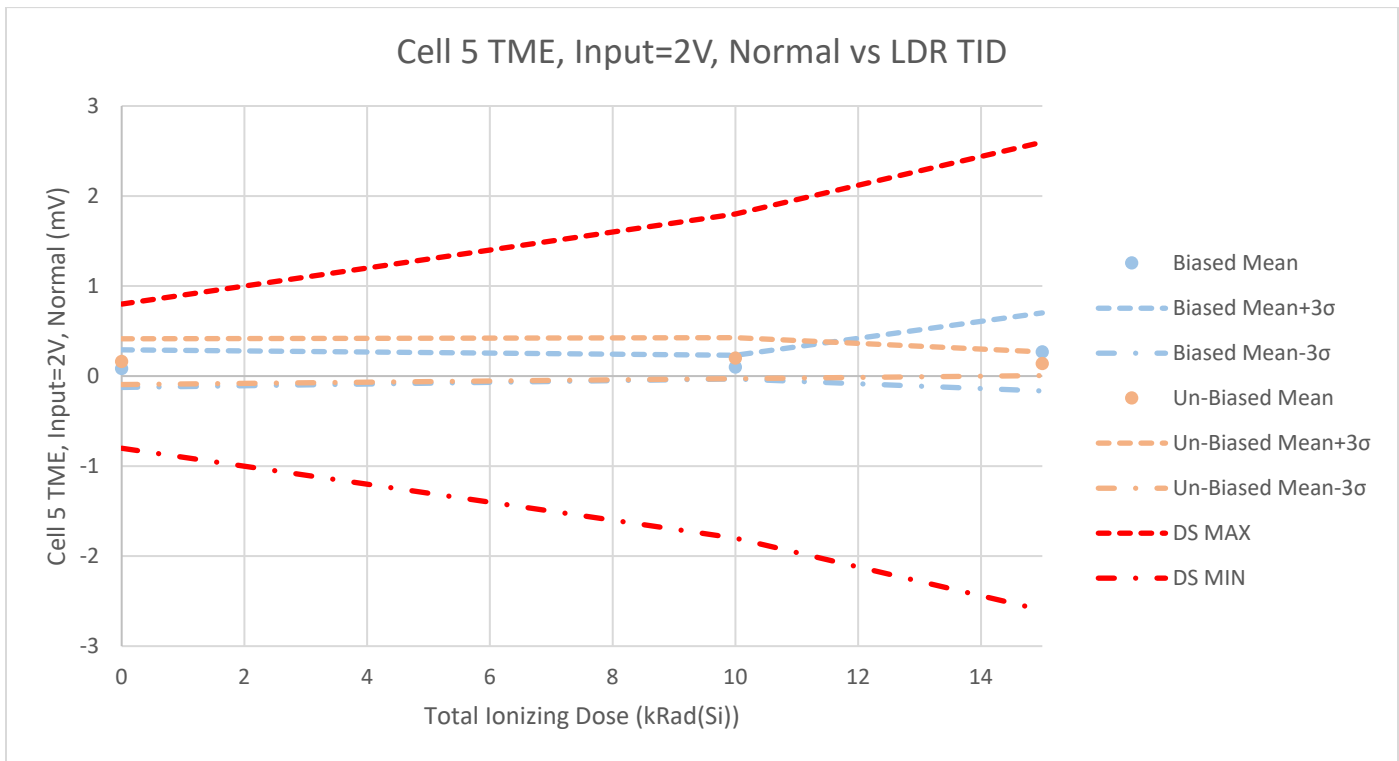

Table A-5-1. Cell 5 TME, Input = 2V, Normal vs. LDR TID for the RT6804HG-1.

Total Ionizing Dose (kRad(Si))	0	10	15	Units
LDR TID Biased				
Biased Mean	0.0827	0.1002	0.2687	mV
Std Dev	0.0695	0.0437	0.1445	
Biased Mean+3σ	0.2910	0.2313	0.7024	
Biased Mean-3σ	-0.1257	-0.0310	-0.1649	
LDR TID Un-Biased				
Un-Biased Mean	0.1608	0.1992	0.1378	mV
Std Dev	0.0846	0.0760	0.0439	
Un-Biased Mean+3σ	0.4146	0.4270	0.2694	
Un-Biased Mean-3σ	-0.0930	-0.0287	0.0062	
DS MIN				
DS MIN	-8.00E-01	-1.80E+00	-2.60E+00	mV
	PASS	PASS	PASS	
DS MAX				
DS MAX	8.00E-01	1.80E+00	2.60E+00	mV
	PASS	PASS	PASS	

Figure A-6-1. Cell 6 TME, Input = 2V, Normal vs. HDR TID for the RT6804HG-1.

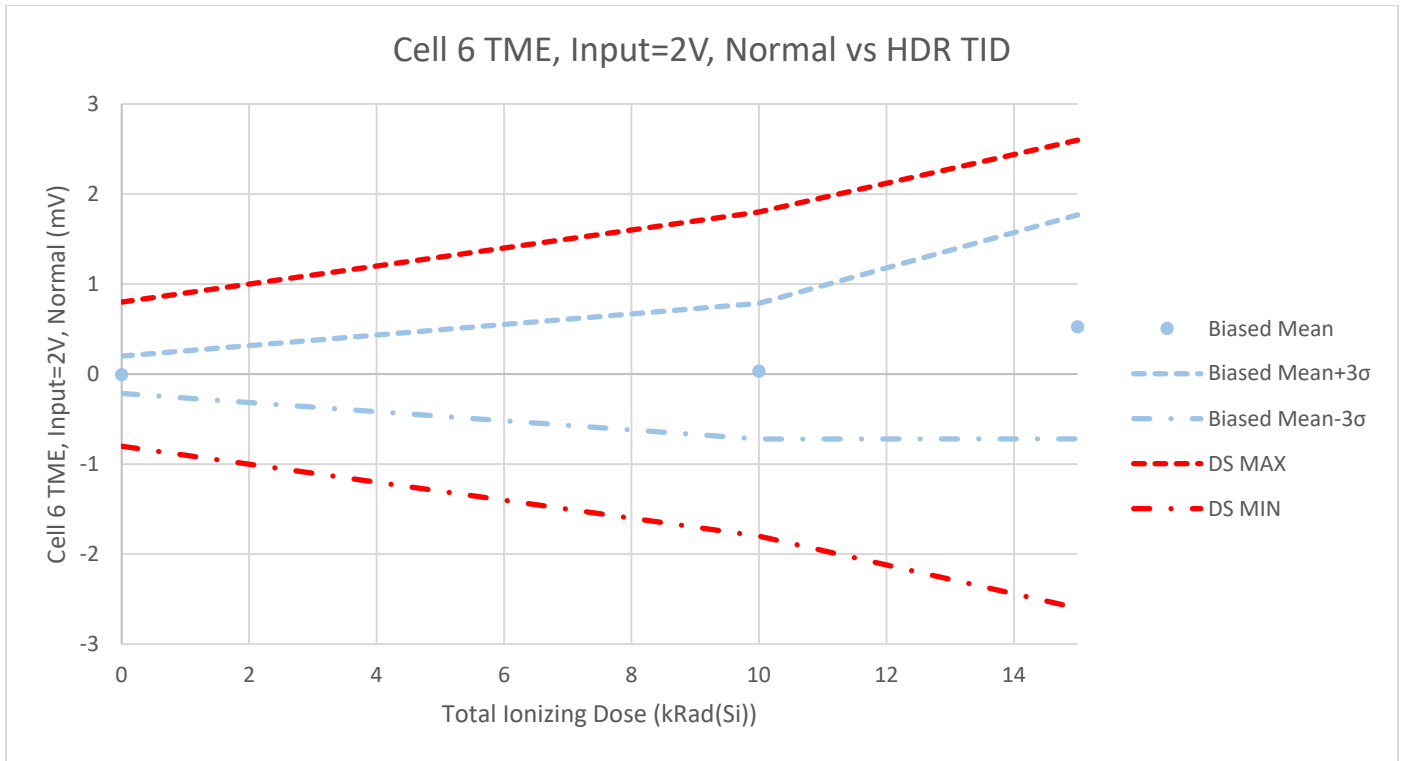

Table A-6-1. Cell 6 TME, Input = 2V, Normal vs. HDR TID for the RT6804HG-1.

HDR TID Biased				
Total Ionizing Dose (kRad(Si))	0	10	15	Units
Biased Mean	-0.0074	0.0325	0.5242	mV
Std Dev	0.0688	0.2513	0.4149	
Biased Mean+3σ	0.1992	0.7863	1.7688	
Biased Mean-3σ	-0.2139	-0.7212	-0.7204	
DS MIN	-8.00E-01	-1.80E+00	-2.60E+00	mV
	PASS	PASS	PASS	
DS MAX	8.00E-01	1.80E+00	2.60E+00	mV
	PASS	PASS	PASS	

Figure A-6-2. Cell 6 TME, Input = 2V, Normal vs. LDR TID for the RT6804HG-1.

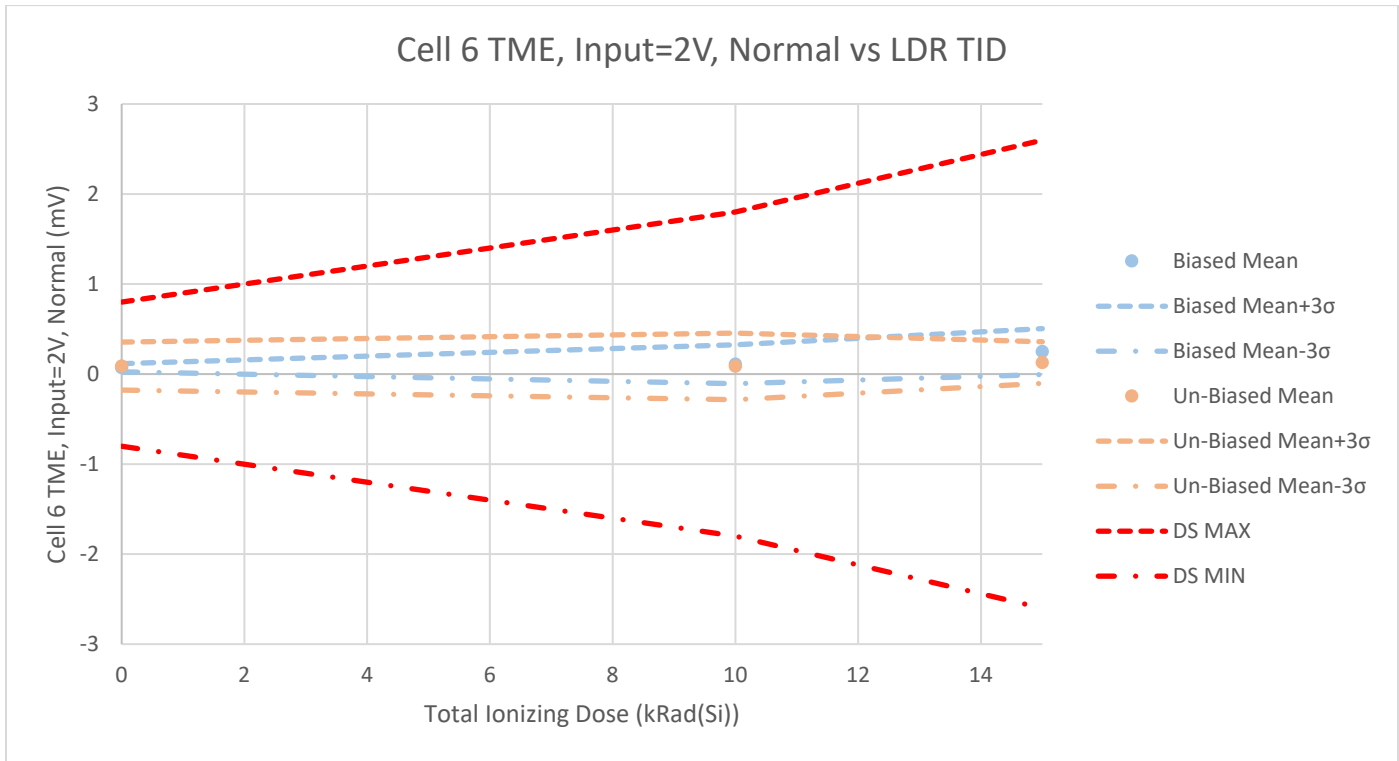

Table A-6-2. Cell 6 TME, Input = 2V, Normal vs. LDR TID for the RT6804HG-1.

LDR TID Biased				
Biased Mean	0.0711	0.1094	0.2496	mV
Std Dev	0.0152	0.0719	0.0850	
Biased Mean+3σ	0.1168	0.3252	0.5047	
Biased Mean-3σ	0.0255	-0.1063	-0.0054	
LDR TID Un-Biased				
Un-Biased Mean	0.0894	0.0865	0.1285	mV
Std Dev	0.0892	0.1233	0.0768	
Un-Biased Mean+3σ	0.3568	0.4565	0.3589	
Un-Biased Mean-3σ	-0.1781	-0.2835	-0.1019	
DS MIN	-8.00E-01	-1.80E+00	-2.60E+00	mV
	PASS	PASS	PASS	
DS MAX	8.00E-01	1.80E+00	2.60E+00	mV
	PASS	PASS	PASS	

Figure A-7-1. Cell 7 TME, Input = 2V, Normal vs. HDR TID for the RT6804HG-1.

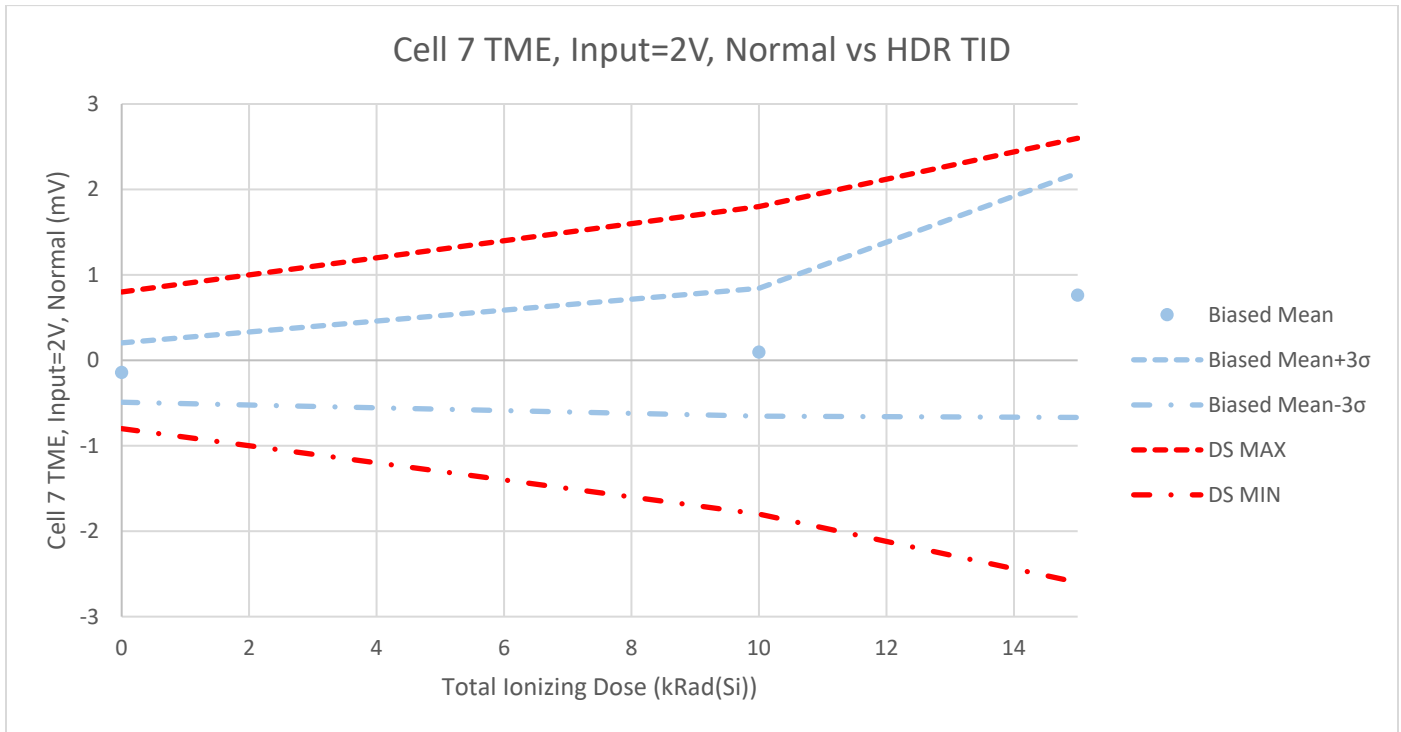

Table A-7-1. Cell 7 TME, Input = 2V, Normal vs. HDR TID for the RT6804HG-1.

Total Ionizing Dose (kRad(Si))	0	10	15	Units
Biased Mean	-0.1428	0.0941	0.7615	mV
Std Dev	0.1159	0.2494	0.4764	
Biased Mean+3σ	0.2048	0.8422	2.1908	
Biased Mean-3σ	-0.4905	-0.6540	-0.6677	
DS MIN	-8.00E-01	-1.80E+00	-2.60E+00	mV
	PASS	PASS	PASS	
DS MAX	8.00E-01	1.80E+00	2.60E+00	mV
	PASS	PASS	PASS	

Figure A-7-2. Cell 7 TME, Input = 2V, Normal vs. LDR TID for the RT6804HG-1.

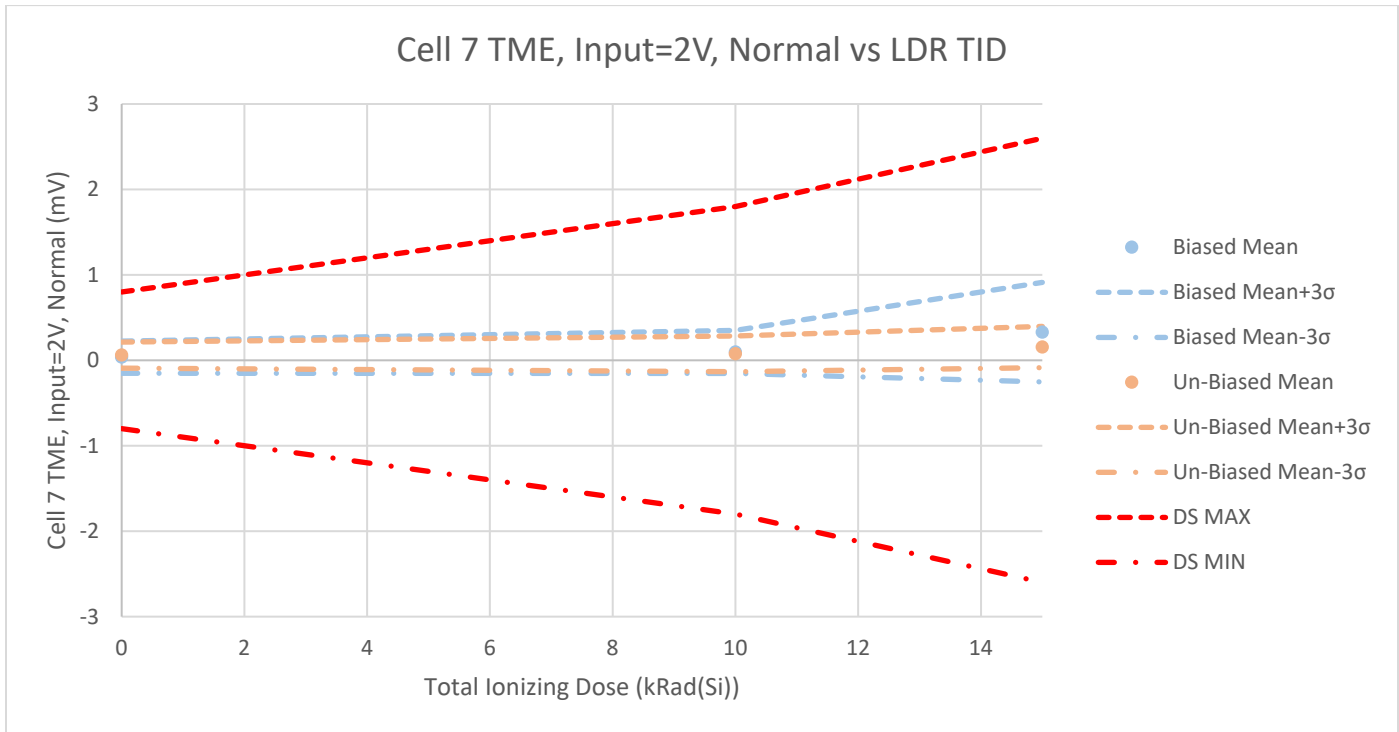

Table A-7-2. Cell 7 TME, Input = 2V, Normal vs. LDR TID for the RT6804HG-1.

Total Ionizing Dose (kRad(Si))	0	10	15	Units
LDR TID Biased				
Biased Mean	0.0365	0.0978	0.3299	mV
Std Dev	0.0626	0.0842	0.1942	
Biased Mean+3σ	0.2244	0.3503	0.9126	
Biased Mean-3σ	-0.1514	-0.1548	-0.2527	
LDR TID Un-Biased				
Un-Biased Mean	0.0608	0.0765	0.1555	mV
Std Dev	0.0510	0.0695	0.0806	
Un-Biased Mean+3σ	0.2139	0.2848	0.3973	
Un-Biased Mean-3σ	-0.0923	-0.1319	-0.0863	
DS Limits				
DS MIN	-8.00E-01	-1.80E+00	-2.60E+00	mV
	PASS	PASS	PASS	
DS MAX	8.00E-01	1.80E+00	2.60E+00	mV
	PASS	PASS	PASS	

Figure A-8-1. Cell 8 TME, Input = 2V, Normal vs. HDR TID for the RT6804HG-1.

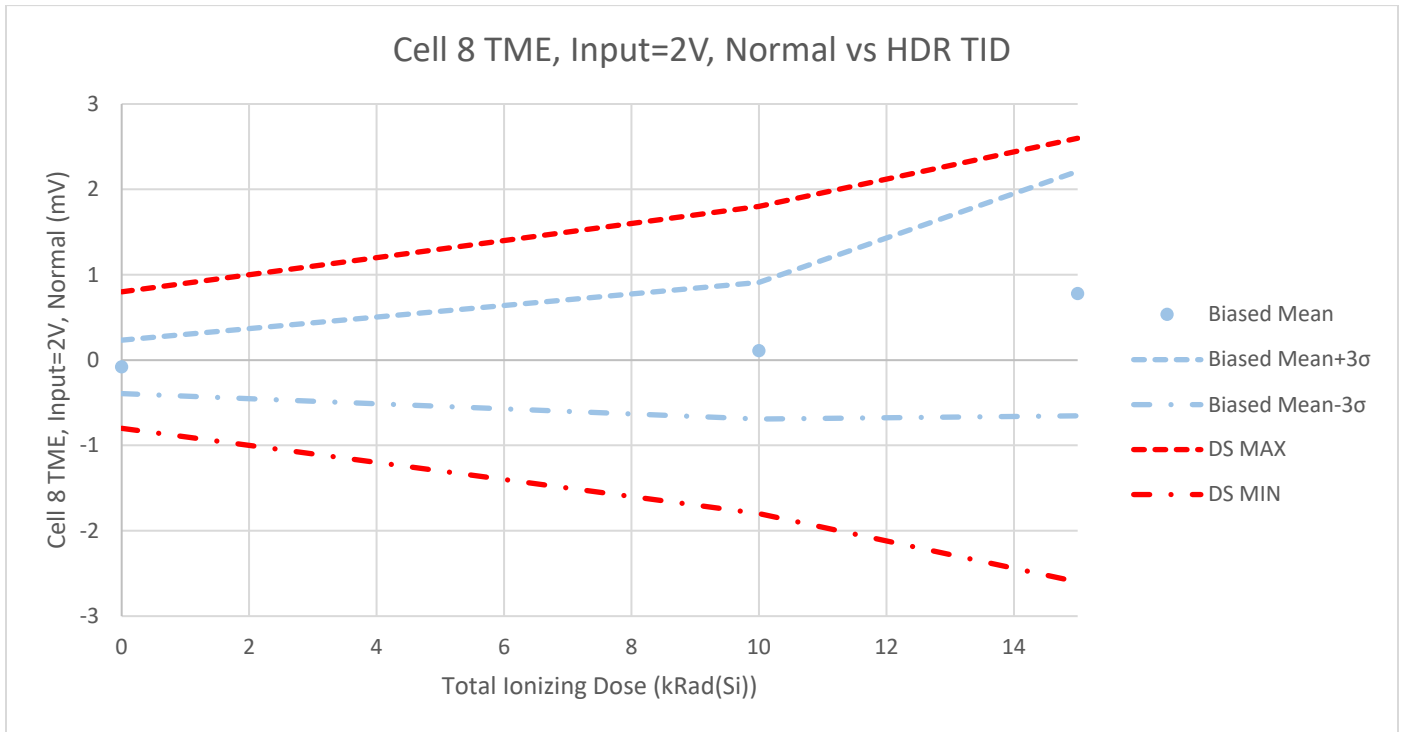

Table A-8-1. Cell 8 TME, Input = 2V, Normal vs. HDR TID for the RT6804HG-1.

HDR TID Biased				
Total Ionizing Dose (kRad(Si))	0	10	15	Units
Biased Mean	-0.0800	0.1097	0.7783	mV
Std Dev	0.1044	0.2667	0.4777	
Biased Mean+3σ	0.2331	0.9100	2.2113	
Biased Mean-3σ	-0.3931	-0.6905	-0.6547	
DS MIN	-8.00E-01	-1.80E+00	-2.60E+00	mV
	PASS	PASS	PASS	
DS MAX	8.00E-01	1.80E+00	2.60E+00	mV
	PASS	PASS	PASS	

Figure A-8-2. Cell 8 TME, Input = 2V, Normal vs. LDR TID for the RT6804HG-1.

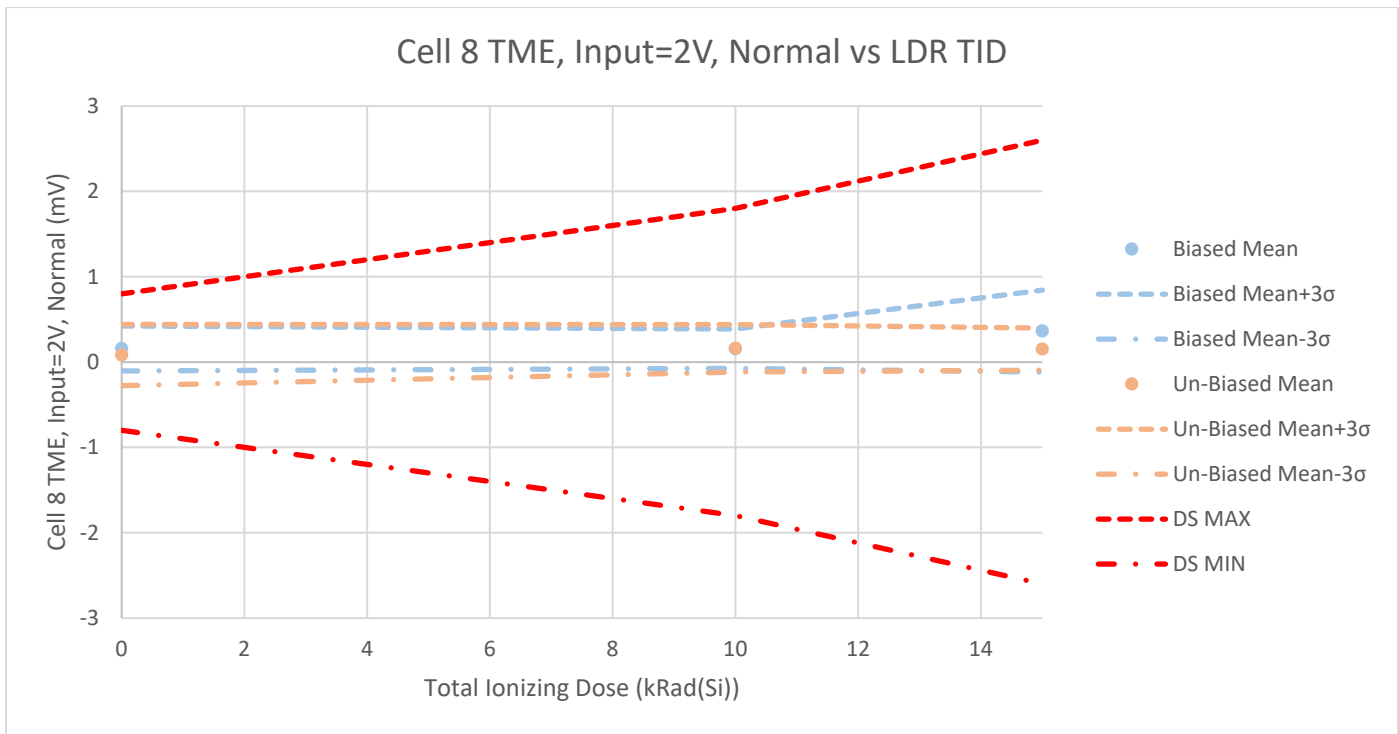

Table A-8-2. Cell 8 TME, Input = 2V, Normal vs. LDR TID for the RT6804HG-1.

LDR TID Biased				
Biased Mean	0.1587	0.1560	0.3634	mV
Std Dev	0.0880	0.0769	0.1601	
Biased Mean+3σ	0.4226	0.3868	0.8437	
Biased Mean-3σ	-0.1052	-0.0747	-0.1170	
LDR TID Un-Biased				
Un-Biased Mean	0.0824	0.1605	0.1517	mV
Std Dev	0.1195	0.0930	0.0822	
Un-Biased Mean+3σ	0.4408	0.4396	0.3983	
Un-Biased Mean-3σ	-0.2761	-0.1186	-0.0949	
DS MIN	-8.00E-01	-1.80E+00	-2.60E+00	mV
	PASS	PASS	PASS	
DS MAX	8.00E-01	1.80E+00	2.60E+00	mV
	PASS	PASS	PASS	

Figure A-9-1. Cell 9 TME, Input = 2V, Normal vs. HDR TID for the RT6804HG-1.

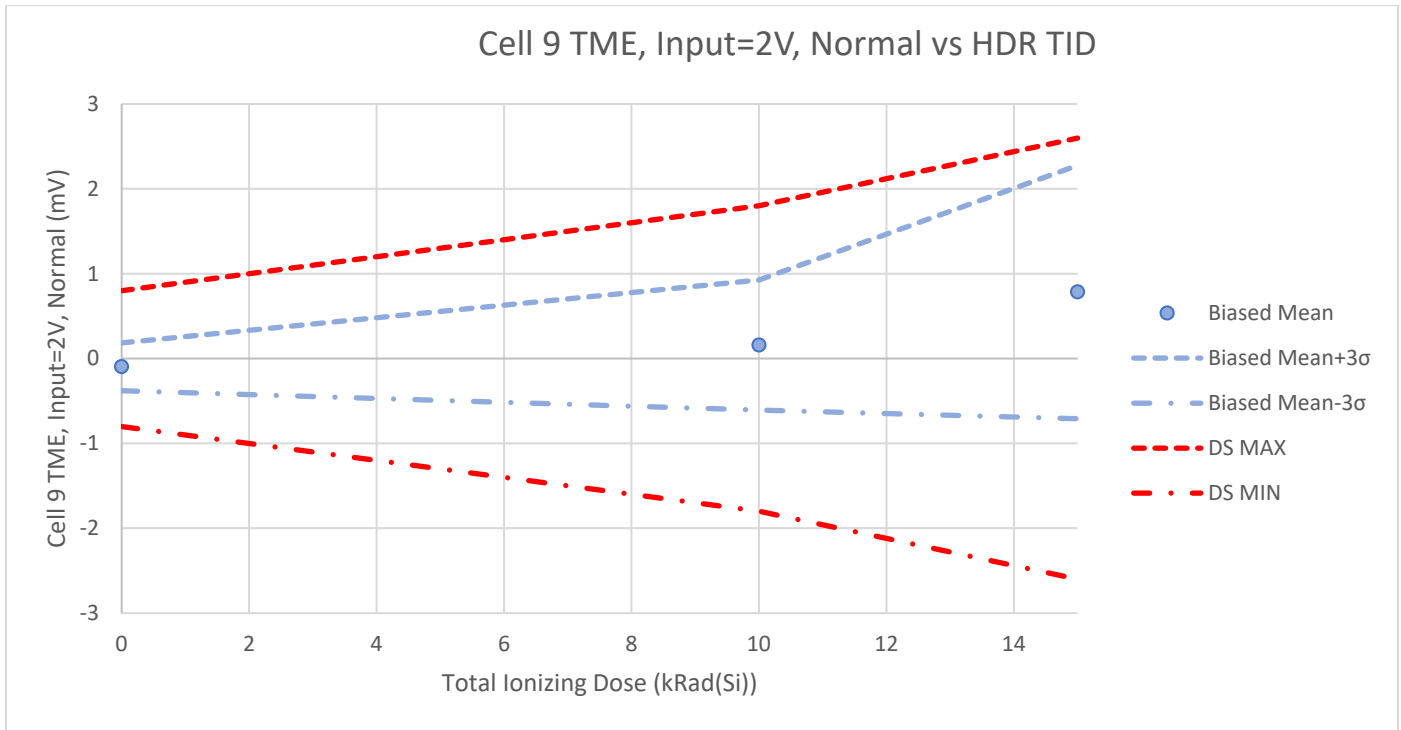

Table A-9-1. Cell 9 TME, Input = 2V, Normal vs. HDR TID for the RT6804HG-1.

HDR TID Biased				
Total Ionizing Dose (kRad(Si))	0	10	15	Units
Biased Mean	-0.0963	0.1593	0.7843	mV
Std Dev	0.0941	0.2556	0.4973	
Biased Mean+3σ	0.1861	0.9261	2.2762	
Biased Mean-3σ	-0.3787	-0.6075	-0.7075	
DS MIN	-8.00E-01	-1.80E+00	-2.60E+00	mV
	PASS	PASS	PASS	
DS MAX	8.00E-01	1.80E+00	2.60E+00	mV
	PASS	PASS	PASS	

Figure A-9-2. Cell 9 TME, Input = 2V, Normal vs. LDR TID for the RT6804HG-1.

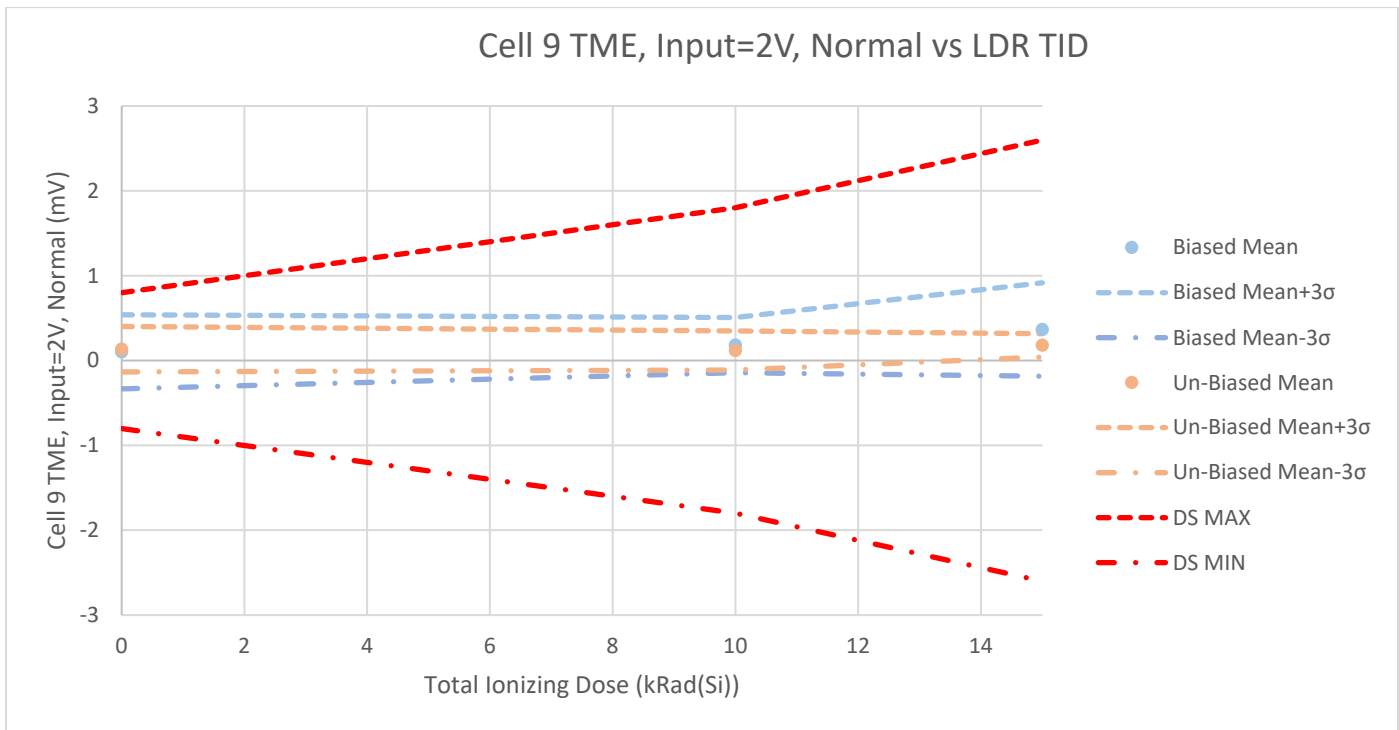

Table A-9-2. Cell 9 TME, Input = 2V, Normal vs. LDR TID for the RT6804HG-1.

LDR TID Biased				
Biased Mean	0.1023	0.1828	0.3662	mV
Std Dev	0.1453	0.1085	0.1835	
Biased Mean+3σ	0.5383	0.5083	0.9166	
Biased Mean-3σ	-0.3337	-0.1426	-0.1843	
LDR TID Un-Biased				
Un-Biased Mean	0.1342	0.1191	0.1801	mV
Std Dev	0.0891	0.0766	0.0461	
Un-Biased Mean+3σ	0.4015	0.3490	0.3182	
Un-Biased Mean-3σ	-0.1331	-0.1107	0.0419	
DS MIN	-8.00E-01	-1.80E+00	-2.60E+00	mV
	PASS	PASS	PASS	
DS MAX	8.00E-01	1.80E+00	2.60E+00	mV
	PASS	PASS	PASS	

Figure A-10-1. Cell 10 TME, Input = 2V, Normal vs. HDR TID for the RT6804HG-1.

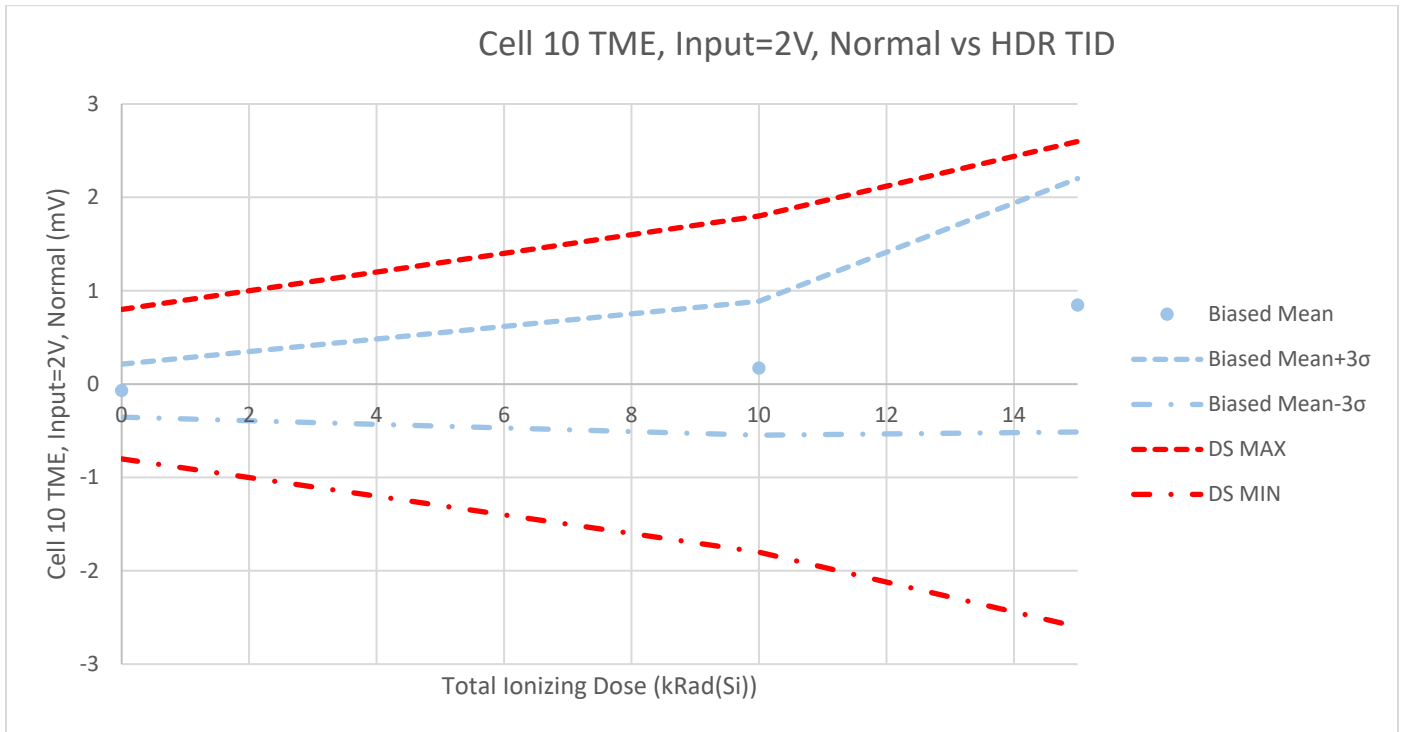

Table A-10-1. Cell 10 TME, Input = 2V, Normal vs. HDR TID for the RT6804HG-1.

HDR TID Biased				
Total Ionizing Dose (kRad(Si))	0	10	15	Units
Biased Mean	-0.0693	0.1703	0.8450	mV
Std Dev	0.0945	0.2390	0.4526	
Biased Mean+3σ	0.2144	0.8873	2.2028	
Biased Mean-3σ	-0.3529	-0.5468	-0.5129	
DS MIN	-8.00E-01	-1.80E+00	-2.60E+00	mV
	PASS	PASS	PASS	
DS MAX	8.00E-01	1.80E+00	2.60E+00	mV
	PASS	PASS	PASS	

Figure A-10-2. Cell 10 TME, Input = 2V, Normal vs. LDR TID for the RT6804HG-1.

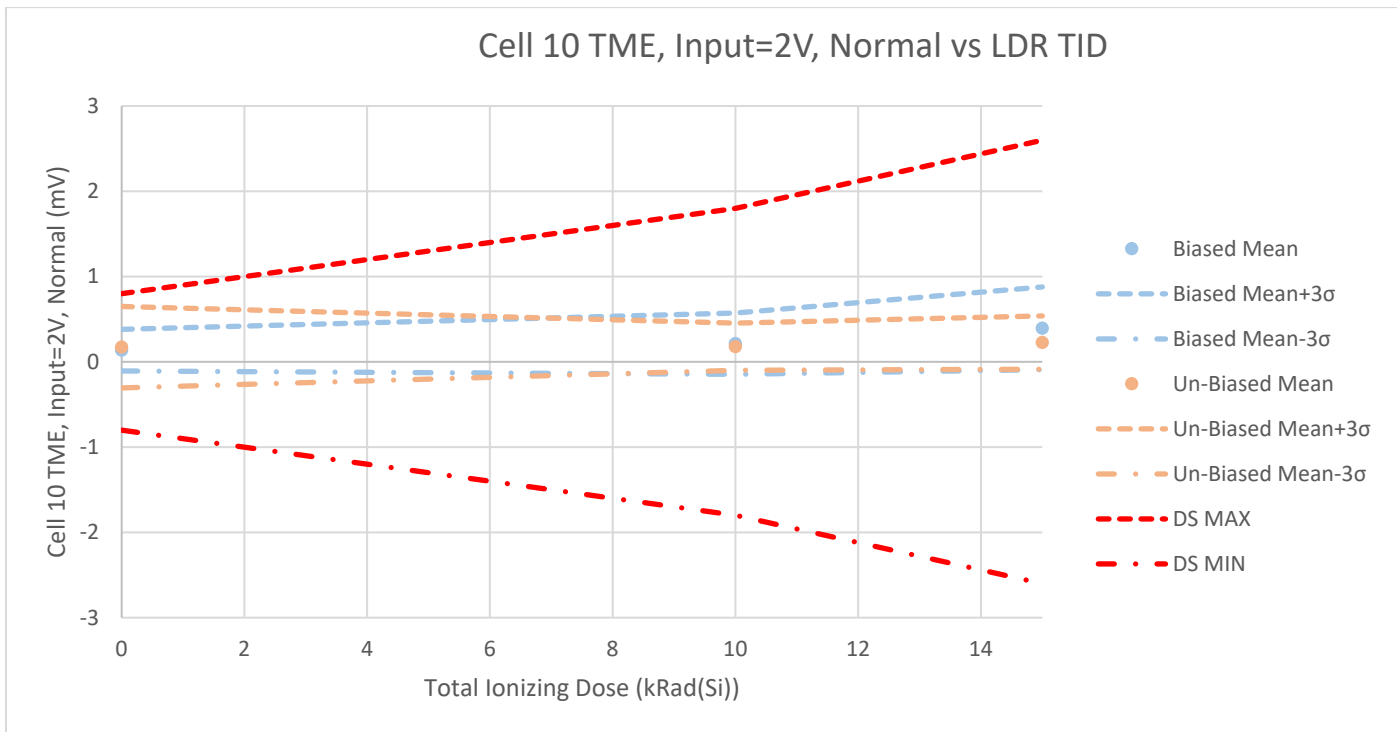

Table A-10-2. Cell 10 TME, Input = 2V, Normal vs. LDR TID for the RT6804HG-1.

Total Ionizing Dose (kRad(Si))	0	10	15	Units
LDR TID Biased				
Biased Mean	0.1371	0.2129	0.3940	mV
Std Dev	0.0816	0.1195	0.1617	
Biased Mean+3σ	0.3819	0.5714	0.8791	
Biased Mean-3σ	-0.1076	-0.1455	-0.0911	
LDR TID Un-Biased				
Un-Biased Mean	0.1728	0.1772	0.2265	mV
Std Dev	0.1592	0.0923	0.1040	
Un-Biased Mean+3σ	0.6505	0.4540	0.5384	
Un-Biased Mean-3σ	-0.3049	-0.0996	-0.0853	
DS MIN	-8.00E-01	-1.80E+00	-2.60E+00	mV
	PASS	PASS	PASS	
DS MAX	8.00E-01	1.80E+00	2.60E+00	mV
	PASS	PASS	PASS	

Figure A-11-1. Cell 11 TME, Input = 2V, Normal vs. HDR TID for the RT6804HG-1.

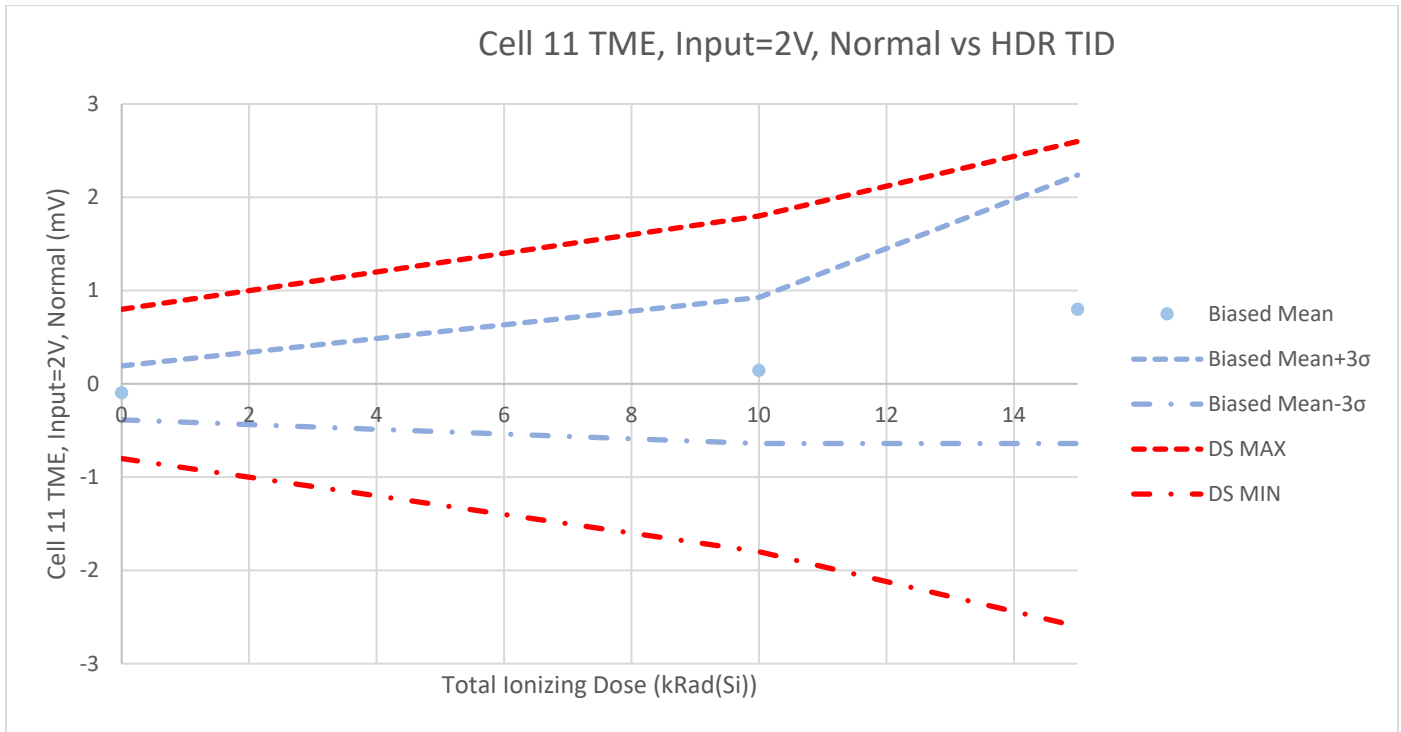

Table A-11-1. Cell 11 TME, Input = 2V, Normal vs. HDR TID for the RT6804HG-1.

HDR TID Biased				
Total Ionizing Dose (kRad(Si))	0	10	15	Units
Biased Mean	-0.0969	0.1435	0.7996	mV
Std Dev	0.0964	0.2611	0.4799	
Biased Mean+3σ	0.1923	0.9267	2.2393	
Biased Mean-3σ	-0.3861	-0.6397	-0.6401	
DS MIN	-8.00E-01	-1.80E+00	-2.60E+00	mV
	PASS	PASS	PASS	
DS MAX	8.00E-01	1.80E+00	2.60E+00	mV
	PASS	PASS	PASS	

Figure A-11-2. Cell 11 TME, Input = 2V, Normal vs. LDR TID for the RT6804HG-1.

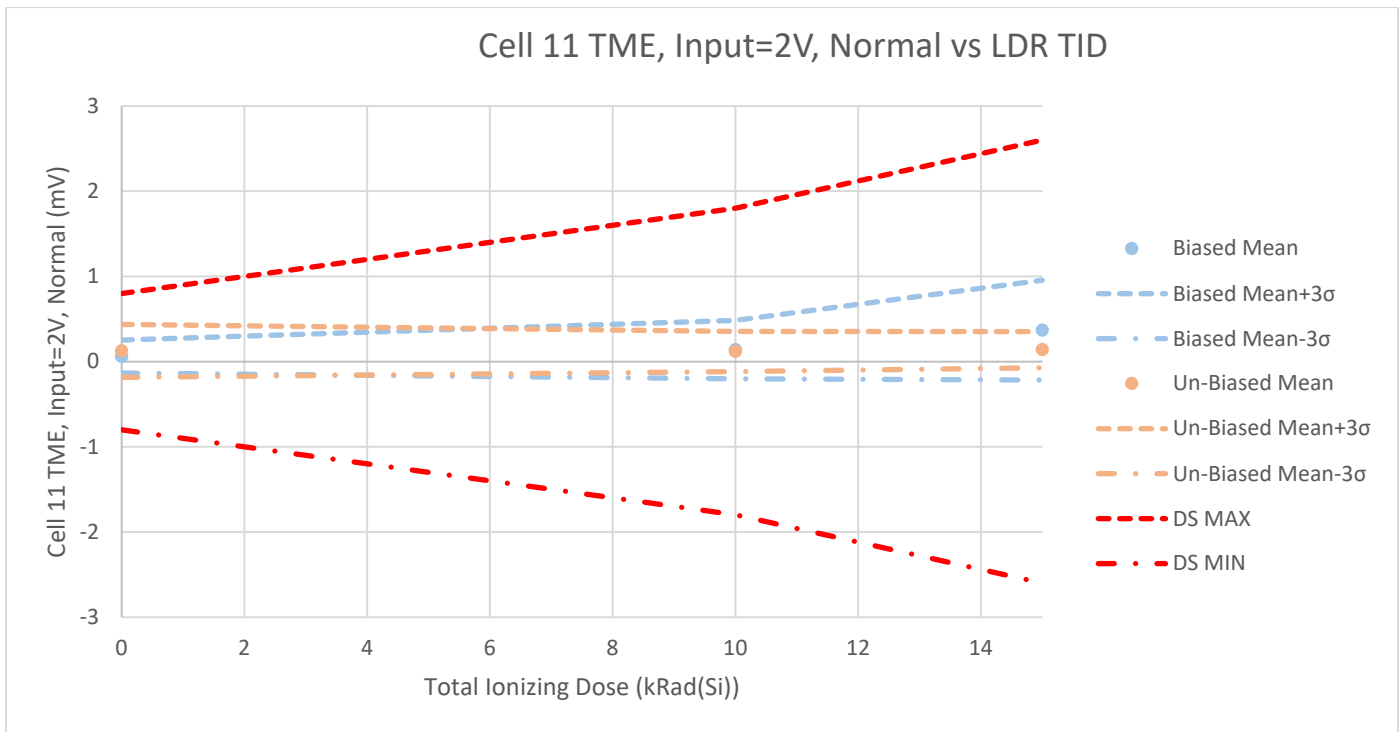

Table A-11-2. Cell 11 TME, Input = 2V, Normal vs. LDR TID for the RT6804HG-1.

Total Ionizing Dose (kRad(Si))	0	10	15	Units
LDR TID Biased				
Biased Mean	0.0593	0.1400	0.3689	mV
Std Dev	0.0645	0.1143	0.1952	
Biased Mean+3σ	0.2527	0.4829	0.9545	
Biased Mean-3σ	-0.1341	-0.2029	-0.2167	
LDR TID Un-Biased				
Un-Biased Mean	0.1255	0.1182	0.1406	mV
Std Dev	0.1036	0.0787	0.0708	
Un-Biased Mean+3σ	0.4364	0.3542	0.3529	
Un-Biased Mean-3σ	-0.1855	-0.1179	-0.0717	
DS MIN	-8.00E-01	-1.80E+00	-2.60E+00	mV
	PASS	PASS	PASS	
DS MAX	8.00E-01	1.80E+00	2.60E+00	mV
	PASS	PASS	PASS	

Figure A-12-1. Cell 12 TME, Input = 2V, Normal vs. HDR TID for the RT6804HG-1.

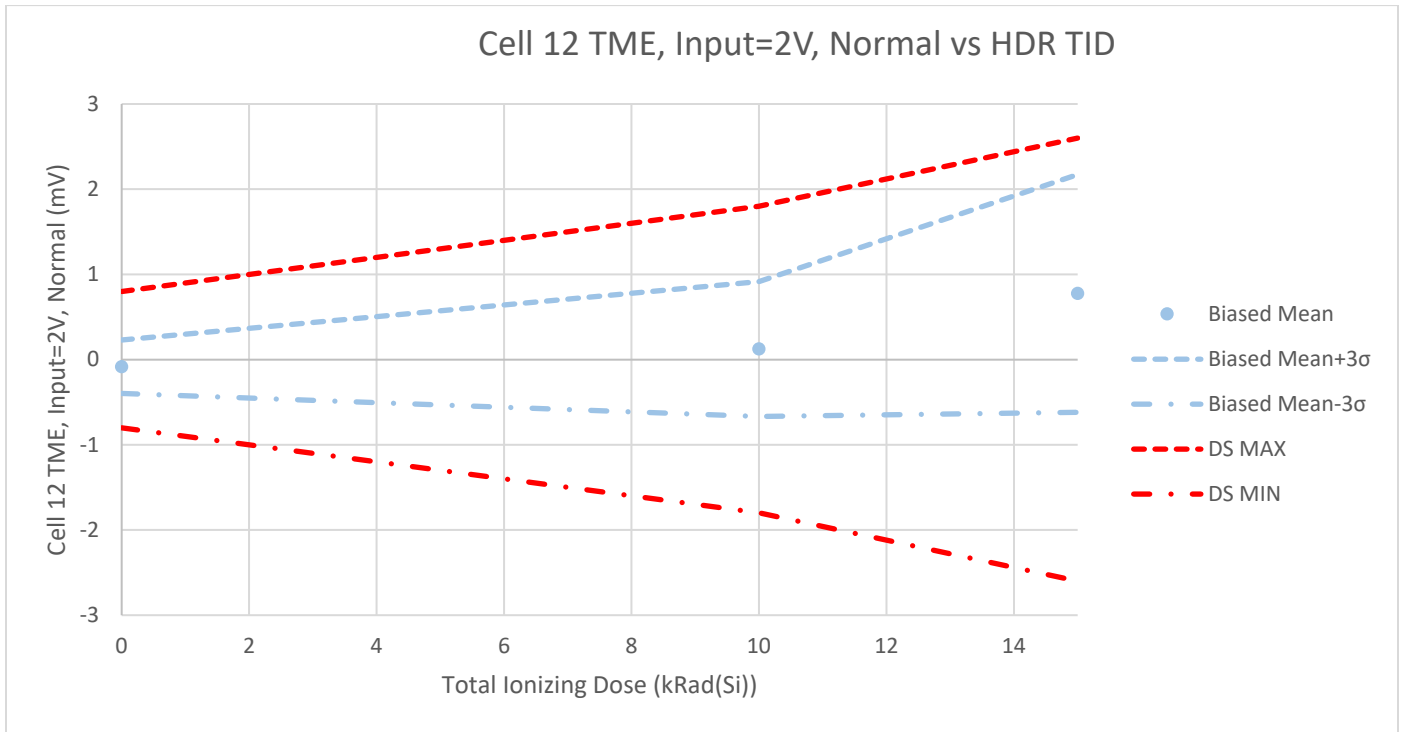

Table A-12-1. Cell 12 TME, Input = 2V, Normal vs. HDR TID for the RT6804HG-1.

HDR TID Biased				
Total Ionizing Dose (kRad(Si))	0	10	15	Units
Biased Mean	-0.0834	0.1240	0.7763	mV
Std Dev	0.1044	0.2635	0.4651	
Biased Mean+3σ	0.2298	0.9147	2.1717	
Biased Mean-3σ	-0.3966	-0.6666	-0.6191	
DS MIN	-8.00E-01	-1.80E+00	-2.60E+00	mV
	PASS	PASS	PASS	
DS MAX	8.00E-01	1.80E+00	2.60E+00	mV
	PASS	PASS	PASS	

Figure A-12-2. Cell 12 TME, Input = 2V, Normal vs. LDR TID for the RT6804HG-1.

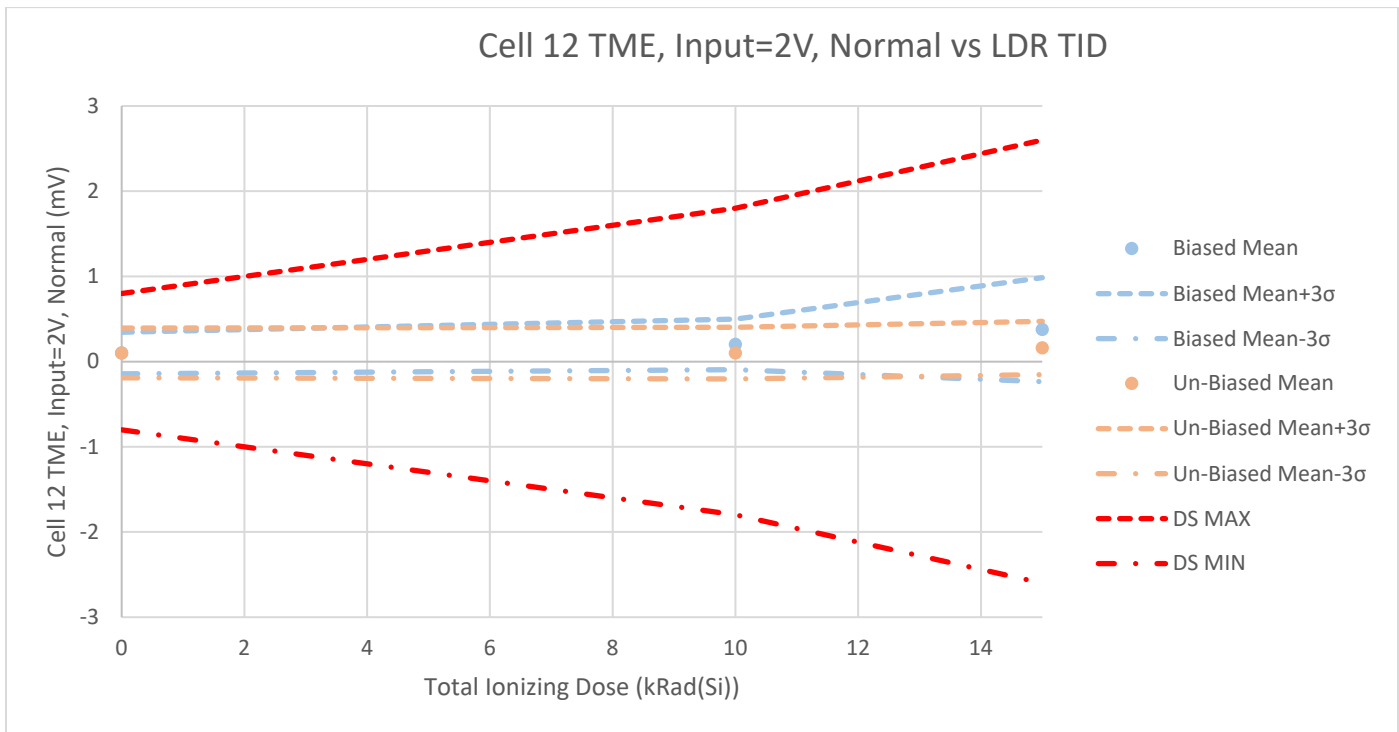

Table A-12-2. Cell 12 TME, Input = 2V, Normal vs. LDR TID for the RT6804HG-1.

Total Ionizing Dose (kRad(Si))	0	10	15	Units
LDR TID Biased				
Biased Mean	0.0995	0.2017	0.3756	mV
Std Dev	0.0816	0.0985	0.2034	
Biased Mean+3σ	0.3443	0.4971	0.9858	
Biased Mean-3σ	-0.1453	-0.0938	-0.2347	
LDR TID Un-Biased				
Un-Biased Mean	0.1007	0.0990	0.1600	mV
Std Dev	0.0976	0.1009	0.1042	
Un-Biased Mean+3σ	0.3934	0.4017	0.4726	
Un-Biased Mean-3σ	-0.1921	-0.2037	-0.1526	
DS MIN	-8.00E-01	-1.80E+00	-2.60E+00	mV
	PASS	PASS	PASS	
DS MAX	8.00E-01	1.80E+00	2.60E+00	mV
	PASS	PASS	PASS	

Figure A-13-1. GPIO1 TME, Input=2V, Normal vs. HDR TID for the RT6804HG-1.

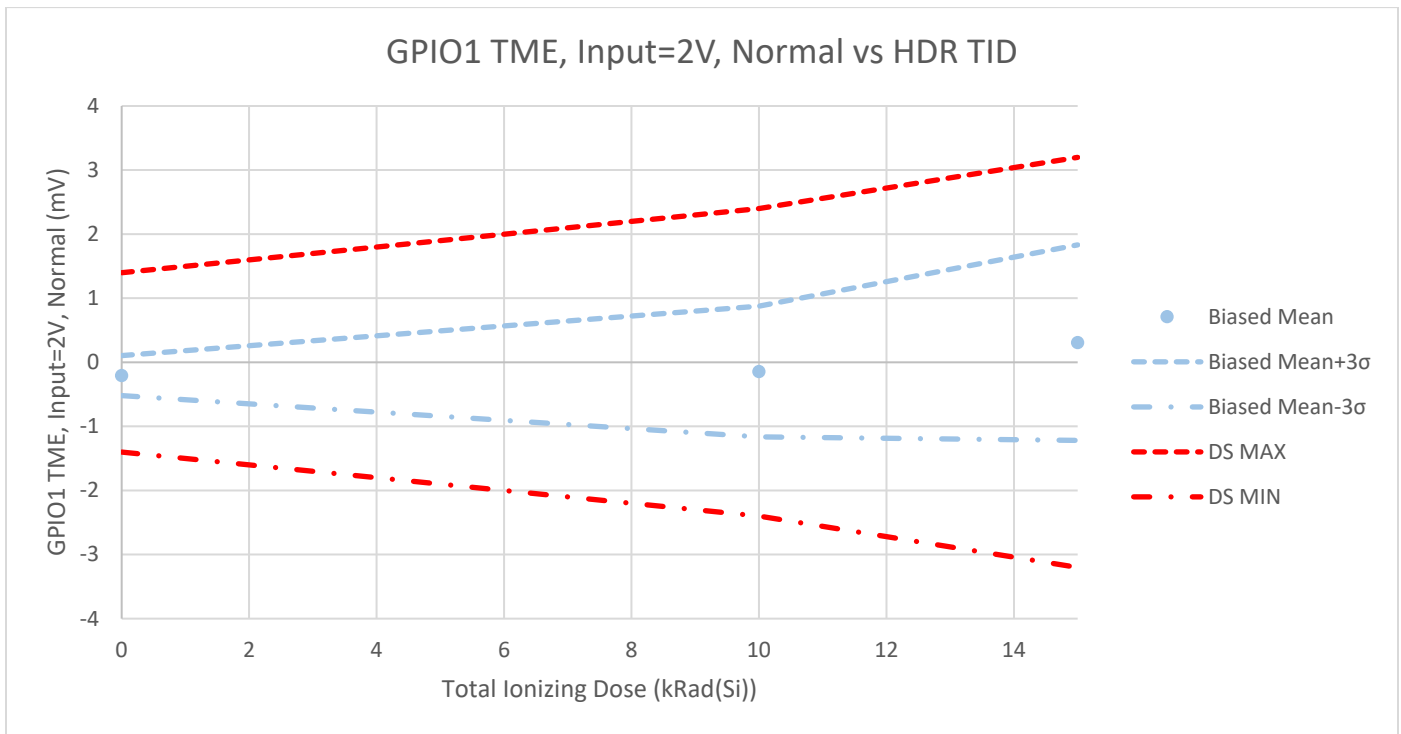

Table A-13-1. GPIO1 TME, Input=2V, Normal vs. HDR TID for the RT6804HG-1.

HDR TID Biased				
Total Ionizing Dose (kRad(Si))	0	10	15	Units
Biased Mean	-0.2070	-0.1452	0.3068	mV
Std Dev	0.1042	0.3400	0.5087	
Biased Mean+3σ	0.1055	0.8747	1.8329	
Biased Mean-3σ	-0.5195	-1.1651	-1.2193	
DS MIN	-1.40E+00	-2.40E+00	-3.20E+00	mV
	PASS	PASS	PASS	
DS MAX	1.40E+00	2.40E+00	3.20E+00	mV
	PASS	PASS	PASS	

Figure A-13-2. GPIO1 TME, Input=2V, Normal vs. LDR TID for the RT6804HG-1.

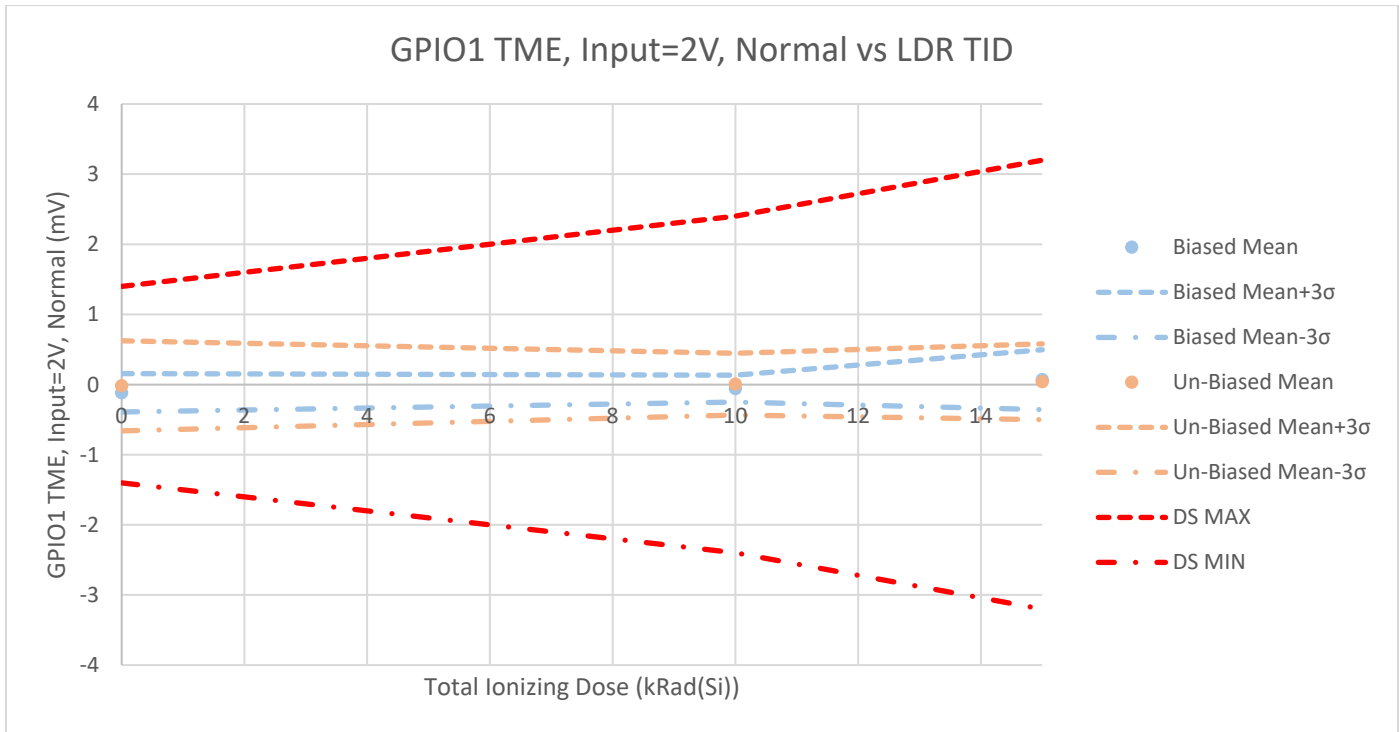

Table A-13-2. GPIO1 TME, Input=2V, Normal vs. LDR TID for the RT6804HG-1.

Total Ionizing Dose (kRad(Si))	0	10	15	Units
LDR TID Biased				
Biased Mean	-0.1172	-0.0577	0.0696	mV
Std Dev	0.0908	0.0637	0.1423	
Biased Mean+3σ	0.1550	0.1333	0.4964	
Biased Mean-3σ	-0.3895	-0.2488	-0.3572	
LDR TID Un-Biased				
Un-Biased Mean	-0.0174	0.0059	0.0398	mV
Std Dev	0.2143	0.1468	0.1800	
Un-Biased Mean+3σ	0.6254	0.4464	0.5796	
Un-Biased Mean-3σ	-0.6603	-0.4346	-0.5001	
DS MIN	-1.40E+00	-2.40E+00	-3.20E+00	mV
	PASS	PASS	PASS	
DS MAX	1.40E+00	2.40E+00	3.20E+00	mV
	PASS	PASS	PASS	

Figure A-14-1. GPIO2 TME, Input=2V, Normal vs. HDR TID for the RT6804HG-1.

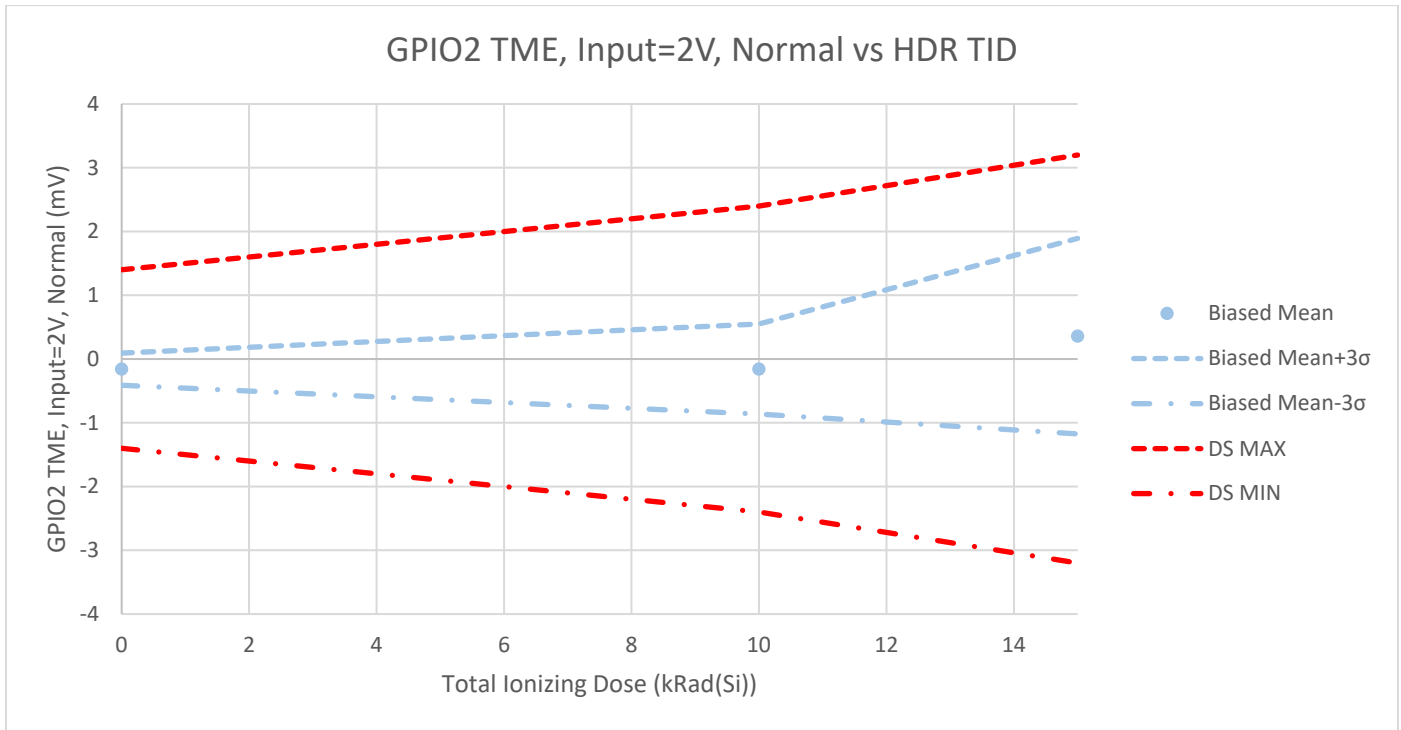

Table A-14-1. GPIO2 TME, Input=2V, Normal vs. HDR TID for the RT6804HG-1.

HDR TID Biased				
Total Ionizing Dose (kRad(Si))	0	10	15	Units
Biased Mean	-0.1595	-0.1578	0.3594	mV
Std Dev	0.0841	0.2356	0.5115	
Biased Mean+3σ	0.0927	0.5492	1.8938	
Biased Mean-3σ	-0.4116	-0.8647	-1.1750	
DS MIN	-1.40E+00	-2.40E+00	-3.20E+00	mV
	PASS	PASS	PASS	
DS MAX	1.40E+00	2.40E+00	3.20E+00	mV
	PASS	PASS	PASS	

Figure A-14-2. GPIO2 TME, Input=2V, Normal vs. LDR TID for the RT6804HG-1.

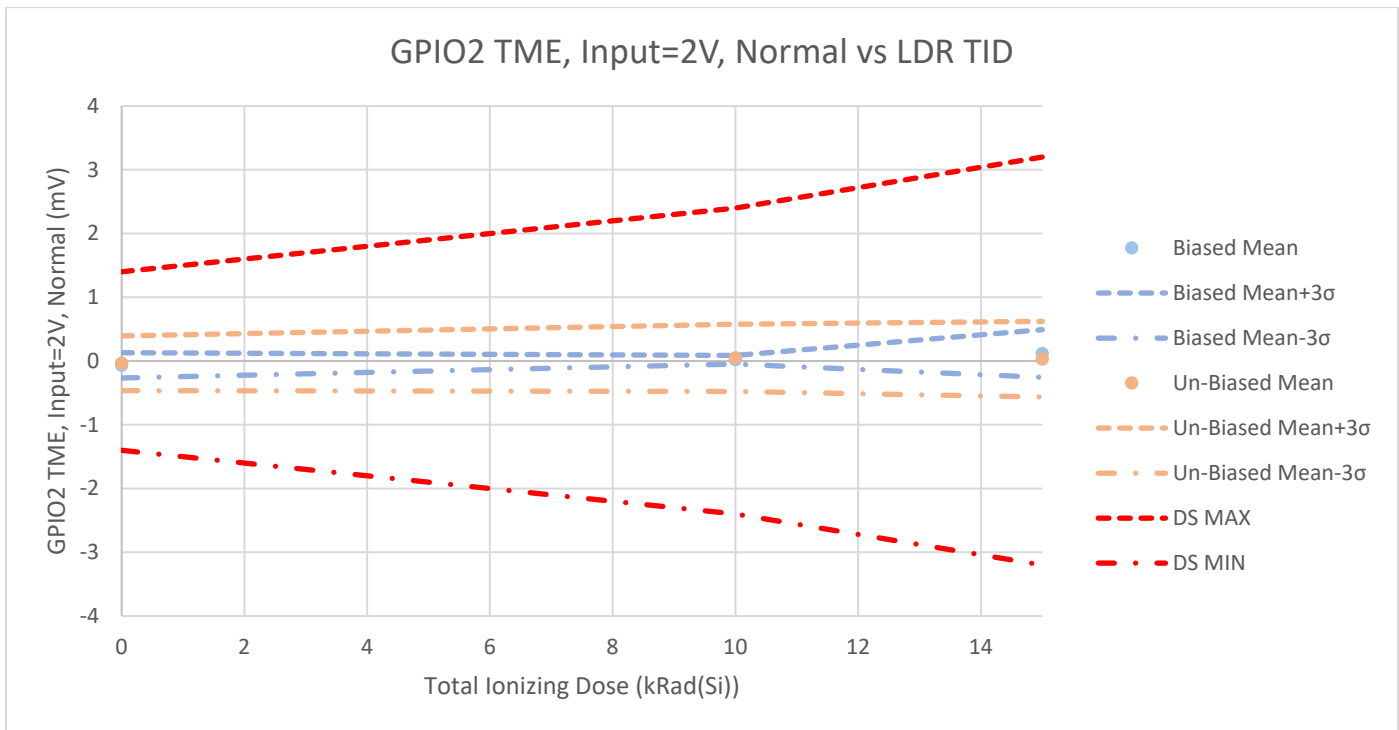

Table A-14-2. GPIO2 TME, Input=2V, Normal vs. LDR TID for the RT6804HG-1.

Total Ionizing Dose (kRad(Si))	0	10	15	Units
LDR TID Biased				
Biased Mean	-0.0675	0.0206	0.1172	mV
Std Dev	0.0658	0.0227	0.1249	
Biased Mean+3σ	0.1300	0.0888	0.4919	
Biased Mean-3σ	-0.2650	-0.0476	-0.2576	
LDR TID Un-Biased				
Un-Biased Mean	-0.0344	0.0503	0.0302	mV
Std Dev	0.1427	0.1757	0.1979	
Un-Biased Mean+3σ	0.3937	0.5773	0.6239	
Un-Biased Mean-3σ	-0.4625	-0.4767	-0.5635	
DS MIN	-1.40E+00	-2.40E+00	-3.20E+00	mV
	PASS	PASS	PASS	
DS MAX	1.40E+00	2.40E+00	3.20E+00	mV
	PASS	PASS	PASS	

Figure A-15-1. GPIO3 TME, Input=2V, Normal vs. HDR TID for the RT6804HG-1.

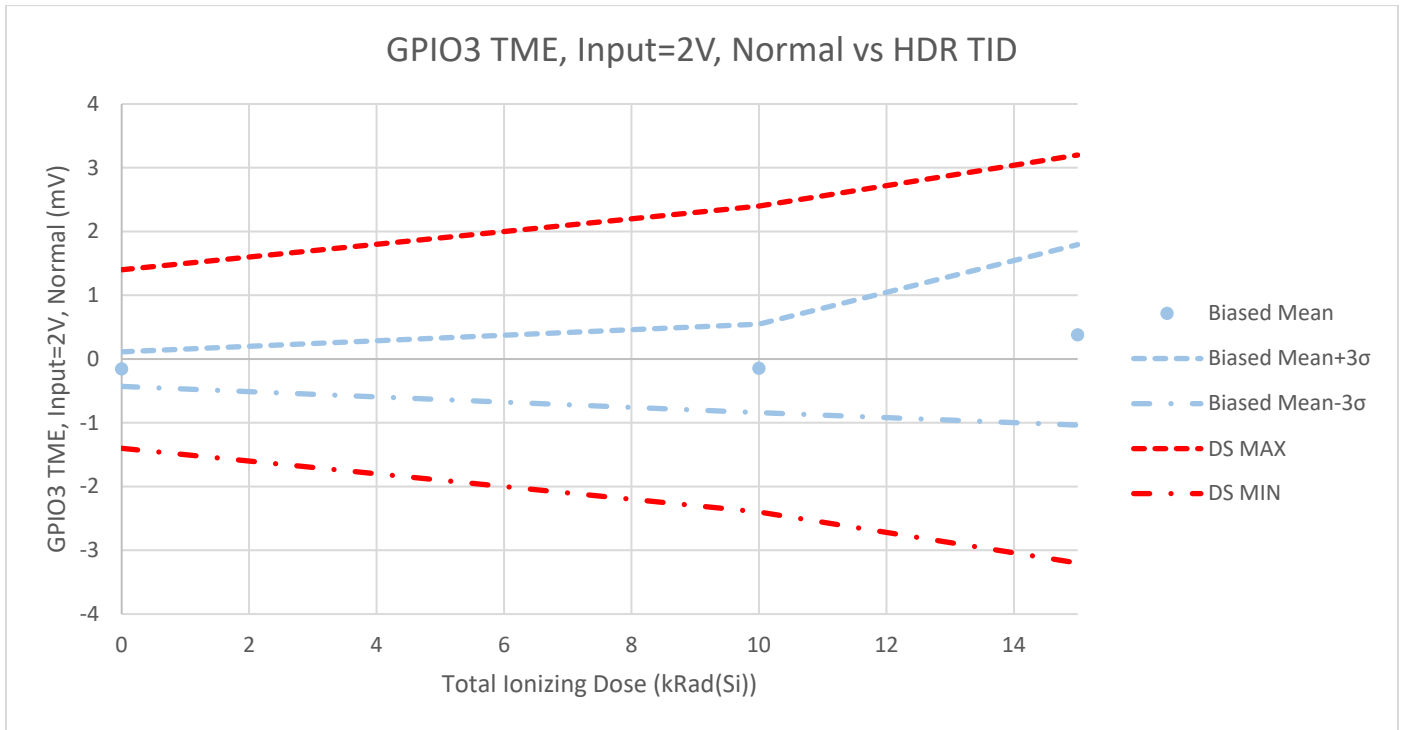

Table A-15-1. GPIO3 TME, Input=2V, Normal vs. HDR TID for the RT6804HG-1.

HDR TID Biased				
Total Ionizing Dose (kRad(Si))	0	10	15	Units
Biased Mean	-0.1572	-0.1473	0.3791	mV
Std Dev	0.0903	0.2313	0.4719	
Biased Mean+3σ	0.1137	0.5465	1.7949	
Biased Mean-3σ	-0.4281	-0.8412	-1.0367	
DS MIN	-1.40E+00	-2.40E+00	-3.20E+00	mV
	PASS	PASS	PASS	
DS MAX	1.40E+00	2.40E+00	3.20E+00	mV
	PASS	PASS	PASS	

Figure A-15-2. GPIO3 TME, Input=2V, Normal vs. LDR TID for the RT6804HG-1.

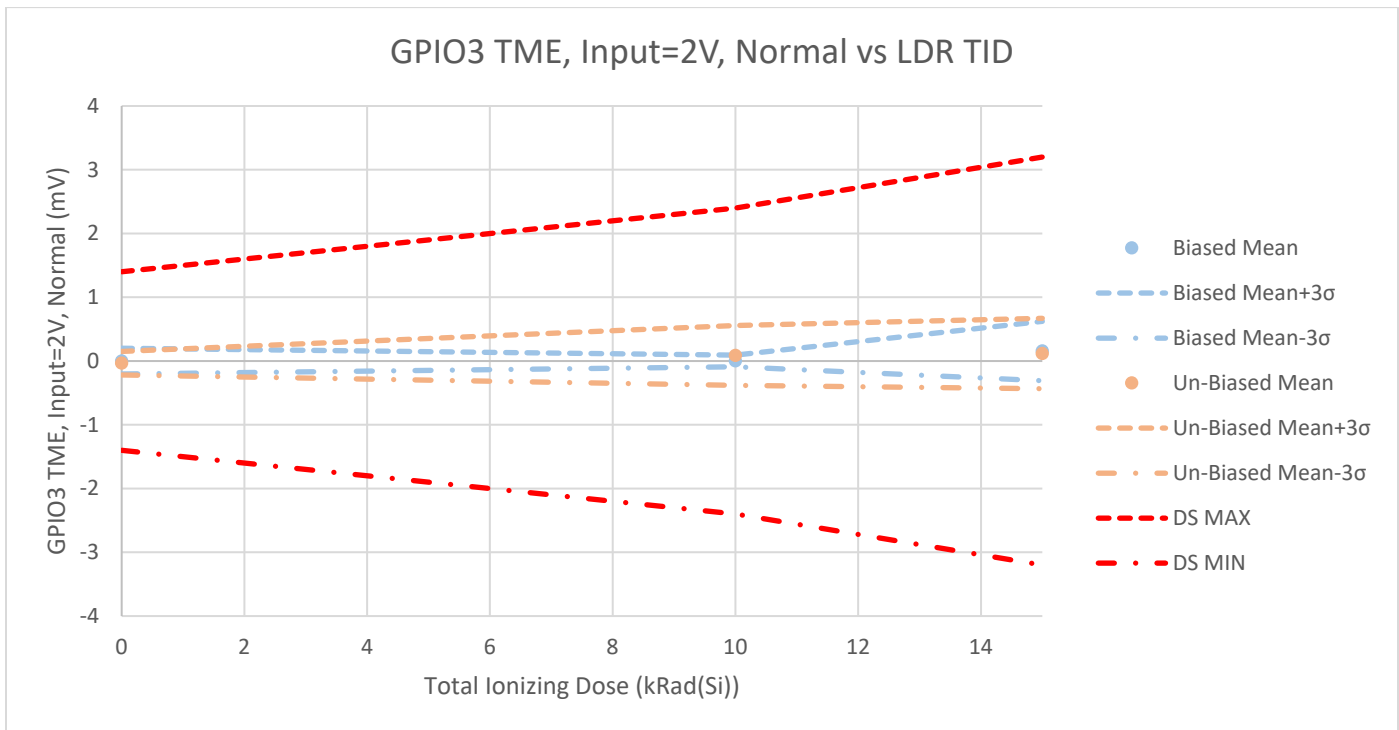

Table A-15-2. GPIO3 TME, Input=2V, Normal vs. LDR TID for the RT6804HG-1.

Total Ionizing Dose (kRad(Si))	0	10	15	Units
LDR TID Biased				
Biased Mean	-0.0014	0.0019	0.1567	mV
Std Dev	0.0673	0.0309	0.1551	
Biased Mean+3σ	0.2005	0.0945	0.6221	
Biased Mean-3σ	-0.2032	-0.0907	-0.3087	
LDR TID Un-Biased				
Un-Biased Mean	-0.0333	0.0874	0.1184	mV
Std Dev	0.0615	0.1567	0.1838	
Un-Biased Mean+3σ	0.1514	0.5575	0.6699	
Un-Biased Mean-3σ	-0.2179	-0.3827	-0.4332	
DS MIN	-1.40E+00	-2.40E+00	-3.20E+00	mV
	PASS	PASS	PASS	
DS MAX	1.40E+00	2.40E+00	3.20E+00	mV
	PASS	PASS	PASS	

Figure A-16-1. GPIO4 TME, Input=2V, Normal vs. HDR TID for the RT6804HG-1.

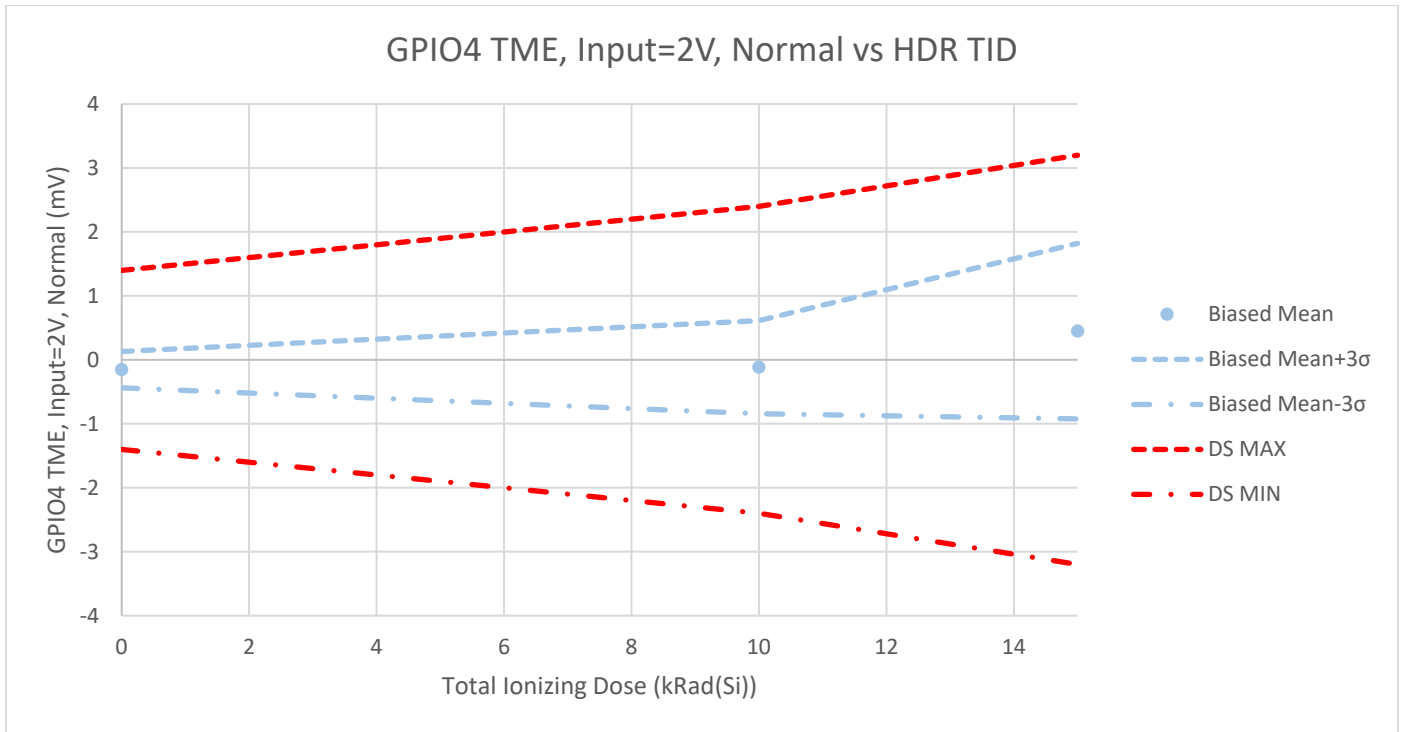

Table A-16-1. GPIO4 TME, Input=2V, Normal vs. HDR TID for the RT6804HG-1.

HDR TID Biased				
Total Ionizing Dose (kRad(Si))	0	10	15	Units
Biased Mean	-0.1526	-0.1160	0.4487	mV
Std Dev	0.0947	0.2425	0.4574	
Biased Mean+3σ	0.1314	0.6115	1.8210	
Biased Mean-3σ	-0.4366	-0.8434	-0.9236	
DS MIN	-1.40E+00	-2.40E+00	-3.20E+00	mV
	PASS	PASS	PASS	
DS MAX	1.40E+00	2.40E+00	3.20E+00	mV
	PASS	PASS	PASS	

Figure A-16-2. GPIO4 TME, Input=2V, Normal vs. LDR TID for the RT6804HG-1.

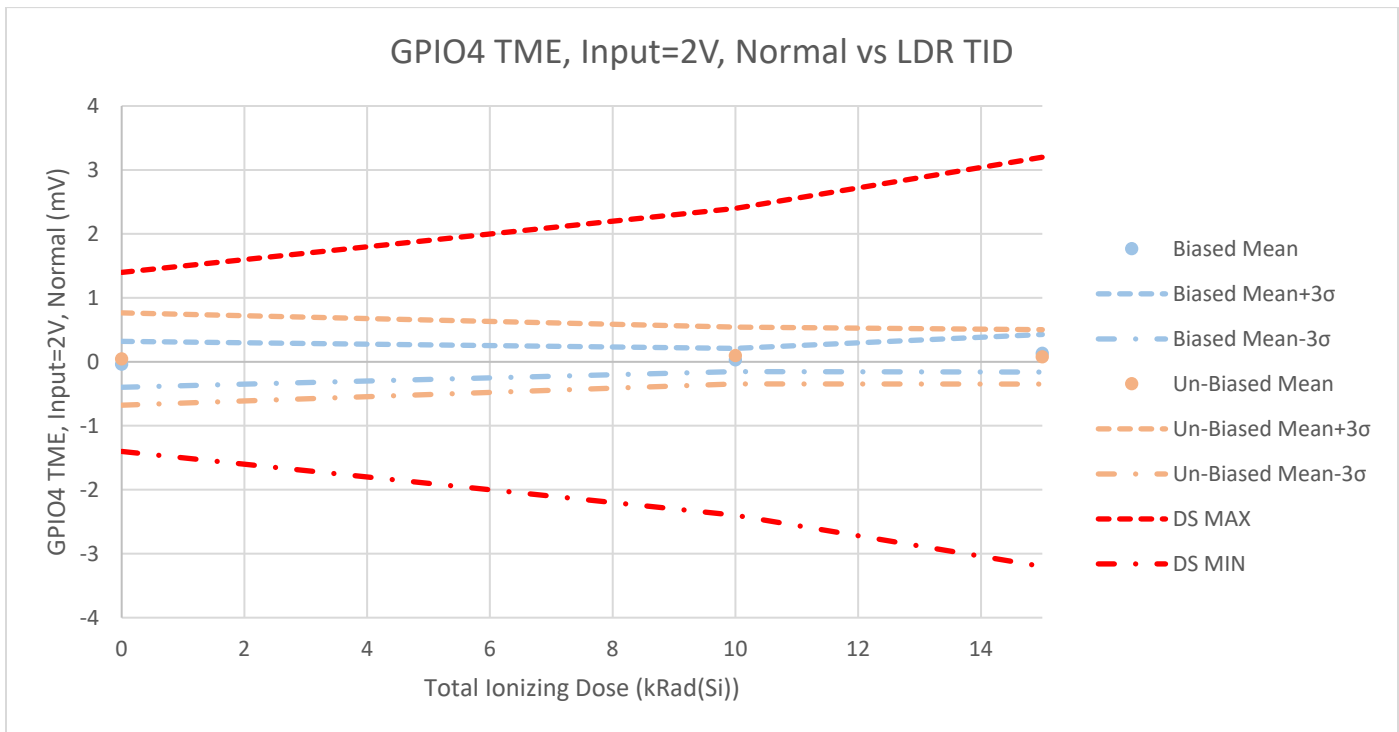

Table A-16-2. GPIO4 TME, Input=2V, Normal vs. LDR TID for the RT6804HG-1.

Total Ionizing Dose (kRad(Si))	0	10	15	Units
LDR TID Biased				
Biased Mean	-0.0383	0.0292	0.1333	mV
Std Dev	0.1197	0.0603	0.0980	
Biased Mean+3σ	0.3207	0.2101	0.4273	
Biased Mean-3σ	-0.3972	-0.1518	-0.1607	
LDR TID Un-Biased				
Un-Biased Mean	0.0443	0.0980	0.0776	mV
Std Dev	0.2409	0.1478	0.1417	
Un-Biased Mean+3σ	0.7670	0.5415	0.5027	
Un-Biased Mean-3σ	-0.6783	-0.3455	-0.3474	
DS Limits				
DS MIN	-1.40E+00	-2.40E+00	-3.20E+00	mV
	PASS	PASS	PASS	
DS MAX	1.40E+00	2.40E+00	3.20E+00	mV
	PASS	PASS	PASS	

Figure A-17-1. GPIO5 TME, Input=2V, Normal vs. HDR TID for the RT6804HG-1.

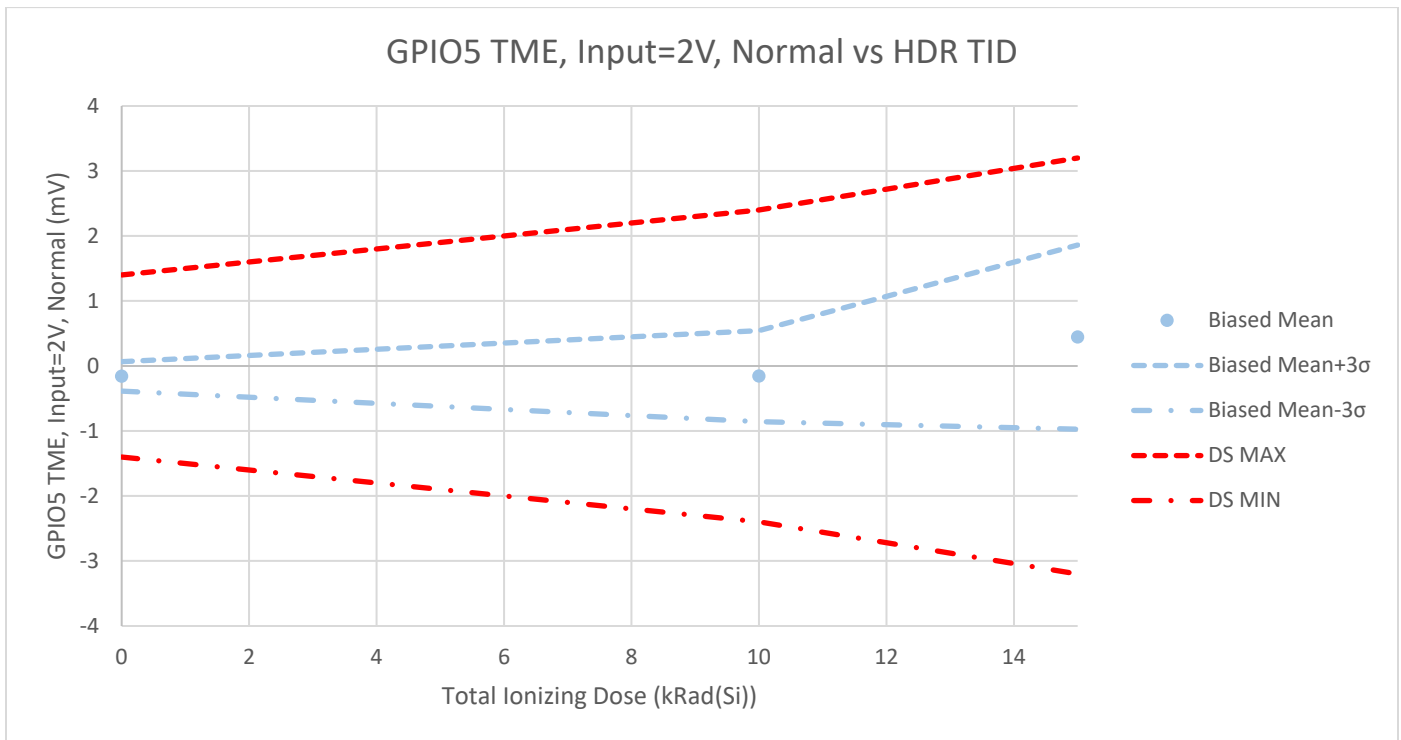

Table A-17-1. GPIO5 TME, Input=2V, Normal vs. HDR TID for the RT6804HG-1.

HDR TID Biased				
Total Ionizing Dose (kRad(Si))	0	10	15	Units
Biased Mean	-0.1590	-0.1570	0.4449	mV
Std Dev	0.0754	0.2334	0.4721	
Biased Mean+3σ	0.0672	0.5431	1.8613	
Biased Mean-3σ	-0.3852	-0.8571	-0.9714	
DS MIN	-1.40E+00	-2.40E+00	-3.20E+00	mV
	PASS	PASS	PASS	
DS MAX	1.40E+00	2.40E+00	3.20E+00	mV
	PASS	PASS	PASS	

Figure A-17-2. GPIO5 TME, Input=2V, Normal vs. LDR TID for the RT6804HG-1.

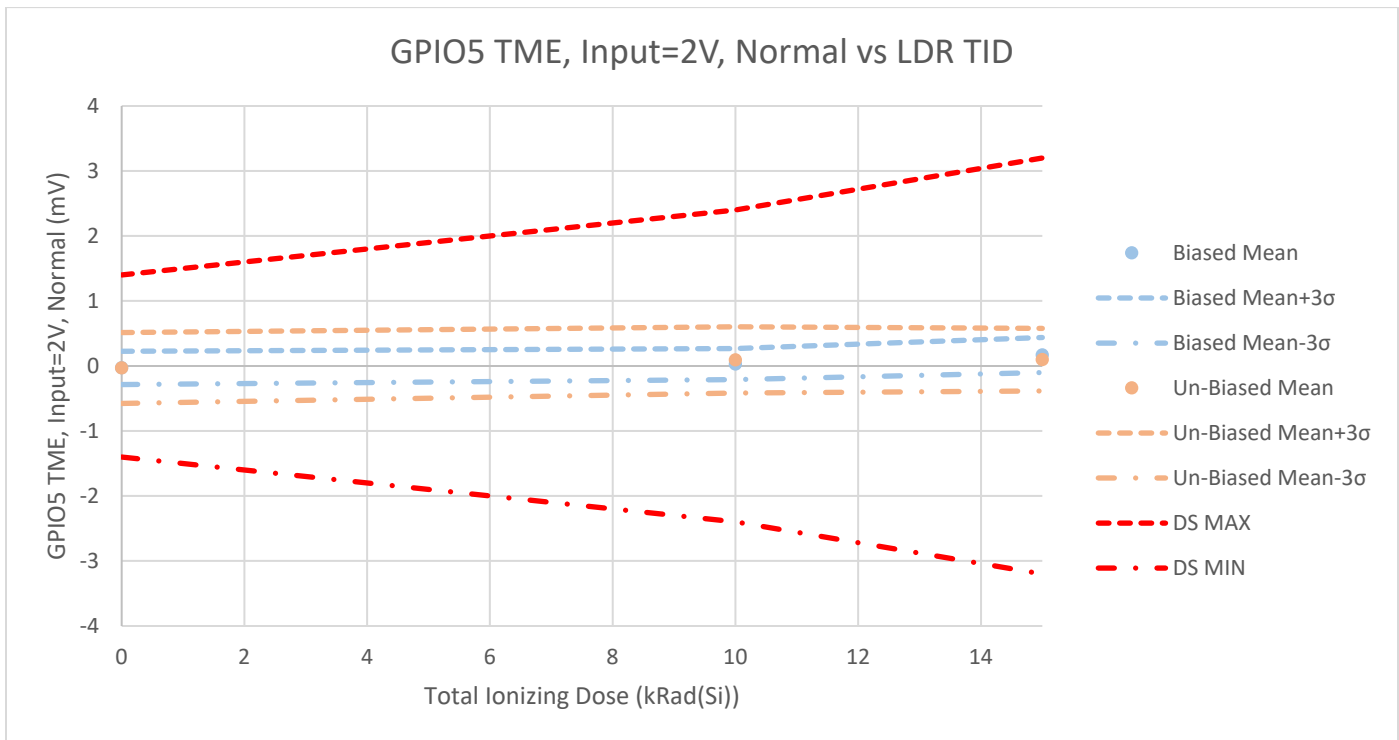

Table A-17-2. GPIO5 TME, Input=2V, Normal vs. LDR TID for the RT6804HG-1.

Total Ionizing Dose (kRad(Si))	0	10	15	Units
LDR TID Biased				
Biased Mean	-0.0292	0.0293	0.1682	mV
Std Dev	0.0851	0.0795	0.0900	
Biased Mean+3σ	0.2261	0.2680	0.4384	
Biased Mean-3σ	-0.2845	-0.2093	-0.1019	
LDR TID Un-Biased				
Un-Biased Mean	-0.0310	0.0936	0.0970	mV
Std Dev	0.1820	0.1703	0.1601	
Un-Biased Mean+3σ	0.5151	0.6044	0.5774	
Un-Biased Mean-3σ	-0.5770	-0.4172	-0.3834	
DS Limits				
DS MIN	-1.40E+00	-2.40E+00	-3.20E+00	mV
	PASS	PASS	PASS	
DS MAX	1.40E+00	2.40E+00	3.20E+00	mV
	PASS	PASS	PASS	

Figure A-18-1. Cell 1 TME, Input = 3.3V, Normal vs. HDR TID for the RT6804HG-1.

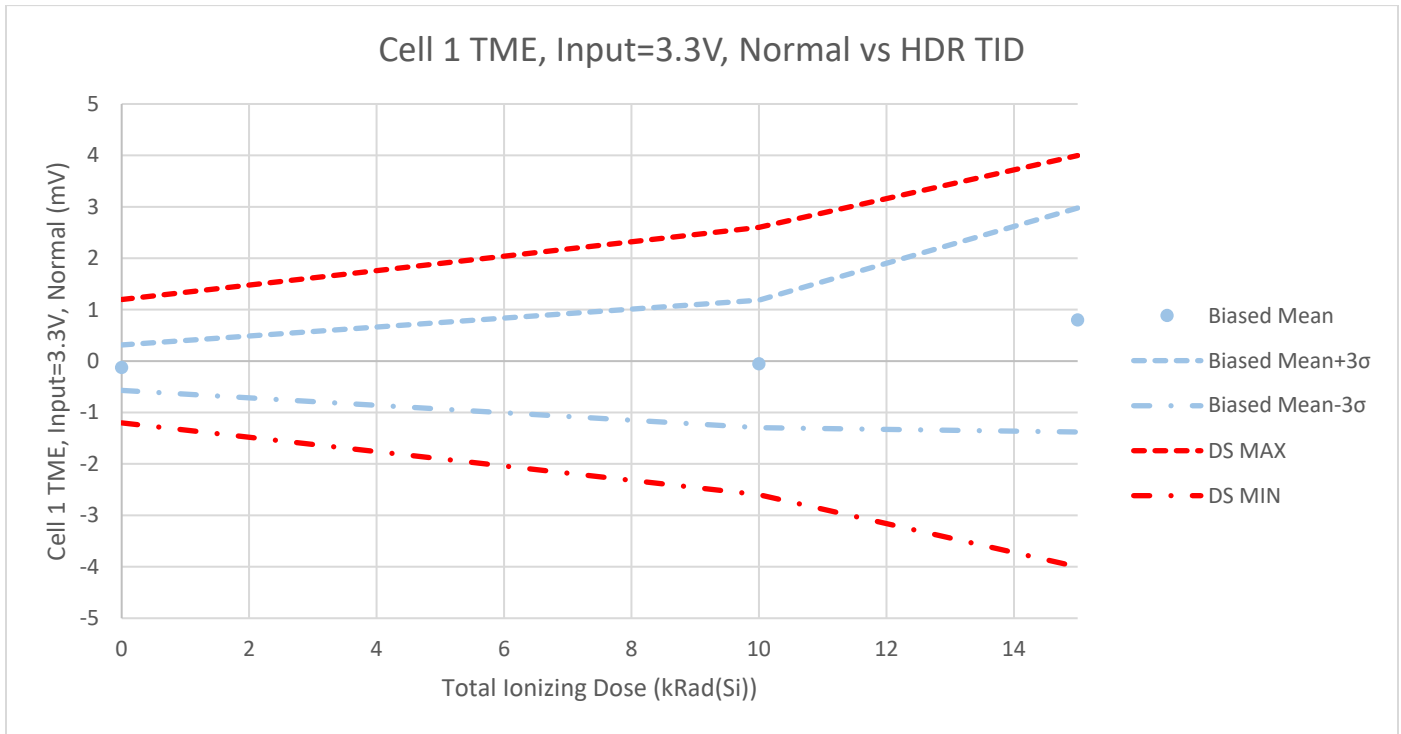

Table A-18-1. Cell 1 TME, Input = 3.3V, Normal vs. HDR TID for the RT6804HG-1.

HDR TID Biased				
Total Ionizing Dose (kRad(Si))	0	10	15	Units
Biased Mean	-0.1268	-0.0549	0.7997	mV
Std Dev	0.1474	0.4133	0.7262	
Biased Mean+3σ	0.3155	1.1851	2.9781	
Biased Mean-3σ	-0.5691	-1.2949	-1.3788	
DS MIN	-1.20E+00	-2.60E+00	-4.00E+00	mV
	PASS	PASS	PASS	
DS MAX	1.20E+00	2.60E+00	4.00E+00	mV
	PASS	PASS	PASS	

Figure A-18-2. Cell 1 TME, Input = 3.3V, Normal vs. LDR TID for the RT6804HG-1.

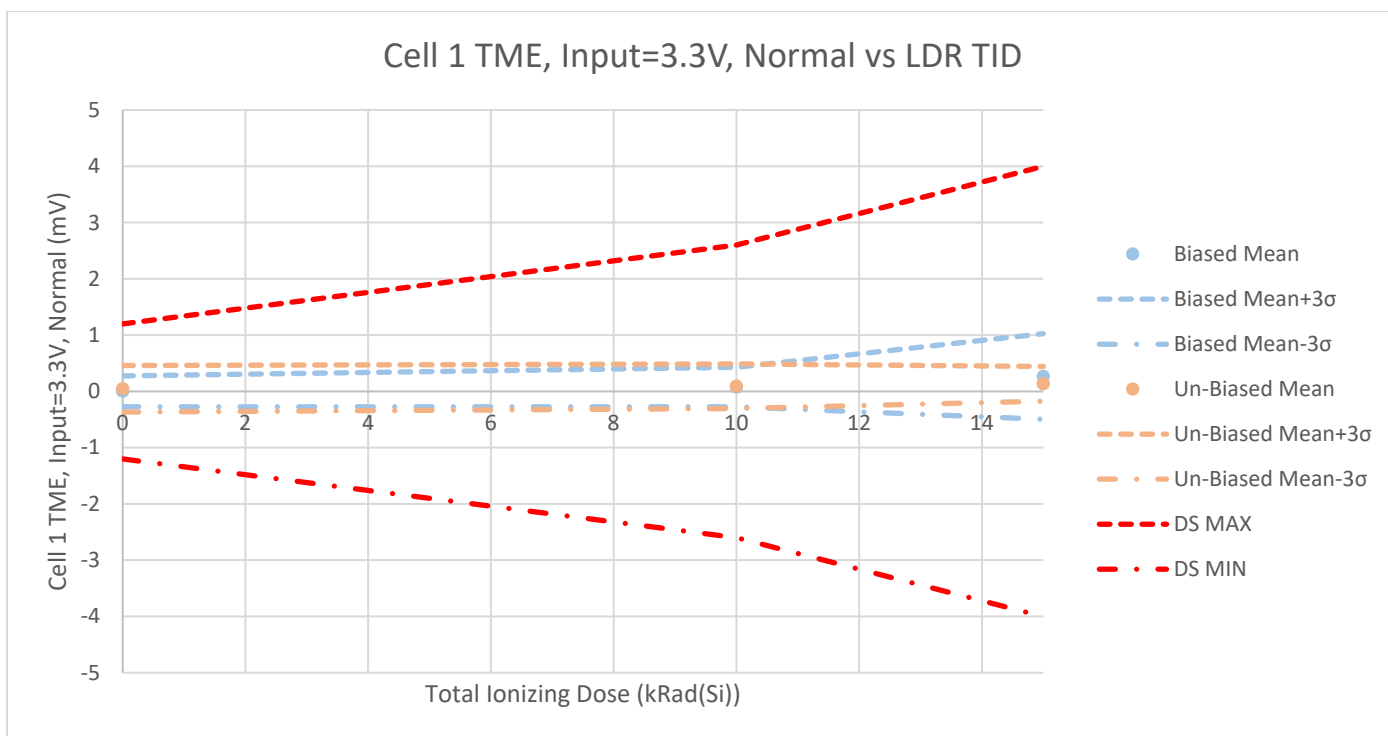

Table A-18-2. Cell 1 TME, Input = 3.3V, Normal vs. LDR TID for the RT6804HG-1.

Total Ionizing Dose (kRad(Si))	0	10	15	Units
LDR TID Biased				
Biased Mean	0.0011	0.0762	0.2654	mV
Std Dev	0.0914	0.1167	0.2533	
Biased Mean+3σ	0.2752	0.4262	1.0253	
Biased Mean-3σ	-0.2729	-0.2738	-0.4945	
LDR TID Un-Biased				
Un-Biased Mean	0.0466	0.0909	0.1354	mV
Std Dev	0.1378	0.1326	0.1029	
Un-Biased Mean+3σ	0.4601	0.4885	0.4440	
Un-Biased Mean-3σ	-0.3668	-0.3068	-0.1732	
DS MIN	-1.20E+00	-2.60E+00	-4.00E+00	mV
	PASS	PASS	PASS	
DS MAX	1.20E+00	2.60E+00	4.00E+00	mV
	PASS	PASS	PASS	

Figure A-19-1. Cell 2 TME, Input = 3.3V, Normal vs. HDR TID for the RT6804HG-1.

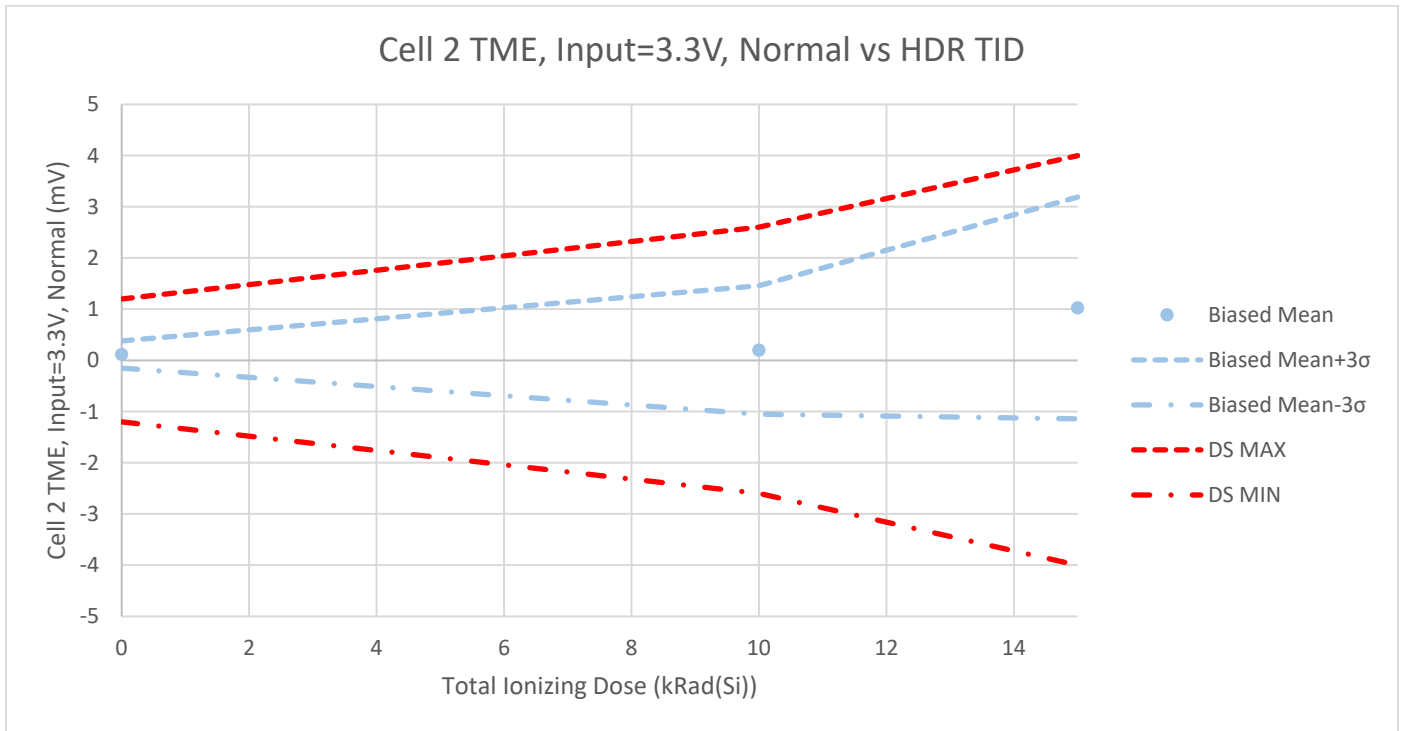

Table A-19-1. Cell 2 TME, Input = 3.3V, Normal vs. HDR TID for the RT6804HG-1.

HDR TID Biased				
Total Ionizing Dose (kRad(Si))	0	10	15	Units
Biased Mean	0.1154	0.2023	1.0246	mV
Std Dev	0.0882	0.4179	0.7222	
Biased Mean+3σ	0.3800	1.4560	3.1913	
Biased Mean-3σ	-0.1491	-1.0513	-1.1420	
DS MIN	-1.20E+00	-2.60E+00	-4.00E+00	mV
	PASS	PASS	PASS	
DS MAX	1.20E+00	2.60E+00	4.00E+00	mV
	PASS	PASS	PASS	

Figure A-19-2. Cell 2 TME, Input = 3.3V, Normal vs. LDR TID for the RT6804HG-1.

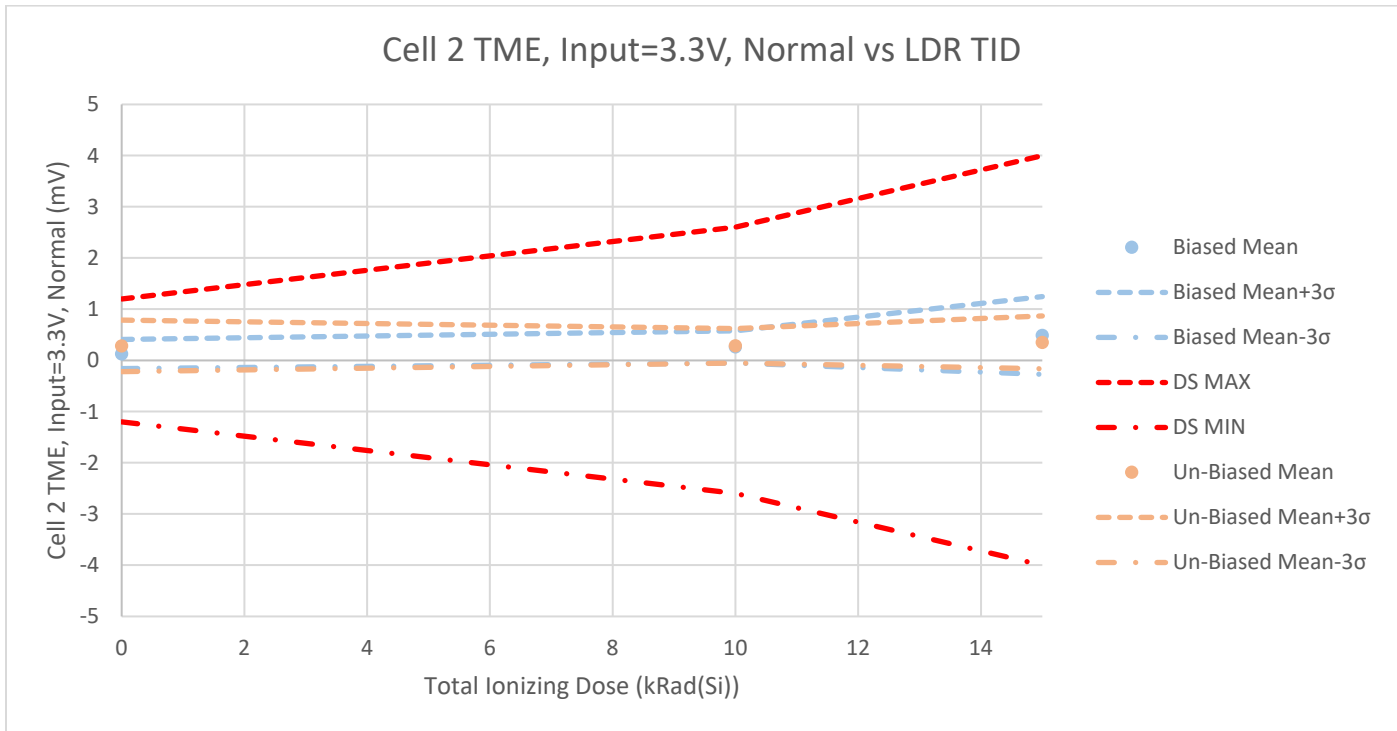

Table A-19-2. Cell 2 TME, Input = 3.3V, Normal vs. LDR TID for the RT6804HG-1.

Total Ionizing Dose (kRad(Si))	0	10	15	Units
LDR TID Biased				
Biased Mean	0.1252	0.2626	0.4874	mV
Std Dev	0.0950	0.1040	0.2529	
Biased Mean+3σ	0.4103	0.5747	1.2462	
Biased Mean-3σ	-0.1599	-0.0495	-0.2713	
LDR TID Un-Biased				
Un-Biased Mean	0.2834	0.2859	0.3518	mV
Std Dev	0.1673	0.1117	0.1720	
Un-Biased Mean+3σ	0.7853	0.6211	0.8679	
Un-Biased Mean-3σ	-0.2185	-0.0492	-0.1642	
DS MIN	-1.20E+00	-2.60E+00	-4.00E+00	mV
	PASS	PASS	PASS	
DS MAX	1.20E+00	2.60E+00	4.00E+00	mV
	PASS	PASS	PASS	

Figure A-20-1. Cell 3 TME, Input = 3.3V, Normal vs. HDR TID for the RT6804HG-1.

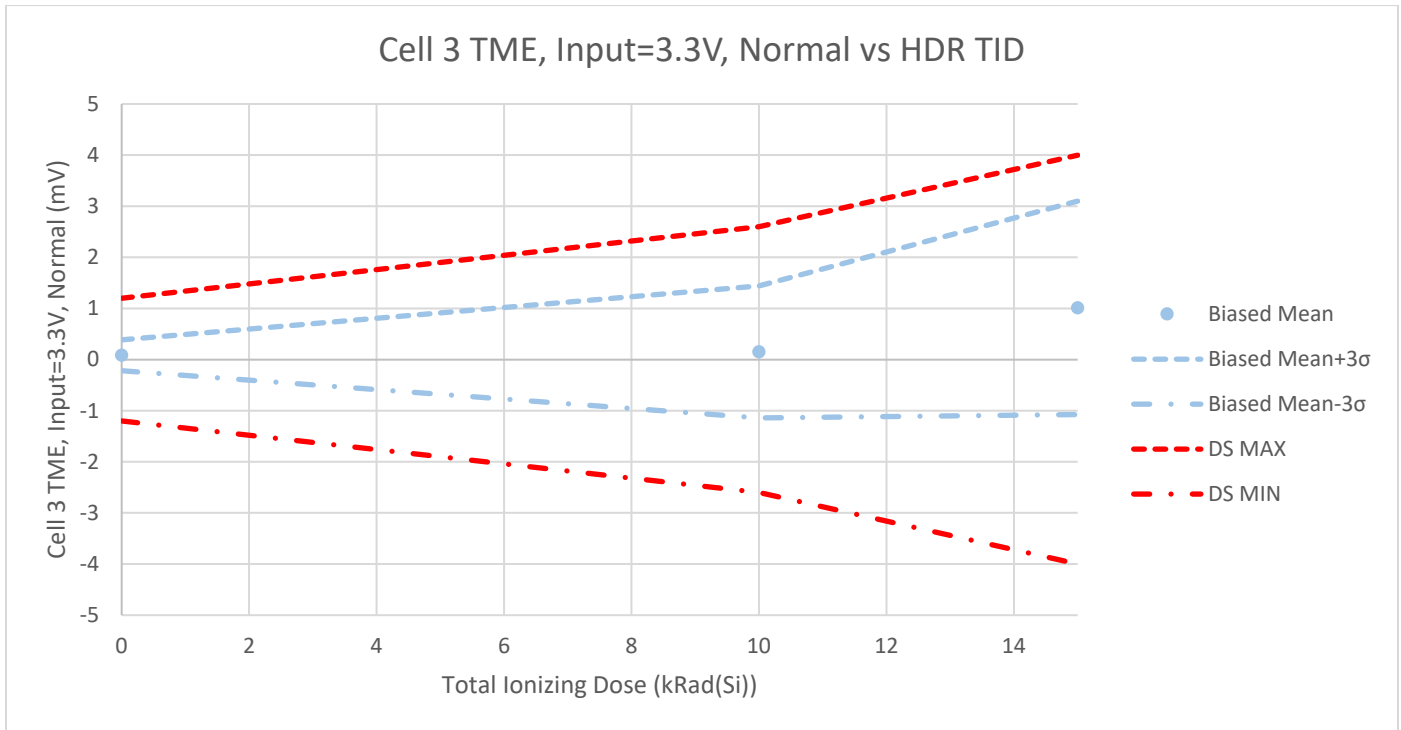

Table A-20-1. Cell 3 TME, Input = 3.3V, Normal vs. HDR TID for the RT6804HG-1.

HDR TID Biased				
Total Ionizing Dose (kRad(Si))	0	10	15	Units
Biased Mean	0.0846	0.1501	1.0121	mV
Std Dev	0.1006	0.4305	0.6963	
Biased Mean+3σ	0.3865	1.4415	3.1009	
Biased Mean-3σ	-0.2174	-1.1412	-1.0767	
DS MIN	-1.20E+00	-2.60E+00	-4.00E+00	mV
	PASS	PASS	PASS	
DS MAX	1.20E+00	2.60E+00	4.00E+00	mV
	PASS	PASS	PASS	

Figure A-20-2. Cell 3 TME, Input = 3.3V, Normal vs. LDR TID for the RT6804HG-1.

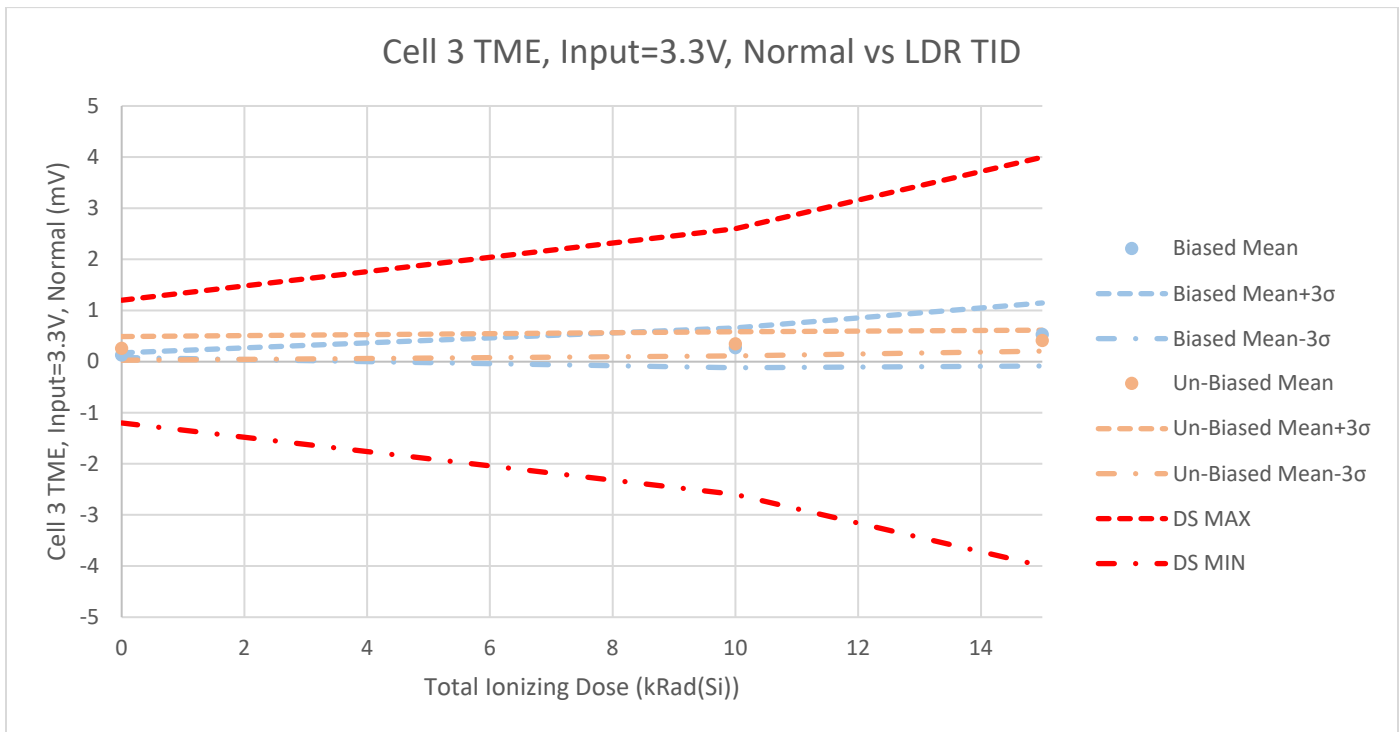

Table A-20-2. Cell 3 TME, Input = 3.3V, Normal vs. LDR TID for the RT6804HG-1.

Total Ionizing Dose (kRad(Si))	0	10	15	Units
LDR TID Biased				
Biased Mean	0.1258	0.2688	0.5298	mV
Std Dev	0.0154	0.1299	0.2061	
Biased Mean+3σ	0.1720	0.6585	1.1479	
Biased Mean-3σ	0.0797	-0.1208	-0.0884	
LDR TID Un-Biased				
Un-Biased Mean	0.2577	0.3463	0.4094	mV
Std Dev	0.0774	0.0792	0.0682	
Un-Biased Mean+3σ	0.4900	0.5840	0.6139	
Un-Biased Mean-3σ	0.0255	0.1086	0.2048	
DS MIN	-1.20E+00	-2.60E+00	-4.00E+00	mV
	PASS	PASS	PASS	
DS MAX	1.20E+00	2.60E+00	4.00E+00	mV
	PASS	PASS	PASS	

Figure A-21-1. Cell 4 TME, Input = 3.3V, Normal vs. HDR TID for the RT6804HG-1.

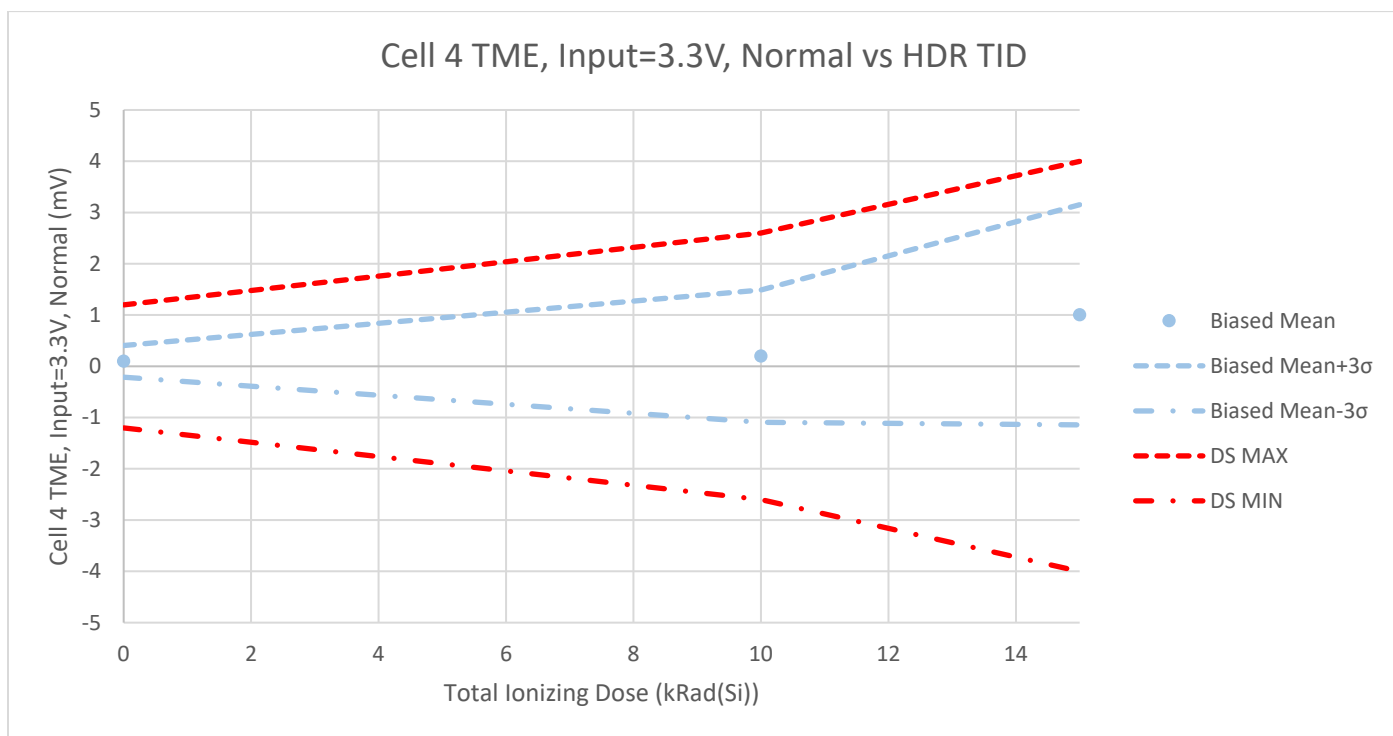

Table A-21-1. Cell 4 TME, Input = 3.3V, Normal vs. HDR TID for the RT6804HG-1.

HDR TID Biased				
Total Ionizing Dose (kRad(Si))	0	10	15	Units
Biased Mean	0.0976	0.1983	1.0049	mV
Std Dev	0.1035	0.4303	0.7161	
Biased Mean+3σ	0.4079	1.4892	3.1533	
Biased Mean-3σ	-0.2128	-1.0927	-1.1435	
DS MIN	-1.20E+00	-2.60E+00	-4.00E+00	mV
	PASS	PASS	PASS	
DS MAX	1.20E+00	2.60E+00	4.00E+00	mV
	PASS	PASS	PASS	

Figure A-21-2. Cell 4 TME, Input = 3.3V, Normal vs. LDR TID for the RT6804HG-1.

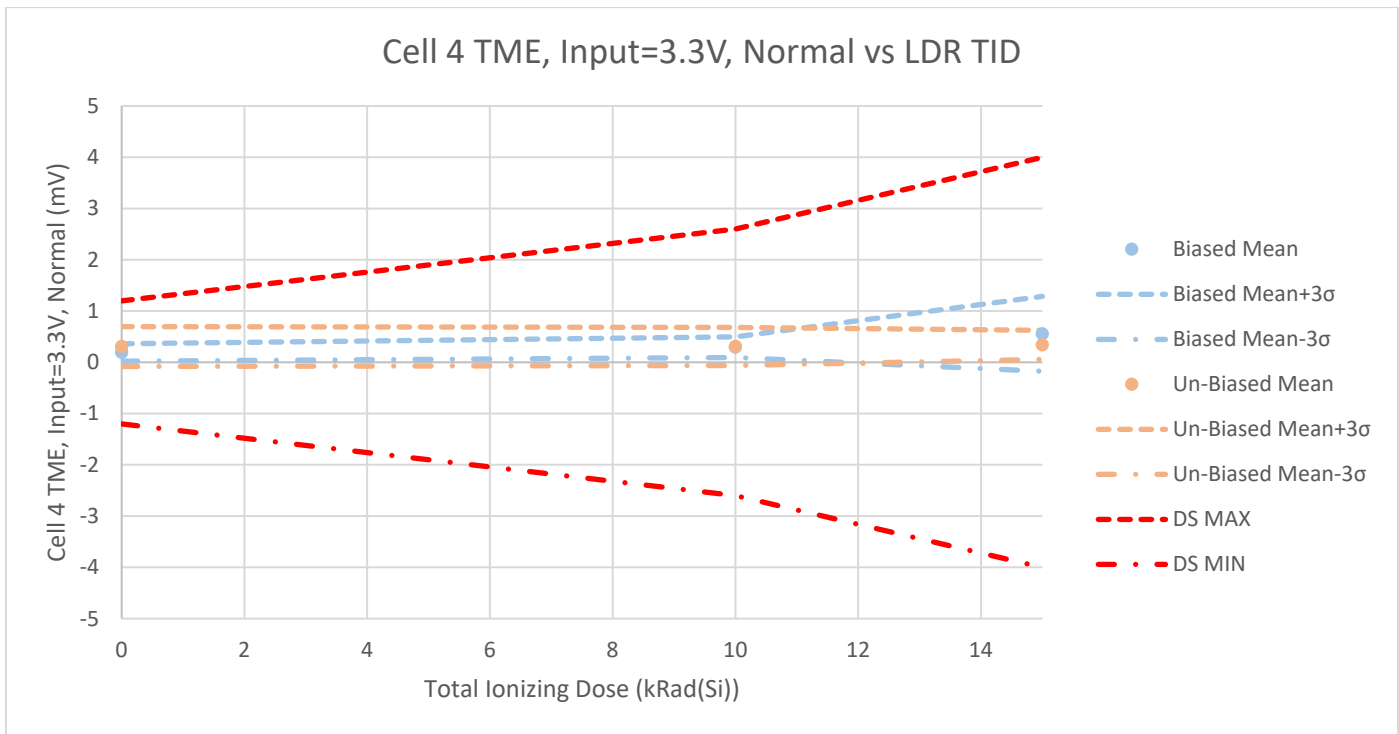

Table A-21-2. Cell 4 TME, Input = 3.3V, Normal vs. LDR TID for the RT6804HG-1.

Total Ionizing Dose (kRad(Si))	0	10	15	Units
LDR TID Biased				
Biased Mean	0.1921	0.2949	0.5556	mV
Std Dev	0.0571	0.0672	0.2433	
Biased Mean+3σ	0.3635	0.4965	1.2856	
Biased Mean-3σ	0.0206	0.0933	-0.1744	
LDR TID Un-Biased				
Un-Biased Mean	0.3071	0.3092	0.3406	mV
Std Dev	0.1293	0.1239	0.0947	
Un-Biased Mean+3σ	0.6952	0.6810	0.6246	
Un-Biased Mean-3σ	-0.0809	-0.0626	0.0566	
DS MIN	-1.20E+00	-2.60E+00	-4.00E+00	mV
	PASS	PASS	PASS	
DS MAX	1.20E+00	2.60E+00	4.00E+00	mV
	PASS	PASS	PASS	

Figure A-22-1. Cell 5 TME, Input = 3.3V, Normal vs. HDR TID for the RT6804HG-1.

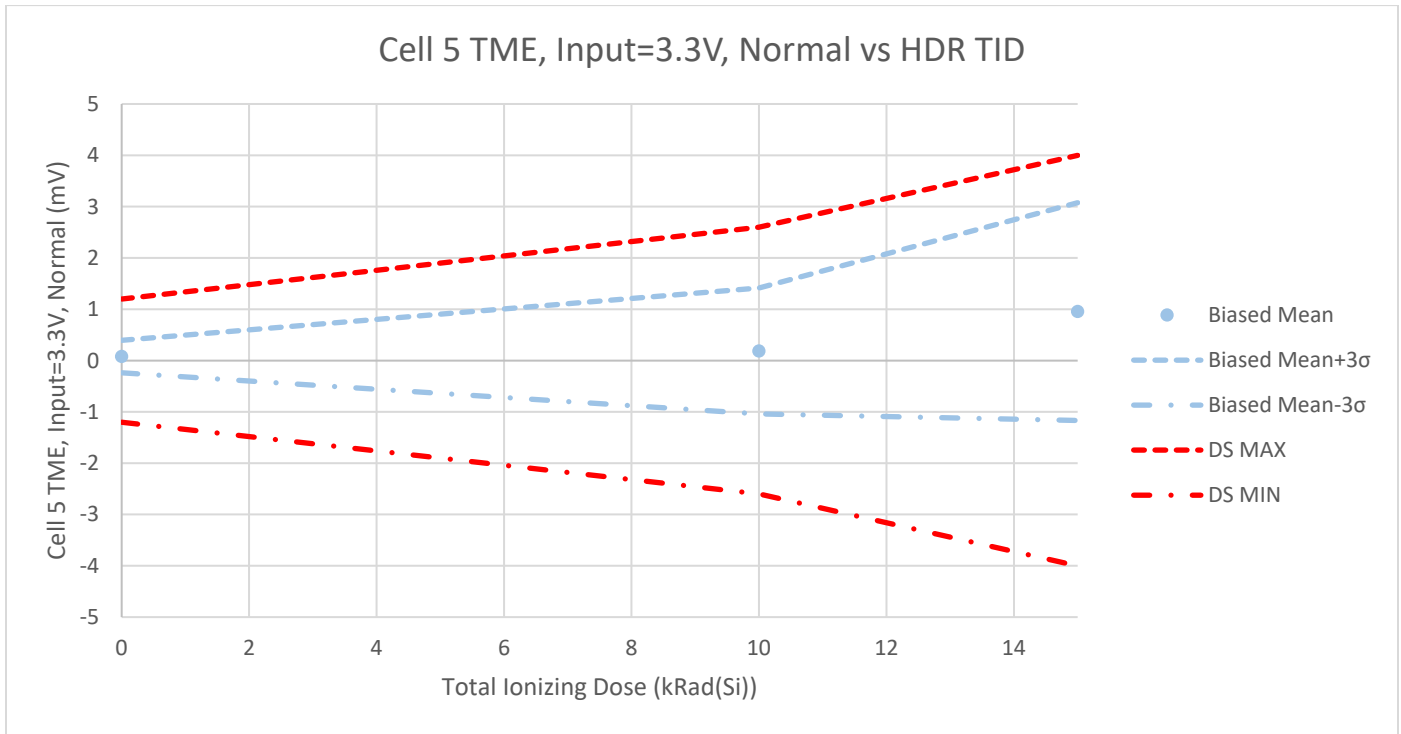

Table A-22-1. Cell 5 TME, Input = 3.3V, Normal vs. HDR TID for the RT6804HG-1.

HDR TID Biased				
Total Ionizing Dose (kRad(Si))	0	10	15	Units
Biased Mean	0.0789	0.1862	0.9560	mV
Std Dev	0.1052	0.4087	0.7077	
Biased Mean+3σ	0.3946	1.4124	3.0789	
Biased Mean-3σ	-0.2368	-1.0400	-1.1670	
DS MIN	-1.20E+00	-2.60E+00	-4.00E+00	mV
	PASS	PASS	PASS	
DS MAX	1.20E+00	2.60E+00	4.00E+00	mV
	PASS	PASS	PASS	

Figure A-22-2. Cell 5 TME, Input = 3.3V, Normal vs. LDR TID for the RT6804HG-1.

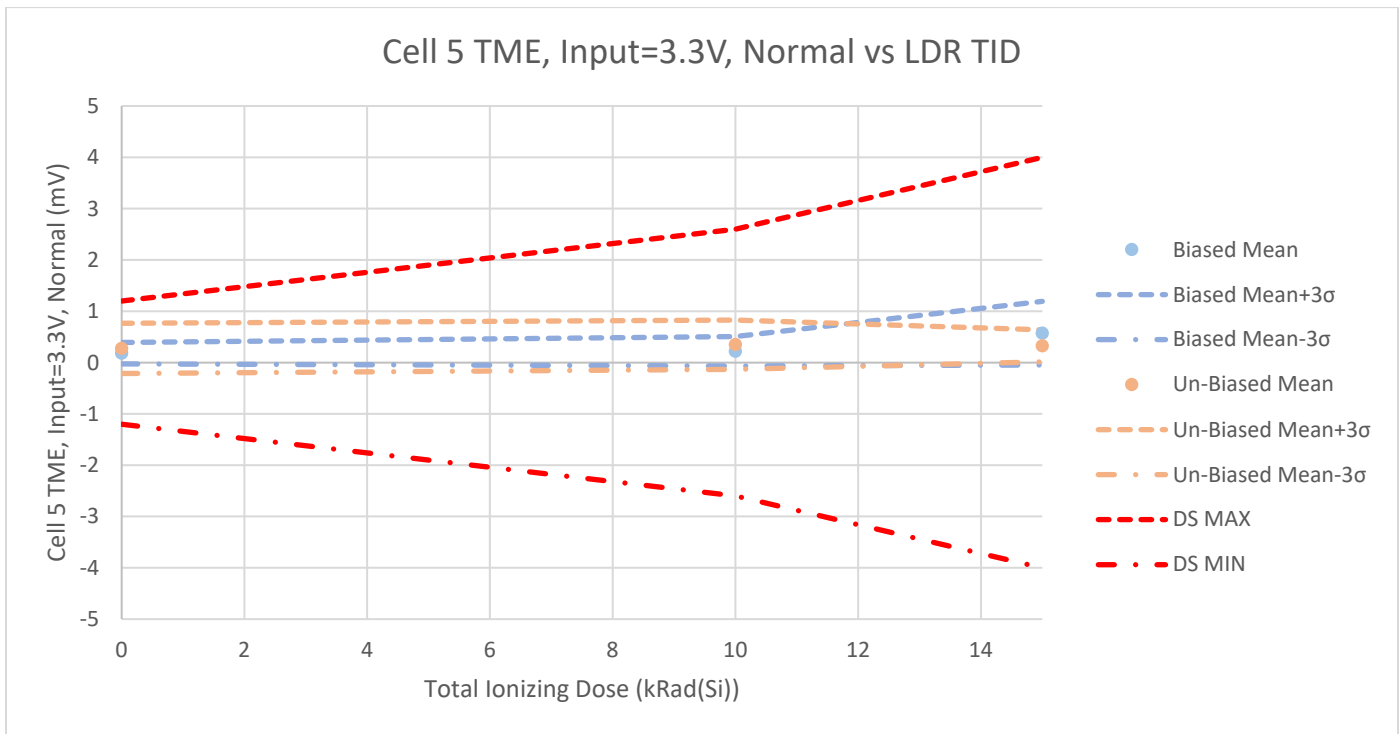

Table A-22-2. Cell 5 TME, Input = 3.3V, Normal vs. LDR TID for the RT6804HG-1.

Total Ionizing Dose (kRad(Si))	0	10	15	Units
LDR TID Biased				
Biased Mean	0.1833	0.2207	0.5728	mV
Std Dev	0.0695	0.0953	0.2073	
Biased Mean+3σ	0.3918	0.5067	1.1948	
Biased Mean-3σ	-0.0252	-0.0653	-0.0493	
LDR TID Un-Biased				
Un-Biased Mean	0.2765	0.3492	0.3263	mV
Std Dev	0.1630	0.1603	0.1038	
Un-Biased Mean+3σ	0.7654	0.8300	0.6378	
Un-Biased Mean-3σ	-0.2124	-0.1316	0.0148	
DS MIN	-1.20E+00	-2.60E+00	-4.00E+00	mV
	PASS	PASS	PASS	
DS MAX	1.20E+00	2.60E+00	4.00E+00	mV
	PASS	PASS	PASS	

Figure A-23-1. Cell 6 TME, Input = 3.3V, Normal vs. HDR TID for the RT6804HG-1.

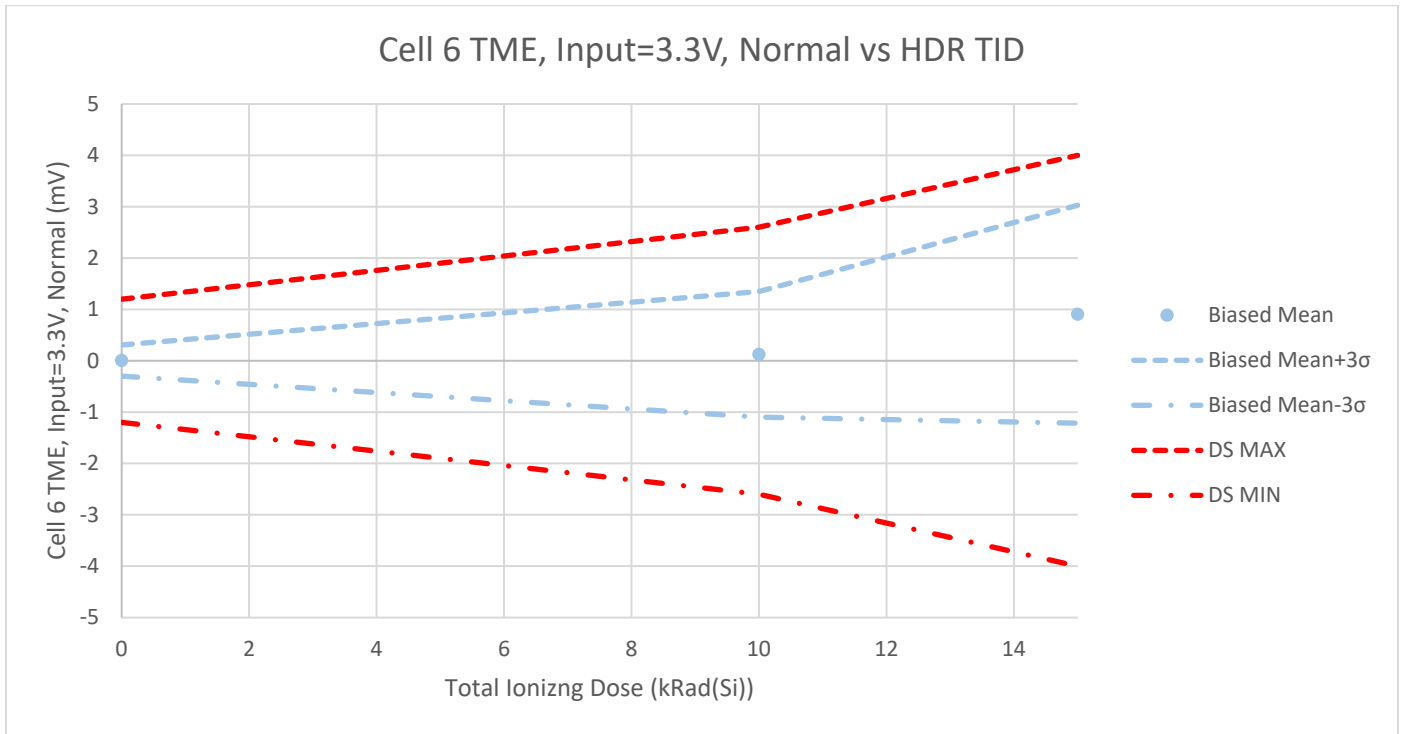

Table A-23-1. Cell 6 TME, Input = 3.3V, Normal vs. HDR TID for the RT6804HG-1.

HDR TID Biased				
Total Ionizing Dose (kRad(Si))	0	10	15	Units
Biased Mean	0.0046	0.1249	0.9062	mV
Std Dev	0.1012	0.4074	0.7072	
Biased Mean+3σ	0.3083	1.3471	3.0278	
Biased Mean-3σ	-0.2992	-1.0974	-1.2153	
DS MIN	-1.20E+00	-2.60E+00	-4.00E+00	mV
	PASS	PASS	PASS	
DS MAX	1.20E+00	2.60E+00	4.00E+00	mV
	PASS	PASS	PASS	

Figure A-23-2. Cell 6 TME, Input = 3.3V, Normal vs. LDR TID for the RT6804HG-1.

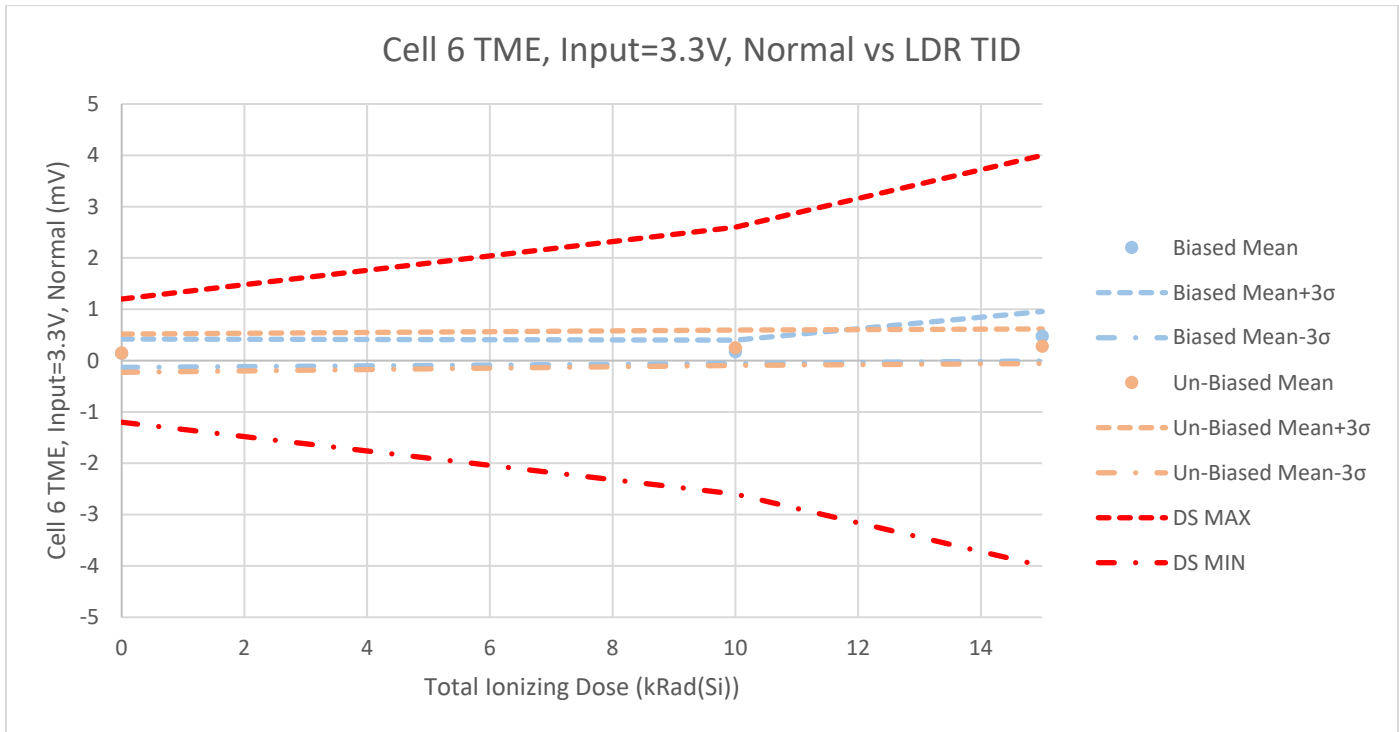

Table A-23-2. Cell 6 TME, Input = 3.3V, Normal vs. LDR TID for the RT6804HG-1.

Total Ionizing Dose (kRad(Si))	0	10	15	Units
LDR TID Biased				
Biased Mean	0.1436	0.1706	0.4760	mV
Std Dev	0.0917	0.0761	0.1609	
Biased Mean+3σ	0.4189	0.3990	0.9586	
Biased Mean-3σ	-0.1316	-0.0577	-0.0065	
LDR TID Un-Biased				
Un-Biased Mean	0.1465	0.2499	0.2813	mV
Std Dev	0.1241	0.1150	0.1126	
Un-Biased Mean+3σ	0.5187	0.5950	0.6190	
Un-Biased Mean-3σ	-0.2257	-0.0952	-0.0565	
DS MIN	-1.20E+00	-2.60E+00	-4.00E+00	mV
	PASS	PASS	PASS	
DS MAX	1.20E+00	2.60E+00	4.00E+00	mV
	PASS	PASS	PASS	

Figure A-24-1. Cell 7 TME, Input = 3.3V, Normal vs. HDR TID for the RT6804HG-1.

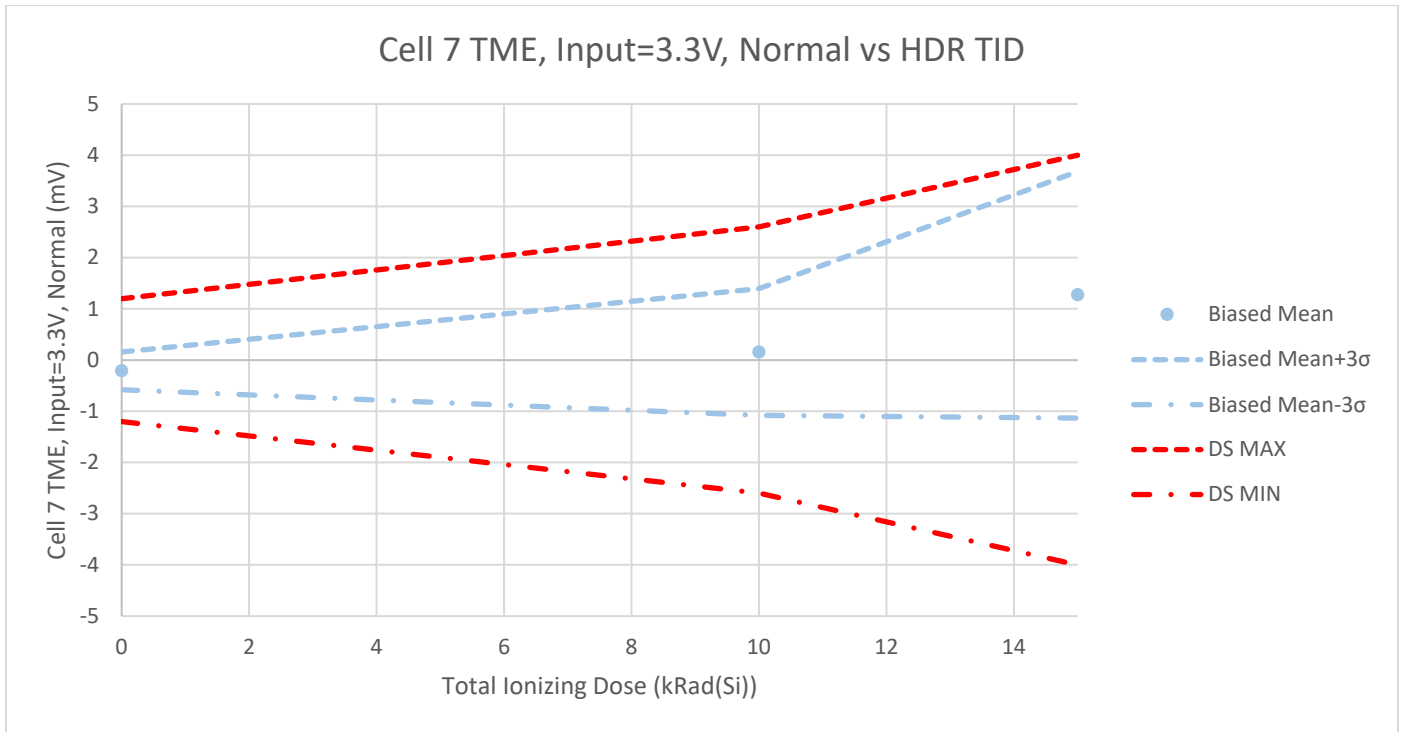

Table A-24-1. Cell 7 TME, Input = 3.3V, Normal vs. HDR TID for the RT6804HG-1.

HDR TID Biased				
Total Ionizing Dose (kRad(Si))	0	10	15	Units
Biased Mean	-0.2098	0.1563	1.2756	mV
Std Dev	0.1230	0.4129	0.8028	
Biased Mean+3σ	0.1592	1.3949	3.6840	
Biased Mean-3σ	-0.5788	-1.0823	-1.1327	
DS MIN	-1.20E+00	-2.60E+00	-4.00E+00	mV
	PASS	PASS	PASS	
DS MAX	1.20E+00	2.60E+00	4.00E+00	mV
	PASS	PASS	PASS	

Figure A-24-2. Cell 7 TME, Input = 3.3V, Normal vs. LDR TID for the RT6804HG-1.

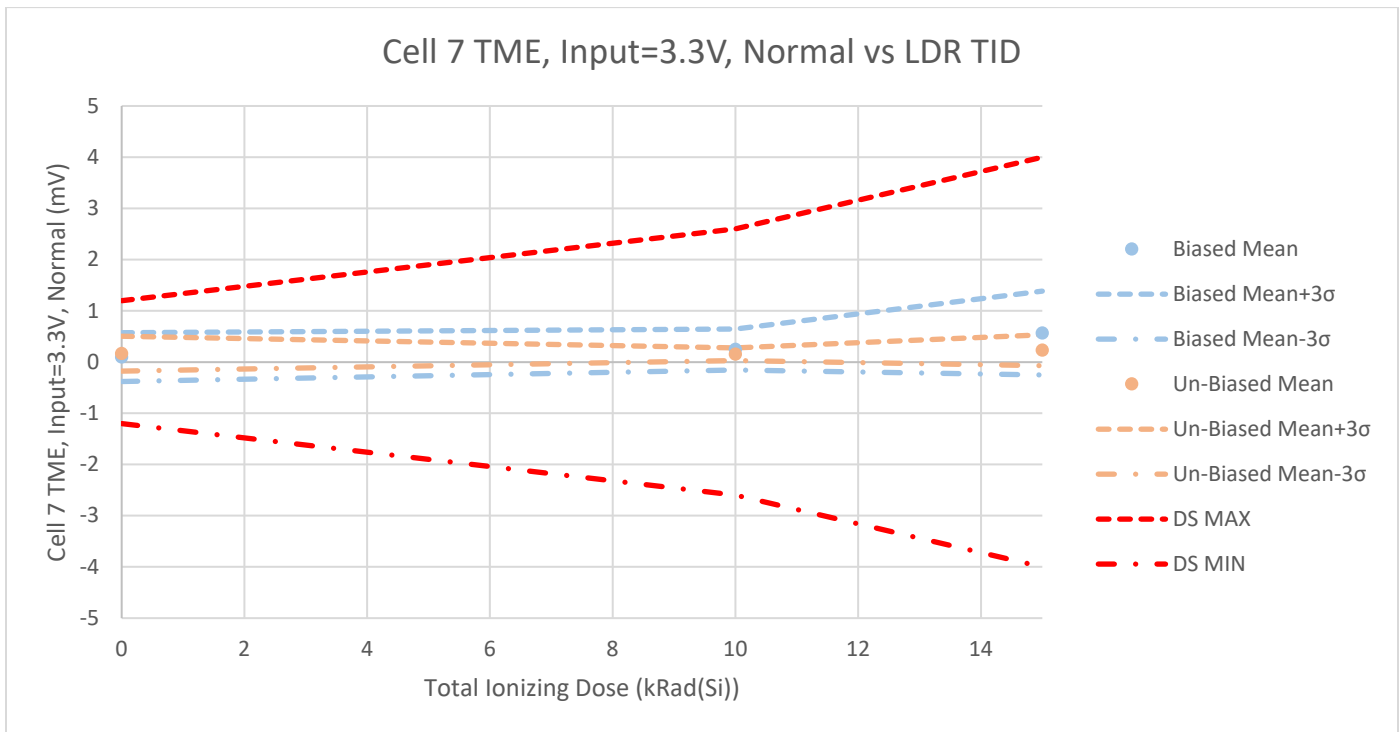

Table A-24-2. Cell 7 TME, Input = 3.3V, Normal vs. LDR TID for the RT6804HG-1.

Total Ionizing Dose (kRad(Si))	0	10	15	Units
LDR TID Biased				
Biased Mean	0.0978	0.2455	0.5669	mV
Std Dev	0.1587	0.1330	0.2734	
Biased Mean+3σ	0.5740	0.6446	1.3872	
Biased Mean-3σ	-0.3784	-0.1536	-0.2534	
LDR TID Un-Biased				
Un-Biased Mean	0.1644	0.1535	0.2303	mV
Std Dev	0.1133	0.0415	0.1006	
Un-Biased Mean+3σ	0.5044	0.2779	0.5323	
Un-Biased Mean-3σ	-0.1756	0.0291	-0.0716	
DS Limits				
DS MIN	-1.20E+00	-2.60E+00	-4.00E+00	mV
	PASS	PASS	PASS	
DS MAX	1.20E+00	2.60E+00	4.00E+00	mV
	PASS	PASS	PASS	

Figure A-25-1. Cell 8 TME, Input = 3.3V, Normal vs. HDR TID for the RT6804HG-1.

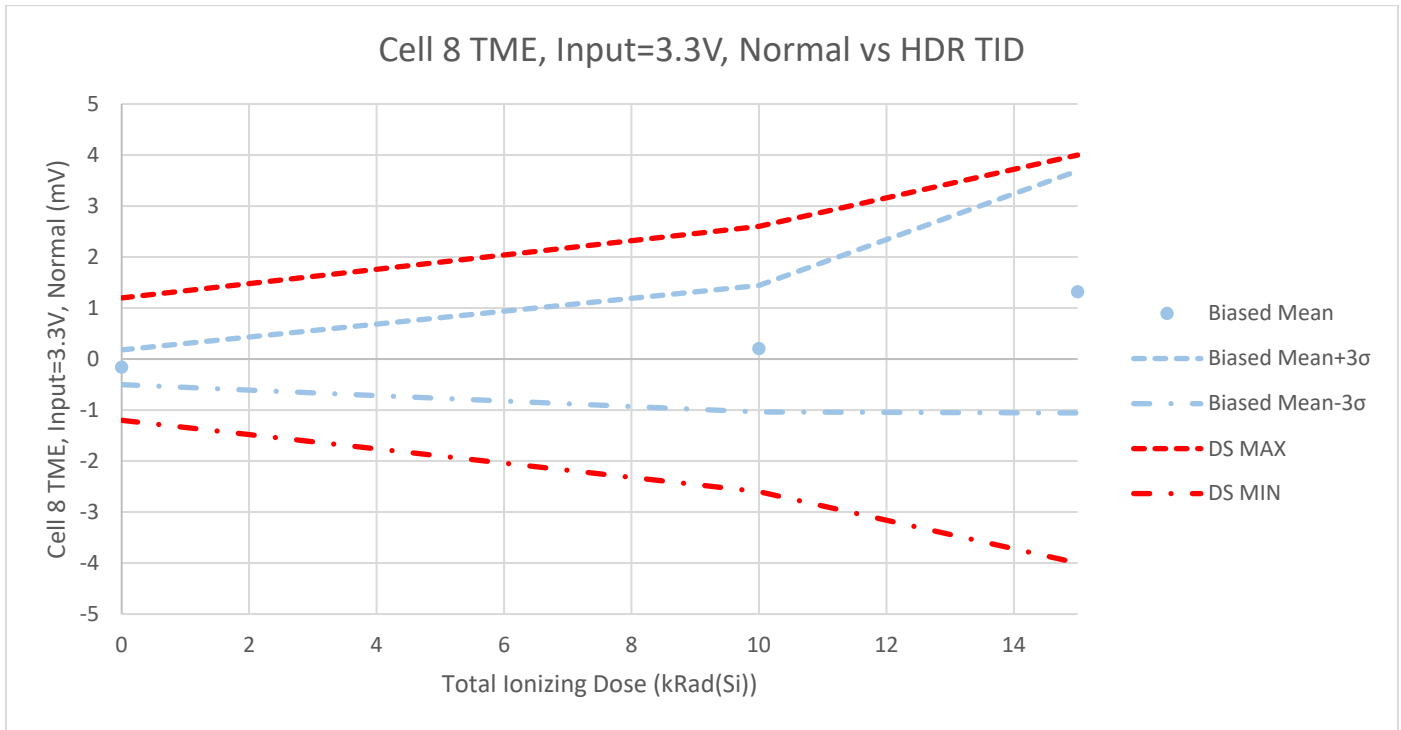

Table A-25-1. Cell 8 TME, Input = 3.3V, Normal vs. HDR TID for the RT6804HG-1.

HDR TID Biased				
Total Ionizing Dose (kRad(Si))	0	10	15	Units
Biased Mean	-0.1595	0.2022	1.3163	mV
Std Dev	0.1134	0.4135	0.7910	
Biased Mean+3σ	0.1806	1.4426	3.6893	
Biased Mean-3σ	-0.4996	-1.0383	-1.0566	
DS MIN	-1.20E+00	-2.60E+00	-4.00E+00	mV
	PASS	PASS	PASS	
DS MAX	1.20E+00	2.60E+00	4.00E+00	mV
	PASS	PASS	PASS	

Figure A-25-2. Cell 8 TME, Input = 3.3V, Normal vs. LDR TID for the RT6804HG-1.

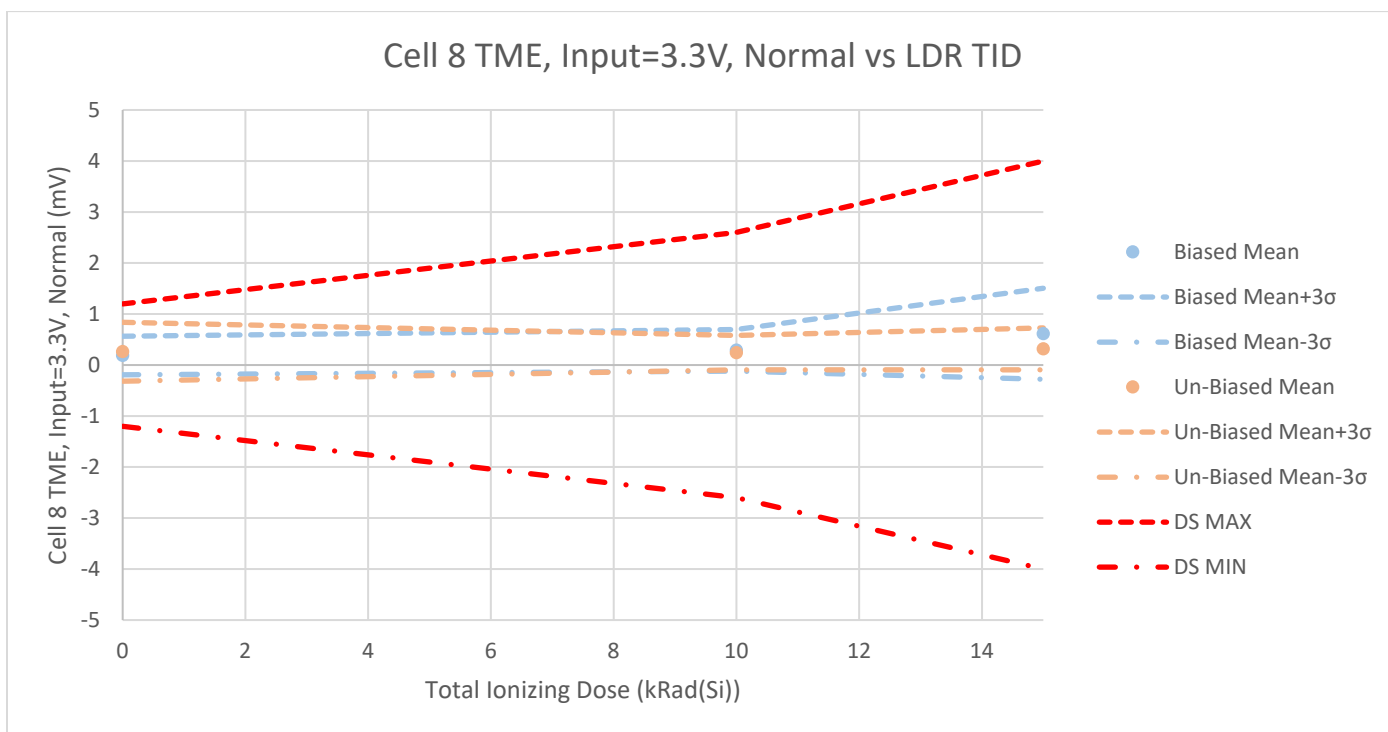

Table A-25-2. Cell 8 TME, Input = 3.3V, Normal vs. LDR TID for the RT6804HG-1.

Total Ionizing Dose (kRad(Si))	0	10	15	Units
LDR TID Biased				
Biased Mean	0.1865	0.2898	0.6152	mV
Std Dev	0.1265	0.1356	0.2974	
Biased Mean+3σ	0.5661	0.6965	1.5073	
Biased Mean-3σ	-0.1931	-0.1170	-0.2770	
LDR TID Un-Biased				
Un-Biased Mean	0.2616	0.2419	0.3175	mV
Std Dev	0.1923	0.1127	0.1370	
Un-Biased Mean+3σ	0.8383	0.5799	0.7283	
Un-Biased Mean-3σ	-0.3152	-0.0961	-0.0934	
DS MIN	-1.20E+00	-2.60E+00	-4.00E+00	mV
	PASS	PASS	PASS	
DS MAX	1.20E+00	2.60E+00	4.00E+00	mV
	PASS	PASS	PASS	

Figure A-26-1. Cell 9 TME, Input = 3.3V, Normal vs. HDR TID for the RT6804HG-1.

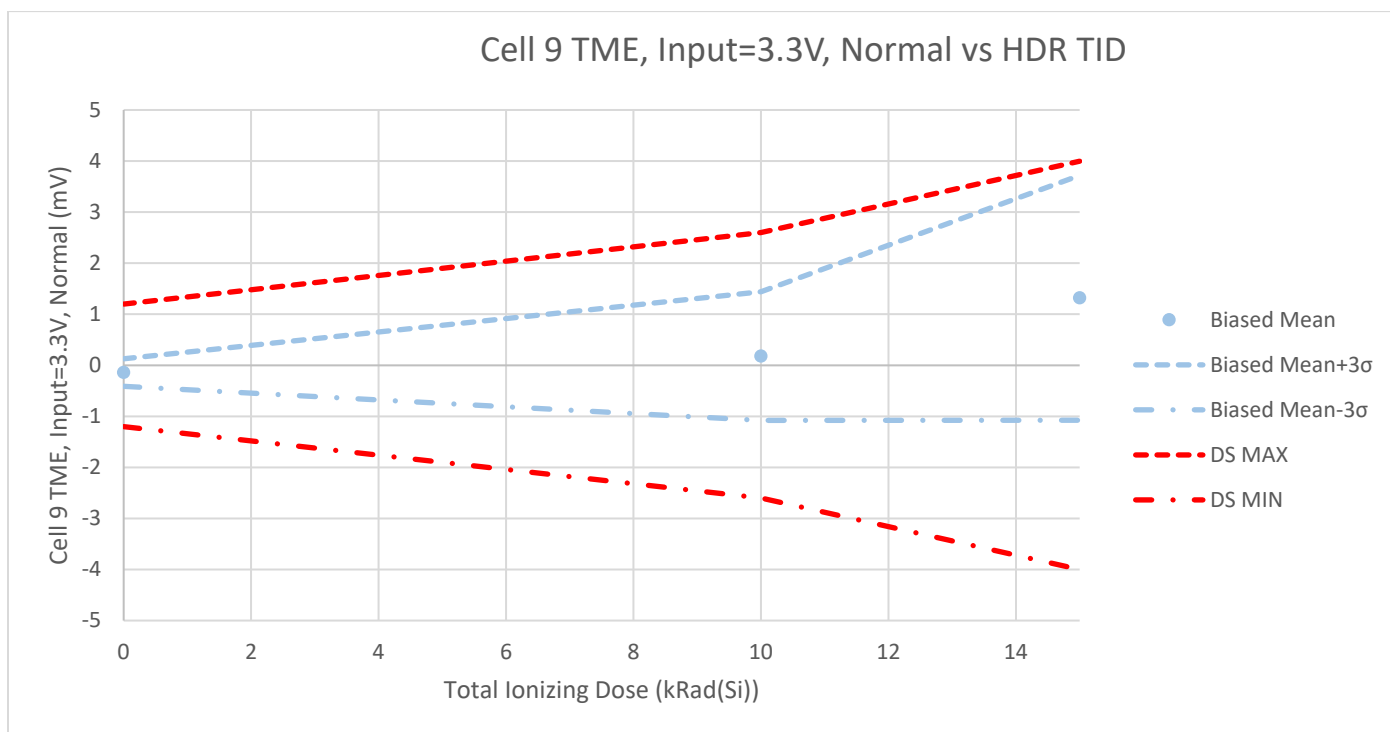

Table A-26-1. Cell 9 TME, Input = 3.3V, Normal vs. HDR TID for the RT6804HG-1.

HDR TID Biased				
Total Ionizing Dose (kRad(Si))	0	10	15	Units
Biased Mean	-0.1408	0.1801	1.3212	mV
Std Dev	0.0899	0.4200	0.7991	
Biased Mean+3σ	0.1290	1.4400	3.7186	
Biased Mean-3σ	-0.4107	-1.0797	-1.0761	
DS MIN	-1.20E+00	-2.60E+00	-4.00E+00	mV
	PASS	PASS	PASS	
DS MAX	1.20E+00	2.60E+00	4.00E+00	mV
	PASS	PASS	PASS	

Figure A-26-2. Cell 9 TME, Input = 3.3V, Normal vs. LDR TID for the RT6804HG-1.

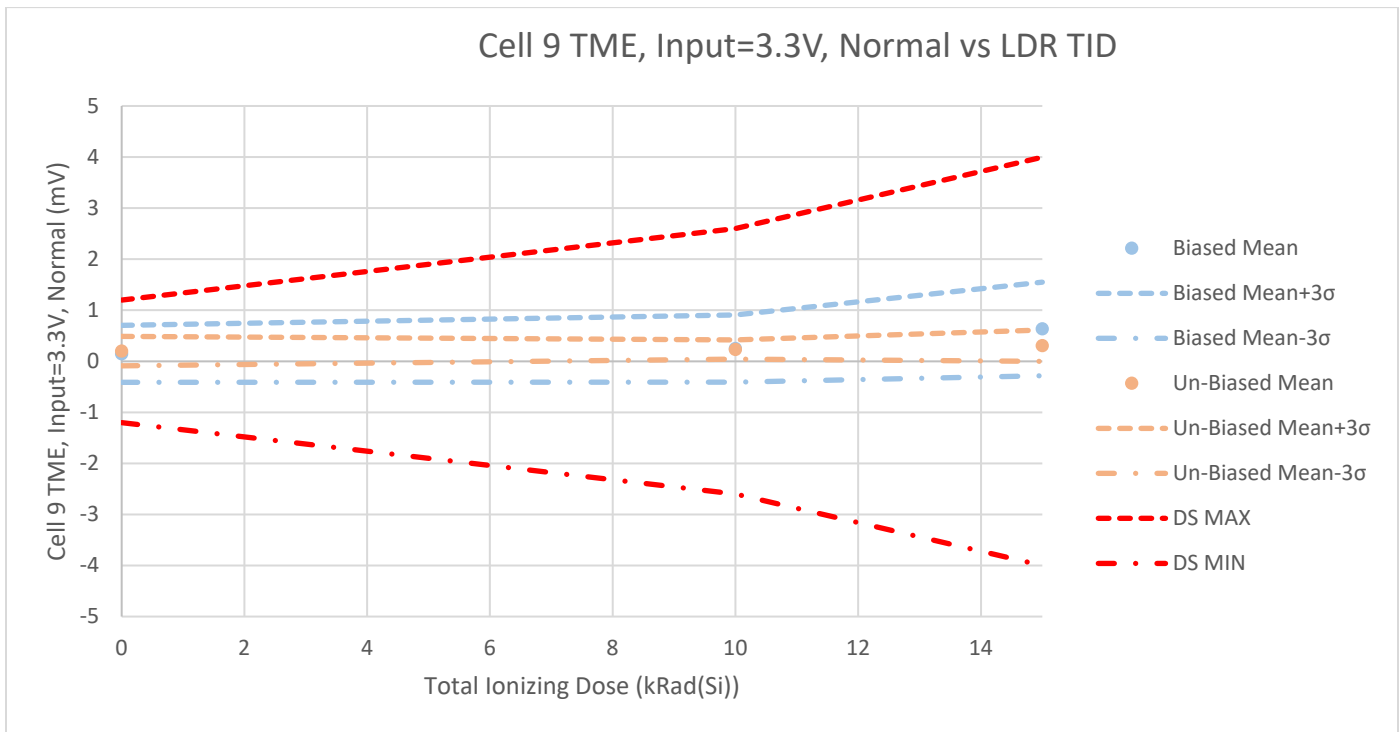

Table A-26-2. Cell 9 TME, Input = 3.3V, Normal vs. LDR TID for the RT6804HG-1.

Total Ionizing Dose (kRad(Si))	0	10	15	Units
LDR TID Biased				
Biased Mean	0.1461	0.2480	0.6338	mV
Std Dev	0.1860	0.2195	0.3055	
Biased Mean+3σ	0.7042	0.9066	1.5503	
Biased Mean-3σ	-0.4120	-0.4106	-0.2827	
LDR TID Un-Biased				
Un-Biased Mean	0.2001	0.2312	0.3056	mV
Std Dev	0.0960	0.0629	0.1029	
Un-Biased Mean+3σ	0.4881	0.4199	0.6143	
Un-Biased Mean-3σ	-0.0878	0.0426	-0.0031	
DS MIN	-1.20E+00	-2.60E+00	-4.00E+00	mV
	PASS	PASS	PASS	
DS MAX	1.20E+00	2.60E+00	4.00E+00	mV
	PASS	PASS	PASS	

Figure A-27-1. Cell 10 TME, Input = 3.3V, Normal vs. HDR TID for the RT6804HG-1.

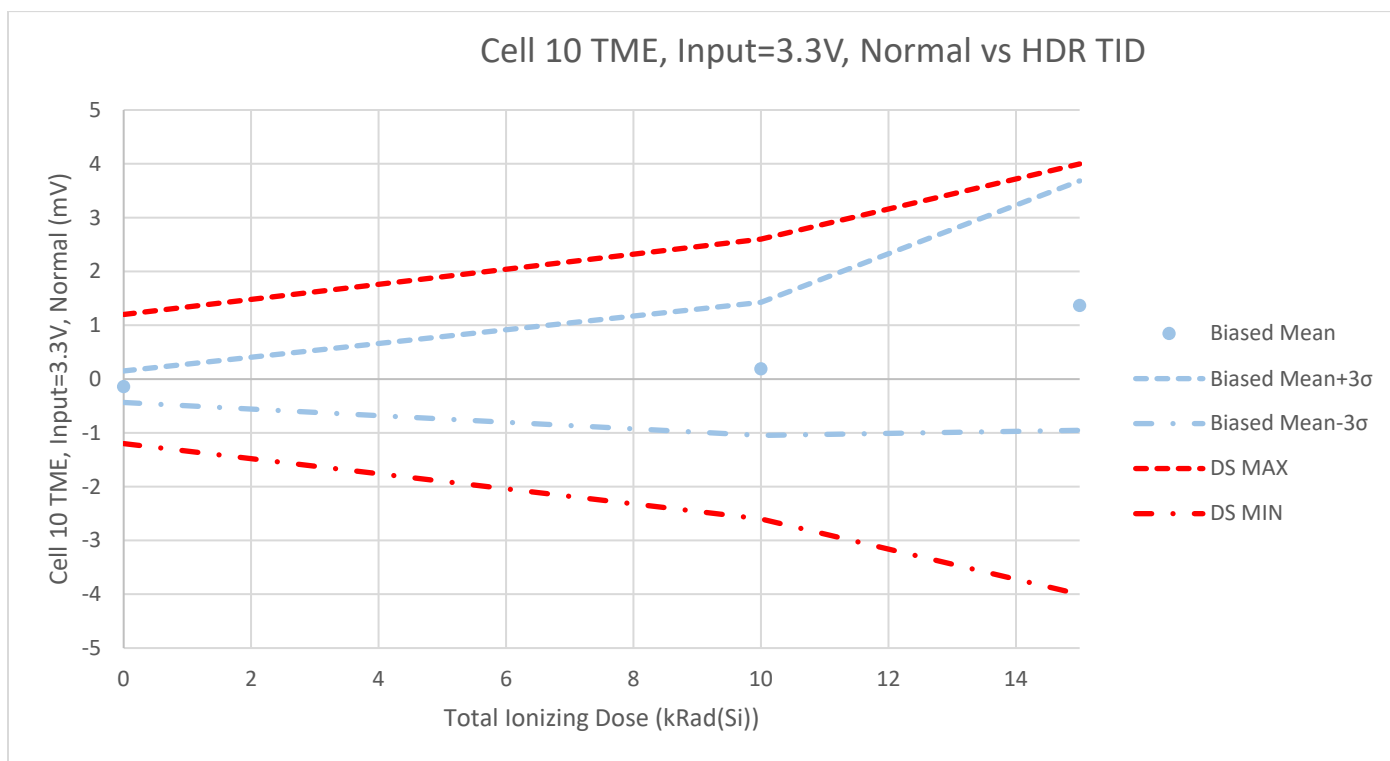

Table A-27-1. Cell 10 TME, Input = 3.3V, Normal vs. HDR TID for the RT6804HG-1.

HDR TID Biased				
Total Ionizing Dose (kRad(Si))	0	10	15	Units
Biased Mean	-0.1418	0.1888	1.3647	mV
Std Dev	0.0978	0.4122	0.7732	
Biased Mean+3σ	0.1514	1.4255	3.6843	
Biased Mean-3σ	-0.4351	-1.0479	-0.9549	
DS MIN	-1.20E+00	-2.60E+00	-4.00E+00	mV
	PASS	PASS	PASS	
DS MAX	1.20E+00	2.60E+00	4.00E+00	mV
	PASS	PASS	PASS	

Figure A-27-2. Cell 10 TME, Input = 3.3V, Normal vs. LDR TID for the RT6804HG-1.

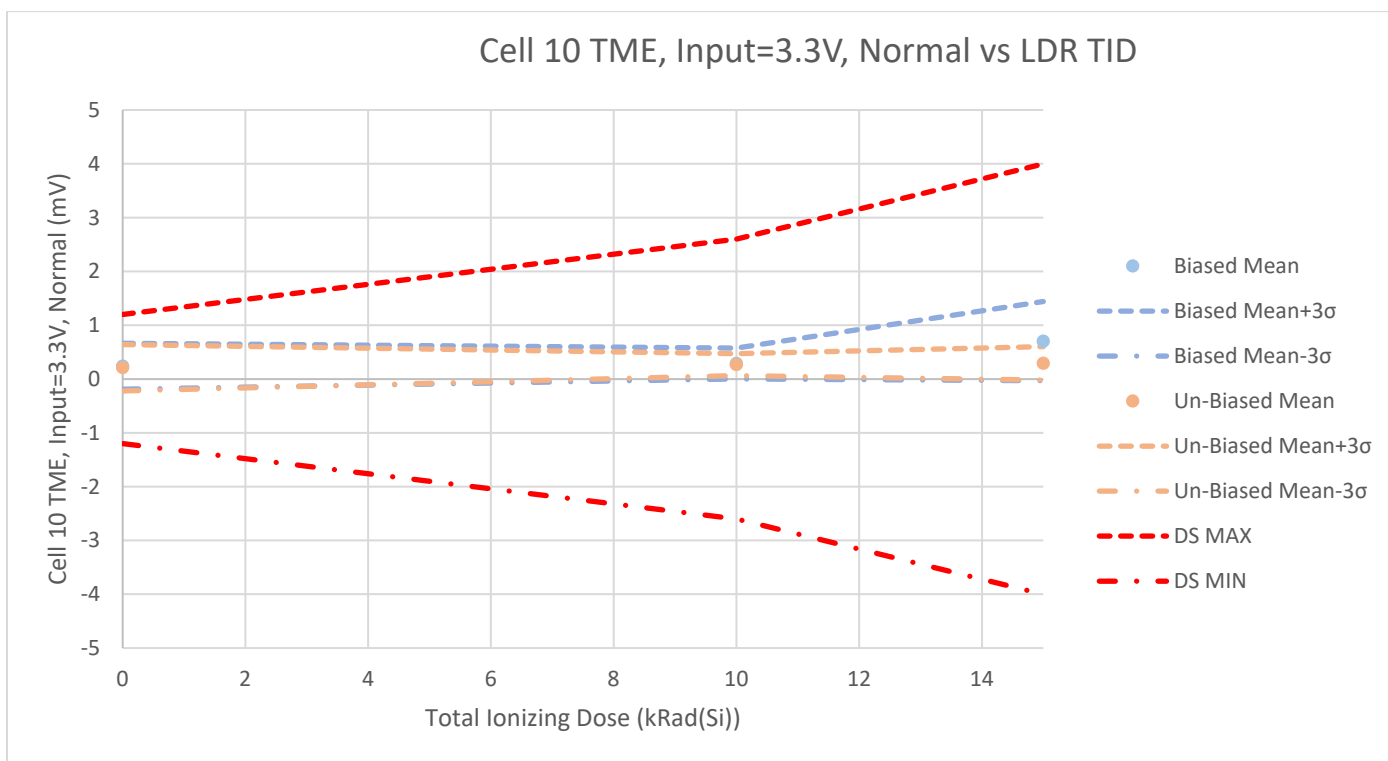

Table A-27-2. Cell 10 TME, Input = 3.3V, Normal vs. LDR TID for the RT6804HG-1.

Total Ionizing Dose (kRad(Si))	0	10	15	Units
LDR TID Biased				
Biased Mean	0.2383	0.2897	0.7041	mV
Std Dev	0.1422	0.0958	0.2457	
Biased Mean+3σ	0.6648	0.5772	1.4411	
Biased Mean-3σ	-0.1882	0.0022	-0.0329	
LDR TID Un-Biased				
Un-Biased Mean	0.2111	0.2691	0.2918	mV
Std Dev	0.1437	0.0680	0.1037	
Un-Biased Mean+3σ	0.6423	0.4732	0.6028	
Un-Biased Mean-3σ	-0.2202	0.0650	-0.0192	
DS MIN	-1.20E+00	-2.60E+00	-4.00E+00	mV
	PASS	PASS	PASS	
DS MAX	1.20E+00	2.60E+00	4.00E+00	mV
	PASS	PASS	PASS	

Figure A-28-1. Cell 11 TME, Input = 3.3V, Normal vs. HDR TID for the RT6804HG-1.

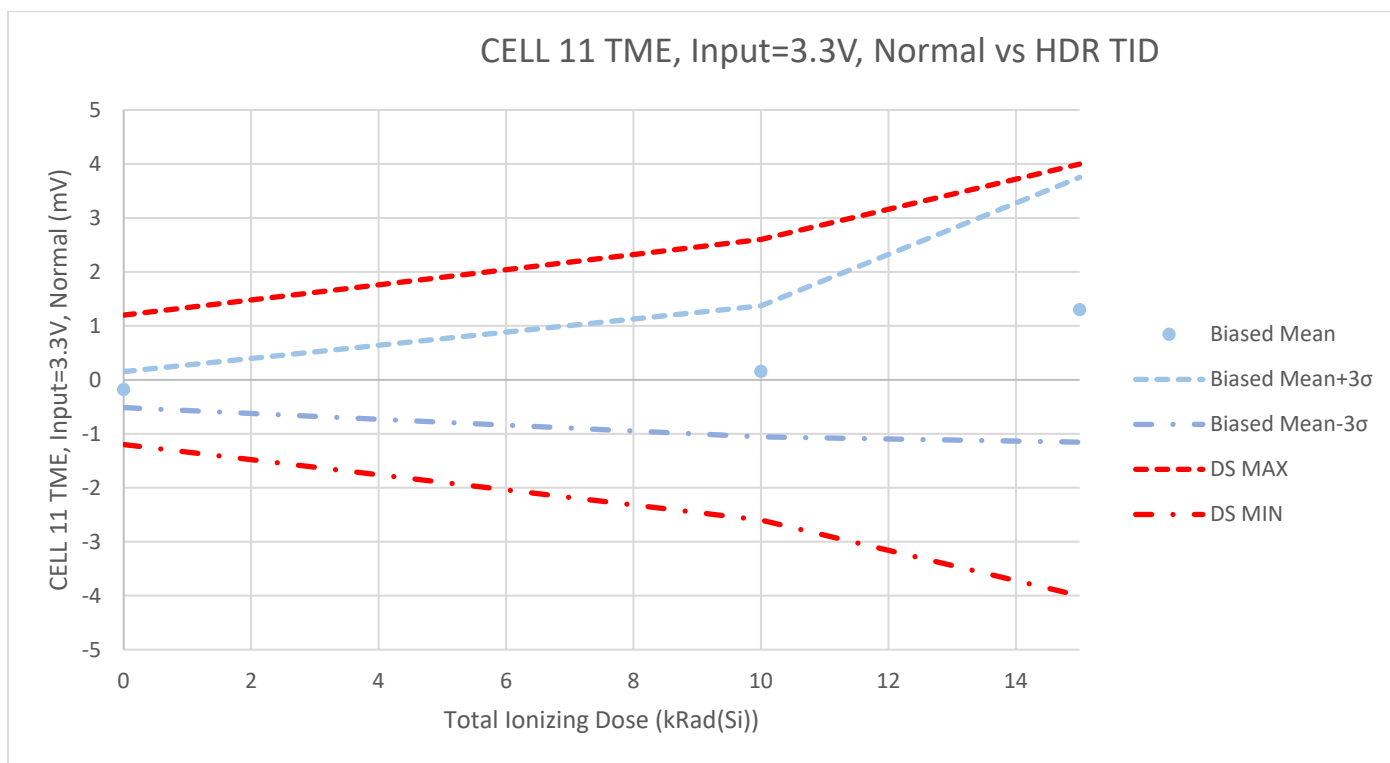

Table A-28-1. Cell 11 TME, Input = 3.3V, Normal vs. HDR TID for the RT6804HG-1.

HDR TID Biased				
Total Ionizing Dose (kRad(Si))	0	10	15	Units
Biased Mean	-0.1799	0.1553	1.2996	mV
Std Dev	0.1116	0.4047	0.8180	
Biased Mean+3σ	0.1548	1.3695	3.7535	
Biased Mean-3σ	-0.5146	-1.0589	-1.1544	
DS MIN	-1.20E+00	-2.60E+00	-4.00E+00	mV
	PASS	PASS	PASS	
DS MAX	1.20E+00	2.60E+00	4.00E+00	mV
	PASS	PASS	PASS	

Figure A-28-2. Cell 11 TME, Input = 3.3V, Normal vs. LDR TID for the RT6804HG-1.

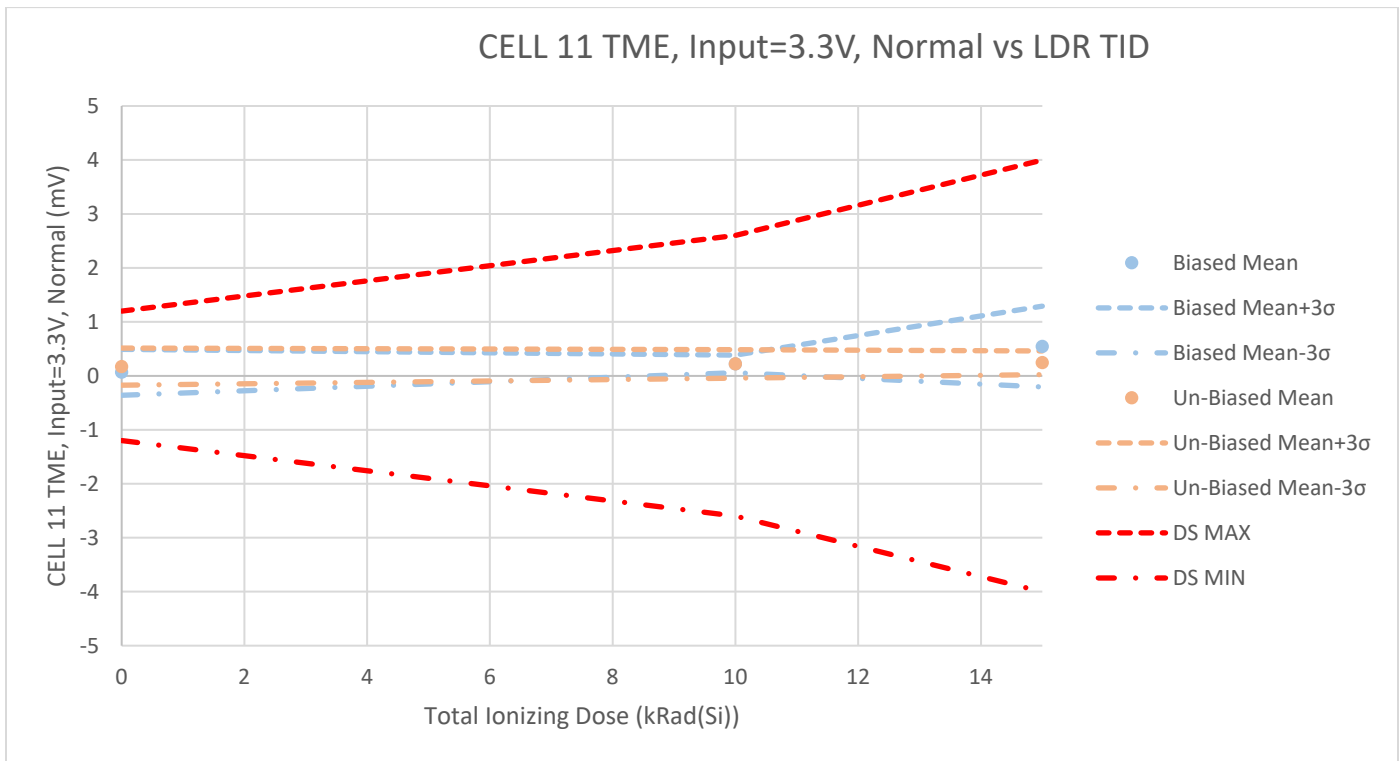

Table A-28-2. Cell 11 TME, Input = 3.3V, Normal vs. LDR TID for the RT6804HG-1.

Total Ionizing Dose (kRad(Si))	0	10	15	Units
LDR TID Biased				
Biased Mean	0.0657	0.2212	0.5424	mV
Std Dev	0.1417	0.0542	0.2500	
Biased Mean+3σ	0.4908	0.3836	1.2925	
Biased Mean-3σ	-0.3594	0.0587	-0.2078	
LDR TID Un-Biased				
Un-Biased Mean	0.1713	0.2202	0.2429	mV
Std Dev	0.1146	0.0878	0.0735	
Un-Biased Mean+3σ	0.5152	0.4837	0.4633	
Un-Biased Mean-3σ	-0.1726	-0.0433	0.0225	
DS MIN	-1.20E+00	-2.60E+00	-4.00E+00	mV
	PASS	PASS	PASS	
DS MAX	1.20E+00	2.60E+00	4.00E+00	mV
	PASS	PASS	PASS	

Figure A-29-1. Cell 12 TME, Input = 3.3V, Normal vs. HDR TID for the RT6804HG-1.

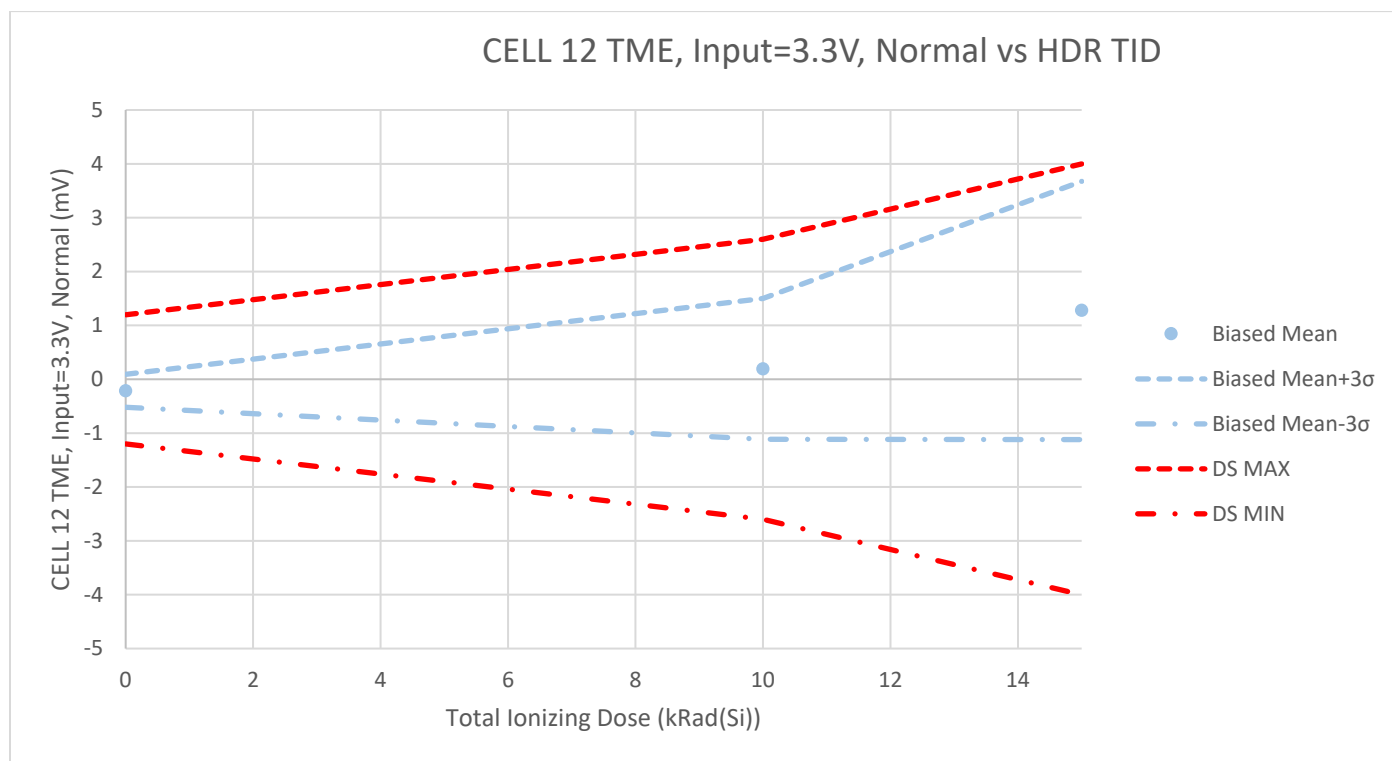

Table A-29-1. Cell 12 TME, Input = 3.3V, Normal vs. HDR TID for the RT6804HG-1.

HDR TID Biased				
Total Ionizing Dose (kRad(Si))	0	10	15	Units
Biased Mean	-0.2127	0.1940	1.2790	mV
Std Dev	0.1018	0.4358	0.7989	
Biased Mean+3σ	0.0926	1.5015	3.6759	
Biased Mean-3σ	-0.5179	-1.1134	-1.1178	
DS MIN	-1.20E+00	-2.60E+00	-4.00E+00	mV
	PASS	PASS	PASS	
DS MAX	1.20E+00	2.60E+00	4.00E+00	mV
	PASS	PASS	PASS	

Figure A-29-2. Cell 12 TME, Input = 3.3V, Normal vs. LDR TID for the RT6804HG-1.

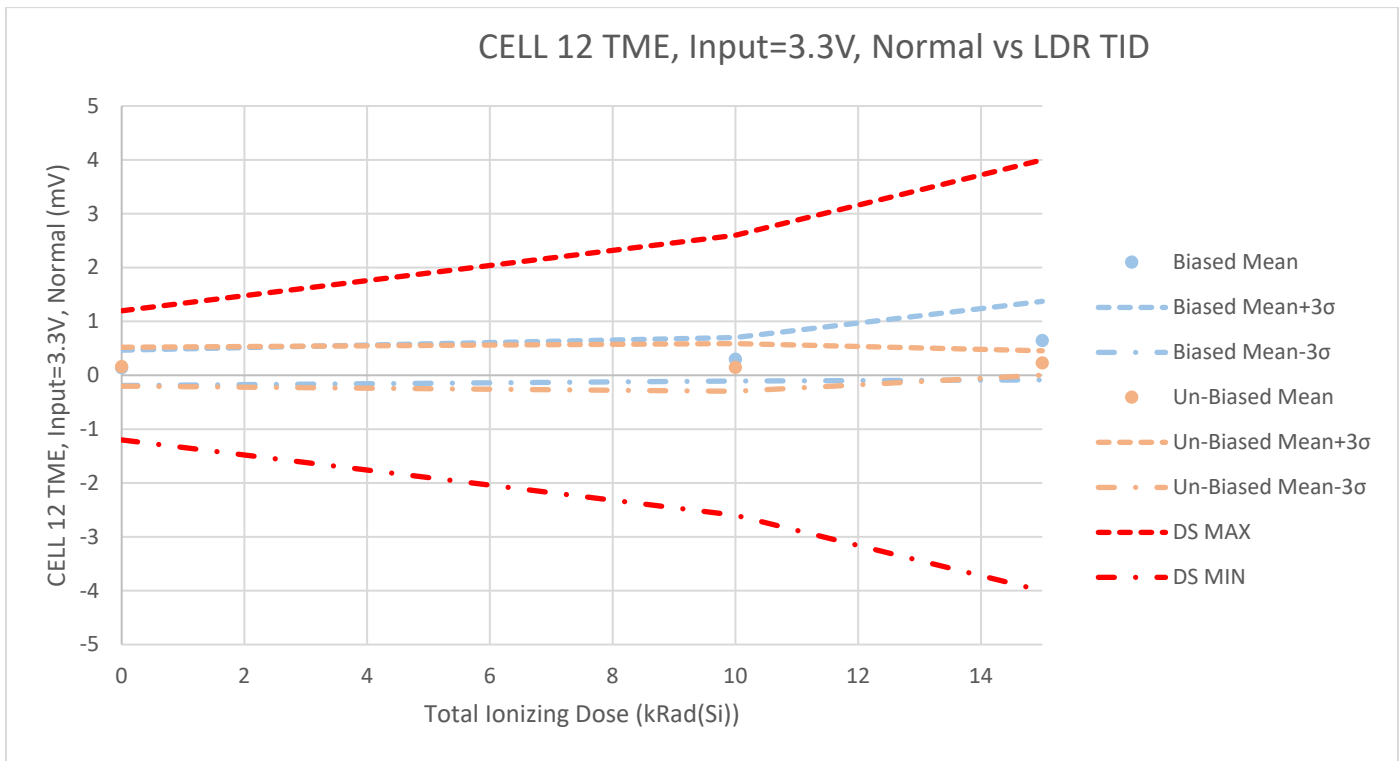

Table A-29-2. Cell 12 TME, Input = 3.3V, Normal vs. LDR TID for the RT6804HG-1.

Total Ionizing Dose (kRad(Si))	0	10	15	Units
LDR TID Biased				
Biased Mean	0.1395	0.2961	0.6454	mV
Std Dev	0.1098	0.1345	0.2430	
Biased Mean+3σ	0.4689	0.6996	1.3743	
Biased Mean-3σ	-0.1899	-0.1075	-0.0835	
LDR TID Un-Biased				
Un-Biased Mean	0.1595	0.1466	0.2296	mV
Std Dev	0.1204	0.1476	0.0754	
Un-Biased Mean+3σ	0.5206	0.5894	0.4556	
Un-Biased Mean-3σ	-0.2016	-0.2961	0.0035	
DS MIN	-1.20E+00	-2.60E+00	-4.00E+00	mV
	PASS	PASS	PASS	
DS MAX	1.20E+00	2.60E+00	4.00E+00	mV
	PASS	PASS	PASS	

Figure A-30-1. GPIO1 TME, Input=3.3V, Normal vs. HDR TID for the RT6804HG-1.

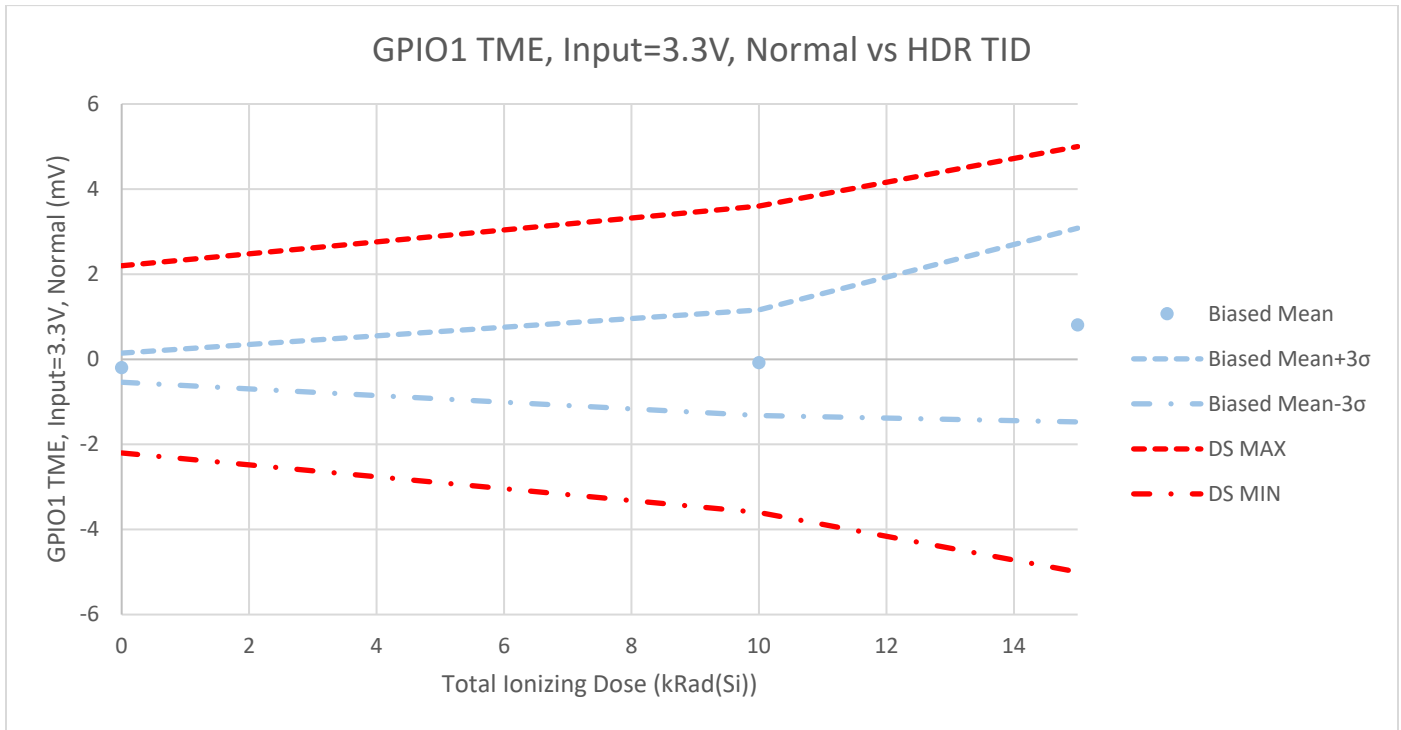

Table A-30-1. GPIO1 TME, Input=3.3V, Normal vs. HDR TID for the RT6804HG-1.

HDR TID Biased				
Total Ionizing Dose (kRad(Si))	0	10	15	Units
Biased Mean	-0.1958	-0.0809	0.8065	mV
Std Dev	0.1139	0.4141	0.7592	
Biased Mean+3σ	0.1458	1.1613	3.0840	
Biased Mean-3σ	-0.5375	-1.3231	-1.4709	
DS MIN	-2.20E+00	-3.60E+00	-5.00E+00	mV
	PASS	PASS	PASS	
DS MAX	2.20E+00	3.60E+00	5.00E+00	mV
	PASS	PASS	PASS	

Figure A-30-2. GPIO1 TME, Input=3.3V, Normal vs. LDR TID for the RT6804HG-1.

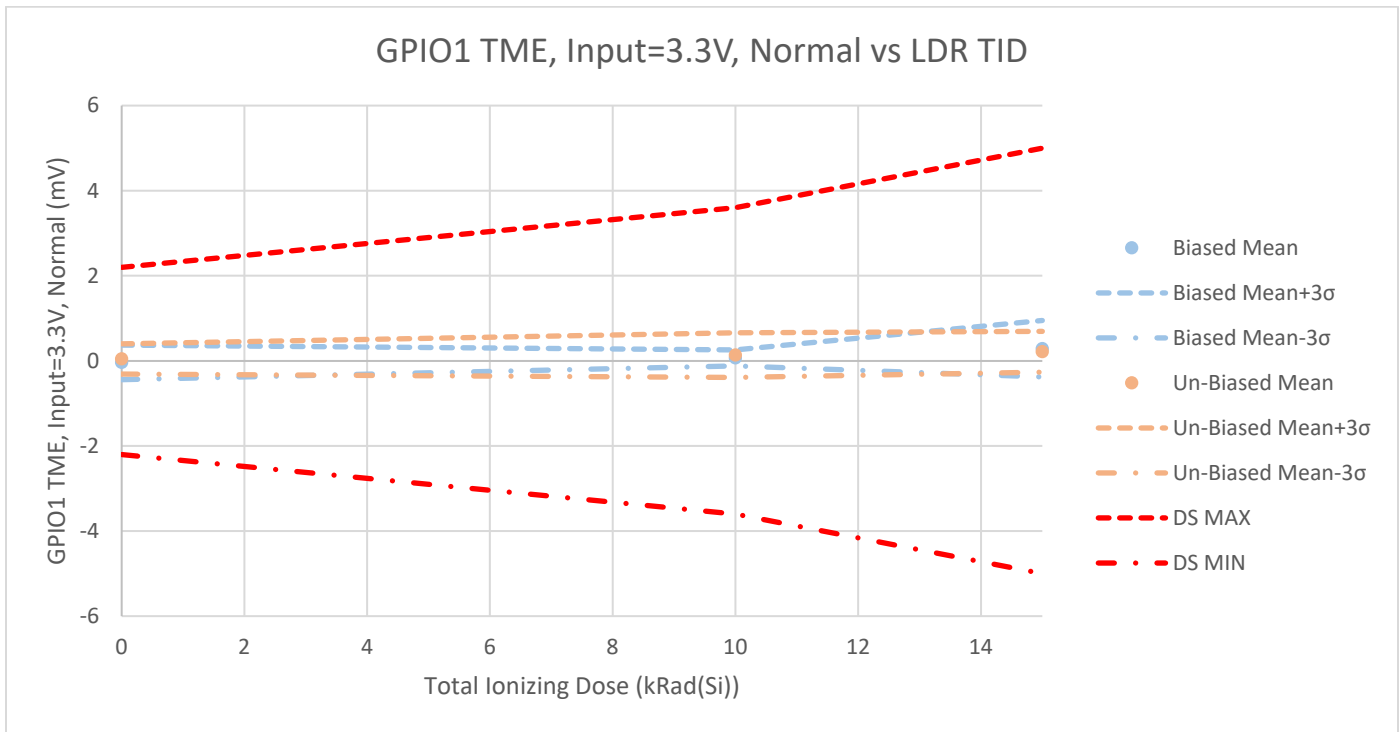

Table A-30-2. GPIO1 TME, Input=3.3V, Normal vs. LDR TID for the RT6804HG-1.

Total Ionizing Dose (kRad(Si))	0	10	15	Units
LDR TID Biased				
Biased Mean	-0.0353	0.0689	0.2861	mV
Std Dev	0.1350	0.0626	0.2218	
Biased Mean+3σ	0.3699	0.2568	0.9515	
Biased Mean-3σ	-0.4404	-0.1189	-0.3793	
LDR TID Un-Biased				
Un-Biased Mean	0.0460	0.1355	0.2154	mV
Std Dev	0.1189	0.1742	0.1602	
Un-Biased Mean+3σ	0.4027	0.6581	0.6958	
Un-Biased Mean-3σ	-0.3107	-0.3871	-0.2651	
DS MIN	-2.20E+00	-3.60E+00	-5.00E+00	mV
	PASS	PASS	PASS	
DS MAX	2.20E+00	3.60E+00	5.00E+00	mV
	PASS	PASS	PASS	

Figure A-31-1. GPIO2 TME, Input=3.3V, Normal vs. HDR TID for the RT6804HG-1.

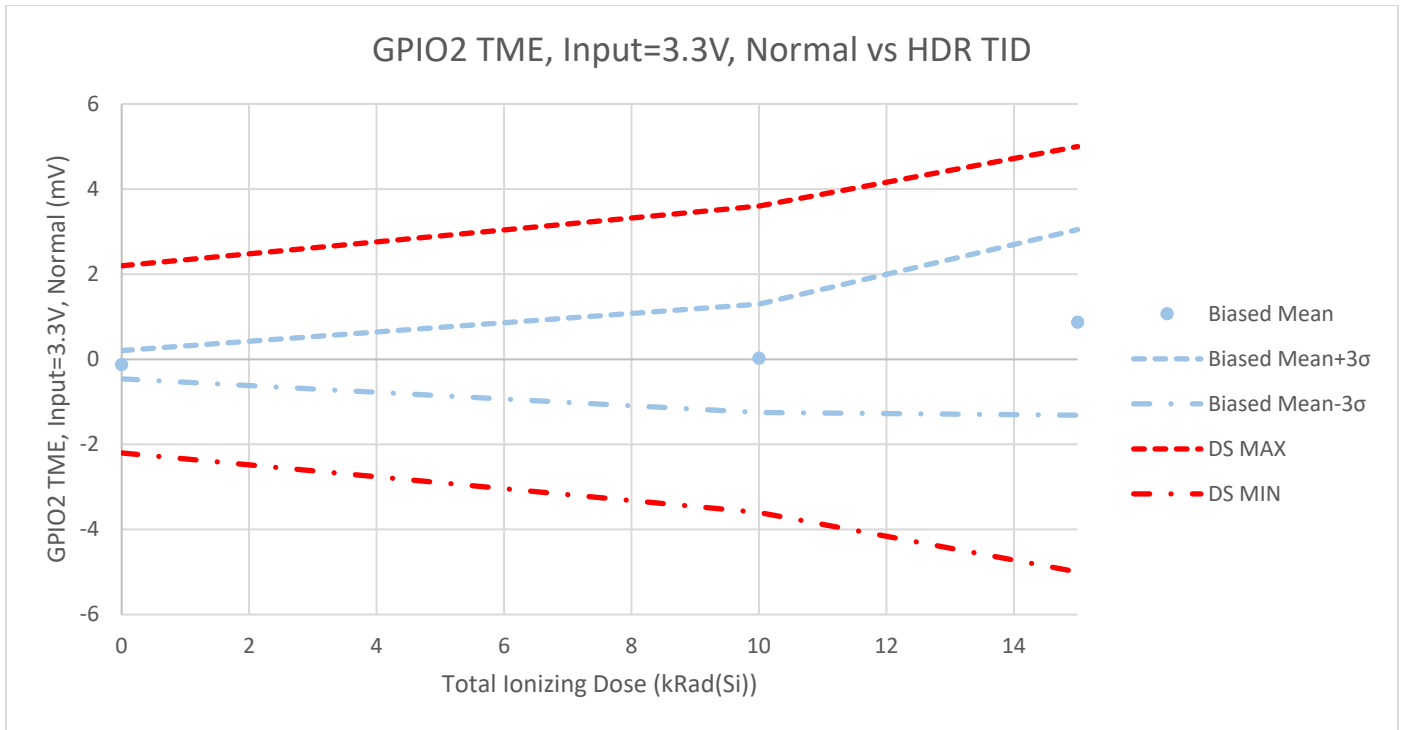

Table A-31-1. GPIO2 TME, Input=3.3V, Normal vs. HDR TID for the RT6804HG-1.

HDR TID Biased				
Total Ionizing Dose (kRad(Si))	0	10	15	Units
Biased Mean	-0.1265	0.0230	0.8693	mV
Std Dev	0.1112	0.4245	0.7269	
Biased Mean+3σ	0.2072	1.2966	3.0500	
Biased Mean-3σ	-0.4602	-1.2506	-1.3115	
DS MIN	-2.20E+00	-3.60E+00	-5.00E+00	mV
	PASS	PASS	PASS	
DS MAX	2.20E+00	3.60E+00	5.00E+00	mV
	PASS	PASS	PASS	

Figure A-31-2. GPIO2 TME, Input=3.3V, Normal vs. LDR TID for the RT6804HG-1.

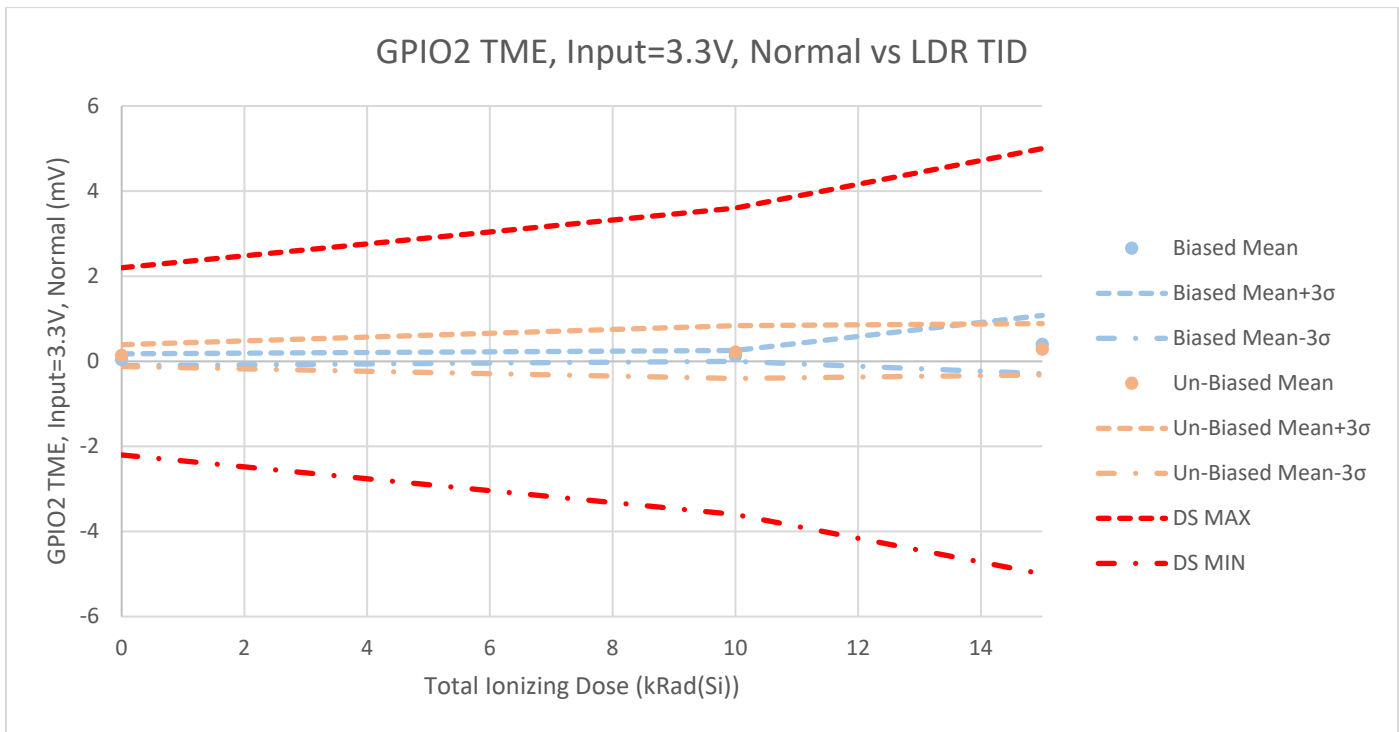

Table A-31-2. GPIO2 TME, Input=3.3V, Normal vs. LDR TID for the RT6804HG-1.

Total Ionizing Dose (kRad(Si))	0	10	15	Units
LDR TID Biased				
Biased Mean	0.0363	0.1256	0.3954	mV
Std Dev	0.0463	0.0421	0.2281	
Biased Mean+3σ	0.1752	0.2518	1.0797	
Biased Mean-3σ	-0.1027	-0.0005	-0.2890	
LDR TID Un-Biased				
Un-Biased Mean	0.1360	0.2165	0.2827	mV
Std Dev	0.0853	0.2066	0.2016	
Un-Biased Mean+3σ	0.3919	0.8364	0.8875	
Un-Biased Mean-3σ	-0.1198	-0.4034	-0.3222	
DS MIN	-2.20E+00	-3.60E+00	-5.00E+00	mV
	PASS	PASS	PASS	
DS MAX	2.20E+00	3.60E+00	5.00E+00	mV
	PASS	PASS	PASS	

Figure A-32-1. GPIO3 TME, Input=3.3V, Normal vs. HDR TID for the RT6804HG-1.

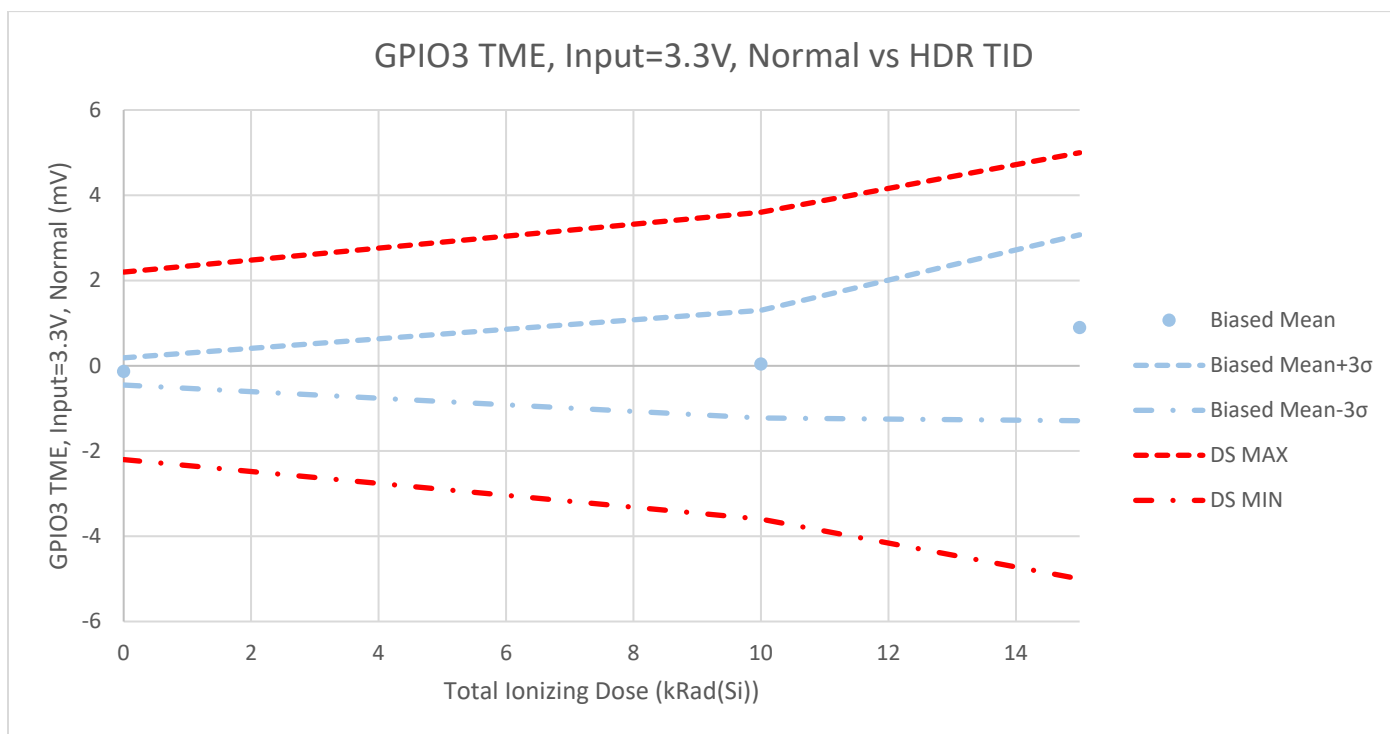

Table A-32-1. GPIO3 TME, Input=3.3V, Normal vs. HDR TID for the RT6804HG-1.

HDR TID Biased				
Total Ionizing Dose (kRad(Si))	0	10	15	Units
Biased Mean	-0.1333	0.0380	0.8936	mV
Std Dev	0.1063	0.4208	0.7269	
Biased Mean+3σ	0.1857	1.3005	3.0743	
Biased Mean-3σ	-0.4524	-1.2245	-1.2870	
DS MIN	-2.20E+00	-3.60E+00	-5.00E+00	mV
	PASS	PASS	PASS	
DS MAX	2.20E+00	3.60E+00	5.00E+00	mV
	PASS	PASS	PASS	

Figure A-32-2. GPIO3 TME, Input=3.3V, Normal vs. LDR TID for the RT6804HG-1.

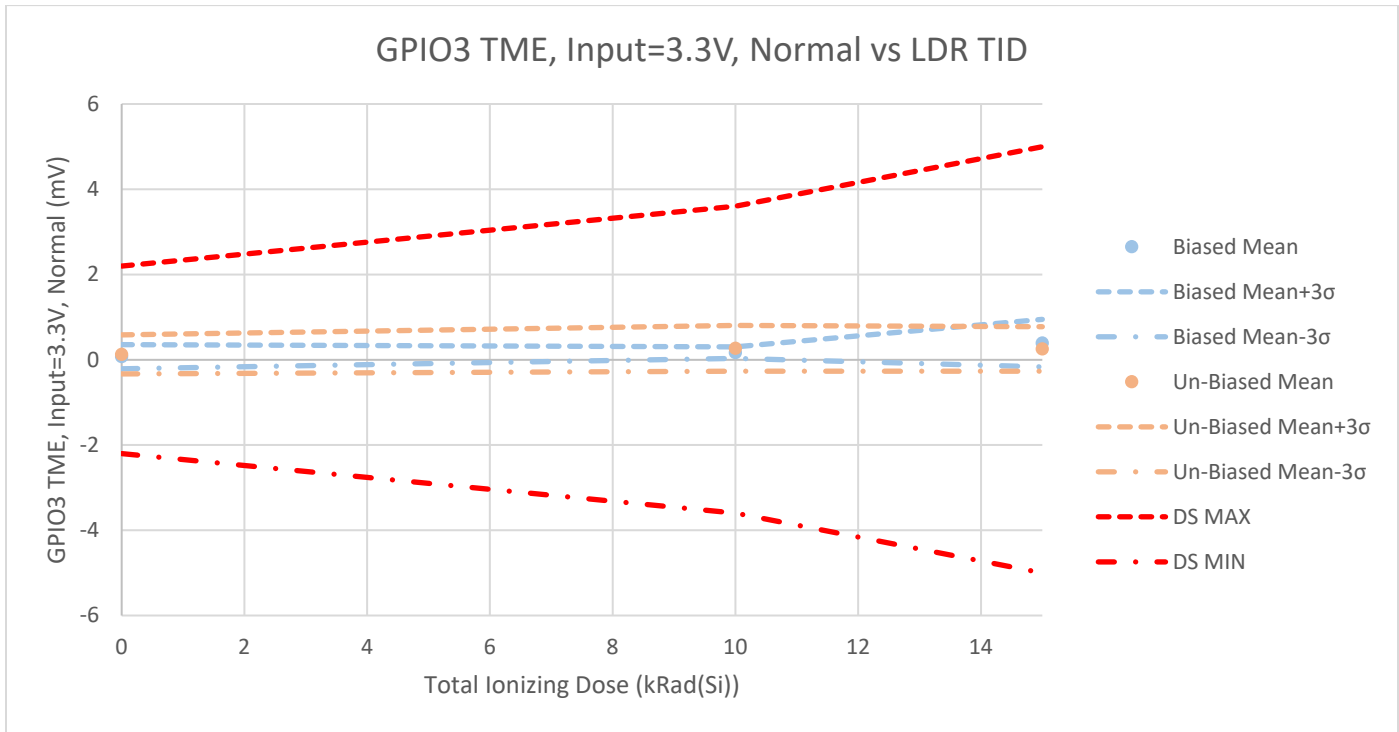

Table A-32-2. GPIO3 TME, Input=3.3V, Normal vs. LDR TID for the RT6804HG-1.

Total Ionizing Dose (kRad(Si))	0	10	15	Units
LDR TID Biased				
Biased Mean	0.0711	0.1684	0.3903	mV
Std Dev	0.0940	0.0456	0.1862	
Biased Mean+3σ	0.3529	0.3052	0.9489	
Biased Mean-3σ	-0.2108	0.0316	-0.1683	
LDR TID Un-Biased				
Un-Biased Mean	0.1265	0.2688	0.2518	mV
Std Dev	0.1525	0.1791	0.1742	
Un-Biased Mean+3σ	0.5841	0.8061	0.7743	
Un-Biased Mean-3σ	-0.3310	-0.2685	-0.2706	
DS Limits				
DS MIN	-2.20E+00	-3.60E+00	-5.00E+00	mV
	PASS	PASS	PASS	
DS MAX	2.20E+00	3.60E+00	5.00E+00	mV
	PASS	PASS	PASS	

Figure A-33-1. GPIO4 TME, Input=3.3V, Normal vs. HDR TID for the RT6804HG-1.

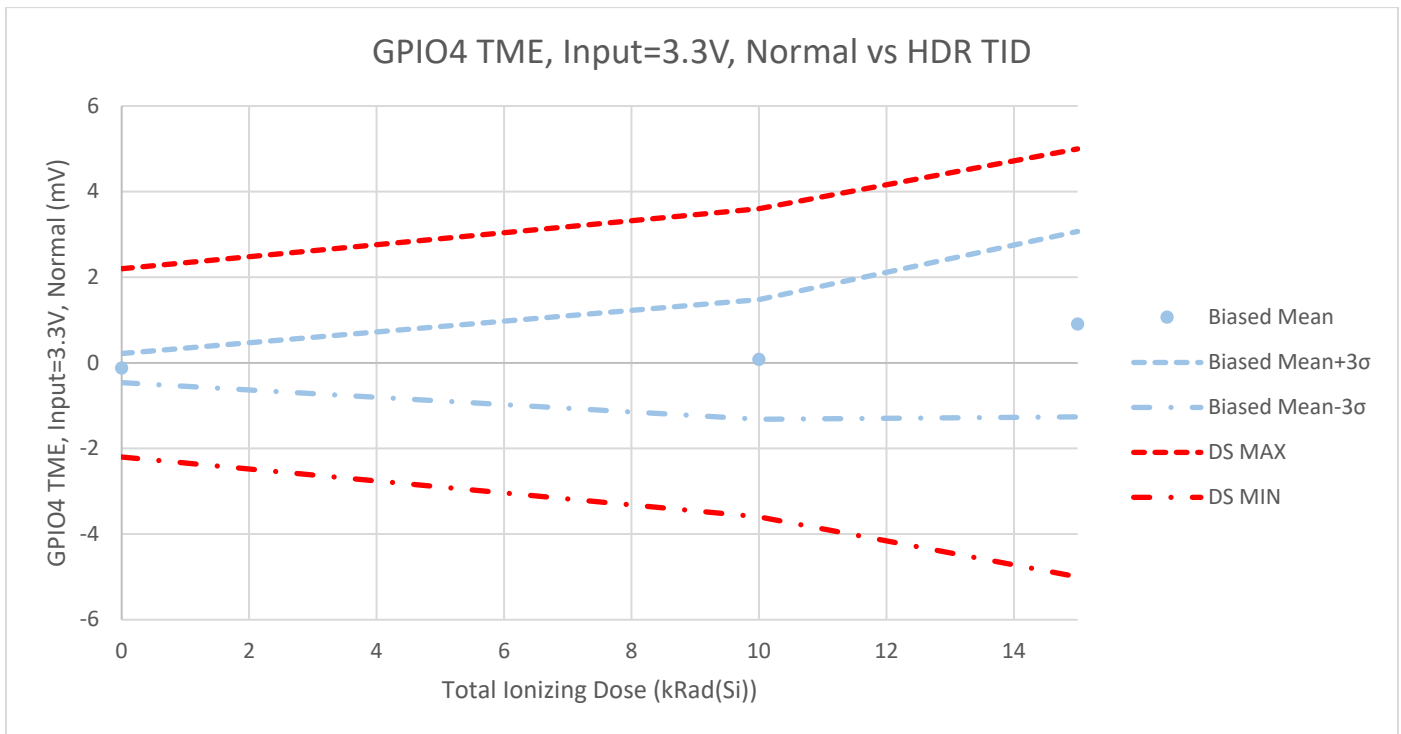

Table A-33-1. GPIO4 TME, Input=3.3V, Normal vs. HDR TID for the RT6804HG-1.

HDR TID Biased				
Total Ionizing Dose (kRad(Si))	0	10	15	Units
Biased Mean	-0.1215	0.0794	0.9030	mV
Std Dev	0.1135	0.4652	0.7222	
Biased Mean+3σ	0.2191	1.4749	3.0695	
Biased Mean-3σ	-0.4621	-1.3160	-1.2635	
DS MIN	-2.20E+00	-3.60E+00	-5.00E+00	mV
	PASS	PASS	PASS	
DS MAX	2.20E+00	3.60E+00	5.00E+00	mV
	PASS	PASS	PASS	

Figure A-33-2. GPIO4 TME, Input=3.3V, Normal vs. LDR TID for the RT6804HG-1.

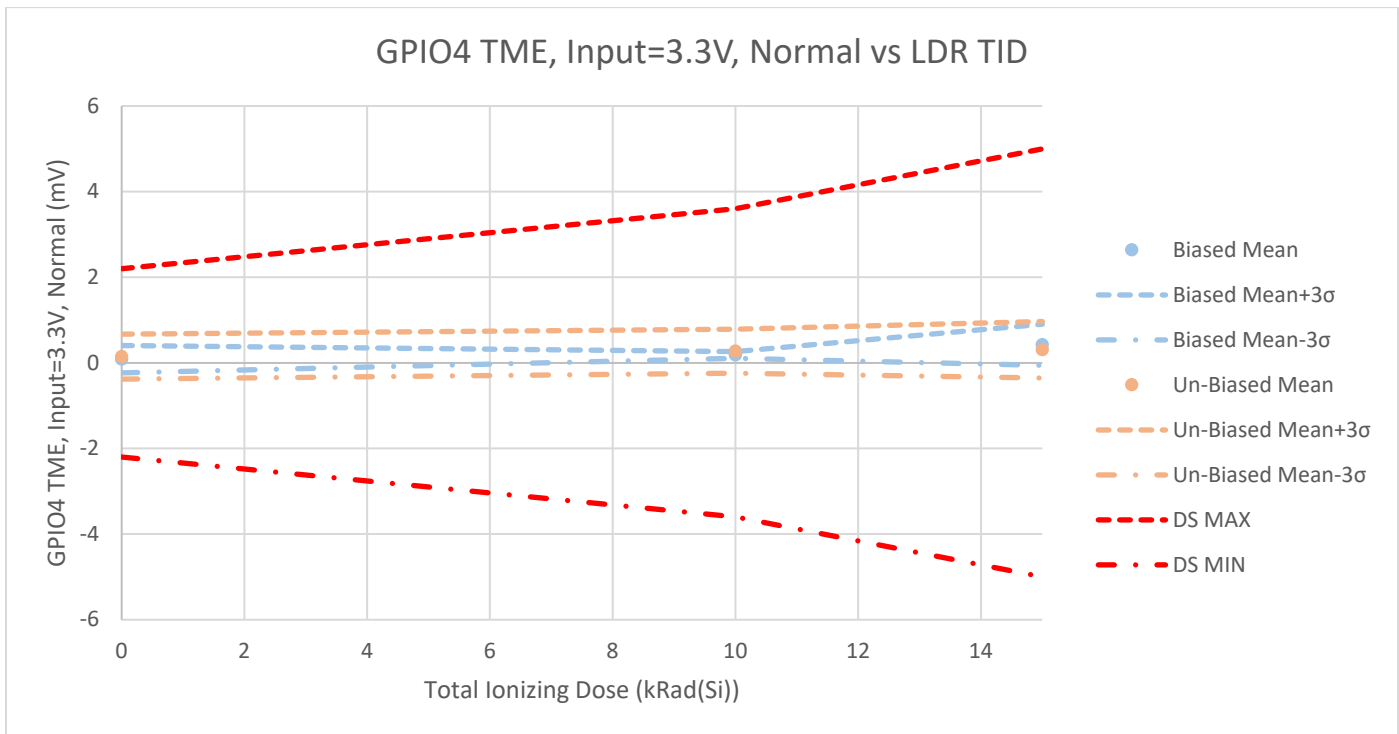

Table A-33-2. GPIO4 TME, Input=3.3V, Normal vs. LDR TID for the RT6804HG-1.

Total Ionizing Dose (kRad(Si))	0	10	15	Units
LDR TID Biased				
Biased Mean	0.0852	0.1849	0.4217	mV
Std Dev	0.1061	0.0258	0.1606	
Biased Mean+3σ	0.4036	0.2624	0.9036	
Biased Mean-3σ	-0.2332	0.1074	-0.0601	
LDR TID Un-Biased				
Un-Biased Mean	0.1462	0.2717	0.3063	mV
Std Dev	0.1747	0.1711	0.2203	
Un-Biased Mean+3σ	0.6703	0.7850	0.9673	
Un-Biased Mean-3σ	-0.3779	-0.2417	-0.3548	
DS Limits				
DS MIN	-2.20E+00	-3.60E+00	-5.00E+00	mV
	PASS	PASS	PASS	
DS MAX	2.20E+00	3.60E+00	5.00E+00	mV
	PASS	PASS	PASS	

Figure A-34-1. GPIO5 TME, Input=3.3V, Normal vs. HDR TID for the RT6804HG-1.

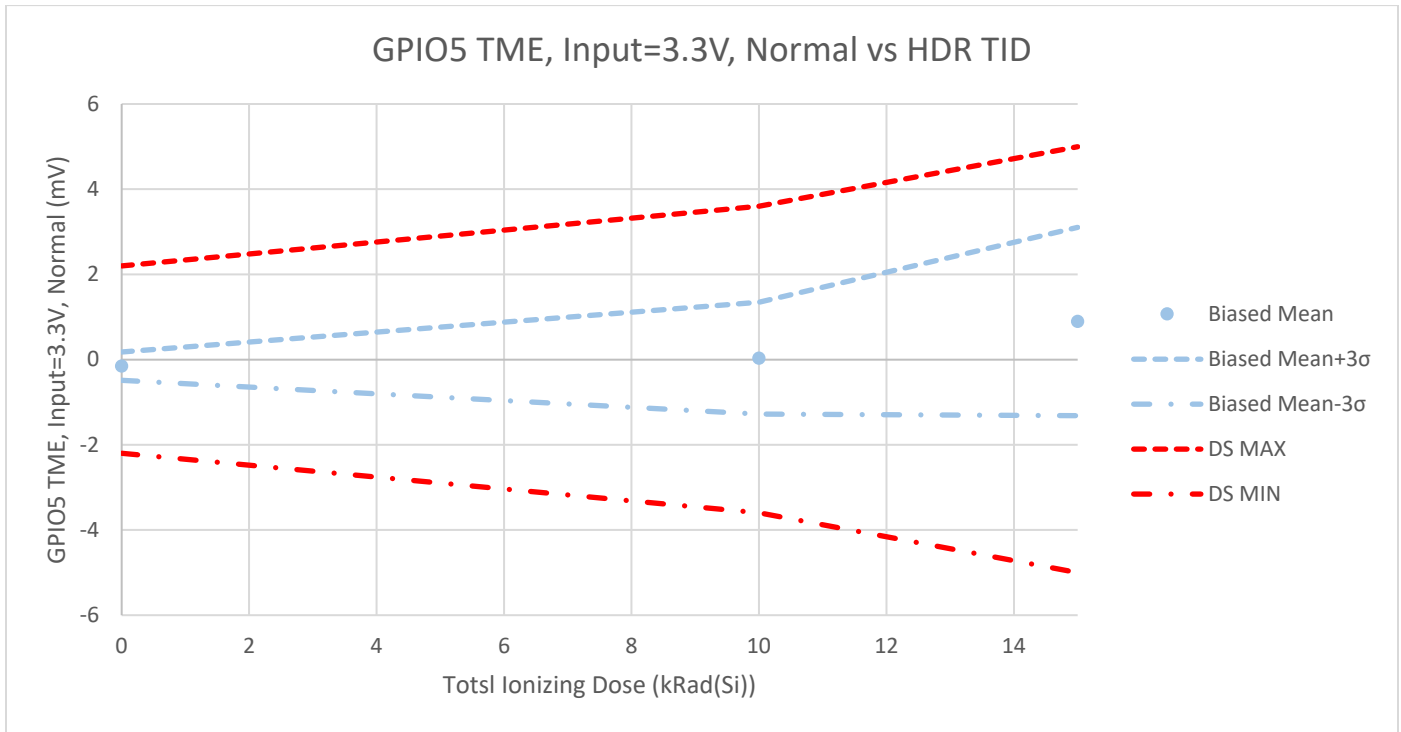

Table A-34-1. GPIO5 TME, Input=3.3V, Normal vs. HDR TID for the RT6804HG-1.

HDR TID Biased				
Total Ionizing Dose (kRad(Si))	0	10	15	Units
Biased Mean	-0.1531	0.0316	0.8955	mV
Std Dev	0.1104	0.4376	0.7369	
Biased Mean+3σ	0.1782	1.3443	3.1061	
Biased Mean-3σ	-0.4844	-1.2811	-1.3151	
DS MIN	-2.20E+00	-3.60E+00	-5.00E+00	mV
	PASS	PASS	PASS	
DS MAX	2.20E+00	3.60E+00	5.00E+00	mV
	PASS	PASS	PASS	

Figure A-34-1. GPIO5 TME, Input=3.3V, Normal vs. LDR TID for the RT6804HG-1.

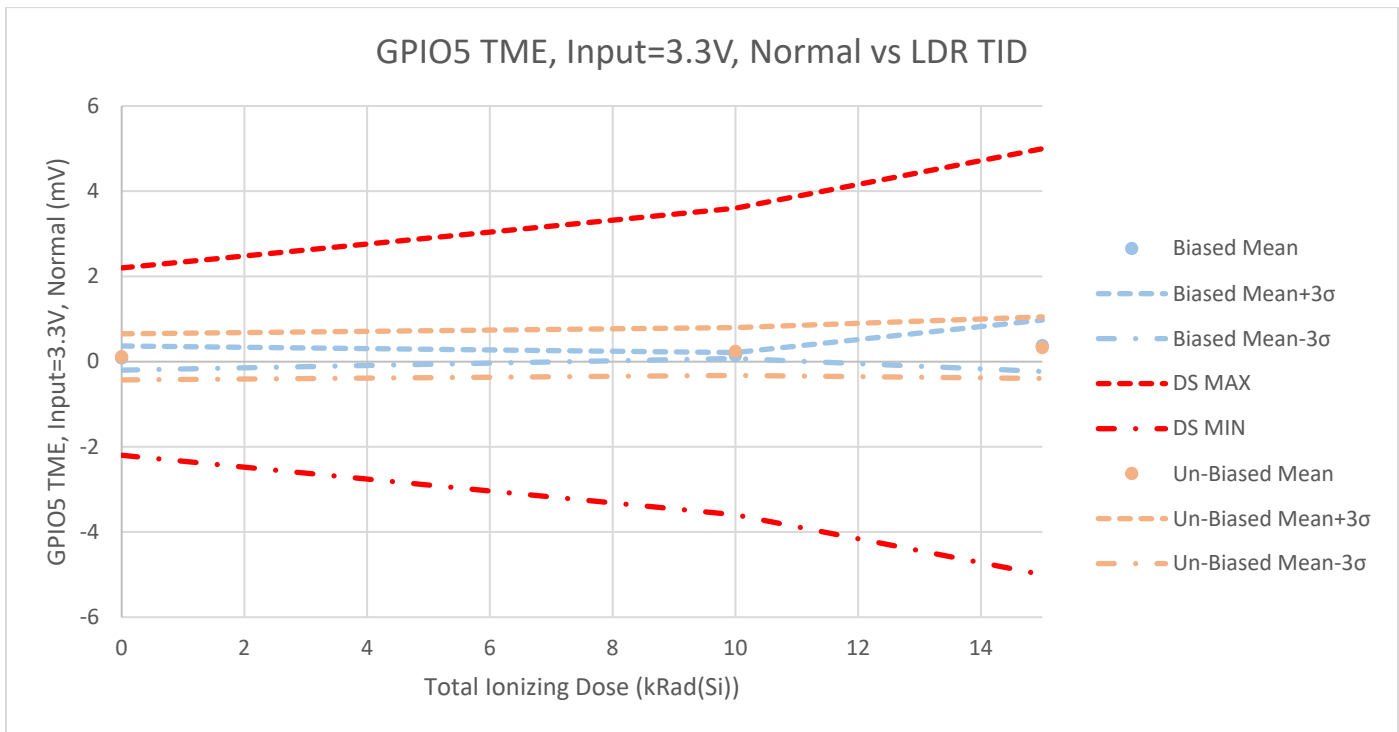

Table A-34-1. GPIO5 TME, Input=3.3V, Normal vs. LDR TID for the RT6804HG-1.

Total Ionizing Dose (kRad(Si))	0	10	15	Units
LDR TID Biased				
Biased Mean	0.0825	0.1444	0.3707	mV
Std Dev	0.0947	0.0231	0.2009	
Biased Mean+3σ	0.3666	0.2138	0.9734	
Biased Mean-3σ	-0.2016	0.0749	-0.2320	
LDR TID Un-Biased				
Un-Biased Mean	0.1113	0.2357	0.3262	mV
Std Dev	0.1798	0.1871	0.2411	
Un-Biased Mean+3σ	0.6508	0.7972	1.0495	
Un-Biased Mean-3σ	-0.4282	-0.3257	-0.3970	
DS MIN	-2.20E+00	-3.60E+00	-5.00E+00	mV
	PASS	PASS	PASS	
DS MAX	2.20E+00	3.60E+00	5.00E+00	mV
	PASS	PASS	PASS	

Figure A-35-1. Cell 1 TME, Input = 4.2V, Normal vs. HDR TID for the RT6804HG-1.

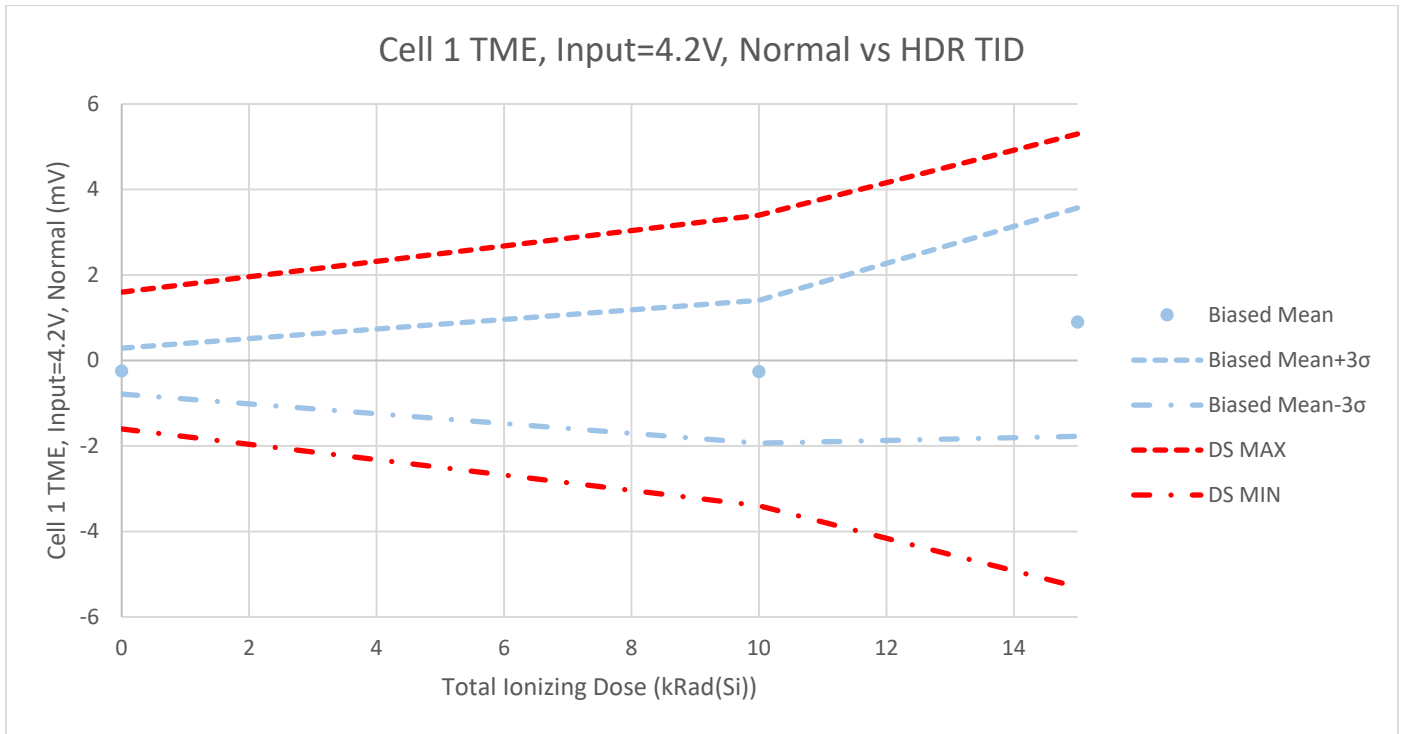

Table A-35-1. Cell 1 TME, Input = 4.2V, Normal vs. HDR TID for the RT6804HG-1.

HDR TID Biased				
Total Ionizing Dose (kRad(Si))	0	10	15	Units
Biased Mean	-0.2465	-0.2619	0.8997	mV
Std Dev	0.1788	0.5569	0.8913	
Biased Mean+3σ	0.2901	1.4087	3.5736	
Biased Mean-3σ	-0.7830	-1.9325	-1.7742	
DS MIN	-1.60E+00	-3.40E+00	-5.30E+00	mV
	PASS	PASS	PASS	
DS MAX	1.60E+00	3.40E+00	5.30E+00	mV
	PASS	PASS	PASS	

Figure A-35-2. Cell 1 TME, Input = 4.2V, Normal vs. LDR TID for the RT6804HG-1.

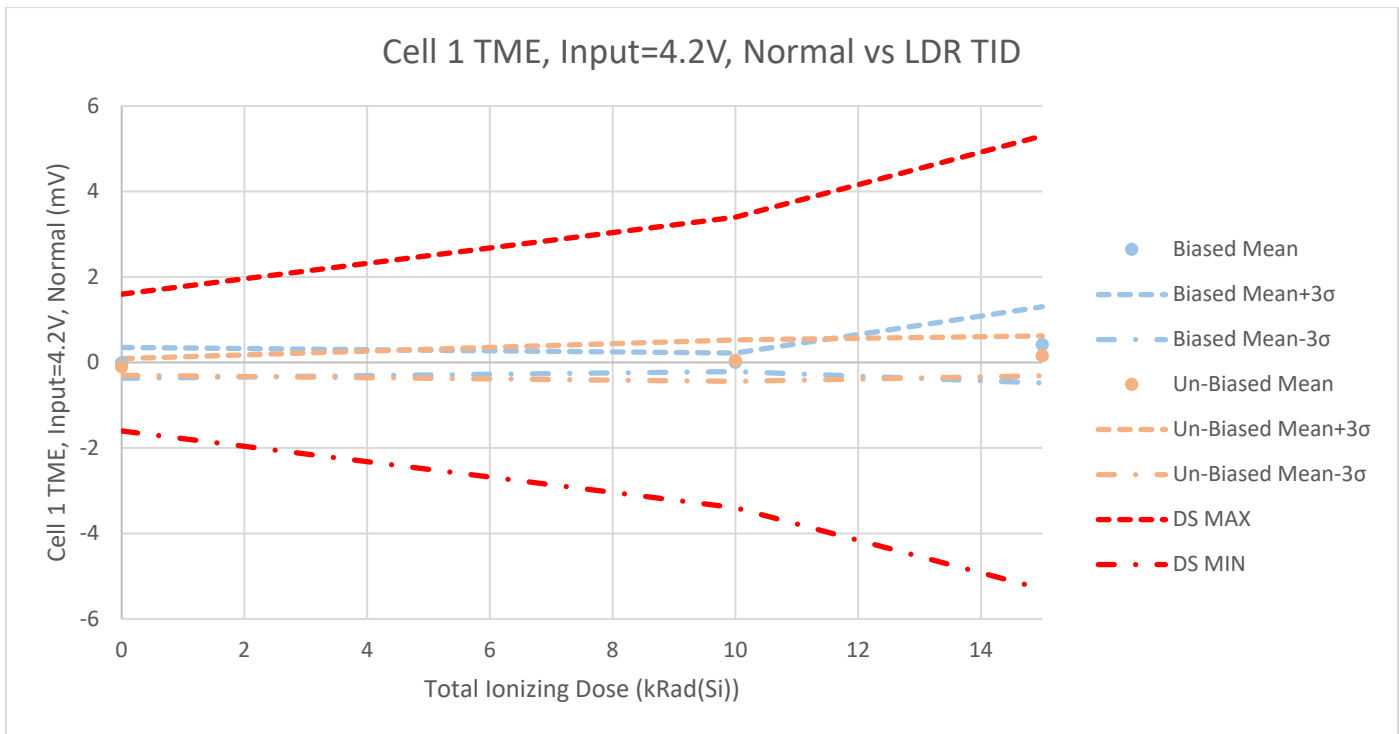

Table A-35-2. Cell 1 TME, Input = 4.2V, Normal vs. LDR TID for the RT6804HG-1.

Total Ionizing Dose (kRad(Si))	0	10	15	Units
LDR TID Biased				
Biased Mean	-0.0100	0.0049	0.4145	mV
Std Dev	0.1202	0.0724	0.2971	
Biased Mean+3σ	0.3506	0.2220	1.3057	
Biased Mean-3σ	-0.3706	-0.2121	-0.4766	
LDR TID Un-Biased				
Un-Biased Mean	-0.1021	0.0434	0.1562	mV
Std Dev	0.0648	0.1611	0.1556	
Un-Biased Mean+3σ	0.0924	0.5265	0.6229	
Un-Biased Mean-3σ	-0.2966	-0.4398	-0.3105	
DS Limits				
DS MIN	-1.60E+00	-3.40E+00	-5.30E+00	mV
	PASS	PASS	PASS	
DS MAX	1.60E+00	3.40E+00	5.30E+00	mV
	PASS	PASS	PASS	

Figure A-36-1. Cell 2 TME, Input = 4.2V, Normal vs. HDR TID for the RT6804HG-1.

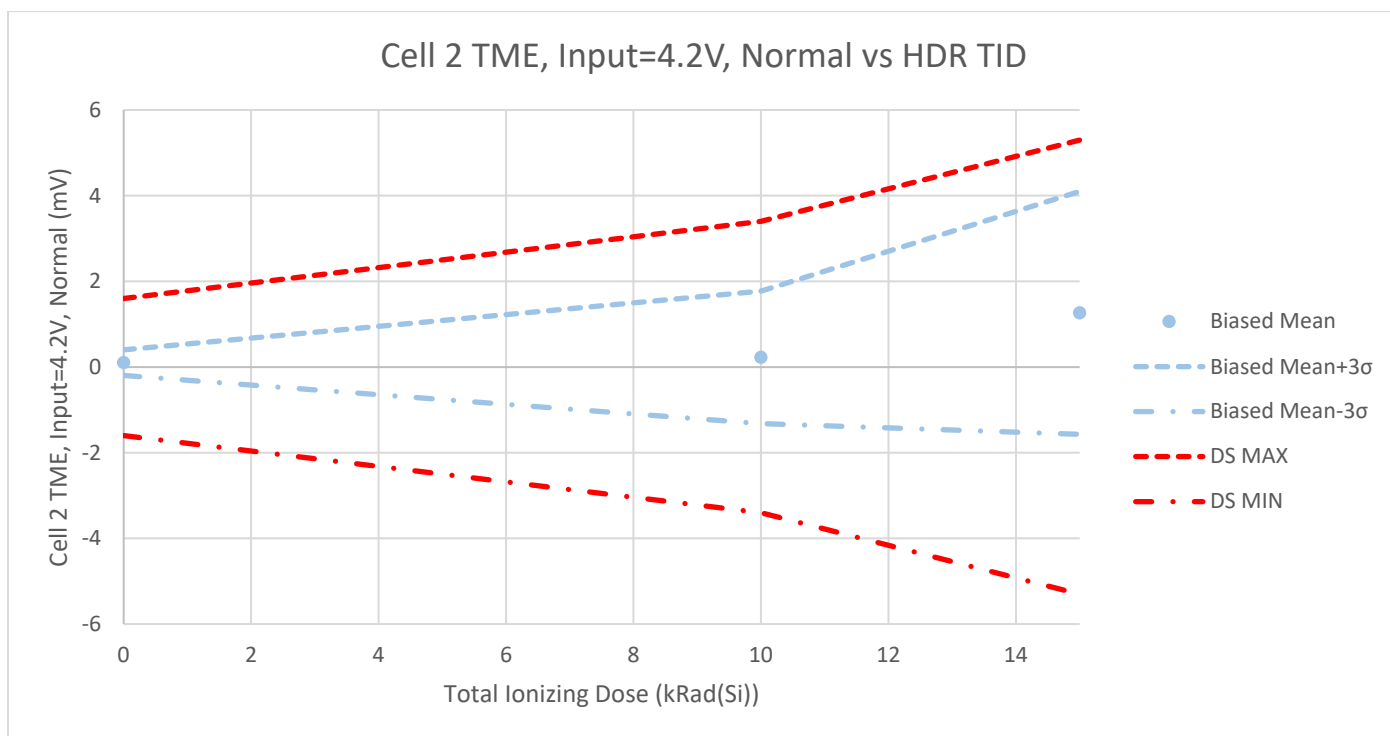

Table A-36-1. Cell 2 TME, Input = 4.2V, Normal vs. HDR TID for the RT6804HG-1.

HDR TID Biased				
Total Ionizing Dose (kRad(Si))	0	10	15	Units
Biased Mean	0.1024	0.2249	1.2651	mV
Std Dev	0.0997	0.5151	0.9449	
Biased Mean+3σ	0.4014	1.7703	4.0998	
Biased Mean-3σ	-0.1965	-1.3205	-1.5695	
DS MIN	-1.60E+00	-3.40E+00	-5.30E+00	mV
	PASS	PASS	PASS	
DS MAX	1.60E+00	3.40E+00	5.30E+00	mV
	PASS	PASS	PASS	

Figure A-36-2. Cell 2 TME, Input = 4.2V, Normal vs. LDR TID for the RT6804HG-1.

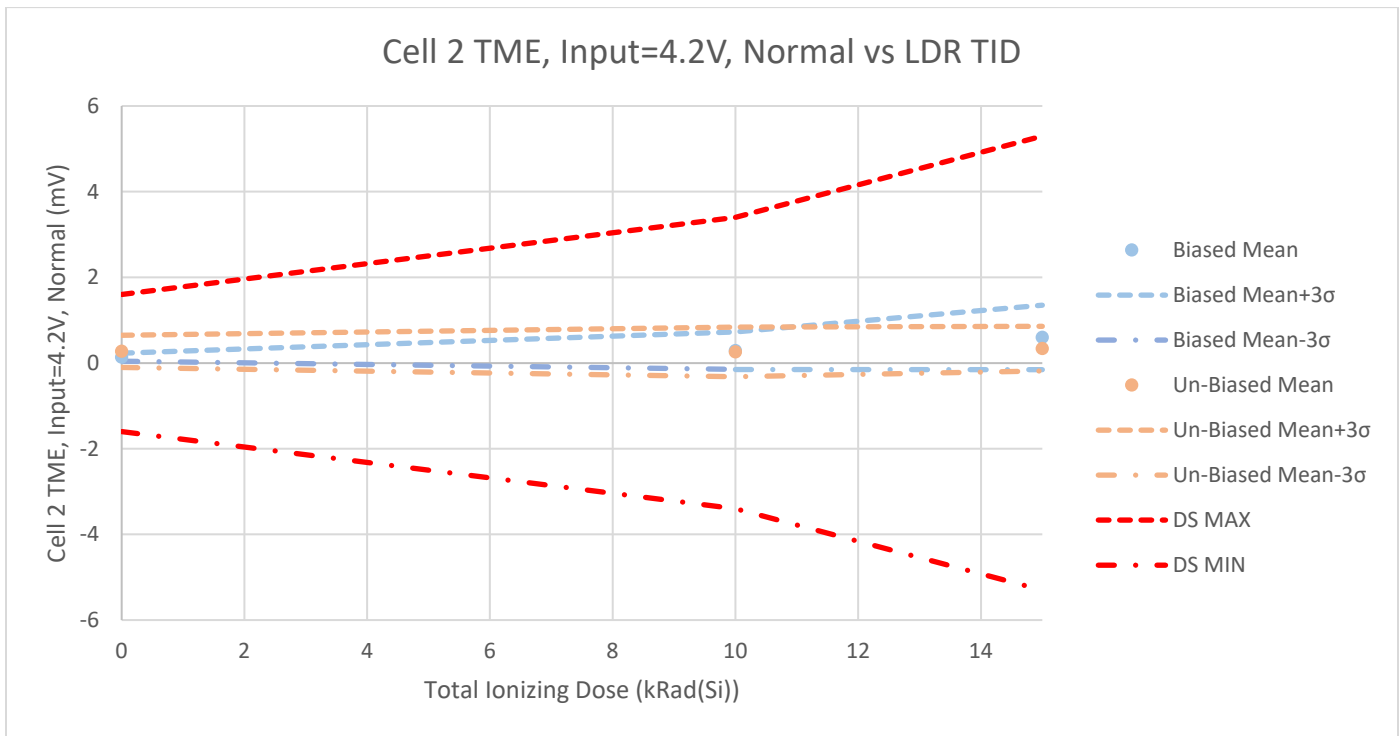

Table A-36-2. Cell 2 TME, Input = 4.2V, Normal vs. LDR TID for the RT6804HG-1.

Total Ionizing Dose (kRad(Si))	0	10	15	Units
LDR TID Biased				
Biased Mean	0.1374	0.2876	0.5988	mV
Std Dev	0.0312	0.1455	0.2504	
Biased Mean+3σ	0.2311	0.7241	1.3501	
Biased Mean-3σ	0.0437	-0.1488	-0.1524	
LDR TID Un-Biased				
Un-Biased Mean	0.2732	0.2602	0.3361	mV
Std Dev	0.1254	0.1927	0.1736	
Un-Biased Mean+3σ	0.6495	0.8382	0.8568	
Un-Biased Mean-3σ	-0.1030	-0.3178	-0.1845	
DS Limits				
DS MIN	-1.60E+00	-3.40E+00	-5.30E+00	mV
	PASS	PASS	PASS	
DS MAX	1.60E+00	3.40E+00	5.30E+00	mV
	PASS	PASS	PASS	

Figure A-37-1. Cell 3 TME, Input = 4.2V, Normal vs. HDR TID for the RT6804HG-1.

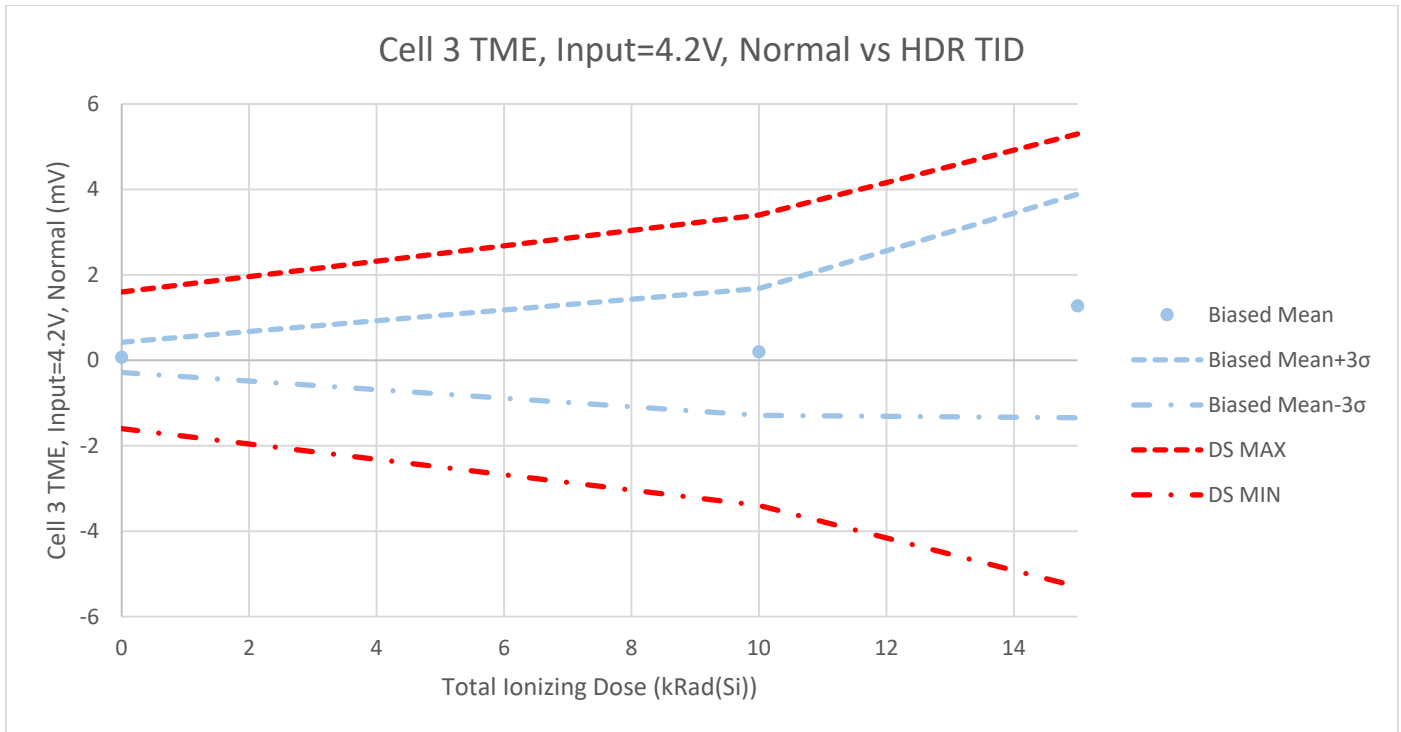

Table A-37-1. Cell 3 TME, Input = 4.2V, Normal vs. HDR TID for the RT6804HG-1.

HDR TID Biased				
Total Ionizing Dose (kRad(Si))	0	10	15	Units
Biased Mean	0.0694	0.1962	1.2727	mV
Std Dev	0.1180	0.4954	0.8722	
Biased Mean+3σ	0.4235	1.6824	3.8893	
Biased Mean-3σ	-0.2847	-1.2900	-1.3439	
DS MIN	-1.60E+00	-3.40E+00	-5.30E+00	mV
	PASS	PASS	PASS	
DS MAX	1.60E+00	3.40E+00	5.30E+00	mV
	PASS	PASS	PASS	

Figure A-37-2. Cell 3 TME, Input = 4.2V, Normal vs. LDR TID for the RT6804HG-1.

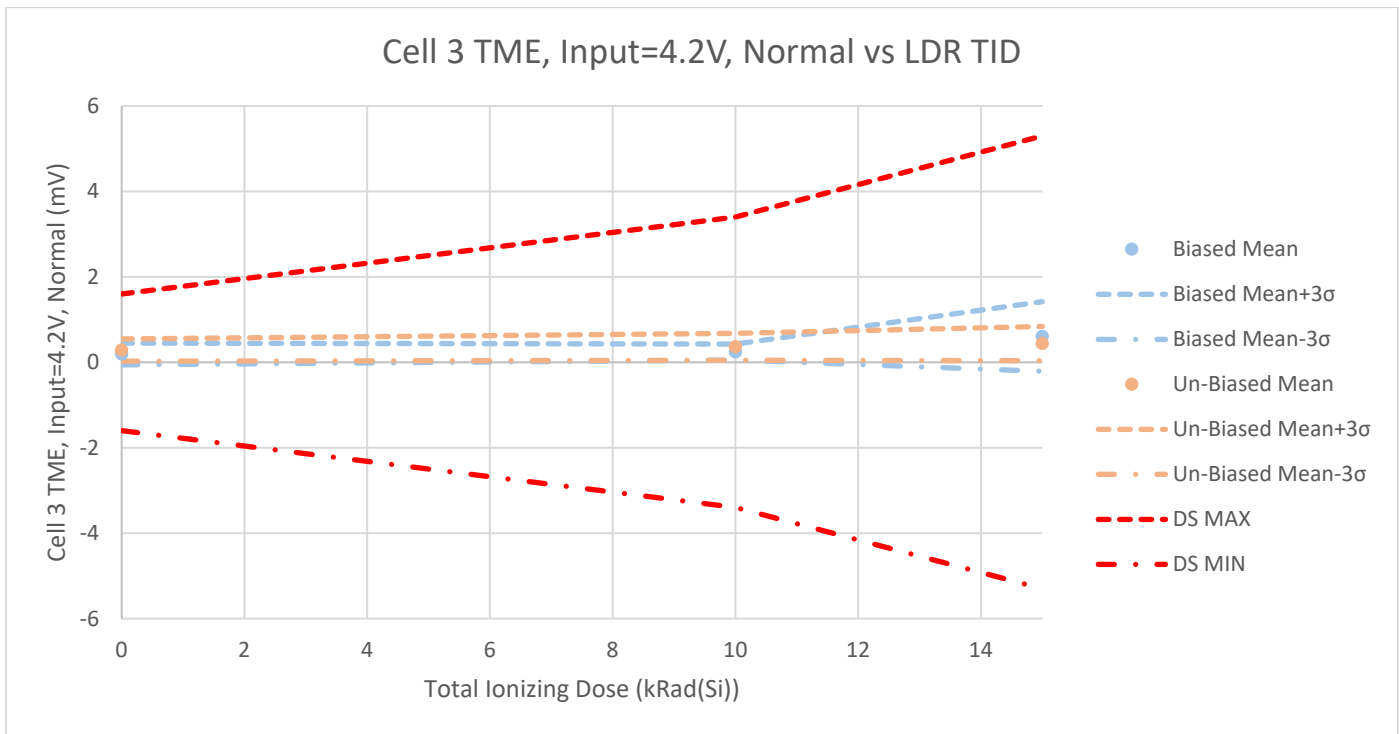

Table A-37-2. Cell 3 TME, Input = 4.2V, Normal vs. LDR TID for the RT6804HG-1.

Total Ionizing Dose (kRad(Si))	0	10	15	Units
LDR TID Biased				
Biased Mean	0.1944	0.2414	0.6055	mV
Std Dev	0.0847	0.0627	0.2722	
Biased Mean+3σ	0.4486	0.4295	1.4220	
Biased Mean-3σ	-0.0598	0.0532	-0.2110	
LDR TID Un-Biased				
Un-Biased Mean	0.2884	0.3634	0.4391	mV
Std Dev	0.0870	0.1050	0.1340	
Un-Biased Mean+3σ	0.5493	0.6784	0.8410	
Un-Biased Mean-3σ	0.0275	0.0484	0.0372	
DS Limits				
DS MIN	-1.60E+00	-3.40E+00	-5.30E+00	mV
	PASS	PASS	PASS	
DS MAX	1.60E+00	3.40E+00	5.30E+00	mV
	PASS	PASS	PASS	

Figure A-38-1. Cell 4 TME, Input = 4.2V, Normal vs. HDR TID for the RT6804HG-1.

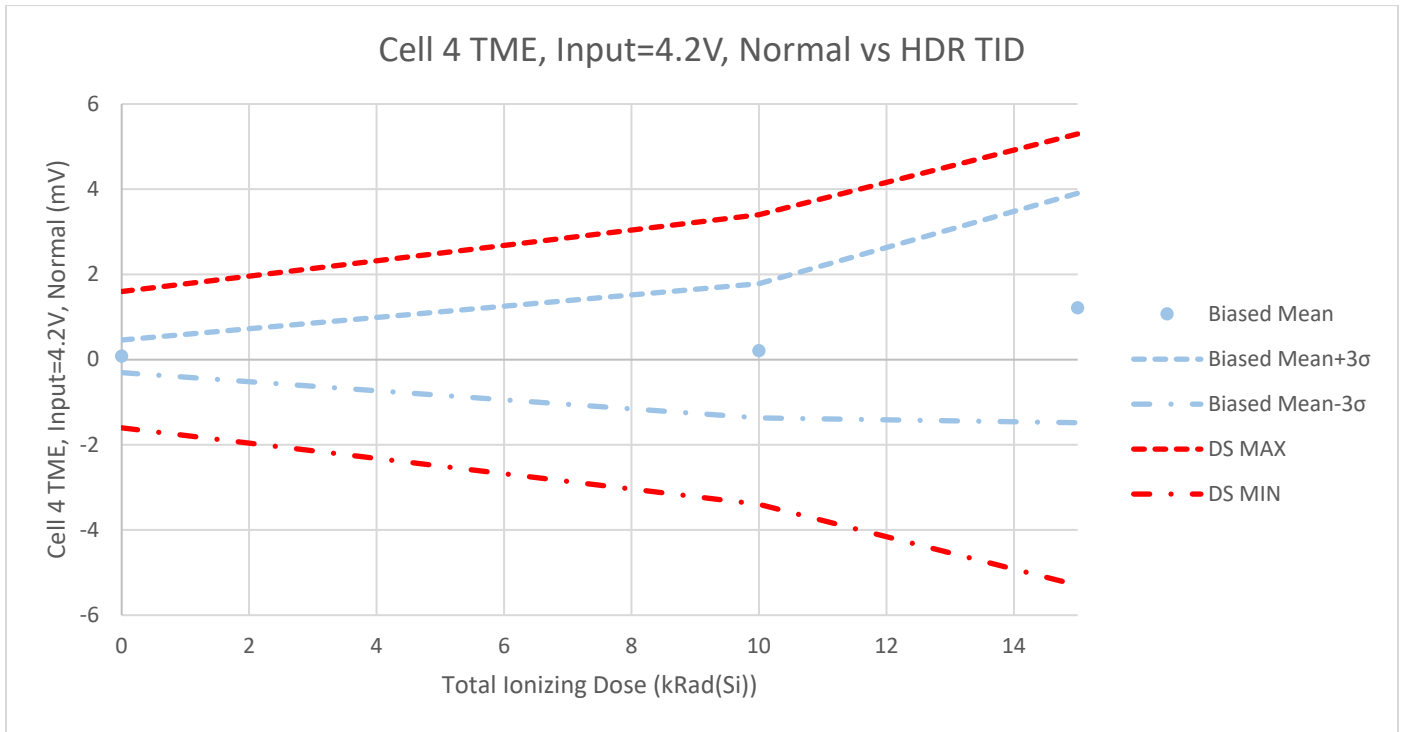

Table A-38-1. Cell 4 TME, Input = 4.2V, Normal vs. HDR TID for the RT6804HG-1.

HDR TID Biased				
Total Ionizing Dose (kRad(Si))	0	10	15	Units
Biased Mean	0.0779	0.2062	1.2127	mV
Std Dev	0.1279	0.5252	0.8977	
Biased Mean+3σ	0.4615	1.7817	3.9057	
Biased Mean-3σ	-0.3058	-1.3693	-1.4803	
DS MIN	-1.60E+00	-3.40E+00	-5.30E+00	mV
	PASS	PASS	PASS	
DS MAX	1.60E+00	3.40E+00	5.30E+00	mV
	PASS	PASS	PASS	

Figure A-38-2. Cell 4 TME, Input = 4.2V, Normal vs. LDR TID for the RT6804HG-1.

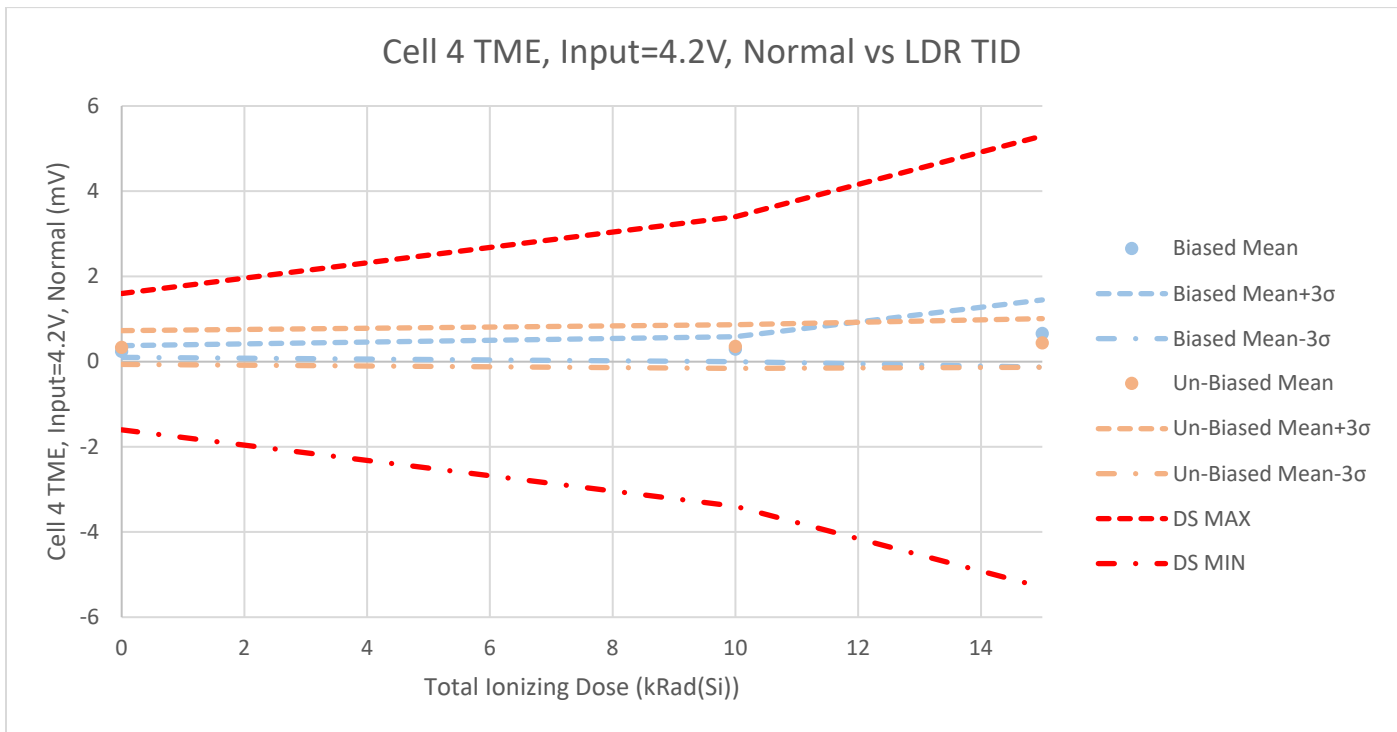

Table A-38-2. Cell 4 TME, Input = 4.2V, Normal vs. LDR TID for the RT6804HG-1.

Total Ionizing Dose (kRad(Si))	0	10	15	Units
LDR TID Biased				
Biased Mean	0.2377	0.2900	0.6591	mV
Std Dev	0.0453	0.0980	0.2631	
Biased Mean+3σ	0.3737	0.5839	1.4483	
Biased Mean-3σ	0.1017	-0.0039	-0.1300	
LDR TID Un-Biased				
Un-Biased Mean	0.3311	0.3528	0.4365	mV
Std Dev	0.1319	0.1712	0.1908	
Un-Biased Mean+3σ	0.7268	0.8664	1.0091	
Un-Biased Mean-3σ	-0.0647	-0.1609	-0.1360	
DS Limits				
DS MIN	-1.60E+00	-3.40E+00	-5.30E+00	mV
	PASS	PASS	PASS	
DS MAX	1.60E+00	3.40E+00	5.30E+00	mV
	PASS	PASS	PASS	

Figure A-39-1. Cell 5 TME, Input = 4.2V, Normal vs. HDR TID for the RT6804HG-1.

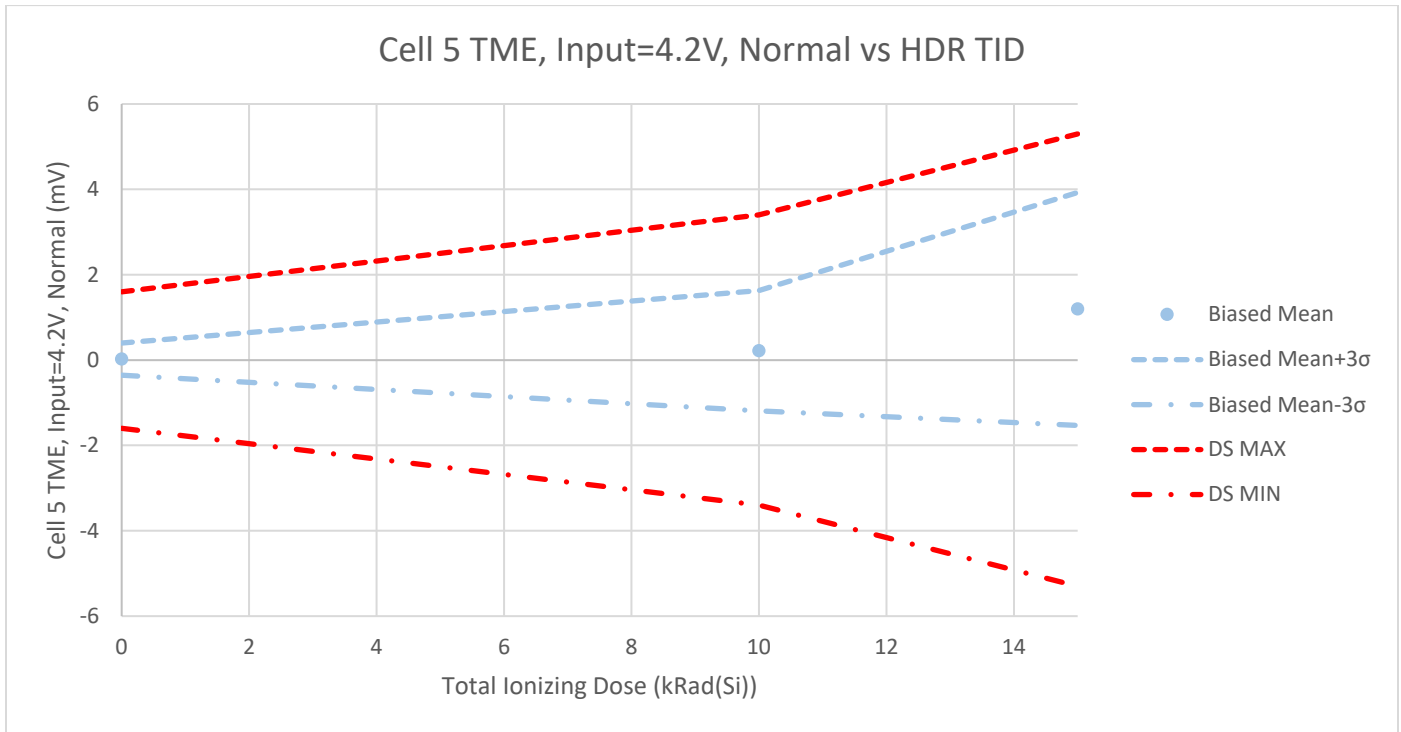

Table A-39-1. Cell 5 TME, Input = 4.2V, Normal vs. HDR TID for the RT6804HG-1.

HDR TID Biased				
Total Ionizing Dose (kRad(Si))	0	10	15	Units
Biased Mean	0.0233	0.2183	1.1978	mV
Std Dev	0.1254	0.4700	0.9098	
Biased Mean+3σ	0.3997	1.6282	3.9273	
Biased Mean-3σ	-0.3530	-1.1915	-1.5318	
DS MIN	-1.60E+00	-3.40E+00	-5.30E+00	mV
	PASS	PASS	PASS	
DS MAX	1.60E+00	3.40E+00	5.30E+00	mV
	PASS	PASS	PASS	

Figure A-39-2. Cell 5 TME, Input = 4.2V, Normal vs. LDR TID for the RT6804HG-1.

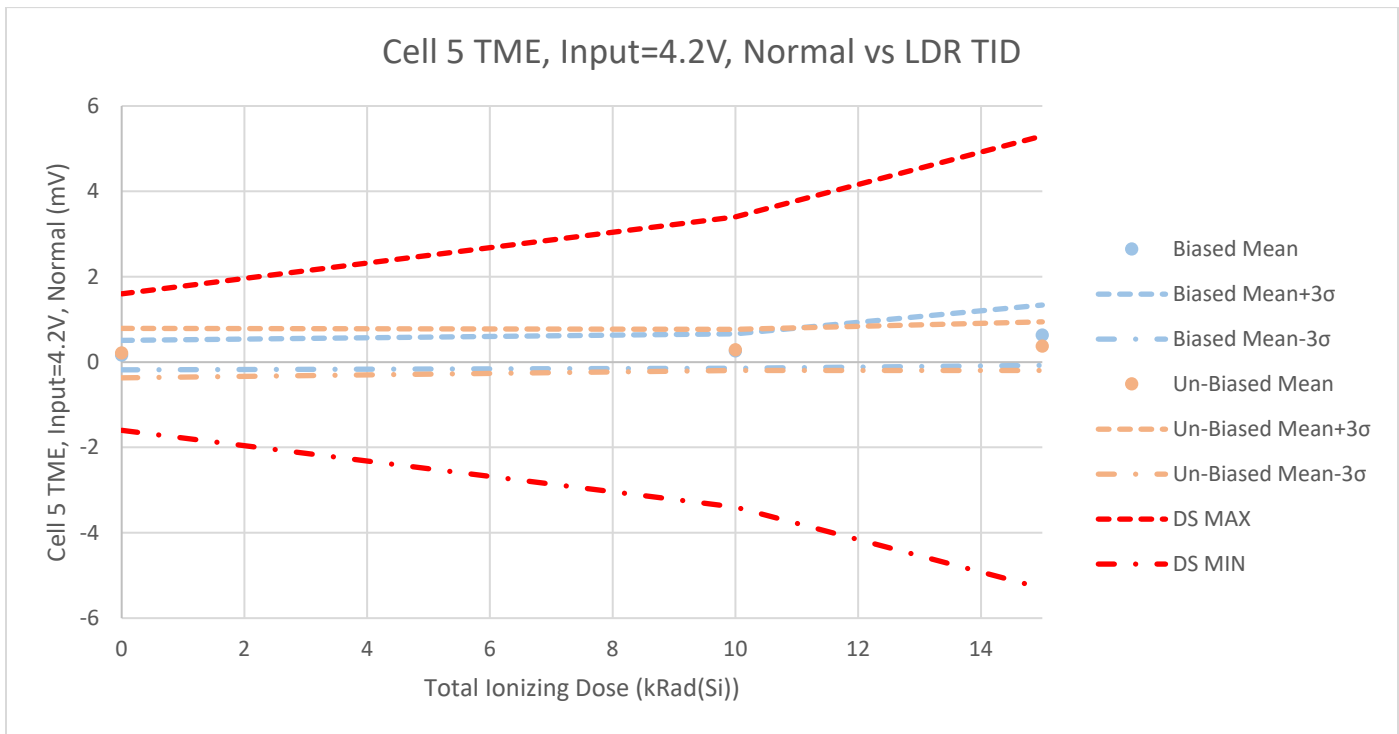

Table A-39-2. Cell 5 TME, Input = 4.2V, Normal vs. LDR TID for the RT6804HG-1.

Total Ionizing Dose (kRad(Si))	0	10	15	Units
LDR TID Biased				
Biased Mean	0.1619	0.2571	0.6298	mV
Std Dev	0.1150	0.1341	0.2356	
Biased Mean+3σ	0.5070	0.6595	1.3365	
Biased Mean-3σ	-0.1832	-0.1452	-0.0770	
LDR TID Un-Biased				
Un-Biased Mean	0.2083	0.2848	0.3720	mV
Std Dev	0.1928	0.1605	0.1899	
Un-Biased Mean+3σ	0.7867	0.7663	0.9418	
Un-Biased Mean-3σ	-0.3700	-0.1968	-0.1978	
DS Limits				
DS MIN	-1.60E+00	-3.40E+00	-5.30E+00	mV
	PASS	PASS	PASS	
DS MAX	1.60E+00	3.40E+00	5.30E+00	mV
	PASS	PASS	PASS	

Figure A-40-1. Cell 6 TME, Input = 4.2V, Normal vs. HDR TID for the RT6804HG-1.

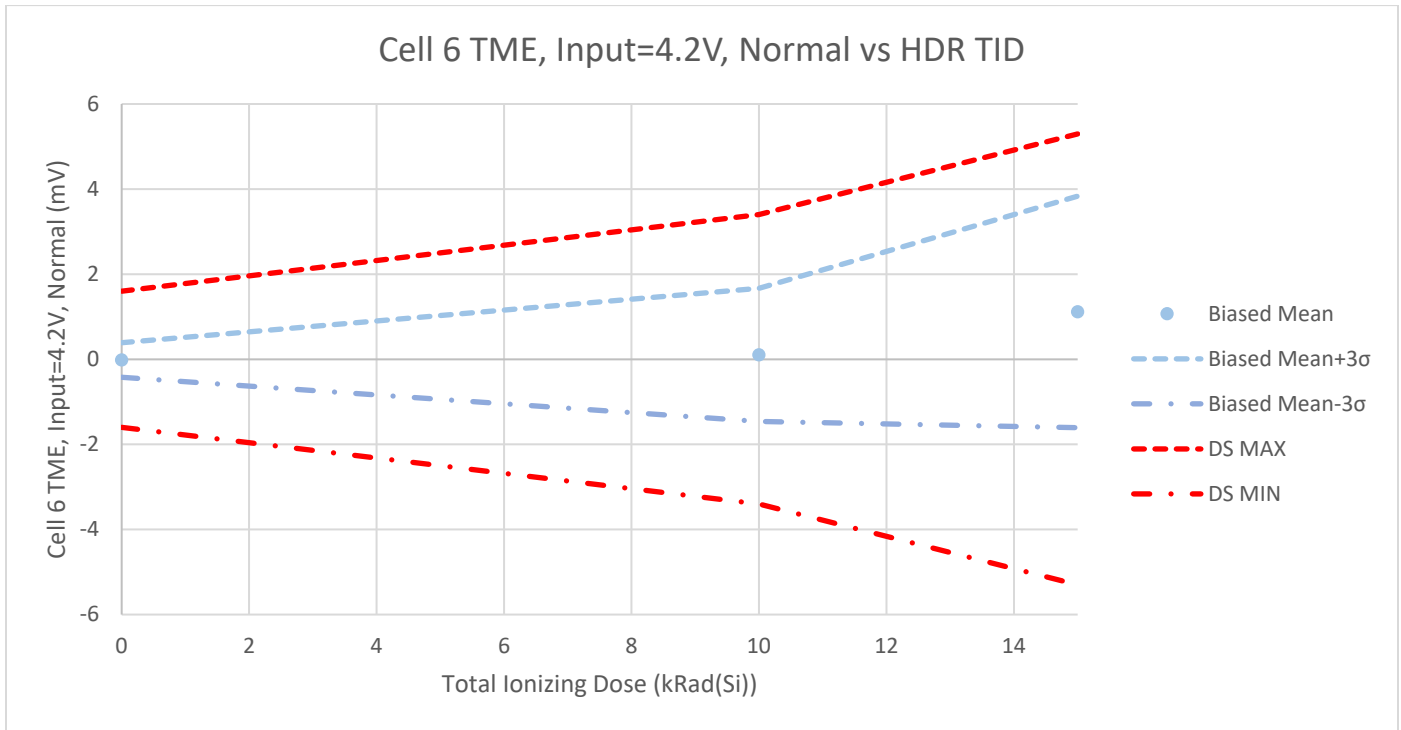

Table A-40-1. Cell 6 TME, Input = 4.2V, Normal vs. HDR TID for the RT6804HG-1.

HDR TID Biased				
Total Ionizing Dose (kRad(Si))	0	10	15	Units
Biased Mean	-0.0163	0.1033	1.1148	mV
Std Dev	0.1352	0.5211	0.9075	
Biased Mean+3σ	0.3892	1.6665	3.8372	
Biased Mean-3σ	-0.4217	-1.4599	-1.6076	
DS MIN	-1.60E+00	-3.40E+00	-5.30E+00	mV
	PASS	PASS	PASS	
DS MAX	1.60E+00	3.40E+00	5.30E+00	mV
	PASS	PASS	PASS	

Figure A-40-2. Cell 6 TME, Input = 4.2V, Normal vs. LDR TID for the RT6804HG-1.

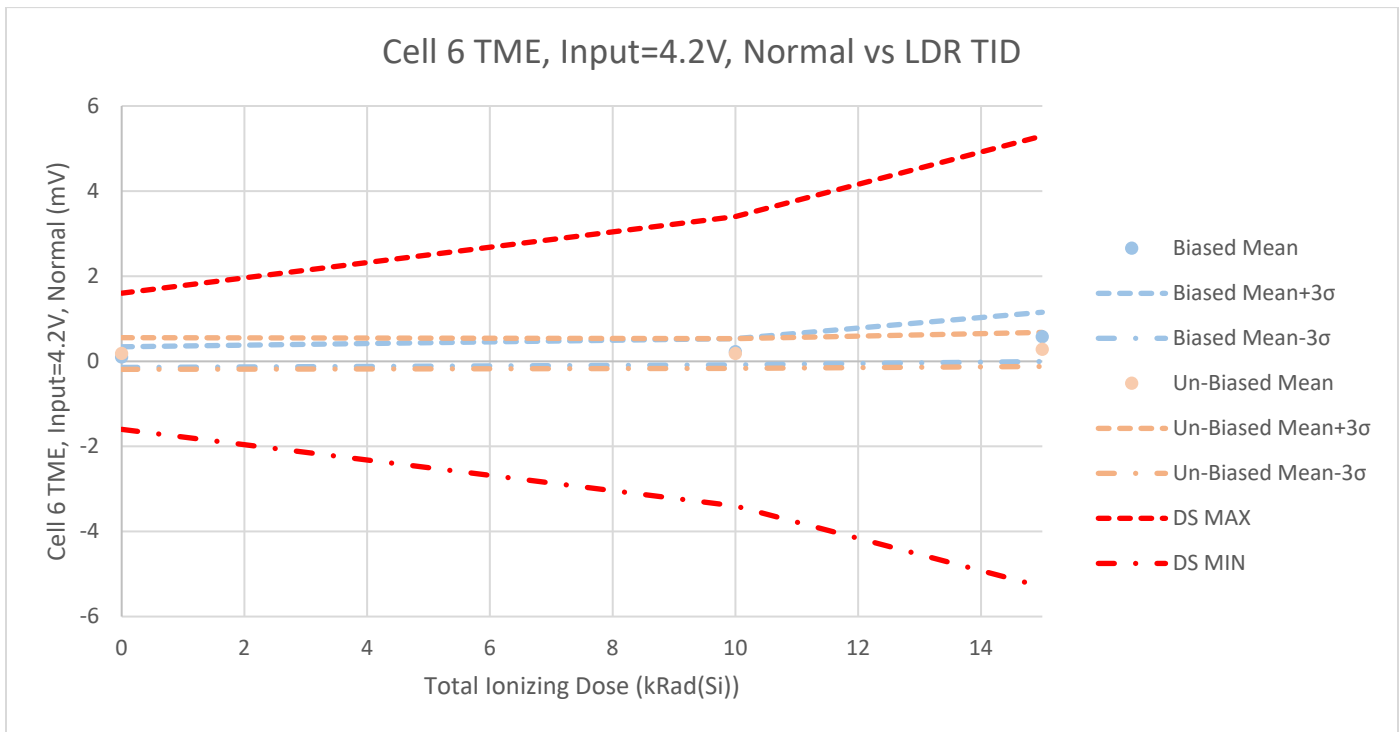

Table A-40-2. Cell 6 TME, Input = 4.2V, Normal vs. LDR TID for the RT6804HG-1.

Total Ionizing Dose (kRad(Si))	0	10	15	Units
LDR TID Biased				
Biased Mean	0.0988	0.2239	0.5755	mV
Std Dev	0.0806	0.1033	0.1931	
Biased Mean+3σ	0.3404	0.5336	1.1546	
Biased Mean-3σ	-0.1429	-0.0859	-0.0037	
LDR TID Un-Biased				
Un-Biased Mean	0.1841	0.1827	0.2799	mV
Std Dev	0.1239	0.1169	0.1334	
Un-Biased Mean+3σ	0.5557	0.5333	0.6799	
Un-Biased Mean-3σ	-0.1875	-0.1679	-0.1202	
DS MIN	-1.60E+00	-3.40E+00	-5.30E+00	mV
	PASS	PASS	PASS	
DS MAX	1.60E+00	3.40E+00	5.30E+00	mV
	PASS	PASS	PASS	

Figure A-41-1. Cell 7 TME, Input = 4.2V, Normal vs. HDR TID for the RT6804HG-1.

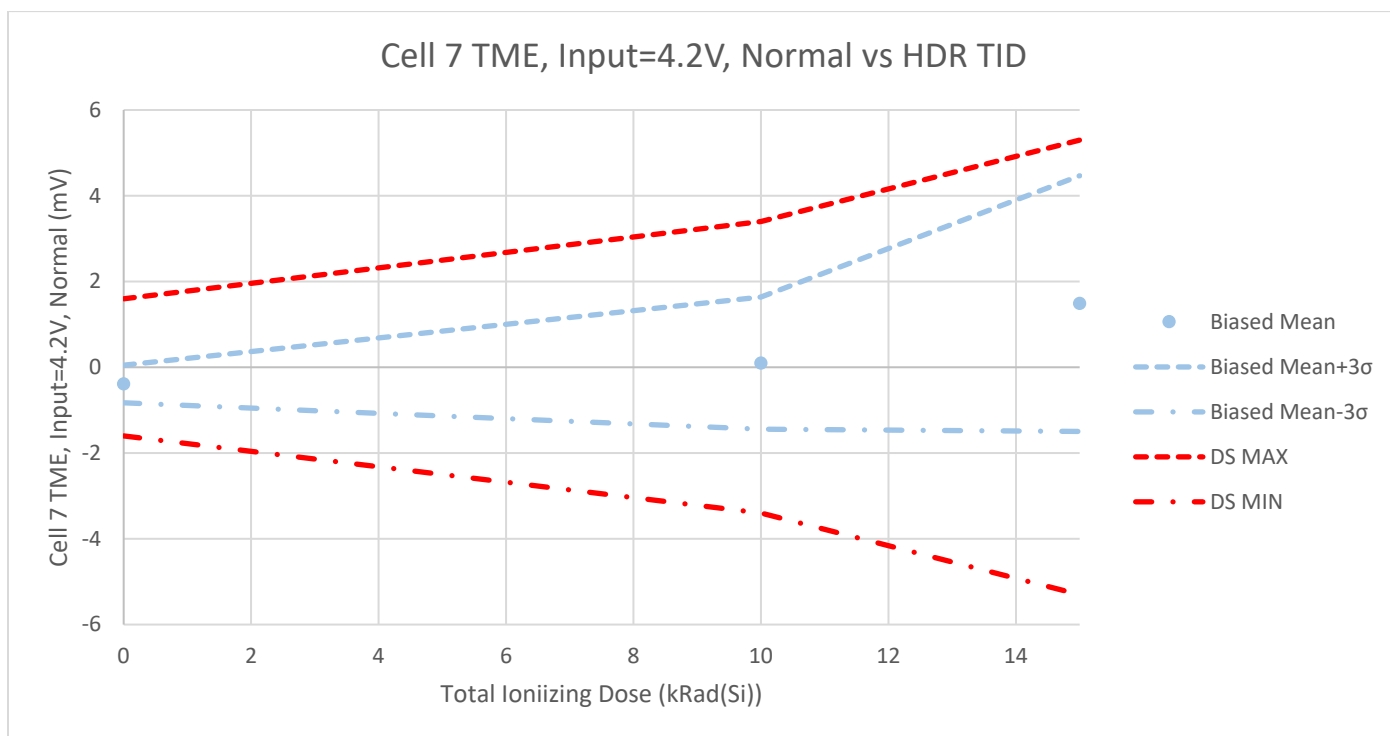

Table A-41-1. Cell 7 TME, Input = 4.2V, Normal vs. HDR TID for the RT6804HG-1.

HDR TID Biased				
Total Ionizing Dose (kRad(Si))	0	10	15	Units
Biased Mean	-0.3891	0.0960	1.4870	mV
Std Dev	0.1462	0.5140	0.9933	
Biased Mean+3σ	0.0497	1.6380	4.4670	
Biased Mean-3σ	-0.8278	-1.4459	-1.4930	
DS MIN	-1.60E+00	-3.40E+00	-5.30E+00	mV
	PASS	PASS	PASS	
DS MAX	1.60E+00	3.40E+00	5.30E+00	mV
	PASS	PASS	PASS	

Figure A-41-2. Cell 7 TME, Input = 4.2V, Normal vs. LDR TID for the RT6804HG-1.

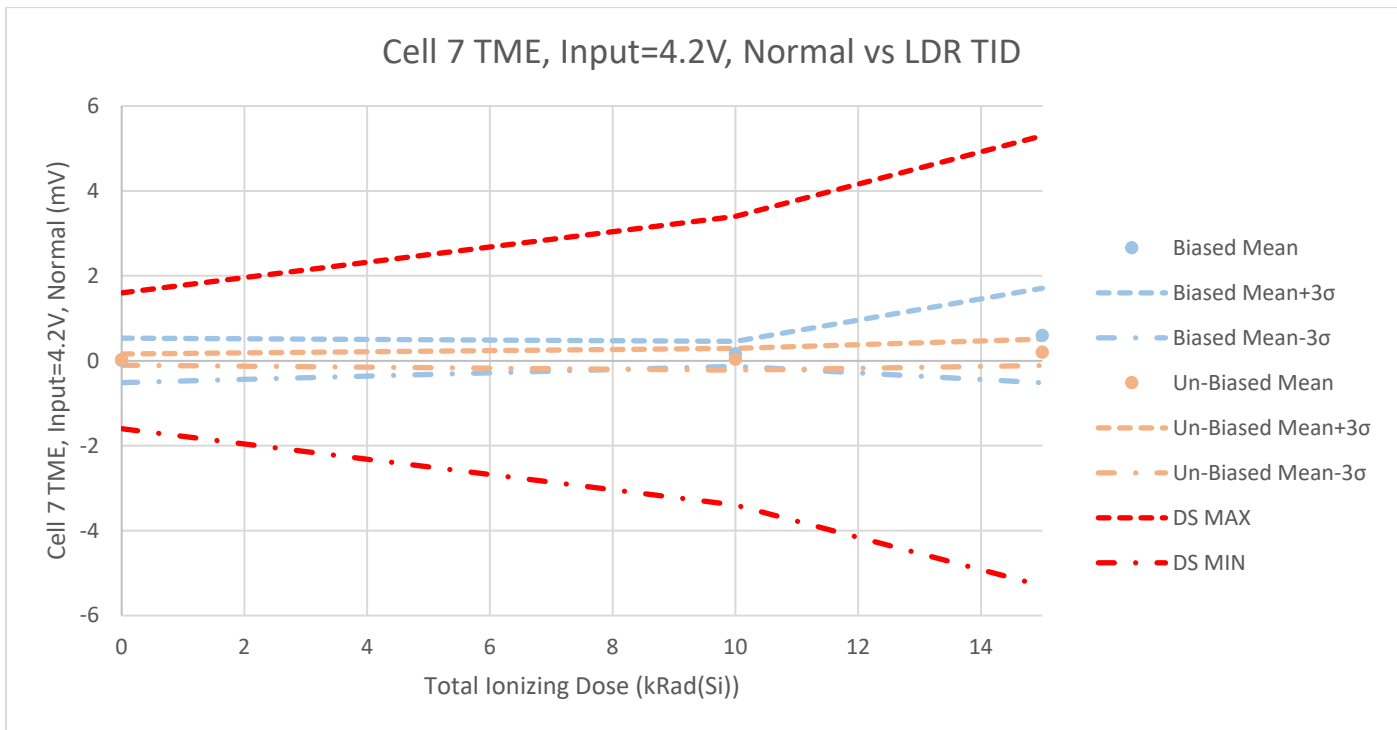

Table A-41-2. Cell 7 TME, Input = 4.2V, Normal vs. LDR TID for the RT6804HG-1.

Total Ionizing Dose (kRad(Si))	0	10	15	Units
LDR TID Biased				
Biased Mean	0.0086	0.1636	0.5960	mV
Std Dev	0.1750	0.0981	0.3713	
Biased Mean+3σ	0.5336	0.4581	1.7099	
Biased Mean-3σ	-0.5165	-0.1308	-0.5178	
LDR TID Un-Biased				
Un-Biased Mean	0.0282	0.0353	0.1992	mV
Std Dev	0.0441	0.0850	0.1036	
Un-Biased Mean+3σ	0.1606	0.2902	0.5099	
Un-Biased Mean-3σ	-0.1043	-0.2196	-0.1115	
DS MIN	-1.60E+00	-3.40E+00	-5.30E+00	mV
	PASS	PASS	PASS	
DS MAX	1.60E+00	3.40E+00	5.30E+00	mV
	PASS	PASS	PASS	

Figure A-42-1. Cell 8 TME, Input = 4.2V, Normal vs. HDR TID for the RT6804HG-1.

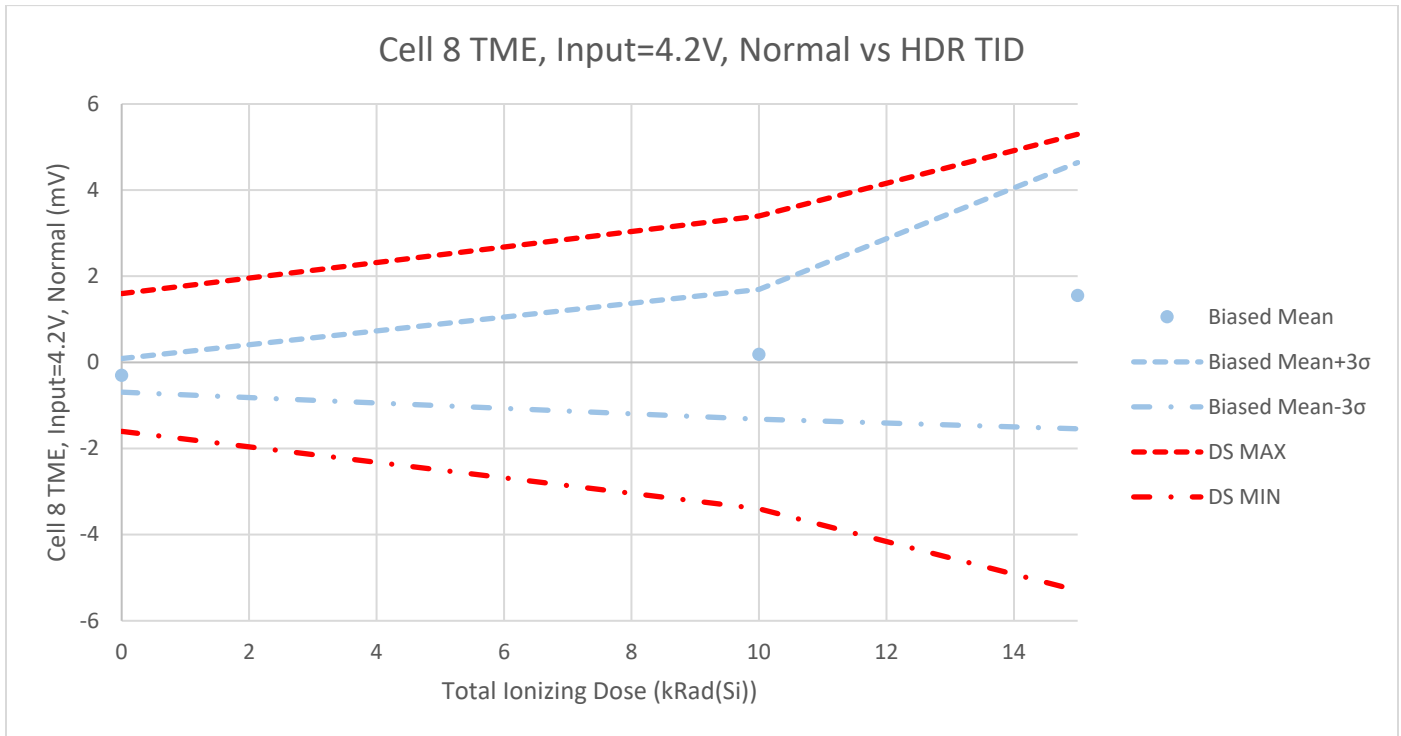

Table A-42-1. Cell 8 TME, Input = 4.2V, Normal vs. HDR TID for the RT6804HG-1.

HDR TID Biased				
Total Ionizing Dose (kRad(Si))	0	10	15	Units
Biased Mean	-0.3016	0.1859	1.5502	mV
Std Dev	0.1298	0.5020	1.0305	
Biased Mean+3σ	0.0878	1.6919	4.6416	
Biased Mean-3σ	-0.6909	-1.3201	-1.5411	
DS MIN	-1.60E+00	-3.40E+00	-5.30E+00	mV
	PASS	PASS	PASS	
DS MAX	1.60E+00	3.40E+00	5.30E+00	mV
	PASS	PASS	PASS	

Figure A-42-2. Cell 8 TME, Input = 4.2V, Normal vs. LDR TID for the RT6804HG-1.

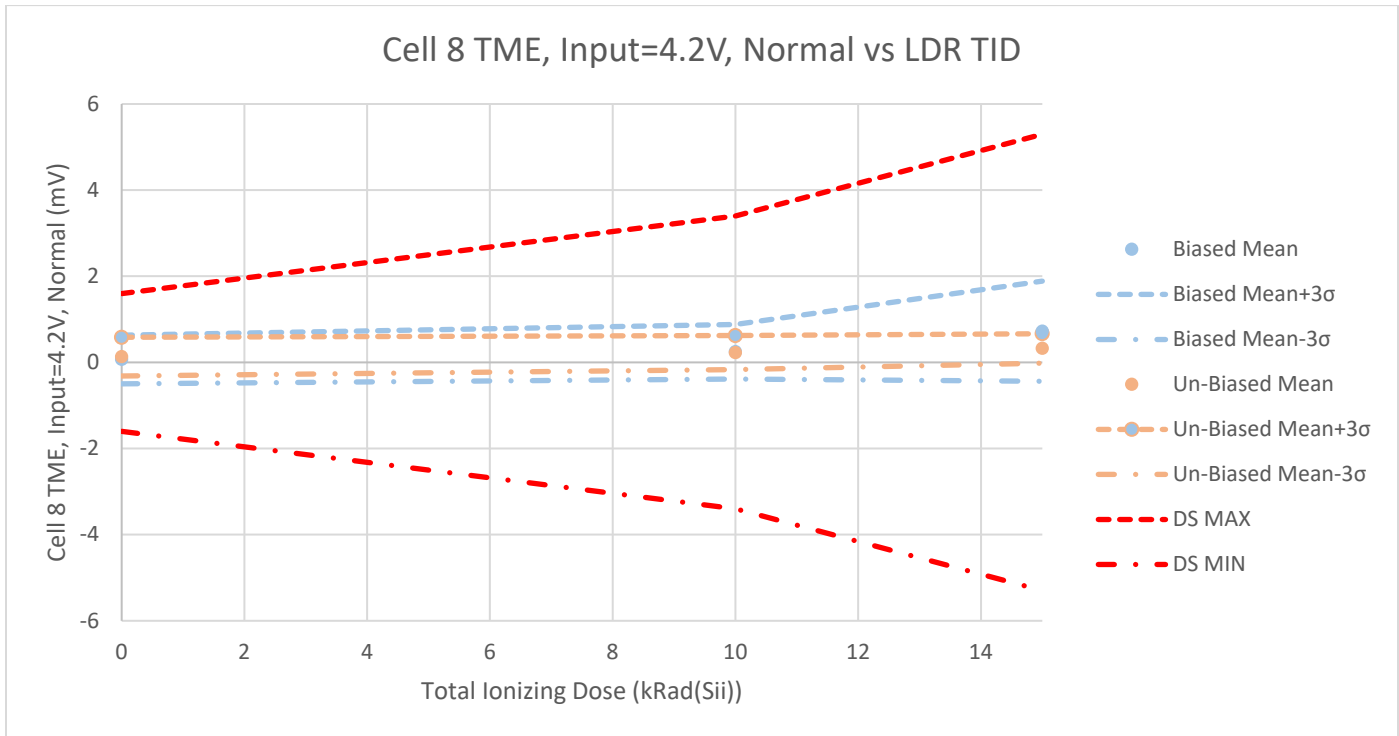

Table A-42-2. Cell 8 TME, Input = 4.2V, Normal vs. LDR TID for the RT6804HG-1.

Total Ionizing Dose (kRad(Si))	0	10	15	Units
LDR TID Biased				
Biased Mean	0.0677	0.2471	0.7240	mV
Std Dev	0.1882	0.2109	0.3875	
Biased Mean+3σ	0.6322	0.8799	1.8864	
Biased Mean-3σ	-0.4968	-0.3856	-0.4384	
LDR TID Un-Biased				
Un-Biased Mean	0.1334	0.2264	0.3243	mV
Std Dev	0.1495	0.1318	0.1142	
Un-Biased Mean+3σ	0.5820	0.6217	0.6668	
Un-Biased Mean-3σ	-0.3152	-0.1690	-0.0182	
DS MIN	-1.60E+00	-3.40E+00	-5.30E+00	mV
	PASS	PASS	PASS	
DS MAX	1.60E+00	3.40E+00	5.30E+00	mV
	PASS	PASS	PASS	

Figure A-43-1. Cell 9 TME, Input = 4.2V, Normal vs. HDR TID for the RT6804HG-1.

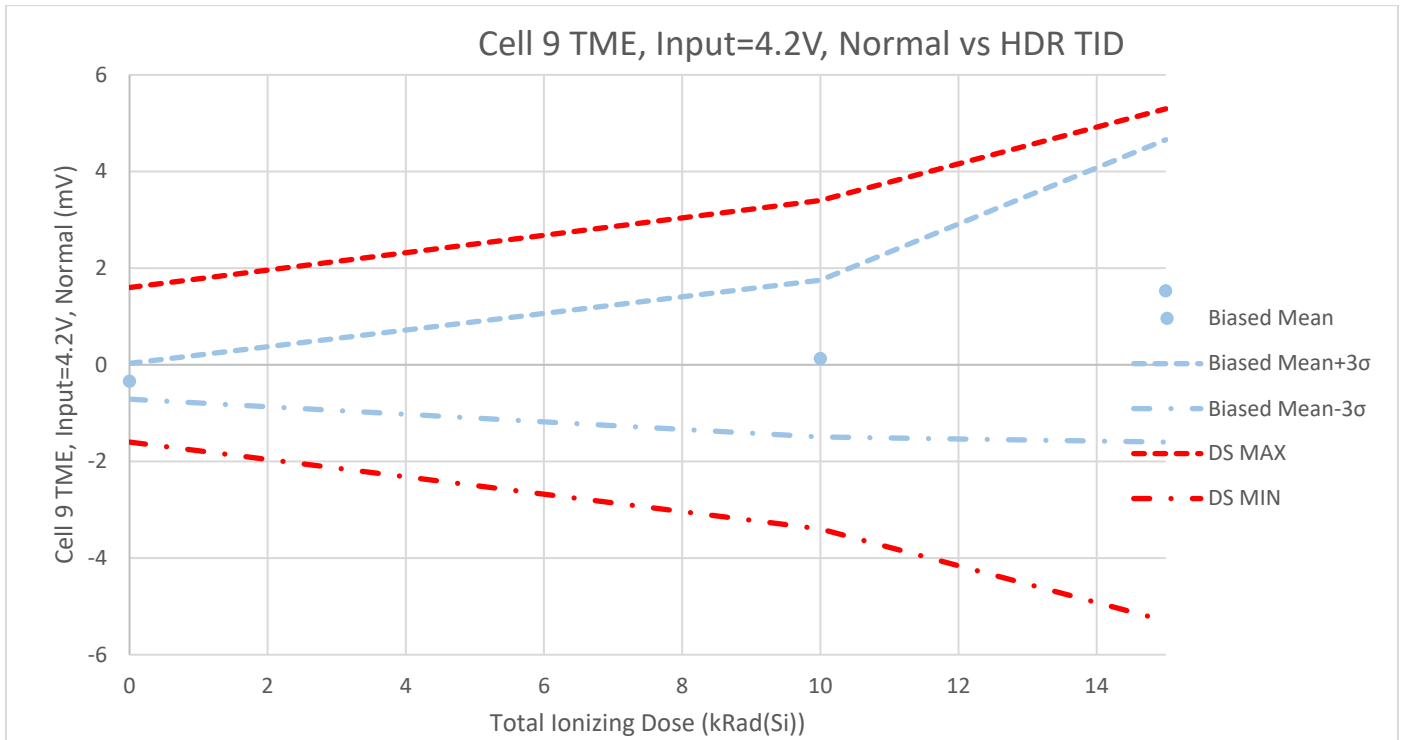

Table A-43-1. Cell 9 TME, Input = 4.2V, Normal vs. HDR TID for the RT6804HG-1.

HDR TID Biased				
Total Ionizing Dose (kRad(Si))	0	10	15	Units
Biased Mean	-0.3410	0.1294	1.5307	mV
Std Dev	0.1235	0.5409	1.0428	
Biased Mean+3σ	0.0294	1.7522	4.6591	
Biased Mean-3σ	-0.7114	-1.4933	-1.5978	
DS MIN	-1.60E+00	-3.40E+00	-5.30E+00	mV
	PASS	PASS	PASS	
DS MAX	1.60E+00	3.40E+00	5.30E+00	mV
	PASS	PASS	PASS	

Figure A-43-2. Cell 9 TME, Input = 4.2V, Normal vs. LDR TID for the RT6804HG-1.

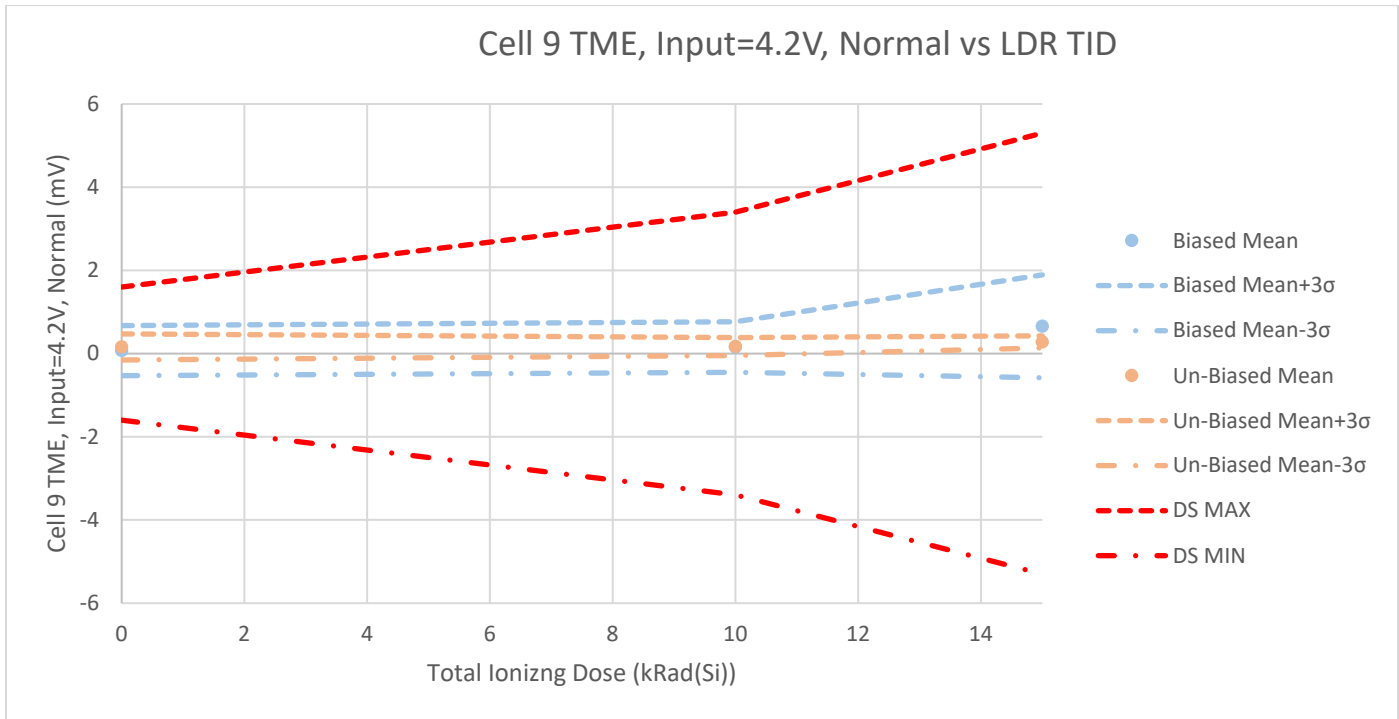

Table A-43-2. Cell 9 TME, Input = 4.2V, Normal vs. LDR TID for the RT6804HG-1.

Total Ionizing Dose (kRad(Si))	0	10	15	Units
LDR TID Biased				
Biased Mean	0.0718	0.1568	0.6554	mV
Std Dev	0.2011	0.2021	0.4121	
Biased Mean+3σ	0.6751	0.7633	1.8917	
Biased Mean-3σ	-0.5315	-0.4496	-0.5810	
LDR TID Un-Biased				
Un-Biased Mean	0.1597	0.1699	0.2800	mV
Std Dev	0.1048	0.0721	0.0488	
Un-Biased Mean+3σ	0.4742	0.3861	0.4265	
Un-Biased Mean-3σ	-0.1548	-0.0463	0.1336	
DS MIN	-1.60E+00	-3.40E+00	-5.30E+00	mV
	PASS	PASS	PASS	
DS MAX	1.60E+00	3.40E+00	5.30E+00	mV
	PASS	PASS	PASS	

Figure A-44-1. Cell 10 TME, Input = 4.2V, Normal vs. HDR TID for the RT6804HG-1.

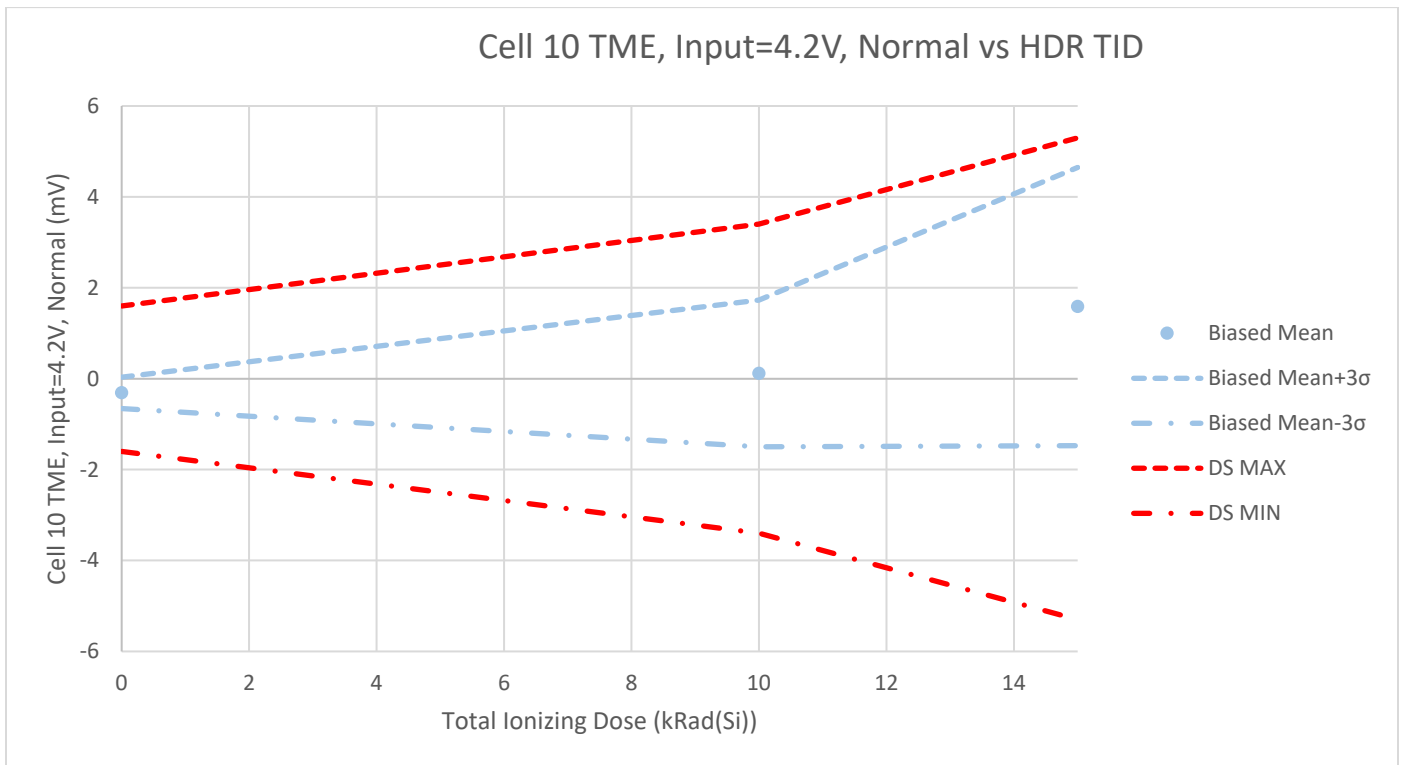

Table A-44-1. Cell 10 TME, Input = 4.2V, Normal vs. HDR TID for the RT6804HG-1.

HDR TID Biased				
Total Ionizing Dose (kRad(Si))	0	10	15	Units
Biased Mean	-0.3105	0.1160	1.5882	mV
Std Dev	0.1154	0.5383	1.0205	
Biased Mean+3σ	0.0357	1.7310	4.6498	
Biased Mean-3σ	-0.6567	-1.4990	-1.4734	
DS MIN	-1.60E+00	-3.40E+00	-5.30E+00	mV
	PASS	PASS	PASS	
DS MAX	1.60E+00	3.40E+00	5.30E+00	mV
	PASS	PASS	PASS	

Figure A-44-2. Cell 10 TME, Input = 4.2V, Normal vs. LDR TID for the RT6804HG-1.

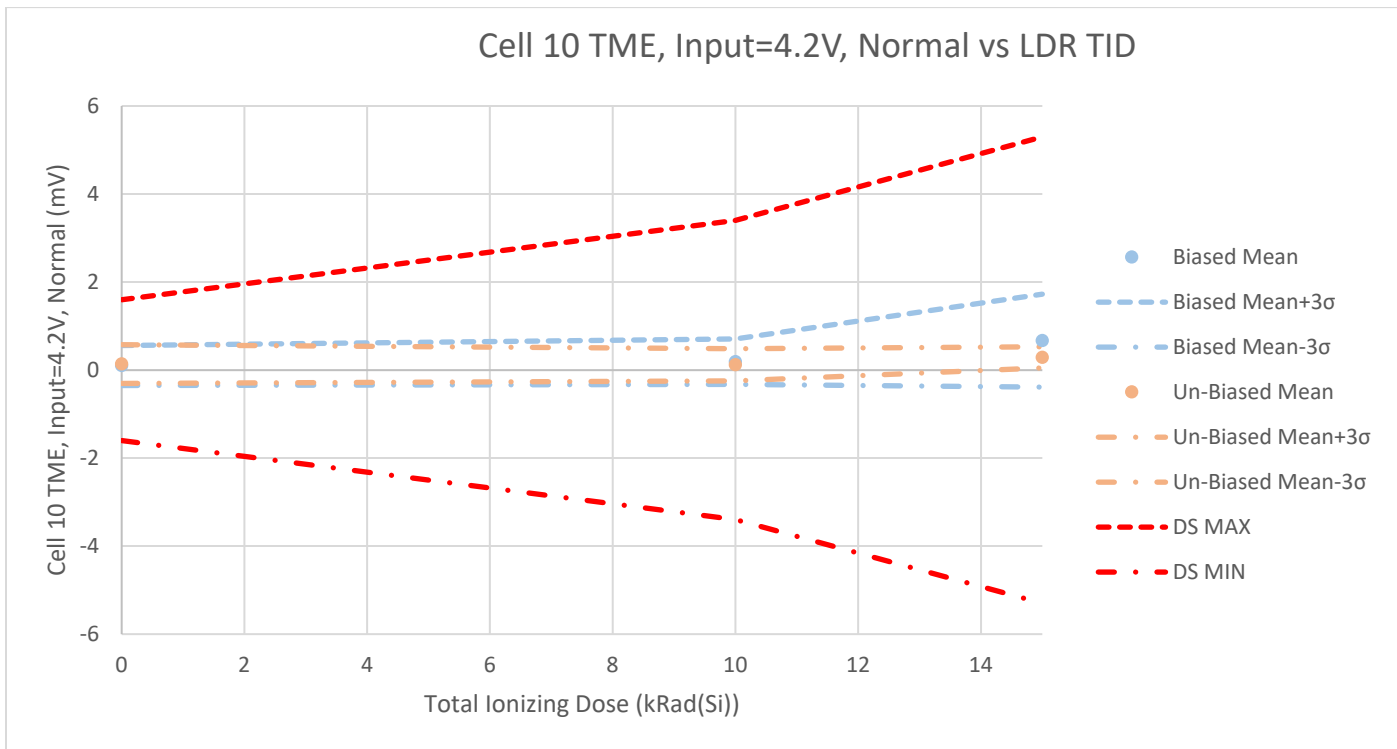

Table A-44-2. Cell 10 TME, Input = 4.2V, Normal vs. LDR TID for the RT6804HG-1.

Total Ionizing Dose (kRad(Si))	0	10	15	Units
LDR TID Biased				
Biased Mean	0.1031	0.1892	0.6697	mV
Std Dev	0.1517	0.1721	0.3517	
Biased Mean+3σ	0.5583	0.7055	1.7250	
Biased Mean-3σ	-0.3521	-0.3271	-0.3855	
LDR TID Un-Biased				
Un-Biased Mean	0.1372	0.1190	0.2881	mV
Std Dev	0.1469	0.1217	0.0798	
Un-Biased Mean+3σ	0.5778	0.4841	0.5273	
Un-Biased Mean-3σ	-0.3033	-0.2460	0.0488	
DS MIN	-1.60E+00	-3.40E+00	-5.30E+00	mV
	PASS	PASS	PASS	
DS MAX	1.60E+00	3.40E+00	5.30E+00	mV
	PASS	PASS	PASS	

Figure A-45-1. Cell 11 TME, Input = 4.2V, Normal vs. HDR TID for the RT6804HG-1.

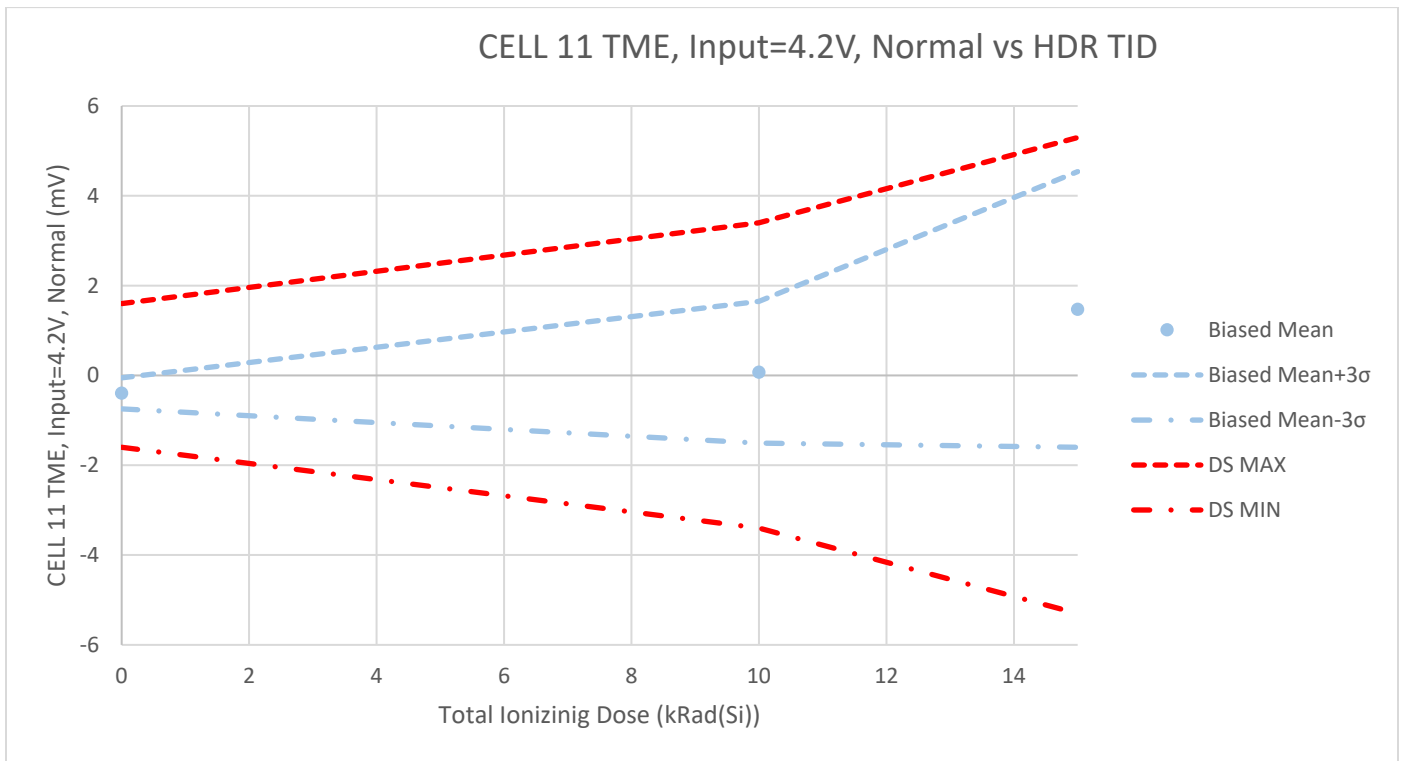

Table A-45-1. Cell 11 TME, Input = 4.2V, Normal vs. HDR TID for the RT6804HG-1.

HDR TID Biased				
Total Ionizing Dose (kRad(Si))	0	10	15	Units
Biased Mean	-0.3974	0.0710	1.4706	mV
Std Dev	0.1152	0.5259	1.0228	
Biased Mean+3σ	-0.0519	1.6486	4.5389	
Biased Mean-3σ	-0.7430	-1.5067	-1.5978	
DS MIN	-1.60E+00	-3.40E+00	-5.30E+00	mV
	PASS	PASS	PASS	
DS MAX	1.60E+00	3.40E+00	5.30E+00	mV
	PASS	PASS	PASS	

Figure A-45-2. Cell 11 TME, Input = 4.2V, Normal vs. LDR TID for the RT6804HG-1.

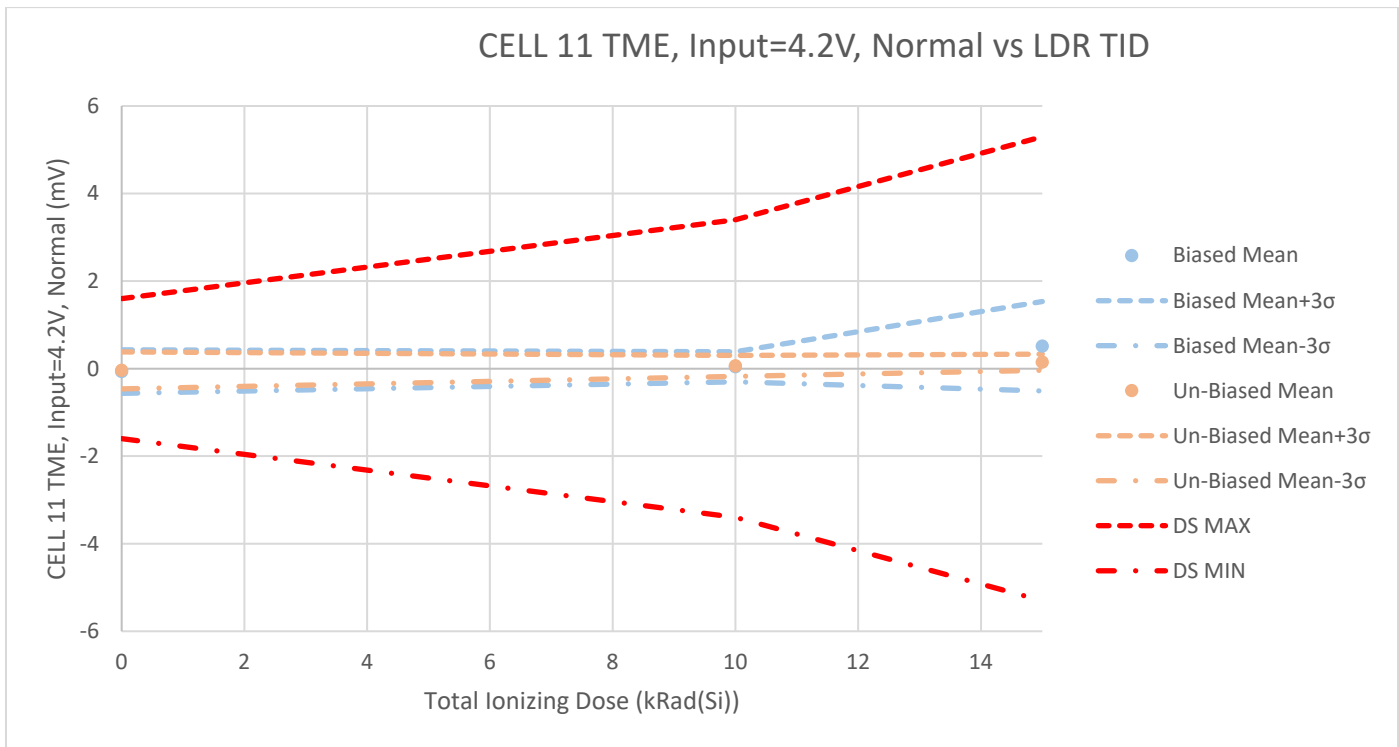

Table A-45-2. Cell 11 TME, Input = 4.2V, Normal vs. LDR TID for the RT6804HG-1.

Total Ionizing Dose (kRad(Si))	0	10	15	Units
LDR TID Biased				
Biased Mean	-0.0669	0.0422	0.5134	mV
Std Dev	0.1653	0.1148	0.3408	
Biased Mean+3σ	0.4290	0.3867	1.5359	
Biased Mean-3σ	-0.5628	-0.3023	-0.5091	
LDR TID Un-Biased				
Un-Biased Mean	-0.0391	0.0616	0.1479	mV
Std Dev	0.1412	0.0804	0.0612	
Un-Biased Mean+3σ	0.3843	0.3029	0.3314	
Un-Biased Mean-3σ	-0.4626	-0.1796	-0.0357	
DS MIN	-1.60E+00	-3.40E+00	-5.30E+00	mV
	PASS	PASS	PASS	
DS MAX	1.60E+00	3.40E+00	5.30E+00	mV
	PASS	PASS	PASS	

Figure A-46-1. Cell 12 TME, Input = 4.2V, Normal vs. HDR TID for the RT6804HG-1.

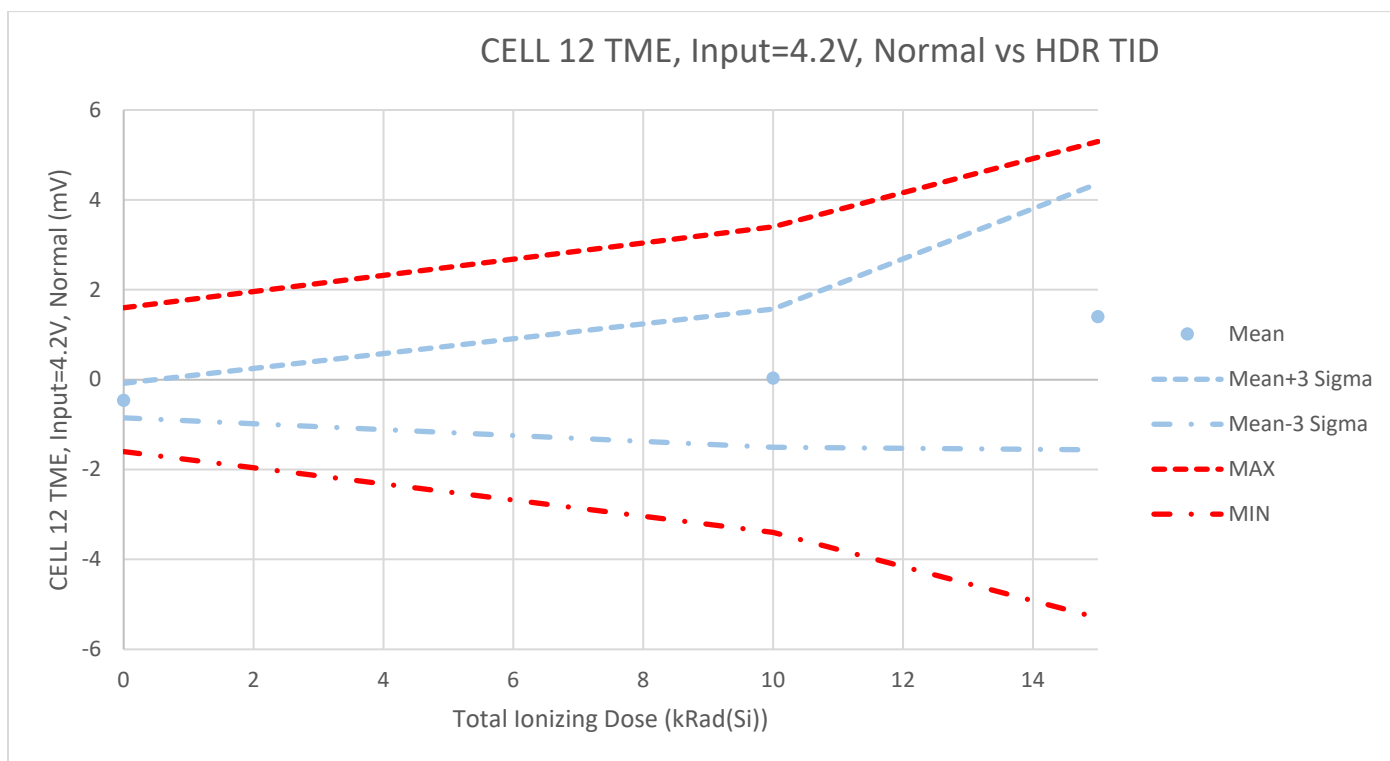

Table A-46-1. Cell 12 TME, Input = 4.2V, Normal vs. HDR TID for the RT6804HG-1.

HDR TID Biased				
Total Ionizing Dose (kRad(Si))	0	10	15	Units
Biased Mean	-0.4641	0.0312	1.4004	mV
Std Dev	0.1281	0.5127	0.9873	
Biased Mean+3σ	-0.0799	1.5693	4.3624	
Biased Mean-3σ	-0.8483	-1.5069	-1.5617	
DS MIN	-1.60E+00	-3.40E+00	-5.30E+00	mV
	PASS	PASS	PASS	
DS MAX	1.60E+00	3.40E+00	5.30E+00	mV
	PASS	PASS	PASS	

Figure A-46-2. Cell 12 TME, Input = 4.2V, Normal vs. LDR TID for the RT6804HG-1.

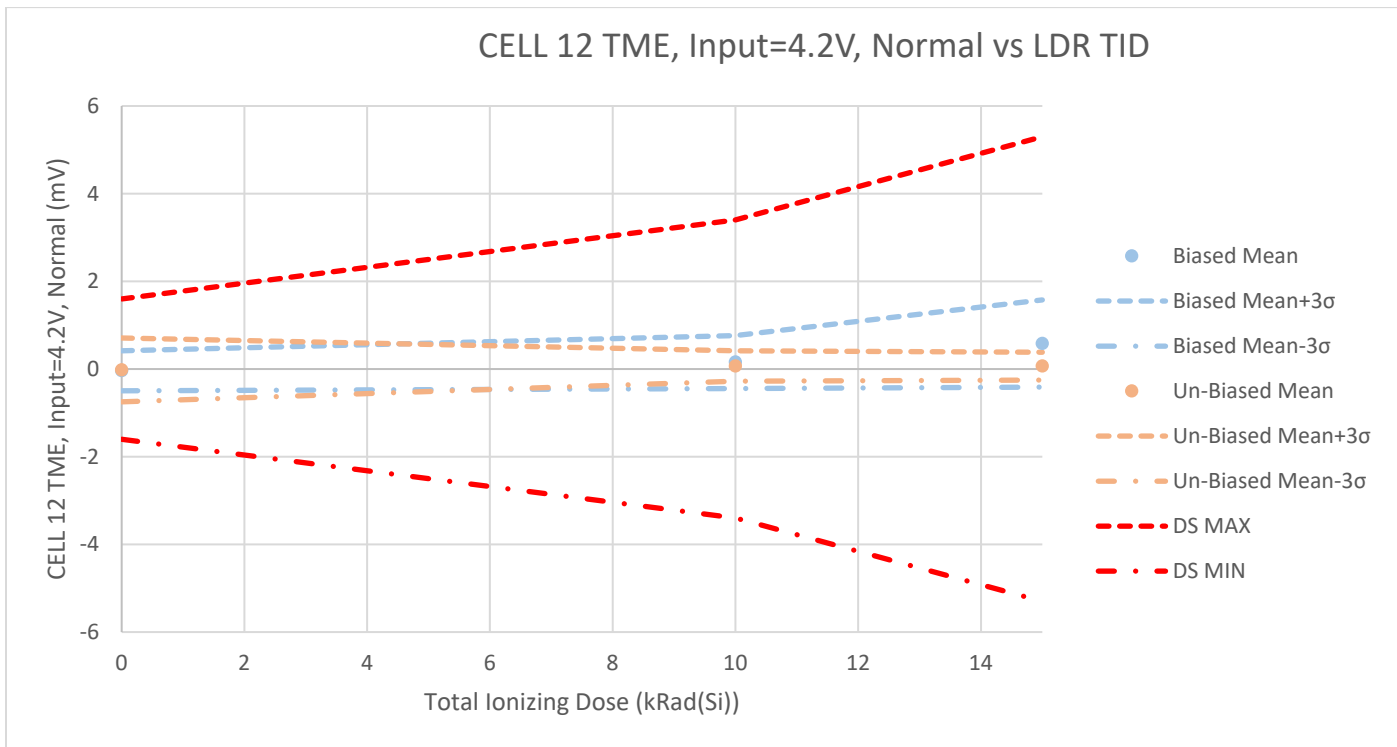

Table A-46-2. Cell 12 TME, Input = 4.2V, Normal vs. LDR TID for the RT6804HG-1.

Total Ionizing Dose (kRad(Si))	0	10	15	Units
LDR TID Biased				
Biased Mean	-0.0390	0.1590	0.5833	mV
Std Dev	0.1525	0.2011	0.3312	
Biased Mean+3σ	0.4184	0.7623	1.5769	
Biased Mean-3σ	-0.4965	-0.4443	-0.4102	
LDR TID Un-Biased				
Un-Biased Mean	-0.0193	0.0688	0.0670	mV
Std Dev	0.2428	0.1160	0.1058	
Un-Biased Mean+3σ	0.7090	0.4167	0.3843	
Un-Biased Mean-3σ	-0.7476	-0.2791	-0.2504	
DS MIN	-1.60E+00	-3.40E+00	-5.30E+00	mV
	PASS	PASS	PASS	
DS MAX	1.60E+00	3.40E+00	5.30E+00	mV
	PASS	PASS	PASS	

Figure A-47-1. GPIO1 TME, Input=4.2V, Normal vs. HDR TID for the RT6804HG-1.

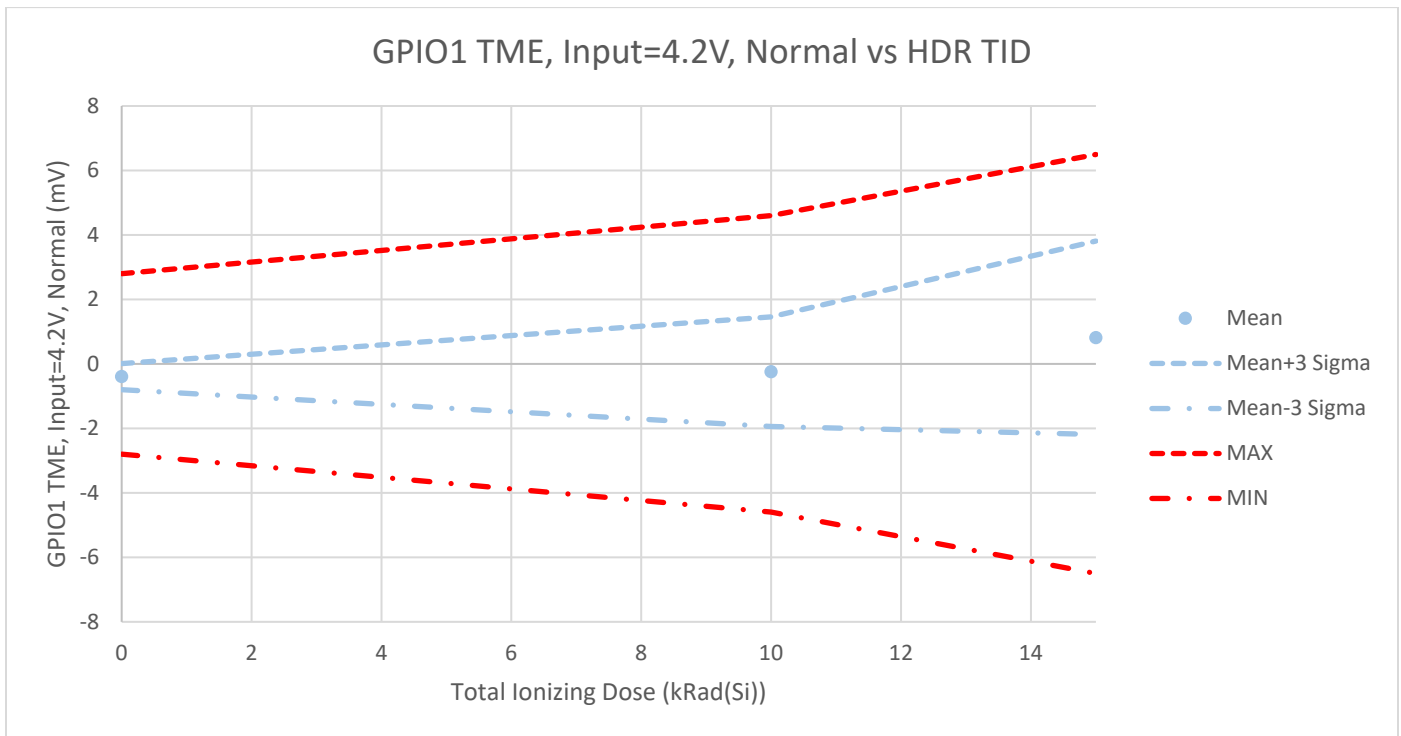

Table A-47-1. GPIO1 TME, Input=4.2V, Normal vs. HDR TID for the RT6804HG-1.

HDR TID Biased				
Total Ionizing Dose (kRad(Si))	0	10	15	Units
Biased Mean	-0.3944	-0.2424	0.8103	mV
Std Dev	0.1349	0.5674	1.0001	
Biased Mean+3σ	0.0102	1.4597	3.8108	
Biased Mean-3σ	-0.7990	-1.9445	-2.1901	
DS MIN	-2.80E+00	-4.60E+00	-6.50E+00	mV
	PASS	PASS	PASS	
DS MAX	2.80E+00	4.60E+00	6.50E+00	mV
	PASS	PASS	PASS	

Figure A-47-2. GPIO1 TME, Input=4.2V, Normal vs. LDR TID for the RT6804HG-1.

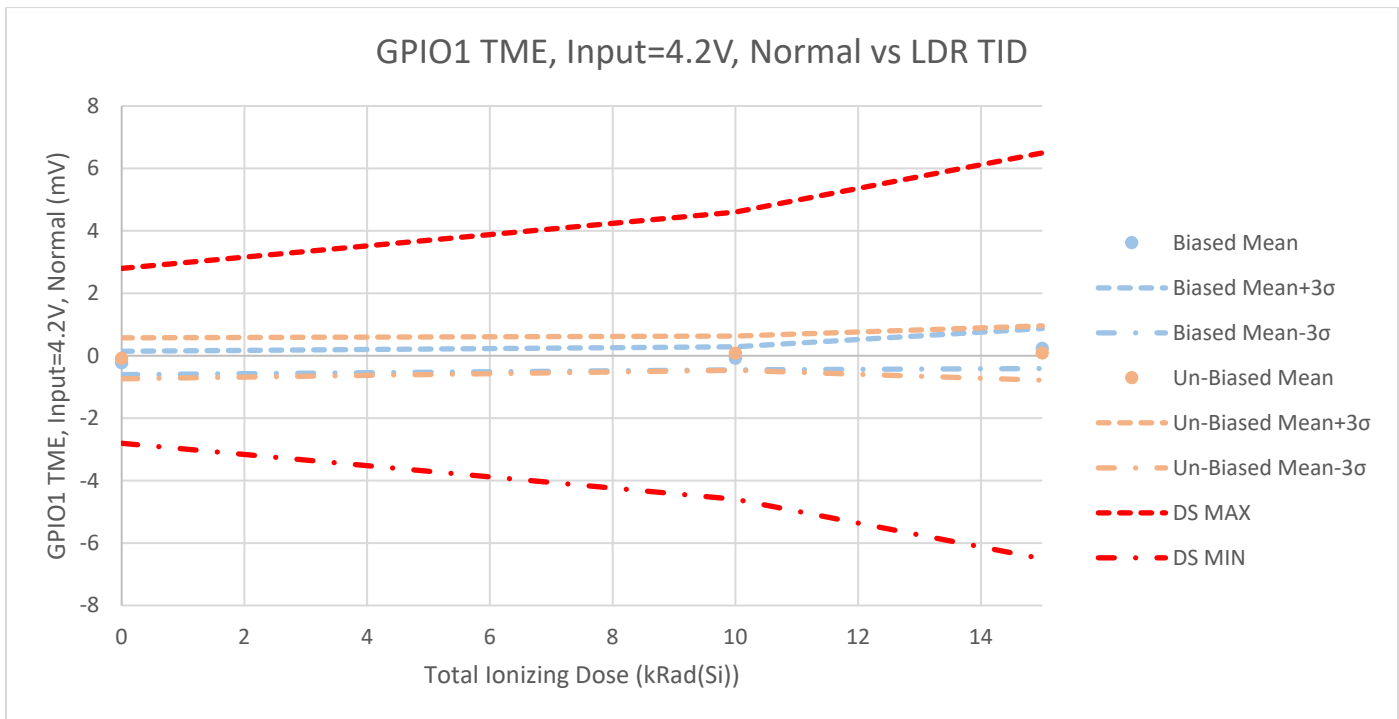

Table A-47-2. GPIO1 TME, Input=4.2V, Normal vs. LDR TID for the RT6804HG-1.

Total Ionizing Dose (kRad(Si))	0	10	15	Units
LDR TID Biased				
Biased Mean	-0.2273	-0.0822	0.2338	mV
Std Dev	0.1248	0.1230	0.2138	
Biased Mean+3σ	0.1470	0.2868	0.8753	
Biased Mean-3σ	-0.6016	-0.4511	-0.4077	
LDR TID Un-Biased				
Un-Biased Mean	-0.0803	0.0839	0.0887	mV
Std Dev	0.2192	0.1826	0.2904	
Un-Biased Mean+3σ	0.5773	0.6318	0.9599	
Un-Biased Mean-3σ	-0.7378	-0.4640	-0.7825	
DS MIN	-2.80E+00	-4.60E+00	-6.50E+00	mV
	PASS	PASS	PASS	
DS MAX	2.80E+00	4.60E+00	6.50E+00	mV
	PASS	PASS	PASS	

Figure A-48-1. GPIO2 TME, Input=4.2V, Normal vs. HDR TID for the RT6804HG-1.

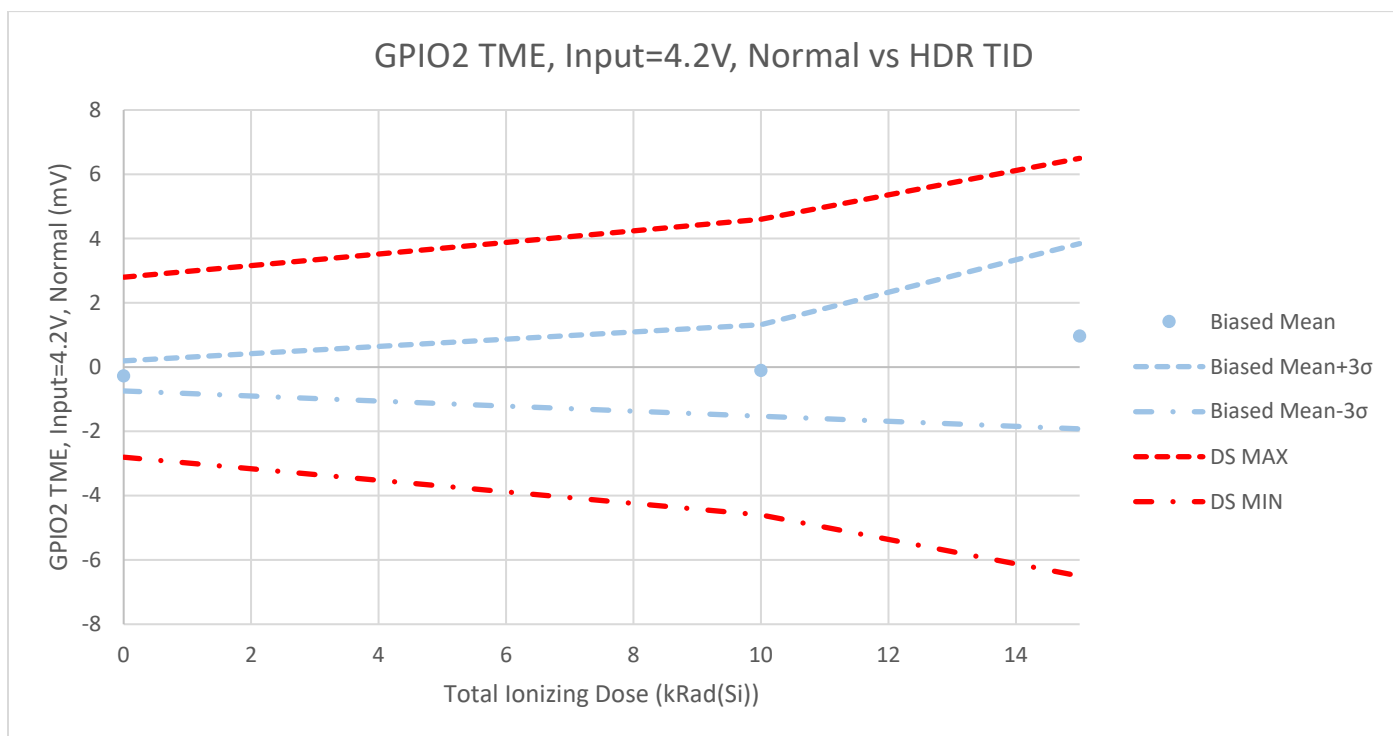

Table A-48-1. GPIO2 TME, Input=4.2V, Normal vs. HDR TID for the RT6804HG-1.

HDR TID Biased				
Total Ionizing Dose (kRad(Si))	0	10	15	Units
Biased Mean	-0.2729	-0.1067	0.9625	mV
Std Dev	0.1562	0.4750	0.9606	
Biased Mean+3σ	0.1958	1.3182	3.8442	
Biased Mean-3σ	-0.7416	-1.5316	-1.9193	
DS MIN	-2.80E+00	-4.60E+00	-6.50E+00	mV
	PASS	PASS	PASS	
DS MAX	2.80E+00	4.60E+00	6.50E+00	mV
	PASS	PASS	PASS	

Figure A-48-2. GPIO2 TME, Input=4.2V, Normal vs. LDR TID for the RT6804HG-1.

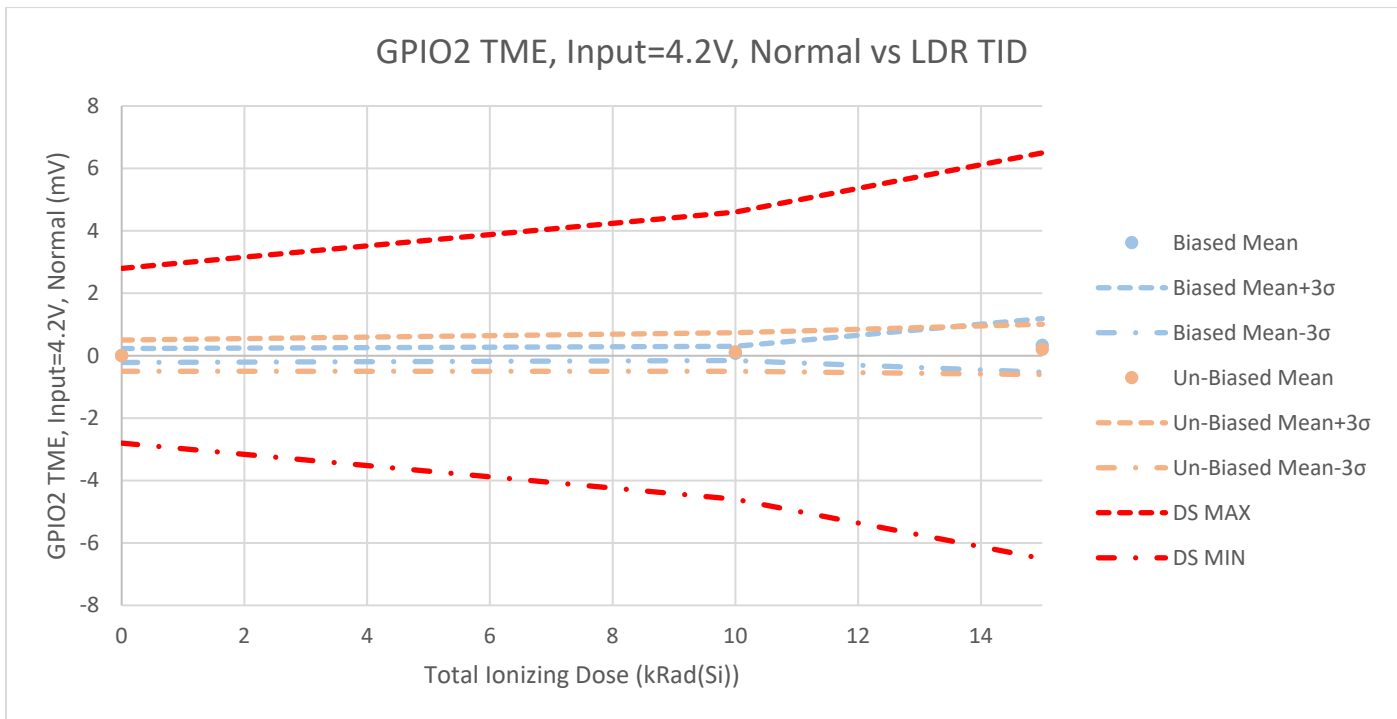

Table A-48-2. GPIO2 TME, Input=4.2V, Normal vs. LDR TID for the RT6804HG-1.

Total Ionizing Dose (kRad(Si))	0	10	15	Units
LDR TID Biased				
Biased Mean	0.0060	0.0732	0.3286	mV
Std Dev	0.0740	0.0760	0.2864	
Biased Mean+3σ	0.2280	0.3014	1.1878	
Biased Mean-3σ	-0.2160	-0.1549	-0.5307	
LDR TID Un-Biased				
Un-Biased Mean	-0.0003	0.1212	0.2014	mV
Std Dev	0.1670	0.2055	0.2692	
Un-Biased Mean+3σ	0.5007	0.7377	1.0089	
Un-Biased Mean-3σ	-0.5013	-0.4952	-0.6062	
DS MIN	-2.80E+00	-4.60E+00	-6.50E+00	mV
	PASS	PASS	PASS	
DS MAX	2.80E+00	4.60E+00	6.50E+00	mV
	PASS	PASS	PASS	

Figure A-49-1. GPIO3 TME, Input=4.2V, Normal vs. HDR TID for the RT6804HG-1.

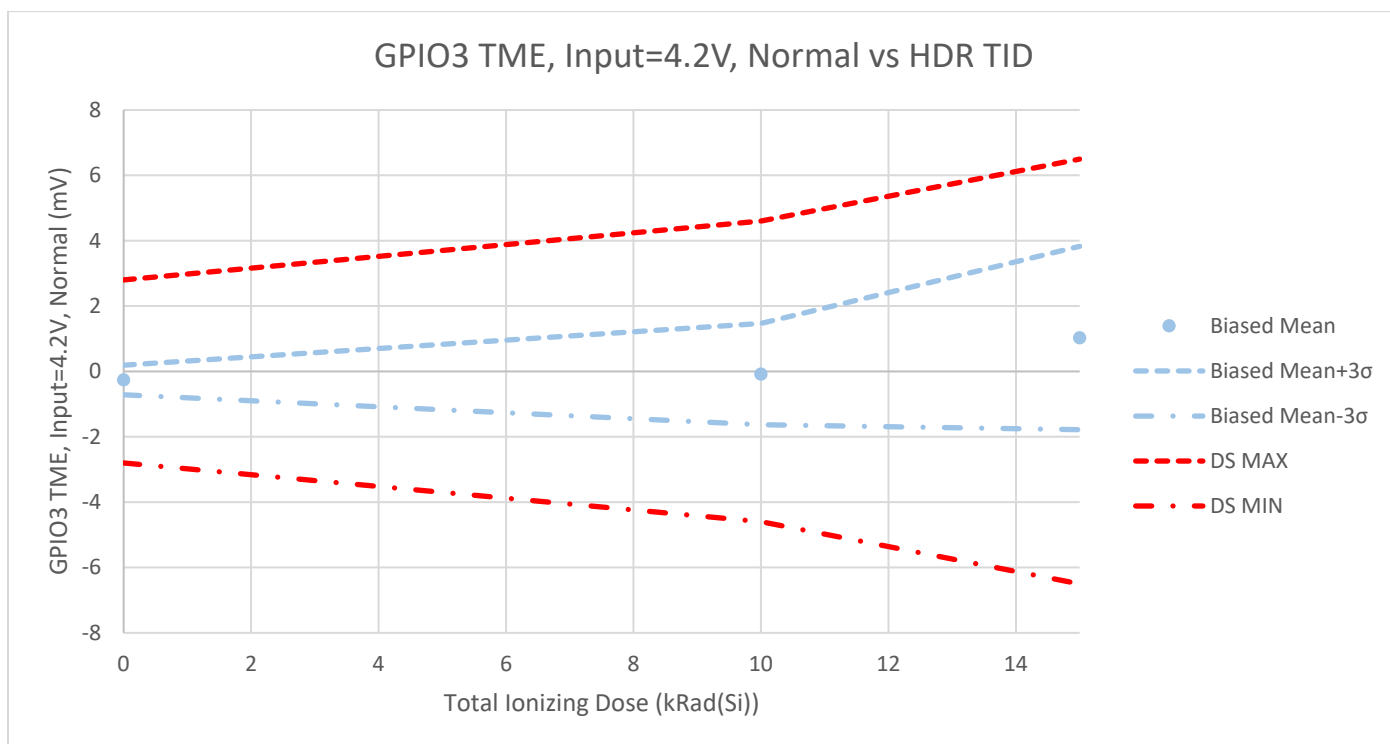

Table A-49-1. GPIO3 TME, Input=4.2V, Normal vs. HDR TID for the RT6804HG-1.

Total Ionizing Dose (kRad(Si))	HDR TID Biased			Units
	0	10	15	
Biased Mean	-0.2606	-0.0820	1.0263	mV
Std Dev	0.1516	0.5159	0.9355	
Biased Mean+3σ	0.1944	1.4657	3.8328	
Biased Mean-3σ	-0.7155	-1.6297	-1.7802	
DS MIN	-2.80E+00	-4.60E+00	-6.50E+00	mV
	PASS	PASS	PASS	
DS MAX	2.80E+00	4.60E+00	6.50E+00	mV
	PASS	PASS	PASS	

Figure A-49-2. GPIO3 TME, Input=4.2V, Normal vs. LDR TID for the RT6804HG-1.

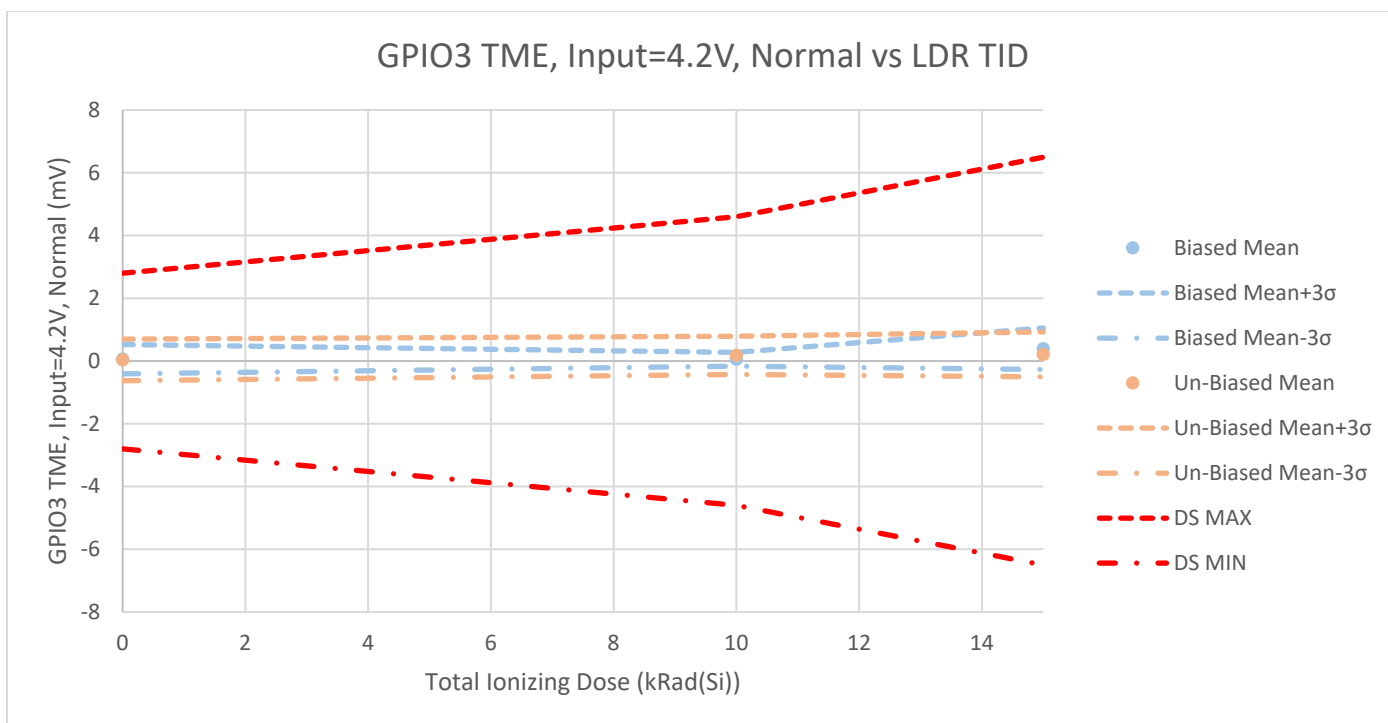

Table A-49-2. GPIO3 TME, Input=4.2V, Normal vs. LDR TID for the RT6804HG-1.

Total Ionizing Dose (kRad(Si))	0	10	15	Units
LDR TID Biased				
Biased Mean	0.0585	0.0574	0.3919	mV
Std Dev	0.1556	0.0731	0.2213	
Biased Mean+3σ	0.5252	0.2767	1.0558	
Biased Mean-3σ	-0.4083	-0.1619	-0.2721	
LDR TID Un-Biased				
Un-Biased Mean	0.0367	0.1821	0.2106	mV
Std Dev	0.2210	0.2027	0.2393	
Un-Biased Mean+3σ	0.6997	0.7901	0.9285	
Un-Biased Mean-3σ	-0.6262	-0.4259	-0.5074	
DS MIN	-2.80E+00	-4.60E+00	-6.50E+00	mV
	PASS	PASS	PASS	
DS MAX	2.80E+00	4.60E+00	6.50E+00	mV
	PASS	PASS	PASS	

Figure A-50-1. GPIO4 TME, Input=4.2V, Normal vs. HDR TID for the RT6804HG-1.

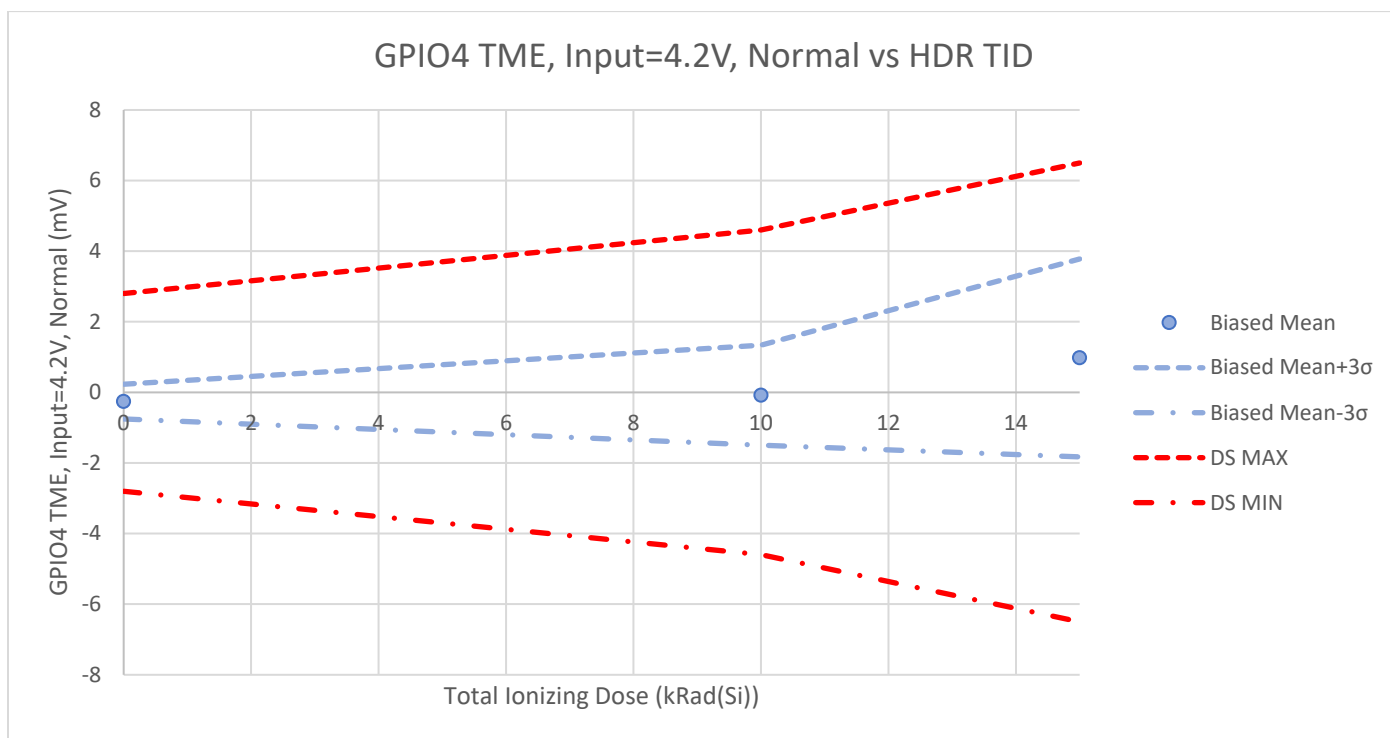

Table A-50-1. GPIO4 TME, Input=4.2V, Normal vs. HDR TID for the RT6804HG-1.

HDR TID Biased				
Total Ionizing Dose (kRad(Si))	0	10	15	Units
Biased Mean	-0.2593	-0.0807	0.9786	mV
Std Dev	0.1641	0.4721	0.9344	
Biased Mean+3σ	0.2332	1.3357	3.7819	
Biased Mean-3σ	-0.7517	-1.4971	-1.8246	
DS MIN	-2.80E+00	-4.60E+00	-6.50E+00	mV
	PASS	PASS	PASS	
DS MAX	2.80E+00	4.60E+00	6.50E+00	mV
	PASS	PASS	PASS	

Figure A-50-2. GPIO4 TME, Input=4.2V, Normal vs. LDR TID for the RT6804HG-1.

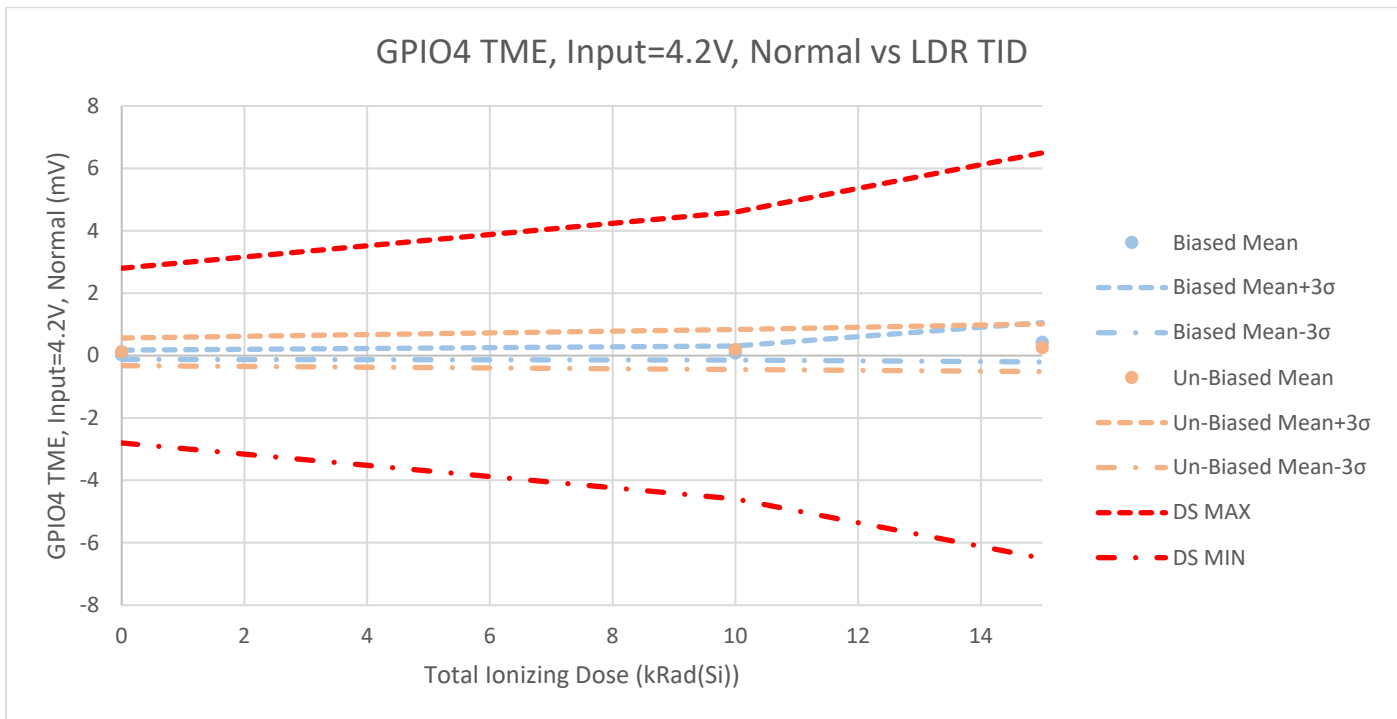

Table A-50-2. GPIO4 TME, Input=4.2V, Normal vs. LDR TID for the RT6804HG-1.

Total Ionizing Dose (kRad(Si))	0	10	15	Units
LDR TID Biased				
Biased Mean	0.0253	0.0818	0.4261	mV
Std Dev	0.0492	0.0752	0.2099	
Biased Mean+3σ	0.1729	0.3073	1.0559	
Biased Mean-3σ	-0.1223	-0.1437	-0.2037	
LDR TID Un-Biased				
Un-Biased Mean	0.1190	0.1921	0.2522	mV
Std Dev	0.1480	0.2142	0.2546	
Un-Biased Mean+3σ	0.5631	0.8347	1.0161	
Un-Biased Mean-3σ	-0.3252	-0.4505	-0.5117	
DS MIN	-2.80E+00	-4.60E+00	-6.50E+00	mV
	PASS	PASS	PASS	
DS MAX	2.80E+00	4.60E+00	6.50E+00	mV
	PASS	PASS	PASS	

Figure A-51-1. GPIO5 TME, Input=4.2V, Normal vs. HDR TID for the RT6804HG-1.

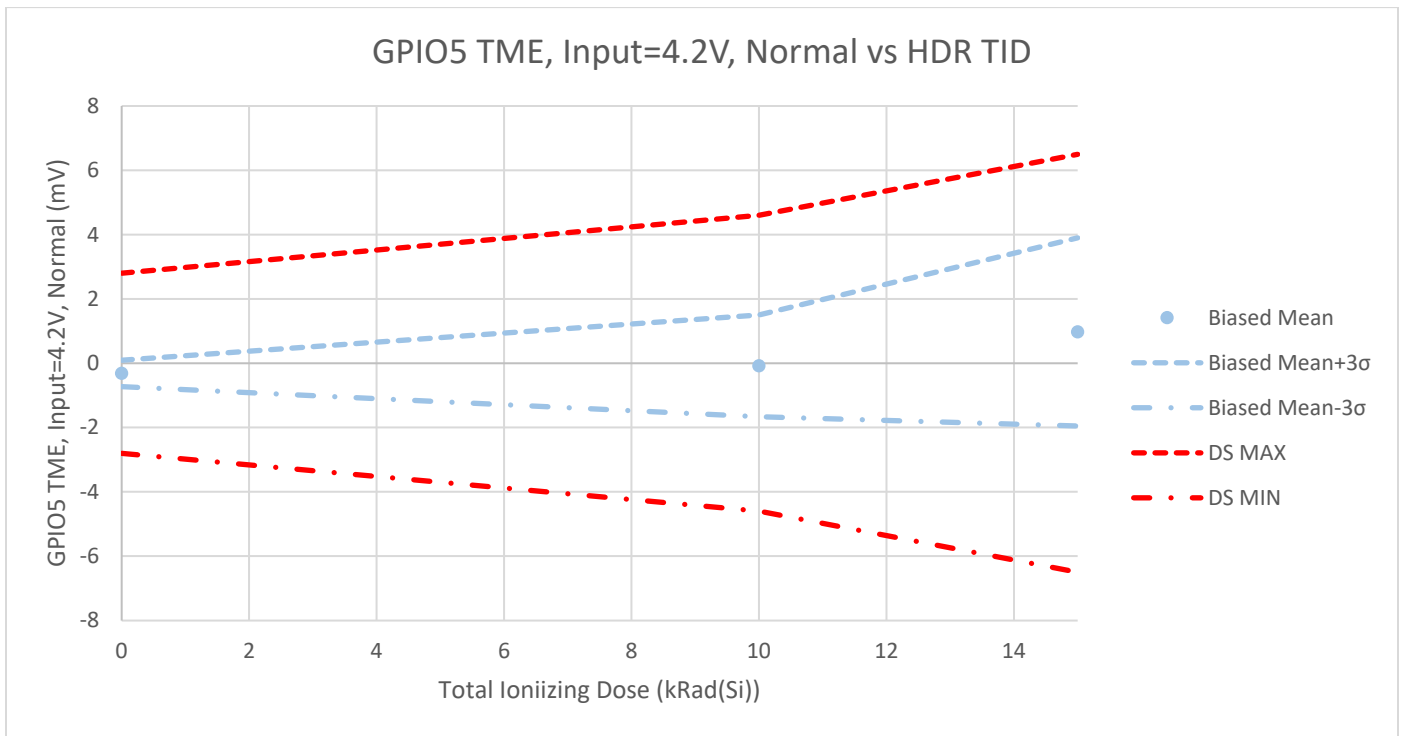

Table A-51-1. GPIO5 TME, Input=4.2V, Normal vs. HDR TID for the RT6804HG-1.

HDR TID Biased				
Total Ionizing Dose (kRad(Si))	0	10	15	Units
Biased Mean	-0.3136	-0.0802	0.9742	mV
Std Dev	0.1368	0.5278	0.9750	
Biased Mean+3σ	0.0968	1.5030	3.8992	
Biased Mean-3σ	-0.7241	-1.6635	-1.9508	
DS MIN	-2.80E+00	-4.60E+00	-6.50E+00	mV
	PASS	PASS	PASS	
DS MAX	2.80E+00	4.60E+00	6.50E+00	mV
	PASS	PASS	PASS	

Figure A-51-2. GPIO5 TME, Input=4.2V, Normal vs. LDR TID for the RT6804HG-1.

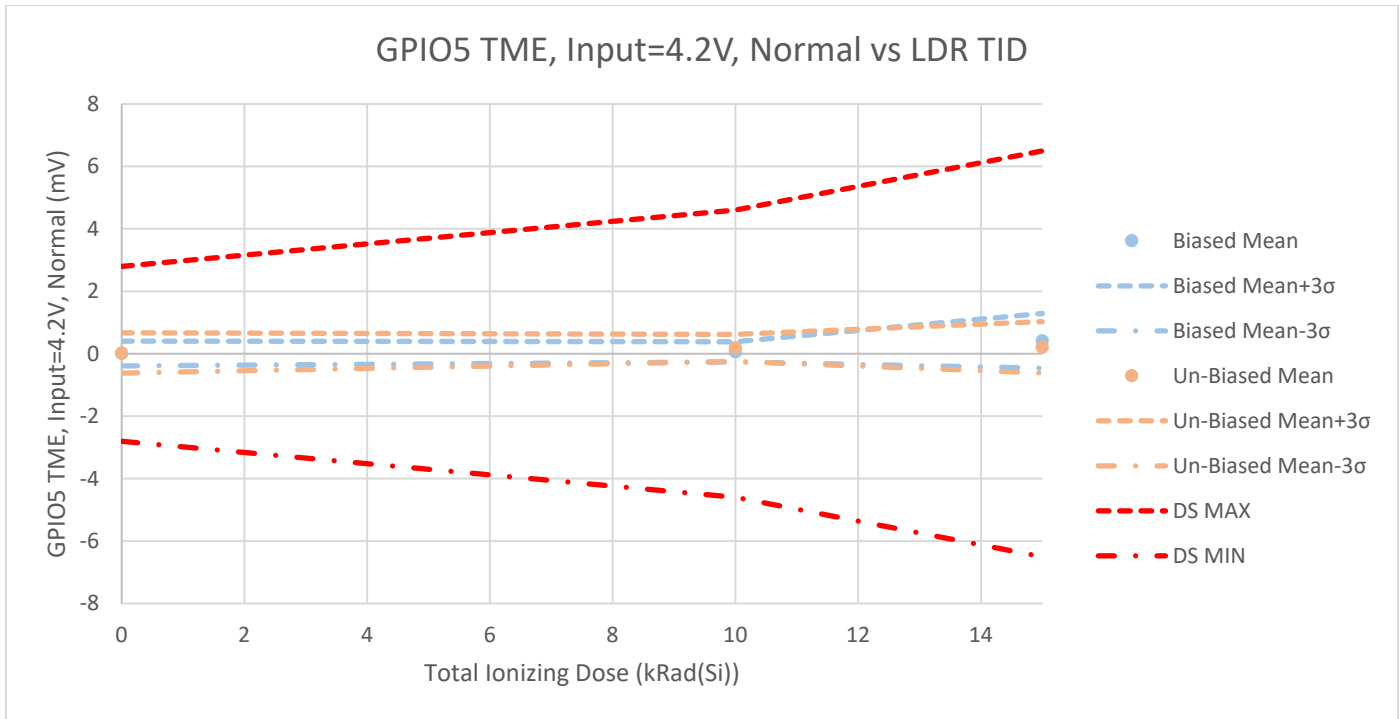

Table A-51-2. GPIO5 TME, Input=4.2V, Normal vs. LDR TID for the RT6804HG-1.

Total Ionizing Dose (kRad(Si))	0	10	15	Units
LDR TID Biased				
Biased Mean	0.0071	0.0628	0.4149	mV
Std Dev	0.1322	0.1082	0.2922	
Biased Mean+3σ	0.4036	0.3873	1.2914	
Biased Mean-3σ	-0.3894	-0.2616	-0.4616	
LDR TID Un-Biased				
Un-Biased Mean	0.0265	0.1897	0.2081	mV
Std Dev	0.2147	0.1443	0.2747	
Un-Biased Mean+3σ	0.6706	0.6225	1.0322	
Un-Biased Mean-3σ	-0.6177	-0.2432	-0.6161	
DS MIN	-2.80E+00	-4.60E+00	-6.50E+00	mV
	PASS	PASS	PASS	
DS MAX	2.80E+00	4.60E+00	6.50E+00	mV
	PASS	PASS	PASS	

Figure A-52-1. VREG TME, Normal vs. HDR TID for the RT6804HG-1.

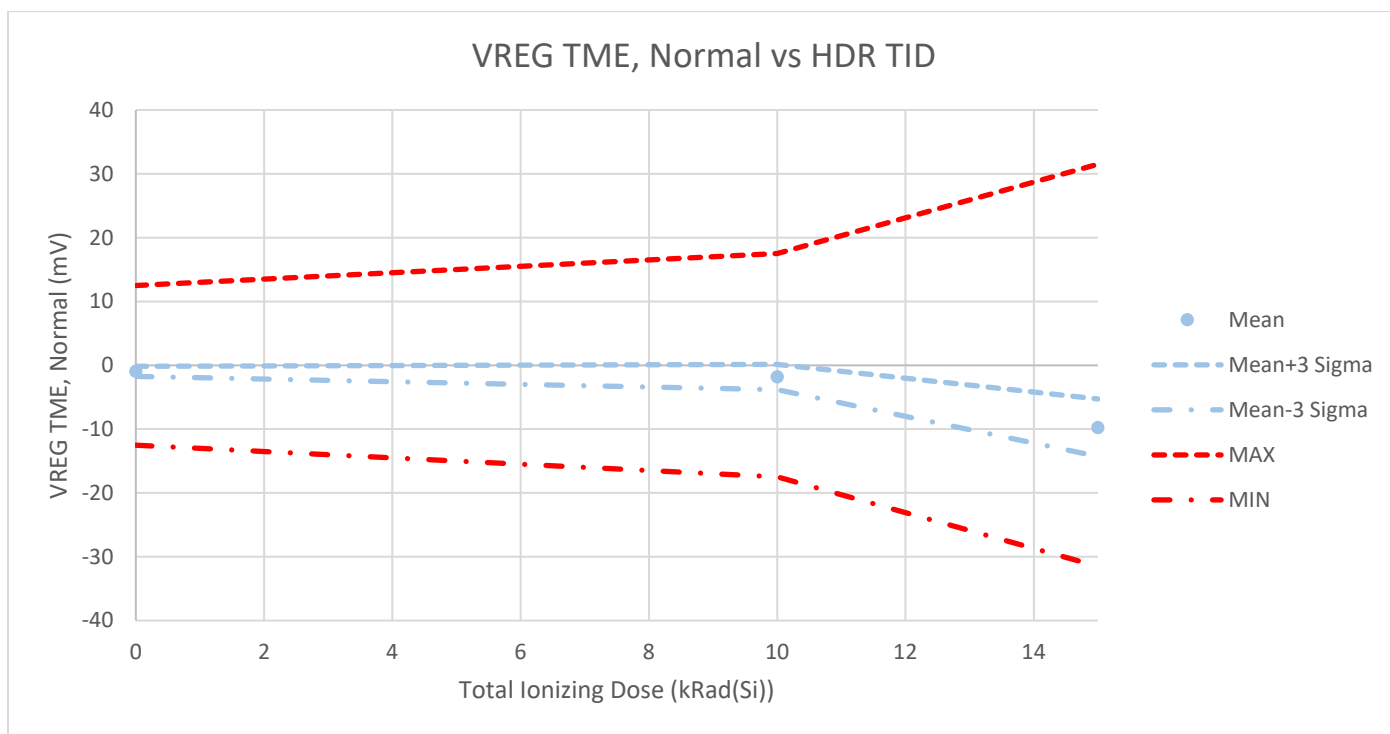

Table A-52-1. VREG TME, Normal vs. HDR TID for the RT6804HG-1.

HDR TID Biased				
Total Ionizing Dose (kRad(Si))	0	10	15	Units
Biased Mean	-0.9500	-1.8267	-9.7667	mV
Std Dev	0.2579	0.6618	1.5019	
Biased Mean+3σ	-0.1764	0.1587	-5.2611	
Biased Mean-3σ	-1.7236	-3.8120	-14.2722	
DS MIN	-1.25E+01	-1.75E+01	-3.15E+01	mV
	PASS	PASS	PASS	
DS MAX	1.25E+01	1.75E+01	3.15E+01	mV
	PASS	PASS	PASS	

Figure A-52-2. VREG TME, Normal vs. LDR TID for the RT6804HG-1.

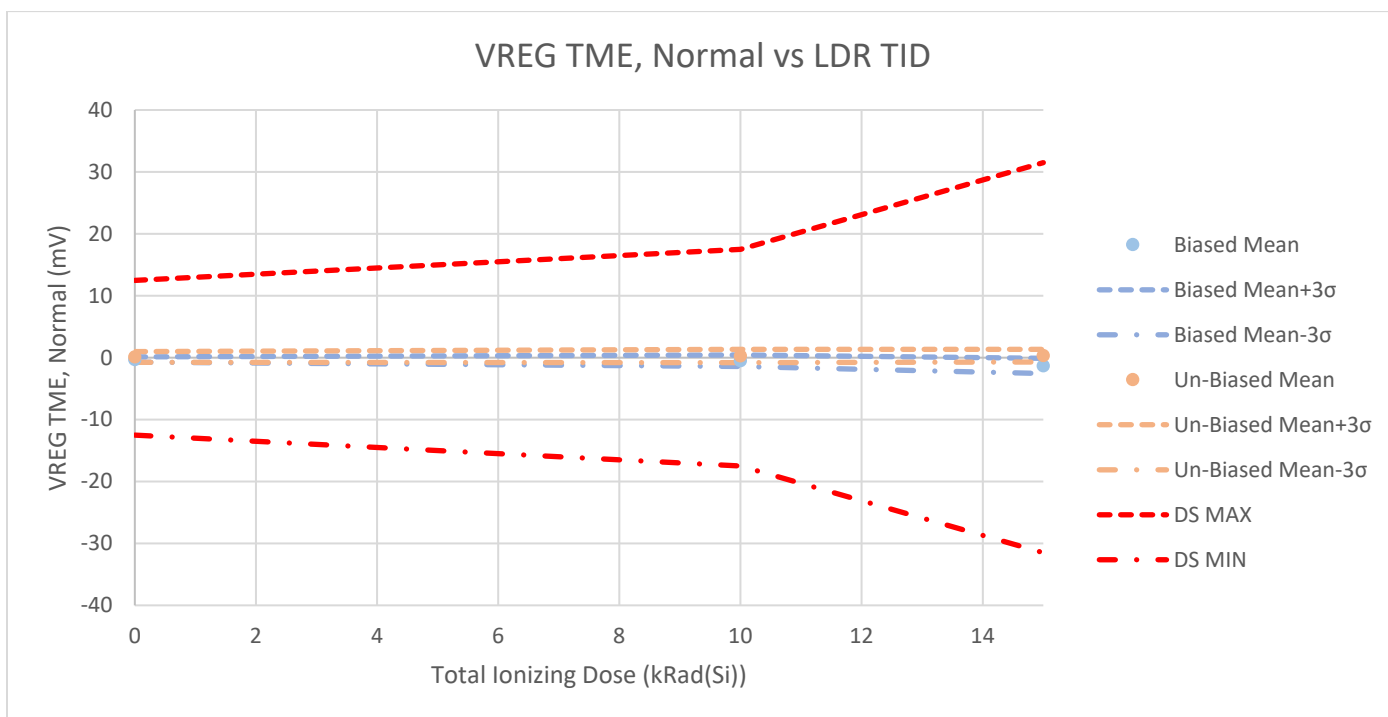

Table A-52-2. VREG TME, Normal vs. LDR TID for the RT6804HG-1.

Total Ionizing Dose (kRad(Si))	0	10	15	Units
LDR TID Biased				
Biased Mean	-0.3000	-0.4800	-1.3200	mV
Std Dev	0.1414	0.3124	0.4069	
Biased Mean+3σ	0.1243	0.4572	-0.0992	
Biased Mean-3σ	-0.7243	-1.4172	-2.5408	
LDR TID Un-Biased				
Un-Biased Mean	0.1200	0.2800	0.3400	mV
Std Dev	0.2926	0.3600	0.3382	
Un-Biased Mean+3σ	0.9977	1.3600	1.3547	
Un-Biased Mean-3σ	-0.7577	-0.8000	-0.6747	
DS MIN	-1.25E+01	-1.75E+01	-3.15E+01	mV
	PASS	PASS	PASS	
DS MAX	1.25E+01	1.75E+01	3.15E+01	mV
	PASS	PASS	PASS	

Figure A-53-1. VREG TME, Filtered vs. HDR TID for the RT6804HG-1.

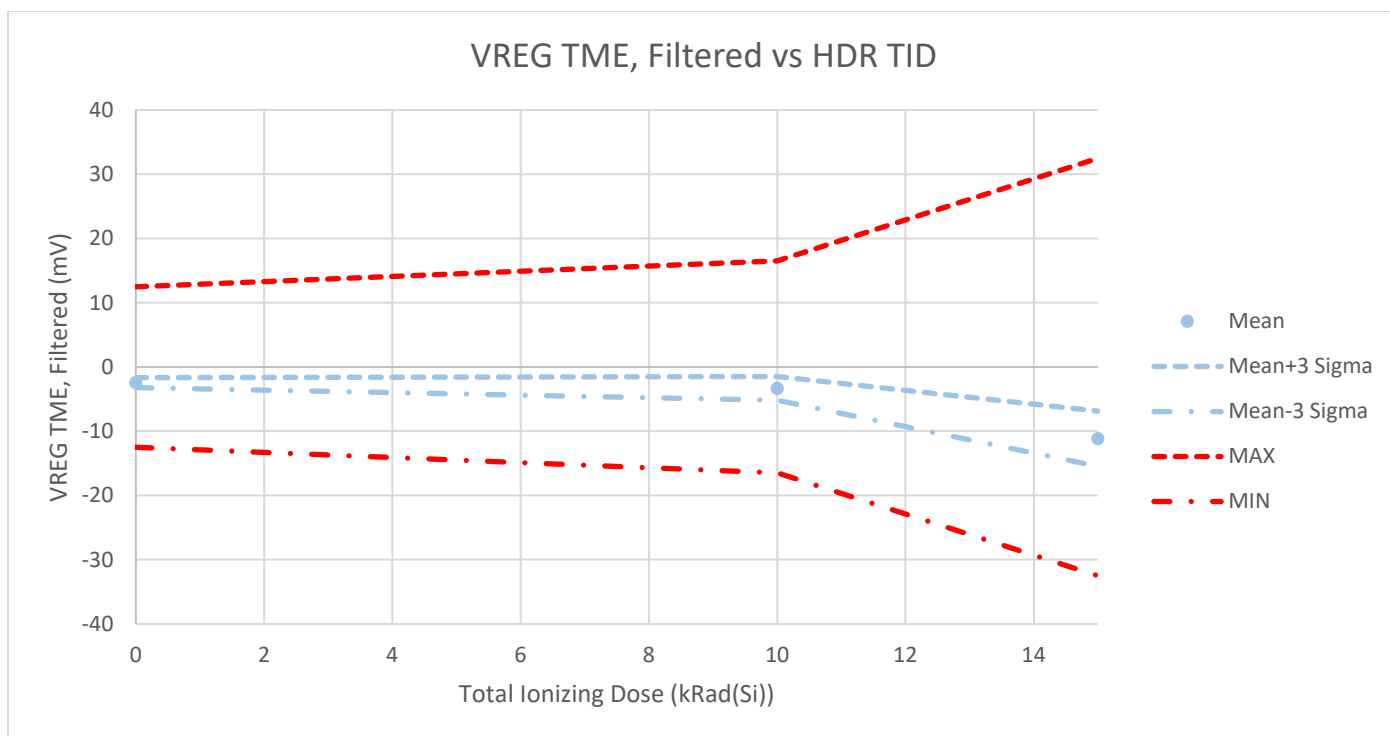

Table A-53-1. VREG TME, Filtered vs. HDR TID for the RT6804HG-1.

HDR TID Biased				
Total Ionizing Dose (kRad(Si))	0	10	15	Units
Biased Mean	-2.4467	-3.3400	-11.1667	mV
Std Dev	0.2553	0.6173	1.4333	
Biased Mean+3σ	-1.6809	-1.4881	-6.8669	
Biased Mean-3σ	-3.2124	-5.1919	-15.4664	
DS MIN	-1.25E+01	-1.65E+01	-3.25E+01	mV
	PASS	PASS	PASS	
DS MAX	1.25E+01	1.65E+01	3.25E+01	mV
	PASS	PASS	PASS	

Figure A-53-2. VREG TME, Filtered vs. LDR TID for the RT6804HG-1.

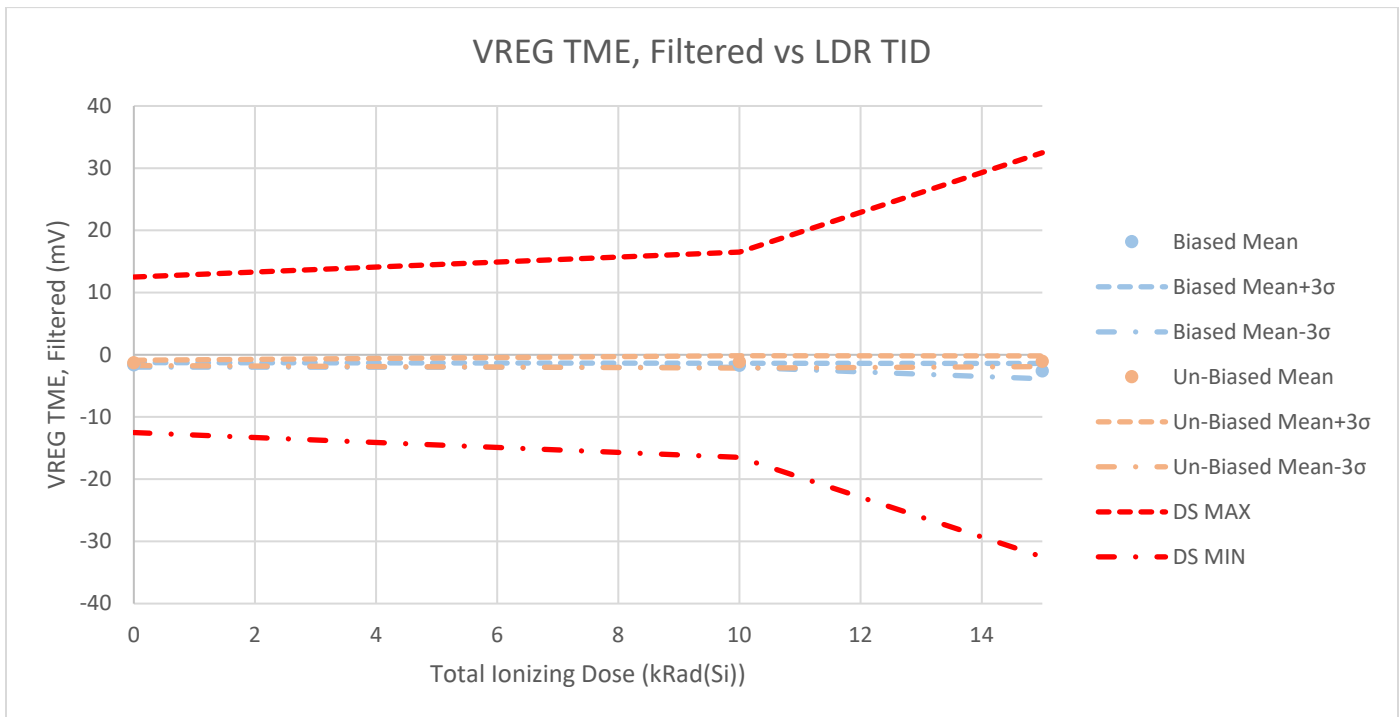

Table A-53-2. VREG TME, Filtered vs. LDR TID for the RT6804HG-1.

Total Ionizing Dose (kRad(Si))	0	10	15	Units
LDR TID Biased				
Biased Mean	-1.6200	-1.7000	-2.6200	mV
Std Dev	0.1166	0.1095	0.4118	
Biased Mean+3σ	-1.2701	-1.3714	-1.3845	
Biased Mean-3σ	-1.9699	-2.0286	-3.8555	
LDR TID Un-Biased				
Un-Biased Mean	-1.3000	-1.1400	-1.0600	mV
Std Dev	0.1414	0.3323	0.2871	
Un-Biased Mean+3σ	-0.8757	-0.1432	-0.1988	
Un-Biased Mean-3σ	-1.7243	-2.1368	-1.9212	
DS MIN	-1.25E+01	-1.65E+01	-3.25E+01	mV
	PASS	PASS	PASS	
DS MAX	1.25E+01	1.65E+01	3.25E+01	mV
	PASS	PASS	PASS	

Figure A-54-1. C0 IB, not measuring vs. HDR TID for the RT6804HG-1.

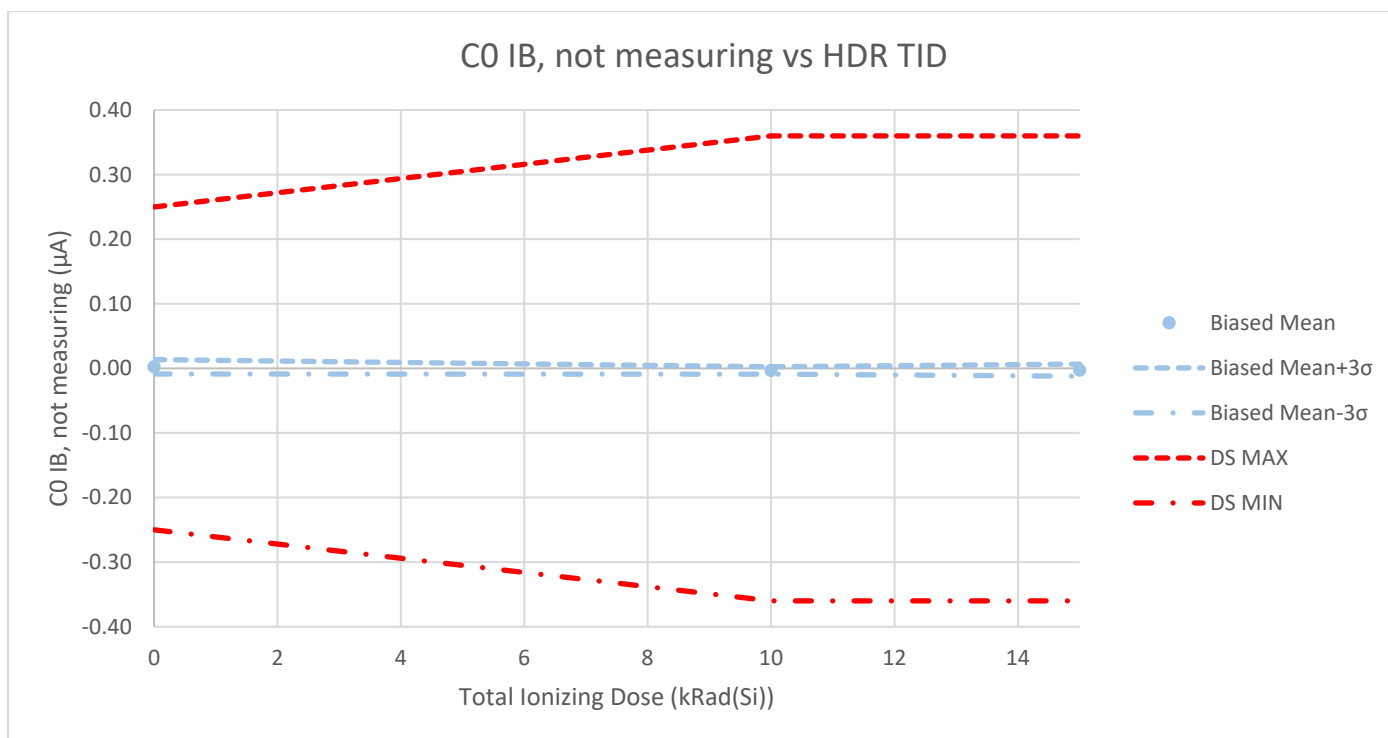

Table A-54-1. C0 IB, not measuring vs. HDR TID for the RT6804HG-1.

HDR TID Biased				
Total Ionizing Dose (kRad(Si))	0	10	15	Units
Biased Mean	0.0025	-0.0033	-0.0028	µA
Std Dev	0.0037	0.0019	0.0031	
Biased Mean+3σ	0.0135	0.0024	0.0067	
Biased Mean-3σ	-0.0085	-0.0091	-0.0122	
DS MIN	-2.50E-01	-3.60E-01	-3.60E-01	µA
	PASS	PASS	PASS	
DS MAX	2.50E-01	3.60E-01	3.60E-01	µA
	PASS	PASS	PASS	

Figure A-54-2. C0 IB, not measuring vs. LDR TID for the RT6804HG-1.

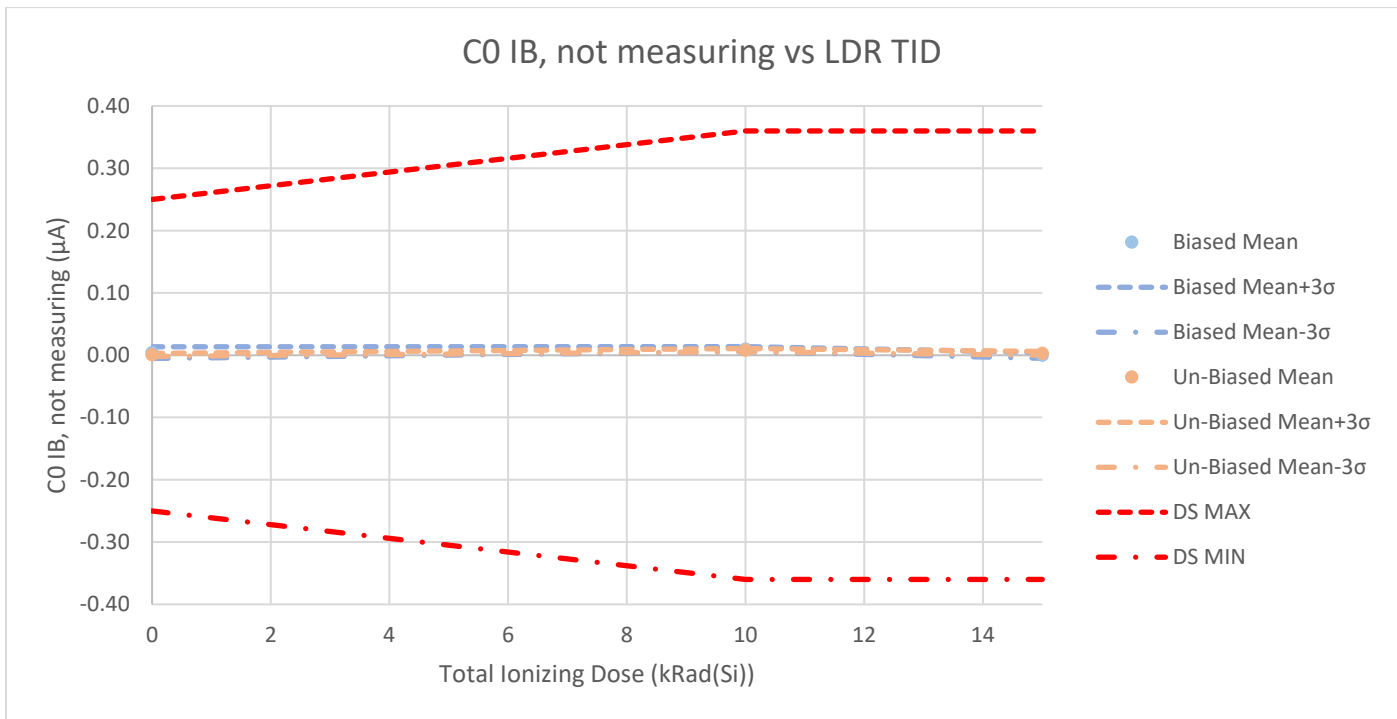

Table A-54-2. C0 IB, not measuring vs. LDR TID for the RT6804HG-1.

Total Ionizing Dose (kRad(Si))	0	10	15	Units
LDR TID Biased				
Biased Mean	0.0042	0.0096	-0.0003	μA
Std Dev	0.0031	0.0013	0.0016	
Biased Mean+3σ	0.0136	0.0136	0.0045	
Biased Mean-3σ	-0.0053	0.0057	-0.0052	
LDR TID Un-Biased				
Un-Biased Mean	0.0006	0.0081	0.0029	μA
Std Dev	0.0008	0.0008	0.0010	
Un-Biased Mean+3σ	0.0029	0.0106	0.0059	
Un-Biased Mean-3σ	-0.0018	0.0056	-0.0002	
DS MIN	-2.50E-01	-3.60E-01	-3.60E-01	μA
	PASS	PASS	PASS	
DS MAX	2.50E-01	3.60E-01	3.60E-01	μA
	PASS	PASS	PASS	

Figure A-55-1. C1 IB, not measuring, S1 connected vs. HDR TID for the RT6804HG-1.

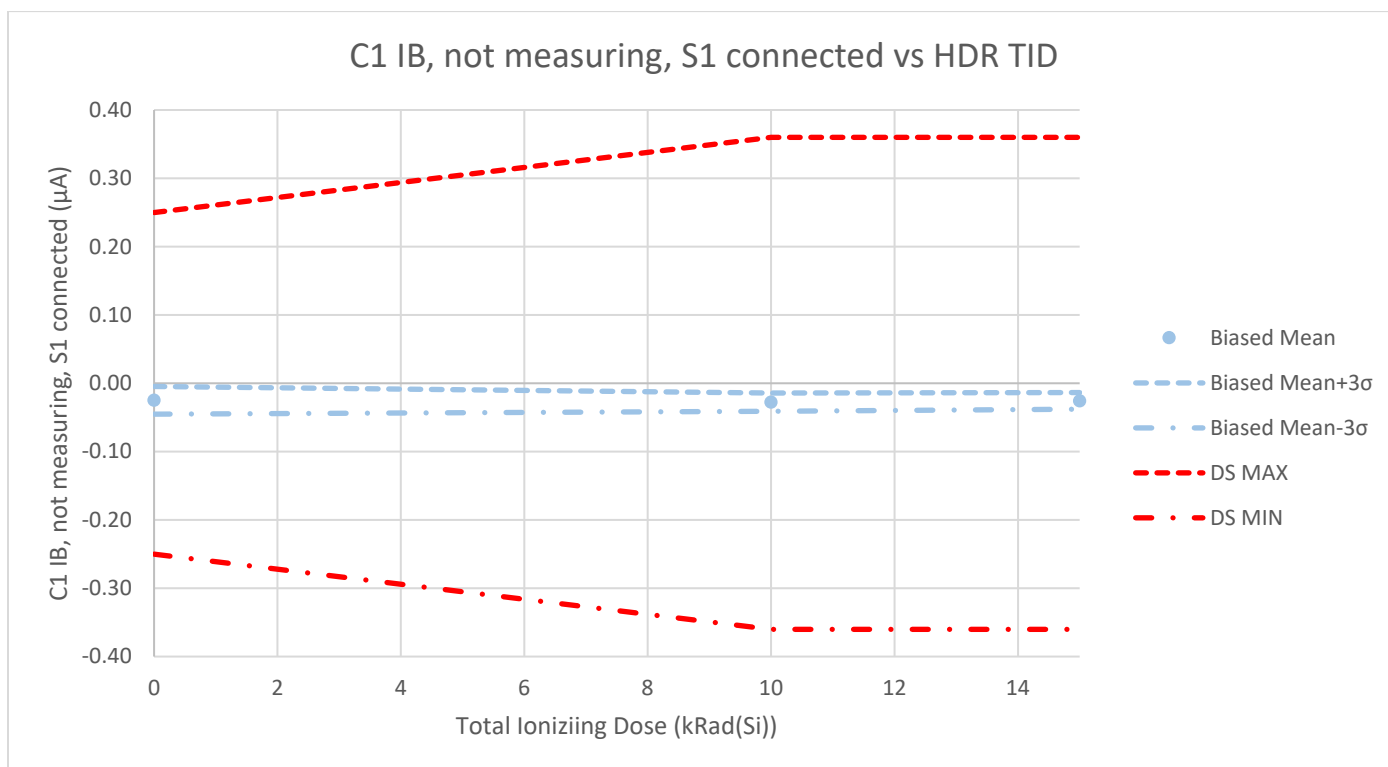

Table A-55-1. C1 IB, not measuring, S1 connected vs. HDR TID for the RT6804HG-1.

HDR TID Biased				
Total Ionizing Dose (kRad(Si))	0	10	15	Units
Biased Mean	-0.0248	-0.0276	-0.0258	µA
Std Dev	0.0067	0.0045	0.0040	
Biased Mean+3σ	-0.0046	-0.0142	-0.0137	
Biased Mean-3σ	-0.0450	-0.0411	-0.0378	
DS MIN	-2.50E-01	-3.60E-01	-3.60E-01	µA
	PASS	PASS	PASS	
DS MAX	2.50E-01	3.60E-01	3.60E-01	µA
	PASS	PASS	PASS	

Figure A-55-2. C1 IB, not measuring, S1 connected vs. LDR TID for the RT6804HG-1.

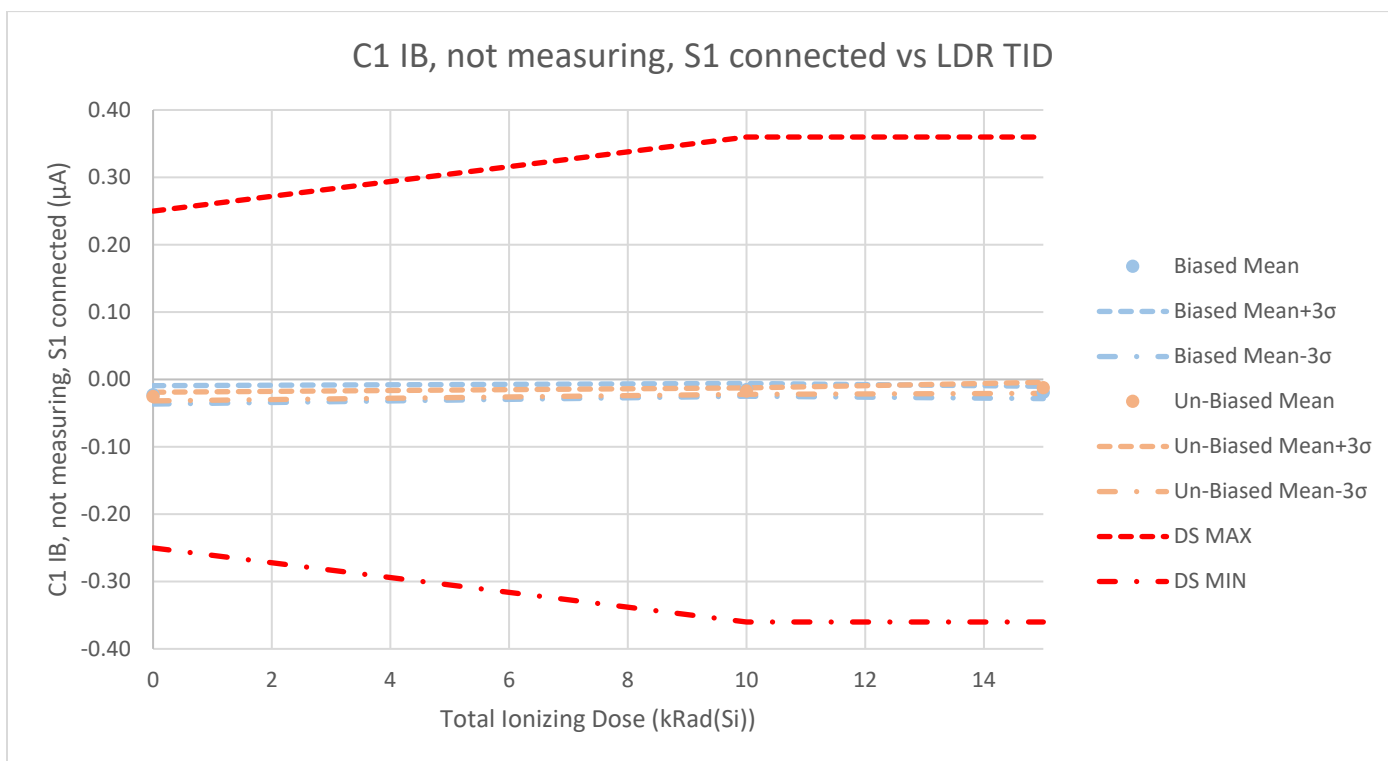

Table A-55-2. C1 IB, not measuring, S1 connected vs. LDR TID for the RT6804HG-1.

Total Ionizing Dose (kRad(Si))	0	10	15	Units
LDR TID Biased				
Biased Mean	-0.0229	-0.0153	-0.0194	µA
Std Dev	0.0045	0.0032	0.0030	
Biased Mean+3σ	-0.0092	-0.0058	-0.0102	
Biased Mean-3σ	-0.0365	-0.0248	-0.0285	
LDR TID Un-Biased				
Un-Biased Mean	-0.0254	-0.0174	-0.0123	µA
Std Dev	0.0021	0.0015	0.0027	
Un-Biased Mean+3σ	-0.0190	-0.0127	-0.0041	
Un-Biased Mean-3σ	-0.0319	-0.0220	-0.0206	
DS MIN	-2.50E-01	-3.60E-01	-3.60E-01	µA
	PASS	PASS	PASS	
DS MAX	2.50E-01	3.60E-01	3.60E-01	µA
	PASS	PASS	PASS	

Figure A-56-1. C2 IB, not measuring, S2 connected vs. HDR TID for the RT6804HG-1.

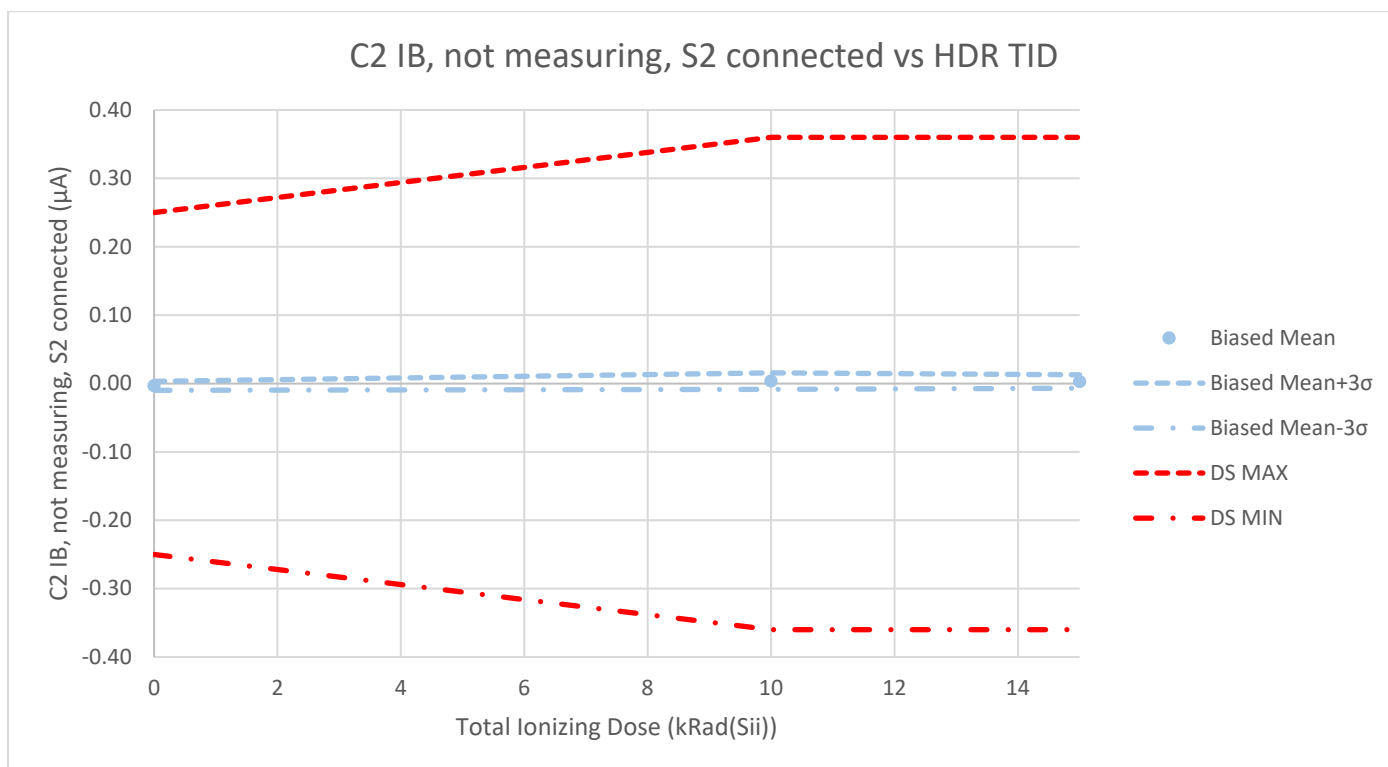

Table A-56-1. C2 IB, not measuring, S2 connected vs. HDR TID for the RT6804HG-1.

HDR TID Biased				
Total Ionizing Dose (kRad(Si))	0	10	15	Units
Biased Mean	-0.0033	0.0035	0.0028	µA
Std Dev	0.0022	0.0040	0.0033	
Biased Mean+3σ	0.0032	0.0156	0.0126	
Biased Mean-3σ	-0.0098	-0.0087	-0.0070	
DS MIN	-2.50E-01	-3.60E-01	-3.60E-01	µA
	PASS	PASS	PASS	
DS MAX	2.50E-01	3.60E-01	3.60E-01	µA
	PASS	PASS	PASS	

Figure A-56-2. C2 IB, not measuring, S2 connected vs. LDR TID for the RT6804HG-1.

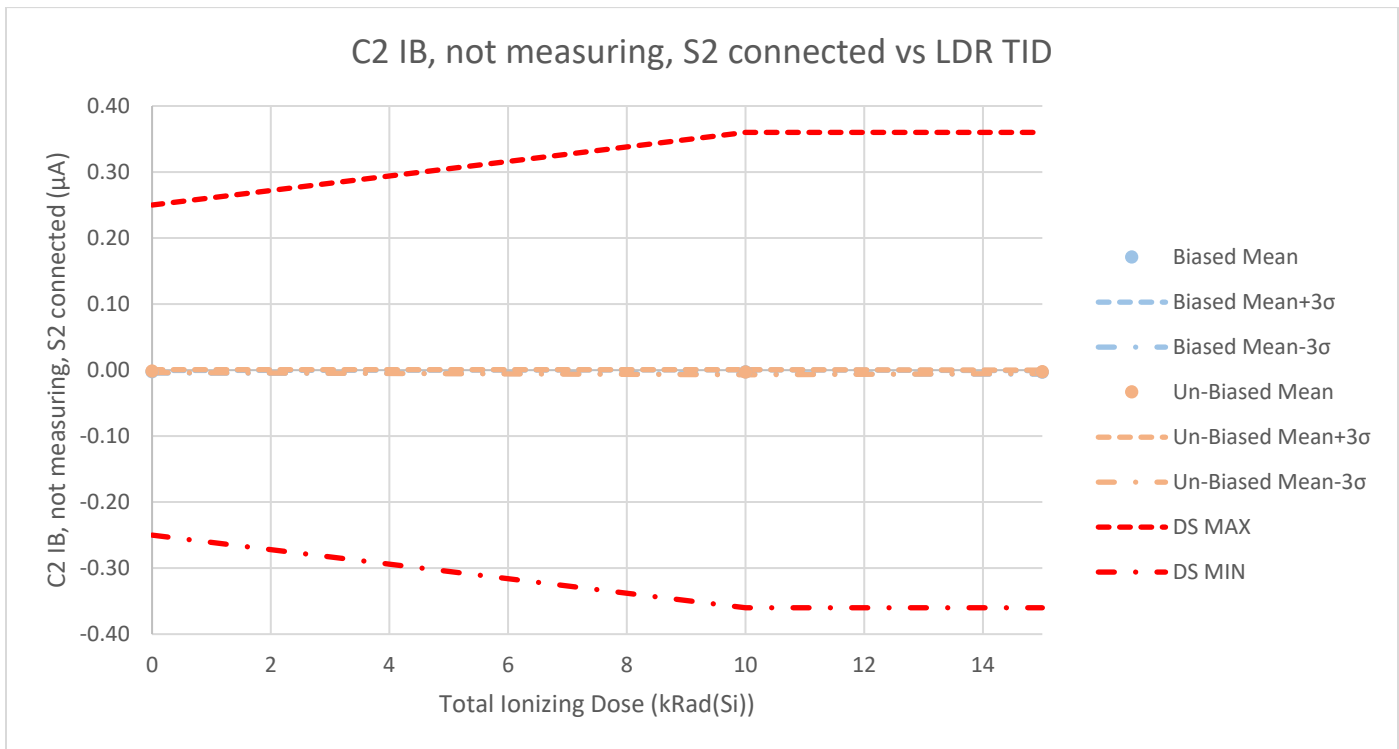

Table A-56-2. C2 IB, not measuring, S2 connected vs. LDR TID for the RT6804HG-1.

Total Ionizing Dose (kRad(Si))	0	10	15	Units
LDR TID Biased				
Biased Mean	-0.0026	-0.0028	-0.0035	µA
Std Dev	0.0006	0.0010	0.0009	
Biased Mean+3σ	-0.0007	0.0003	-0.0009	
Biased Mean-3σ	-0.0046	-0.0059	-0.0061	
LDR TID Un-Biased				
Un-Biased Mean	-0.0016	-0.0033	-0.0027	µA
Std Dev	0.0007	0.0013	0.0009	
Un-Biased Mean+3σ	0.0006	0.0007	-0.0001	
Un-Biased Mean-3σ	-0.0038	-0.0072	-0.0052	
DS MIN	-2.50E-01	-3.60E-01	-3.60E-01	µA
	PASS	PASS	PASS	
DS MAX	2.50E-01	3.60E-01	3.60E-01	µA
	PASS	PASS	PASS	

Figure A-57-1. C3 IB, not measuring, S3 connected vs. HDR TID for the RT6804HG-1.

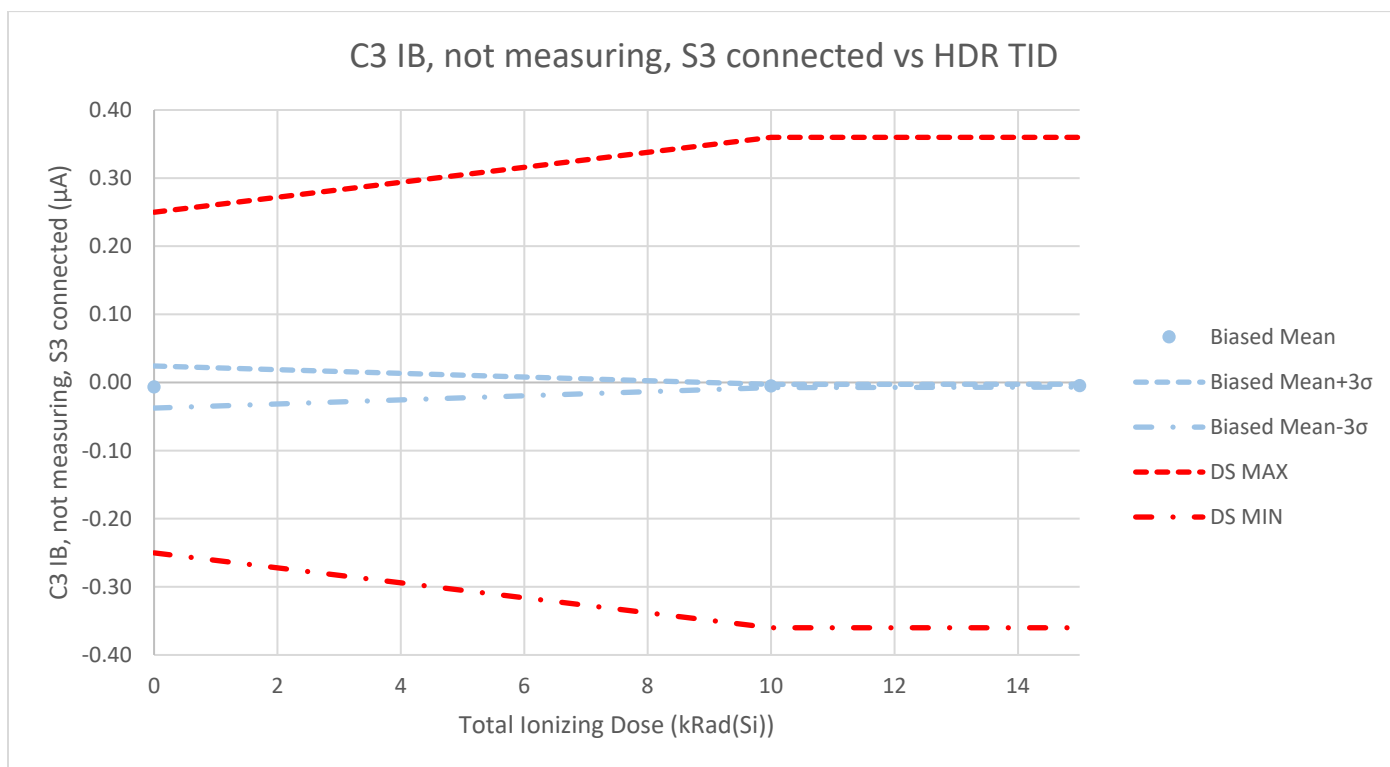

Table A-57-1. C3 IB, not measuring, S3 connected vs. HDR TID for the RT6804HG-1.

HDR TID Biased				
Total Ionizing Dose (kRad(Si))	0	10	15	Units
Biased Mean	-0.0066	-0.0051	-0.0047	µA
Std Dev	0.0103	0.0008	0.0007	
Biased Mean+3σ	0.0243	-0.0027	-0.0027	
Biased Mean-3σ	-0.0374	-0.0076	-0.0067	
DS MIN	-2.50E-01	-3.60E-01	-3.60E-01	µA
	PASS	PASS	PASS	
DS MAX	2.50E-01	3.60E-01	3.60E-01	µA
	PASS	PASS	PASS	

Figure A-57-2. C3 IB, not measuring, S3 connected vs. LDR TID for the RT6804HG-1.

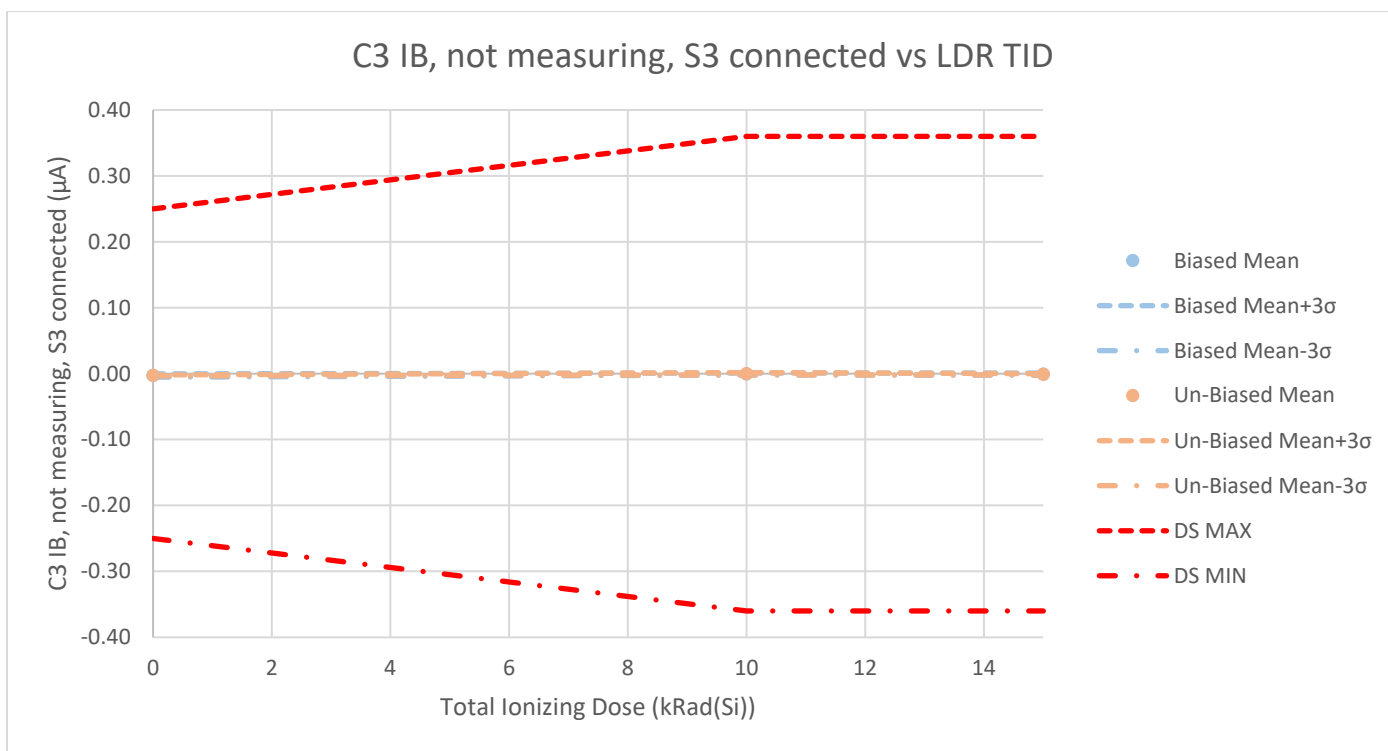

Table A-57-2. C3 IB, not measuring, S3 connected vs. LDR TID for the RT6804HG-1.

Total Ionizing Dose (kRad(Si))	0	10	15	Units
LDR TID Biased				
Biased Mean	-0.0028	-0.0006	-0.0008	µA
Std Dev	0.0008	0.0005	0.0006	
Biased Mean+3σ	-0.0003	0.0009	0.0010	
Biased Mean-3σ	-0.0052	-0.0022	-0.0026	
LDR TID Un-Biased				
Un-Biased Mean	-0.0028	-0.0002	-0.0011	µA
Std Dev	0.0003	0.0006	0.0004	
Un-Biased Mean+3σ	-0.0020	0.0016	0.0000	
Un-Biased Mean-3σ	-0.0036	-0.0020	-0.0022	
DS MIN	-2.50E-01	-3.60E-01	-3.60E-01	µA
	PASS	PASS	PASS	
DS MAX	2.50E-01	3.60E-01	3.60E-01	µA
	PASS	PASS	PASS	

Figure A-58-1. C4 IB, not measuring, S4 connected vs. HDR TID for the RT6804HG-1.

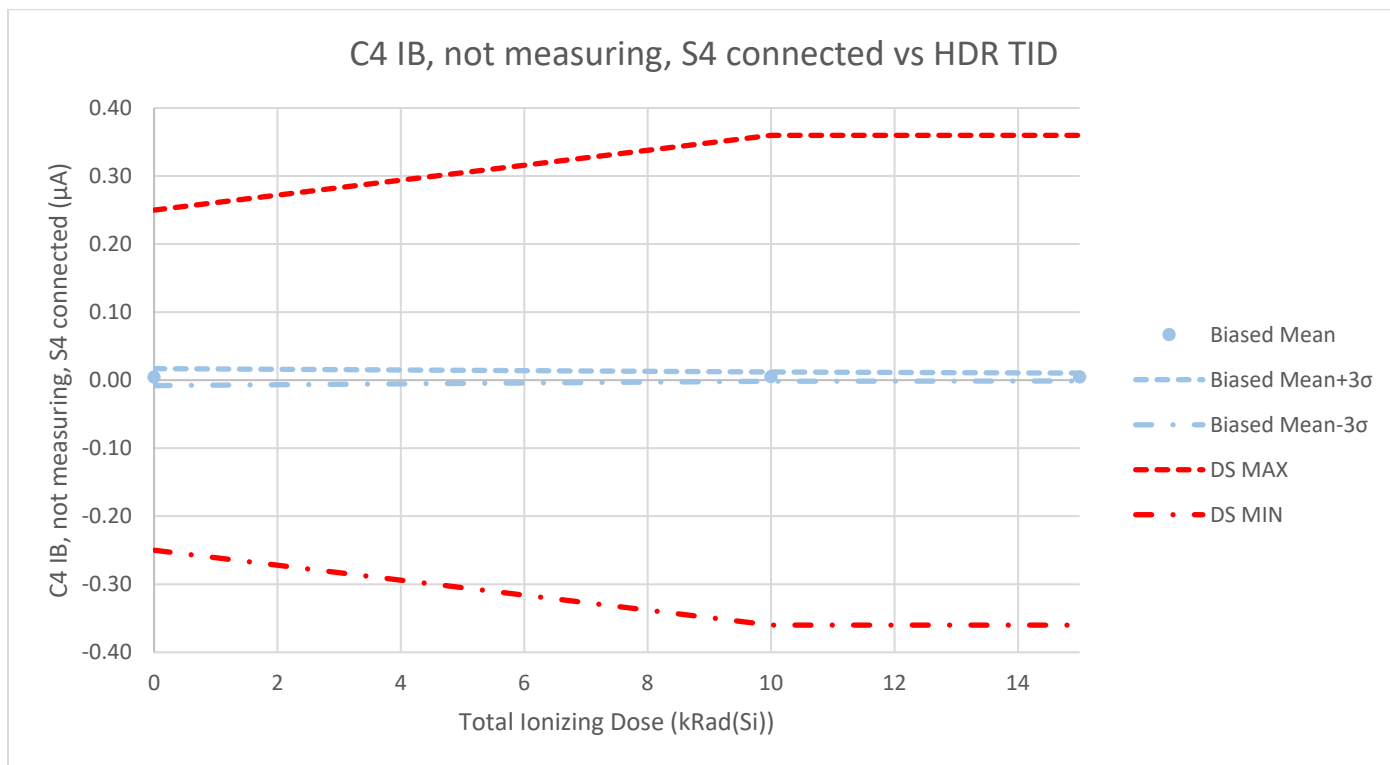

Table A-58-1. C4 IB, not measuring, S4 connected vs. HDR TID for the RT6804HG-1.

HDR TID Biased				
Total Ionizing Dose (kRad(Si))	0	10	15	Units
Biased Mean	0.0046	0.0051	0.0046	µA
Std Dev	0.0041	0.0022	0.0019	
Biased Mean+3σ	0.0170	0.0119	0.0103	
Biased Mean-3σ	-0.0079	-0.0016	-0.0011	
DS MIN	-2.50E-01	-3.60E-01	-3.60E-01	µA
	PASS	PASS	PASS	
DS MAX	2.50E-01	3.60E-01	3.60E-01	µA
	PASS	PASS	PASS	

Figure A-58-2. C4 IB, not measuring, S4 connected vs. LDR TID for the RT6804HG-1.

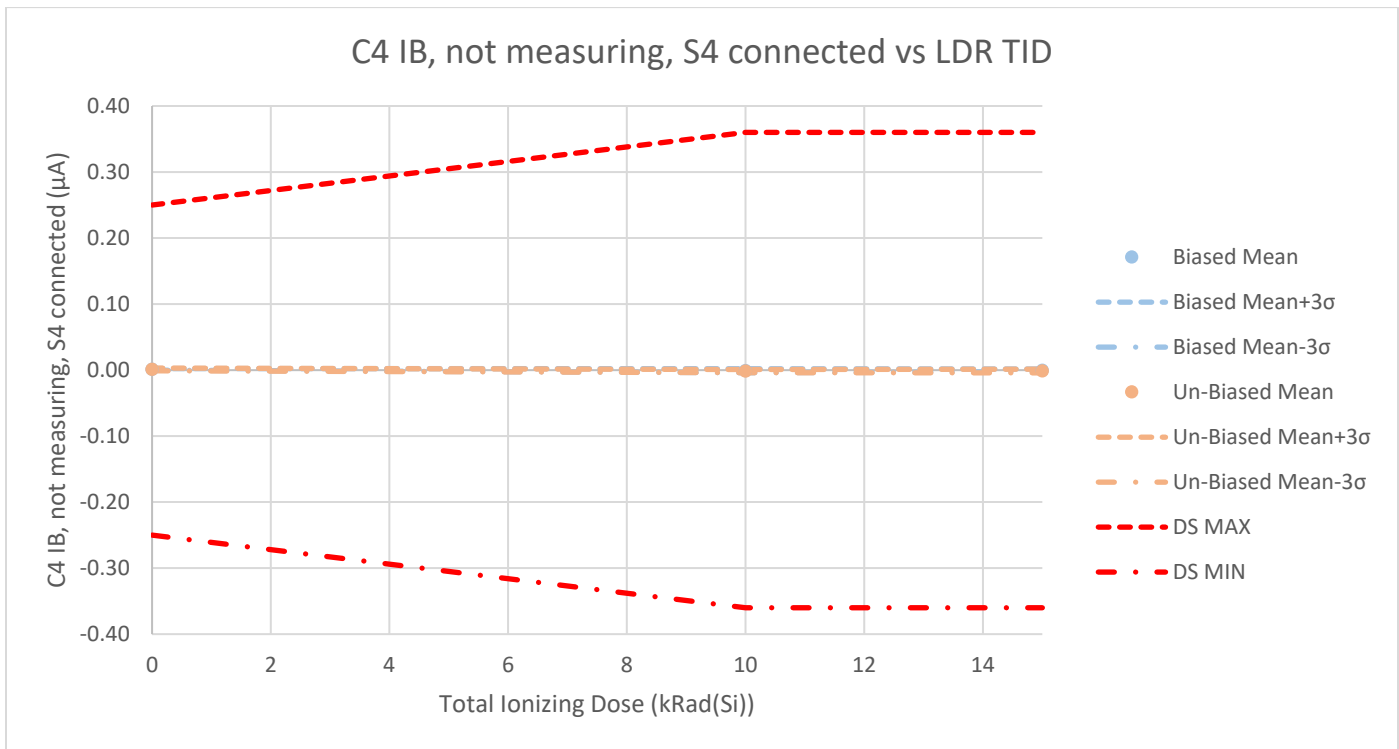

Table A-58-2. C4 IB, not measuring, S4 connected vs. LDR TID for the RT6804HG-1.

Total Ionizing Dose (kRad(Si))	0	10	15	Units
LDR TID Biased				
Biased Mean	0.0011	-0.0010	-0.0005	µA
Std Dev	0.0004	0.0010	0.0007	
Biased Mean+3σ	0.0022	0.0019	0.0016	
Biased Mean-3σ	-0.0001	-0.0040	-0.0026	
LDR TID Un-Biased				
Un-Biased Mean	0.0009	-0.0017	-0.0016	µA
Std Dev	0.0007	0.0008	0.0009	
Un-Biased Mean+3σ	0.0030	0.0008	0.0011	
Un-Biased Mean-3σ	-0.0012	-0.0042	-0.0043	
DS MIN	-2.50E-01	-3.60E-01	-3.60E-01	µA
	PASS	PASS	PASS	
DS MAX	2.50E-01	3.60E-01	3.60E-01	µA
	PASS	PASS	PASS	

Figure A-59-1. C5 IB, not measuring, S5 connected vs. HDR TID for the RT6804HG-1.

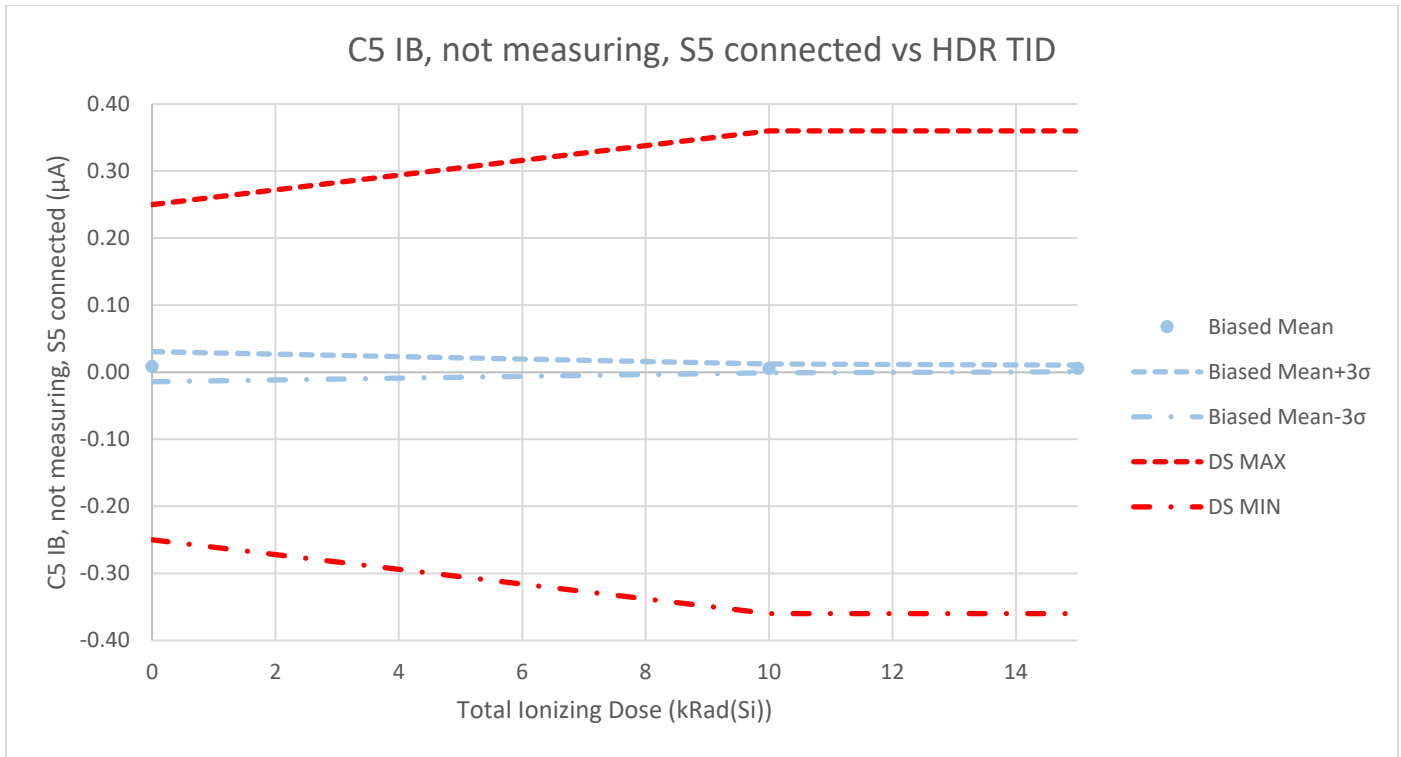

Table A-59-1. C5 IB, not measuring, S5 connected vs. HDR TID for the RT6804HG-1.

HDR TID Biased				
Total Ionizing Dose (kRad(Si))	0	10	15	Units
Biased Mean	0.0083	0.0056	0.0058	µA
Std Dev	0.0075	0.0022	0.0017	
Biased Mean+3σ	0.0308	0.0122	0.0108	
Biased Mean-3σ	-0.0141	-0.0009	0.0007	
DS MIN	-2.50E-01	-3.60E-01	-3.60E-01	µA
	PASS	PASS	PASS	
DS MAX	2.50E-01	3.60E-01	3.60E-01	µA
	PASS	PASS	PASS	

Figure A-59-2. C5 IB, not measuring, S5 connected vs. LDR TID for the RT6804HG-1.

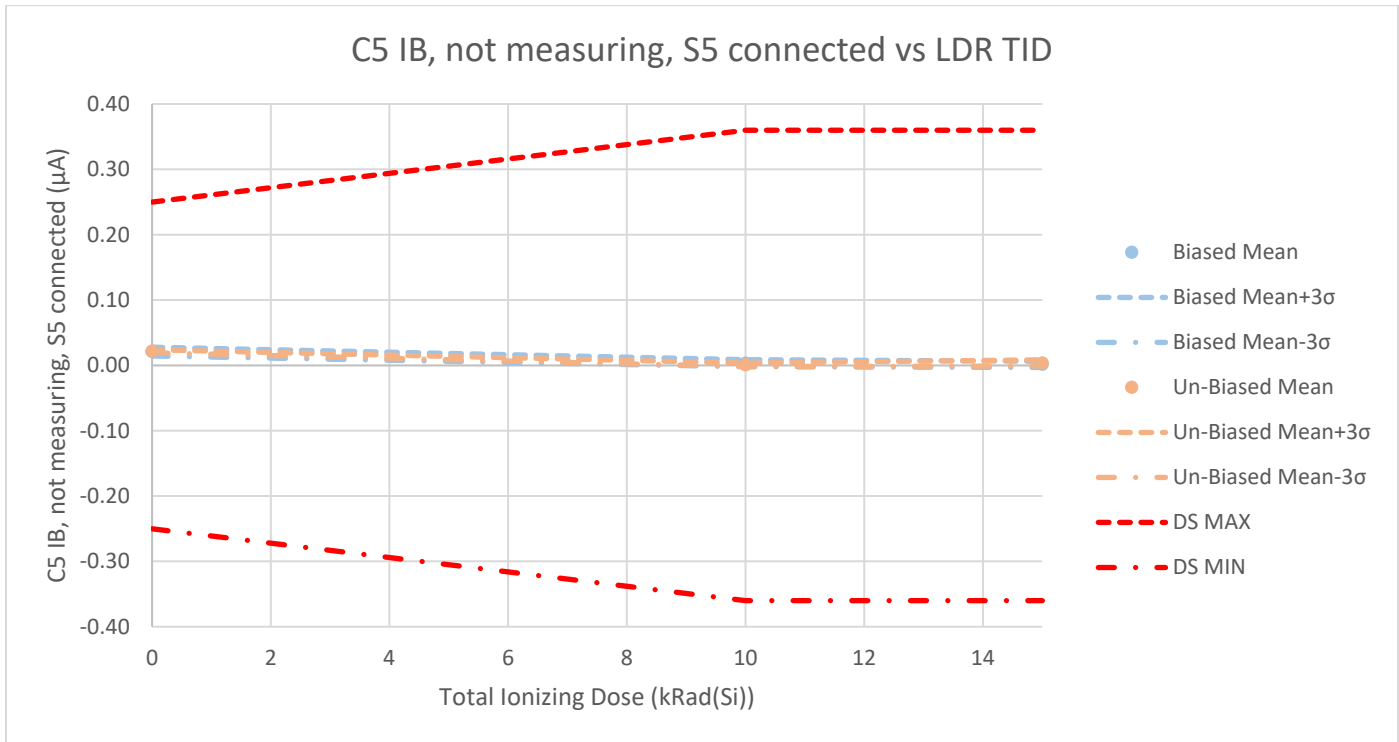

Table A-59-2. C5 IB, not measuring, S5 connected vs. LDR TID for the RT6804HG-1.

Total Ionizing Dose (kRad(Si))	0	10	15	Units
LDR TID Biased				
Biased Mean	0.0212	0.0032	0.0016	µA
Std Dev	0.0023	0.0018	0.0016	
Biased Mean+3σ	0.0279	0.0086	0.0064	
Biased Mean-3σ	0.0144	-0.0021	-0.0032	
LDR TID Un-Biased				
Un-Biased Mean	0.0217	0.0009	0.0036	µA
Std Dev	0.0008	0.0009	0.0016	
Un-Biased Mean+3σ	0.0240	0.0037	0.0083	
Un-Biased Mean-3σ	0.0194	-0.0019	-0.0011	
DS Limits				
DS MIN	-2.50E-01	-3.60E-01	-3.60E-01	µA
	PASS	PASS	PASS	
DS MAX	2.50E-01	3.60E-01	3.60E-01	µA
	PASS	PASS	PASS	

Figure A-60-1. C6 IB, not measuring, S6 connected vs. HDR TID for the RT6804HG-1.

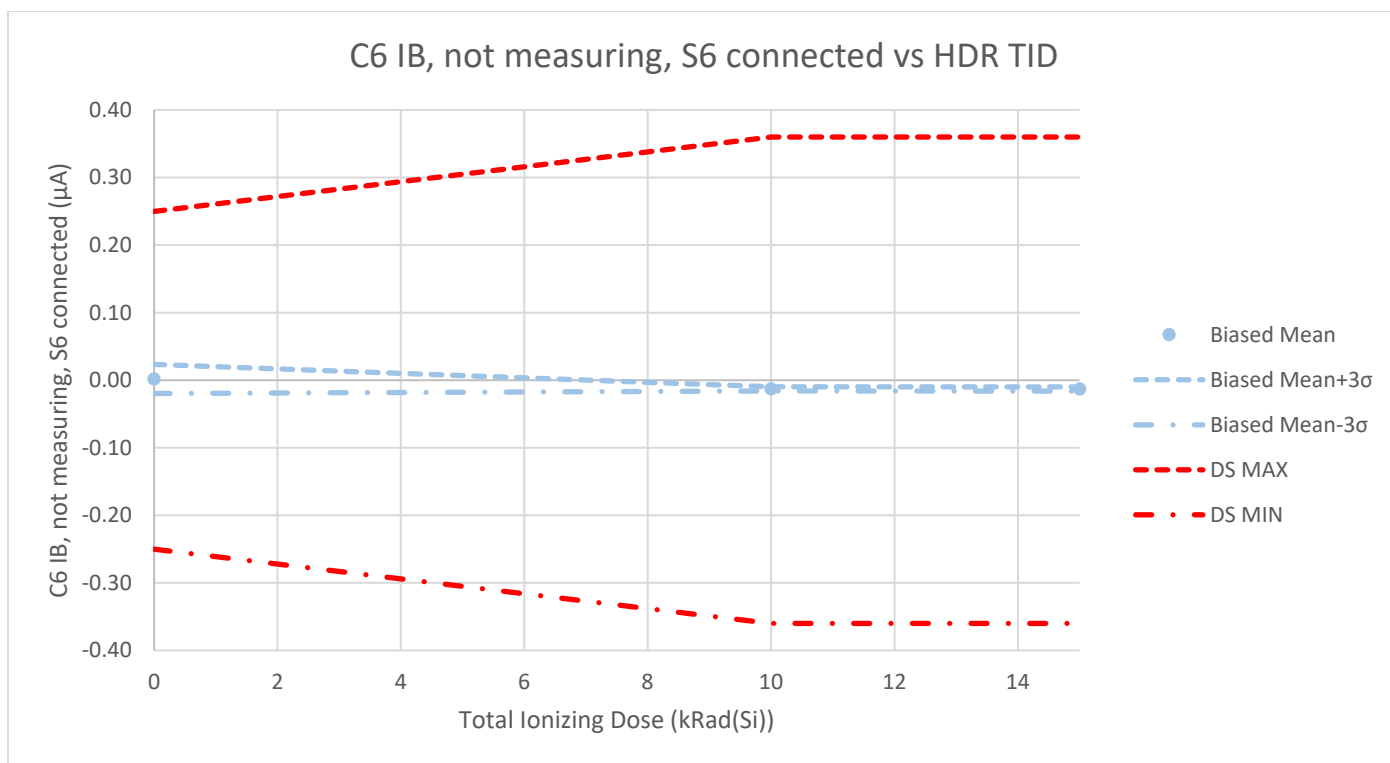

Table A-60-1. C6 IB, not measuring, S6 connected vs. HDR TID for the RT6804HG-1.

HDR TID Biased				
Total Ionizing Dose (kRad(Si))	0	10	15	Units
Biased Mean	0.0019	-0.0128	-0.0130	µA
Std Dev	0.0072	0.0010	0.0010	
Biased Mean+3σ	0.0234	-0.0098	-0.0099	
Biased Mean-3σ	-0.0196	-0.0159	-0.0161	
DS MIN	-2.50E-01	-3.60E-01	-3.60E-01	µA
	PASS	PASS	PASS	
DS MAX	2.50E-01	3.60E-01	3.60E-01	µA
	PASS	PASS	PASS	

Figure A-60-2. C6 IB, not measuring, S6 connected vs. LDR TID for the RT6804HG-1.

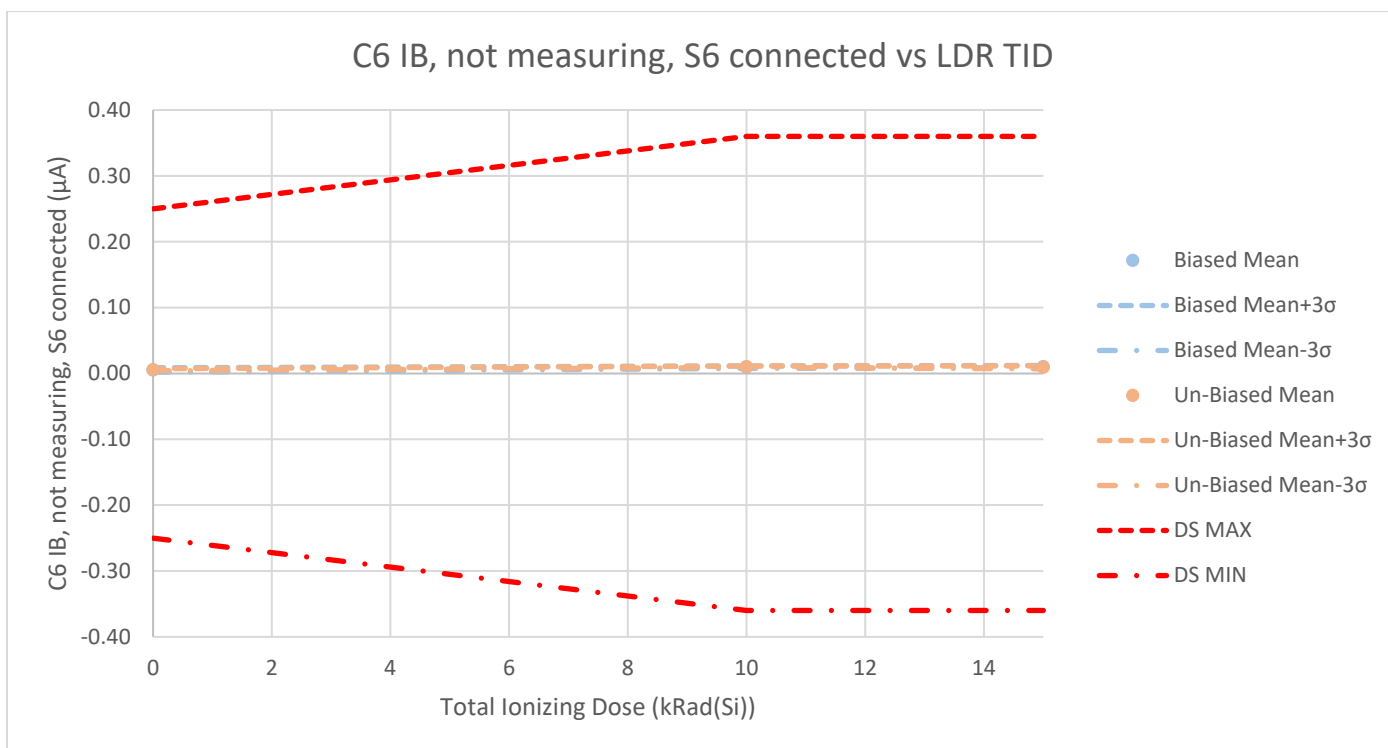

Table A-60-2. C6 IB, not measuring, S6 connected vs. LDR TID for the RT6804HG-1.

Total Ionizing Dose (kRad(Si))	0	10	15	Units
LDR TID Biased				
Biased Mean	0.0053	0.0094	0.0104	µA
Std Dev	0.0012	0.0006	0.0006	
Biased Mean+3σ	0.0088	0.0113	0.0121	
Biased Mean-3σ	0.0018	0.0075	0.0087	
LDR TID Un-Biased				
Un-Biased Mean	0.0057	0.0103	0.0093	µA
Std Dev	0.0006	0.0003	0.0008	
Un-Biased Mean+3σ	0.0073	0.0113	0.0115	
Un-Biased Mean-3σ	0.0040	0.0093	0.0070	
DS MIN	-2.50E-01	-3.60E-01	-3.60E-01	µA
	PASS	PASS	PASS	
DS MAX	2.50E-01	3.60E-01	3.60E-01	µA
	PASS	PASS	PASS	

Figure A-61-1. C7 IB, not measuring, S7 connected vs. HDR TID for the RT6804HG-1.

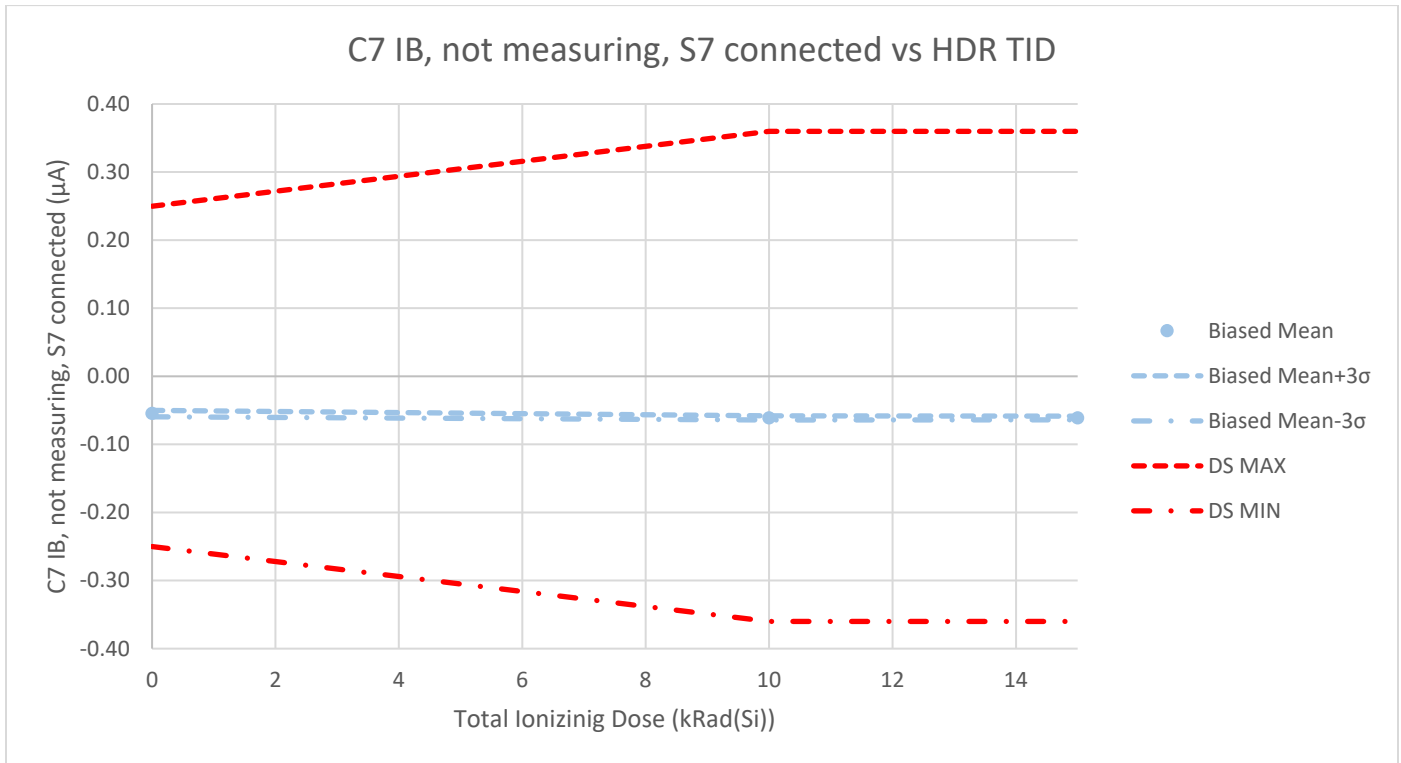

Table A-61-1. C7 IB, not measuring, S7 connected vs. HDR TID for the RT6804HG-1.

HDR TID Biased				
Total Ionizing Dose (kRad(Si))	0	10	15	Units
Biased Mean	-0.0547	-0.0612	-0.0613	µA
Std Dev	0.0015	0.0010	0.0009	
Biased Mean+3σ	-0.0501	-0.0581	-0.0585	
Biased Mean-3σ	-0.0593	-0.0642	-0.0640	
DS MIN	-2.50E-01	-3.60E-01	-3.60E-01	µA
	PASS	PASS	PASS	
DS MAX	2.50E-01	3.60E-01	3.60E-01	µA
	PASS	PASS	PASS	

Figure A-61-2. C7 IB, not measuring, S7 connected vs. LDR TID for the RT6804HG-1.

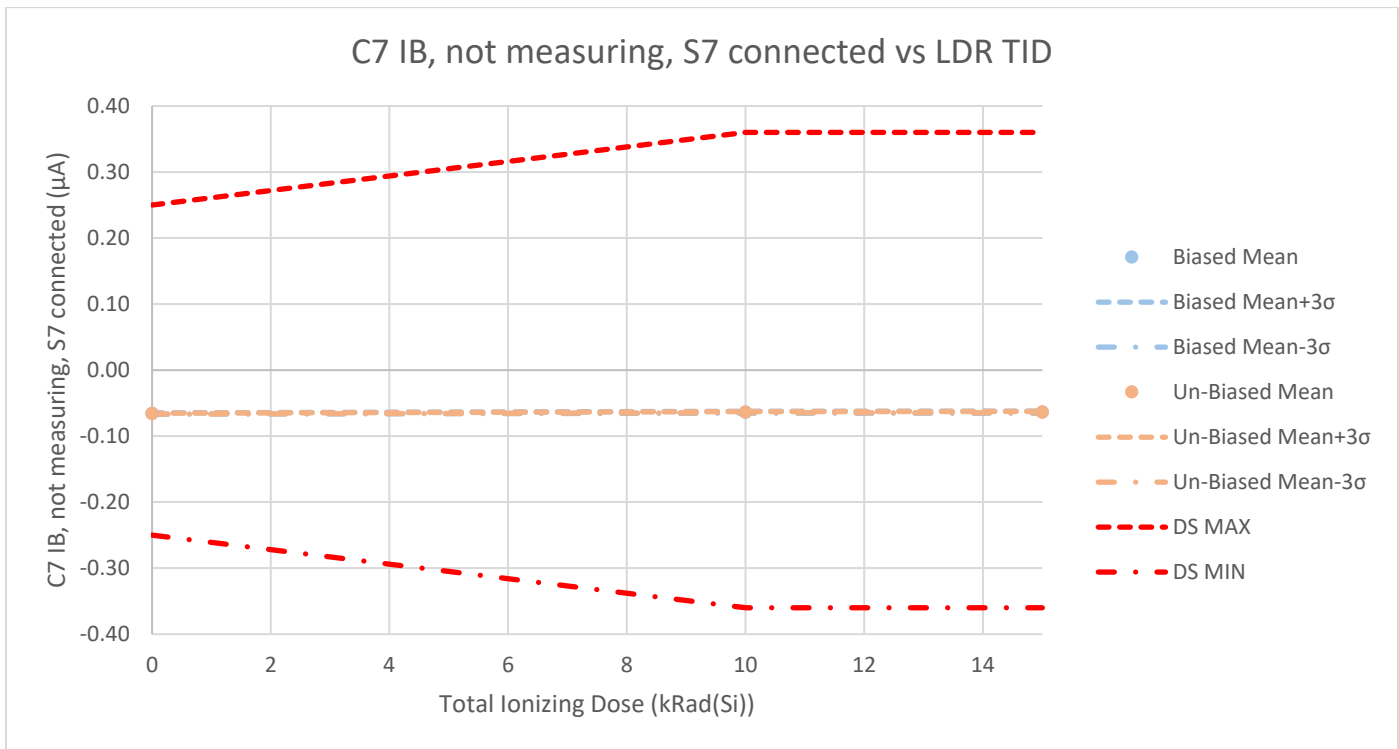

Table A-61-2. C7 IB, not measuring, S7 connected vs. LDR TID for the RT6804HG-1.

Total Ionizing Dose (kRad(Si))	0	10	15	Units
LDR TID Biased				
Biased Mean	-0.0657	-0.0640	-0.0638	µA
Std Dev	0.0003	0.0005	0.0005	
Biased Mean+3σ	-0.0647	-0.0625	-0.0622	
Biased Mean-3σ	-0.0667	-0.0655	-0.0654	
LDR TID Un-Biased				
Un-Biased Mean	-0.0660	-0.0638	-0.0638	µA
Std Dev	0.0002	0.0003	0.0004	
Un-Biased Mean+3σ	-0.0653	-0.0630	-0.0627	
Un-Biased Mean-3σ	-0.0667	-0.0646	-0.0648	
DS MIN	-2.50E-01	-3.60E-01	-3.60E-01	µA
	PASS	PASS	PASS	
DS MAX	2.50E-01	3.60E-01	3.60E-01	µA
	PASS	PASS	PASS	

Figure A-62-1. C8 IB, not measuring, S8 connected vs. HDR TID for the RT6804HG-1.

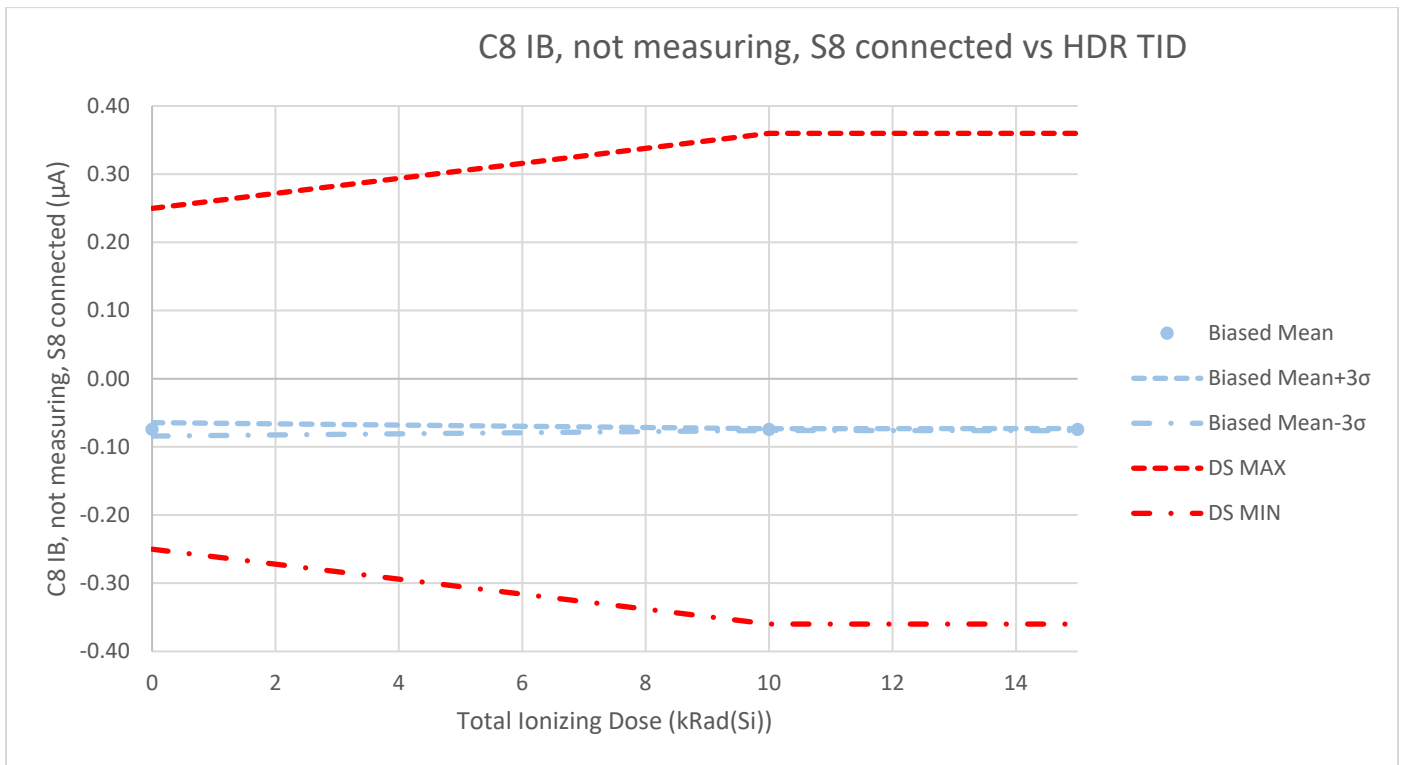

Table A-62-1. C8 IB, not measuring, S8 connected vs. HDR TID for the RT6804HG-1.

HDR TID Biased				
Total Ionizing Dose (kRad(Si))	0	10	15	Units
Biased Mean	-0.0743	-0.0747	-0.0747	µA
Std Dev	0.0033	0.0004	0.0005	
Biased Mean+3σ	-0.0644	-0.0734	-0.0732	
Biased Mean-3σ	-0.0842	-0.0760	-0.0761	
DS MIN	-2.50E-01	-3.60E-01	-3.60E-01	µA
	PASS	PASS	PASS	
DS MAX	2.50E-01	3.60E-01	3.60E-01	µA
	PASS	PASS	PASS	

Figure A-62-2. C8 IB, not measuring, S8 connected vs. LDR TID for the RT6804HG-1.

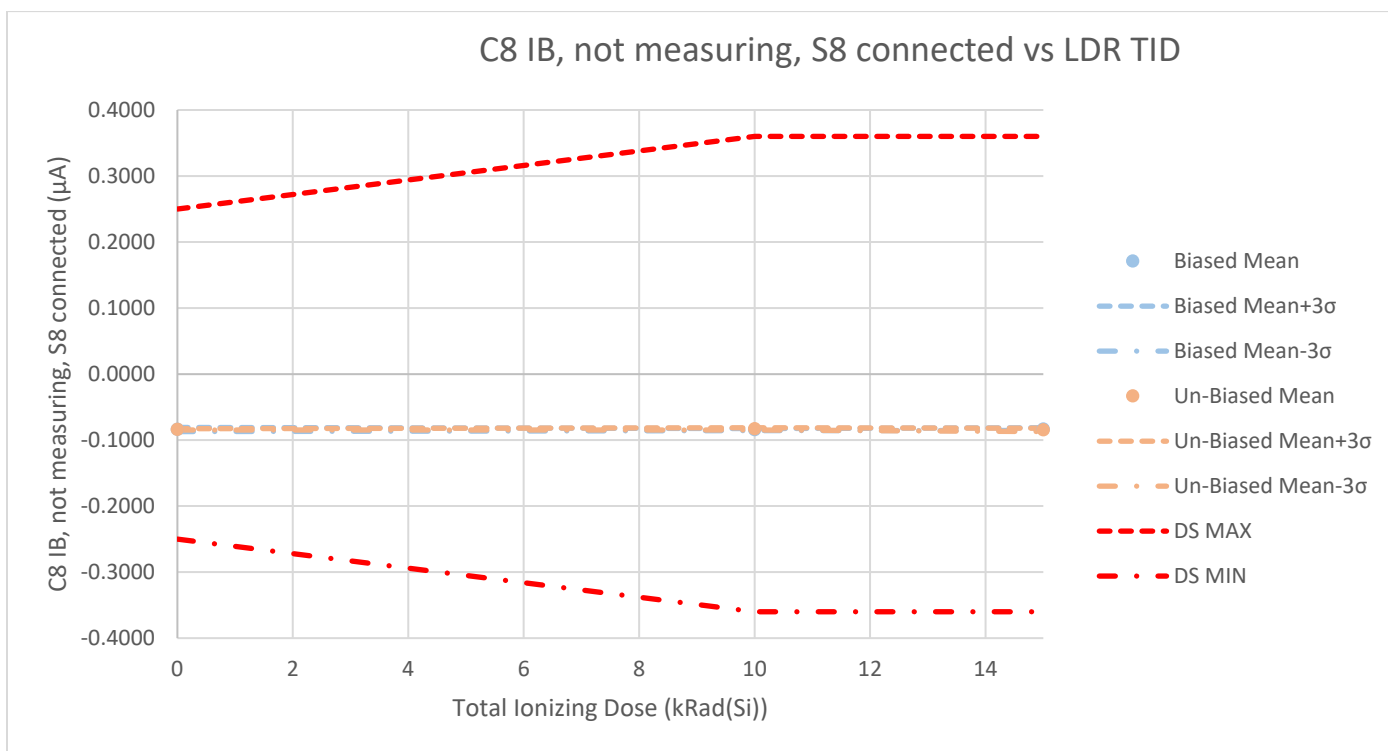

Table A-62-2. C8 IB, not measuring, S8 connected vs. LDR TID for the RT6804HG-1.

Total Ionizing Dose (kRad(Si))	0	10	15	Units
LDR TID Biased				
Biased Mean	-0.0840	-0.0842	-0.0835	µA
Std Dev	0.0011	0.0006	0.0007	
Biased Mean+3σ	-0.0808	-0.0826	-0.0814	
Biased Mean-3σ	-0.0872	-0.0859	-0.0855	
LDR TID Un-Biased				
Un-Biased Mean	-0.0838	-0.0830	-0.0847	µA
Std Dev	0.0003	0.0005	0.0008	
Un-Biased Mean+3σ	-0.0829	-0.0814	-0.0821	
Un-Biased Mean-3σ	-0.0848	-0.0846	-0.0872	
DS MIN	-2.50E-01	-3.60E-01	-3.60E-01	µA
	PASS	PASS	PASS	
DS MAX	2.50E-01	3.60E-01	3.60E-01	µA
	PASS	PASS	PASS	

Figure A-63-1. C9 IB, not measuring, S9 connected vs. HDR TID for the RT6804HG-1.

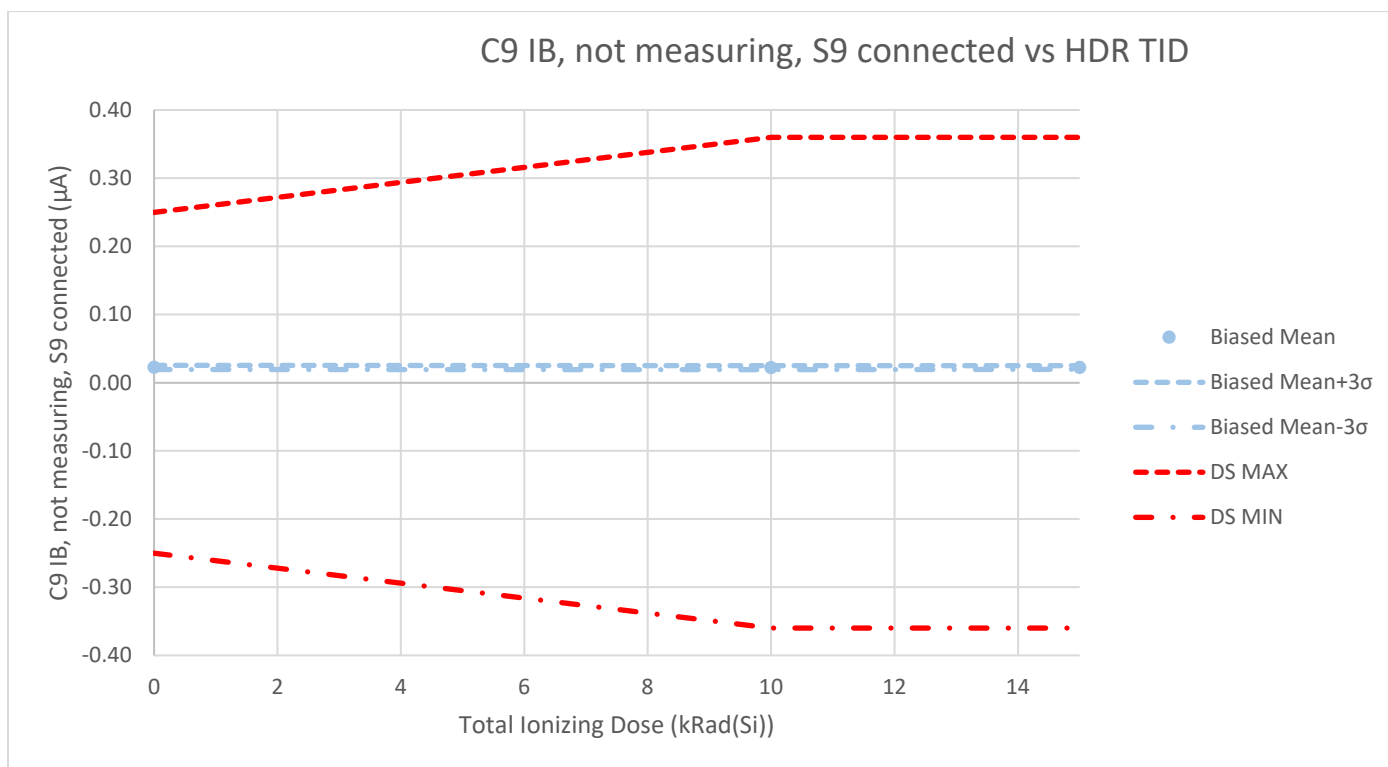

Table A-63-1. C9 IB, not measuring, S9 connected vs. HDR TID for the RT6804HG-1.

HDR TID Biased				
Total Ionizing Dose (kRad(Si))	0	10	15	Units
Biased Mean	0.0225	0.0221	0.0223	µA
Std Dev	0.0011	0.0010	0.0009	
Biased Mean+3σ	0.0256	0.0250	0.0249	
Biased Mean-3σ	0.0193	0.0191	0.0197	
DS MIN	-2.50E-01	-3.60E-01	-3.60E-01	µA
	PASS	PASS	PASS	
DS MAX	2.50E-01	3.60E-01	3.60E-01	µA
	PASS	PASS	PASS	

Figure A-63-2. C9 IB, not measuring, S9 connected vs. LDR TID for the RT6804HG-1.

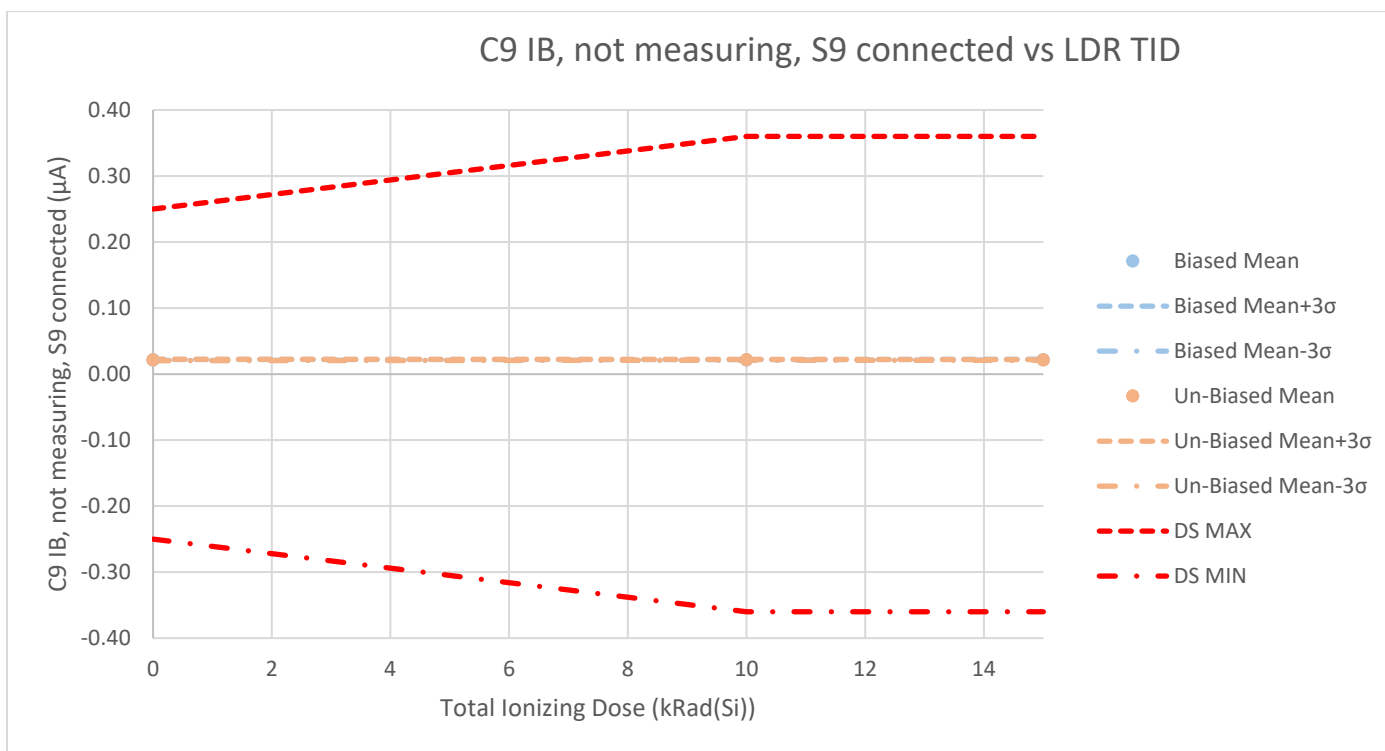

Table A-63-2. C9 IB, not measuring, S9 connected vs. LDR TID for the RT6804HG-1.

Total Ionizing Dose (kRad(Si))	0	10	15	Units
LDR TID Biased				
Biased Mean	0.0214	0.0215	0.0217	µA
Std Dev	0.0002	0.0001	0.0002	
Biased Mean+3σ	0.0220	0.0219	0.0224	
Biased Mean-3σ	0.0208	0.0211	0.0210	
LDR TID Un-Biased				
Un-Biased Mean	0.0213	0.0215	0.0213	µA
Std Dev	0.0004	0.0002	0.0002	
Un-Biased Mean+3σ	0.0223	0.0220	0.0219	
Un-Biased Mean-3σ	0.0202	0.0210	0.0207	
DS MIN	-2.50E-01	-3.60E-01	-3.60E-01	µA
	PASS	PASS	PASS	
DS MAX	2.50E-01	3.60E-01	3.60E-01	µA
	PASS	PASS	PASS	

Figure A-64-1. C10 IB, not measuring, S10 connected vs. HDR TID for the RT6804HG-1.

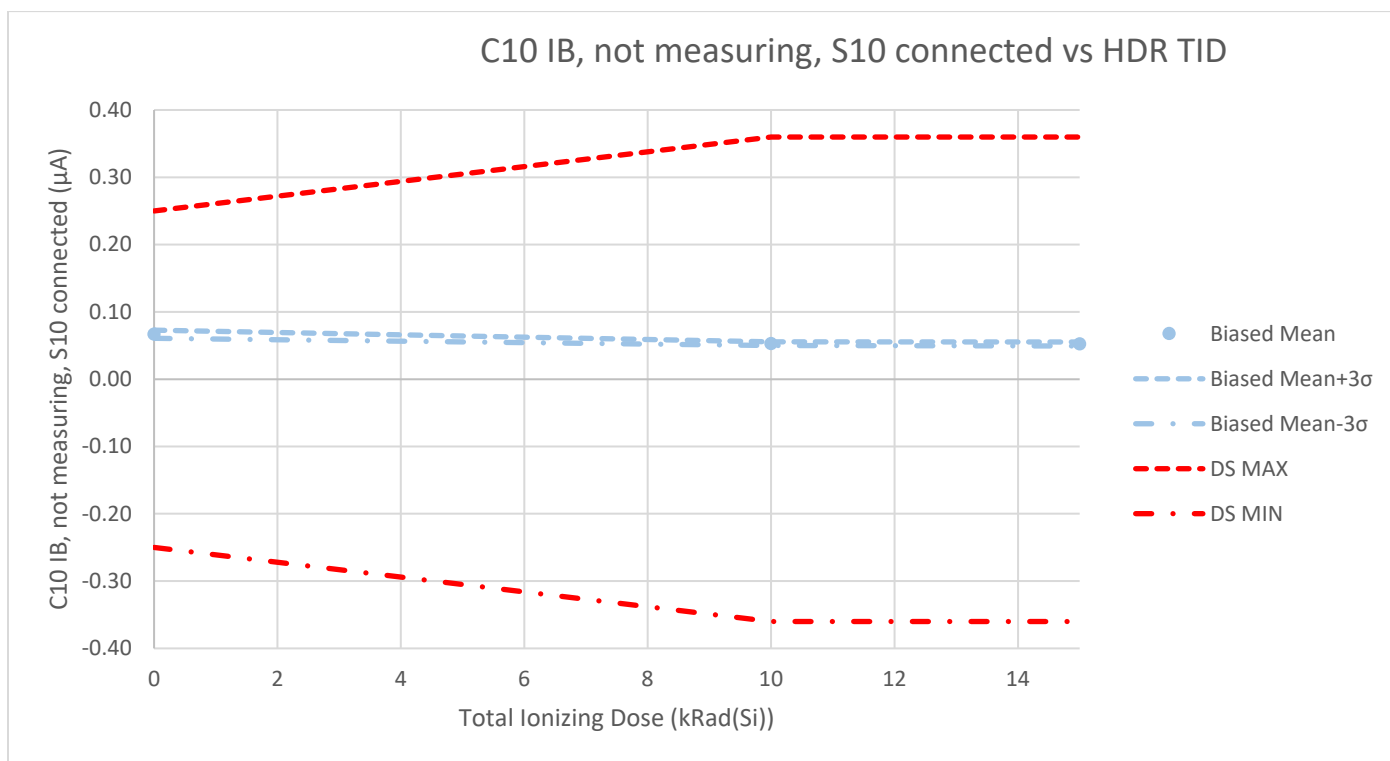

Table A-64-1. C10 IB, not measuring, S10 connected vs. HDR TID for the RT6804HG-1.

HDR TID Biased				
Total Ionizing Dose (kRad(Si))	0	10	15	Units
Biased Mean	0.0668	0.0528	0.0523	µA
Std Dev	0.0020	0.0009	0.0010	
Biased Mean+3σ	0.0728	0.0555	0.0554	
Biased Mean-3σ	0.0607	0.0500	0.0493	
DS MIN	-2.50E-01	-3.60E-01	-3.60E-01	µA
	PASS	PASS	PASS	
DS MAX	2.50E-01	3.60E-01	3.60E-01	µA
	PASS	PASS	PASS	

Figure A-64-2. C10 IB, not measuring, S10 connected vs. LDR TID for the RT6804HG-1.

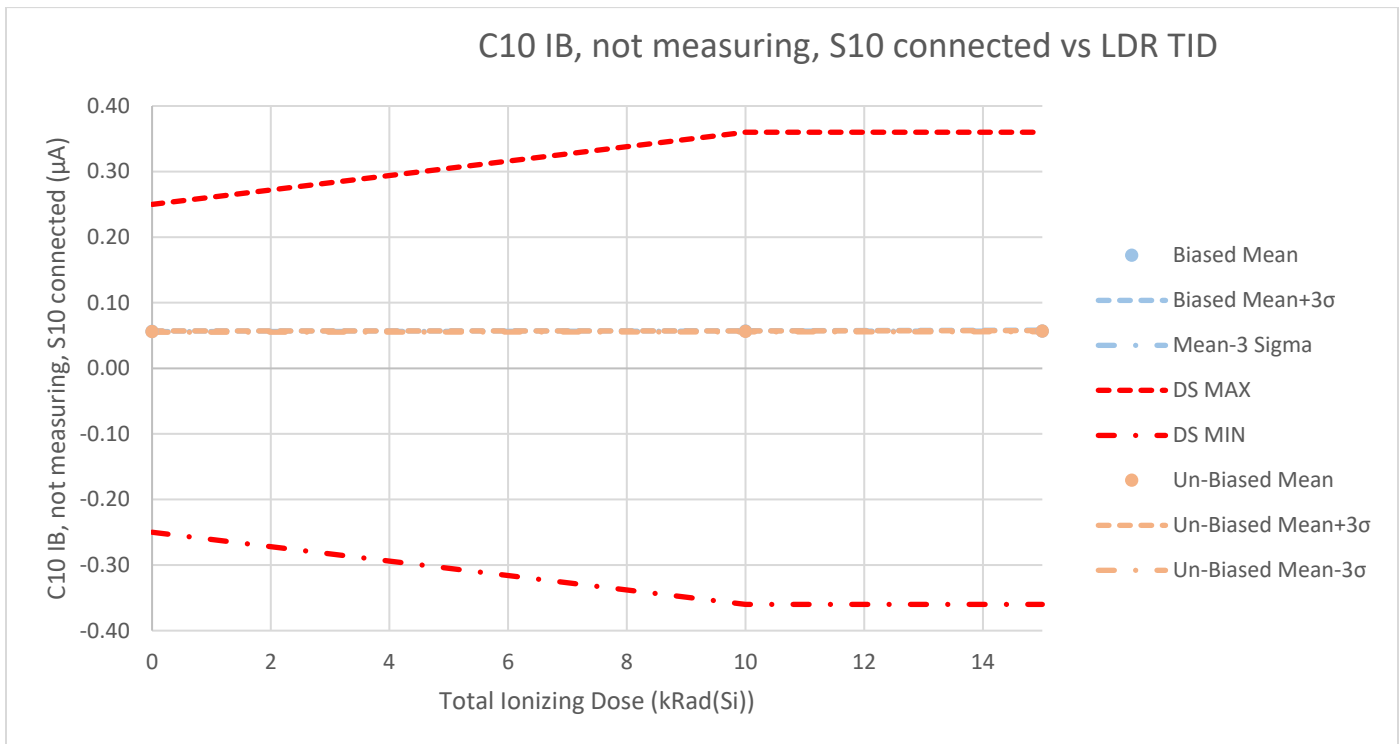

Table A-64-2. C10 IB, not measuring, S10 connected vs. LDR TID for the RT6804HG-1.

Total Ionizing Dose (kRad(Si))	0	10	15	Units
LDR TID Biased				
Biased Mean	0.0561	0.0567	0.0566	µA
Std Dev	0.0003	0.0001	0.0005	
Biased Mean+3σ	0.0570	0.0571	0.0583	
Biased Mean-3σ	0.0551	0.0563	0.0550	
LDR TID Un-Biased				
Un-Biased Mean	0.0560	0.0562	0.0567	µA
Std Dev	0.0003	0.0003	0.0003	
Un-Biased Mean+3σ	0.0569	0.0570	0.0575	
Un-Biased Mean-3σ	0.0551	0.0554	0.0558	
DS Limits				
DS MIN	-2.50E-01	-3.60E-01	-3.60E-01	µA
	PASS	PASS	PASS	
DS MAX	2.50E-01	3.60E-01	3.60E-01	µA
	PASS	PASS	PASS	

Figure A-65-1. C11 IB, not measuring, S11 connected vs. HDR TID for the RT6804HG-1.

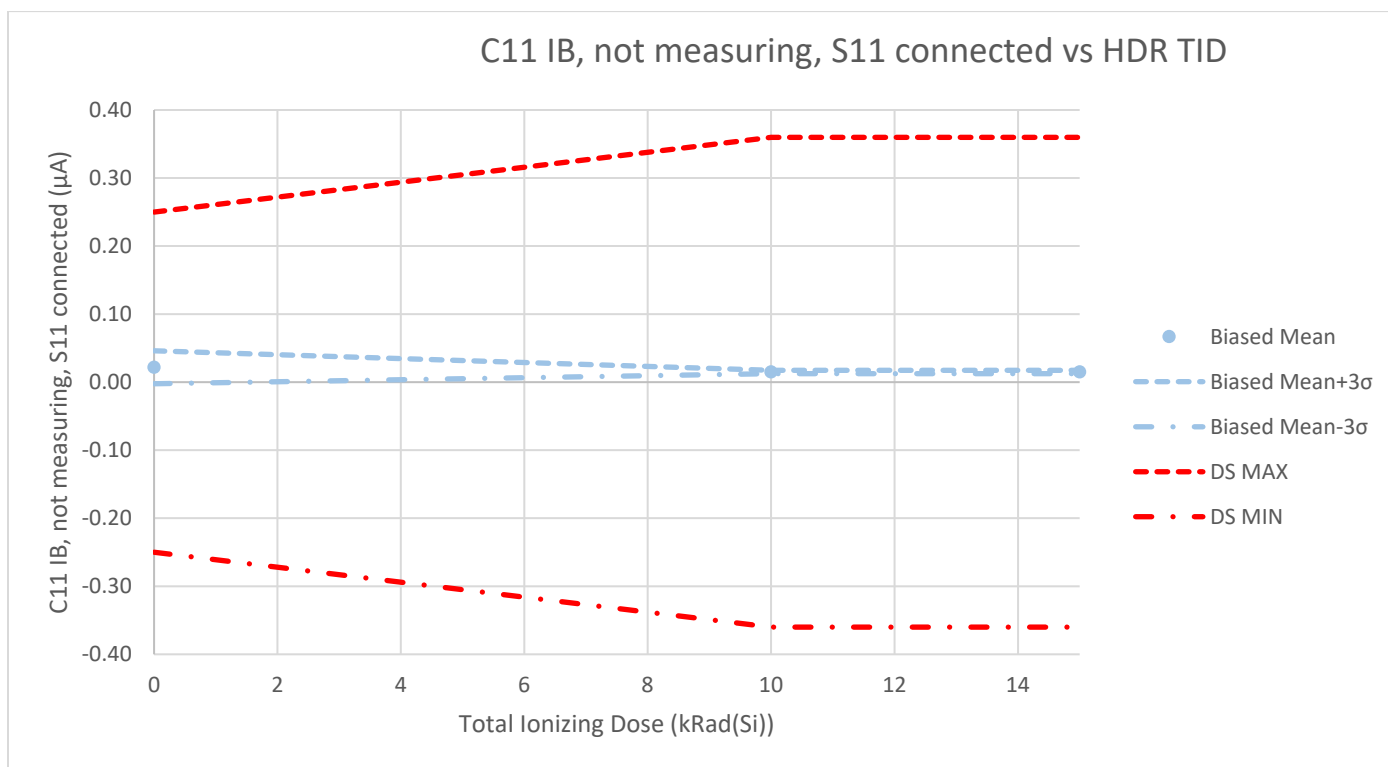

Table A-65-1. C11 IB, not measuring, S11 connected vs. HDR TID for the RT6804HG-1.

HDR TID Biased				
Total Ionizing Dose (kRad(Si))	0	10	15	Units
Biased Mean	0.0219	0.0150	0.0150	µA
Std Dev	0.0081	0.0008	0.0008	
Biased Mean+3σ	0.0461	0.0175	0.0175	
Biased Mean-3σ	-0.0023	0.0125	0.0125	
DS MIN	-2.50E-01	-3.60E-01	-3.60E-01	µA
	PASS	PASS	PASS	
DS MAX	2.50E-01	3.60E-01	3.60E-01	µA
	PASS	PASS	PASS	

Figure A-65-2. C11 IB, not measuring, S11 connected vs. LDR TID for the RT6804HG-1.

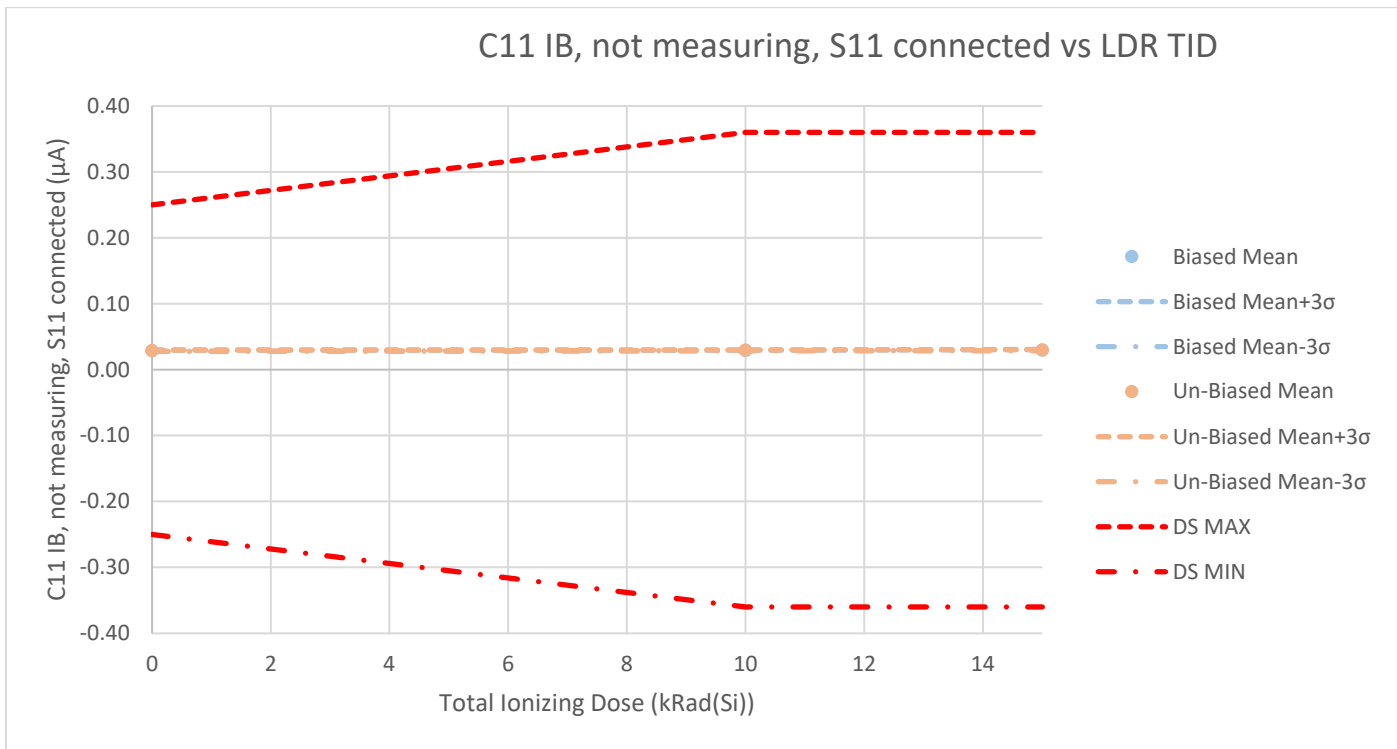

Table A-65-2. C11 IB, not measuring, S11 connected vs. LDR TID for the RT6804HG-1.

Total Ionizing Dose (kRad(Si))	0	10	15	Units
LDR TID Biased				
Biased Mean	0.0287	0.0291	0.0296	µA
Std Dev	0.0003	0.0001	0.0003	
Biased Mean+3σ	0.0296	0.0296	0.0305	
Biased Mean-3σ	0.0278	0.0287	0.0287	
LDR TID Un-Biased				
Un-Biased Mean	0.0288	0.0295	0.0296	µA
Std Dev	0.0003	0.0001	0.0003	
Un-Biased Mean+3σ	0.0297	0.0298	0.0306	
Un-Biased Mean-3σ	0.0279	0.0292	0.0287	
DS MIN	-2.50E-01	-3.60E-01	-3.60E-01	µA
	PASS	PASS	PASS	
DS MAX	2.50E-01	3.60E-01	3.60E-01	µA
	PASS	PASS	PASS	

Figure A-66-1. C12 IB, not measuring, S12 connected vs. HDR TID for the RT6804HG-1.

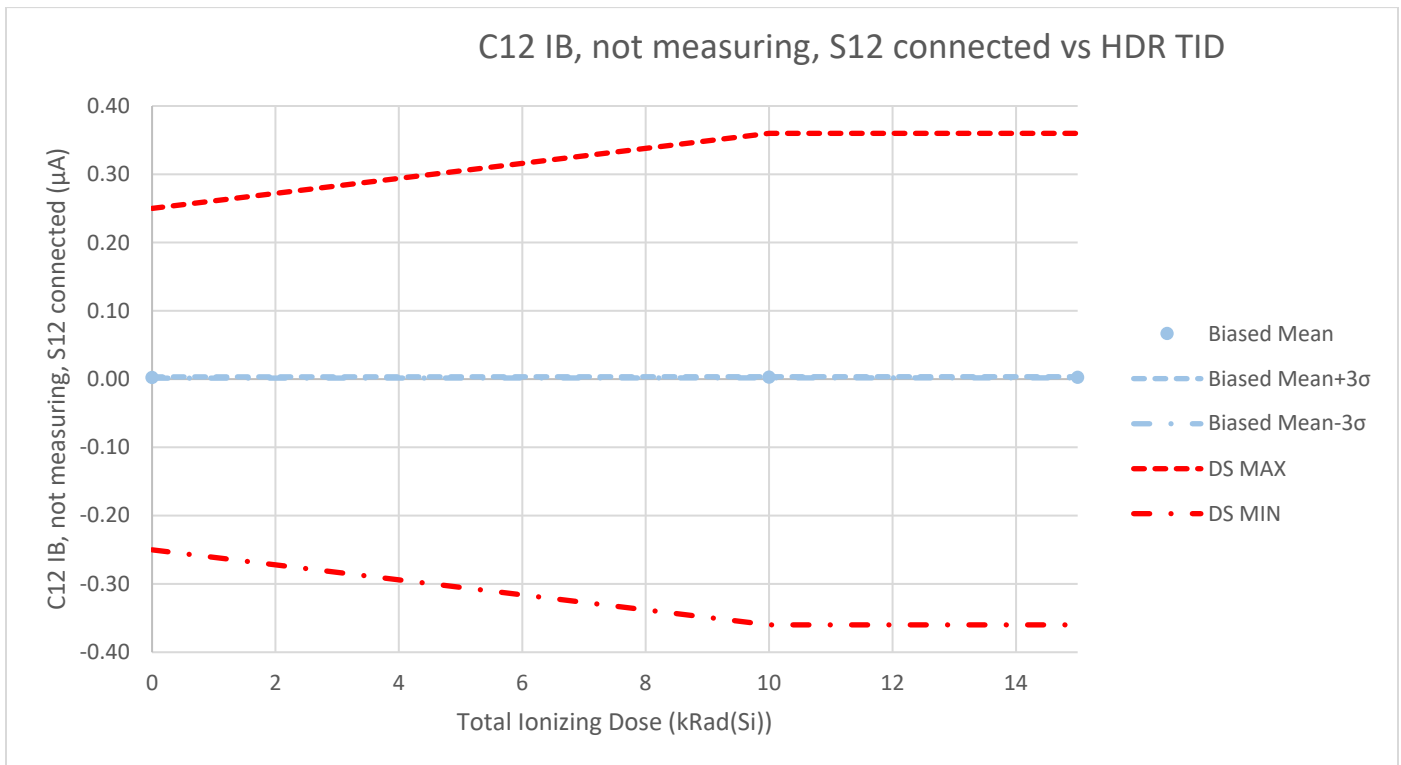

Table A-66-1. C12 IB, not measuring, S12 connected vs. HDR TID for the RT6804HG-1.

HDR TID Biased				
Total Ionizing Dose (kRad(Si))	0	10	15	Units
Biased Mean	0.0023	0.0027	0.0026	µA
Std Dev	0.0003	0.0002	0.0002	
Biased Mean+3σ	0.0033	0.0035	0.0033	
Biased Mean-3σ	0.0013	0.0020	0.0019	
DS MIN	-2.50E-01	-3.60E-01	-3.60E-01	µA
	PASS	PASS	PASS	
DS MAX	2.50E-01	3.60E-01	3.60E-01	µA
	PASS	PASS	PASS	

Figure A-66-2. C12 IB, not measuring, S12 connected vs. LDR TID for the RT6804HG-1.

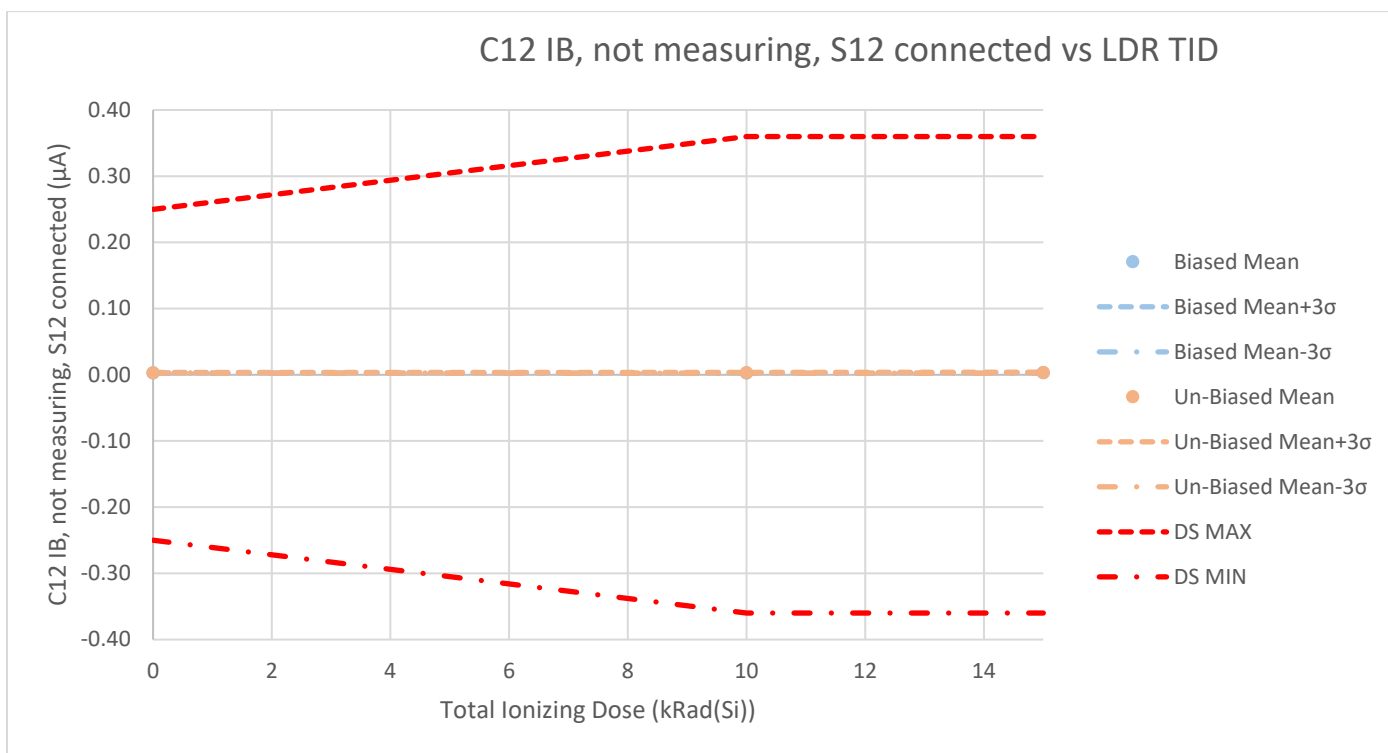

Table A-66-2. C12 IB, not measuring, S12 connected vs. LDR TID for the RT6804HG-1.

Total Ionizing Dose (kRad(Si))	0	10	15	Units
LDR TID Biased				
Biased Mean	0.0029	0.0027	0.0030	µA
Std Dev	0.0001	0.0001	0.0002	
Biased Mean+3σ	0.0033	0.0031	0.0035	
Biased Mean-3σ	0.0025	0.0023	0.0025	
LDR TID Un-Biased				
Un-Biased Mean	0.0029	0.0030	0.0032	µA
Std Dev	0.0002	0.0002	0.0002	
Un-Biased Mean+3σ	0.0034	0.0035	0.0039	
Un-Biased Mean-3σ	0.0025	0.0024	0.0025	
DS MIN	-2.50E-01	-3.60E-01	-3.60E-01	µA
	PASS	PASS	PASS	
DS MAX	2.50E-01	3.60E-01	3.60E-01	µA
	PASS	PASS	PASS	

Figure A-67-1. GPIO1 IB, not measuring vs. HDR TID for the RT6804HG-1.

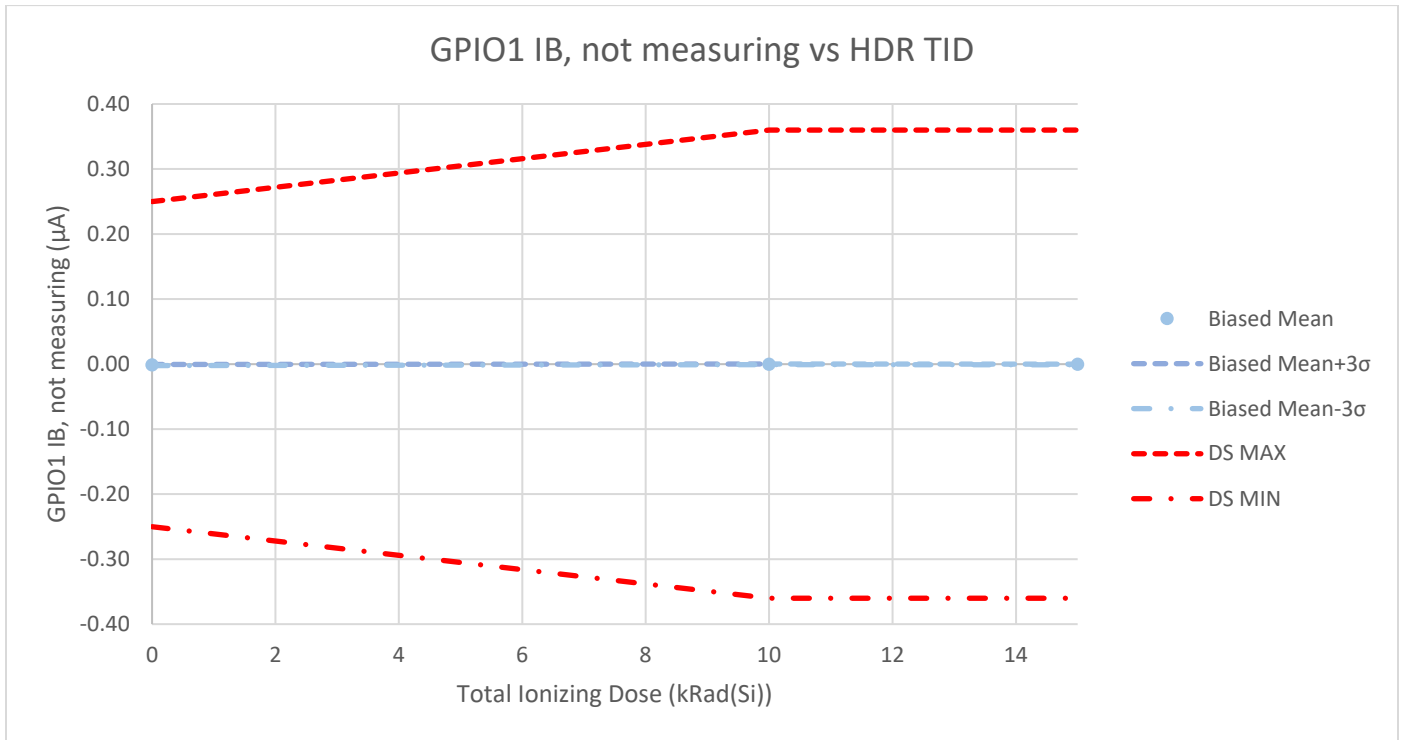

Table A-67-1. GPIO1 IB, not measuring vs. HDR TID for the RT6804HG-1.

HDR TID Biased				
Total Ionizing Dose (kRad(Si))	0	10	15	Units
Biased Mean	-0.0014	-0.0004	-0.0004	μA
Std Dev	0.0003	0.0002	0.0002	
Biased Mean+3σ	-0.0006	0.0001	0.0000	
Biased Mean-3σ	-0.0022	-0.0009	-0.0009	
DS MIN	-2.50E-01	-3.60E-01	-3.60E-01	μA
	PASS	PASS	PASS	
DS MAX	2.50E-01	3.60E-01	3.60E-01	μA
	PASS	PASS	PASS	

Figure A-67-2. GPIO1 IB, not measuring vs. LDR TID for the RT6804HG-1.

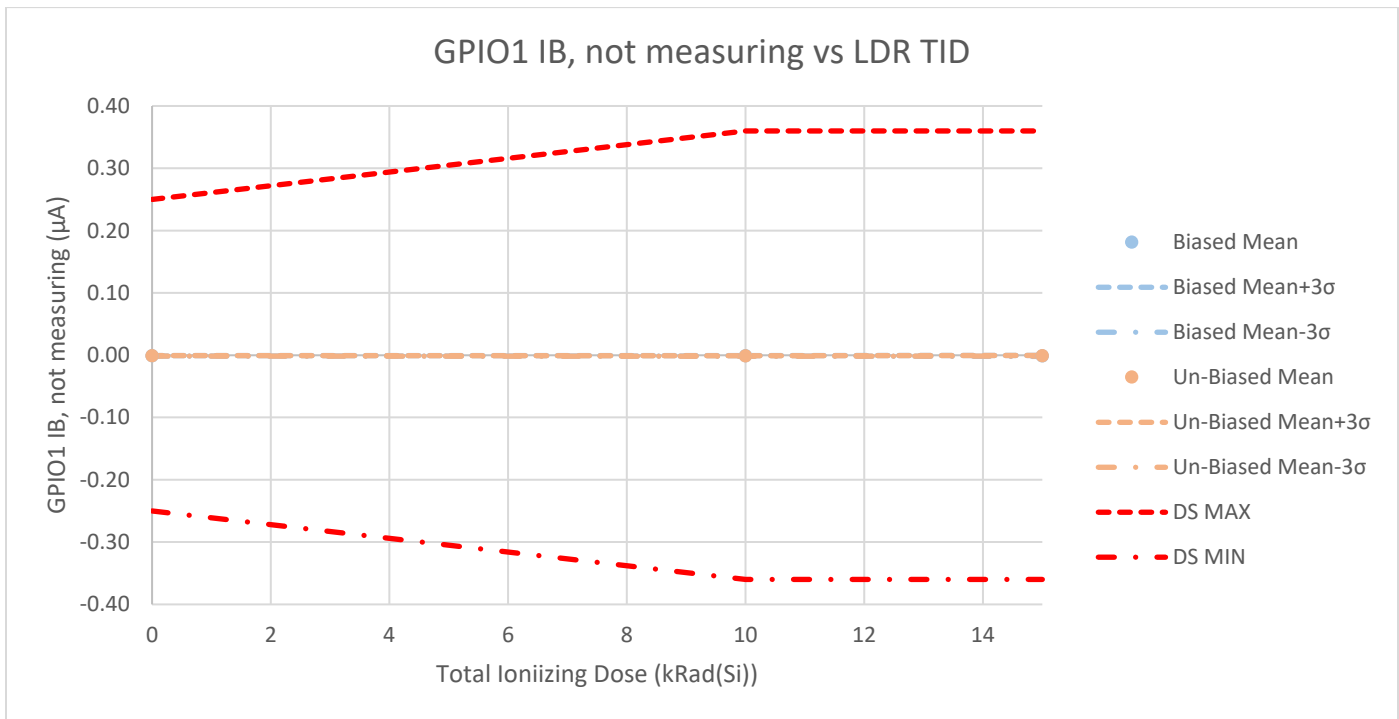

Table A-67-2. GPIO1 IB, not measuring vs. LDR TID for the RT6804HG-1.

Total Ionizing Dose (kRad(Si))	0	10	15	Units
LDR TID Biased				
Biased Mean	-0.0011	-0.0011	-0.0012	µA
Std Dev	0.0001	0.0001	0.0003	
Biased Mean+3σ	-0.0007	-0.0006	-0.0004	
Biased Mean-3σ	-0.0015	-0.0015	-0.0020	
LDR TID Un-Biased				
Un-Biased Mean	-0.0011	-0.0012	-0.0009	µA
Std Dev	0.0001	0.0001	0.0002	
Un-Biased Mean+3σ	-0.0006	-0.0008	-0.0002	
Un-Biased Mean-3σ	-0.0015	-0.0016	-0.0015	
DS MIN	-2.50E-01	-3.60E-01	-3.60E-01	µA
	PASS	PASS	PASS	
DS MAX	2.50E-01	3.60E-01	3.60E-01	µA
	PASS	PASS	PASS	

Figure A-68-1. GPIO2 IB, not measuring vs. HDR TID for the RT6804HG-1.

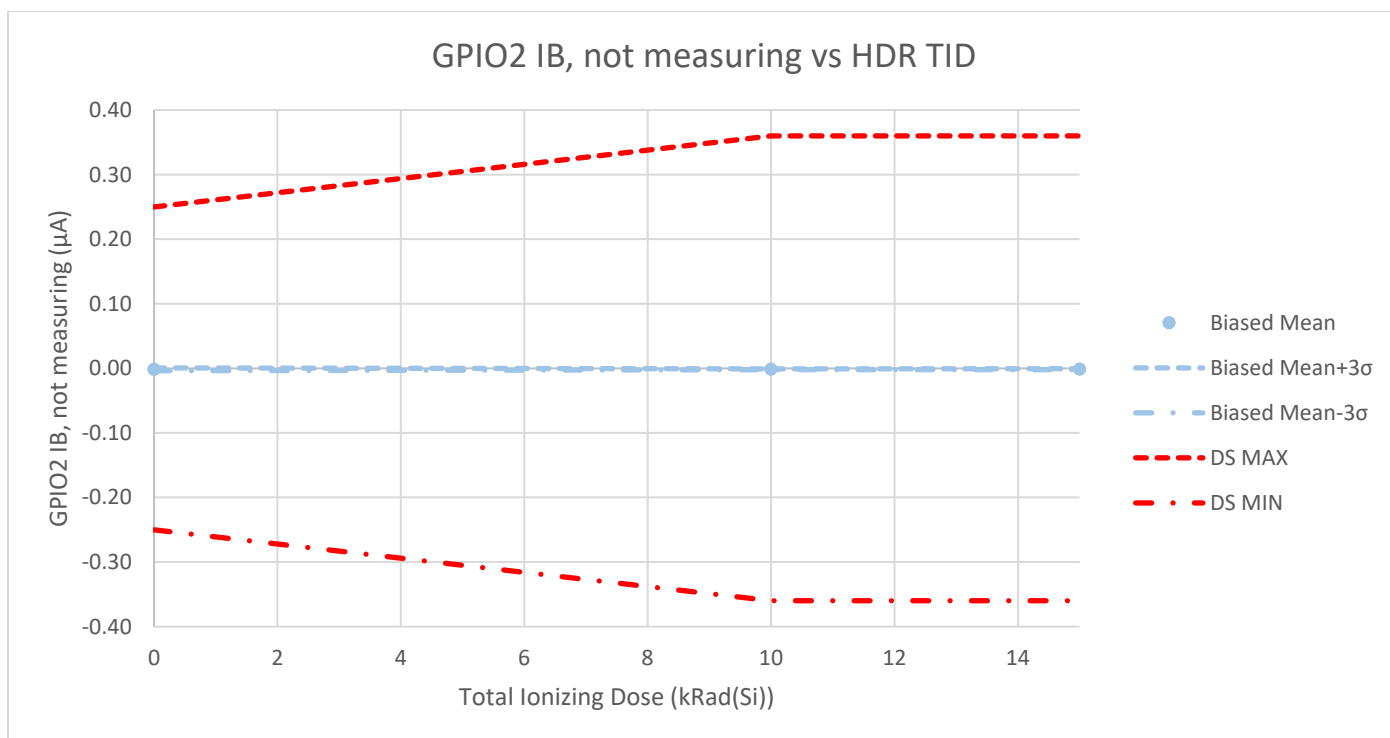

Table A-68-1. GPIO2 IB, not measuring vs. HDR TID for the RT6804HG-1.

HDR TID Biased				
Total Ionizing Dose (kRad(Si))	0	10	15	Units
Biased Mean	-0.0016	-0.0015	-0.0014	μA
Std Dev	0.0007	0.0002	0.0003	
Biased Mean+3σ	0.0006	-0.0009	-0.0006	
Biased Mean-3σ	-0.0038	-0.0021	-0.0022	
DS MIN	-2.50E-01	-3.60E-01	-3.60E-01	μA
	PASS	PASS	PASS	
DS MAX	2.50E-01	3.60E-01	3.60E-01	μA
	PASS	PASS	PASS	

Figure A-68-2. GPIO2 IB, not measuring vs. LDR TID for the RT6804HG-1.

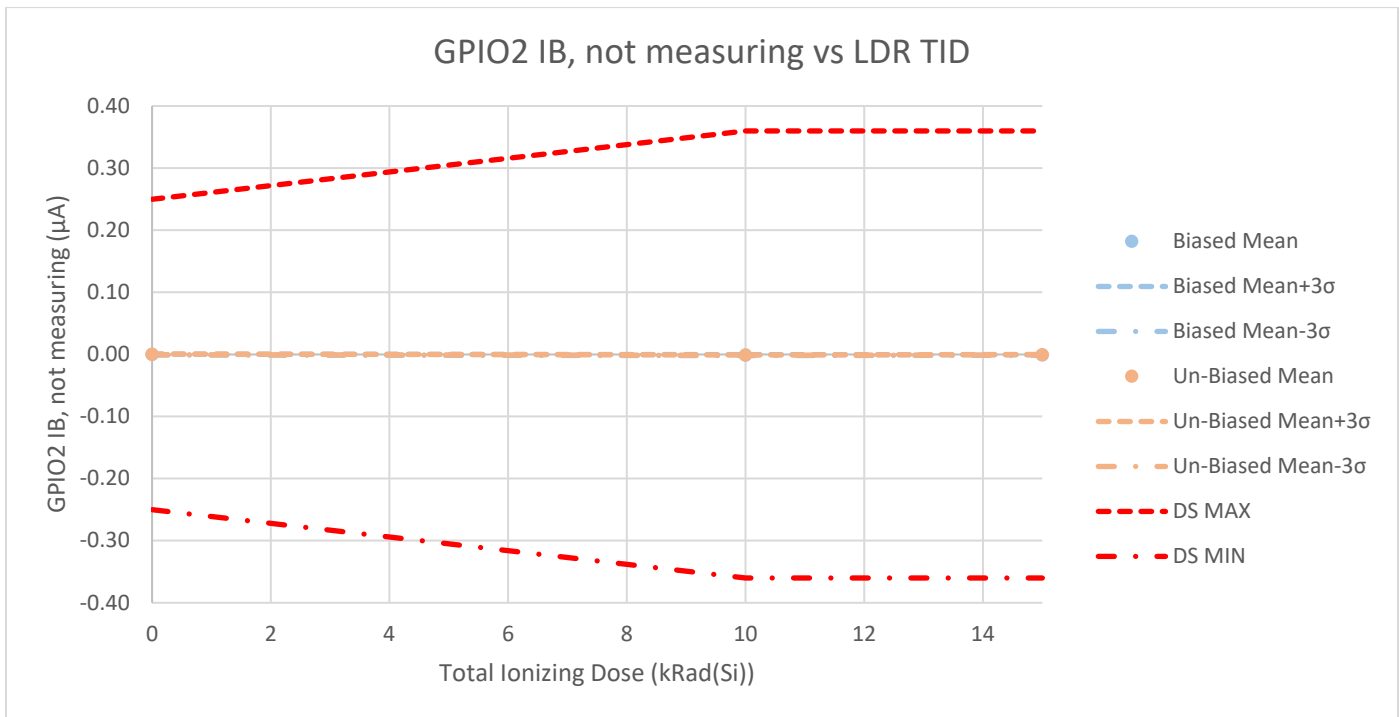

Table A-68-2. GPIO2 IB, not measuring vs. LDR TID for the RT6804HG-1.

Total Ionizing Dose (kRad(Si))	0	10	15	Units
LDR TID Biased				
Biased Mean	-0.0002	-0.0011	-0.0010	µA
Std Dev	0.0002	0.0002	0.0001	
Biased Mean+3σ	0.0003	-0.0004	-0.0007	
Biased Mean-3σ	-0.0008	-0.0019	-0.0013	
LDR TID Un-Biased				
Un-Biased Mean	0.0000	-0.0012	-0.0008	µA
Std Dev	0.0002	0.0001	0.0002	
Un-Biased Mean+3σ	0.0007	-0.0009	-0.0003	
Un-Biased Mean-3σ	-0.0007	-0.0014	-0.0013	
DS MIN	-2.50E-01	-3.60E-01	-3.60E-01	µA
	PASS	PASS	PASS	
DS MAX	2.50E-01	3.60E-01	3.60E-01	µA
	PASS	PASS	PASS	

Figure A-69-1. GPIO3 IB, not measuring vs. HDR TID for the RT6804HG-1.

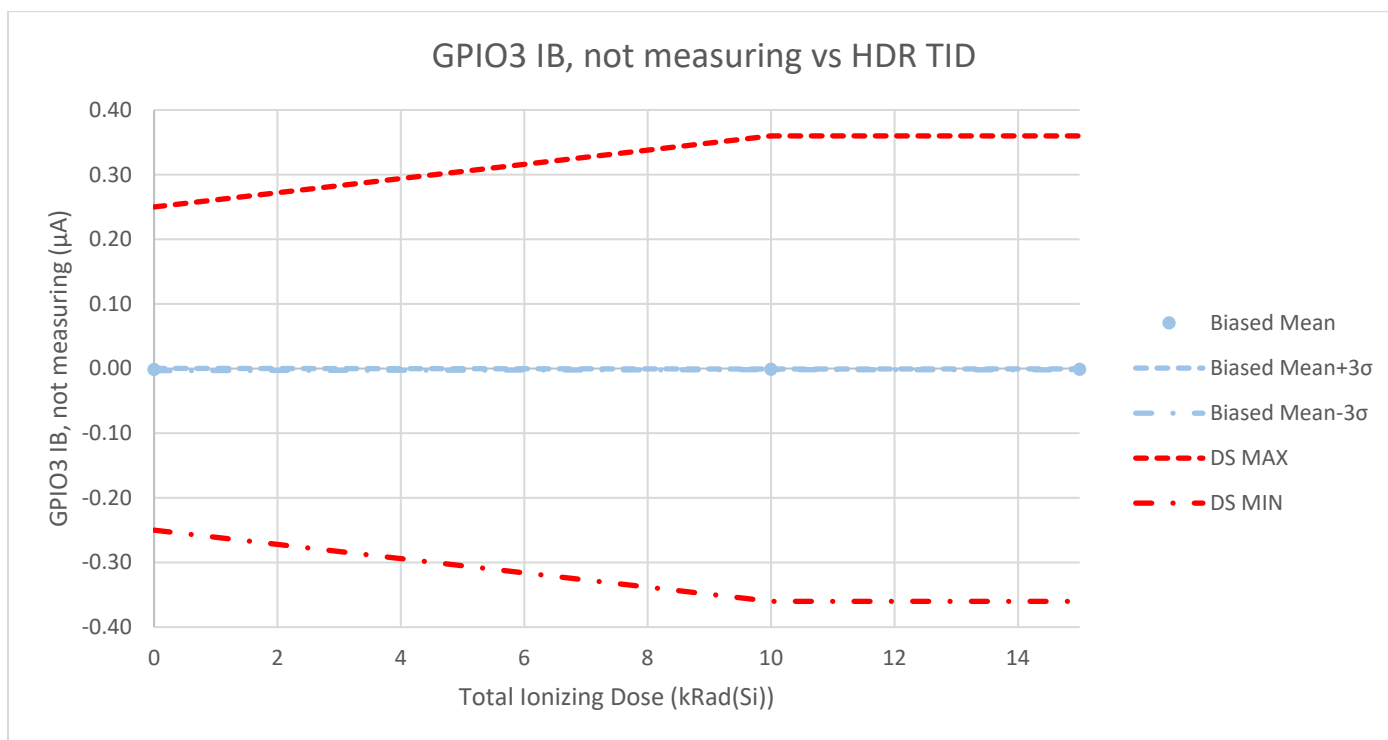

Table A-69-1. GPIO3 IB, not measuring vs. HDR TID for the RT6804HG-1.

HDR TID Biased				
Total Ionizing Dose (kRad(Si))	0	10	15	Units
Biased Mean	-0.0014	-0.0012	-0.0013	μA
Std Dev	0.0006	0.0002	0.0002	
Biased Mean+3σ	0.0003	-0.0007	-0.0006	
Biased Mean-3σ	-0.0031	-0.0018	-0.0020	
DS MIN	-2.50E-01	-3.60E-01	-3.60E-01	μA
	PASS	PASS	PASS	
DS MAX	2.50E-01	3.60E-01	3.60E-01	μA
	PASS	PASS	PASS	

Figure A-69-2. GPIO3 IB, not measuring vs. LDR TID for the RT6804HG-1.

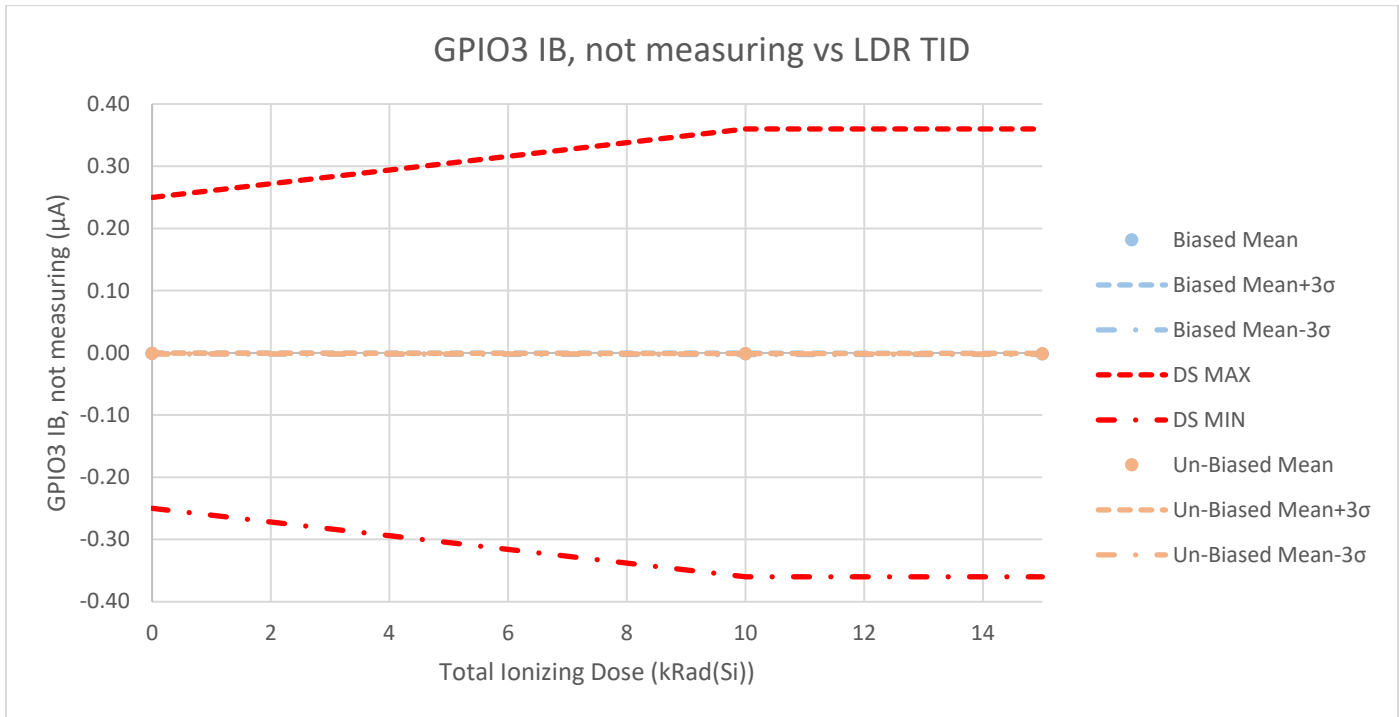

Table A-69-2. GPIO3 IB, not measuring vs. LDR TID for the RT6804HG-1.

Total Ionizing Dose (kRad(Si))	0	10	15	Units
LDR TID Biased				
Biased Mean	-0.0010	-0.0016	-0.0018	µA
Std Dev	0.0002	0.0004	0.0003	
Biased Mean+3σ	-0.0004	-0.0005	-0.0009	
Biased Mean-3σ	-0.0016	-0.0027	-0.0026	
LDR TID Un-Biased				
Un-Biased Mean	-0.0011	-0.0014	-0.0015	µA
Std Dev	0.0002	0.0001	0.0001	
Un-Biased Mean+3σ	-0.0004	-0.0012	-0.0011	
Un-Biased Mean-3σ	-0.0018	-0.0017	-0.0018	
DS MIN	-2.50E-01	-3.60E-01	-3.60E-01	µA
	PASS	PASS	PASS	
DS MAX	2.50E-01	3.60E-01	3.60E-01	µA
	PASS	PASS	PASS	

Figure A-70-1. GPIO4 IB, not measuring vs. HDR TID for the RT6804HG-1.

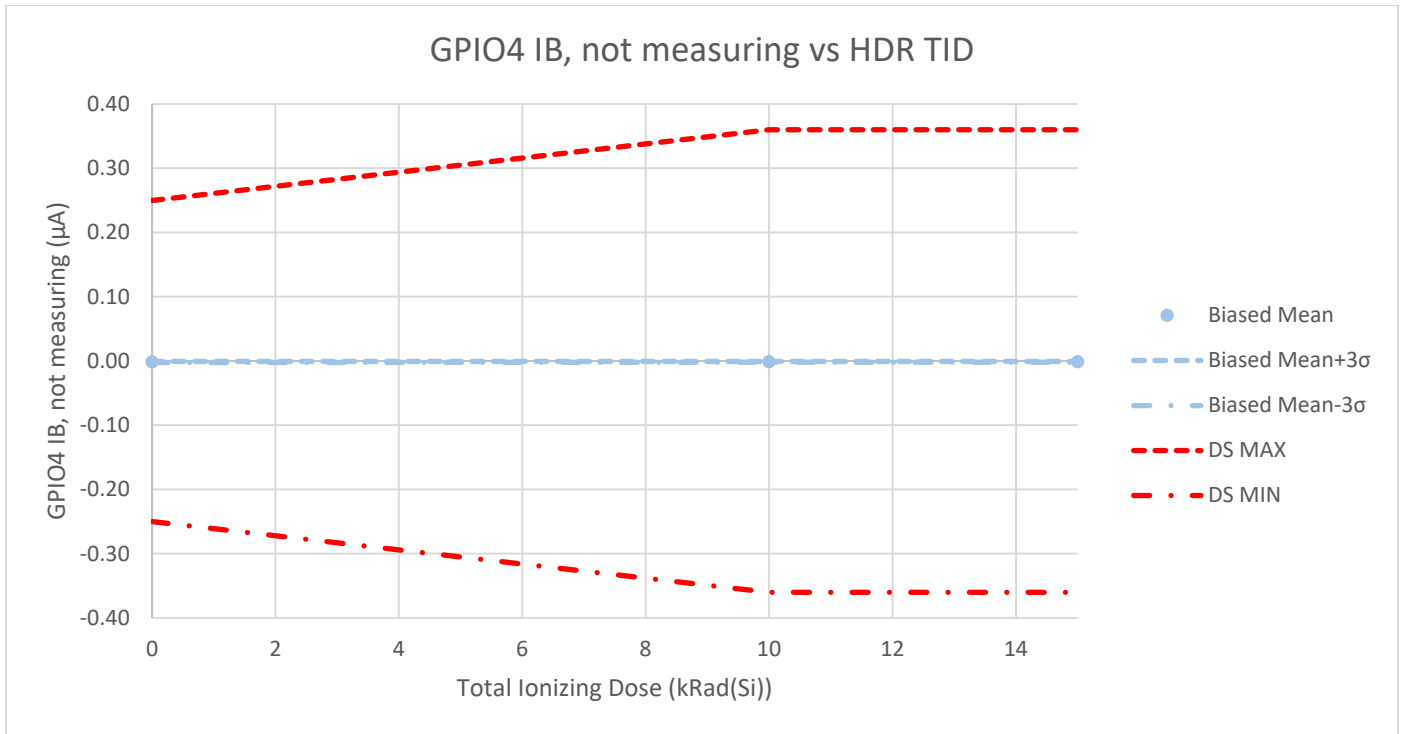

Table A-70-1. GPIO4 IB, not measuring vs. HDR TID for the RT6804HG-1.

HDR TID Biased				
Total Ionizing Dose (kRad(Si))	0	10	15	Units
Biased Mean	-0.0015	-0.0013	-0.0013	μA
Std Dev	0.0003	0.0002	0.0002	
Biased Mean+3σ	-0.0007	-0.0007	-0.0006	
Biased Mean-3σ	-0.0024	-0.0019	-0.0019	
DS MIN	-2.50E-01	-3.60E-01	-3.60E-01	μA
	PASS	PASS	PASS	
DS MAX	2.50E-01	3.60E-01	3.60E-01	μA
	PASS	PASS	PASS	

Figure A-70-2. GPIO4 IB, not measuring vs. LDR TID for the RT6804HG-1.

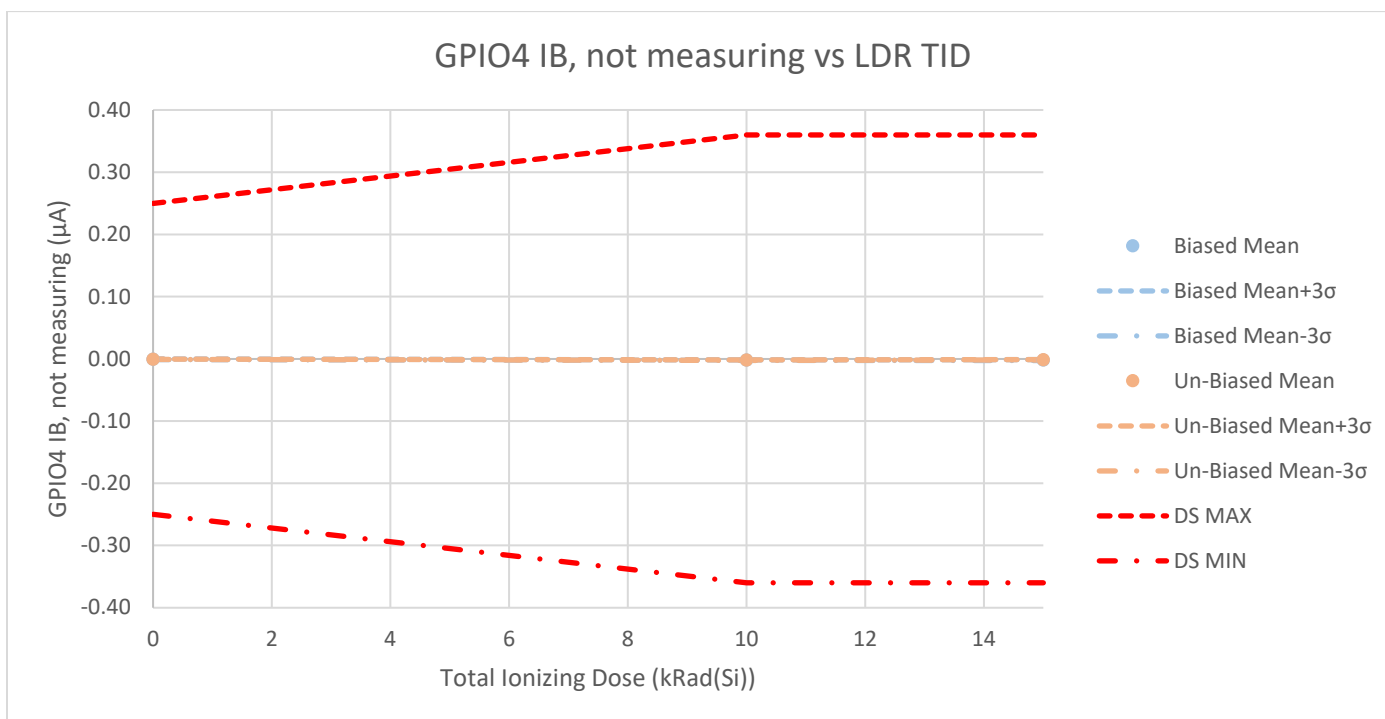

Table A-70-2. GPIO4 IB, not measuring vs. LDR TID for the RT6804HG-1.

Total Ionizing Dose (kRad(Si))	0	10	15	Units
LDR TID Biased				
Biased Mean	-0.0007	-0.0021	-0.0019	µA
Std Dev	0.0002	0.0001	0.0002	
Biased Mean+3σ	-0.0002	-0.0017	-0.0012	
Biased Mean-3σ	-0.0012	-0.0024	-0.0026	
LDR TID Un-Biased				
Un-Biased Mean	-0.0007	-0.0019	-0.0016	µA
Std Dev	0.0001	0.0001	0.0001	
Un-Biased Mean+3σ	-0.0005	-0.0016	-0.0014	
Un-Biased Mean-3σ	-0.0009	-0.0023	-0.0018	
DS MIN	-2.50E-01	-3.60E-01	-3.60E-01	µA
	PASS	PASS	PASS	
DS MAX	2.50E-01	3.60E-01	3.60E-01	µA
	PASS	PASS	PASS	

Figure A-71-1. GPIO5 IB, not measuring vs. HDR TID for the RT6804HG-1.

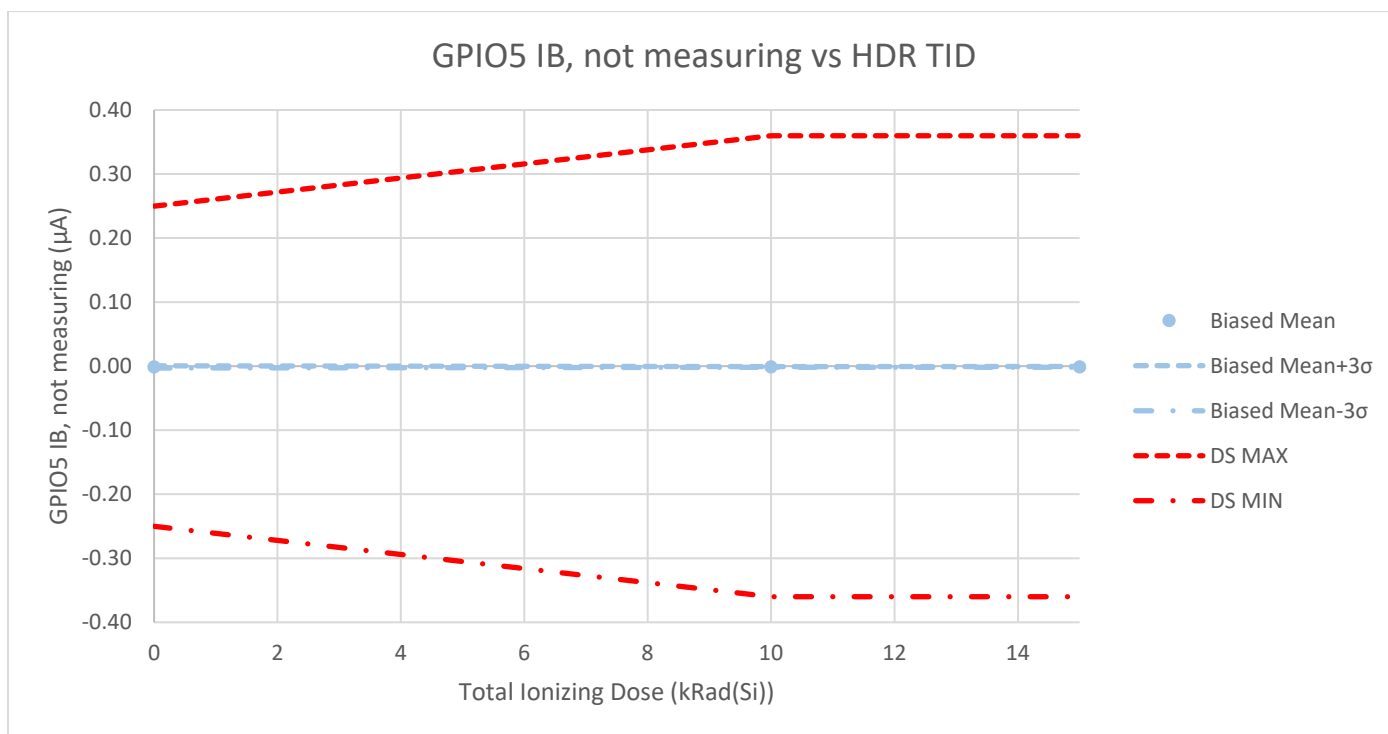

Table A-71-1. GPIO5 IB, not measuring vs. HDR TID for the RT6804HG-1.

HDR TID Biased				
Total Ionizing Dose (kRad(Si))	0	10	15	Units
Biased Mean	-0.0012	-0.0012	-0.0012	µA
Std Dev	0.0006	0.0002	0.0002	
Biased Mean+3σ	0.0006	-0.0007	-0.0005	
Biased Mean-3σ	-0.0029	-0.0017	-0.0019	
DS MIN	-2.50E-01	-3.60E-01	-3.60E-01	µA
	PASS	PASS	PASS	
DS MAX	2.50E-01	3.60E-01	3.60E-01	µA
	PASS	PASS	PASS	

Figure A-71-2. GPIO5 IB, not measuring vs. LDR TID for the RT6804HG-1.

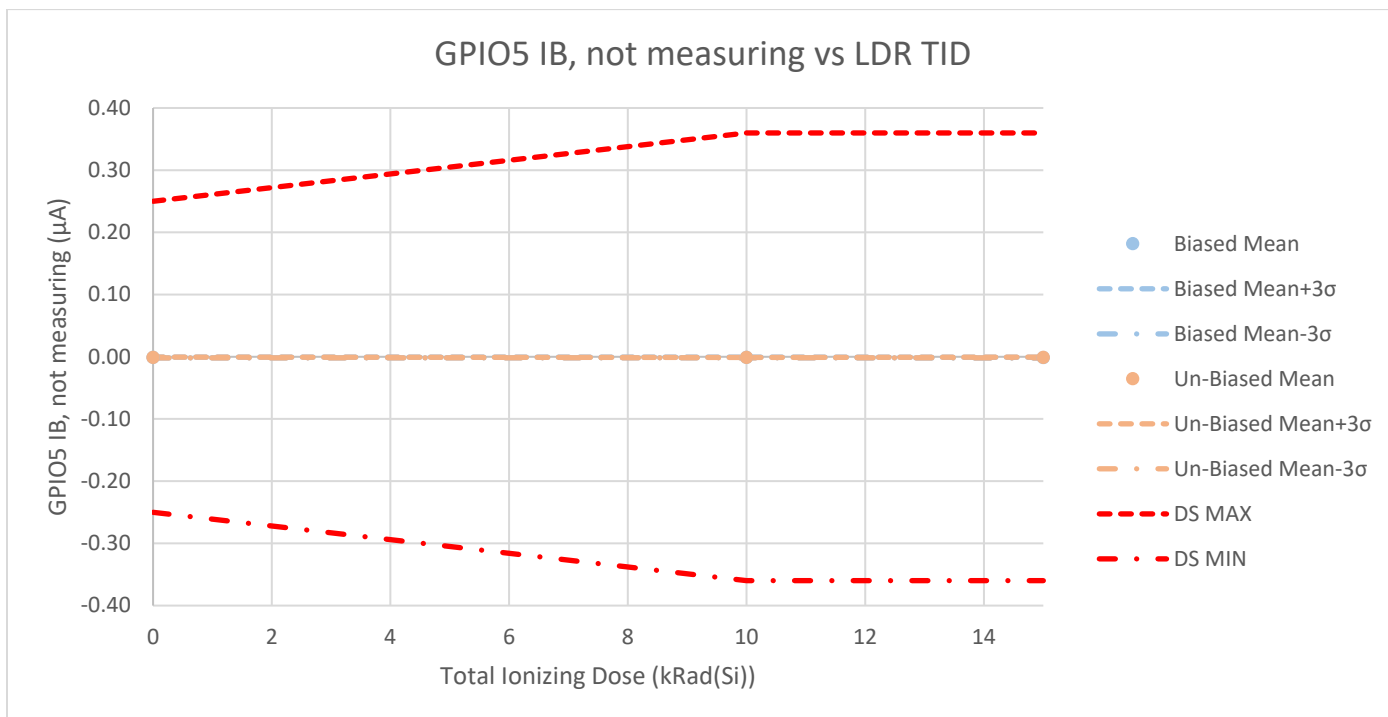

Table A-71-2. GPIO5 IB, not measuring vs. LDR TID for the RT6804HG-1.

Total Ionizing Dose (kRad(Si))	0	10	15	Units
LDR TID Biased				
Biased Mean	-0.0011	-0.0012	-0.0013	µA
Std Dev	0.0002	0.0002	0.0002	
Biased Mean+3σ	-0.0005	-0.0007	-0.0008	
Biased Mean-3σ	-0.0017	-0.0017	-0.0019	
LDR TID Un-Biased				
Un-Biased Mean	-0.0012	-0.0013	-0.0012	µA
Std Dev	0.0002	0.0001	0.0002	
Un-Biased Mean+3σ	-0.0006	-0.0009	-0.0005	
Un-Biased Mean-3σ	-0.0019	-0.0016	-0.0019	
DS MIN	-2.50E-01	-3.60E-01	-3.60E-01	µA
	PASS	PASS	PASS	
DS MAX	2.50E-01	3.60E-01	3.60E-01	µA
	PASS	PASS	PASS	

Figure A-72-1. Primary Reference, VREF1, VREG=5V vs. HDR TID for the RT6804HG-1.

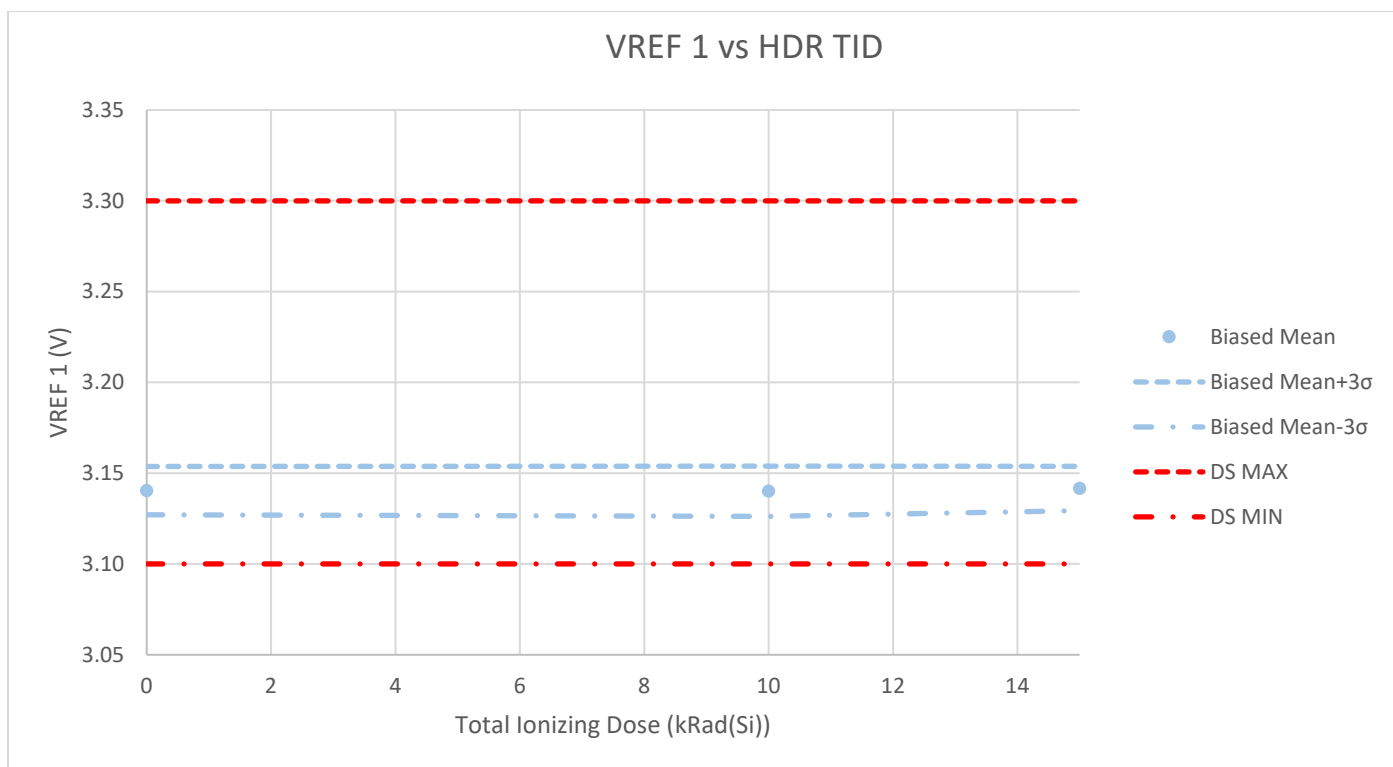

Table A-72-1. Primary Reference, VREF1, VREG=5V vs. HDR TID for the RT6804HG-1.

HDR TID Biased				
Total Ionizing Dose (kRad(Si))	0	10	15	Units
Biased Mean	3.1404	3.1401	3.1416	V
Std Dev	0.0044	0.0046	0.0041	
Biased Mean+3σ	3.1537	3.1539	3.1537	
Biased Mean-3σ	3.1270	3.1262	3.1294	
DS MIN	3.10E+00	3.10E+00	3.10E+00	V
	PASS	PASS	PASS	
DS MAX	3.30E+00	3.30E+00	3.30E+00	V
	PASS	PASS	PASS	

Figure A-72-2. Primary Reference, VREF1, VREG=5V vs. LDR TID for the RT6804HG-1.

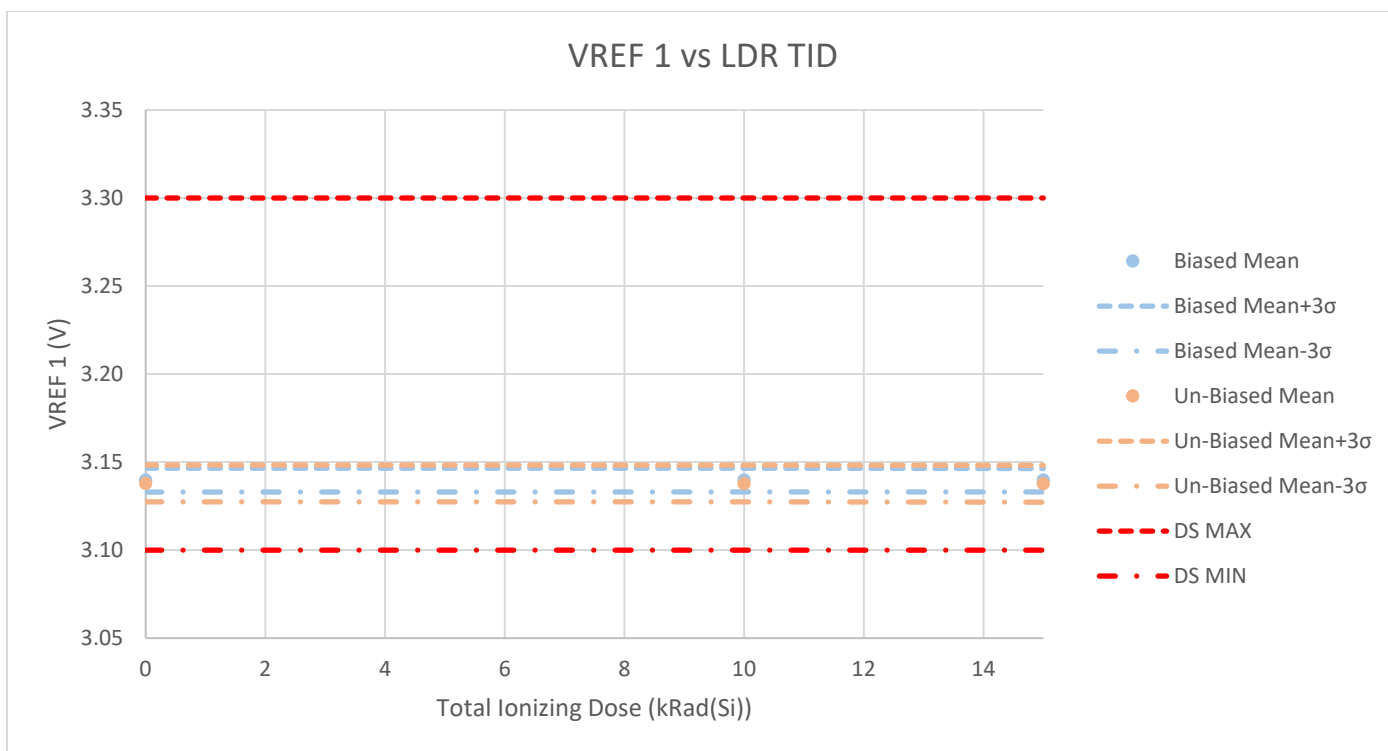

Table A-72-2. Primary Reference, VREF1, VREG=5V vs. LDR TID for the RT6804HG-1.

Total Ionizing Dose (kRad(Si))	0	10	15	Units
LDR TID Biased				
Biased Mean	3.1398	3.1397	3.1397	V
Std Dev	0.0023	0.0022	0.0022	
Biased Mean+3σ	3.1465	3.1465	3.1463	
Biased Mean-3σ	3.1330	3.1330	3.1330	
LDR TID Un-Biased				
Un-Biased Mean	3.1378	3.1378	3.1377	V
Std Dev	0.0035	0.0035	0.0035	
Un-Biased Mean+3σ	3.1483	3.1482	3.1482	
Un-Biased Mean-3σ	3.1274	3.1274	3.1273	
DS MIN	3.10E+00	3.10E+00	3.10E+00	V
	PASS	PASS	PASS	
DS MAX	3.30E+00	3.30E+00	3.30E+00	V
	PASS	PASS	PASS	

Figure A-73-1. Primary Reference, VREF2, VREG=5V vs. HDR TID for the RT6804HG-1.

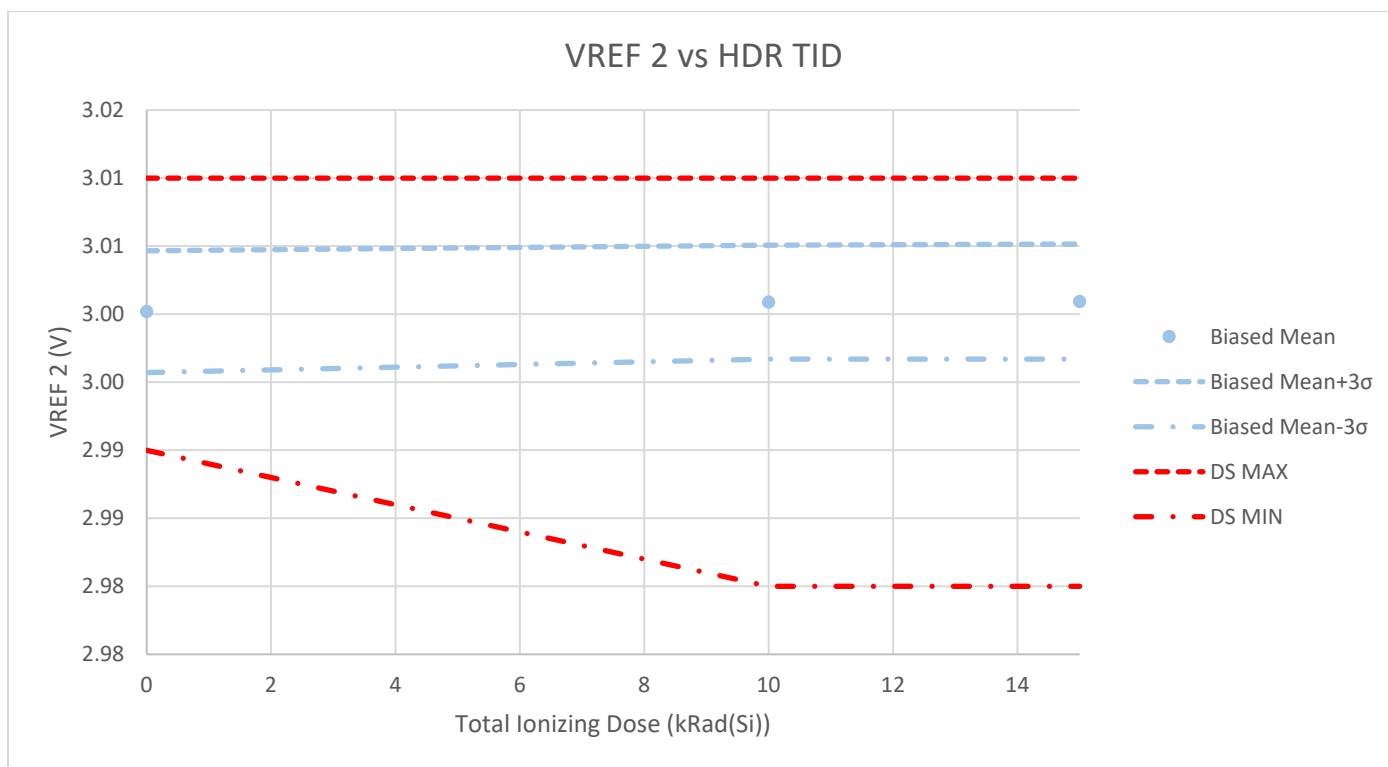

Table A-73-1. Primary Reference, VREF2, VREG=5V vs. HDR TID for the RT6804HG-1.

HDR TID Biased				
Total Ionizing Dose (kRad(Si))	0	10	15	Units
Biased Mean	3.0002	3.0009	3.0009	V
Std Dev	0.0015	0.0014	0.0014	
Biased Mean+3σ	3.0047	3.0051	3.0052	
Biased Mean-3σ	2.9957	2.9967	2.9967	
DS MIN	2.99E+00	2.98E+00	2.98E+00	V
	PASS	PASS	PASS	
DS MAX	3.01E+00	3.01E+00	3.01E+00	V
	PASS	PASS	PASS	

Figure A-73-2. Primary Reference, VREF2, VREG=5V vs. LDR TID for the RT6804HG-1.

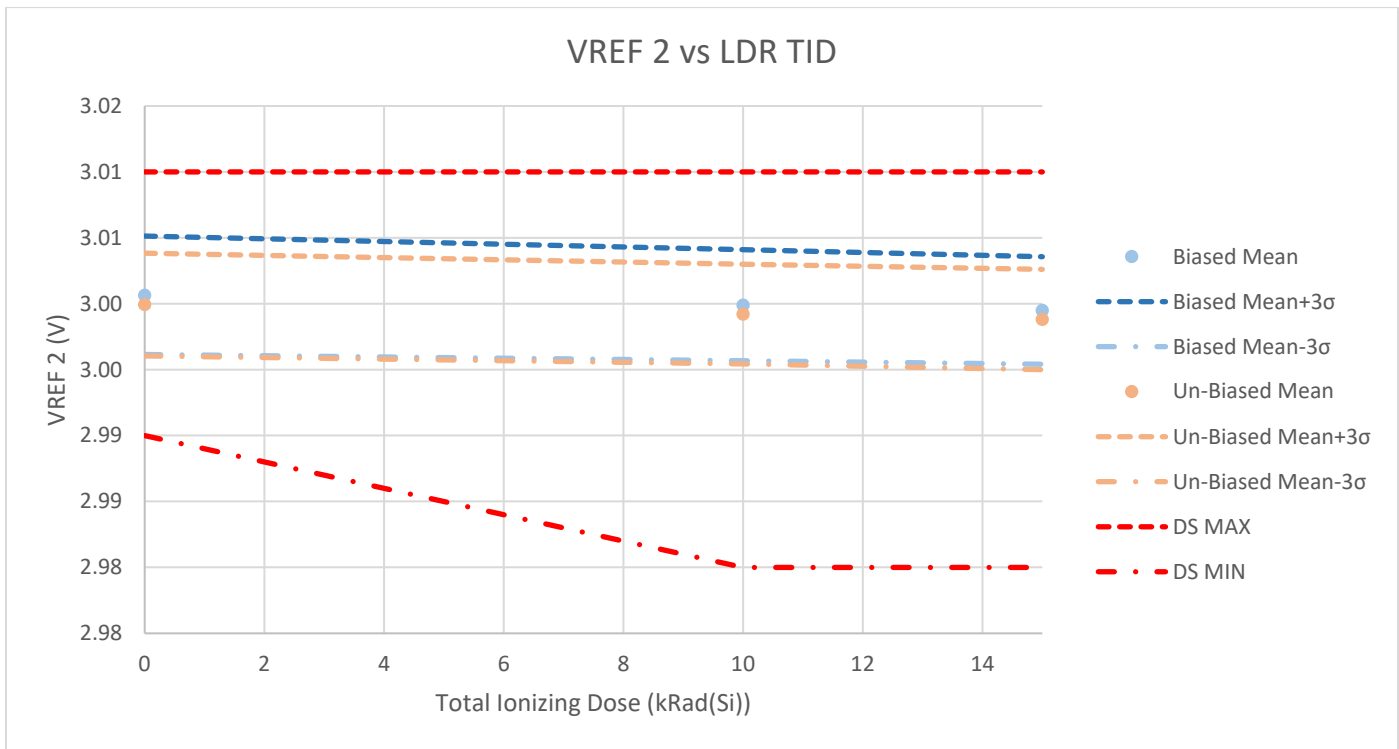

Table A-73-2. Primary Reference, VREF2, VREG=5V vs. LDR TID for the RT6804HG-1.

Total Ionizing Dose (kRad(Si))	0	10	15	Units
LDR TID Biased				
Biased Mean	3.0006	2.9999	2.9995	V
Std Dev	0.0015	0.0014	0.0014	
Biased Mean+3σ	3.0051	3.0041	3.0036	
Biased Mean-3σ	2.9961	2.9957	2.9954	
LDR TID Un-Biased				
Un-Biased Mean	2.9999	2.9992	2.9988	V
Std Dev	0.0013	0.0013	0.0013	
Un-Biased Mean+3σ	3.0038	3.0030	3.0026	
Un-Biased Mean-3σ	2.9960	2.9954	2.9950	
DS MIN	2.99E+00	2.98E+00	2.98E+00	V
	PASS	PASS	PASS	
DS MAX	3.01E+00	3.01E+00	3.01E+00	V
	PASS	PASS	PASS	

Figure A-74-1. Isy, V+, Sleep State @ Vs=39.6V, VREG=0V vs. HDR TID for the RT6804HG-1.

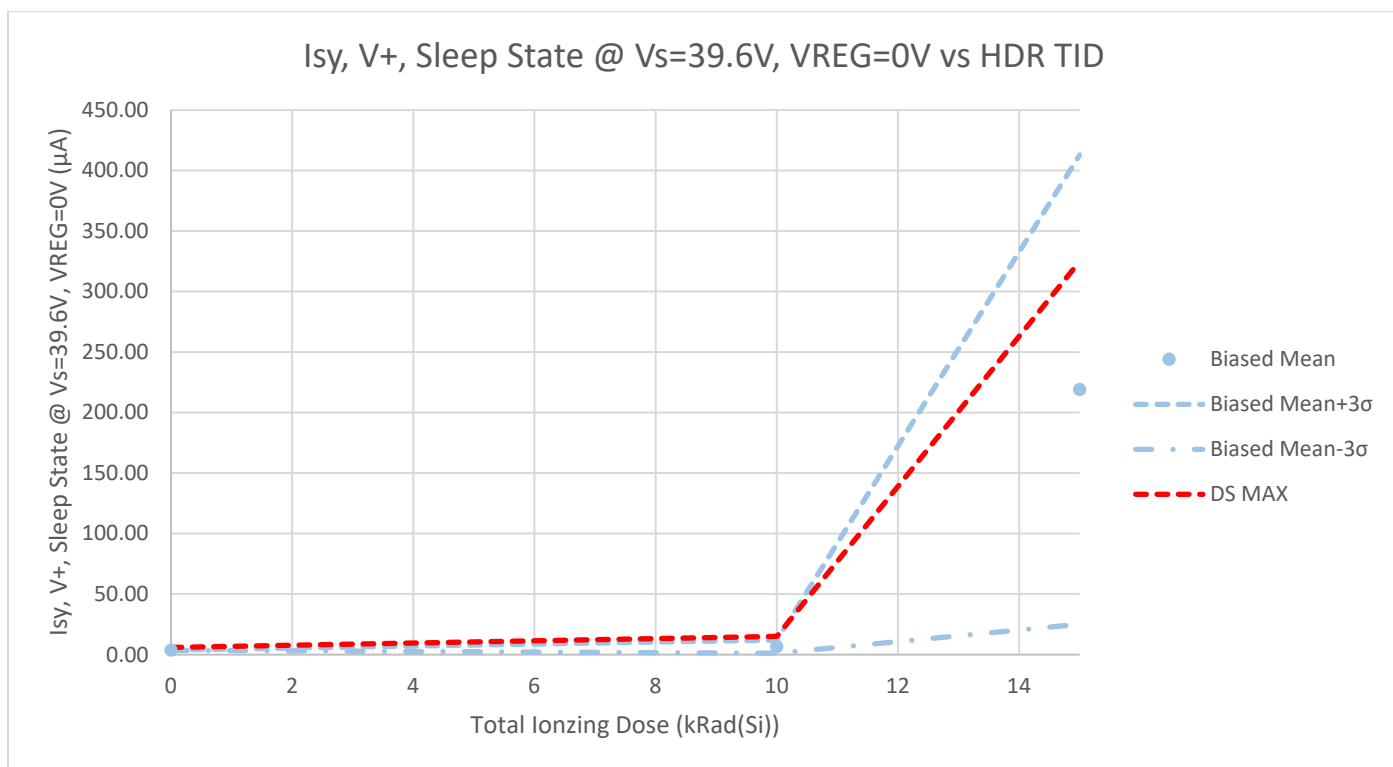

Table A-74-1. Isy, V+, Sleep State @ Vs=39.6V, VREG=0V vs. HDR TID for the RT6804HG-1.

HDR TID Biased				
Total Ionizing Dose (kRad(Si))	0	10	15	Units
Biased Mean	3.6916	6.5757	218.9968	µA
Std Dev	0.0605	1.7997	64.6388	
Biased Mean+3σ	3.8732	11.9748	412.9133	
Biased Mean-3σ	3.5100	1.1767	25.0803	
DS MIN	PASS	PASS	PASS	
DS MAX	6.00E+00	1.50E+01	3.25E+02	µA
	PASS	PASS	PASS	

Figure A-74-2. Isy, V+, Sleep State @ Vs=39.6V, VREG=0V vs. LDR TID for the RT6804HG-1.

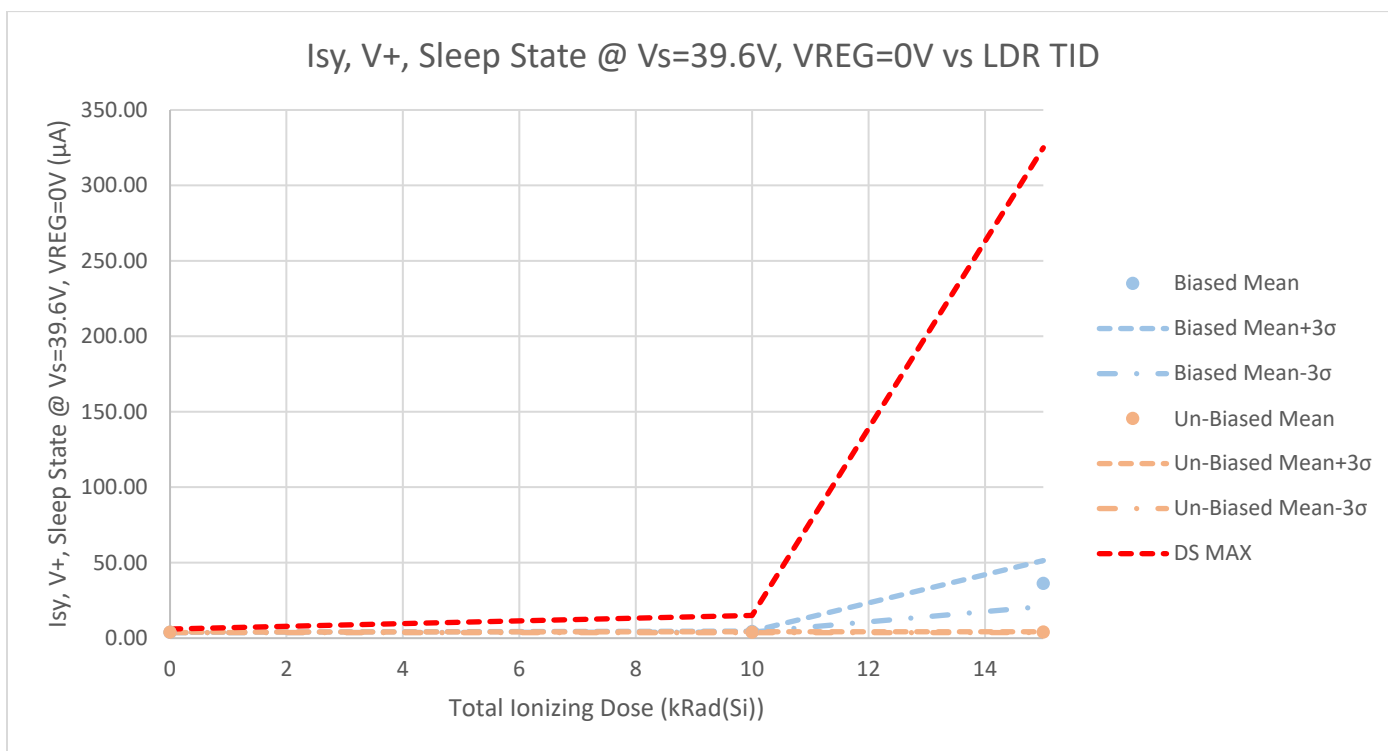

Table A-74-2. Isy, V+, Sleep State @ Vs=39.6V, VREG=0V vs. LDR TID for the RT6804HG-1.

Total Ionizing Dose (kRad(Si))	0	10	15	Units
LDR TID Biased				
Biased Mean	3.7468	4.2662	36.2073	µA
Std Dev	0.0538	0.1032	5.0692	
Biased Mean+3σ	3.9081	4.5758	51.4149	
Biased Mean-3σ	3.5856	3.9567	20.9997	
LDR TID Un-Biased				
Un-Biased Mean	3.7955	3.8649	3.9110	µA
Std Dev	0.0671	0.1089	0.0795	
Un-Biased Mean+3σ	3.9967	4.1916	4.1494	
Un-Biased Mean-3σ	3.5944	3.5382	3.6725	
DS MIN				
	PASS	PASS	PASS	
DS MAX				
	6.00E+00	1.50E+01	3.25E+02	µA
	PASS	PASS	PASS	

Figure A-75-1. Isy, V+, Sleep State @ Vs=39.6V vs. HDR TID for the RT6804HG-1.

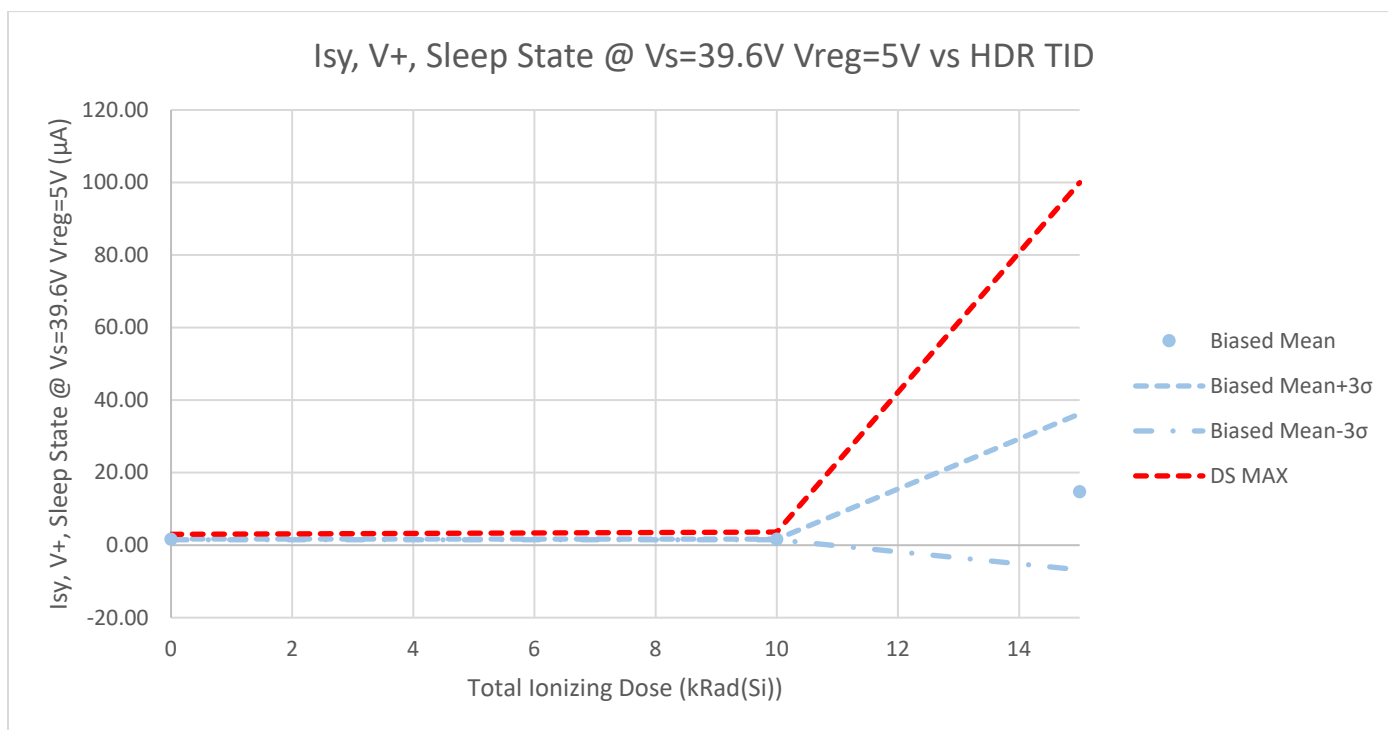

Table A-75-1. Isy, V+, Sleep State @ Vs=39.6V vs. HDR TID for the RT6804HG-1.

HDR TID Biased				
Total Ionizing Dose (kRad(Si))	0	10	15	Units
Biased Mean	1.5952	1.5954	14.6997	µA
Std Dev	0.0351	0.0317	7.1668	
Biased Mean+3σ	1.7006	1.6905	36.2000	
Biased Mean-3σ	1.4898	1.5003	-6.8005	
DS MIN				
	PASS	PASS	PASS	
DS MAX				
	3.00E+00	3.60E+00	1.00E+02	µA
	PASS	PASS	PASS	

Figure A-75-2. Isy, V+, Sleep State @ Vs=39.6V vs. LDR TID for the RT6804HG-1.

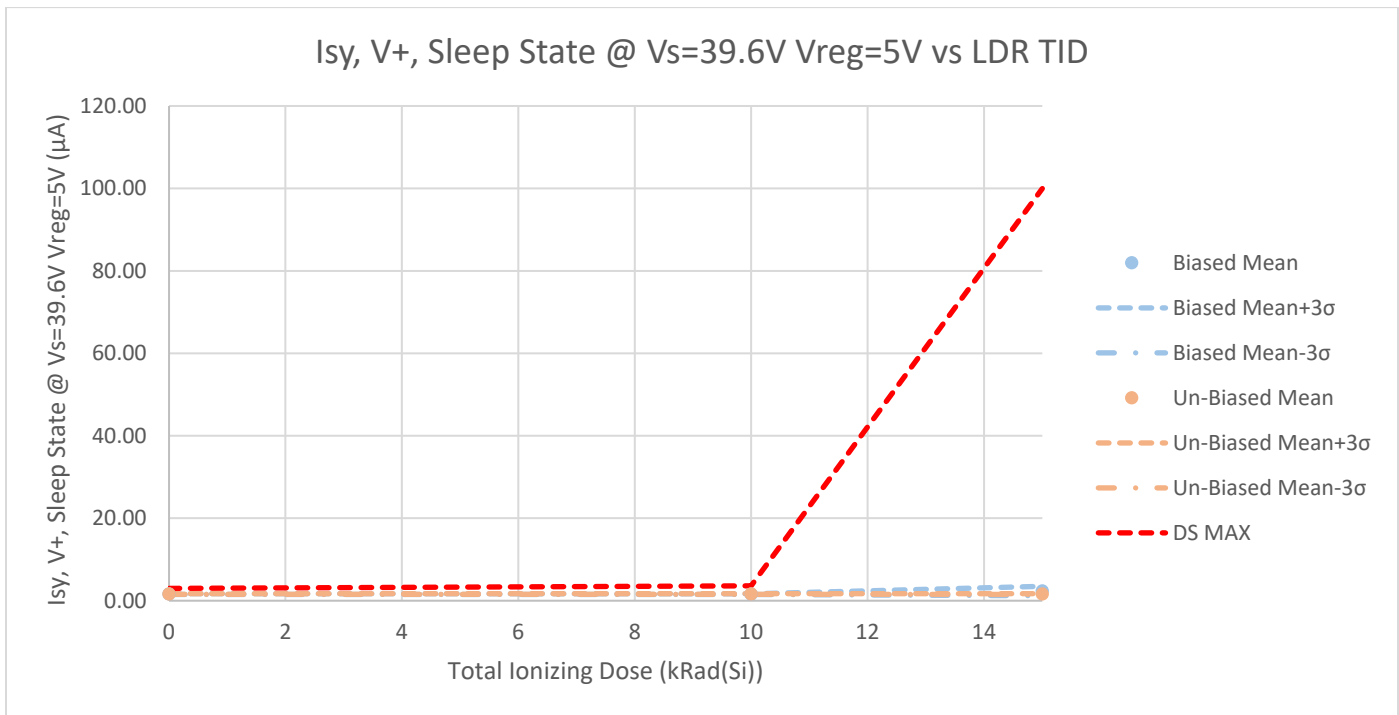

Table A-75-2. Isy, V+, Sleep State @ Vs=39.6V vs. LDR TID for the RT6804HG-1.

Total Ionizing Dose (kRad(Si))	0	10	15	Units
LDR TID Biased				
Biased Mean	1.6046	1.5968	2.3699	µA
Std Dev	0.0270	0.0267	0.3818	
Biased Mean+3σ	1.6856	1.6770	3.5154	
Biased Mean-3σ	1.5236	1.5166	1.2245	
LDR TID Un-Biased				
Un-Biased Mean	1.6333	1.6233	1.6200	µA
Std Dev	0.0294	0.0298	0.0312	
Un-Biased Mean+3σ	1.7215	1.7127	1.7135	
Un-Biased Mean-3σ	1.5450	1.5338	1.5265	
DS MIN				
	PASS	PASS	PASS	
DS MAX				
	3.00E+00	3.60E+00	1.00E+02	µA
	PASS	PASS	PASS	

Figure A-76-1. Isy, V+, Standby State @ Vs=39.6V vs. HDR TID for the RT6804HG-1.

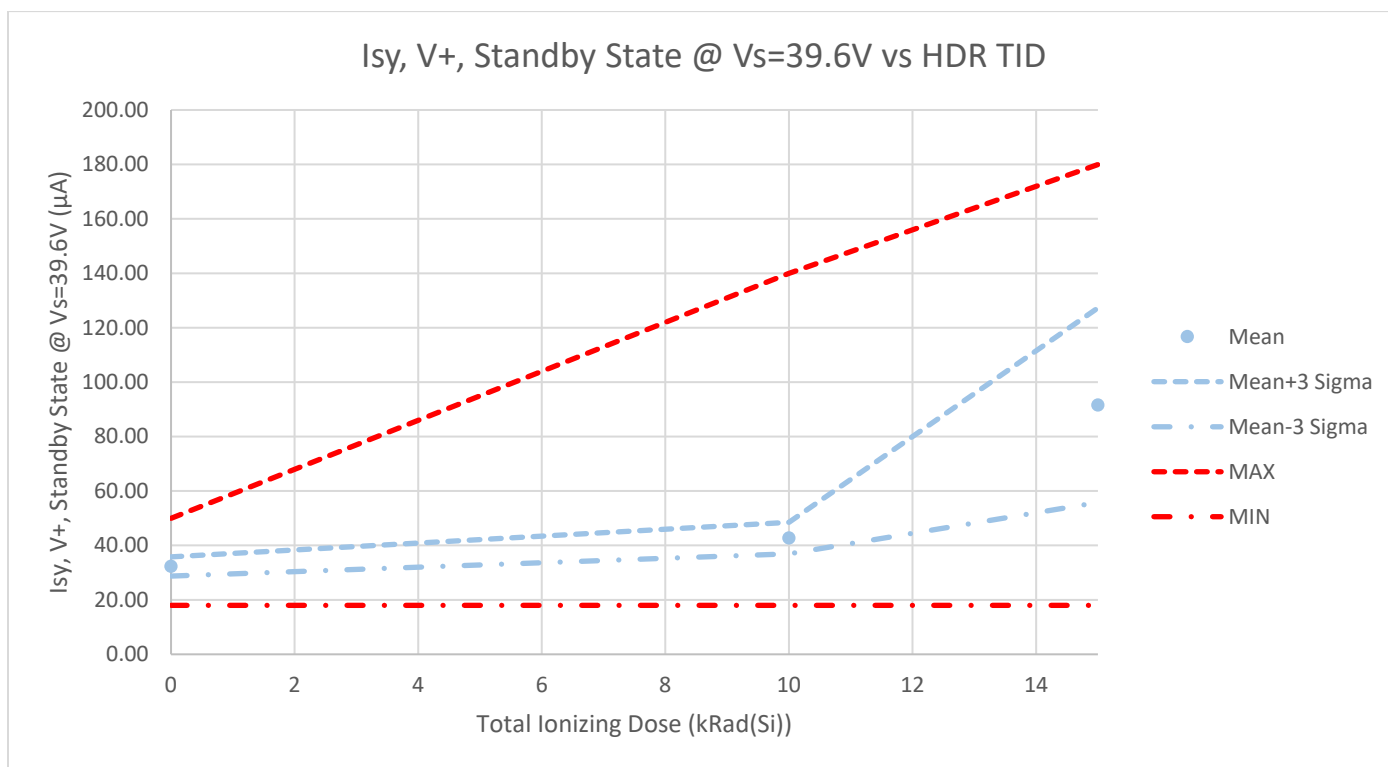

Table A-76-1. Isy, V+, Standby State @ Vs=39.6V vs. HDR TID for the RT6804HG-1.

HDR TID Biased				
Total Ionizing Dose (kRad(Si))	0	10	15	Units
Biased Mean	32.2972	42.7185	91.5655	µA
Std Dev	1.1835	1.9297	11.9110	
Biased Mean+3σ	35.8475	48.5074	127.2986	
Biased Mean-3σ	28.7468	36.9295	55.8324	
DS MIN	1.80E+01	1.80E+01	1.80E+01	µA
	PASS	PASS	PASS	
DS MAX	5.00E+01	1.40E+02	1.80E+02	µA
	PASS	PASS	PASS	

Figure A-76-2. Isy, V+, Standby State @ Vs=39.6V vs. LDR TID for the RT6804HG-1.

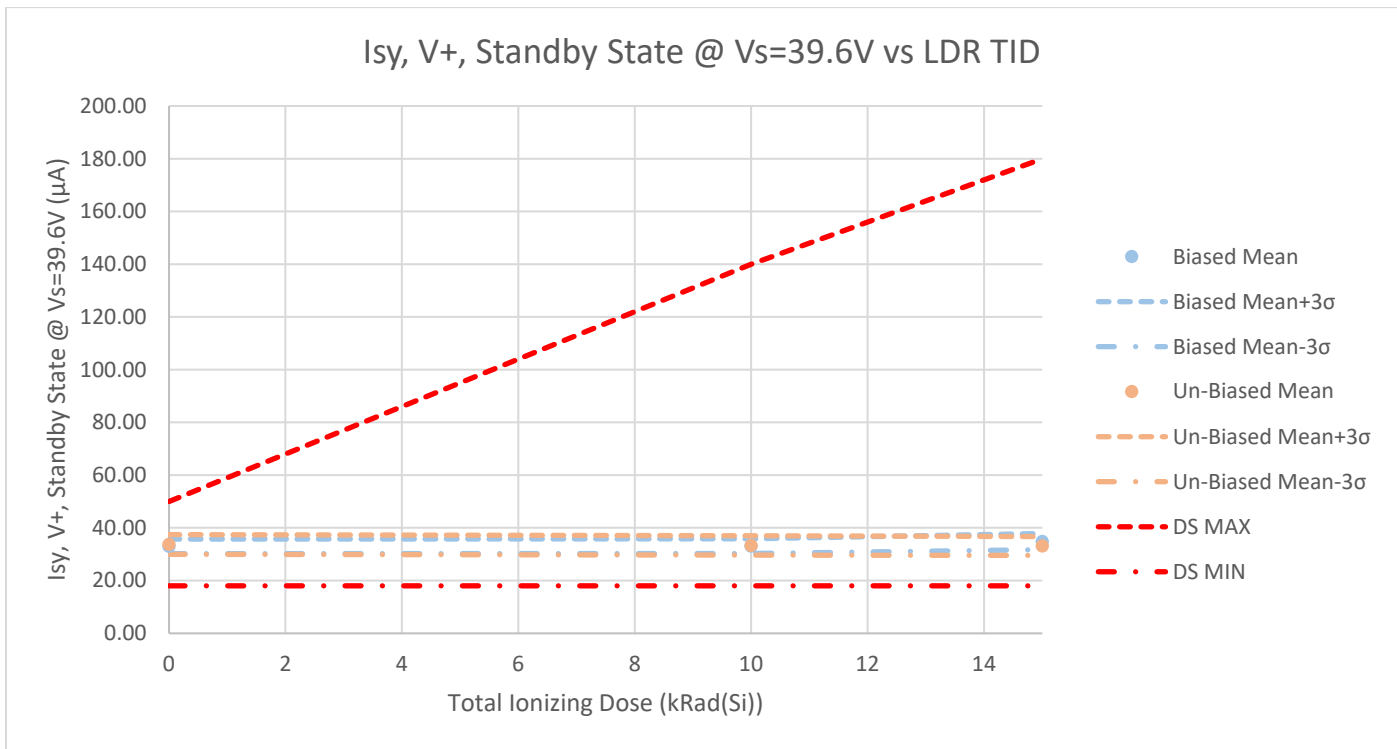

Table A-76-2. Isy, V+, Standby State @ Vs=39.6V vs. LDR TID for the RT6804HG-1.

Total Ionizing Dose (kRad(Si))	0	10	15	Units
LDR TID Biased				
Biased Mean	32.9414	33.0456	34.7743	µA
Std Dev	0.9199	0.9287	1.0167	
Biased Mean+3σ	35.7012	35.8315	37.8244	
Biased Mean-3σ	30.1815	30.2596	31.7242	
LDR TID Un-Biased				
Un-Biased Mean	33.6786	33.2959	33.1147	µA
Std Dev	1.2457	1.2290	1.2029	
Un-Biased Mean+3σ	37.4156	36.9828	36.7235	
Un-Biased Mean-3σ	29.9416	29.6091	29.5060	
DS MIN	1.80E+01	1.80E+01	1.80E+01	µA
	PASS	PASS	PASS	
DS MAX	5.00E+01	1.40E+02	1.80E+02	µA
	PASS	PASS	PASS	

Figure A-77-1. Isy, V+, Ready State @ Vs=39.6V vs. HDR TID for the RT6804HG-1.

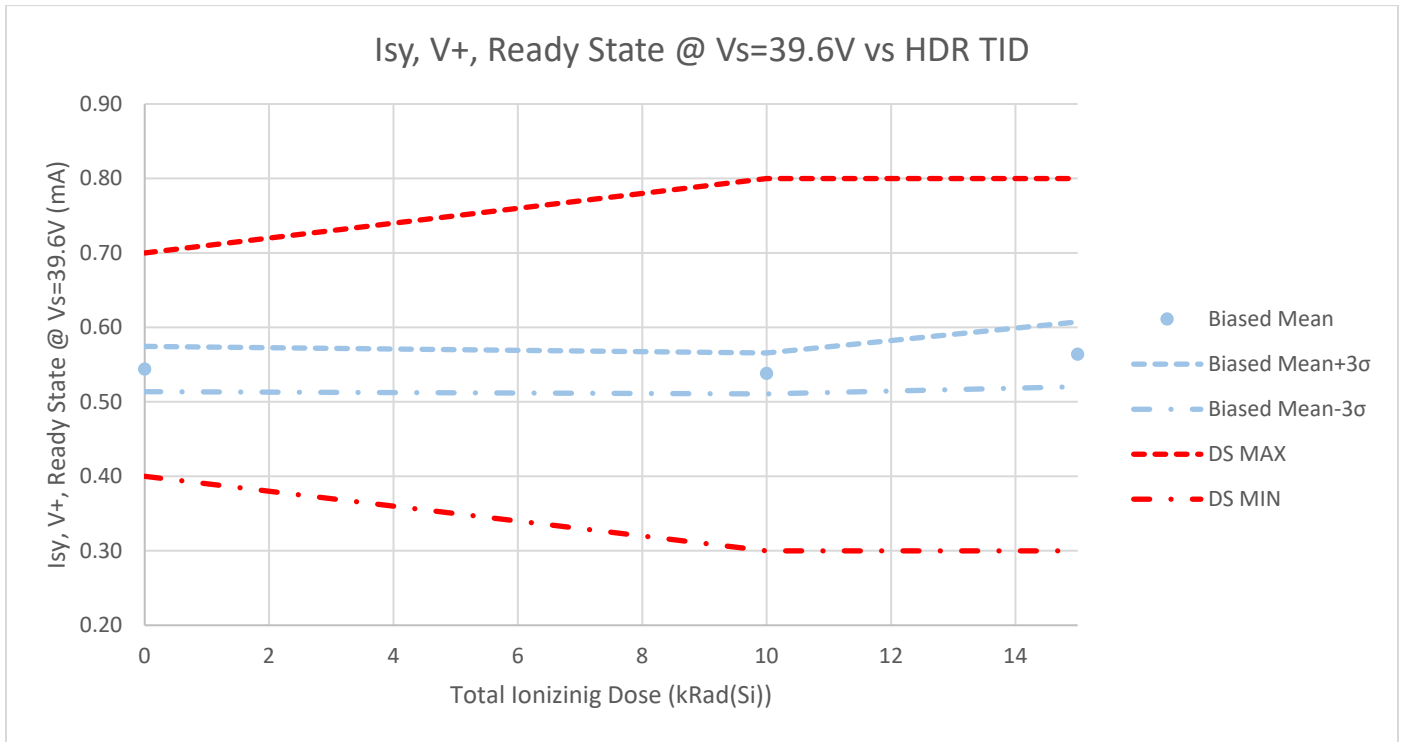

Table A-77-1. Isy, V+, Ready State @ Vs=39.6V vs. HDR TID for the RT6804HG-1.

HDR TID Biased				
Total Ionizing Dose (kRad(Si))	0	10	15	Units
Biased Mean	0.5440	0.5382	0.5639	mA
Std Dev	0.0101	0.0092	0.0145	
Biased Mean+3σ	0.5744	0.5657	0.6074	
Biased Mean-3σ	0.5137	0.5108	0.5203	
DS MIN	4.00E-01	3.00E-01	3.00E-01	mA
	PASS	PASS	PASS	
DS MAX	7.00E-01	8.00E-01	8.00E-01	mA
	PASS	PASS	PASS	

Figure A-77-2. Isy, V+, Ready State @ Vs=39.6V vs. LDR TID for the RT6804HG-1.

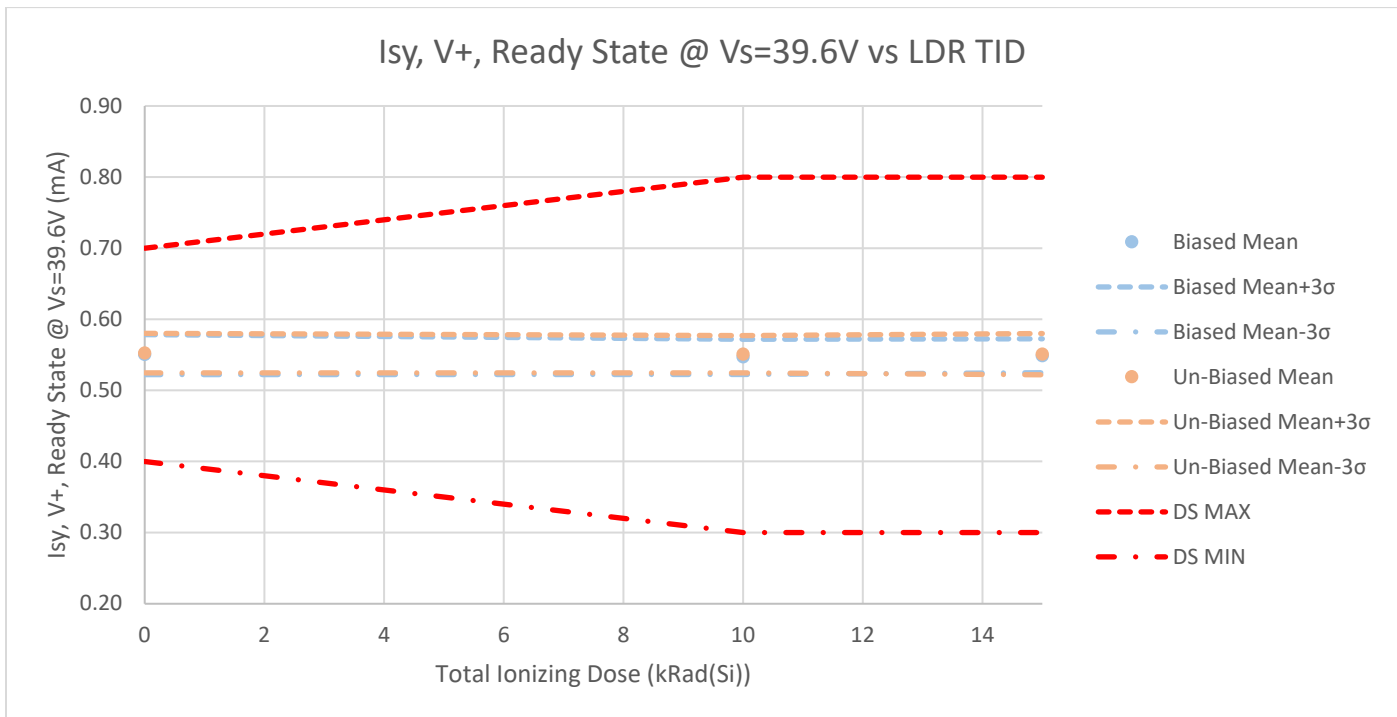

Table A-77-2. Isy, V+, Ready State @ Vs=39.6V vs. LDR TID for the RT6804HG-1.

Total Ionizing Dose (kRad(Si))	0	10	15	Units
LDR TID Biased				
Biased Mean	0.5504	0.5472	0.5487	mA
Std Dev	0.0094	0.0083	0.0079	
Biased Mean+3σ	0.5784	0.5720	0.5726	
Biased Mean-3σ	0.5223	0.5224	0.5249	
LDR TID Un-Biased				
Un-Biased Mean	0.5524	0.5509	0.5510	mA
Std Dev	0.0093	0.0087	0.0097	
Un-Biased Mean+3σ	0.5803	0.5771	0.5800	
Un-Biased Mean-3σ	0.5246	0.5247	0.5219	
DS MIN	4.00E-01	3.00E-01	3.00E-01	mA
	PASS	PASS	PASS	
DS MAX	7.00E-01	8.00E-01	8.00E-01	mA
	PASS	PASS	PASS	

Figure A-78-1. Isy, V+, Measurement State @ Vs=39.6V vs. HDR TID for the RT6804HG-1.

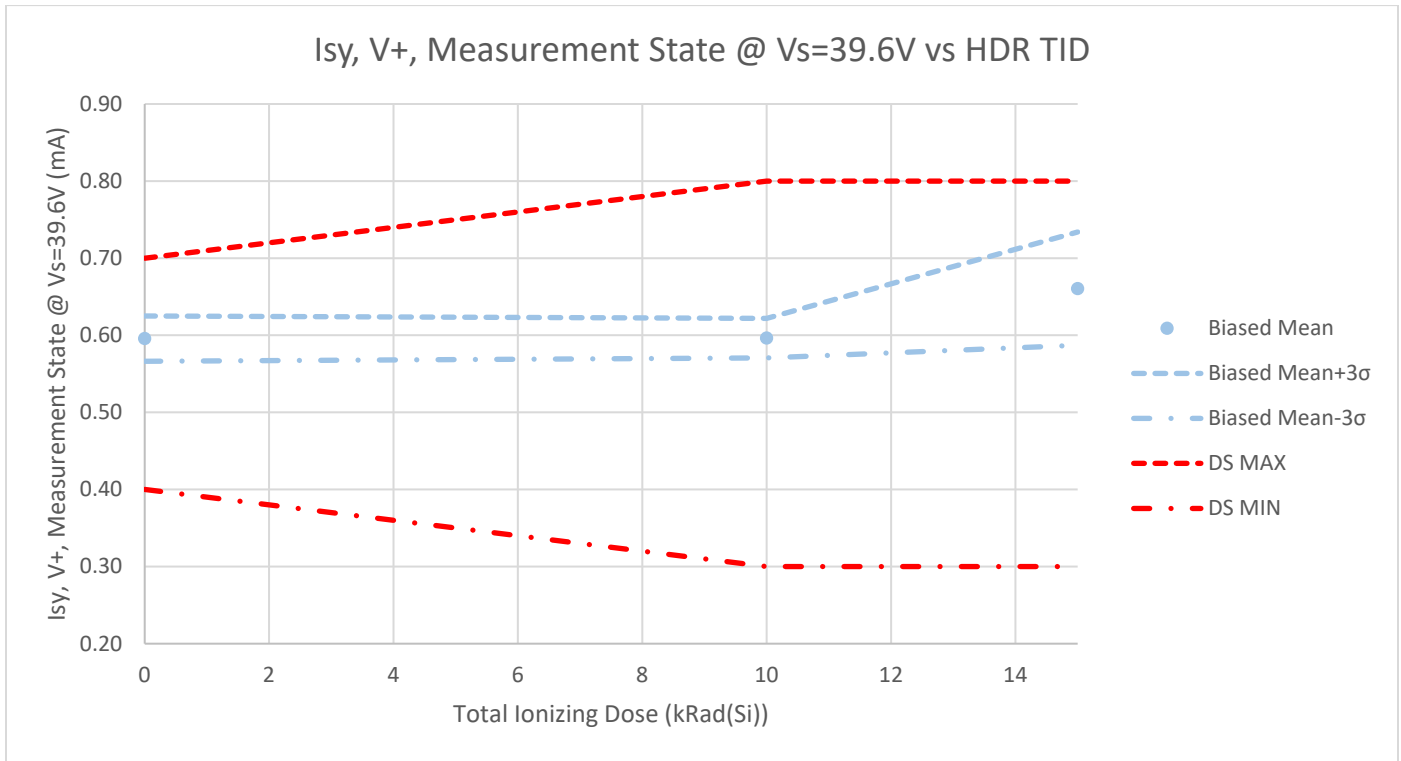

Table A-78-1. Isy, V+, Measurement State @ Vs=39.6V vs. HDR TID for the RT6804HG-1.

HDR TID Biased				
Total Ionizing Dose (kRad(Si))	0	10	15	Units
Biased Mean	0.5957	0.5963	0.6606	mA
Std Dev	0.0098	0.0085	0.0245	
Biased Mean+3σ	0.6250	0.6219	0.7340	
Biased Mean-3σ	0.5664	0.5706	0.5872	
DS MIN	4.00E-01	3.00E-01	3.00E-01	mA
	PASS	PASS	PASS	
DS MAX	7.00E-01	8.00E-01	8.00E-01	mA
	PASS	PASS	PASS	

Figure A-78-2. Isy, V+, Measurement State @ Vs=39.6V vs. LDR TID for the RT6804HG-1.

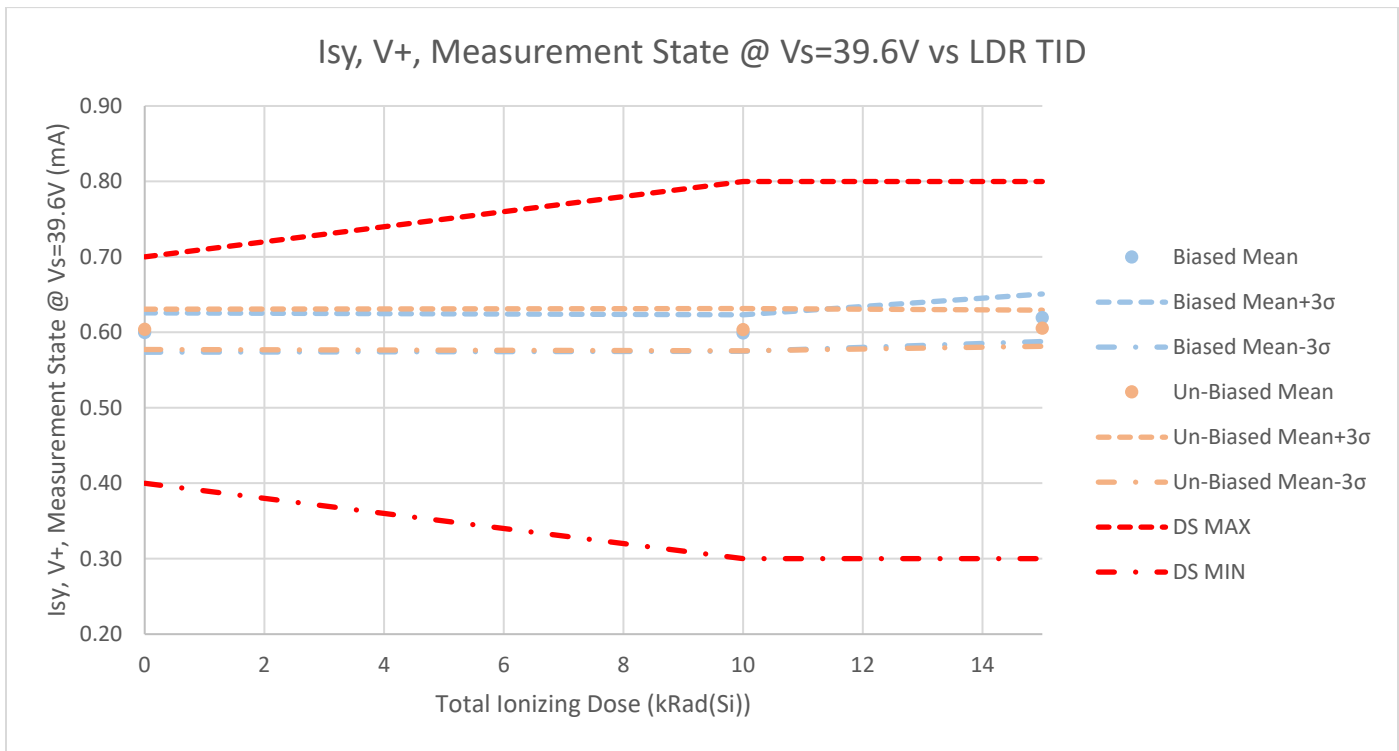

Table A-78-2. Isy, V+, Measurement State @ Vs=39.6V vs. LDR TID for the RT6804HG-1.

Total Ionizing Dose (kRad(Si))	0	10	15	Units
LDR TID Biased				
Biased Mean	0.5997	0.5991	0.6193	mA
Std Dev	0.0087	0.0081	0.0105	
Biased Mean+3σ	0.6258	0.6233	0.6509	
Biased Mean-3σ	0.5736	0.5749	0.5878	
LDR TID Un-Biased				
Un-Biased Mean	0.6039	0.6036	0.6055	mA
Std Dev	0.0089	0.0094	0.0080	
Un-Biased Mean+3σ	0.6306	0.6316	0.6294	
Un-Biased Mean-3σ	0.5771	0.5755	0.5816	
DS MIN	4.00E-01	3.00E-01	3.00E-01	mA
	PASS	PASS	PASS	
DS MAX	7.00E-01	8.00E-01	8.00E-01	mA
	PASS	PASS	PASS	

Figure A-79-1. Isy, VREG, Sleep State @ Vs=39.6V vs. HDR TID for the RT6804HG-1.

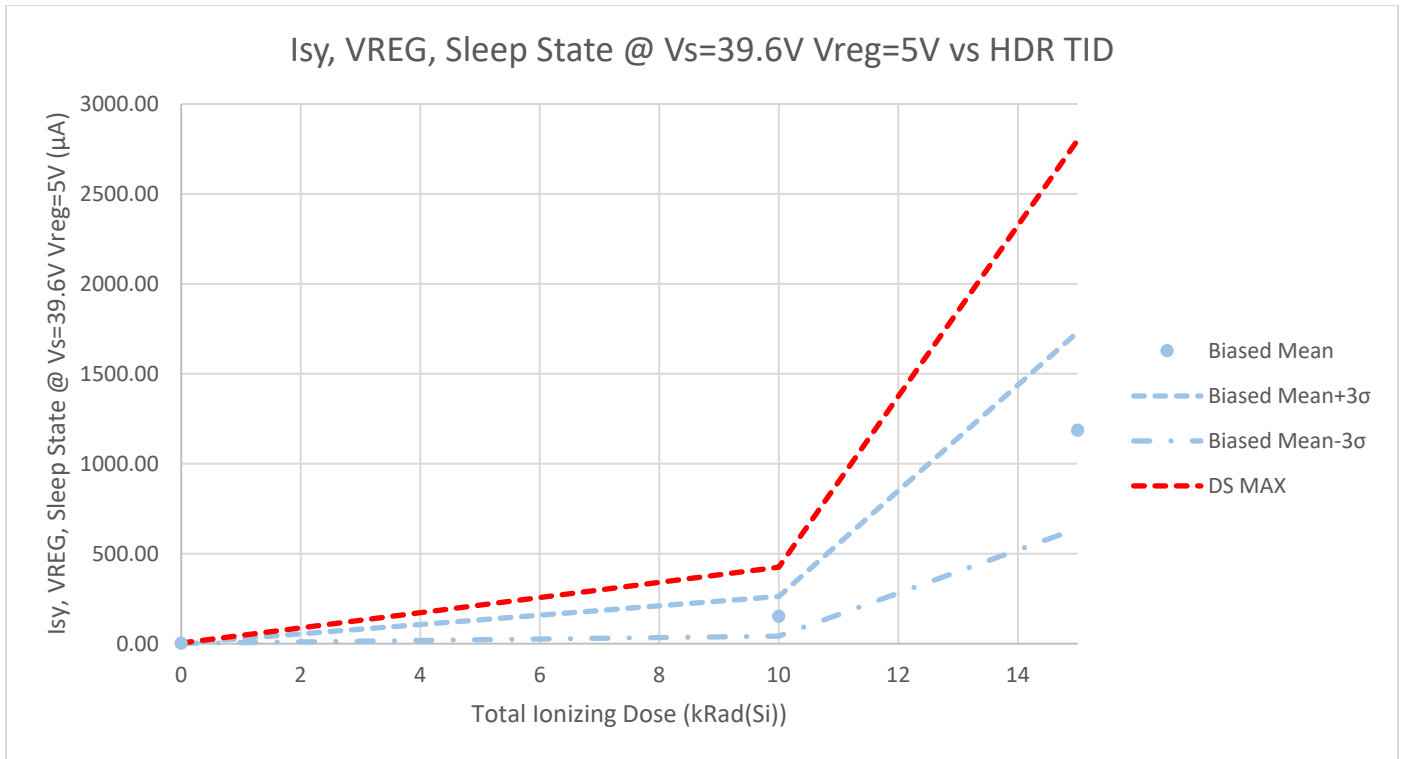

Table A-79-1. Isy, VREG, Sleep State @ Vs=39.6V vs. HDR TID for the RT6804HG-1.

HDR TID Biased				
Total Ionizing Dose (kRad(Si))	0	10	15	Units
Biased Mean	2.1338	152.1447	1186.6130	µA
Std Dev	0.1047	36.7729	181.9080	
Biased Mean+3σ	2.4479	262.4634	1732.3370	
Biased Mean-3σ	1.8197	41.8261	640.8890	
DS MIN	PASS	PASS	PASS	
DS MAX	4.00E+00	4.25E+02	2.80E+03	µA
	PASS	PASS	PASS	

Figure A-79-2. Isy, VREG, Sleep State @ Vs=39.6V vs. LDR TID for the RT6804HG-1.

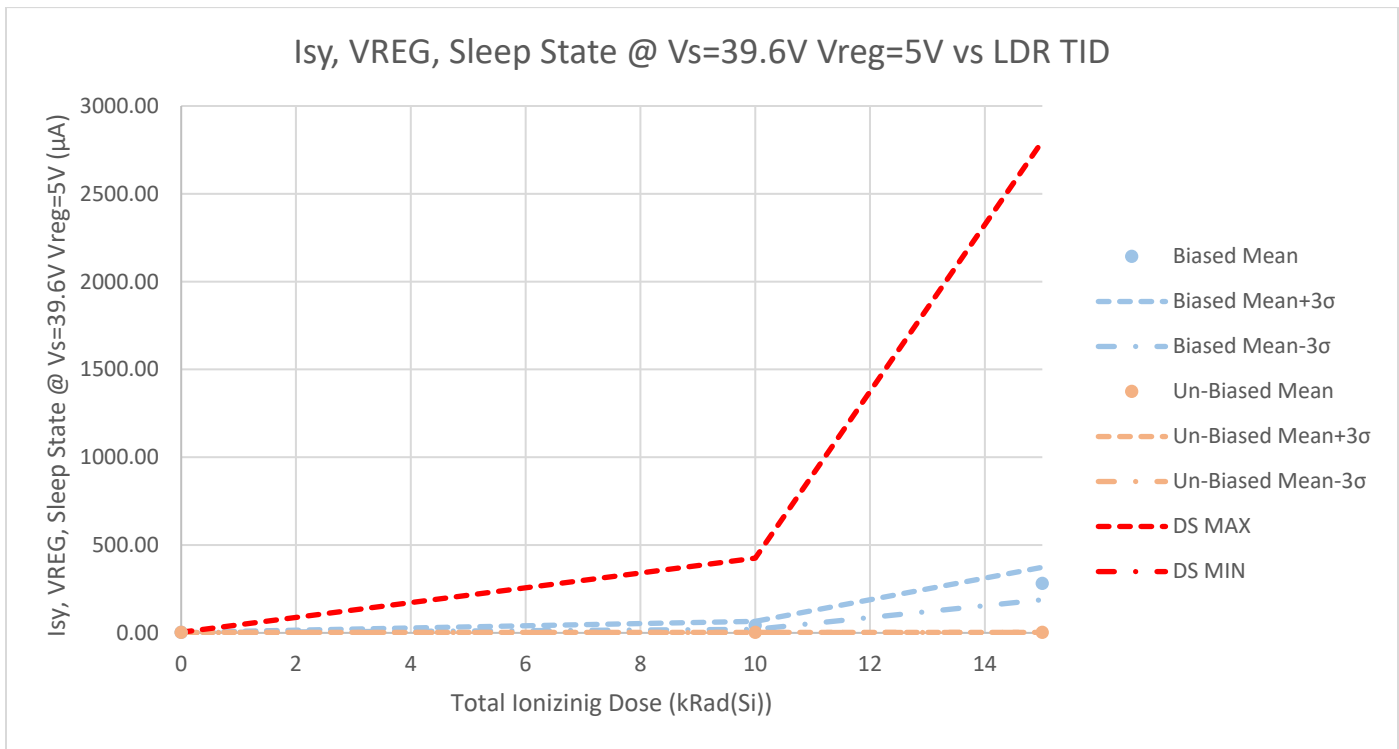

Table A-79-2. Isy, VREG, Sleep State @ Vs=39.6V vs. LDR TID for the RT6804HG-1.

Total Ionizing Dose (kRad(Si))	0	10	15	Units
LDR TID Biased				
Biased Mean	2.2798	42.7056	281.2948	µA
Std Dev	0.0337	7.6437	30.8530	
Biased Mean+3σ	2.3808	65.6366	373.8540	
Biased Mean-3σ	2.1789	19.7746	188.7357	
LDR TID Un-Biased				
Un-Biased Mean	2.2979	2.4408	2.3948	µA
Std Dev	0.0444	0.0845	0.0723	
Un-Biased Mean+3σ	2.4311	2.6944	2.6115	
Un-Biased Mean-3σ	2.1647	2.1873	2.1780	
DS MIN				
DS MIN	PASS	PASS	PASS	
DS MAX				
DS MAX	4.00E+00	4.25E+02	2.80E+03	µA
	PASS	PASS	PASS	

Figure A-80-1. Isy, VREG, Standby State @ Vs=39.6V vs. HDR TID for the RT6804HG-1.

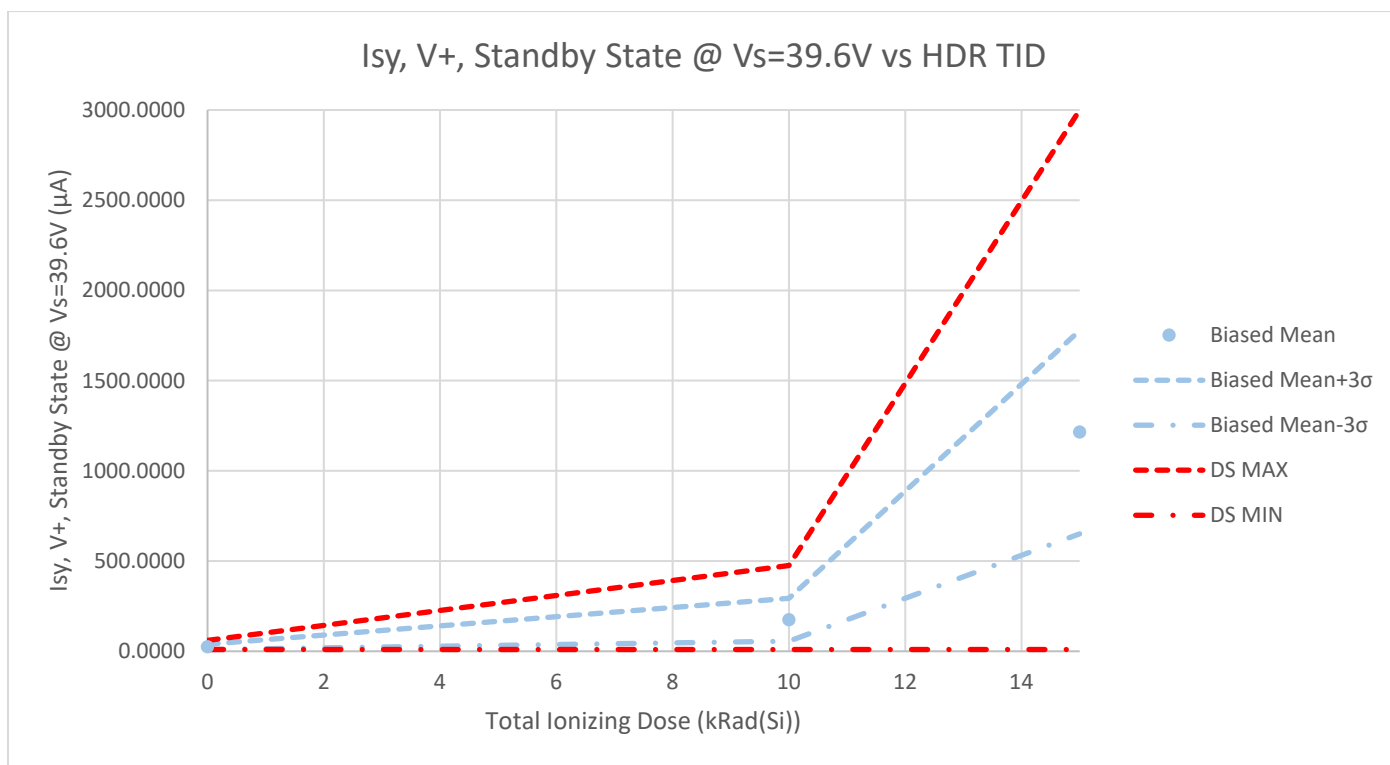

Table A-80-1. Isy, VREG, Standby State @ Vs=39.6V vs. HDR TID for the RT6804HG-1.

HDR TID Biased				
Total Ionizing Dose (kRad(Si))	0	10	15	Units
Biased Mean	24.2236	174.5198	1214.5252	µA
Std Dev	4.9320	39.6889	187.8992	
Biased Mean+3σ	39.0196	293.5864	1778.2228	
Biased Mean-3σ	9.4276	55.4531	650.8276	
DS MIN	1.00E+01	1.00E+01	1.00E+01	µA
	PASS	PASS	PASS	
DS MAX	6.00E+01	4.75E+02	3.00E+03	µA
	PASS	PASS	PASS	

Figure A-80-2. Isy, VREG, Standby State @ Vs=39.6V vs. LDR TID for the RT6804HG-1.

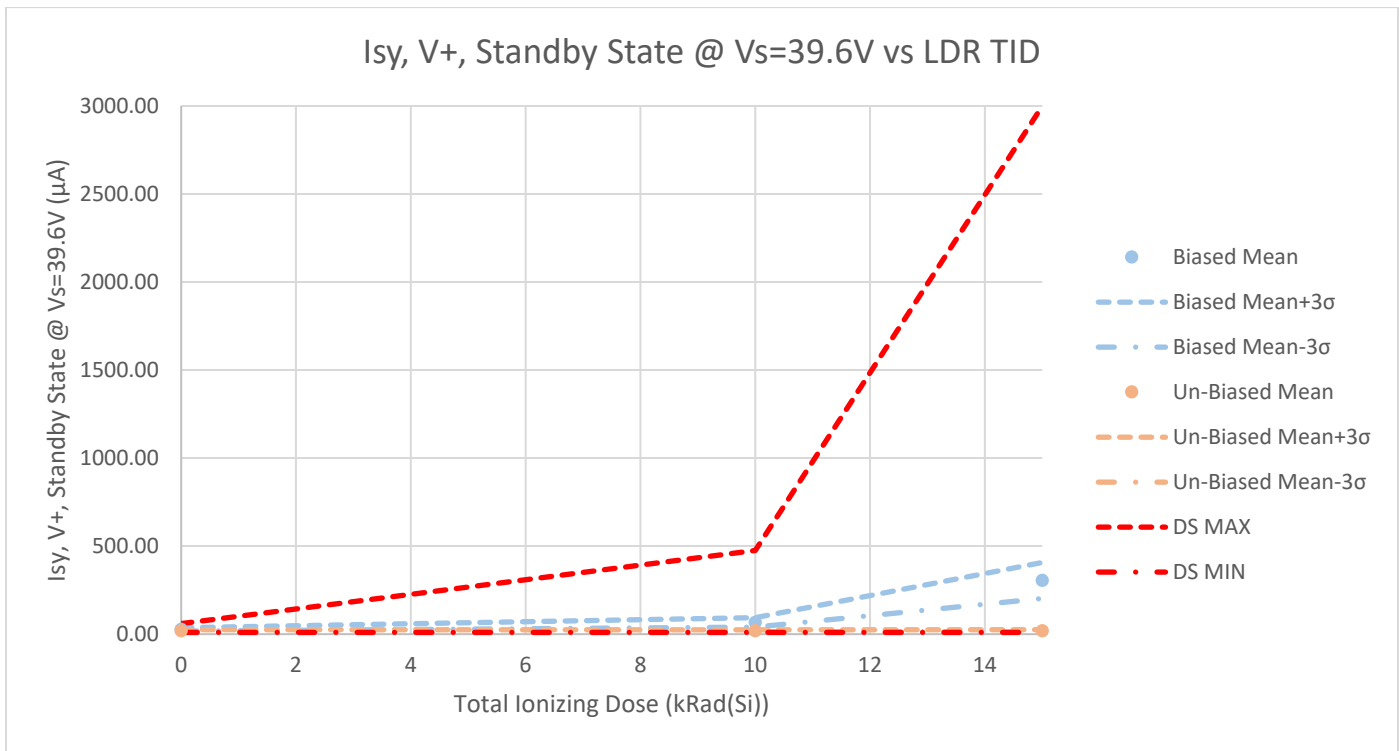

Table A-80-2. Isy, VREG, Standby State @ Vs=39.6V vs. LDR TID for the RT6804HG-1.

Total Ionizing Dose (kRad(Si))	0	10	15	Units
LDR TID Biased				
Biased Mean	26.4293	66.0212	304.4761	µA
Std Dev	3.3211	9.0217	34.0649	
Biased Mean+3σ	36.3927	93.0862	406.6709	
Biased Mean-3σ	16.4659	38.9562	202.2813	
LDR TID Un-Biased				
Un-Biased Mean	18.0284	18.0517	17.9675	µA
Std Dev	2.2564	1.9866	2.2680	
Un-Biased Mean+3σ	24.7975	24.0114	24.7714	
Un-Biased Mean-3σ	11.2593	12.0921	11.1637	
DS MIN	1.00E+01	1.00E+01	1.00E+01	µA
	PASS	PASS	PASS	
DS MAX	6.00E+01	4.75E+02	3.00E+03	µA
	PASS	PASS	PASS	

Figure A-81-1. Isy, VREG, Ready State @ Vs=39.6V vs. HDR TID for the RT6804HG-1.

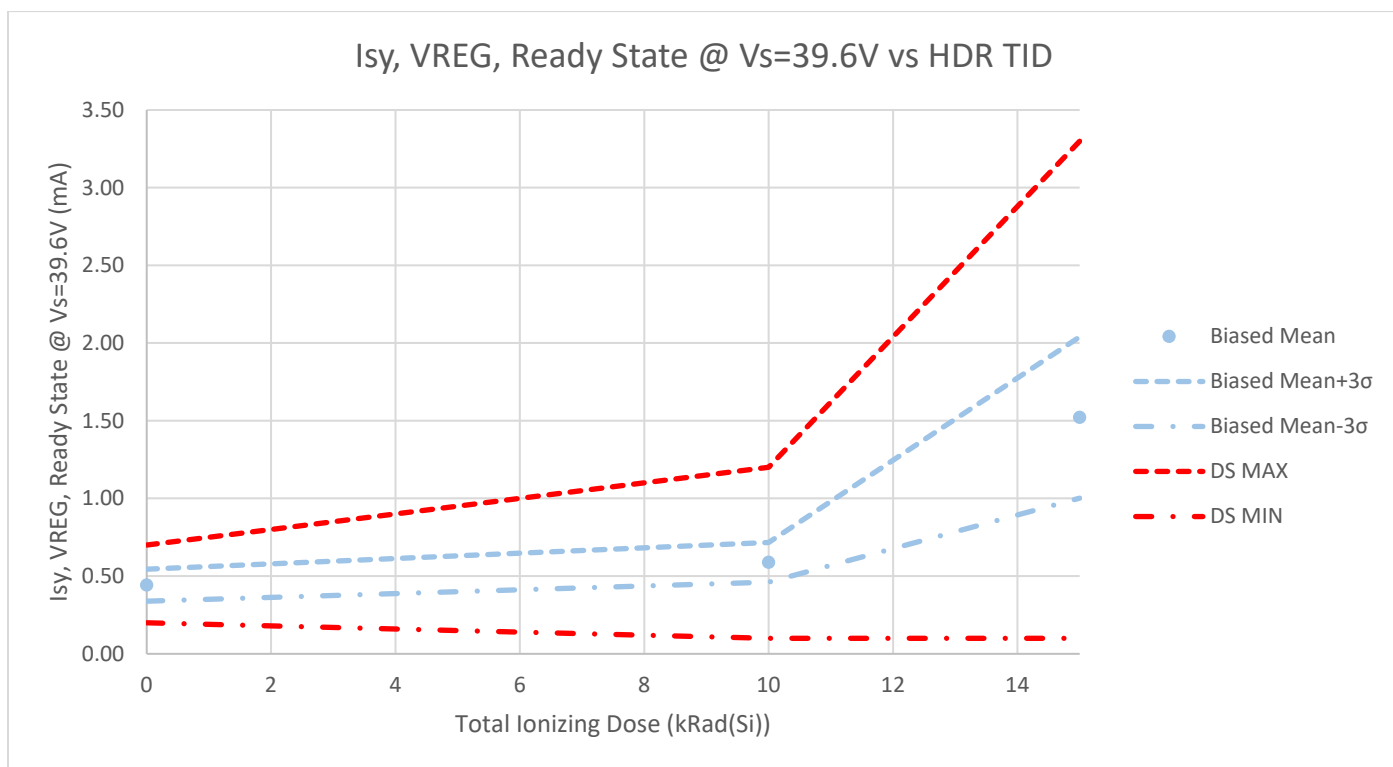

Table A-81-1. Isy, VREG, Ready State @ Vs=39.6V vs. HDR TID for the RT6804HG-1.

HDR TID Biased				
Total Ionizing Dose (kRad(Si))	0	10	15	Units
Biased Mean	0.4420	0.5887	1.5212	mA
Std Dev	0.0344	0.0426	0.1730	
Biased Mean+3σ	0.5452	0.7165	2.0403	
Biased Mean-3σ	0.3388	0.4609	1.0020	
DS MIN	2.00E-01	1.00E-01	1.00E-01	mA
	PASS	PASS	PASS	
DS MAX	7.00E-01	1.20E+00	3.30E+00	mA
	PASS	PASS	PASS	

Figure A-81-2. Isy, VREG, Ready State @ Vs=39.6V vs. LDR TID for the RT6804HG-1.

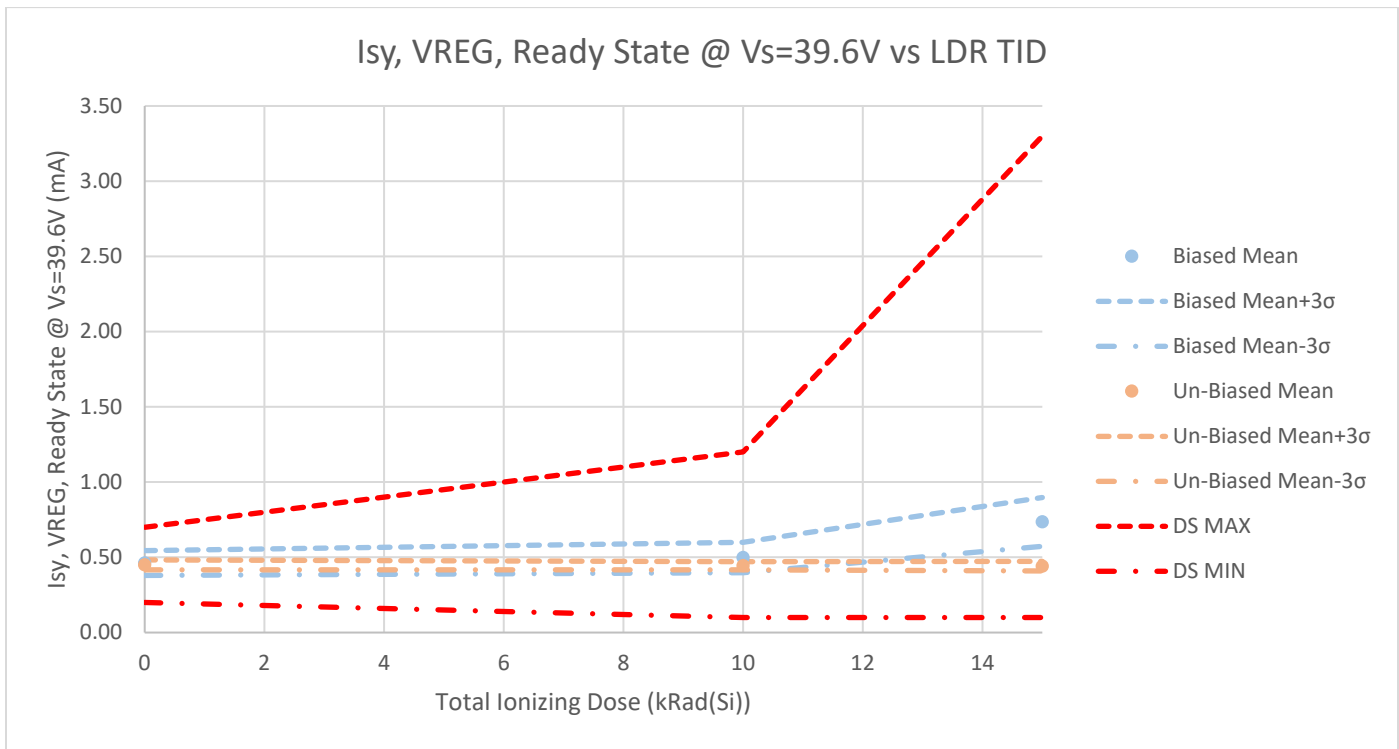

Table A-81-2. Isy, VREG, Ready State @ Vs=39.6V vs. LDR TID for the RT6804HG-1.

Total Ionizing Dose (kRad(Si))	0	10	15	Units
LDR TID Biased				
Biased Mean	0.4616	0.4979	0.7355	mA
Std Dev	0.0274	0.0338	0.0541	
Biased Mean+3σ	0.5437	0.5993	0.8978	
Biased Mean-3σ	0.3796	0.3966	0.5732	
LDR TID Un-Biased				
Un-Biased Mean	0.4495	0.4438	0.4405	mA
Std Dev	0.0110	0.0090	0.0106	
Un-Biased Mean+3σ	0.4825	0.4707	0.4724	
Un-Biased Mean-3σ	0.4165	0.4169	0.4087	
DS MIN	2.00E-01	1.00E-01	1.00E-01	mA
	PASS	PASS	PASS	
DS MAX	7.00E-01	1.20E+00	3.30E+00	mA
	PASS	PASS	PASS	

Figure A-82-1. Isy, VREG, Measurement State @ Vs=39.6V vs. HDR TID for the RT6804HG-1.

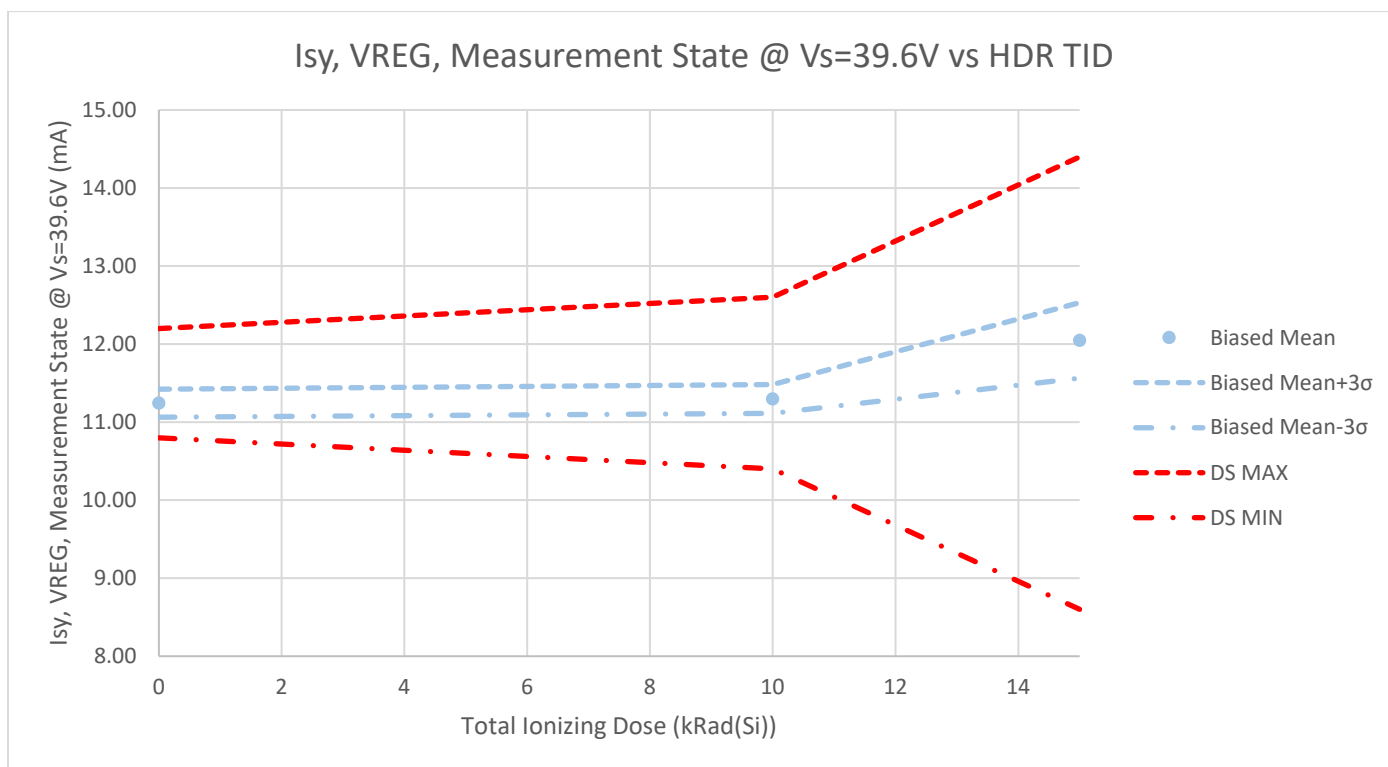

Table A-82-1. Isy, VREG, Measurement State @ Vs=39.6V vs. HDR TID for the RT6804HG-1.

HDR TID Biased				
Total Ionizing Dose (kRad(Si))	0	10	15	Units
Biased Mean	11.2426	11.2968	12.0475	mA
Std Dev	0.0597	0.0614	0.1613	
Biased Mean+3σ	11.4217	11.4810	12.5312	
Biased Mean-3σ	11.0635	11.1127	11.5637	
DS MIN	1.08E+01	1.04E+01	8.60E+00	mA
	PASS	PASS	PASS	
DS MAX	1.22E+01	1.26E+01	1.44E+01	mA
	PASS	PASS	PASS	

Figure A-82-2. Isy, VREG, Measurement State @ Vs=39.6V vs. LDR TID for the RT6804HG-1.

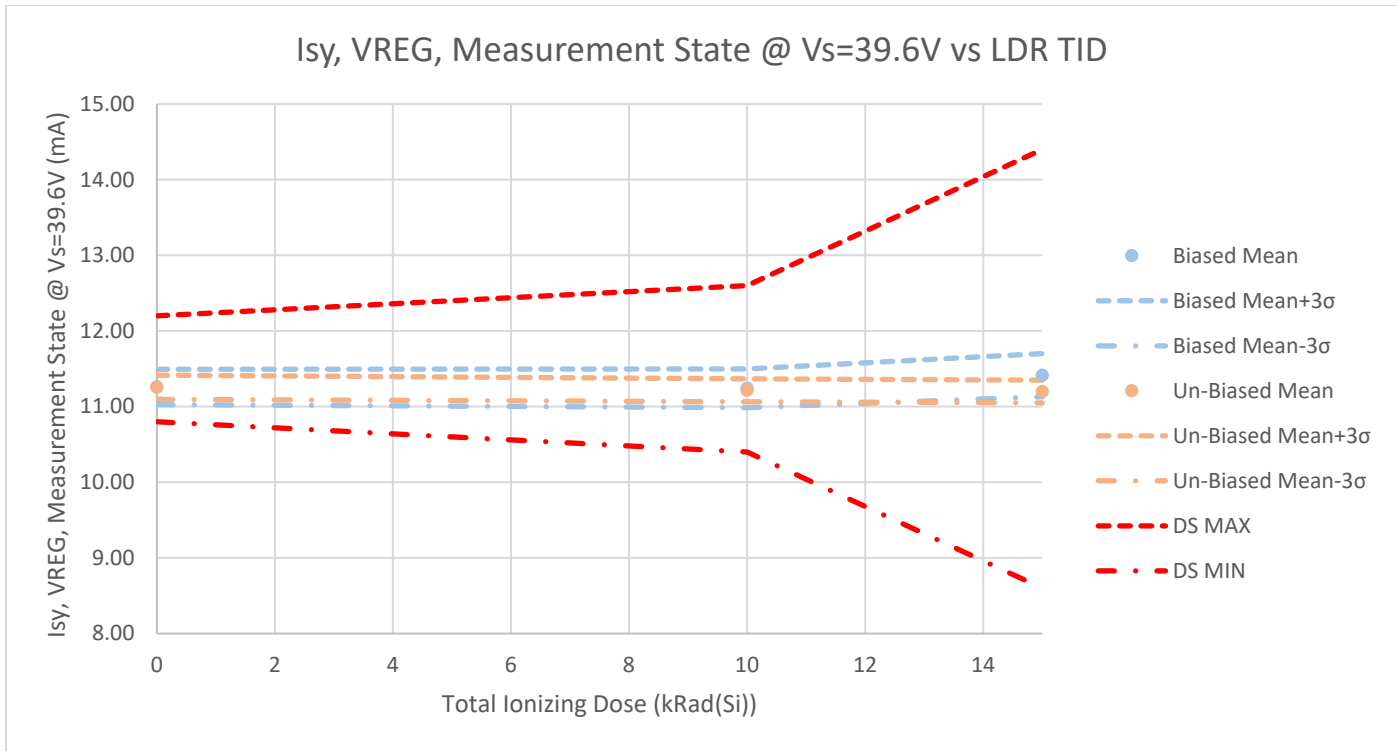

Table A-82-2. Isy, VREG, Measurement State @ Vs=39.6V vs. LDR TID for the RT6804HG-1.

Total Ionizing Dose (kRad(Si))	0	10	15	Units
LDR TID Biased				
Biased Mean	11.2595	11.2417	11.4147	mA
Std Dev	0.0781	0.0850	0.0951	
Biased Mean+3σ	11.4937	11.4967	11.7001	
Biased Mean-3σ	11.0253	10.9866	11.1293	
LDR TID Un-Biased				
Un-Biased Mean	11.2557	11.2150	11.1996	mA
Std Dev	0.0530	0.0504	0.0503	
Un-Biased Mean+3σ	11.4147	11.3661	11.3507	
Un-Biased Mean-3σ	11.0966	11.0639	11.0486	
DS MIN	1.08E+01	1.04E+01	8.60E+00	mA
	PASS	PASS	PASS	
DS MAX	1.22E+01	1.26E+01	1.44E+01	mA
	PASS	PASS	PASS	

Figure A-83-1. DRIVE pin @ V=39.6V, Iload=1uA vs. HDR TID for the RT6804HG-1.

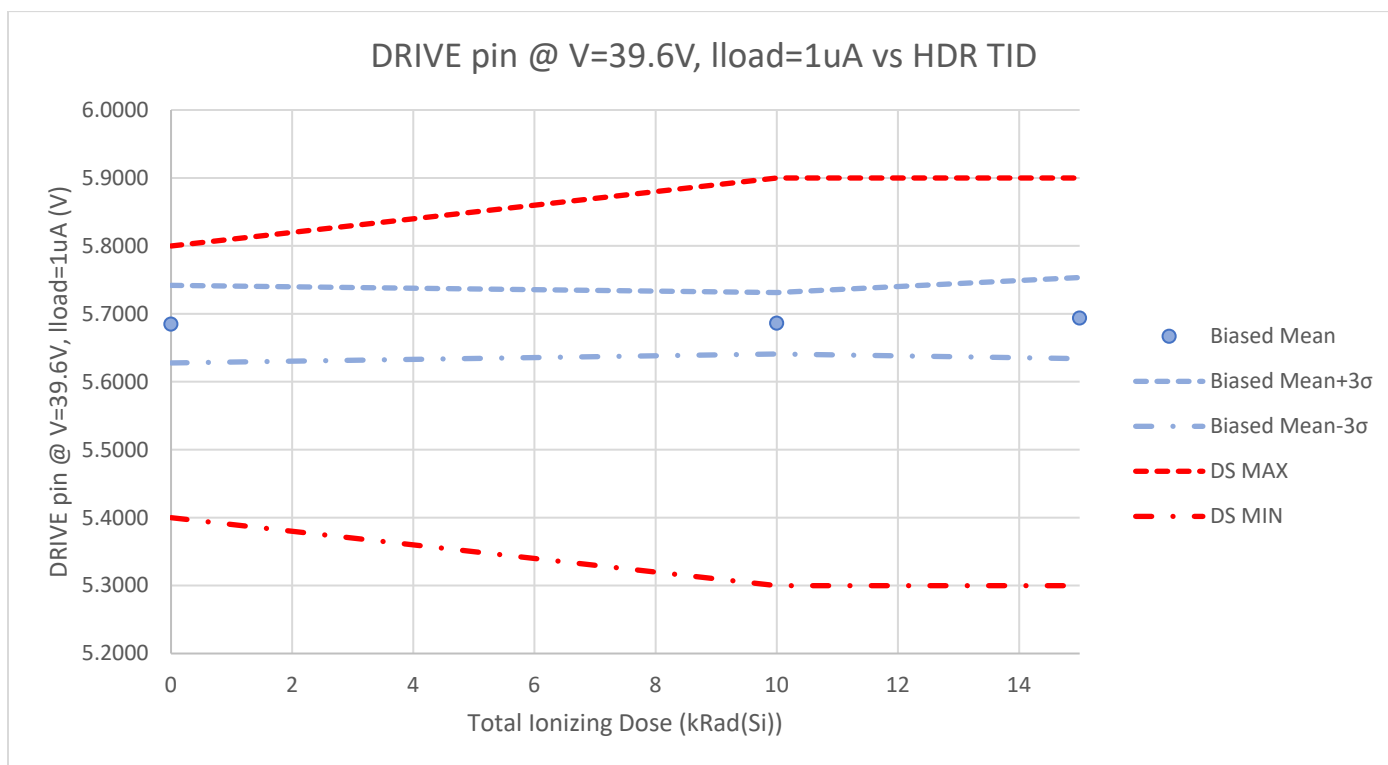

Table A-83-1. DRIVE pin @ V=39.6V, Iload=1uA vs. HDR TID for the RT6804HG-1.

HDR TID Biased				
Total Ionizing Dose (kRad(Si))	0	10	15	Units
Biased Mean	5.6848	5.6861	5.6937	V
Std Dev	0.0190	0.0151	0.0199	
Biased Mean+3σ	5.7418	5.7313	5.7535	
Biased Mean-3σ	5.6277	5.6409	5.6339	
DS MIN	5.40E+00	5.30E+00	5.30E+00	V
	PASS	PASS	PASS	
DS MAX	5.80E+00	5.90E+00	5.90E+00	V
	PASS	PASS	PASS	

Figure A-83-2. I_{sy} , DRIVE pin @ $V=39.6V$, $I_{load}=1\mu A$ vs. LDR TID for the RT6804HG-1.

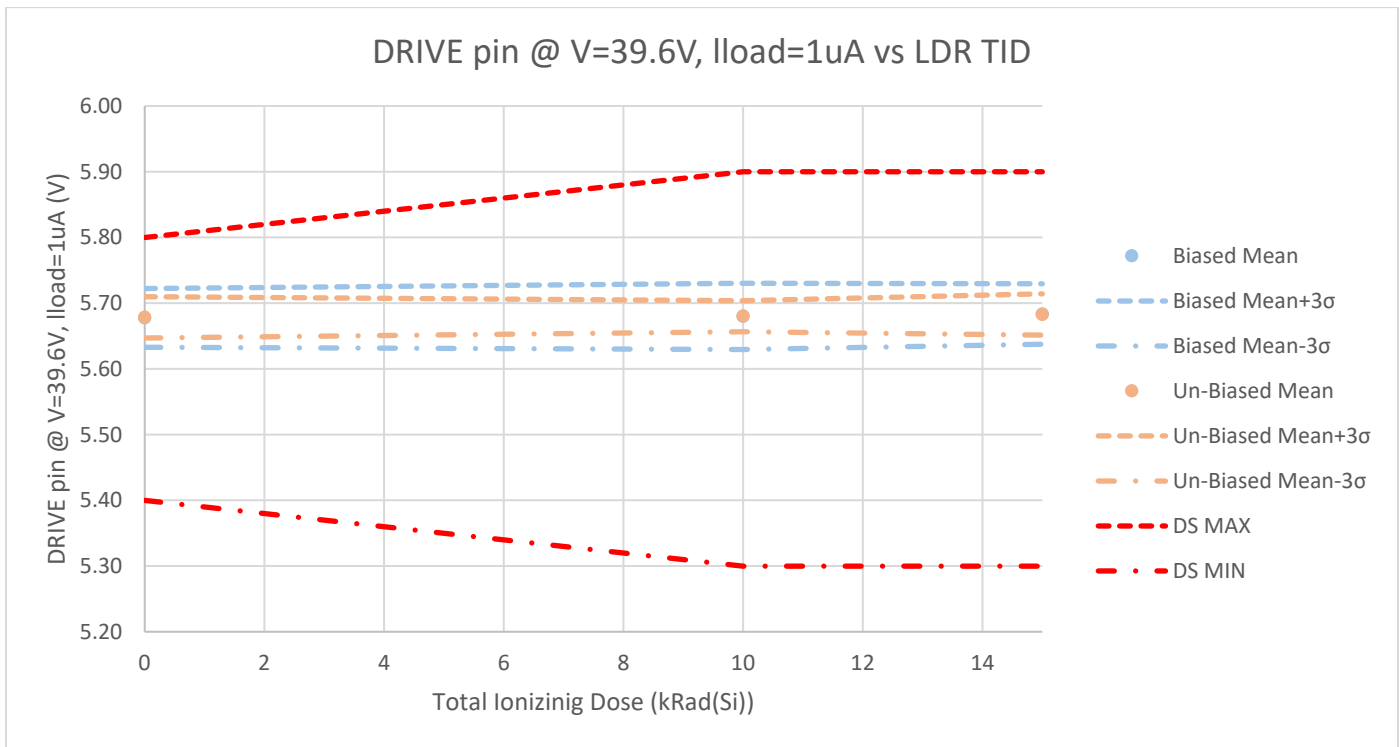

Table A-83-2. DRIVE pin @ $V=39.6V$, $I_{load}=1\mu A$ vs. LDR TID for the RT6804HG-1.

Total Ionizing Dose (kRad(Si))	0	10	15	Units
LDR TID Biased				
Biased Mean	5.6777	5.6800	5.6835	V
Std Dev	0.0149	0.0168	0.0153	
Biased Mean+3σ	5.7224	5.7304	5.7295	
Biased Mean-3σ	5.6330	5.6297	5.6375	
LDR TID Un-Biased				
Un-Biased Mean	5.6785	5.6803	5.6828	V
Std Dev	0.0105	0.0079	0.0105	
Un-Biased Mean+3σ	5.7099	5.7039	5.7144	
Un-Biased Mean-3σ	5.6472	5.6566	5.6513	
DS Limits				
DS MIN	5.40E+00	5.30E+00	5.30E+00	V
	PASS	PASS	PASS	
DS MAX	5.80E+00	5.90E+00	5.90E+00	V
	PASS	PASS	PASS	

Figure A-84-1. S1 Ron vs. HDR TID for the RT6804HG-1.

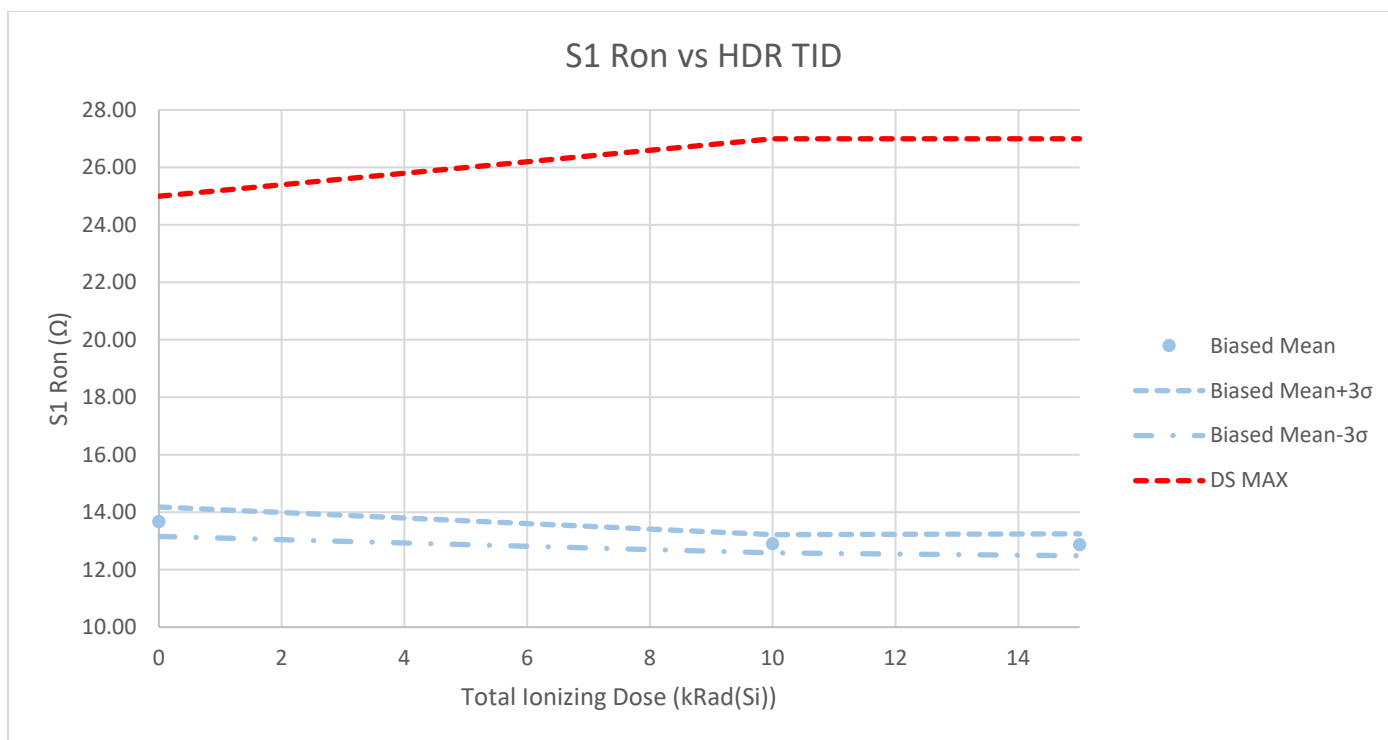

Table A-84-1. S1 Ron vs. HDR TID for the RT6804HG-1.

HDR TID Biased				
Total Ionizing Dose (kRad(Si))	0	10	15	Units
Biased Mean	13.6706	12.9014	12.8664	Ω
Std Dev	0.1712	0.1069	0.1261	
Biased Mean+3σ	14.1842	13.2219	13.2445	
Biased Mean-3σ	13.1571	12.5808	12.4882	
DS MIN	PASS	PASS	PASS	
DS MAX	2.50E+01	2.70E+01	2.70E+01	Ω
	PASS	PASS	PASS	

Figure A-84-2. S1 Ron vs. LDR TID for the RT6804HG-1.

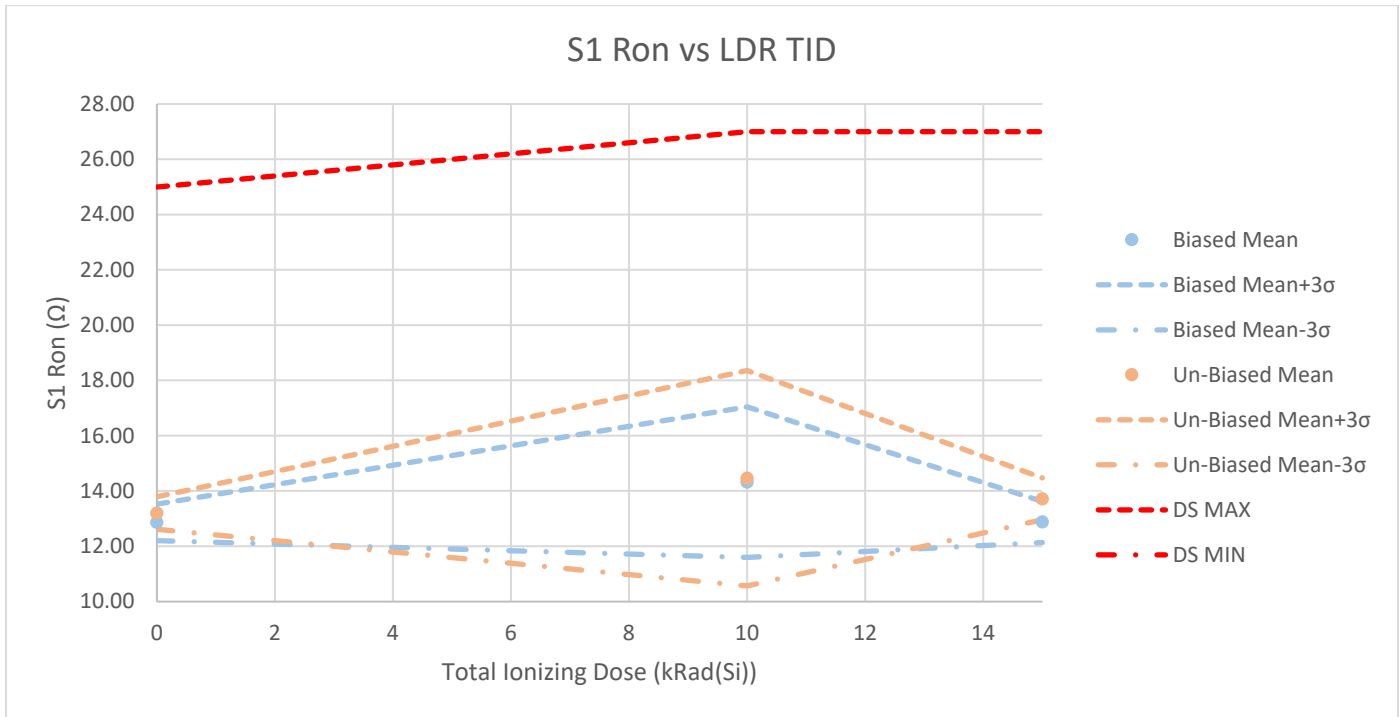

Table A-84-2. S1 Ron vs. LDR TID for the RT6804HG-1.

Total Ionizing Dose (kRad(Si))	0	10	15	Units
LDR TID Biased				
Biased Mean	12.8632	14.3207	12.8767	Ω
Std Dev	0.2198	0.9080	0.2478	
Biased Mean+3σ	13.5227	17.0448	13.6201	
Biased Mean-3σ	12.2036	11.5966	12.1333	
LDR TID Un-Biased				
Un-Biased Mean	13.1999	14.4598	13.7153	Ω
Std Dev	0.1961	1.2989	0.2516	
Un-Biased Mean+3σ	13.7883	18.3566	14.4701	
Un-Biased Mean-3σ	12.6115	10.5629	12.9604	
DS MIN				
	PASS	PASS	PASS	
DS MAX	2.50E+01	2.70E+01	2.70E+01	Ω
	PASS	PASS	PASS	

Figure A-85-1. S2 Ron vs. HDR TID for the RT6804HG-1.

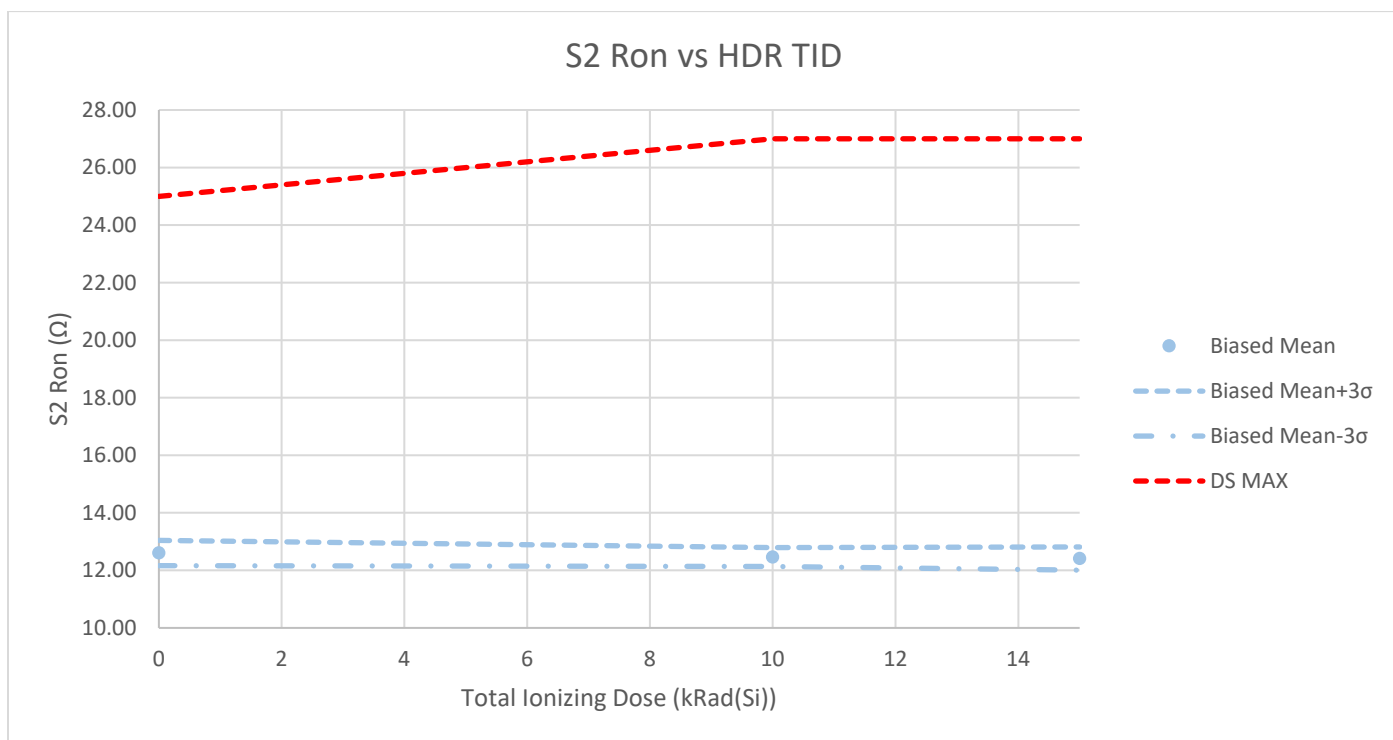

Table A-85-1. S2 Ron vs. HDR TID for the RT6804HG-1.

HDR TID Biased				
Total Ionizing Dose (kRad(Si))	0	10	15	Units
Biased Mean	12.6060	12.4628	12.4123	Ω
Std Dev	0.1465	0.1096	0.1336	
Biased Mean+3σ	13.0455	12.7916	12.8130	
Biased Mean-3σ	12.1666	12.1340	12.0116	
DS MIN	PASS	PASS	PASS	
DS MAX	2.50E+01	2.70E+01	2.70E+01	Ω
	PASS	PASS	PASS	

Figure A-85-2. S2 Ron vs. LDR TID for the RT6804HG-1.

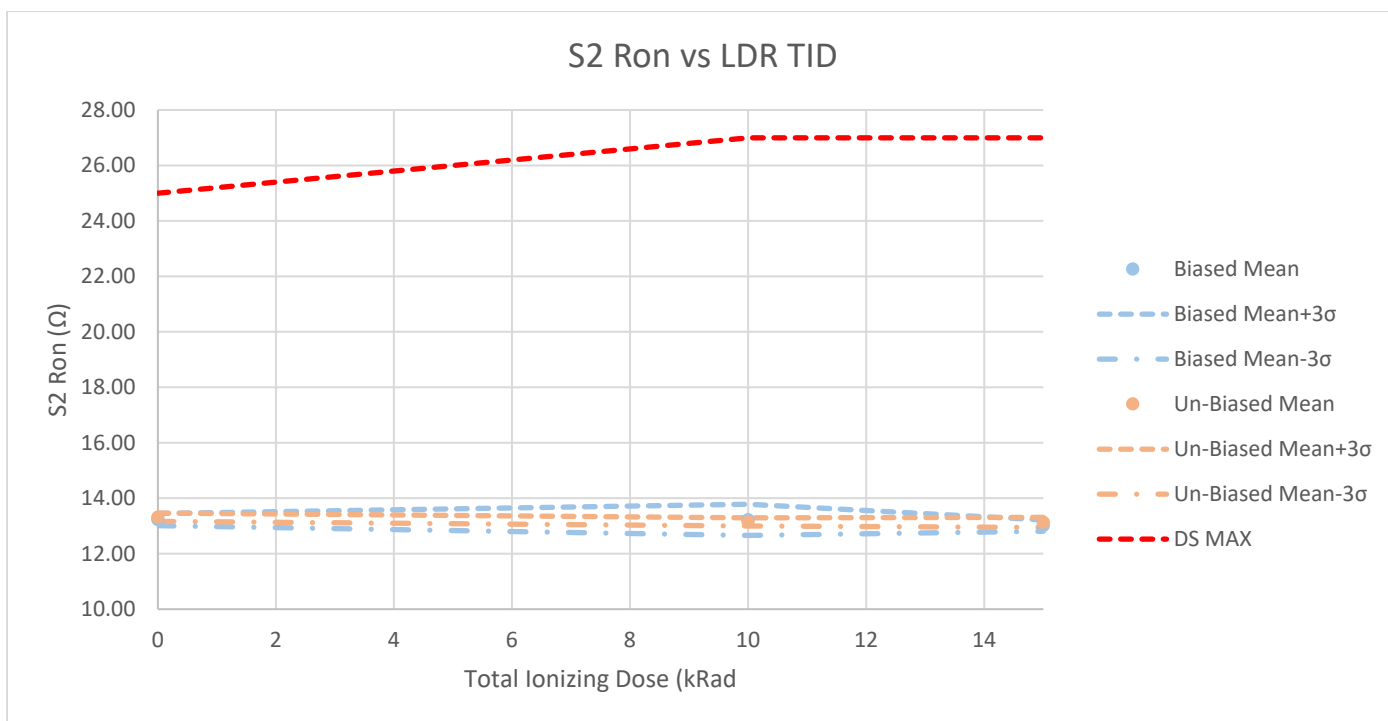

Table A-85-2. S2 Ron vs. LDR TID for the RT6804HG-1.

Total Ionizing Dose (kRad(Si))	0	10	15	Units
LDR TID Biased				
Biased Mean	13.2296	13.2196	13.0138	Ω
Std Dev	0.0729	0.1876	0.0689	
Biased Mean+3σ	13.4483	13.7823	13.2204	
Biased Mean-3σ	13.0110	12.6569	12.8071	
LDR TID Un-Biased				
Un-Biased Mean	13.3160	13.1448	13.1298	Ω
Std Dev	0.0493	0.0502	0.0600	
Un-Biased Mean+3σ	13.4639	13.2952	13.3097	
Un-Biased Mean-3σ	13.1681	12.9943	12.9500	
DS MIN	PASS	PASS	PASS	
DS MAX	2.50E+01	2.70E+01	2.70E+01	Ω
	PASS	PASS	PASS	

Figure A-86-1. S3 Ron vs. HDR TID for the RT6804HG-1.

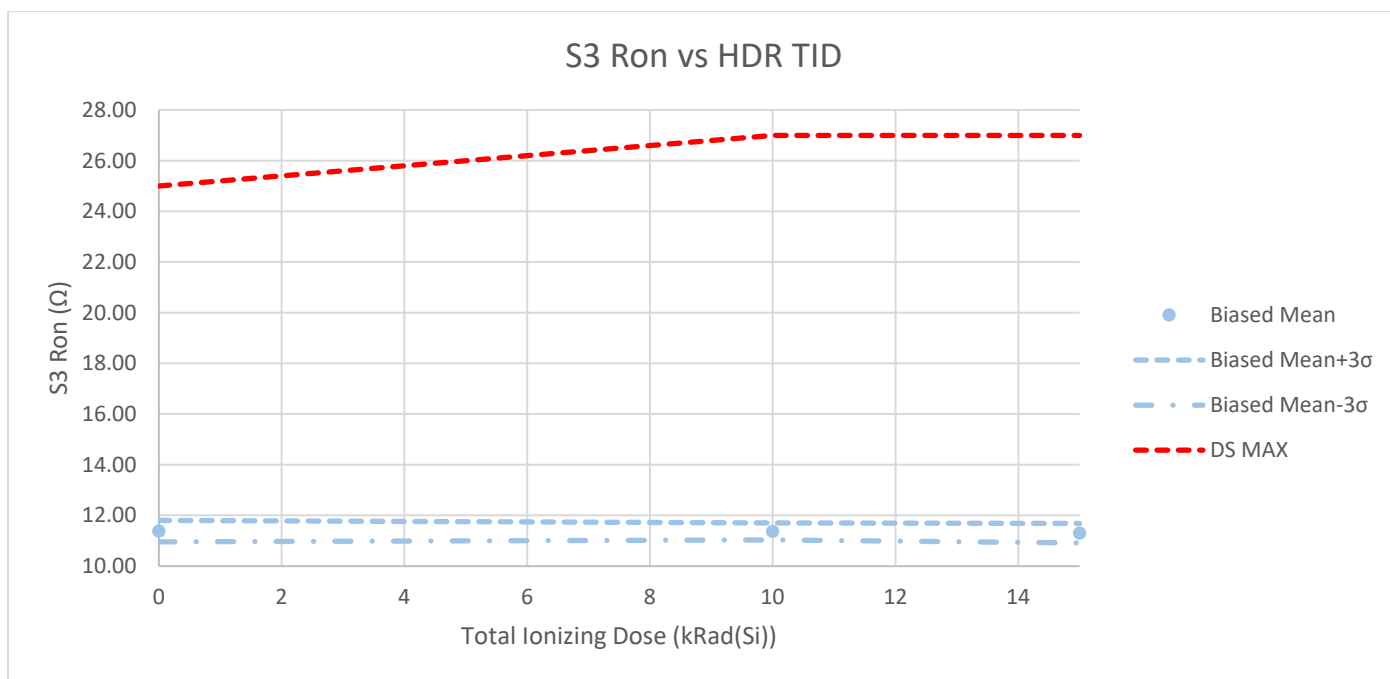

Table A-86-1. S3 Ron vs. HDR TID for the RT6804HG-1.

HDR TID Biased				
Total Ionizing Dose (kRad(Si))	0	10	15	Units
Biased Mean	11.3789	11.3649	11.2975	Ω
Std Dev	0.1424	0.1108	0.1284	
Biased Mean+3σ	11.8060	11.6974	11.6827	
Biased Mean-3σ	10.9518	11.0324	10.9124	
DS MIN				
	PASS	PASS	PASS	
DS MAX	2.50E+01	2.70E+01	2.70E+01	Ω
	PASS	PASS	PASS	

Figure A-86-2. S3 Ron vs. LDR TID for the RT6804HG-1.

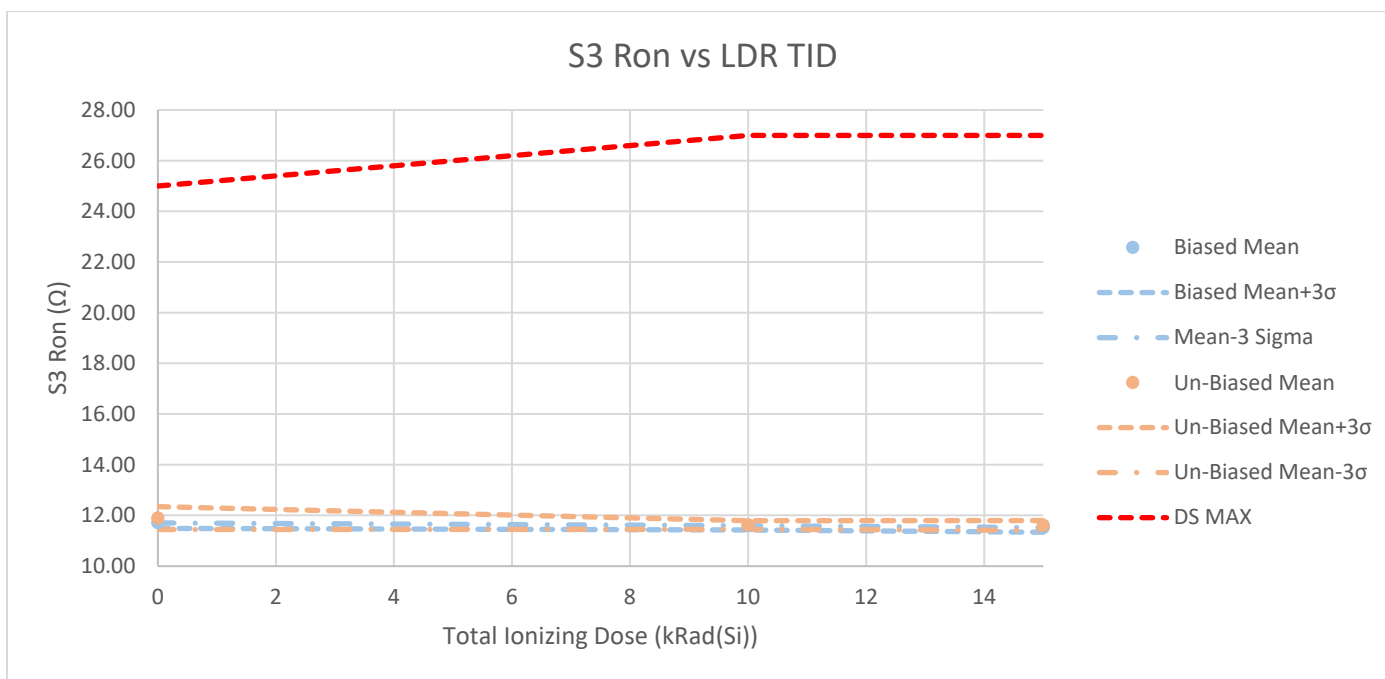

Table A-86-2. S3 Ron vs. LDR TID for the RT6804HG-1.

Total Ionizing Dose (kRad(Si))	0	10	15	Units
LDR TID Biased				
Biased Mean	11.7056	11.5909	11.5178	Ω
Std Dev	0.0720	0.0568	0.0610	
Biased Mean+3σ	11.9216	11.7613	11.7007	
Biased Mean-3σ	11.4896	11.4206	11.3348	
LDR TID Un-Biased				
Un-Biased Mean	11.8923	11.6209	11.6026	Ω
Std Dev	0.1516	0.0564	0.0645	
Un-Biased Mean+3σ	12.3472	11.7901	11.7961	
Un-Biased Mean-3σ	11.4375	11.4516	11.4091	
DS MIN				
	PASS	PASS	PASS	
DS MAX				
	2.50E+01	2.70E+01	2.70E+01	Ω
	PASS	PASS	PASS	

Figure A-87-1. S4 Ron vs. HDR TID for the RT6804HG-1.

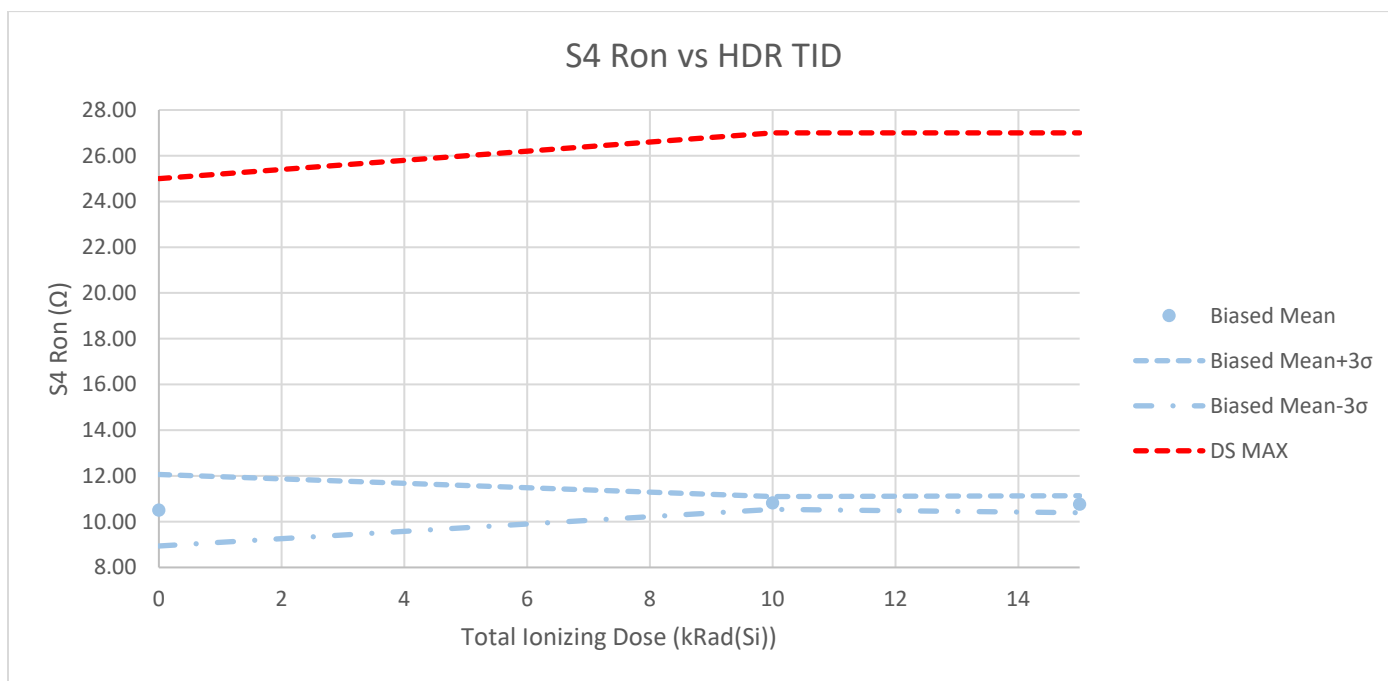

Table A-87-1. S4 Ron vs. HDR TID for the RT6804HG-1.

HDR TID Biased				
Total Ionizing Dose (kRad(Si))	0	10	15	Units
Biased Mean	10.4988	10.8182	10.7614	Ω
Std Dev	0.5213	0.0939	0.1237	
Biased Mean+3σ	12.0628	11.0999	11.1326	
Biased Mean-3σ	8.9348	10.5366	10.3903	
DS MIN				
	PASS	PASS	PASS	
DS MAX				Ω
	PASS	PASS	PASS	

Figure A-87-2. S4 Ron vs. LDR TID for the RT6804HG-1.

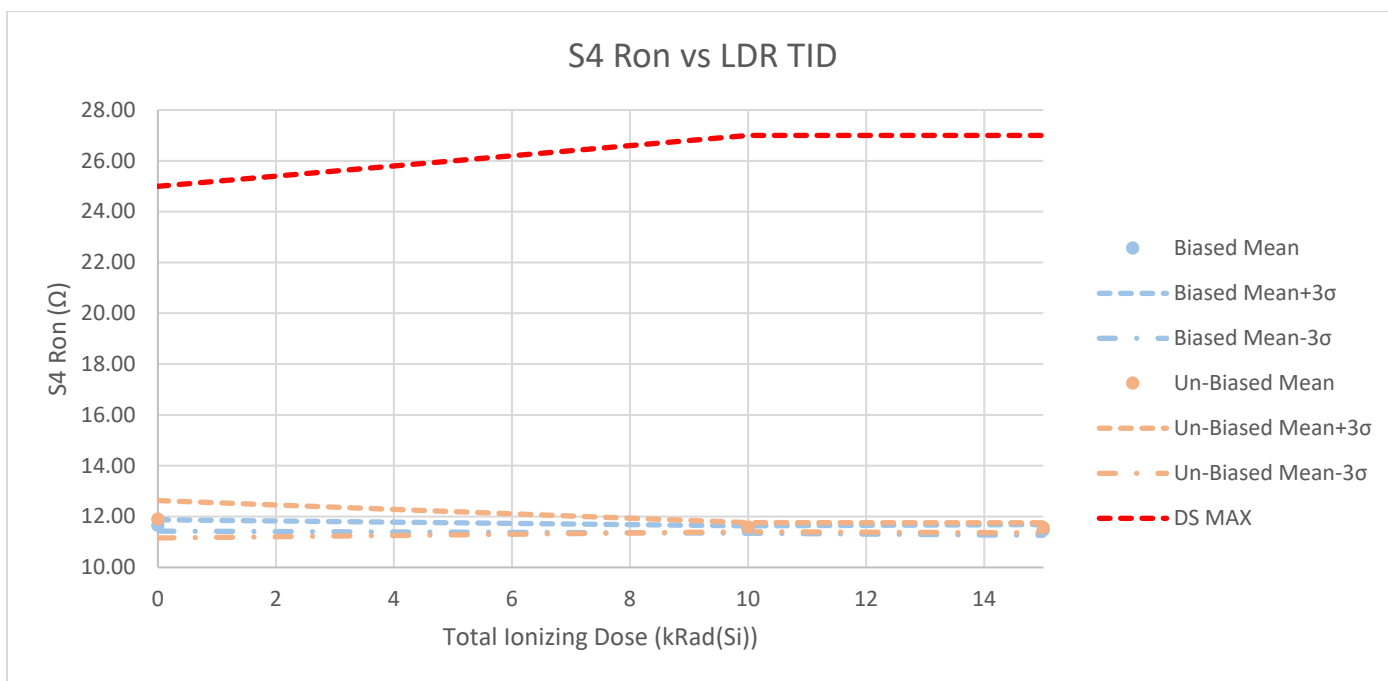

Table A-87-2. S4 Ron vs. LDR TID for the RT6804HG-1.

Total Ionizing Dose (kRad(Si))	0	10	15	Units
LDR TID Biased				
Biased Mean	11.6542	11.4918	11.4722	Ω
Std Dev	0.0742	0.0484	0.0707	
Biased Mean+3σ	11.8769	11.6369	11.6842	
Biased Mean-3σ	11.4315	11.3467	11.2602	
LDR TID Un-Biased				
Un-Biased Mean	11.8953	11.5817	11.5556	Ω
Std Dev	0.2458	0.0596	0.0665	
Un-Biased Mean+3σ	12.6328	11.7604	11.7551	
Un-Biased Mean-3σ	11.1579	11.4031	11.3561	
DS MIN				
	PASS	PASS	PASS	
DS MAX				
	2.50E+01	2.70E+01	2.70E+01	Ω
	PASS	PASS	PASS	

Figure A-88-1. S5 Ron vs. HDR TID for the RT6804HG-1.

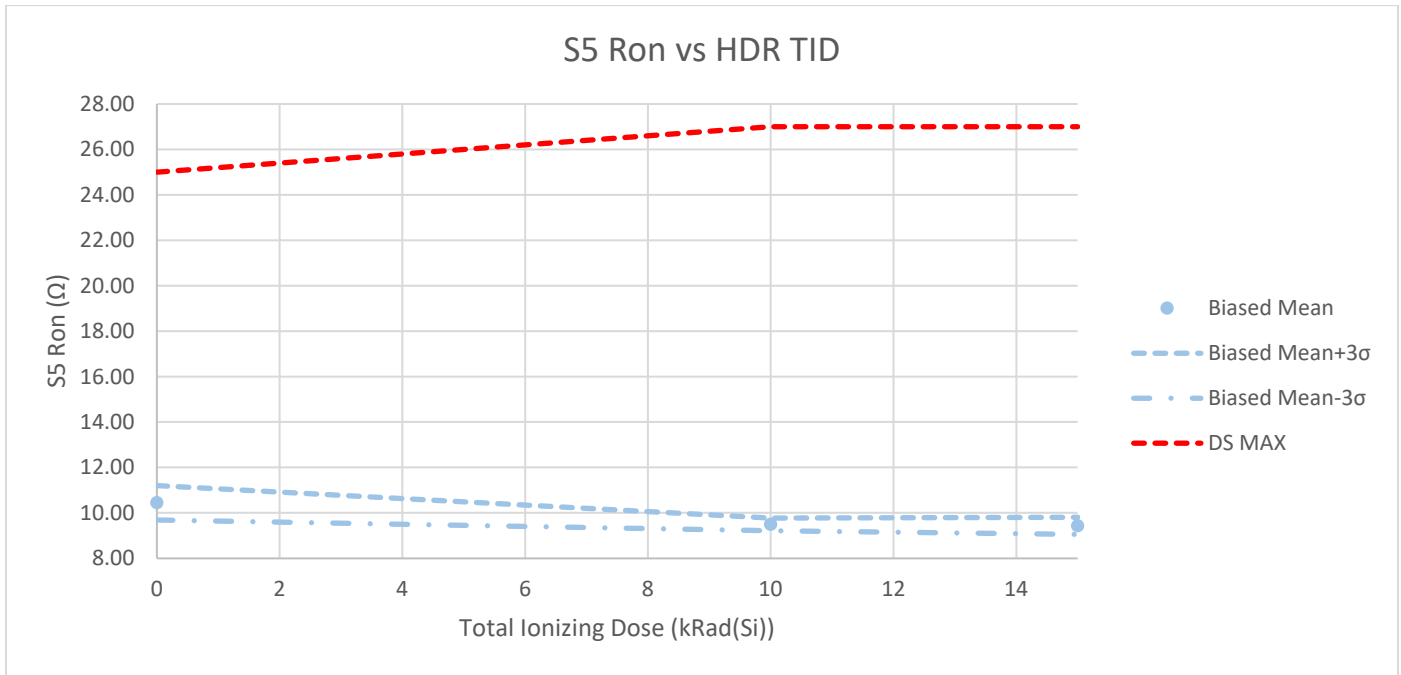

Table A-88-1. S5 Ron vs. HDR TID for the RT6804HG-1.

HDR TID Biased				
Total Ionizing Dose (kRad(Si))	0	10	15	Units
Biased Mean	10.4452	9.4927	9.4297	Ω
Std Dev	0.2515	0.0939	0.1253	
Biased Mean+3σ	11.1997	9.7744	9.8055	
Biased Mean-3σ	9.6908	9.2110	9.0539	
DS MIN				
	PASS	PASS	PASS	
DS MAX	2.50E+01	2.70E+01	2.70E+01	Ω
	PASS	PASS	PASS	

Figure A-88-2. S5 Ron vs. LDR TID for the RT6804HG-1.

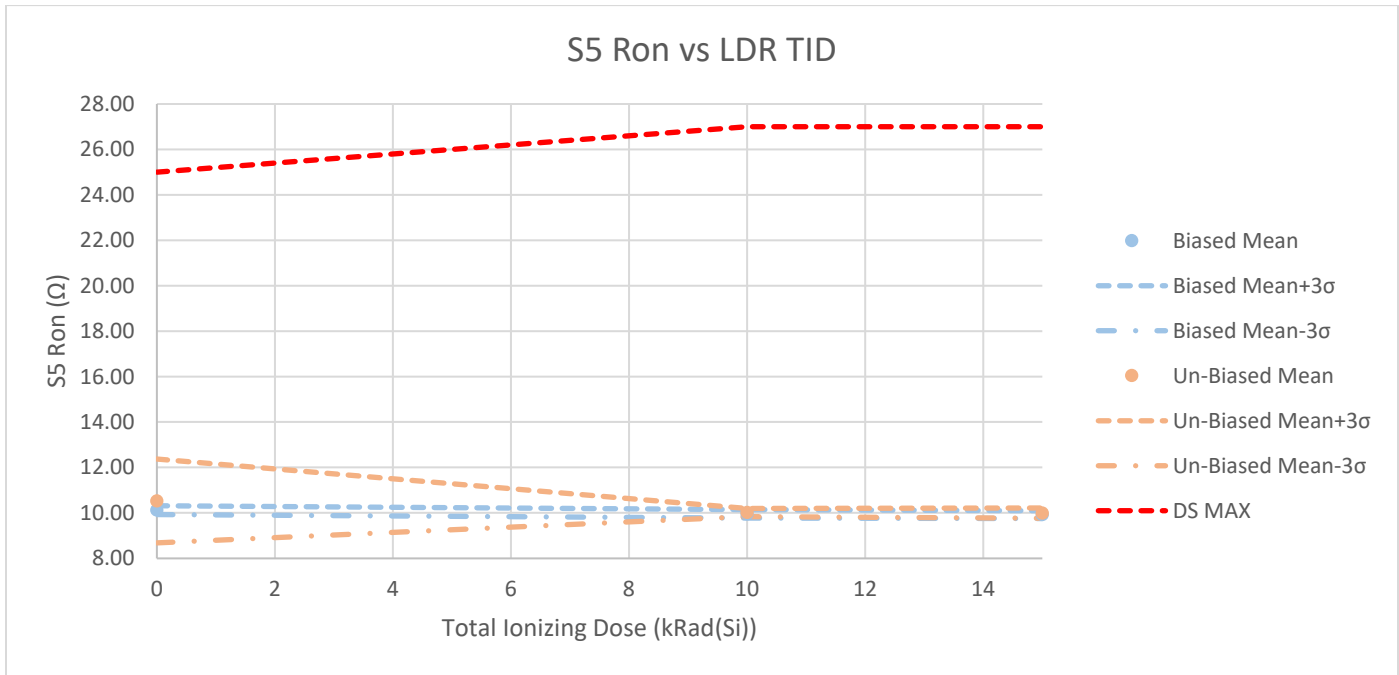

Table A-88-2. S5 Ron vs. LDR TID for the RT6804HG-1.

Total Ionizing Dose (kRad(Si))	0	10	15	Units
LDR TID Biased				
Biased Mean	10.1229	9.9563	9.9273	Ω
Std Dev	0.0639	0.0630	0.0577	
Biased Mean+3σ	10.3147	10.1451	10.1004	
Biased Mean-3σ	9.9311	9.7674	9.7542	
LDR TID Un-Biased				
Un-Biased Mean	10.5268	10.0174	9.9901	Ω
Std Dev	0.6156	0.0597	0.0756	
Un-Biased Mean+3σ	12.3737	10.1966	10.2168	
Un-Biased Mean-3σ	8.6800	9.8383	9.7634	
DS MIN				
	PASS	PASS	PASS	
DS MAX				
	2.50E+01	2.70E+01	2.70E+01	Ω
	PASS	PASS	PASS	

Figure A-89-1. S6 Ron vs. HDR TID for the RT6804HG-1.

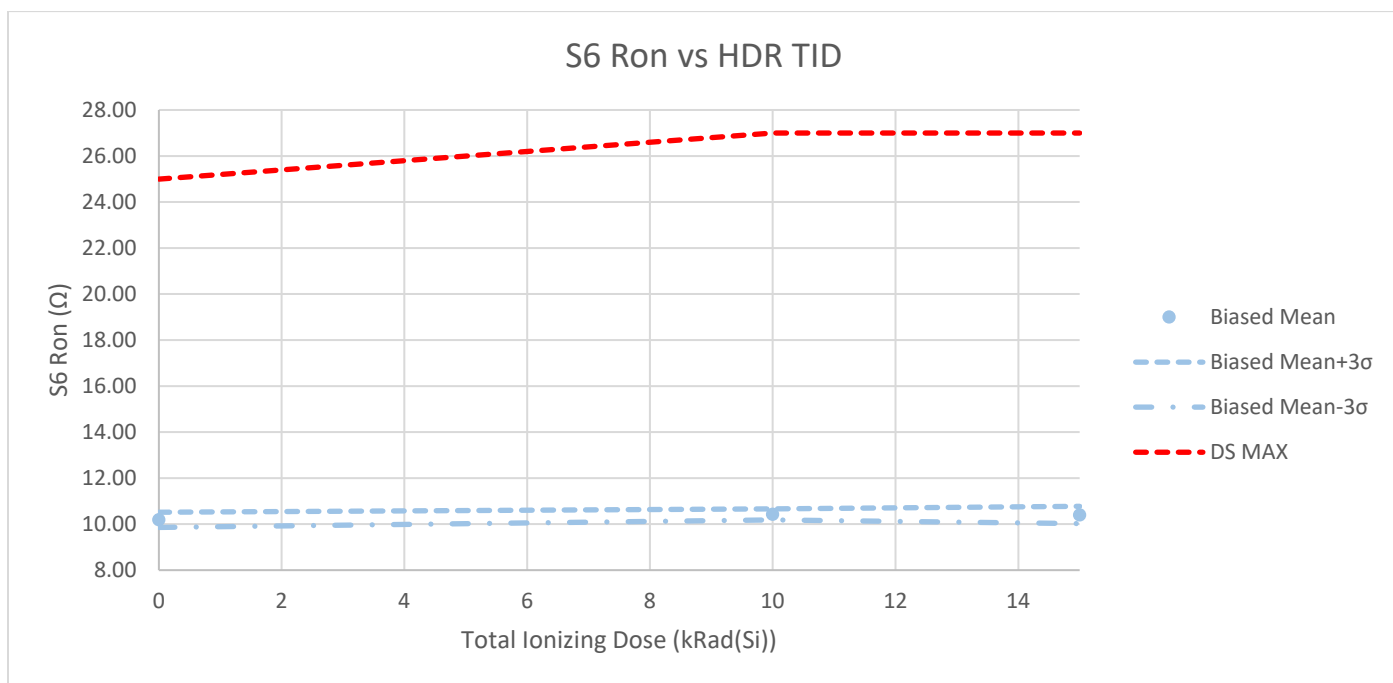

Table A-89-1. S6 Ron vs. HDR TID for the RT6804HG-1.

HDR TID Biased				
Total Ionizing Dose (kRad(Si))	0	10	15	Units
Biased Mean	10.1924	10.4249	10.4015	Ω
Std Dev	0.1098	0.0804	0.1253	
Biased Mean+3σ	10.5218	10.6661	10.7774	
Biased Mean-3σ	9.8630	10.1838	10.0256	
DS MIN				
	PASS	PASS	PASS	
DS MAX	2.50E+01	2.70E+01	2.70E+01	Ω
	PASS	PASS	PASS	

Figure A-89-2. S6 Ron vs. LDR TID for the RT6804HG-1.

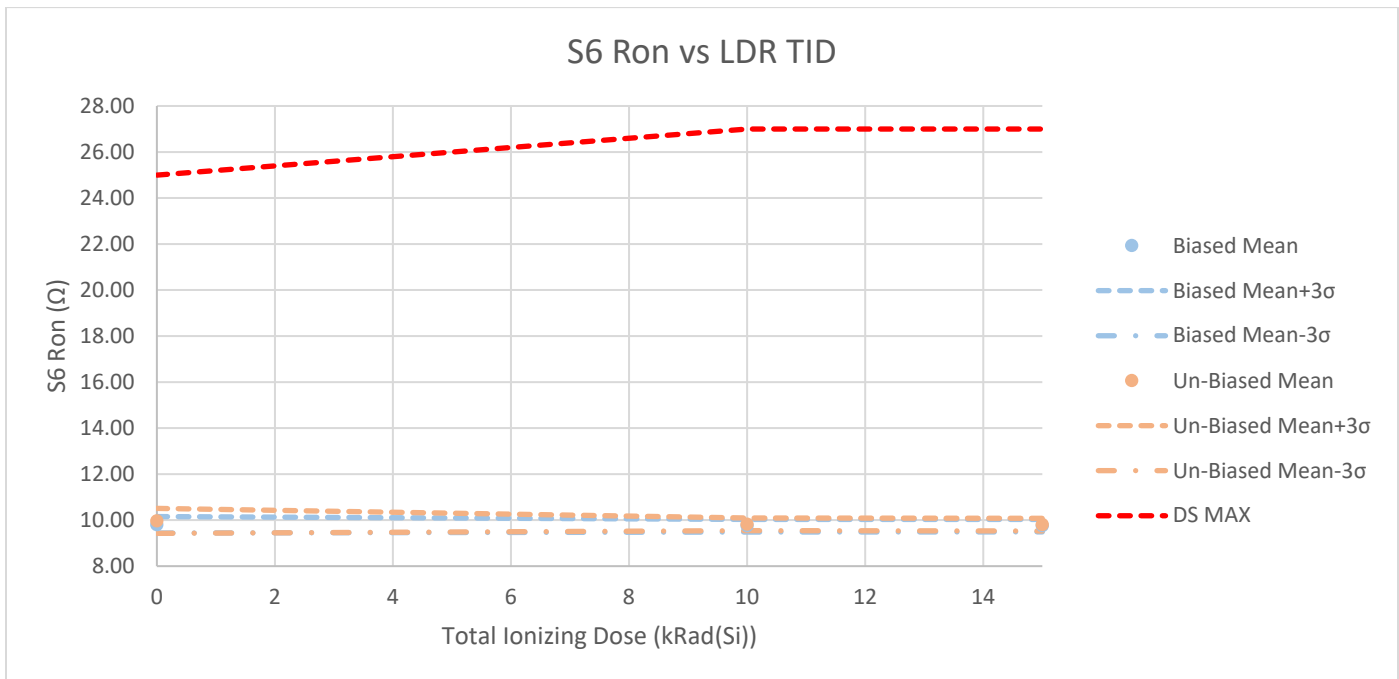

Table A-89-2. S6 Ron vs. LDR TID for the RT6804HG-1.

Total Ionizing Dose (kRad(Si))	0	10	15	Units
LDR TID Biased				
Biased Mean	9.7991	9.7573	9.7619	Ω
Std Dev	0.1187	0.0917	0.0901	
Biased Mean+3σ	10.1552	10.0324	10.0322	
Biased Mean-3σ	9.4430	9.4823	9.4916	
LDR TID Un-Biased				
Un-Biased Mean	9.9708	9.8198	9.8046	Ω
Std Dev	0.1809	0.0911	0.0921	
Un-Biased Mean+3σ	10.5134	10.0932	10.0809	
Un-Biased Mean-3σ	9.4281	9.5465	9.5283	
DS MIN				
	PASS	PASS	PASS	
DS MAX				
	2.50E+01	2.70E+01	2.70E+01	Ω
	PASS	PASS	PASS	

Figure A-90-1. S7 Ron vs. HDR TID for the RT6804HG-1.

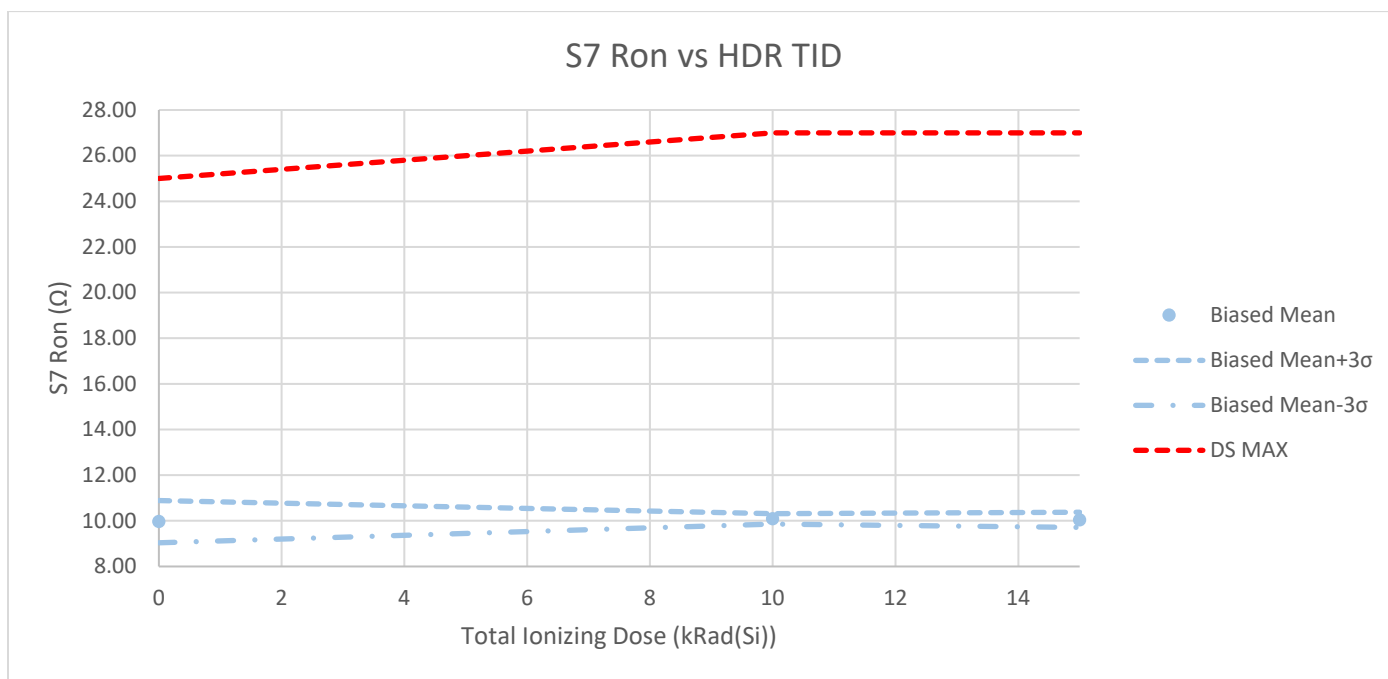

Table A-90-1. S7 Ron vs. HDR TID for the RT6804HG-1.

HDR TID Biased				
Total Ionizing Dose (kRad(Si))	0	10	15	Units
Biased Mean	9.9643	10.0856	10.0406	Ω
Std Dev	0.3081	0.0764	0.1120	
Biased Mean+3σ	10.8887	10.3147	10.3767	
Biased Mean-3σ	9.0400	9.8565	9.7045	
DS MIN				
	PASS	PASS	PASS	
DS MAX				Ω
	PASS	PASS	PASS	

Figure A-90-2. S7 Ron vs. LDR TID for the RT6804HG-1.

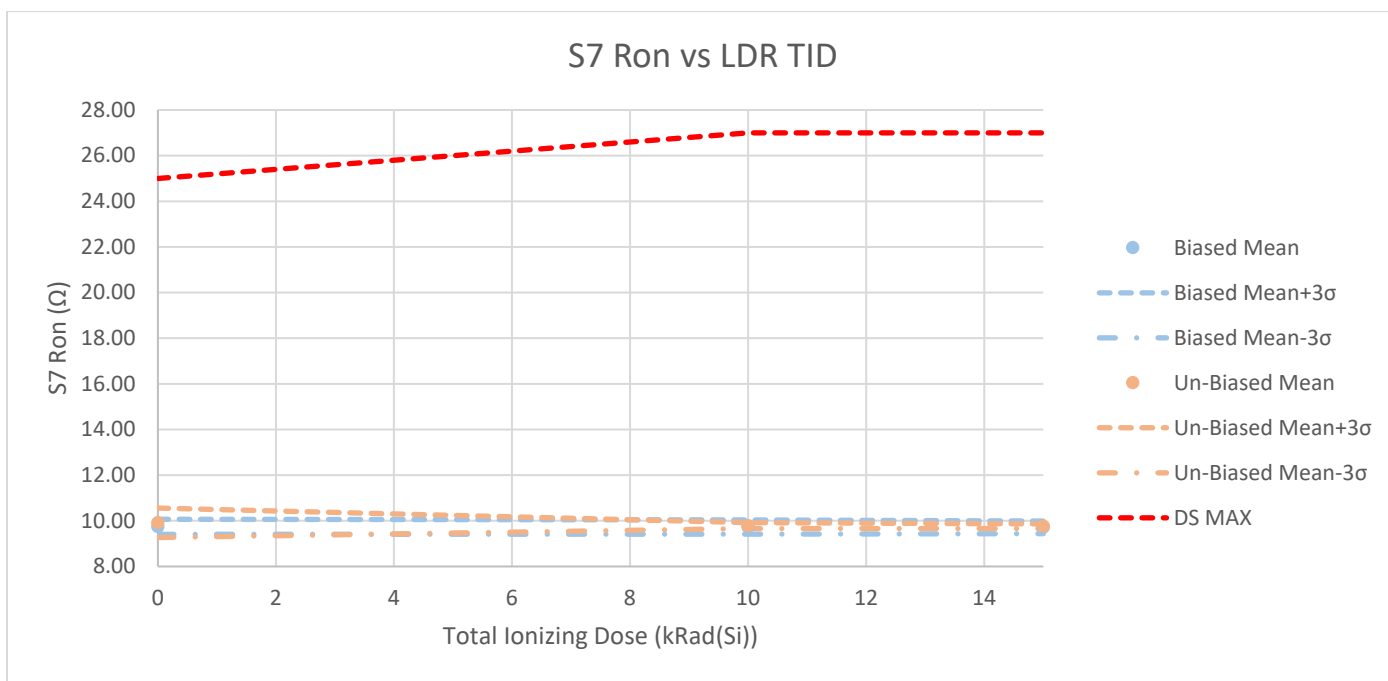

Table A-90-2. S7 Ron vs. LDR TID for the RT6804HG-1.

Total Ionizing Dose (kRad(Si))	0	10	15	Units
LDR TID Biased				
Biased Mean	9.7407	9.7269	9.7147	Ω
Std Dev	0.1096	0.1041	0.0927	
Biased Mean+3σ	10.0694	10.0391	9.9927	
Biased Mean-3σ	9.4119	9.4146	9.4367	
LDR TID Un-Biased				
Un-Biased Mean	9.9151	9.7877	9.7626	Ω
Std Dev	0.2142	0.0424	0.0339	
Un-Biased Mean+3σ	10.5577	9.9150	9.8643	
Un-Biased Mean-3σ	9.2726	9.6604	9.6609	
DS MIN				
	PASS	PASS	PASS	
DS MAX				
	2.50E+01	2.70E+01	2.70E+01	Ω
	PASS	PASS	PASS	

Figure A-91-1. S8 Ron vs. HDR TID for the RT6804HG-1.

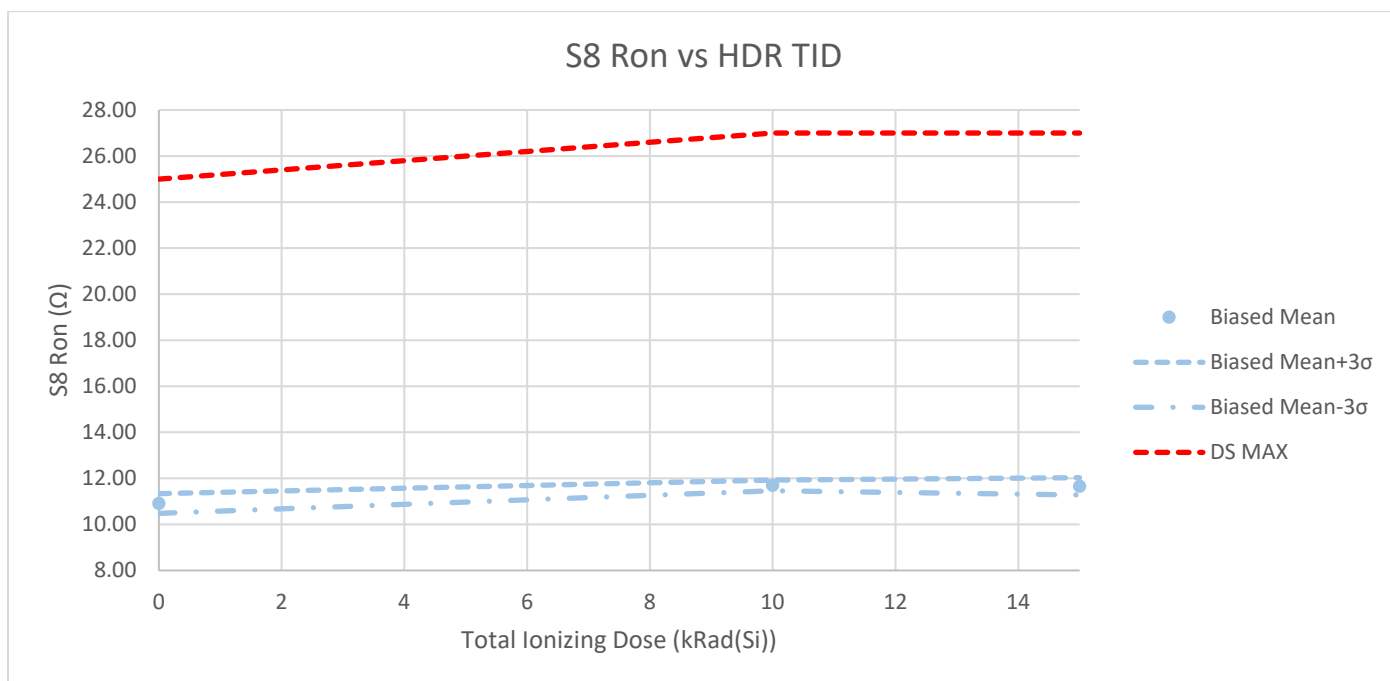

Table A-91-1. S8 Ron vs. HDR TID for the RT6804HG-1.

HDR TID Biased				
Total Ionizing Dose (kRad(Si))	0	10	15	Units
Biased Mean	10.9074	11.6936	11.6541	Ω
Std Dev	0.1419	0.0770	0.1259	
Biased Mean+3σ	11.3332	11.9245	12.0318	
Biased Mean-3σ	10.4816	11.4627	11.2763	
DS MIN				
	PASS	PASS	PASS	
DS MAX	2.50E+01	2.70E+01	2.70E+01	Ω
	PASS	PASS	PASS	

Figure A-91-2. S8 Ron vs. LDR TID for the RT6804HG-1.

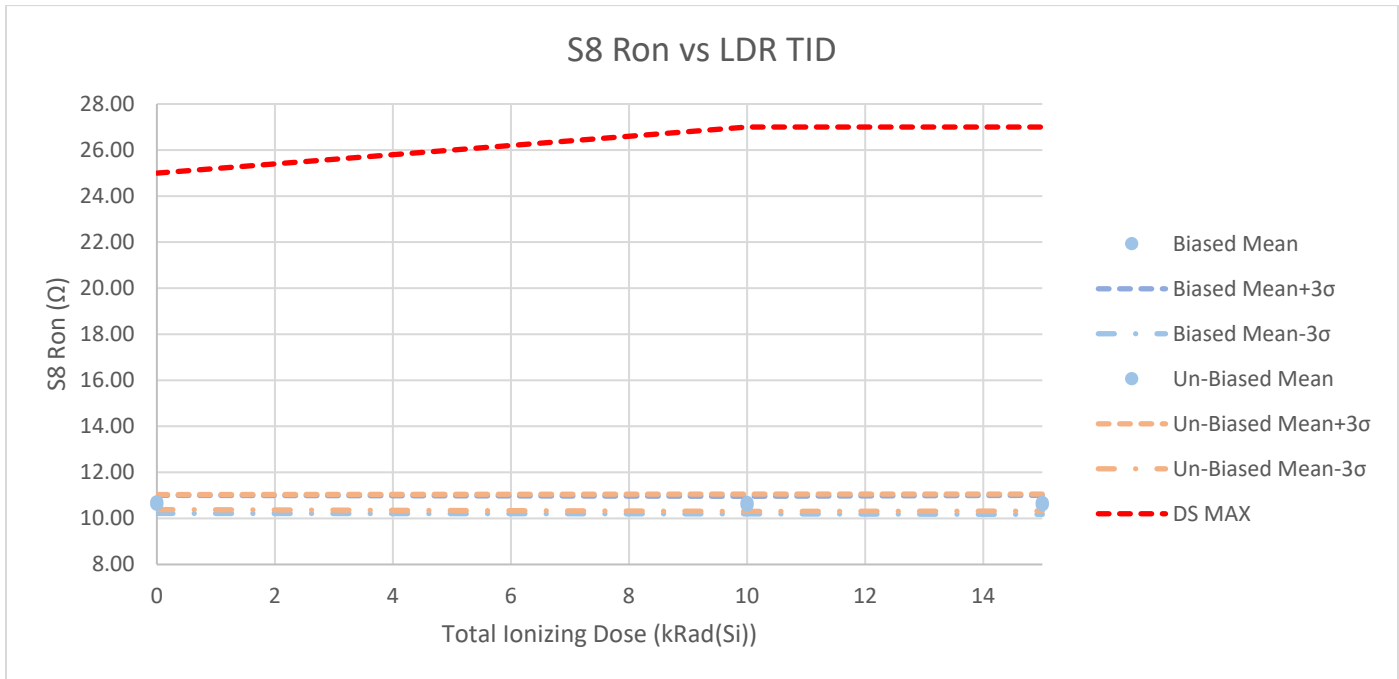

Table A-91-2. S8 Ron vs. LDR TID for the RT6804HG-1.

Total Ionizing Dose (kRad(Si))	0	10	15	Units
LDR TID Biased				
Biased Mean	10.6089	10.5791	10.5876	Ω
Std Dev	0.1307	0.1282	0.1366	
Biased Mean+3σ	11.0010	10.9636	10.9975	
Biased Mean-3σ	10.2168	10.1946	10.1777	
LDR TID Un-Biased				
Un-Biased Mean	10.7126	10.6836	10.6874	Ω
Std Dev	0.1092	0.1259	0.1231	
Un-Biased Mean+3σ	11.0402	11.0612	11.0568	
Un-Biased Mean-3σ	10.3850	10.3060	10.3180	
DS MIN				
	PASS	PASS	PASS	
DS MAX				
	2.50E+01	2.70E+01	2.70E+01	Ω
	PASS	PASS	PASS	

Figure A-92-1. S9 Ron vs. HDR TID for the RT6804HG-1.

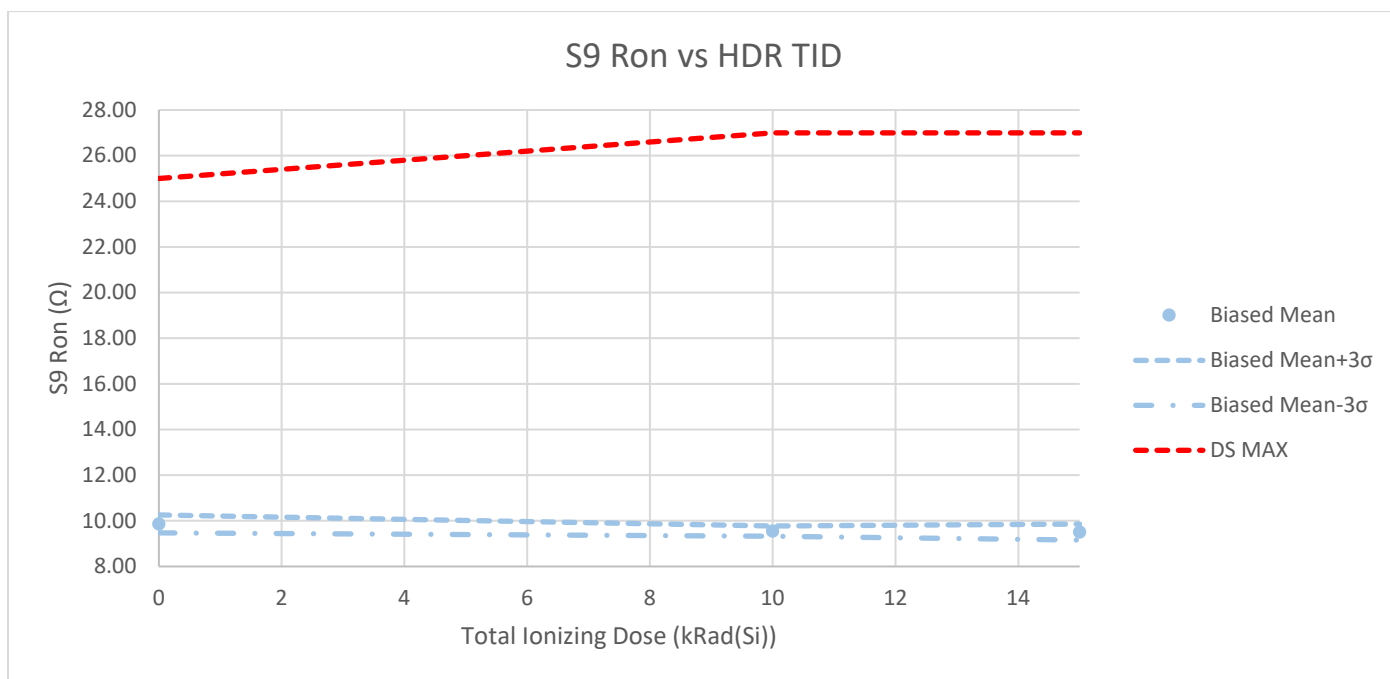

Table A-92-1. S9 Ron vs. HDR TID for the RT6804HG-1.

HDR TID Biased				
Total Ionizing Dose (kRad(Si))	0	10	15	Units
Biased Mean	9.8634	9.5488	9.5063	Ω
Std Dev	0.1306	0.0752	0.1161	
Biased Mean+3σ	10.2550	9.7742	9.8546	
Biased Mean-3σ	9.4717	9.3233	9.1580	
DS MIN	PASS	PASS	PASS	
DS MAX	2.50E+01	2.70E+01	2.70E+01	Ω
	PASS	PASS	PASS	

Figure A-92-2. S9 Ron vs. LDR TID for the RT6804HG-1.

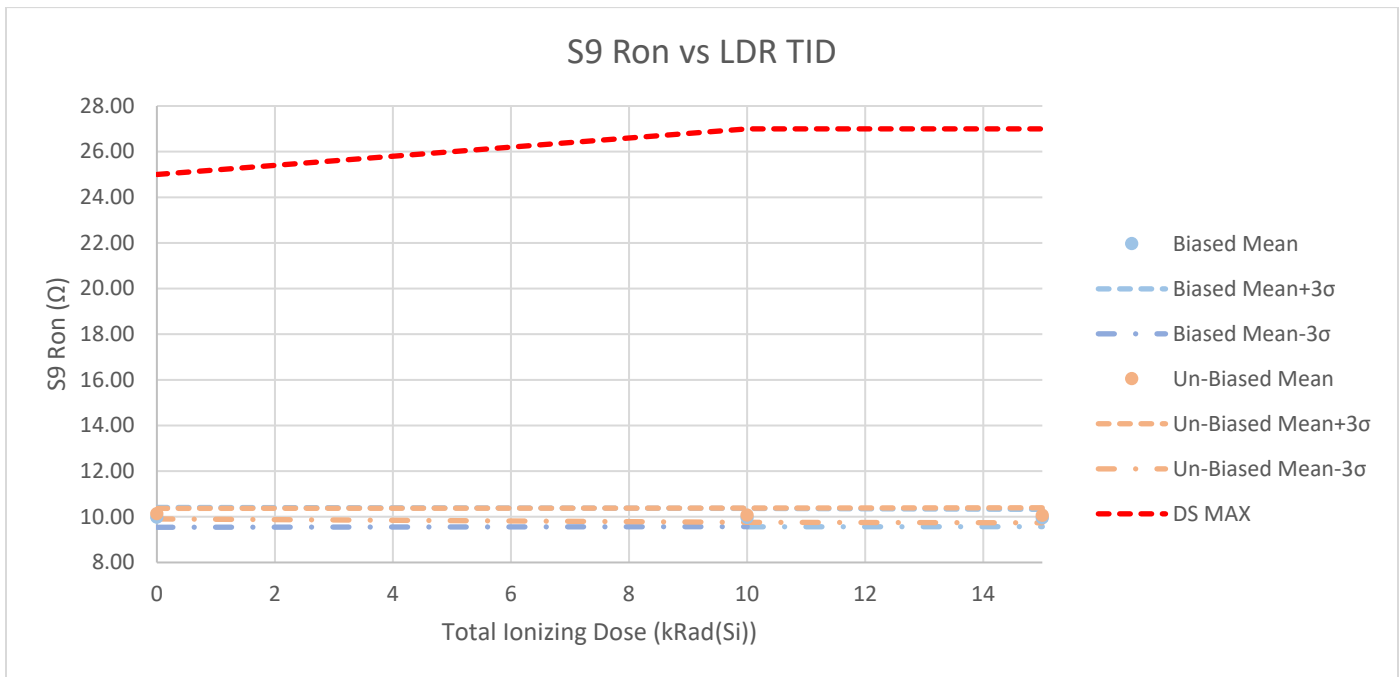

Table A-92-2. S9 Ron vs. LDR TID for the RT6804HG-1.

Total Ionizing Dose (kRad(Si))	0	10	15	Units
LDR TID Biased				
Biased Mean	9.9792	9.9646	9.9509	Ω
Std Dev	0.1445	0.1334	0.1262	
Biased Mean+3σ	10.4126	10.3649	10.3294	
Biased Mean-3σ	9.5457	9.5643	9.5723	
LDR TID Un-Biased				
Un-Biased Mean	10.1386	10.0691	10.0683	Ω
Std Dev	0.0767	0.1045	0.1097	
Un-Biased Mean+3σ	10.3686	10.3824	10.3972	
Un-Biased Mean-3σ	9.9085	9.7557	9.7393	
DS MIN				
	PASS	PASS	PASS	
DS MAX				
	2.50E+01	2.70E+01	2.70E+01	Ω
	PASS	PASS	PASS	

Figure A-93-1. S10 Ron vs. HDR TID for the RT6804HG-1.

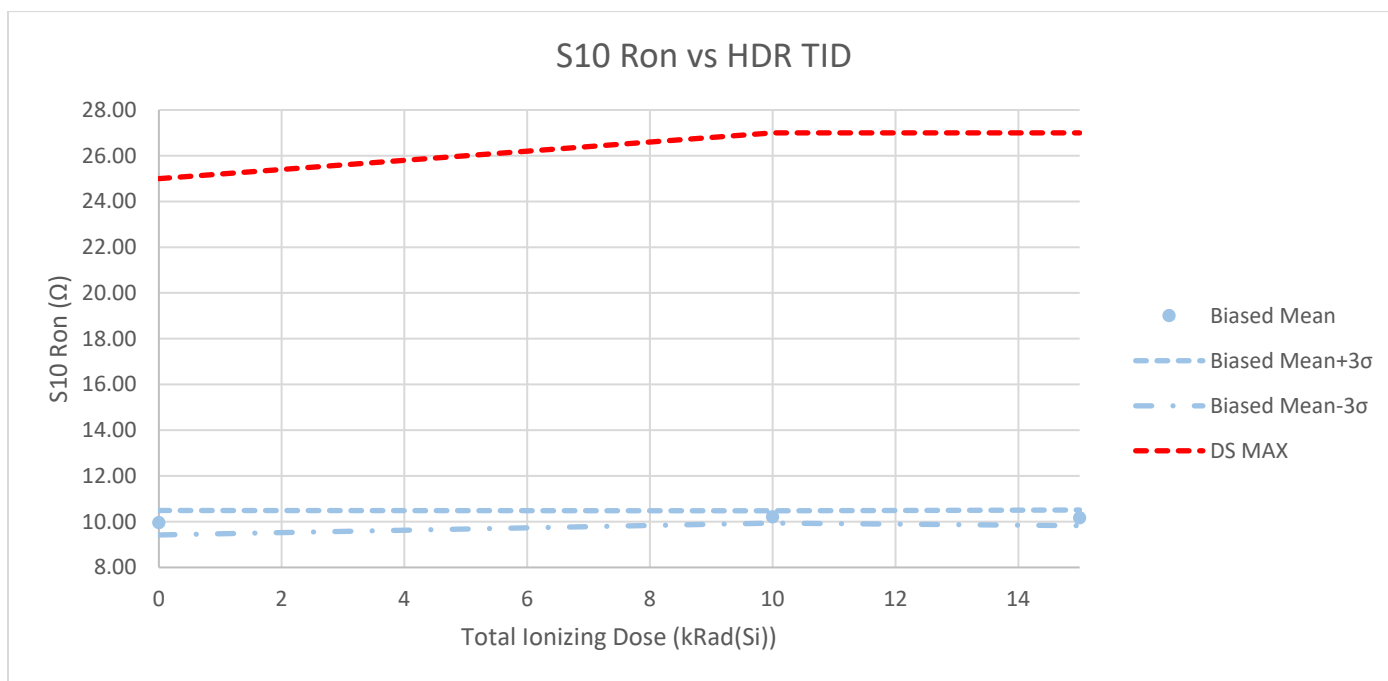

Table A-93-1. S10 Ron vs. HDR TID for the RT6804HG-1.

HDR TID Biased				
Total Ionizing Dose (kRad(Si))	0	10	15	Units
Biased Mean	9.9523	10.2042	10.1665	Ω
Std Dev	0.1775	0.0897	0.1150	
Biased Mean+3σ	10.4847	10.4733	10.5114	
Biased Mean-3σ	9.4199	9.9350	9.8215	
DS MIN				
	PASS	PASS	PASS	
DS MAX				Ω
	PASS	PASS	PASS	

Figure A-93-2. S10 Ron vs. LDR TID for the RT6804HG-1.

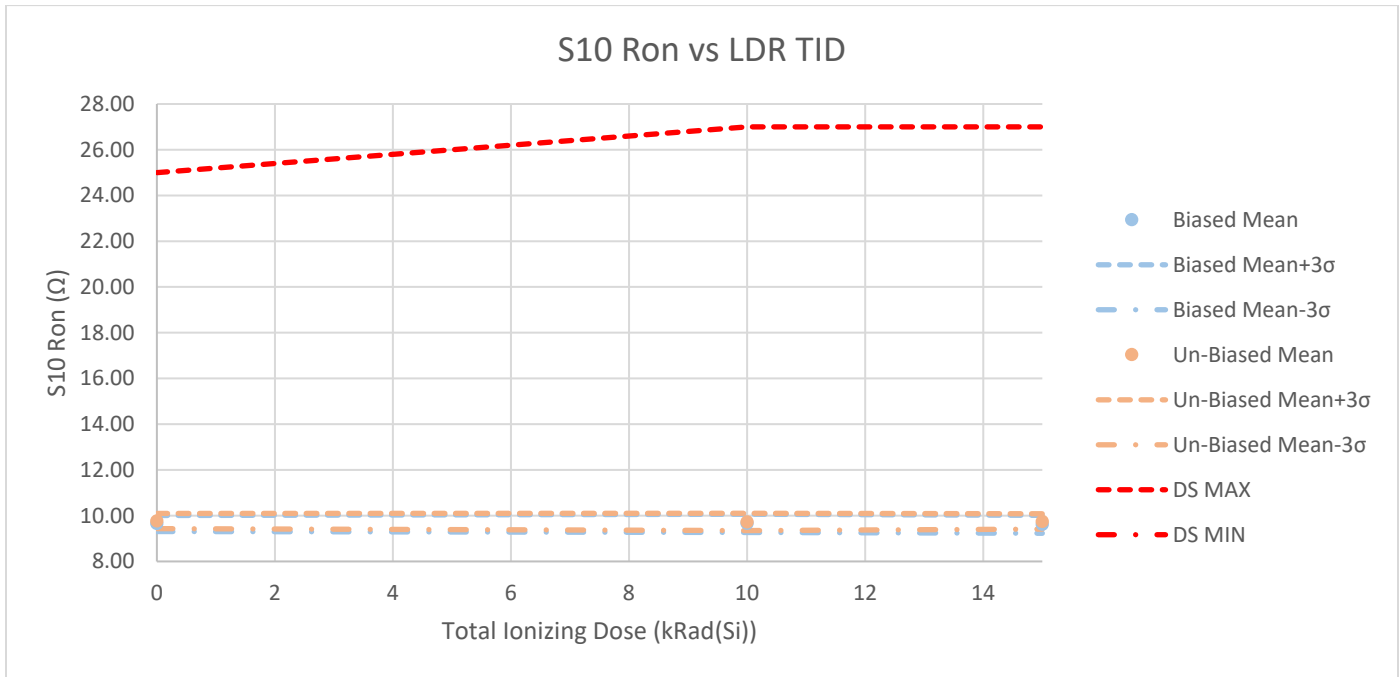

Table A-93-2. S10 Ron vs. LDR TID for the RT6804HG-1.

Total Ionizing Dose (kRad(Si))	0	10	15	Units
LDR TID Biased				
Biased Mean	9.6571	9.6637	9.6218	Ω
Std Dev	0.1170	0.1328	0.1294	
Biased Mean+3σ	10.0081	10.0622	10.0100	
Biased Mean-3σ	9.3060	9.2651	9.2336	
LDR TID Un-Biased				
Un-Biased Mean	9.7629	9.7268	9.7459	Ω
Std Dev	0.1096	0.1263	0.1121	
Un-Biased Mean+3σ	10.0916	10.1056	10.0822	
Un-Biased Mean-3σ	9.4341	9.3480	9.4095	
DS MIN				
DS MIN				
	PASS	PASS	PASS	
DS MAX				
DS MAX	2.50E+01	2.70E+01	2.70E+01	Ω
	PASS	PASS	PASS	

Figure A-94-1. S11 Ron vs. HDR TID for the RT6804HG-1.

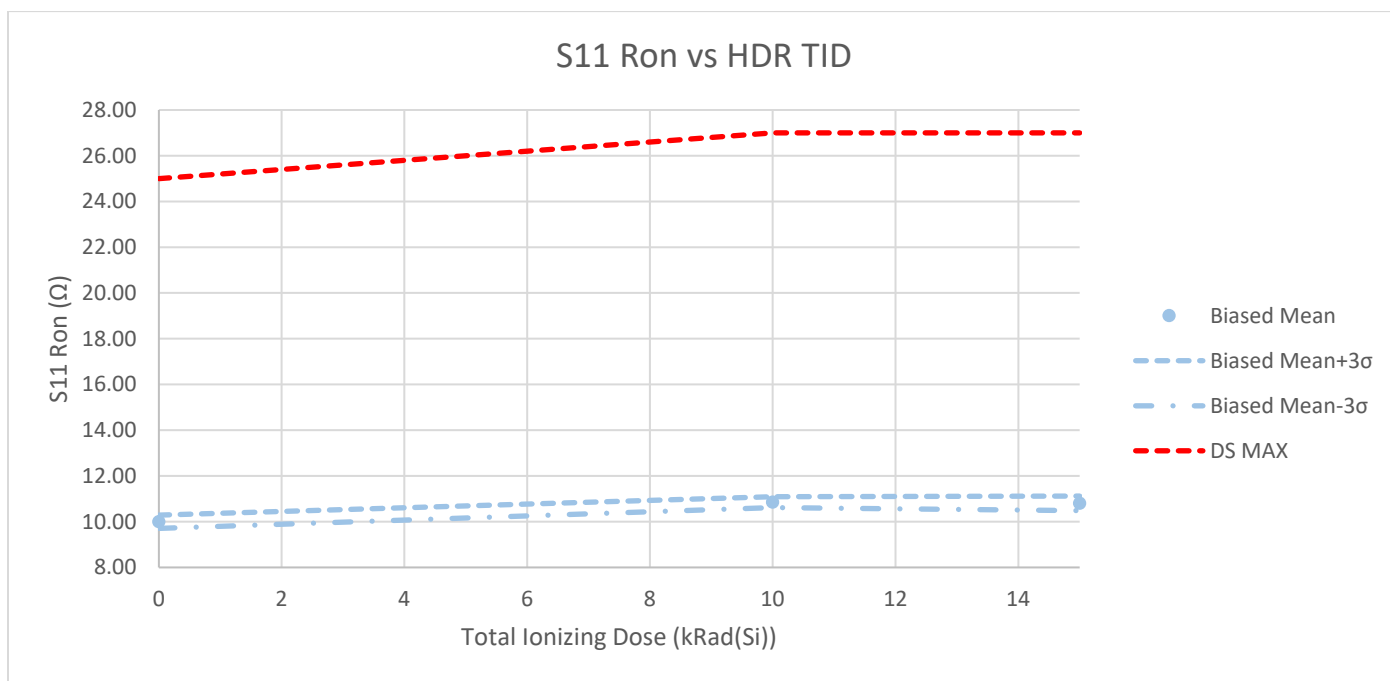

Table A-94-1. S11 Ron vs. HDR TID for the RT6804HG-1.

HDR TID Biased				
Total Ionizing Dose (kRad(Si))	0	10	15	Units
Biased Mean	9.9955	10.8524	10.7989	Ω
Std Dev	0.0974	0.0787	0.1066	
Biased Mean+3σ	10.2879	11.0885	11.1186	
Biased Mean-3σ	9.7032	10.6163	10.4791	
DS MIN				
	PASS	PASS	PASS	
DS MAX				Ω
	PASS	PASS	PASS	

Figure A-94-2. S11 Ron vs. LDR TID for the RT6804HG-1.

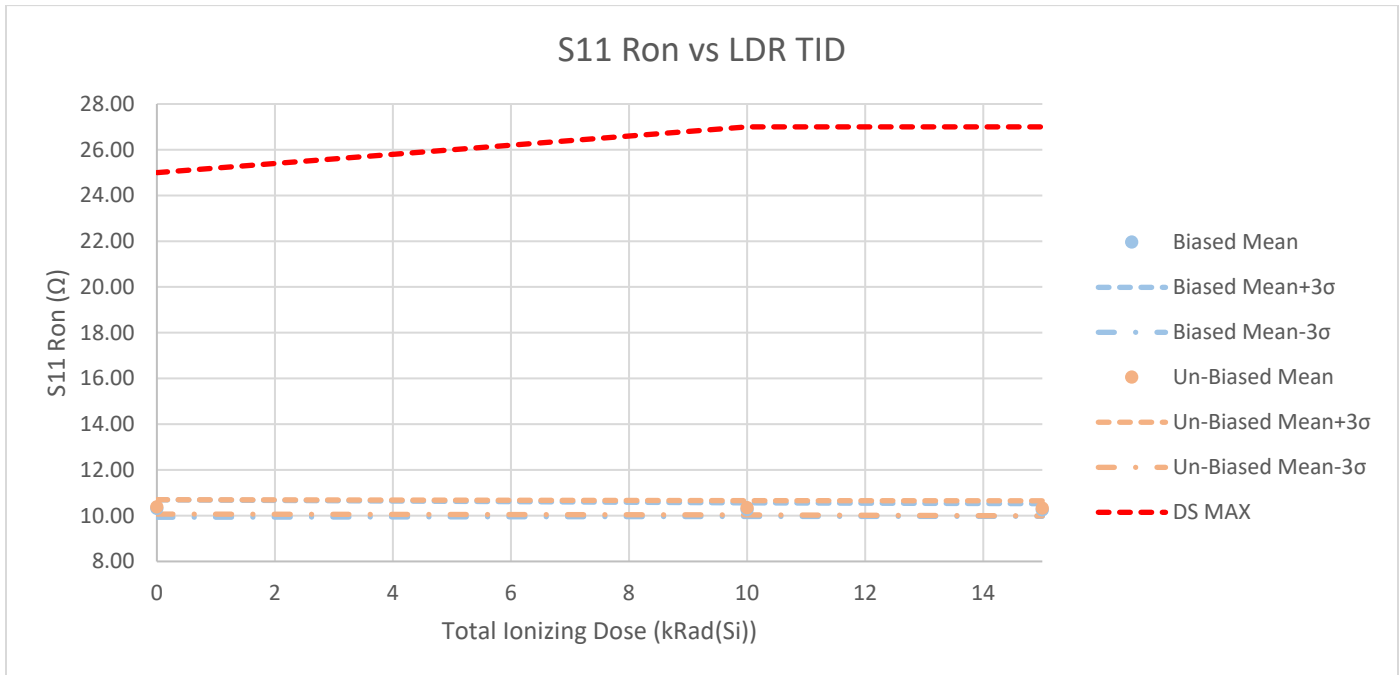

Table A-94-2. S11 Ron vs. LDR TID for the RT6804HG-1.

Total Ionizing Dose (kRad(Si))	0	10	15	Units
LDR TID Biased				
Biased Mean	10.3117	10.2624	10.2479	Ω
Std Dev	0.1278	0.0979	0.0931	
Biased Mean+3σ	10.6951	10.5562	10.5273	
Biased Mean-3σ	9.9283	9.9686	9.9685	
LDR TID Un-Biased				
Un-Biased Mean	10.3829	10.3435	10.3244	Ω
Std Dev	0.1052	0.1033	0.1094	
Un-Biased Mean+3σ	10.6985	10.6535	10.6525	
Un-Biased Mean-3σ	10.0673	10.0335	9.9963	
DS MIN				
	PASS	PASS	PASS	
DS MAX				
	2.50E+01	2.70E+01	2.70E+01	Ω
	PASS	PASS	PASS	

Figure A-95-1. S12 Ron vs. HDR TID for the RT6804HG-1.

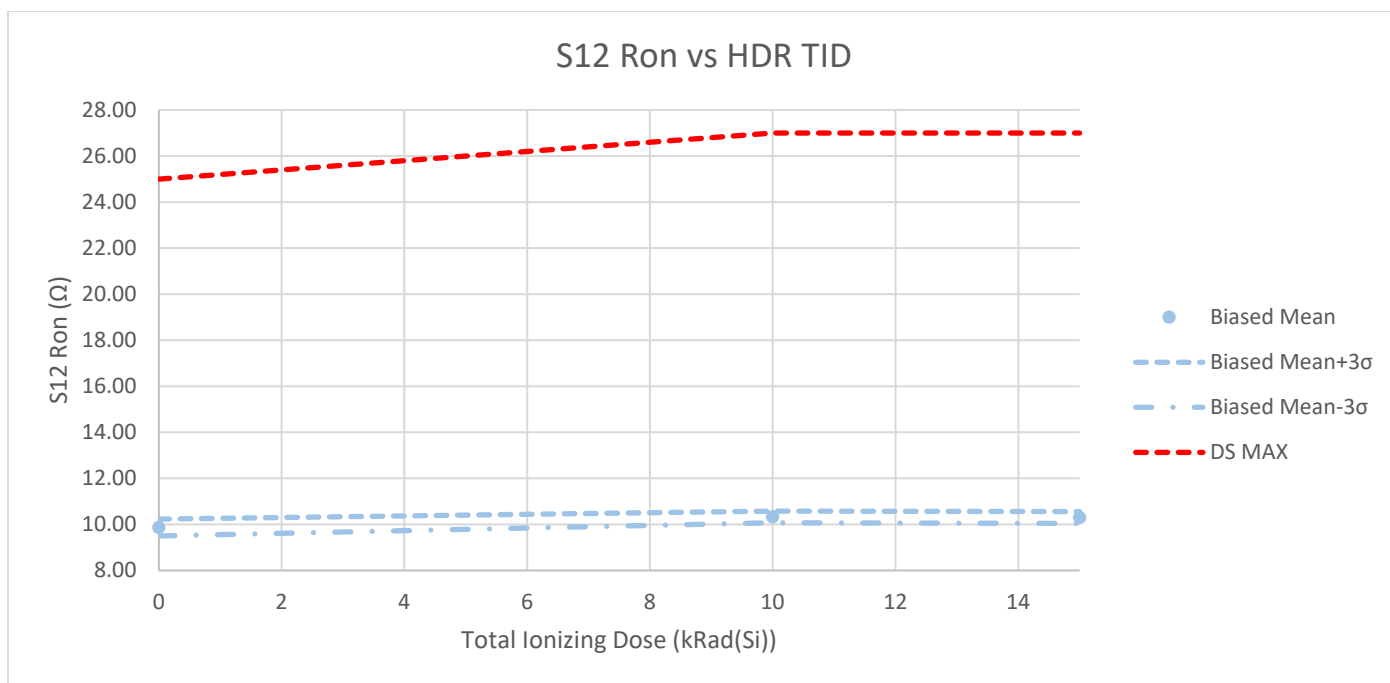

Table A-95-1. S12 Ron vs. HDR TID for the RT6804HG-1.

HDR TID Biased				
Total Ionizing Dose (kRad(Si))	0	10	15	Units
Biased Mean	9.8670	10.3246	10.3006	Ω
Std Dev	0.1212	0.0837	0.0857	
Biased Mean+3σ	10.2306	10.5756	10.5576	
Biased Mean-3σ	9.5033	10.0735	10.0436	
DS MIN				
	PASS	PASS	PASS	
DS MAX	2.50E+01	2.70E+01	2.70E+01	Ω
	PASS	PASS	PASS	

Figure A-95-2. S12 Ron vs. LDR TID for the RT6804HG-1.

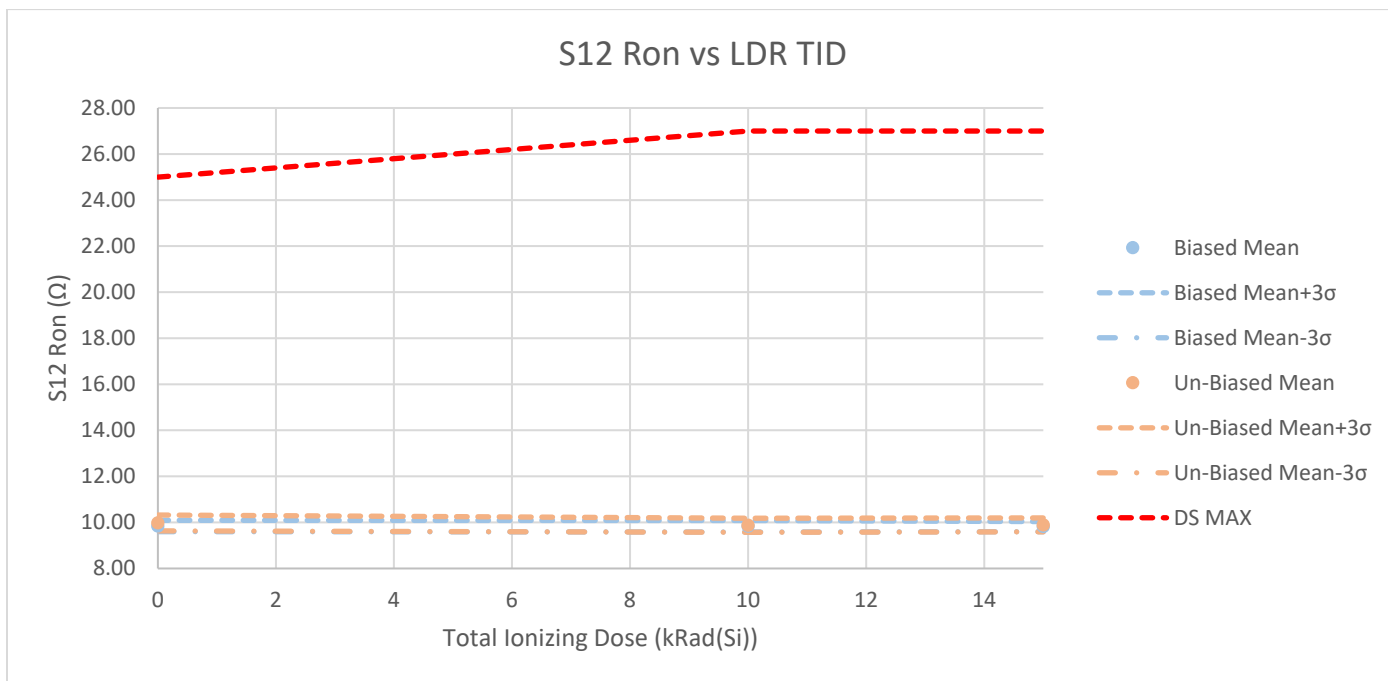

Table A-95-2. S12 Ron vs. LDR TID for the RT6804HG-1.

Total Ionizing Dose (kRad(Si))	0	10	15	Units
LDR TID Biased				
Biased Mean	9.8414	9.8333	9.8188	Ω
Std Dev	0.0830	0.0829	0.0734	
Biased Mean+3σ	10.0905	10.0819	10.0391	
Biased Mean-3σ	9.5923	9.5846	9.5984	
LDR TID Un-Biased				
Un-Biased Mean	9.9749	9.8760	9.8905	Ω
Std Dev	0.1145	0.1023	0.1002	
Un-Biased Mean+3σ	10.3185	10.1828	10.1910	
Un-Biased Mean-3σ	9.6314	9.5691	9.5899	
DS MIN				
	PASS	PASS	PASS	
DS MAX				
	2.50E+01	2.70E+01	2.70E+01	Ω
	PASS	PASS	PASS	

Figure A-96-1. CSB leakage @ 5V vs. HDR TID for the RT6804HG-1.

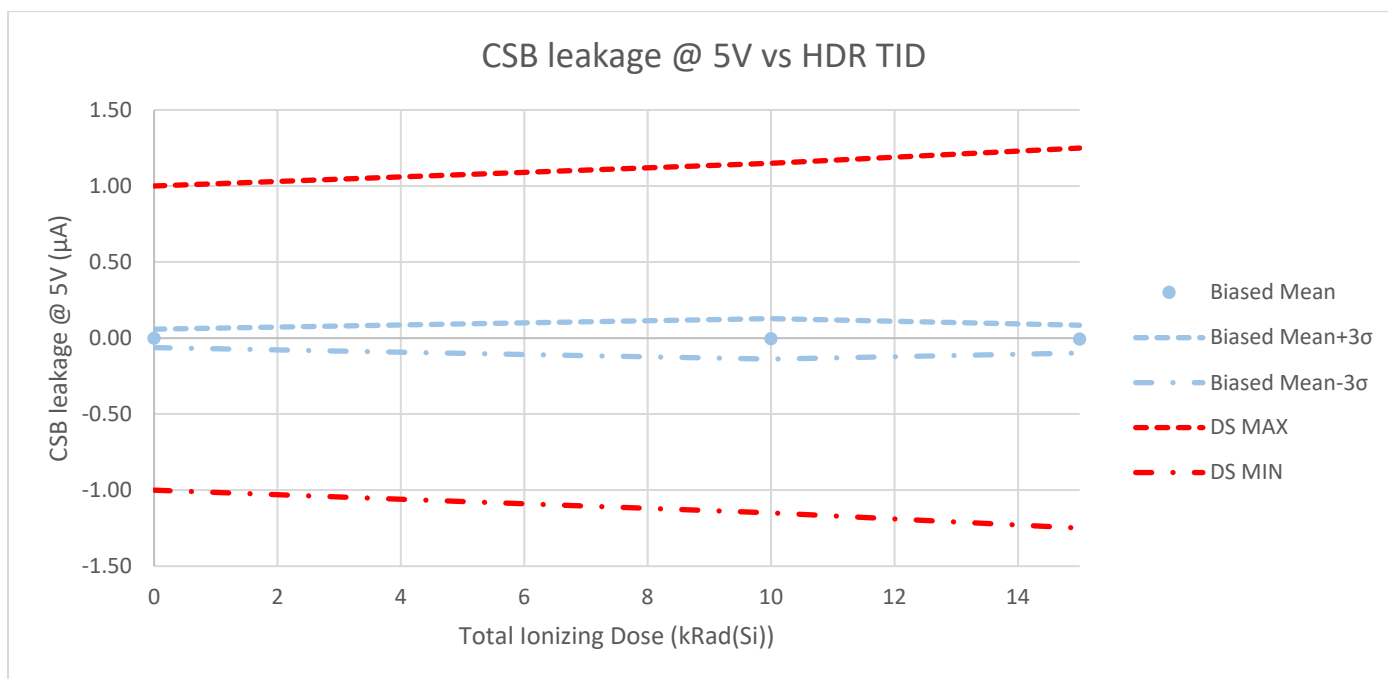

Table A-96-1. CSB leakage @ 5V vs. HDR TID for the RT6804HG-1.

HDR TID Biased				
Total Ionizing Dose (kRad(Si))	0	10	15	Units
Biased Mean	-0.0021	-0.0052	-0.0071	μA
Std Dev	0.0200	0.0445	0.0305	
Biased Mean+3σ	0.0580	0.1282	0.0845	
Biased Mean-3σ	-0.0622	-0.1386	-0.0987	
DS MIN	-1.00E+00	-1.15E+00	-1.25E+00	μA
	PASS	PASS	PASS	
DS MAX	1.00E+00	1.15E+00	1.25E+00	μA
	PASS	PASS	PASS	

Figure A-96-2. CSB leakage @ 5V vs. LDR TID for the RT6804HG-1.

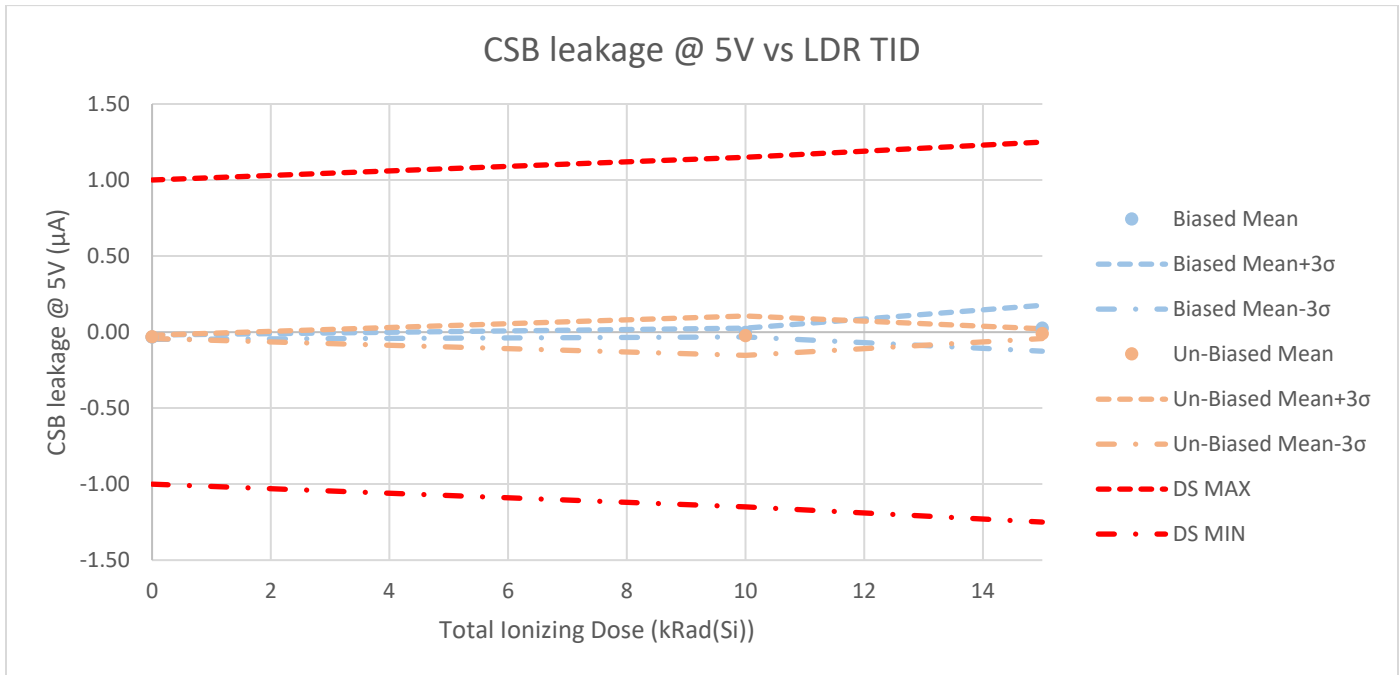

Table A-96-2. CSB leakage @ 5V vs. LDR TID for the RT6804HG-1.

Total Ionizing Dose (kRad(Si))	0	10	15	Units
LDR TID Biased				
Biased Mean	-0.0336	-0.0030	0.0254	µA
Std Dev	0.0048	0.0095	0.0504	
Biased Mean+3σ	-0.0191	0.0255	0.1765	
Biased Mean-3σ	-0.0480	-0.0316	-0.1257	
LDR TID Un-Biased				
Un-Biased Mean	-0.0317	-0.0240	-0.0110	µA
Std Dev	0.0037	0.0431	0.0106	
Un-Biased Mean+3σ	-0.0205	0.1054	0.0208	
Un-Biased Mean-3σ	-0.0429	-0.1535	-0.0427	
DS MIN				
DS MIN	-1.00E+00	-1.15E+00	-1.25E+00	µA
	PASS	PASS	PASS	
DS MAX				
DS MAX	1.00E+00	1.15E+00	1.25E+00	µA
	PASS	PASS	PASS	

Figure A-97-1. SCK leakage @ 5V vs. HDR TID for the RT6804HG-1.

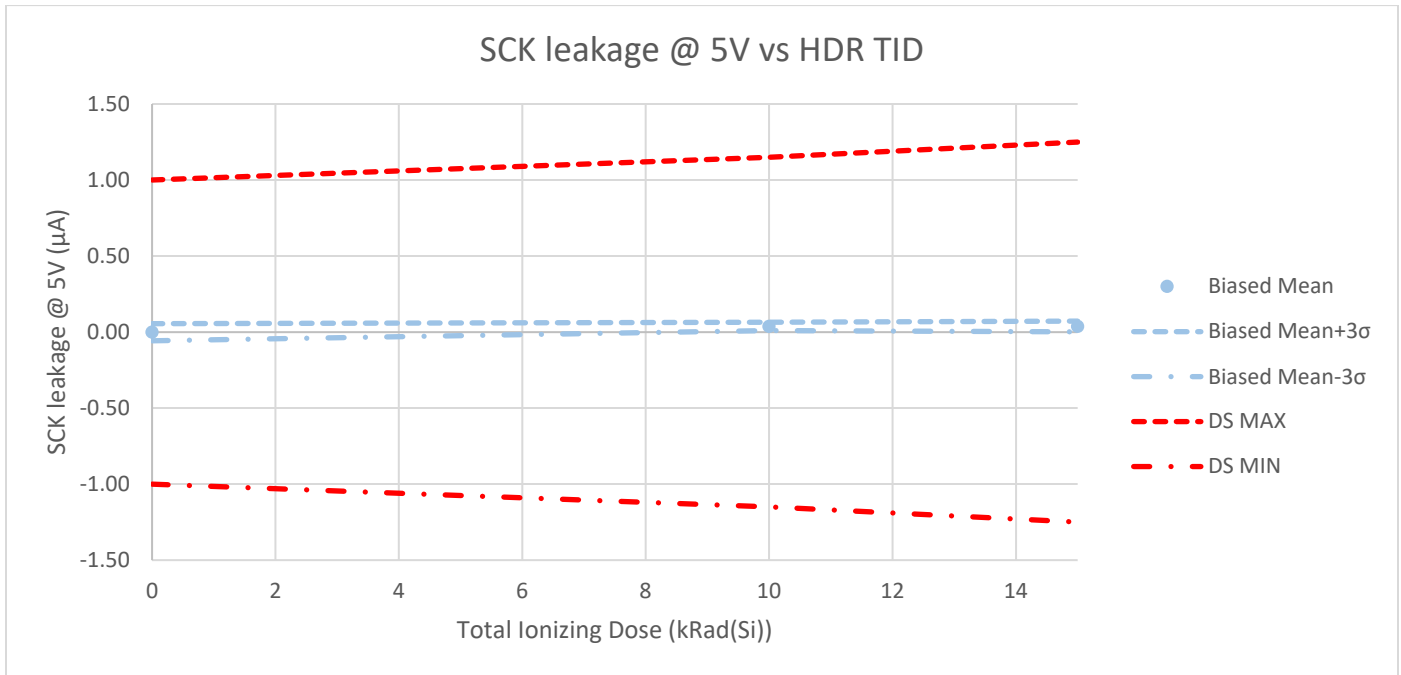

Table A-97-1. SCK leakage @ 5V vs. HDR TID for the RT6804HG-1.

HDR TID Biased				
Total Ionizing Dose (kRad(Si))	0	10	15	Units
Biased Mean	-0.0007	0.0371	0.0367	μA
Std Dev	0.0188	0.0089	0.0118	
Biased Mean+3σ	0.0557	0.0638	0.0722	
Biased Mean-3σ	-0.0571	0.0105	0.0011	
DS MIN	-1.00E+00	-1.15E+00	-1.25E+00	μA
	PASS	PASS	PASS	
DS MAX	1.00E+00	1.15E+00	1.25E+00	μA
	PASS	PASS	PASS	

Figure A-97-2. SCK leakage @ 5V vs. LDR TID for the RT6804HG-1.

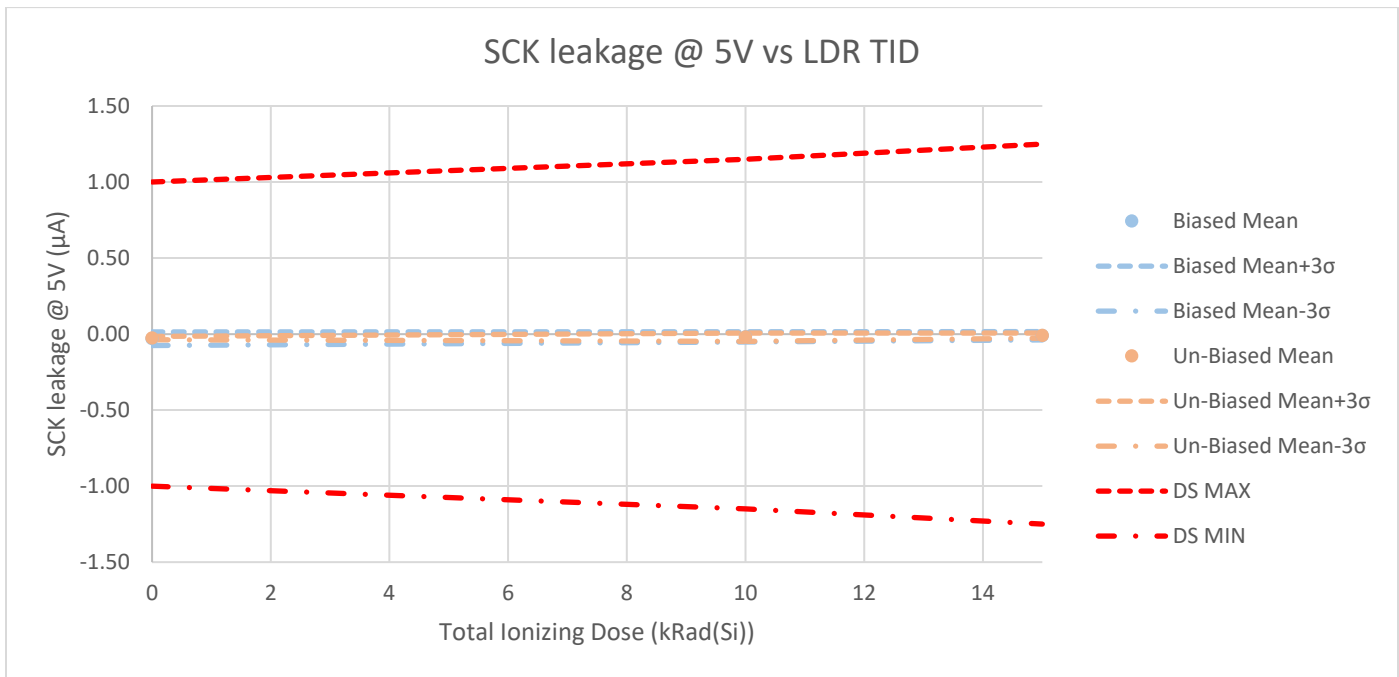

Table A-97-2. SCK leakage @ 5V vs. LDR TID for the RT6804HG-1.

Total Ionizing Dose (kRad(Si))	0	10	15	Units
LDR TID Biased				
Biased Mean	-0.0301	-0.0186	-0.0110	μA
Std Dev	0.0149	0.0112	0.0093	
Biased Mean+3 σ	0.0146	0.0149	0.0168	
Biased Mean-3 σ	-0.0748	-0.0521	-0.0388	
LDR TID Un-Biased				
Un-Biased Mean	-0.0265	-0.0204	-0.0097	μA
Std Dev	0.0038	0.0091	0.0056	
Un-Biased Mean+3 σ	-0.0150	0.0069	0.0071	
Un-Biased Mean-3 σ	-0.0380	-0.0476	-0.0264	
DS Limits				
DS MIN	-1.00E+00	-1.15E+00	-1.25E+00	μA
	PASS	PASS	PASS	
DS MAX	1.00E+00	1.15E+00	1.25E+00	μA
	PASS	PASS	PASS	

Figure A-98-1. SDI leakage @ 5V vs. HDR TID for the RT6804HG-1.

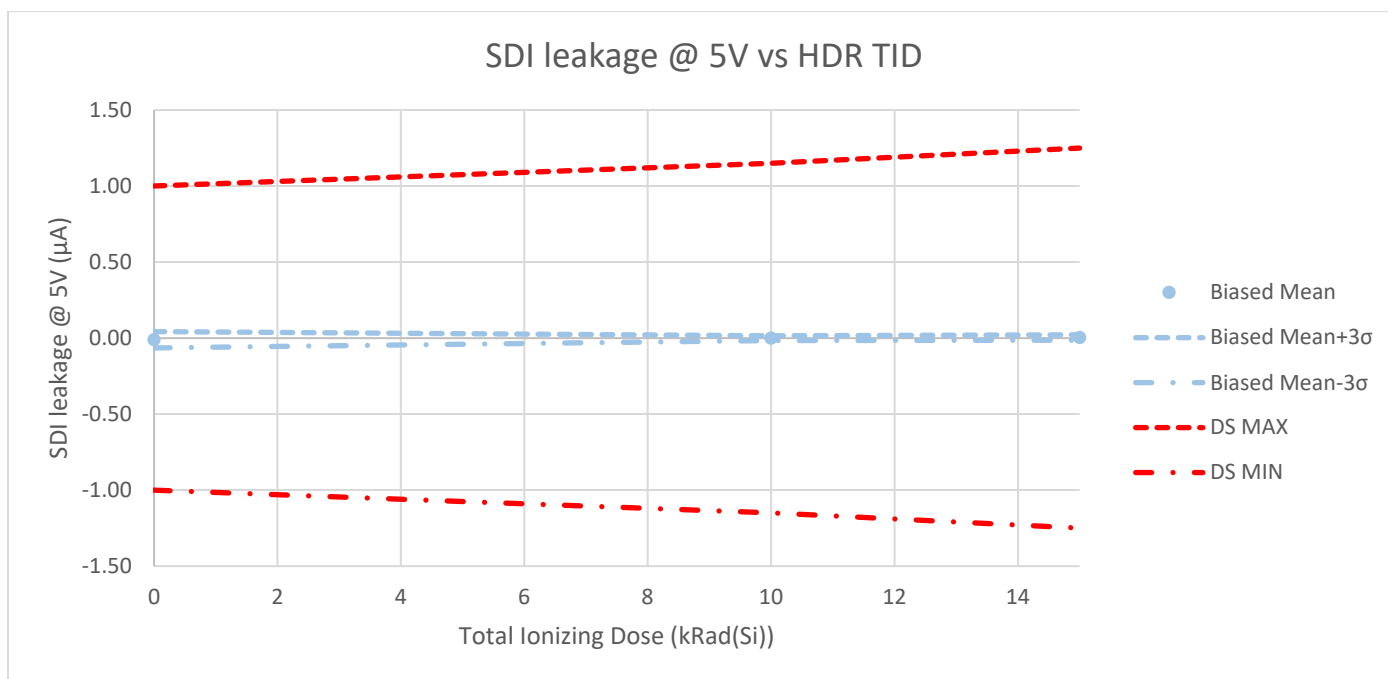

Table A-98-1. SDI leakage @ 5V vs. HDR TID for the RT6804HG-1.

HDR TID Biased				
Total Ionizing Dose (kRad(Si))	0	10	15	Units
Biased Mean	-0.0114	-0.0005	0.0036	µA
Std Dev	0.0179	0.0053	0.0059	
Biased Mean+3σ	0.0422	0.0154	0.0212	
Biased Mean-3σ	-0.0650	-0.0165	-0.0140	
DS MIN	-1.00E+00	-1.15E+00	-1.25E+00	µA
	PASS	PASS	PASS	
DS MAX	1.00E+00	1.15E+00	1.25E+00	µA
	PASS	PASS	PASS	

Figure A-98-2. SDI leakage @ 5V vs. LDR TID for the RT6804HG-1.

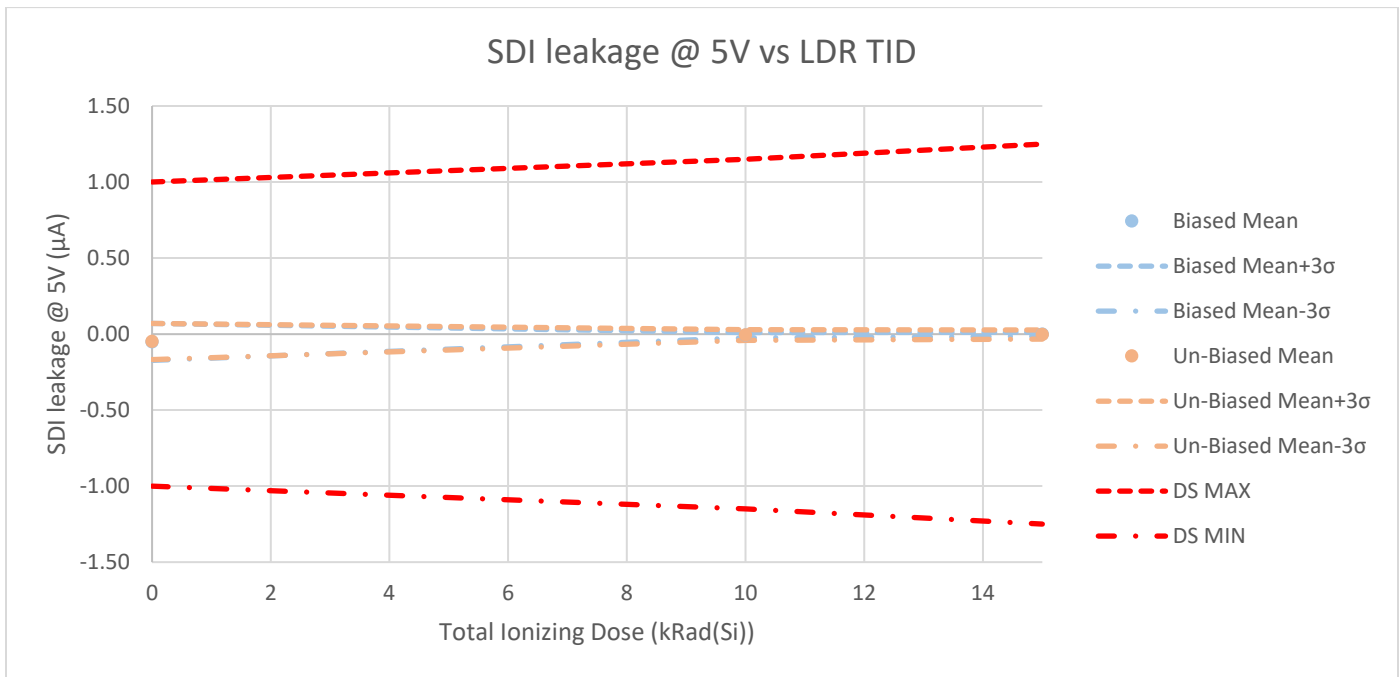

Table A-98-2. SDI leakage @ 5V vs. LDR TID for the RT6804HG-1.

Total Ionizing Dose (kRad(Si))	0	10	15	Units
LDR TID Biased				
Biased Mean	-0.0516	-0.0077	-0.0014	µA
Std Dev	0.0404	0.0058	0.0043	
Biased Mean+3σ	0.0695	0.0096	0.0116	
Biased Mean-3σ	-0.1726	-0.0249	-0.0144	
LDR TID Un-Biased				
Un-Biased Mean	-0.0489	-0.0068	-0.0028	µA
Std Dev	0.0397	0.0118	0.0100	
Un-Biased Mean+3σ	0.0703	0.0288	0.0274	
Un-Biased Mean-3σ	-0.1681	-0.0423	-0.0329	
DS MIN				
DS MIN	-1.00E+00	-1.15E+00	-1.25E+00	µA
	PASS	PASS	PASS	
DS MAX				
DS MAX	1.00E+00	1.15E+00	1.25E+00	µA
	PASS	PASS	PASS	

Figure A-99-1. SDO leakage @ 5V vs. HDR TID for the RT6804HG-1.

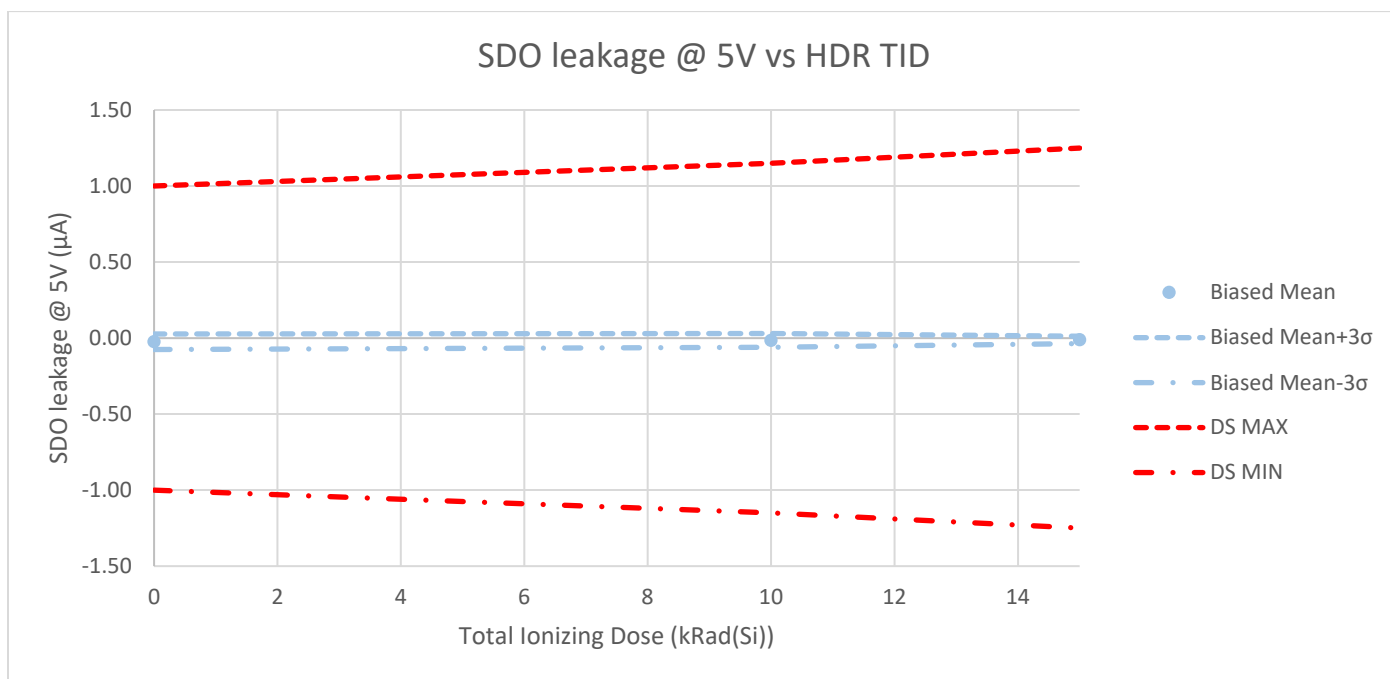

Table A-99-1. SDO leakage @ 5V vs. HDR TID for the RT6804HG-1.

HDR TID Biased				
Total Ionizing Dose (kRad(Si))	0	10	15	Units
Biased Mean	-0.0246	-0.0156	-0.0118	μA
Std Dev	0.0168	0.0153	0.0081	
Biased Mean+3σ	0.0259	0.0302	0.0124	
Biased Mean-3σ	-0.0751	-0.0614	-0.0360	
DS MIN	-1.00E+00	-1.15E+00	-1.25E+00	μA
	PASS	PASS	PASS	
DS MAX	1.00E+00	1.15E+00	1.25E+00	μA
	PASS	PASS	PASS	

Figure A-99-2. SDO leakage @ 5V vs. LDR TID for the RT6804HG-1.

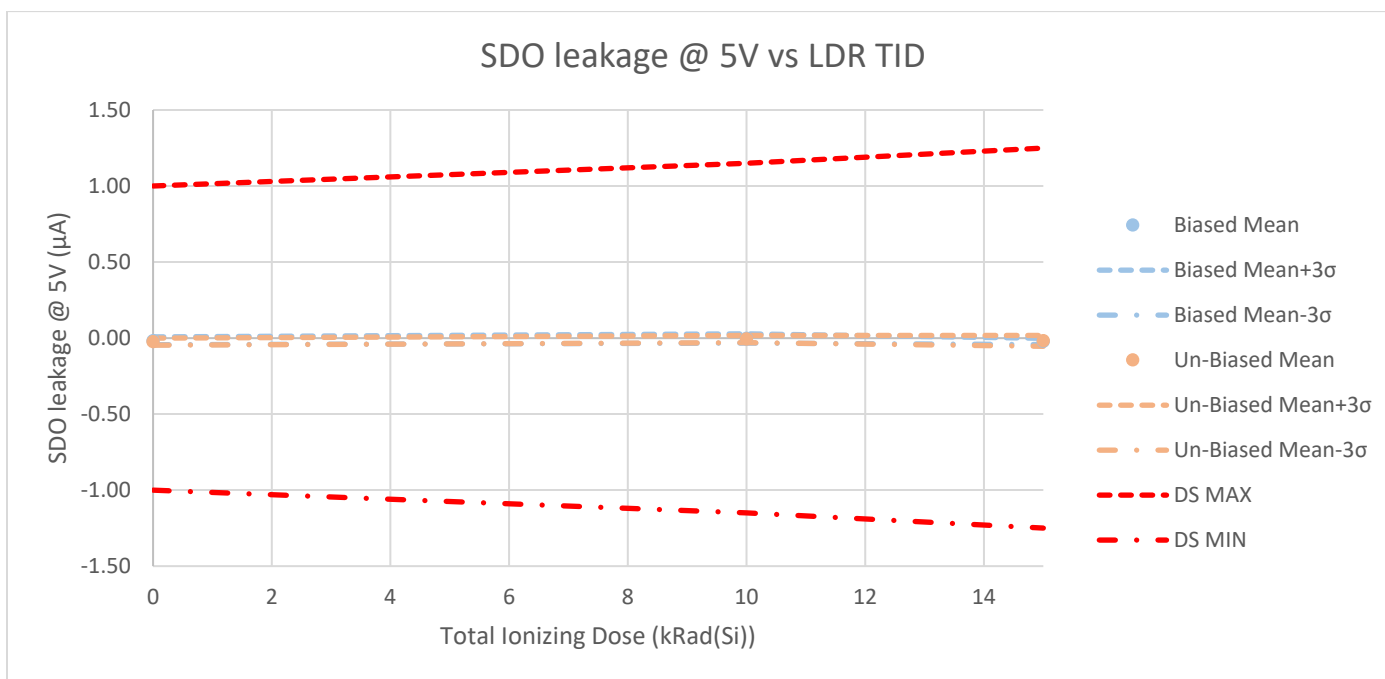

Table A-99-2. SDO leakage @ 5V vs. LDR TID for the RT6804HG-1.

Total Ionizing Dose (kRad(Si))	0	10	15	Units
LDR TID Biased				
Biased Mean	-0.0182	-0.0024	-0.0223	µA
Std Dev	0.0085	0.0102	0.0069	
Biased Mean+3σ	0.0072	0.0283	-0.0015	
Biased Mean-3σ	-0.0435	-0.0331	-0.0431	
LDR TID Un-Biased				
Un-Biased Mean	-0.0239	-0.0064	-0.0183	µA
Std Dev	0.0077	0.0079	0.0121	
Un-Biased Mean+3σ	-0.0008	0.0172	0.0178	
Un-Biased Mean-3σ	-0.0470	-0.0300	-0.0545	
DS Limits				
DS MIN	-1.00E+00	-1.15E+00	-1.25E+00	µA
	PASS	PASS	PASS	
DS MAX	1.00E+00	1.15E+00	1.25E+00	µA
	PASS	PASS	PASS	

Figure A-100-1. ISOMD leakage @ 5V vs. HDR TID for the RT6804HG-1.

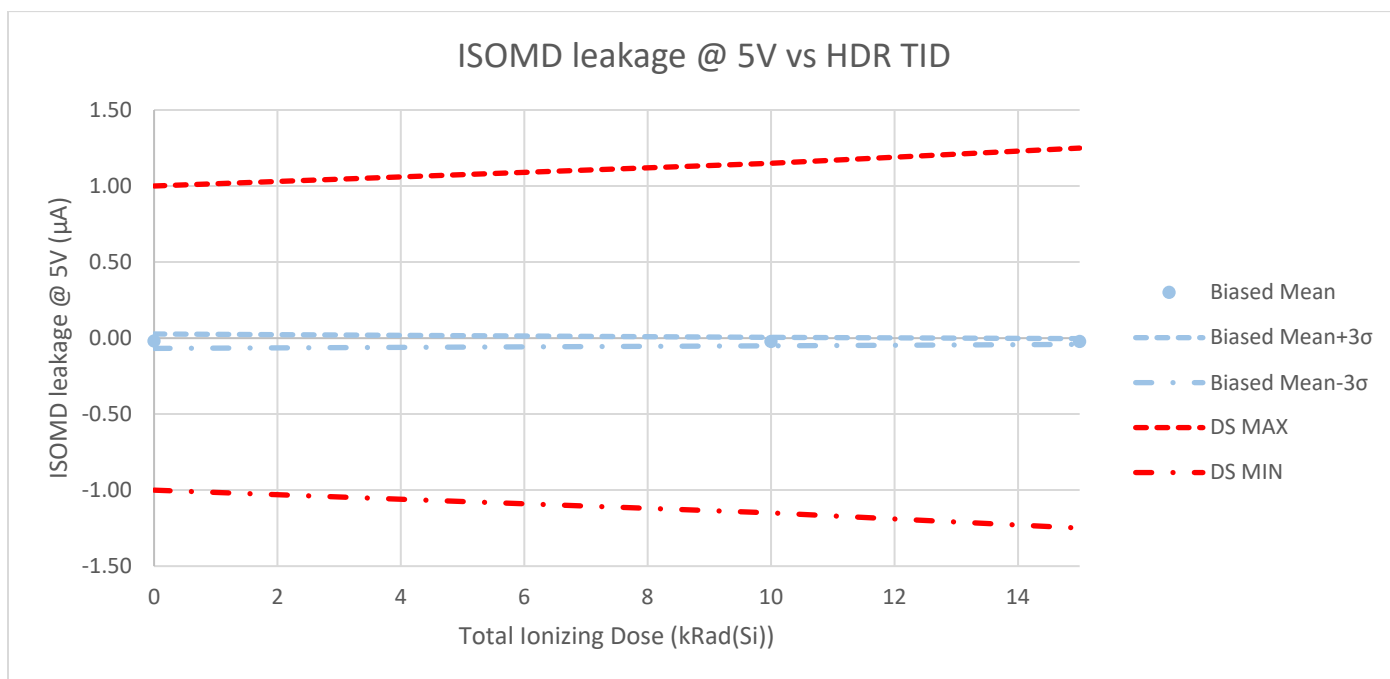

Table A-100-1. ISOMD leakage @ 5V vs. HDR TID for the RT6804HG-1.

HDR TID Biased				
Total Ionizing Dose (kRad(Si))	0	10	15	Units
Biased Mean	-0.0204	-0.0236	-0.0227	μA
Std Dev	0.0158	0.0092	0.0063	
Biased Mean+3σ	0.0272	0.0039	-0.0037	
Biased Mean-3σ	-0.0679	-0.0511	-0.0417	
DS MIN	-1.00E+00	-1.15E+00	-1.25E+00	μA
	PASS	PASS	PASS	
DS MAX	1.00E+00	1.15E+00	1.25E+00	μA
	PASS	PASS	PASS	

Figure A-100-2. ISOMD leakage @ 5V vs. LDR TID for the RT6804HG-1.

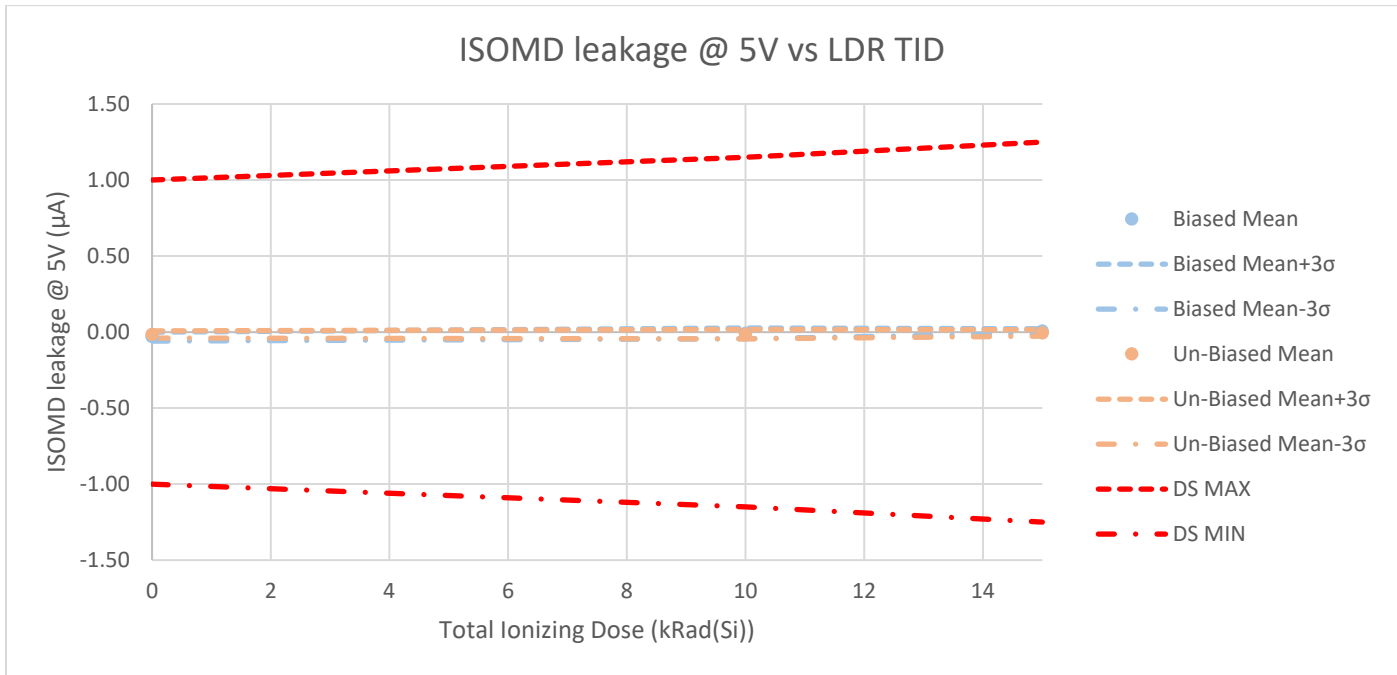

Table A-100-2. ISOMD leakage @ 5V vs. LDR TID for the RT6804HG-1.

Total Ionizing Dose (kRad(Si))	0	10	15	Units
LDR TID Biased				
Biased Mean	-0.0300	-0.0087	0.0060	µA
Std Dev	0.0099	0.0117	0.0051	
Biased Mean+3σ	-0.0004	0.0265	0.0214	
Biased Mean-3σ	-0.0596	-0.0438	-0.0094	
LDR TID Un-Biased				
Un-Biased Mean	-0.0158	-0.0135	-0.0064	µA
Std Dev	0.0079	0.0104	0.0070	
Un-Biased Mean+3σ	0.0078	0.0176	0.0145	
Un-Biased Mean-3σ	-0.0394	-0.0447	-0.0273	
DS Limits				
DS MIN	-1.00E+00	-1.15E+00	-1.25E+00	µA
	PASS	PASS	PASS	
DS MAX	1.00E+00	1.15E+00	1.25E+00	µA
	PASS	PASS	PASS	

Figure A-101-1. SWTEN leakage @ 5V vs. HDR TID for the RT6804HG-1.

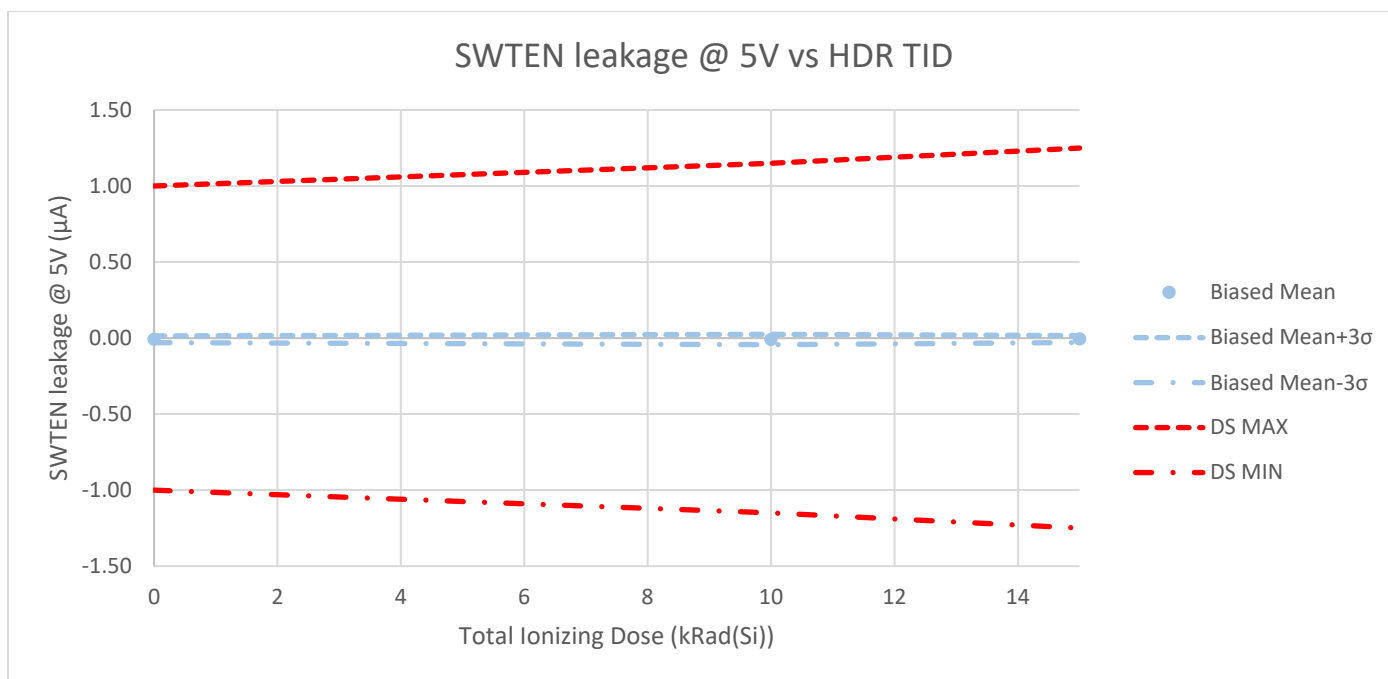

Table A-101-1. SWTEN leakage @ 5V vs. HDR TID for the RT6804HG-1.

HDR TID Biased				
Total Ionizing Dose (kRad(Si))	0	10	15	Units
Biased Mean	-0.0083	-0.0096	-0.0065	μA
Std Dev	0.0076	0.0114	0.0075	
Biased Mean+3σ	0.0143	0.0245	0.0159	
Biased Mean-3σ	-0.0310	-0.0437	-0.0290	
DS MIN	-1.00E+00	-1.15E+00	-1.25E+00	μA
	PASS	PASS	PASS	
DS MAX	1.00E+00	1.15E+00	1.25E+00	μA
	PASS	PASS	PASS	

Figure A-101-2. SWTEN leakage @ 5V vs. LDR TID for the RT6804HG-1.

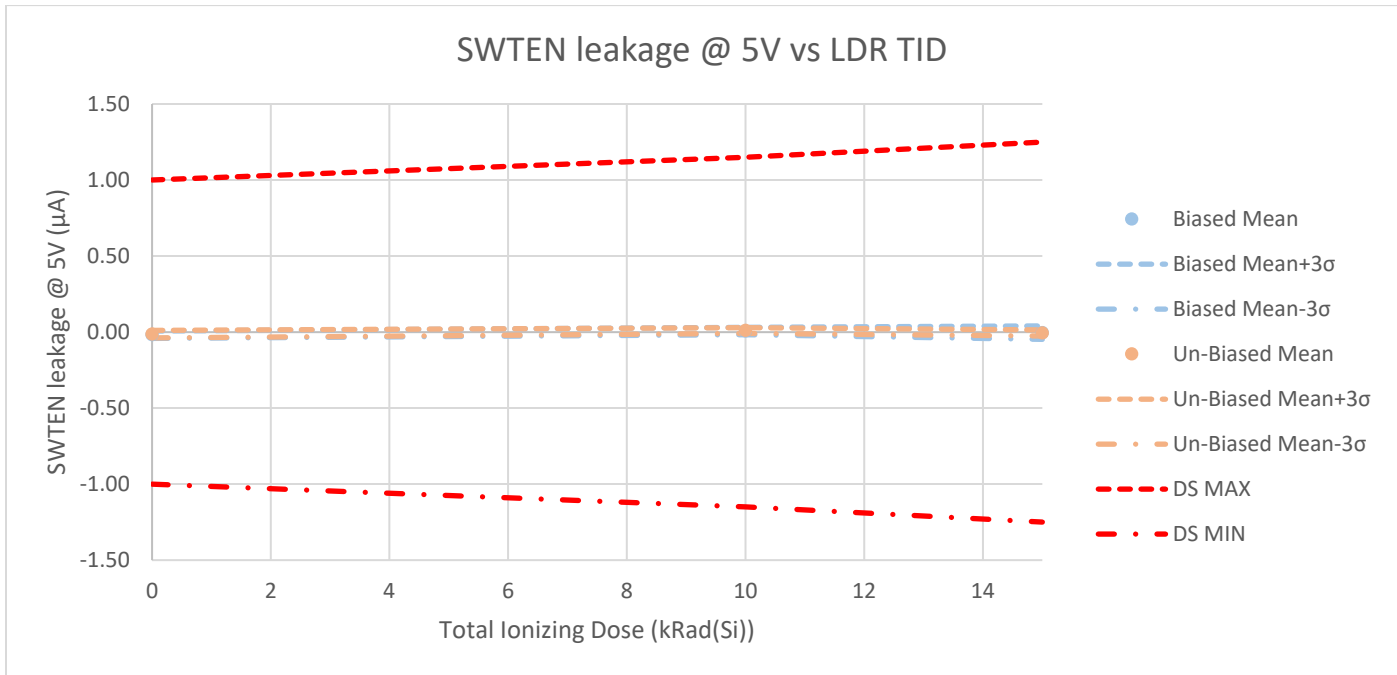

Table A-101-2. SWTEN leakage @ 5V vs. LDR TID for the RT6804HG-1.

Total Ionizing Dose (kRad(Si))	0	10	15	Units
LDR TID Biased				
Biased Mean	-0.0173	0.0065	-0.0037	µA
Std Dev	0.0081	0.0081	0.0148	
Biased Mean+3σ	0.0069	0.0309	0.0406	
Biased Mean-3σ	-0.0415	-0.0178	-0.0480	
LDR TID Un-Biased				
Un-Biased Mean	-0.0138	0.0101	-0.0064	µA
Std Dev	0.0083	0.0064	0.0067	
Un-Biased Mean+3σ	0.0110	0.0292	0.0138	
Un-Biased Mean-3σ	-0.0386	-0.0091	-0.0266	
DS MIN				
DS MIN	-1.00E+00	-1.15E+00	-1.25E+00	µA
	PASS	PASS	PASS	
DS MAX				
DS MAX	1.00E+00	1.15E+00	1.25E+00	µA
	PASS	PASS	PASS	

Figure A-102-1. IBIAS leakage @ 5V vs. HDR TID for the RT6804HG-1.

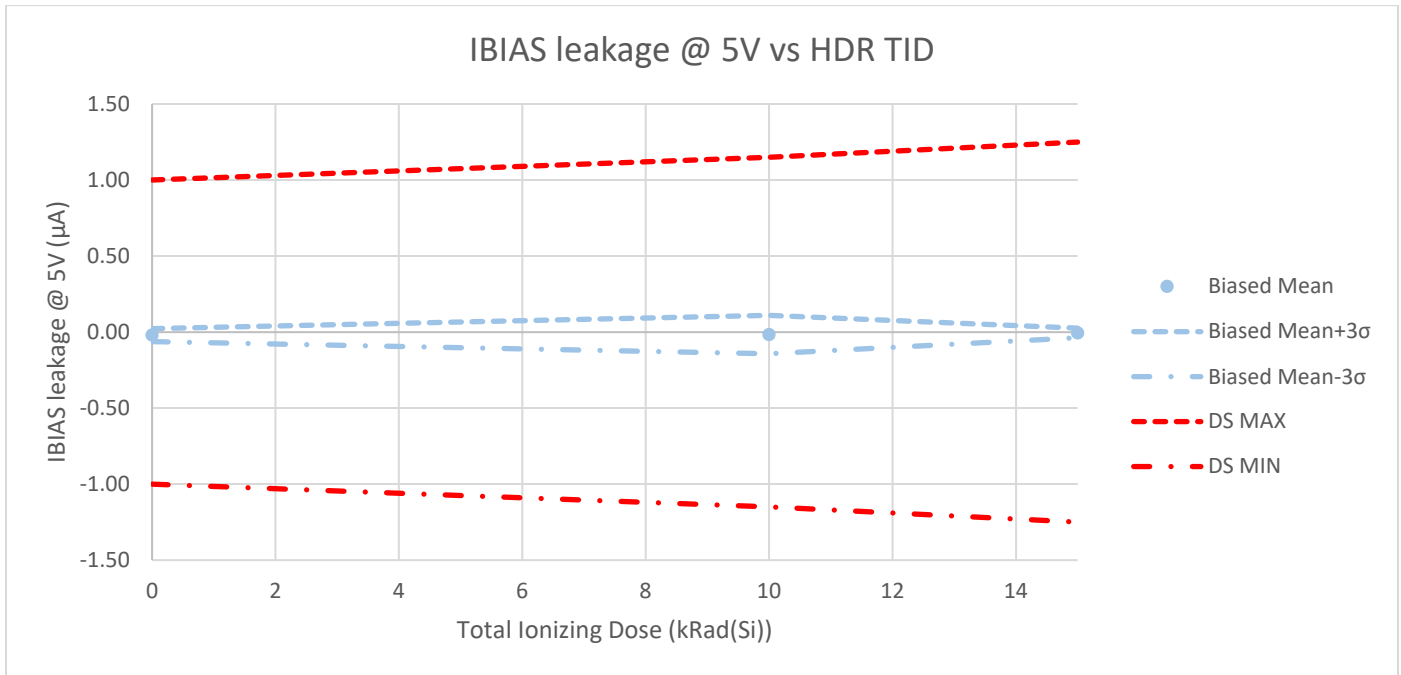

Table A-102-1. IBIAS leakage @ 5V vs. HDR TID for the RT6804HG-1.

HDR TID Biased				
Total Ionizing Dose (kRad(Si))	0	10	15	Units
Biased Mean	-0.0203	-0.0164	-0.0060	μA
Std Dev	0.0144	0.0420	0.0103	
Biased Mean+3σ	0.0230	0.1097	0.0249	
Biased Mean-3σ	-0.0636	-0.1424	-0.0369	
DS MIN	-1.00E+00	-1.15E+00	-1.25E+00	μA
	PASS	PASS	PASS	
DS MAX	1.00E+00	1.15E+00	1.25E+00	μA
	PASS	PASS	PASS	

Figure A-102-2. IBIAS leakage @ 5V vs. LDR TID for the RT6804HG-1.

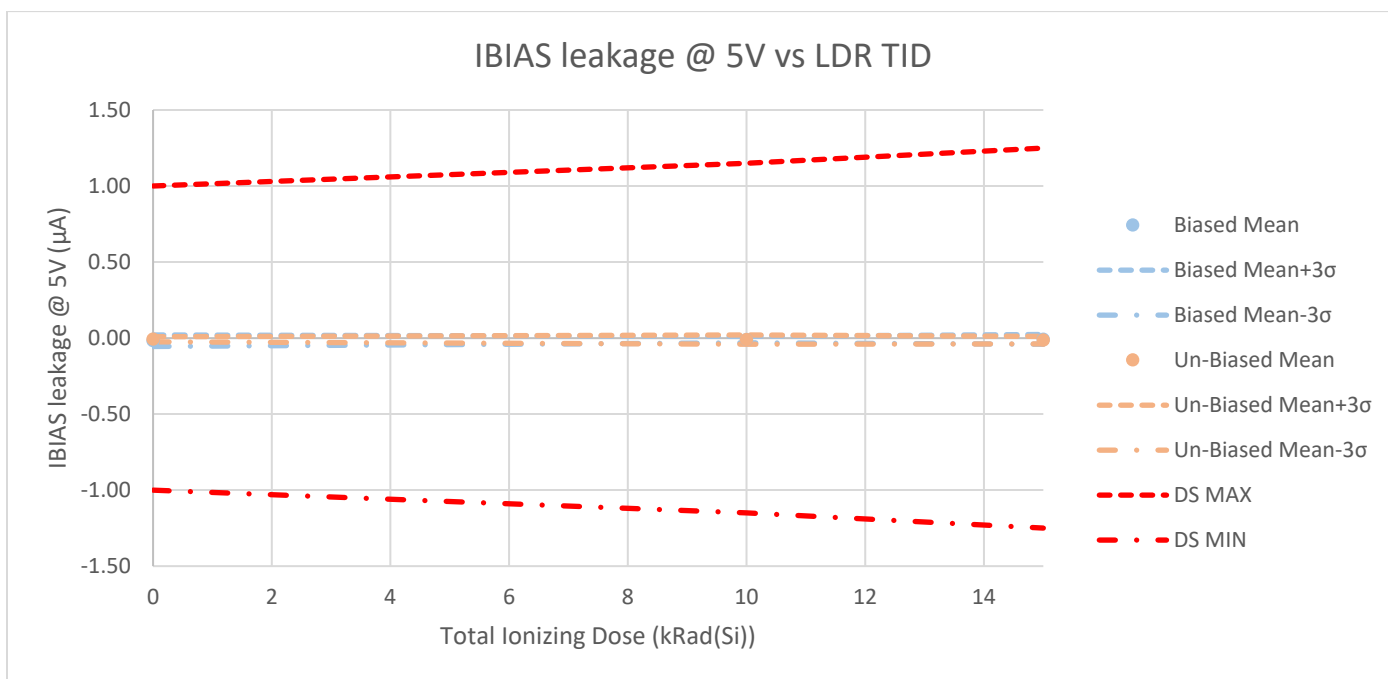

Table A-102-2. IBIAS leakage @ 5V vs. LDR TID for the RT6804HG-1.

Total Ionizing Dose (kRad(Si))	0	10	15	Units
LDR TID Biased				
Biased Mean	-0.0181	-0.0100	-0.0087	μA
Std Dev	0.0125	0.0071	0.0107	
Biased Mean+3σ	0.0196	0.0114	0.0233	
Biased Mean-3σ	-0.0557	-0.0314	-0.0407	
LDR TID Un-Biased				
Un-Biased Mean	-0.0078	-0.0100	-0.0140	μA
Std Dev	0.0057	0.0103	0.0081	
Un-Biased Mean+3σ	0.0094	0.0209	0.0104	
Un-Biased Mean-3σ	-0.0250	-0.0410	-0.0384	
DS MIN				
DS MIN	-1.00E+00	-1.15E+00	-1.25E+00	μA
	PASS	PASS	PASS	
DS MAX				
DS MAX	1.00E+00	1.15E+00	1.25E+00	μA
	PASS	PASS	PASS	

Figure A-103-1. ICMP leakage @ 5V vs. HDR TID for the RT6804HG-1.

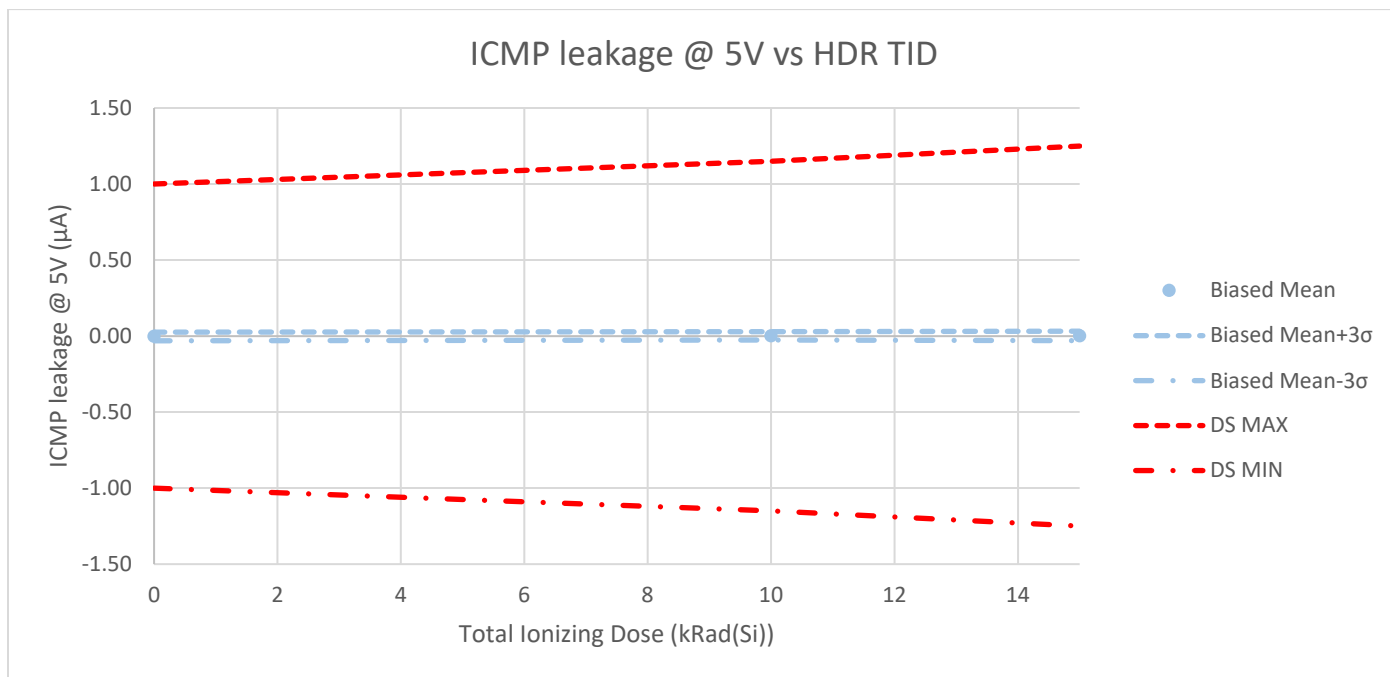

Table A-103-1. ICMP leakage @ 5V vs. HDR TID for the RT6804HG-1.

HDR TID Biased				
Total Ionizing Dose (kRad(Si))	0	10	15	Units
Biased Mean	-0.0023	0.0012	0.0006	μA
Std Dev	0.0094	0.0089	0.0104	
Biased Mean+3σ	0.0260	0.0279	0.0316	
Biased Mean-3σ	-0.0306	-0.0255	-0.0305	
DS MIN	-1.00E+00	-1.15E+00	-1.25E+00	μA
	PASS	PASS	PASS	
DS MAX	1.00E+00	1.15E+00	1.25E+00	μA
	PASS	PASS	PASS	

Figure A-103-2. ICMP leakage @ 5V vs. LDR TID for the RT6804HG-1.

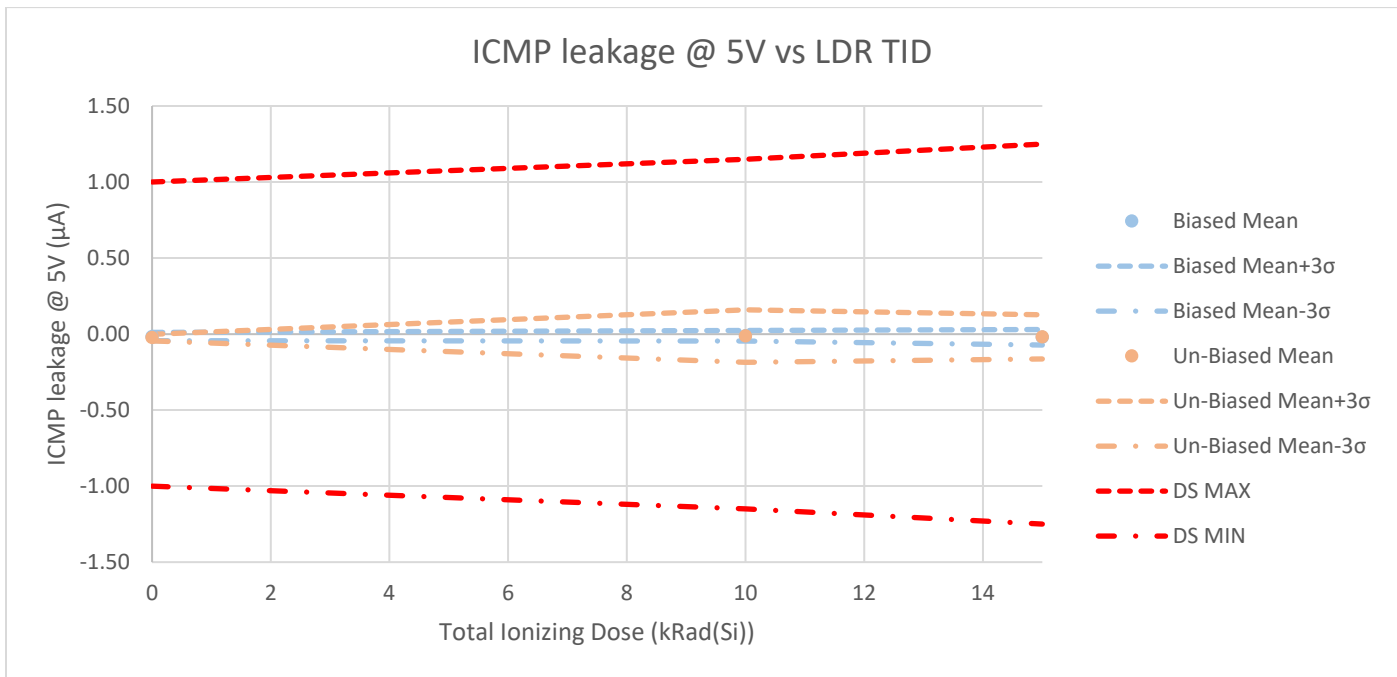

Table A-103-2. ICMP leakage @ 5V vs. LDR TID for the RT6804HG-1.

Total Ionizing Dose (kRad(Si))	0	10	15	Units
LDR TID Biased				
Biased Mean	-0.0166	-0.0114	-0.0212	µA
Std Dev	0.0091	0.0116	0.0169	
Biased Mean+3σ	0.0108	0.0234	0.0296	
Biased Mean-3σ	-0.0439	-0.0462	-0.0720	
LDR TID Un-Biased				
Un-Biased Mean	-0.0232	-0.0127	-0.0190	µA
Std Dev	0.0073	0.0575	0.0485	
Un-Biased Mean+3σ	-0.0013	0.1598	0.1266	
Un-Biased Mean-3σ	-0.0452	-0.1853	-0.1645	
DS MIN				
DS MIN	-1.00E+00	-1.15E+00	-1.25E+00	µA
	PASS	PASS	PASS	
DS MAX				
DS MAX	1.00E+00	1.15E+00	1.25E+00	µA
	PASS	PASS	PASS	

Figure A-104-1. IHM leakage @ 5V vs. HDR TID for the RT6804HG-1.

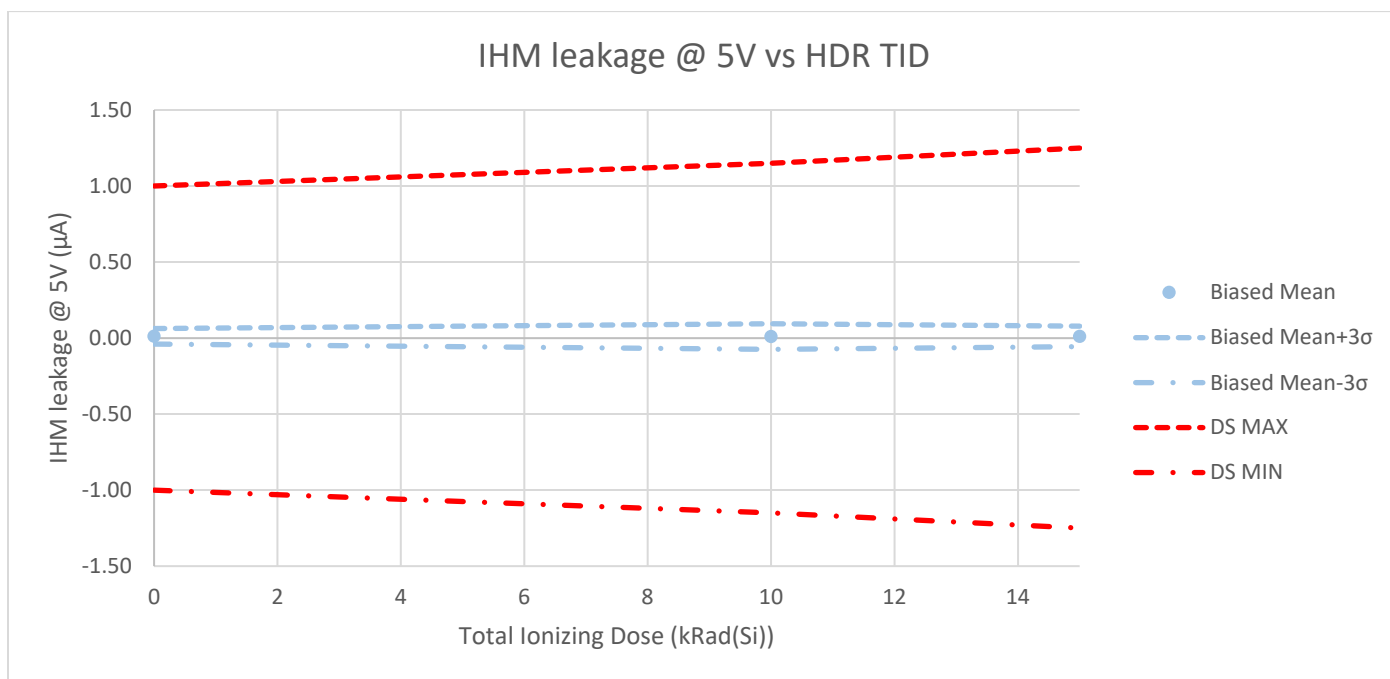

Table A-104-1. IHM leakage @ 5V vs. HDR TID for the RT6804HG-1.

HDR TID Biased				
Total Ionizing Dose (kRad(Si))	0	10	15	Units
Biased Mean	0.0117	0.0100	0.0103	μA
Std Dev	0.0171	0.0282	0.0224	
Biased Mean+3σ	0.0629	0.0946	0.0776	
Biased Mean-3σ	-0.0395	-0.0746	-0.0569	
DS MIN	-1.00E+00	-1.15E+00	-1.25E+00	μA
	PASS	PASS	PASS	
DS MAX	1.00E+00	1.15E+00	1.25E+00	μA
	PASS	PASS	PASS	

Figure A-104-2. IHM leakage @ 5V vs. LDR TID for the RT6804HG-1.

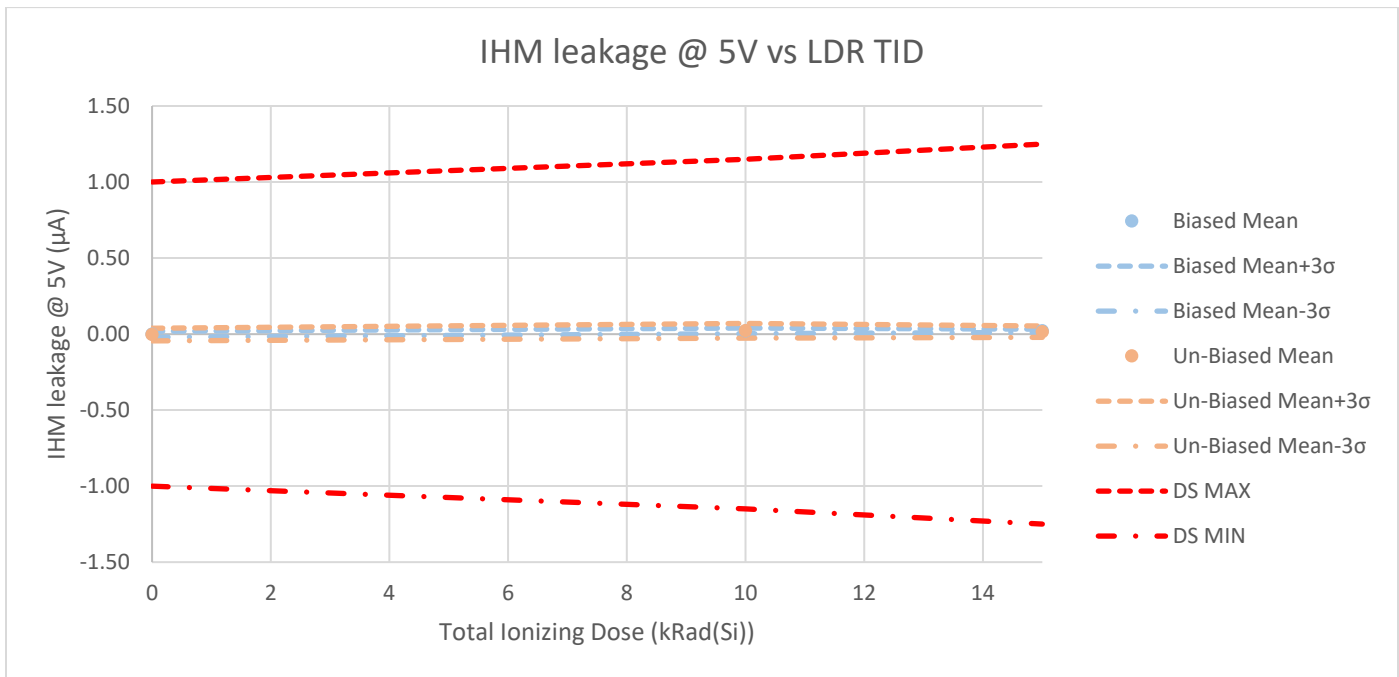

Table A-104-2. IHM leakage @ 5V vs. LDR TID for the RT6804HG-1.

Total Ionizing Dose (kRad(Si))	0	10	15	Units
LDR TID Biased				
Biased Mean	-0.0008	0.0204	0.0213	µA
Std Dev	0.0064	0.0062	0.0035	
Biased Mean+3σ	0.0184	0.0391	0.0317	
Biased Mean-3σ	-0.0201	0.0017	0.0109	
LDR TID Un-Biased				
Un-Biased Mean	-0.0032	0.0218	0.0153	µA
Std Dev	0.0139	0.0162	0.0123	
Un-Biased Mean+3σ	0.0387	0.0704	0.0522	
Un-Biased Mean-3σ	-0.0450	-0.0268	-0.0217	
DS Limits				
DS MIN	-1.00E+00	-1.15E+00	-1.25E+00	µA
	PASS	PASS	PASS	
DS MAX	1.00E+00	1.15E+00	1.25E+00	µA
	PASS	PASS	PASS	

Figure A-105-1. IHP leakage @ 5V vs. HDR TID for the RT6804HG-1.

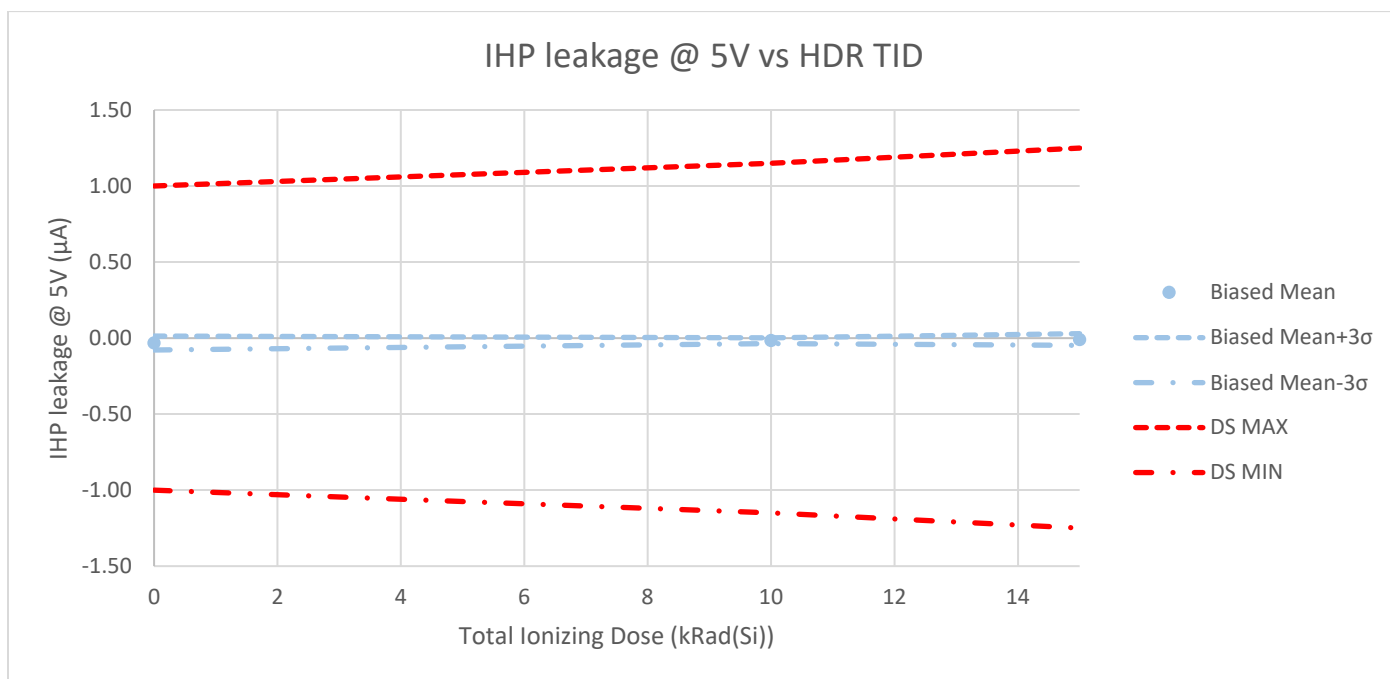

Table A-105-1. IHP leakage @ 5V vs. HDR TID for the RT6804HG-1.

HDR TID Biased				
Total Ionizing Dose (kRad(Si))	0	10	15	Units
Biased Mean	-0.0328	-0.0172	-0.0100	μA
Std Dev	0.0151	0.0062	0.0128	
Biased Mean+3σ	0.0125	0.0014	0.0285	
Biased Mean-3σ	-0.0781	-0.0359	-0.0485	
DS MIN	-1.00E+00	-1.15E+00	-1.25E+00	μA
	PASS	PASS	PASS	
DS MAX	1.00E+00	1.15E+00	1.25E+00	μA
	PASS	PASS	PASS	

Figure A-105-2. IHP leakage @ 5V vs. LDR TID for the RT6804HG-1.

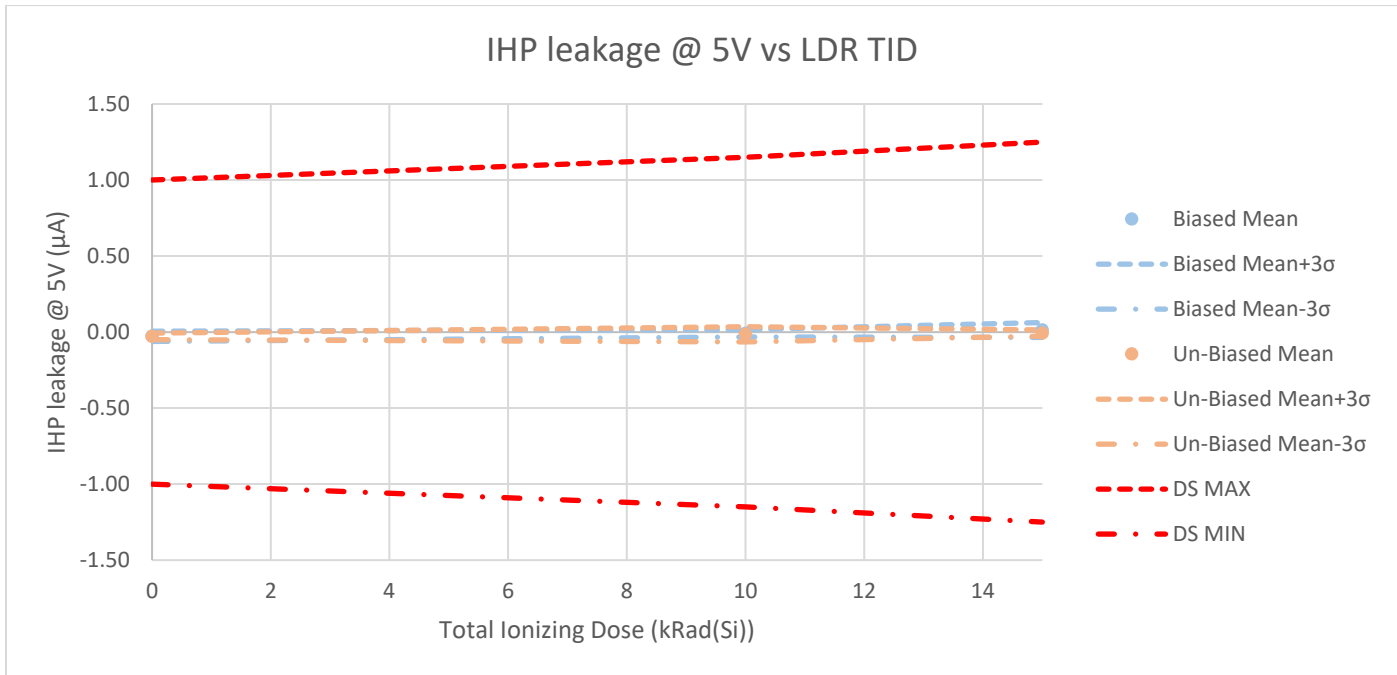

Table A-105-2. IHP leakage @ 5V vs. LDR TID for the RT6804HG-1.

Total Ionizing Dose (kRad(Si))	0	10	15	Units
LDR TID Biased				
Biased Mean	-0.0275	-0.0082	0.0136	µA
Std Dev	0.0112	0.0080	0.0163	
Biased Mean+3σ	0.0060	0.0159	0.0626	
Biased Mean-3σ	-0.0610	-0.0322	-0.0354	
LDR TID Un-Biased				
Un-Biased Mean	-0.0284	-0.0148	-0.0068	µA
Std Dev	0.0072	0.0168	0.0067	
Un-Biased Mean+3σ	-0.0067	0.0354	0.0133	
Un-Biased Mean-3σ	-0.0501	-0.0651	-0.0270	
DS Limits				
DS MIN	-1.00E+00	-1.15E+00	-1.25E+00	µA
	PASS	PASS	PASS	
DS MAX	1.00E+00	1.15E+00	1.25E+00	µA
	PASS	PASS	PASS	

Figure A-106-1. VBIAS @ 2K, VREG=4.5V vs. HDR TID for the RT6804HG-1.

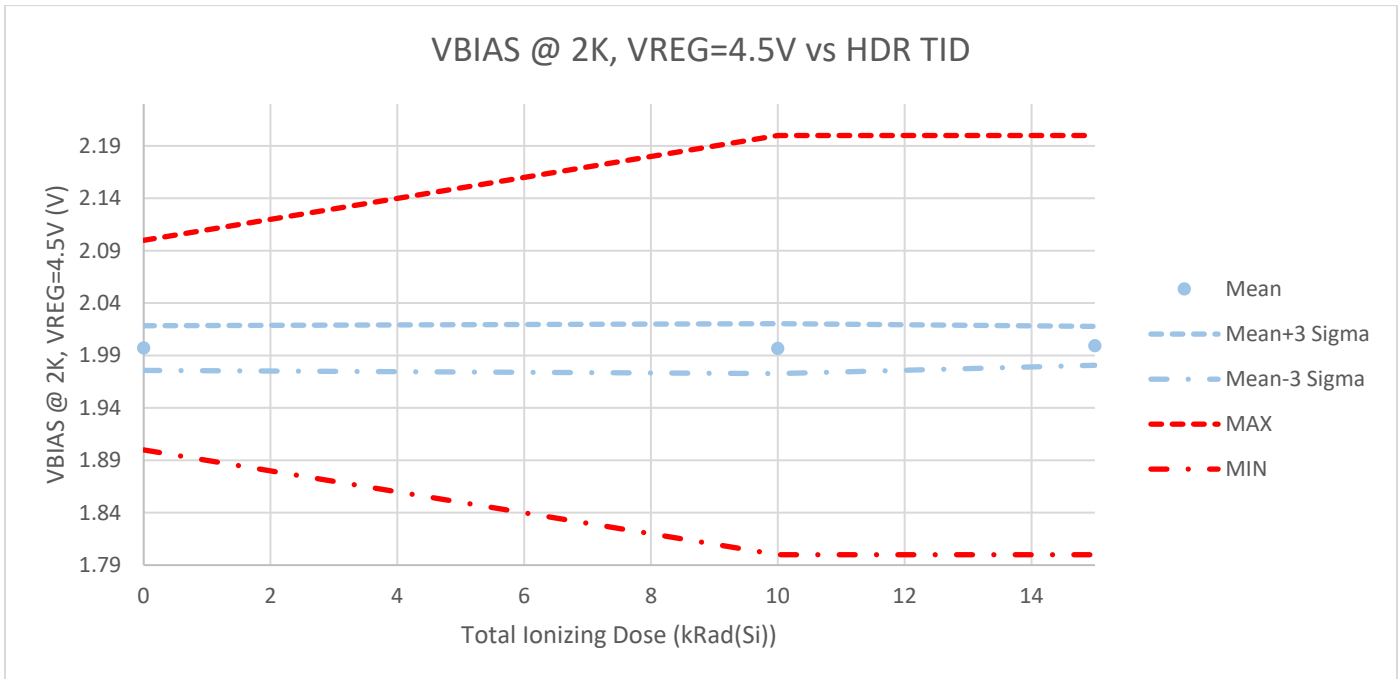
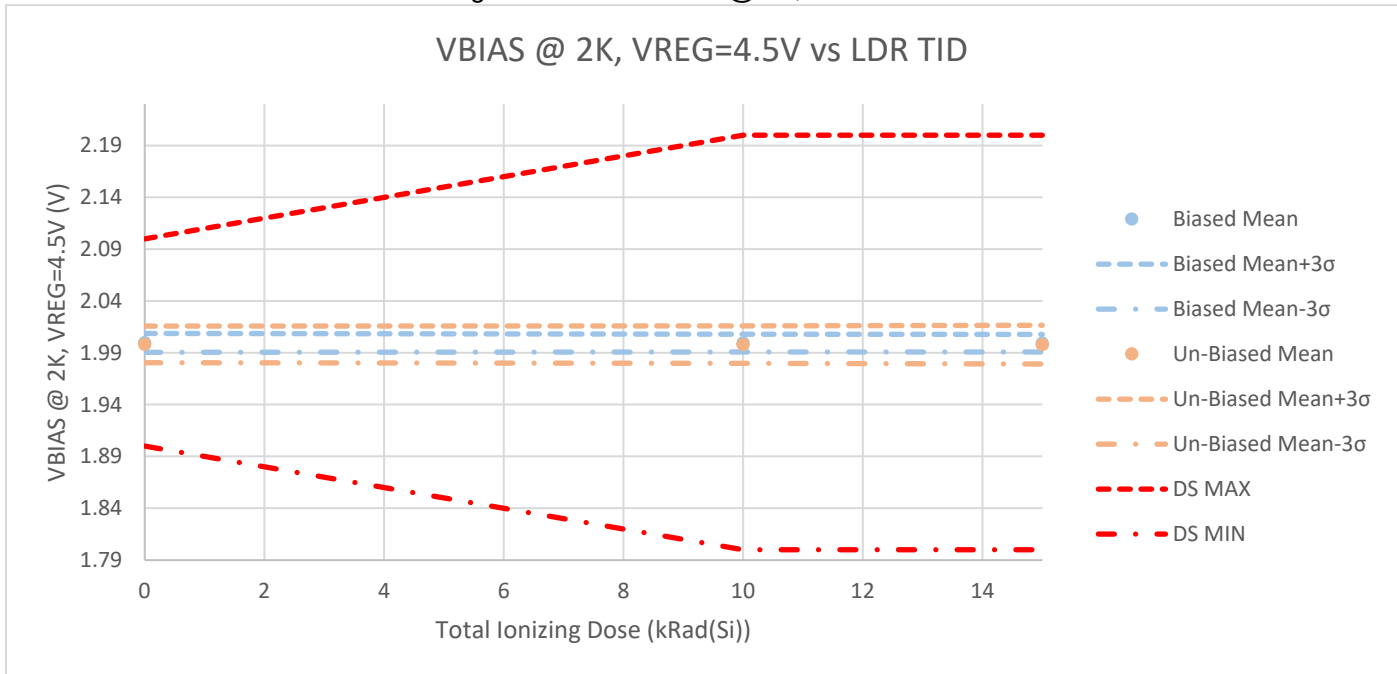

Table A-106-1. VBIAS @ 2K, VREG=4.5V vs. HDR TID for the RT6804HG-1.

HDR TID Biased				
Total Ionizing Dose (kRad(Si))	0	10	15	Units
Biased Mean	1.9971	1.9967	1.9993	V
Std Dev	0.0071	0.0079	0.0062	
Biased Mean+3σ	2.0184	2.0204	2.0178	
Biased Mean-3σ	1.9758	1.9729	1.9808	
DS MIN	1.90E+00	1.80E+00	1.80E+00	V
	PASS	PASS	PASS	
DS MAX	2.10E+00	2.20E+00	2.20E+00	V
	PASS	PASS	PASS	

Figure A-106-2. VBIAS @ 2K, VREG=4.5V



vs. LDR TID for the RT6804HG-1.

Table A-106-2. VBIAS @ 2K, VREG=4.5V vs. LDR TID for the RT6804HG-1.

Total Ionizing Dose (kRad(Si))	0	10	15	Units
LDR TID Biased				
Biased Mean	1.9996	1.9993	1.9992	V
Std Dev	0.0030	0.0028	0.0028	
Biased Mean+3σ	2.0087	2.0079	2.0077	
Biased Mean-3σ	1.9905	1.9908	1.9908	
LDR TID Un-Biased				
Un-Biased Mean	1.9981	1.9978	1.9979	V
Std Dev	0.0059	0.0060	0.0062	
Un-Biased Mean+3σ	2.0158	2.0159	2.0165	
Un-Biased Mean-3σ	1.9804	1.9797	1.9792	
DS MIN	1.90E+00	1.80E+00	1.80E+00	V
	PASS	PASS	PASS	
DS MAX	2.10E+00	2.20E+00	2.20E+00	V
	PASS	PASS	PASS	

Figure A-107-1. VBIAS @ 2K, VREG=5.5V vs. HDR TID for the RT6804HG-1.

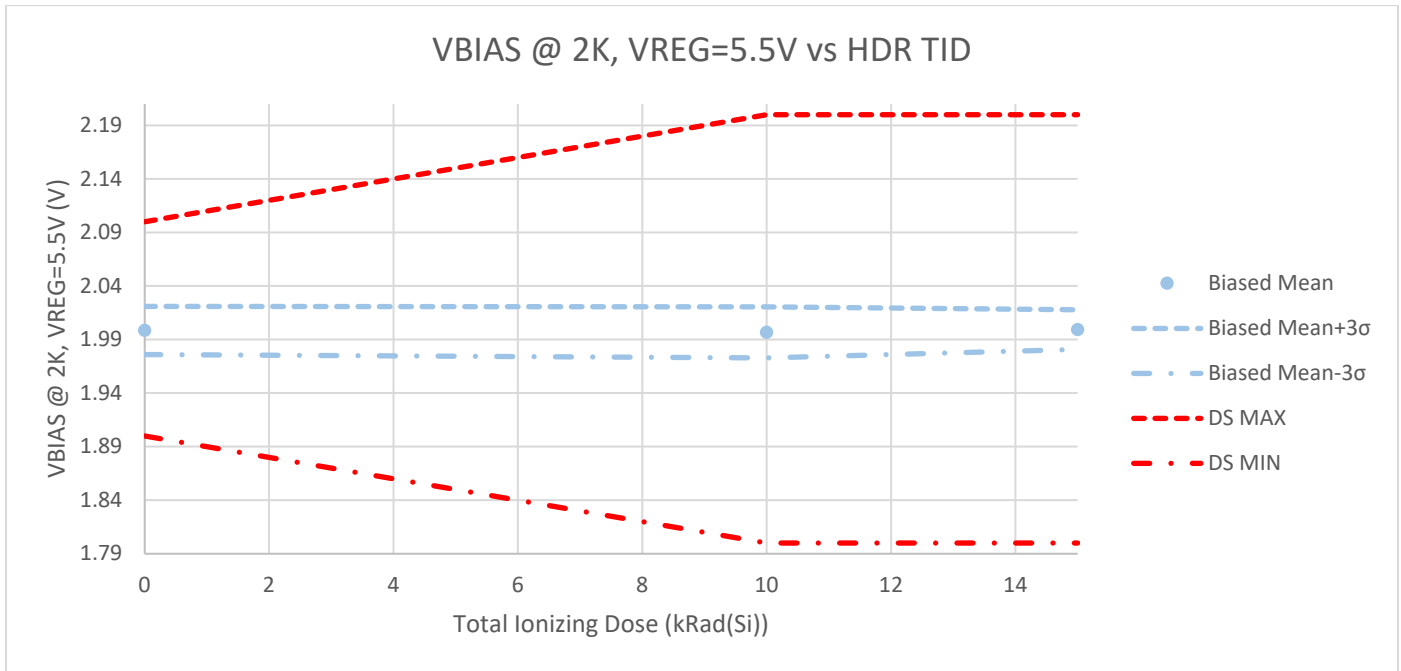

Table A-107-1. VBIAS @ 2K, VREG=5.5V vs. HDR TID for the RT6804HG-1.

HDR TID Biased				
Total Ionizing Dose (kRad(Si))	0	10	15	Units
Biased Mean	1.9985	1.9967	1.9993	V
Std Dev	0.0075	0.0079	0.0062	
Biased Mean+3σ	2.0210	2.0204	2.0178	
Biased Mean-3σ	1.9759	1.9729	1.9808	
DS MIN	1.90E+00	1.80E+00	1.80E+00	V
	PASS	PASS	PASS	
DS MAX	2.10E+00	2.20E+00	2.20E+00	V
	PASS	PASS	PASS	

Figure A-107-2. VBIAS @ 2K, VREG=5.5V vs. LDR TID for the RT6804HG-1.

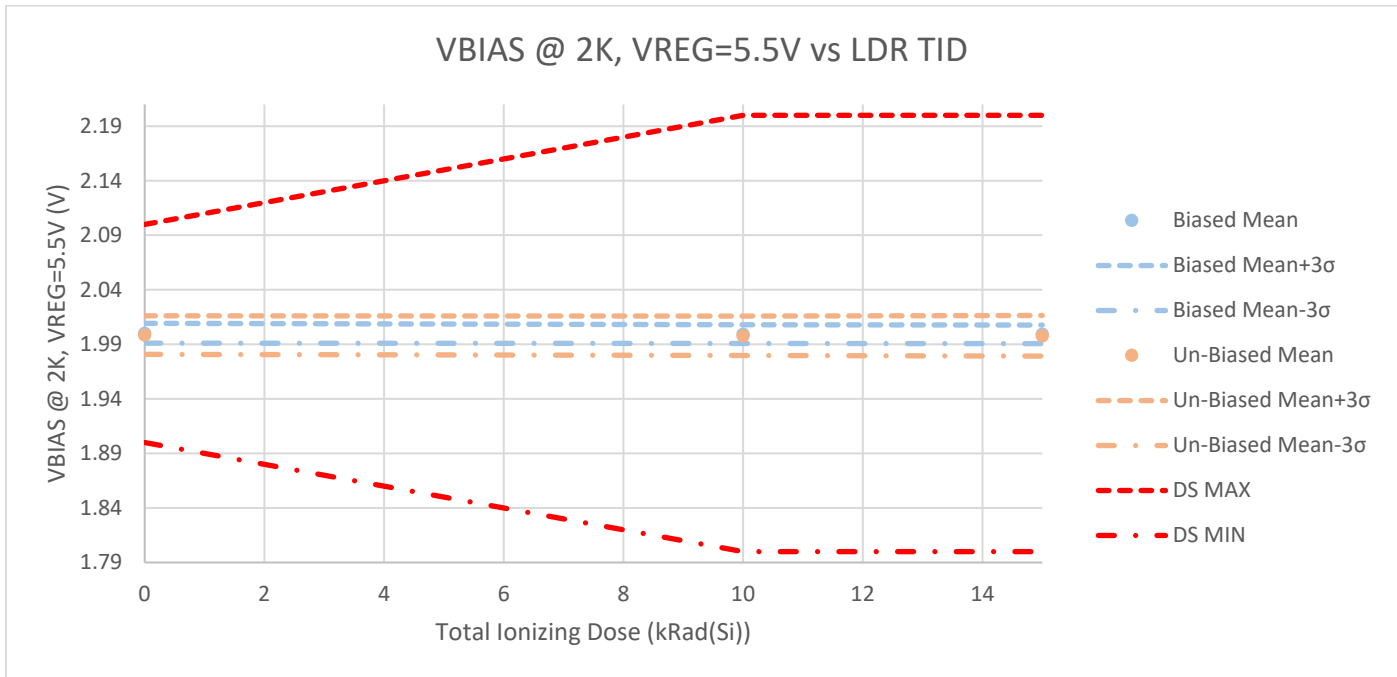

Table A-107-2. VBIAS @ 2K, VREG=5.5V vs. LDR TID for the RT6804HG-1.

Total Ionizing Dose (kRad(Si))	0	10	15	Units
LDR TID Biased				
Biased Mean	2.0002	1.9993	1.9992	V
Std Dev	0.0030	0.0028	0.0028	
Biased Mean+3σ	2.0094	2.0079	2.0077	
Biased Mean-3σ	1.9911	1.9908	1.9908	
LDR TID Un-Biased				
Un-Biased Mean	1.9985	1.9978	1.9979	V
Std Dev	0.0059	0.0060	0.0062	
Un-Biased Mean+3σ	2.0162	2.0159	2.0165	
Un-Biased Mean-3σ	1.9809	1.9797	1.9792	
DS MIN				
DS MIN	1.90E+00	1.80E+00	1.80E+00	V
	PASS	PASS	PASS	
DS MAX				
DS MAX	2.10E+00	2.20E+00	2.20E+00	V
	PASS	PASS	PASS	

Figure A-108-1. VBIAS @ 20K, VREG=4.5V vs. HDR TID for the RT6804HG-1.

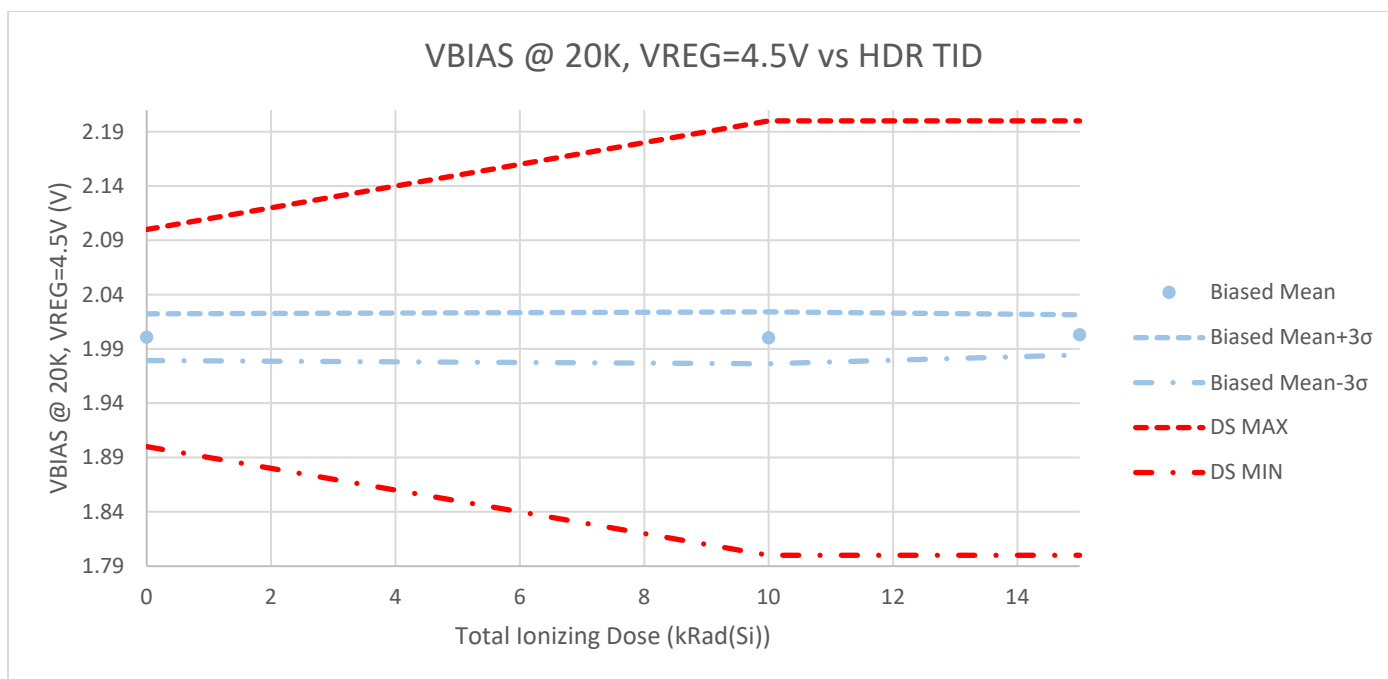

Table A-108-1. VBIAS @ 20K, VREG=4.5V vs. HDR TID for the RT6804HG-1.

HDR TID Biased				
Total Ionizing Dose (kRad(Si))	0	10	15	Units
Biased Mean	2.0007	2.0002	2.0029	V
Std Dev	0.0072	0.0080	0.0062	
Biased Mean+3σ	2.0222	2.0241	2.0215	
Biased Mean-3σ	1.9792	1.9763	1.9844	
DS MIN	1.90E+00	1.80E+00	1.80E+00	V
	PASS	PASS	PASS	
DS MAX	2.10E+00	2.20E+00	2.20E+00	V
	PASS	PASS	PASS	

Figure A-108-2. VBIAS @ 20K, VREG=4.5V vs. LDR TID for the RT6804HG-1.

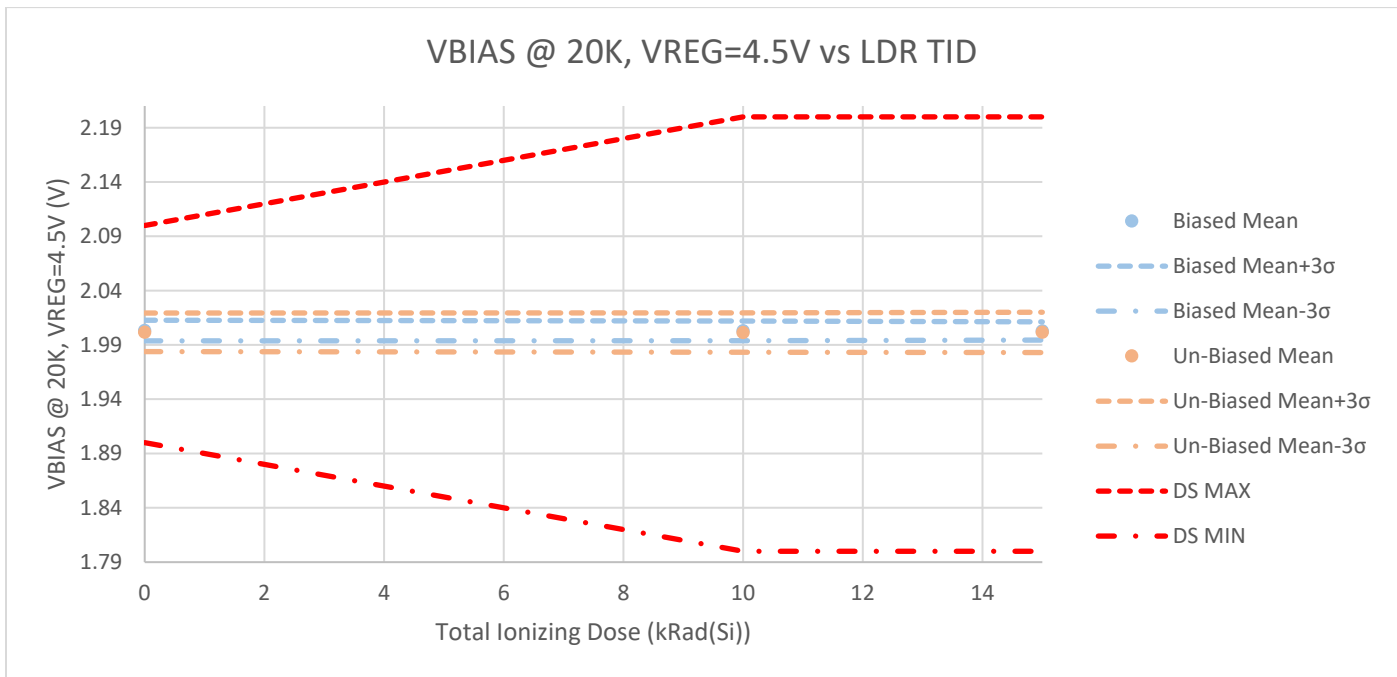

Table A-108-2. VBIAS @ 20K, VREG=4.5V vs. LDR TID for the RT6804HG-1.

Total Ionizing Dose (kRad(Si))	0	10	15	Units
LDR TID Biased				
Biased Mean	2.0032	2.0029	2.0028	V
Std Dev	0.0032	0.0030	0.0028	
Biased Mean+3σ	2.0127	2.0120	2.0113	
Biased Mean-3σ	1.9938	1.9938	1.9944	
LDR TID Un-Biased				
Un-Biased Mean	2.0016	2.0013	2.0016	V
Std Dev	0.0059	0.0061	0.0062	
Un-Biased Mean+3σ	2.0193	2.0195	2.0201	
Un-Biased Mean-3σ	1.9839	1.9831	1.9830	
DS MIN				
DS MIN	1.90E+00	1.80E+00	1.80E+00	V
	PASS	PASS	PASS	
DS MAX				
DS MAX	2.10E+00	2.20E+00	2.20E+00	V
	PASS	PASS	PASS	

Figure A-109-1. VBIAS @ 20K, VREG=5.5V vs. HDR TID for the RT6804HG-1.

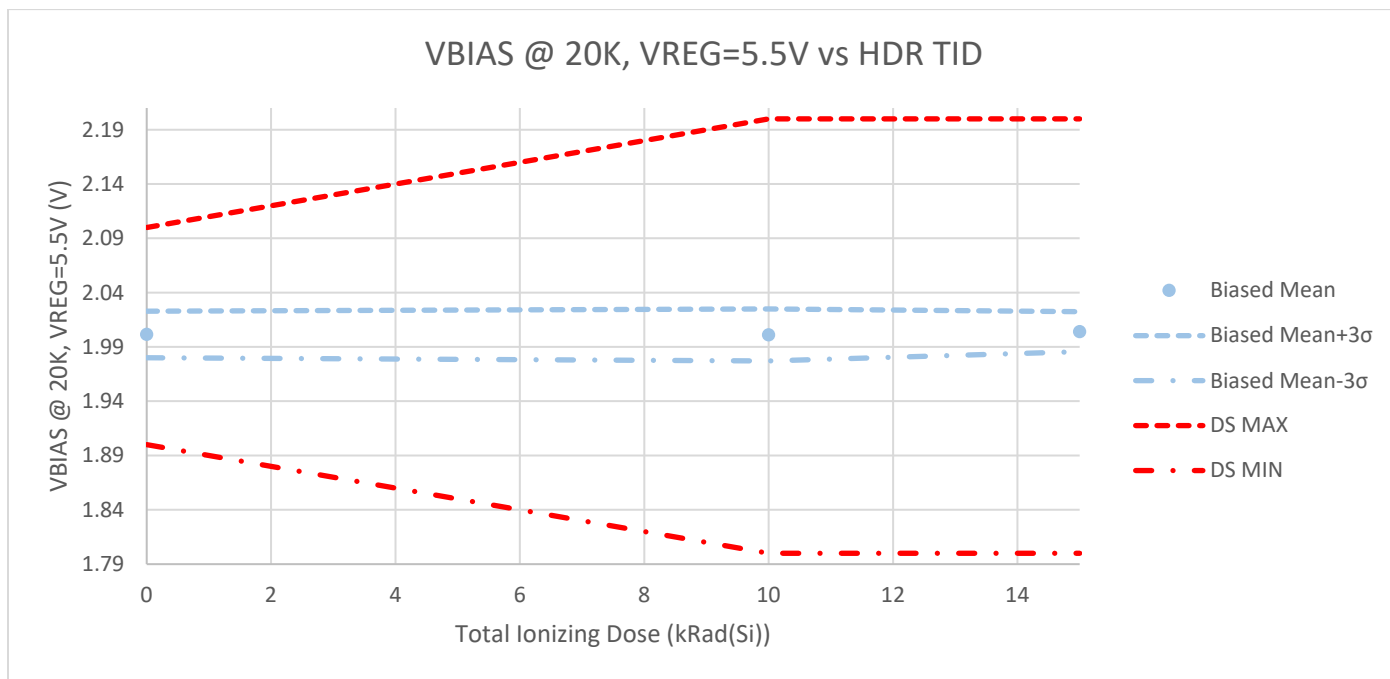

Table A-109-1. VBIAS @ 20K, VREG=5.5V vs. HDR TID for the RT6804HG-1.

HDR TID Biased				
Total Ionizing Dose (kRad(Si))	0	10	15	Units
Biased Mean	2.0015	2.0011	2.0040	V
Std Dev	0.0071	0.0080	0.0061	
Biased Mean+3σ	2.0229	2.0249	2.0225	
Biased Mean-3σ	1.9800	1.9772	1.9856	
DS MIN	1.90E+00	1.80E+00	1.80E+00	V
	PASS	PASS	PASS	
DS MAX	2.10E+00	2.20E+00	2.20E+00	V
	PASS	PASS	PASS	

Figure A-109-2. VBIAS @ 20K, VREG=5.5V vs. LDR TID for the RT6804HG-1.

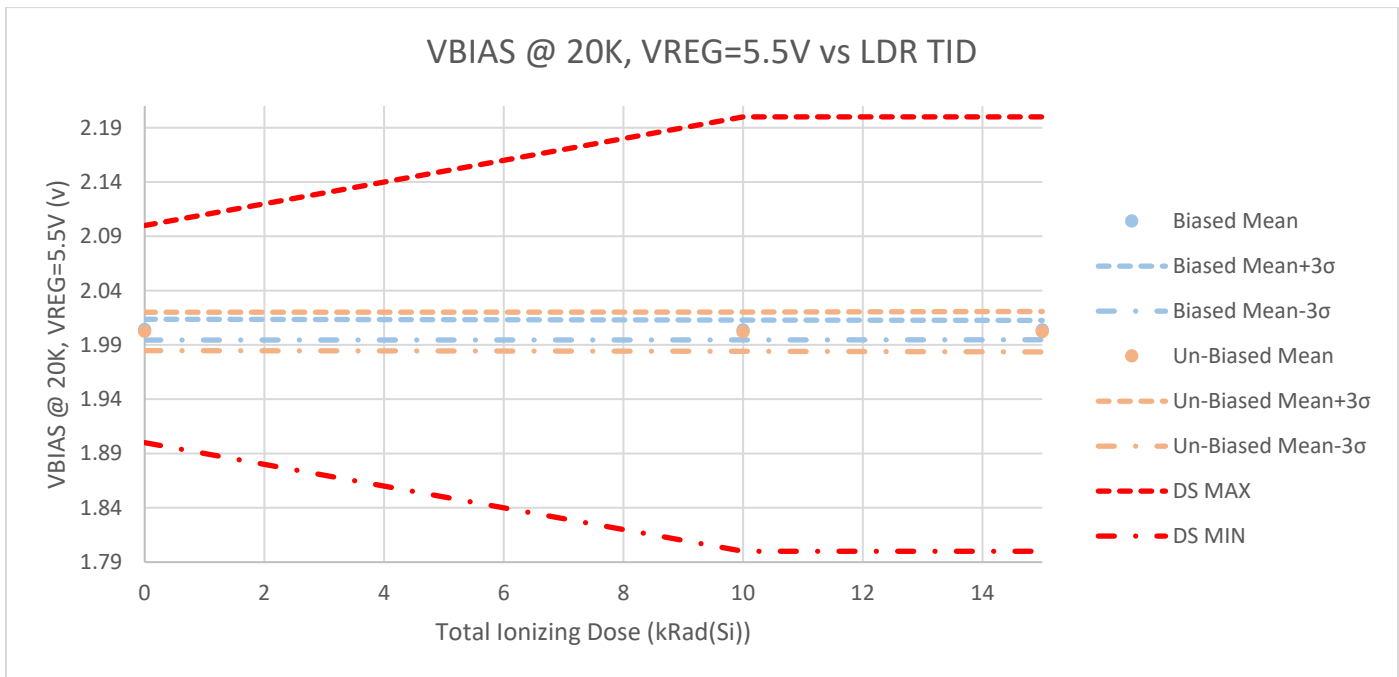

Table A-109-2. VBIAS @ 20K, VREG=5.5V vs. LDR TID for the RT6804HG-1.

Total Ionizing Dose (kRad(Si))	0	10	15	Units
LDR TID Biased				
Biased Mean	2.0041	2.0037	2.0037	V
Std Dev	0.0032	0.0031	0.0030	
Biased Mean+3σ	2.0136	2.0129	2.0127	
Biased Mean-3σ	1.9945	1.9946	1.9948	
LDR TID Un-Biased				
Un-Biased Mean	2.0025	2.0021	2.0023	V
Std Dev	0.0059	0.0060	0.0062	
Un-Biased Mean+3σ	2.0201	2.0202	2.0209	
Un-Biased Mean-3σ	1.9848	1.9840	1.9836	
DS MIN				
DS MIN	1.90E+00	1.80E+00	1.80E+00	V
	PASS	PASS	PASS	
DS MAX				
DS MAX	2.10E+00	2.20E+00	2.20E+00	V
	PASS	PASS	PASS	

Figure A-110-1. VBIAS @ 2K DRIVING, VREG=4.5V vs. HDR TID for the RT6804HG-1.

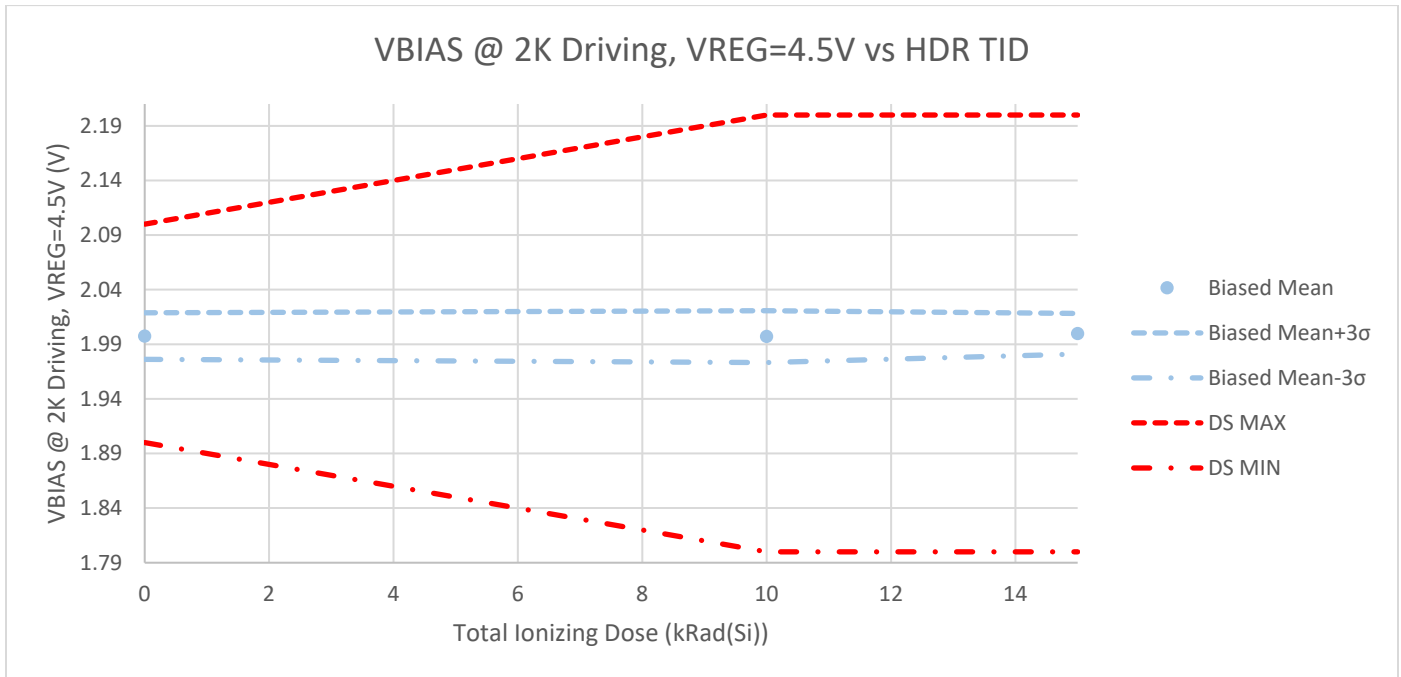

Table A-110-1. VBIAS @ 2K DRIVING, VREG=4.5V vs. HDR TID for the RT6804HG-1.

HDR TID Biased				
Total Ionizing Dose (kRad(Si))	0	10	15	Units
Biased Mean	1.9975	1.9971	1.9997	V
Std Dev	0.0071	0.0079	0.0062	
Biased Mean+3σ	2.0188	2.0208	2.0183	
Biased Mean-3σ	1.9762	1.9734	1.9812	
DS MIN	1.90E+00	1.80E+00	1.80E+00	V
	PASS	PASS	PASS	
DS MAX	2.10E+00	2.20E+00	2.20E+00	V
	PASS	PASS	PASS	

Figure A-110-2. VBIAS @ 2K DRIVING, VREG=4.5V vs. LDR TID for the RT6804HG-1.

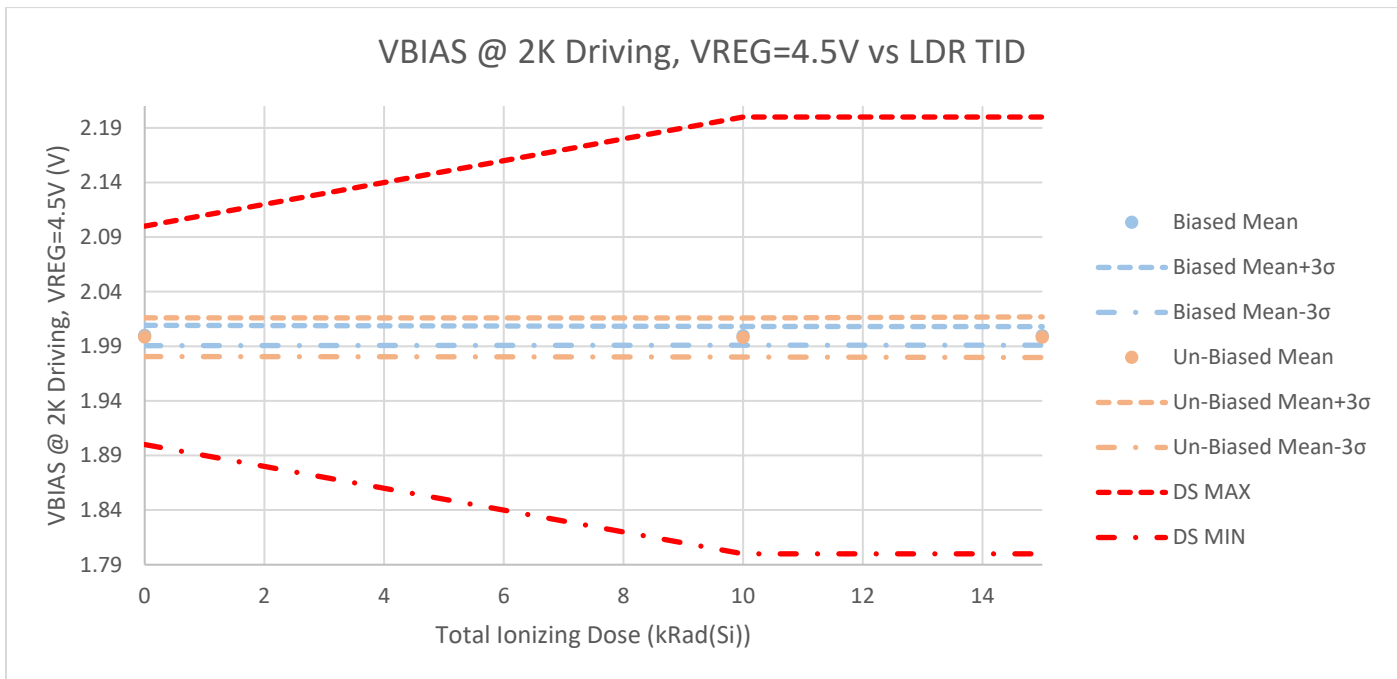

Table A-110-2. VBIAS @ 2K DRIVING, VREG=4.5V vs. LDR TID for the RT6804HG-1.

Total Ionizing Dose (kRad(Si))	0	10	15	Units
LDR TID Biased				
Biased Mean	1.9999	1.9996	1.9995	V
Std Dev	0.0031	0.0029	0.0028	
Biased Mean+3σ	2.0092	2.0082	2.0080	
Biased Mean-3σ	1.9906	1.9910	1.9911	
LDR TID Un-Biased				
Un-Biased Mean	1.9984	1.9981	1.9983	V
Std Dev	0.0059	0.0060	0.0062	
Un-Biased Mean+3σ	2.0161	2.0160	2.0169	
Un-Biased Mean-3σ	1.9807	1.9802	1.9797	
DS MIN				
DS MIN	1.90E+00	1.80E+00	1.80E+00	V
	PASS	PASS	PASS	
DS MAX				
DS MAX	2.10E+00	2.20E+00	2.20E+00	V
	PASS	PASS	PASS	

Figure A-111-1. VBIAS @ 2K DRIVING, VREG=5.5V vs. HDR TID for the RT6804HG-1.

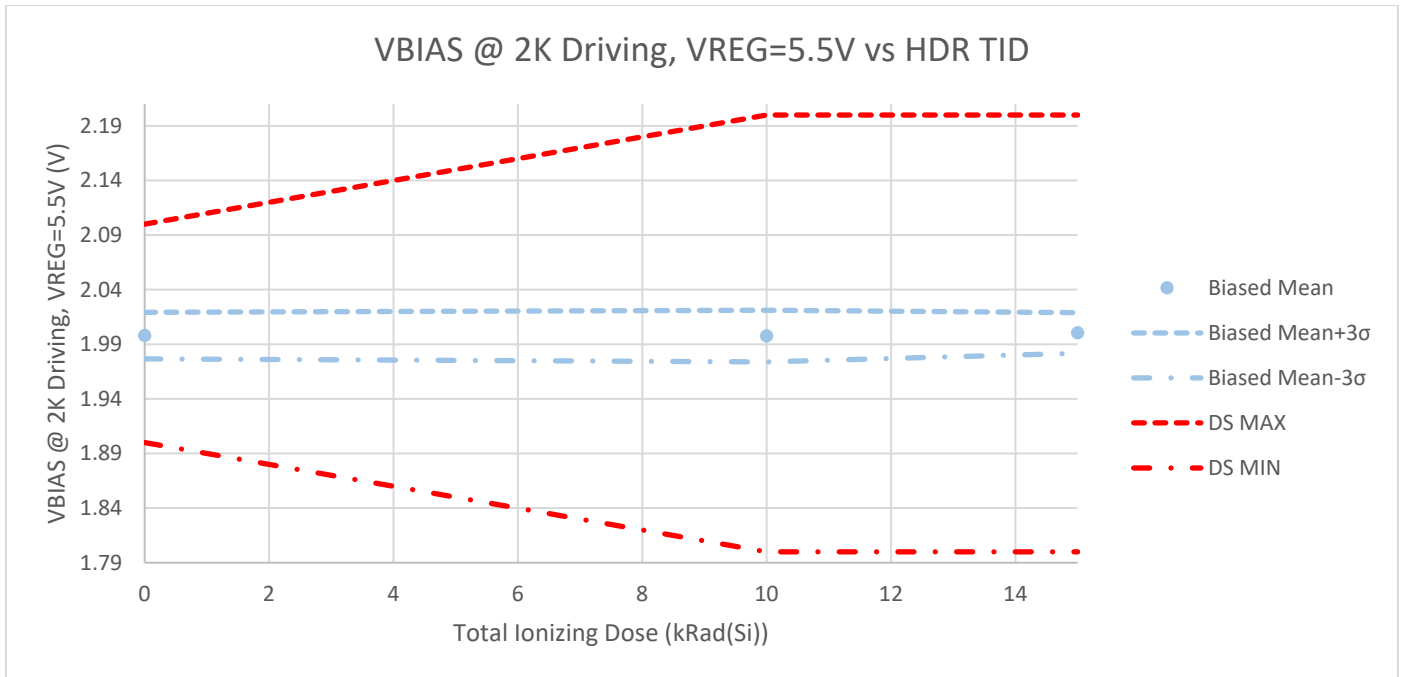

Table A-111-1. VBIAS @ 2K DRIVING, VREG=5.5V vs. HDR TID for the RT6804HG-1.

HDR TID Biased				
Total Ionizing Dose (kRad(Si))	0	10	15	Units
Biased Mean	1.9979	1.9976	2.0005	V
Std Dev	0.0071	0.0079	0.0062	
Biased Mean+3σ	2.0193	2.0213	2.0191	
Biased Mean-3σ	1.9766	1.9740	1.9819	
DS MIN	1.90E+00	1.80E+00	1.80E+00	V
	PASS	PASS	PASS	
DS MAX	2.10E+00	2.20E+00	2.20E+00	V
	PASS	PASS	PASS	

Figure A-111-2. VBIAS @ 2K DRIVING, VREG=5.5V vs. LDR TID for the RT6804HG-1.

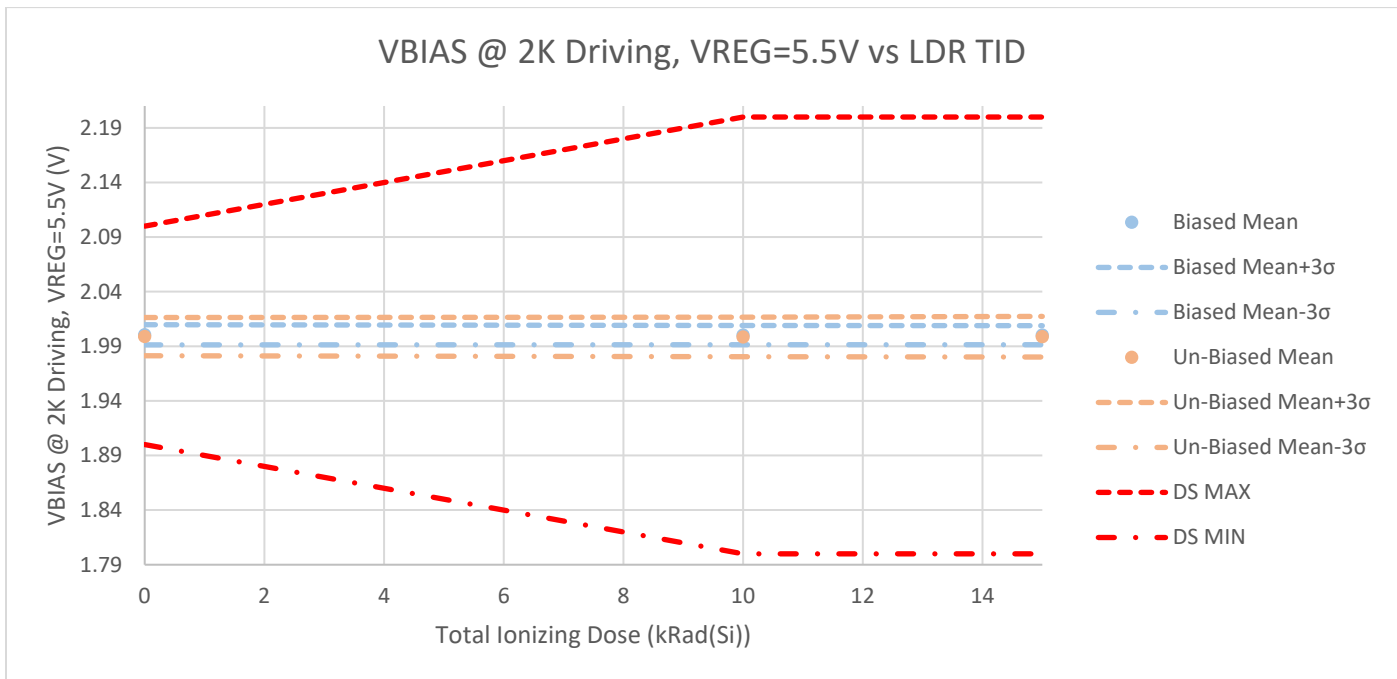

Table A-111-2. VBIAS @ 2K DRIVING, VREG=5.5V vs. LDR TID for the RT6804HG-1.

Total Ionizing Dose (kRad(Si))	0	10	15	Units
LDR TID Biased				
Biased Mean	2.0005	2.0002	2.0002	V
Std Dev	0.0031	0.0029	0.0029	
Biased Mean+3σ	2.0098	2.0089	2.0089	
Biased Mean-3σ	1.9913	1.9914	1.9914	
LDR TID Un-Biased				
Un-Biased Mean	1.9989	1.9985	1.9988	V
Std Dev	0.0058	0.0060	0.0062	
Un-Biased Mean+3σ	2.0164	2.0166	2.0174	
Un-Biased Mean-3σ	1.9814	1.9804	1.9802	
DS MIN				
DS MIN	1.90E+00	1.80E+00	1.80E+00	V
	PASS	PASS	PASS	
DS MAX				
DS MAX	2.10E+00	2.20E+00	2.20E+00	V
	PASS	PASS	PASS	

Figure A-112-1. AIBLM @ 2K, VLM=mid, VREG=4.5V vs. HDR TID for the RT6804HG-1.

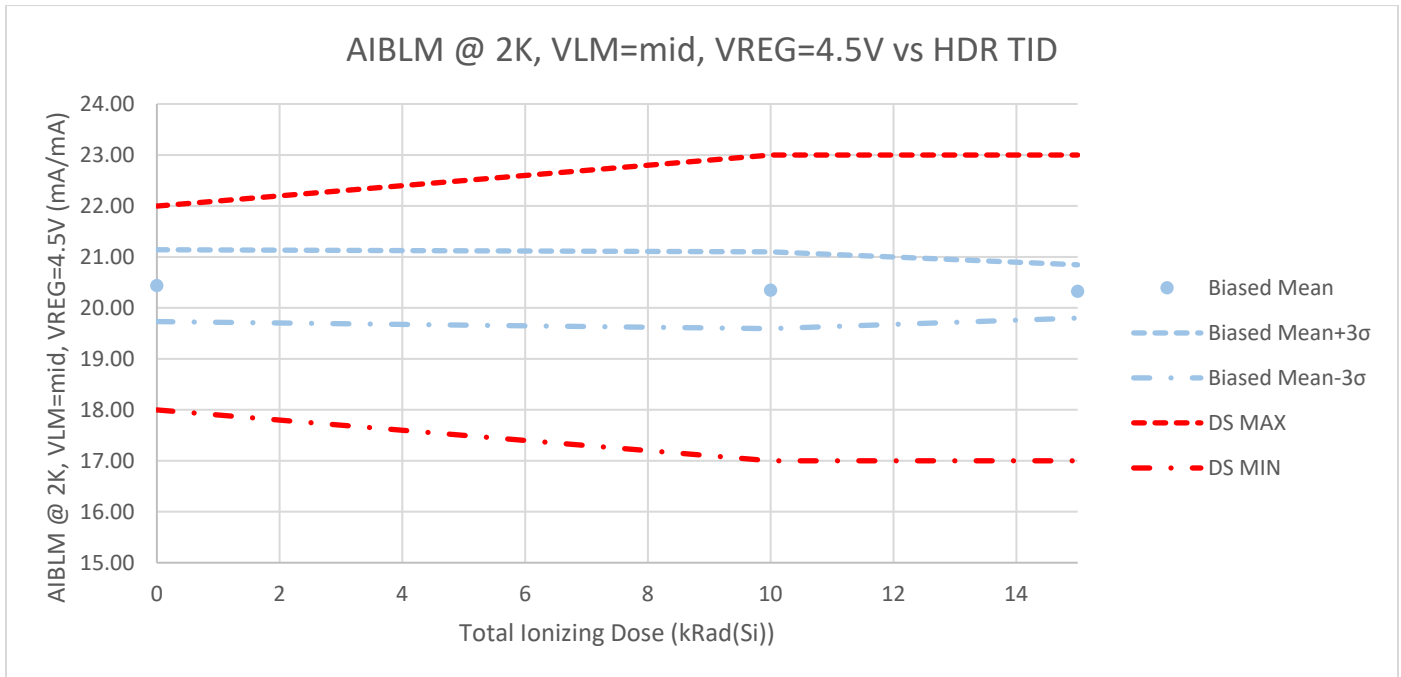

Table A-112-1. AIBLM @ 2K, VLM=mid, VREG=4.5V vs. HDR TID for the RT6804HG-1.

HDR TID Biased				
Total Ionizing Dose (kRad(Si))	0	10	15	Units
Biased Mean	20.4360	20.3457	20.3238	mA/mA
Std Dev	0.2354	0.2509	0.1742	
Biased Mean+3σ	21.1421	21.0986	20.8463	
Biased Mean-3σ	19.7300	19.5929	19.8012	
DS MIN	1.80E+01	1.70E+01	1.70E+01	mA/mA
	PASS	PASS	PASS	
DS MAX	2.20E+01	2.30E+01	2.30E+01	mA/mA
	PASS	PASS	PASS	

Figure A-112-2. AIBLM @ 2K, VLM=mid, VREG=4.5V vs. LDR TID for the RT6804HG-1.

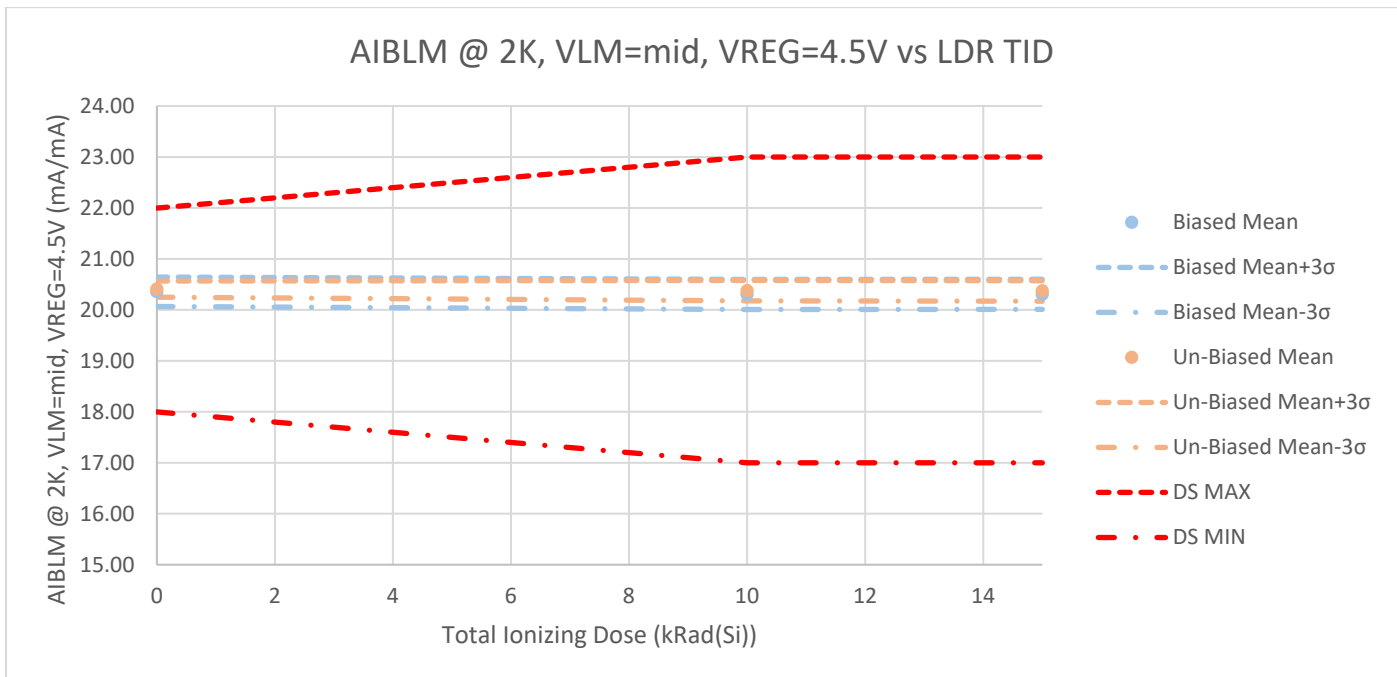

Table A-112-2. AIBLM @ 2K, VLM=mid, VREG=4.5V vs. LDR TID for the RT6804HG-1.

Total Ionizing Dose (kRad(Si))	0	10	15	Units
LDR TID Biased				
Biased Mean	20.3559	20.3036	20.3042	mA/mA
Std Dev	0.0966	0.0980	0.0981	
Biased Mean+3σ	20.6456	20.5976	20.5985	
Biased Mean-3σ	20.0662	20.0096	20.0099	
LDR TID Un-Biased				
Un-Biased Mean	20.4082	20.3783	20.3729	mA/mA
Std Dev	0.0530	0.0671	0.0667	
Un-Biased Mean+3σ	20.5672	20.5798	20.5730	
Un-Biased Mean-3σ	20.2493	20.1769	20.1728	
DS MIN				
DS MIN	1.80E+01	1.70E+01	1.70E+01	mA/mA
	PASS	PASS	PASS	
DS MAX				
DS MAX	2.20E+01	2.30E+01	2.30E+01	mA/mA
	PASS	PASS	PASS	

Figure A-113-1. AIBLM @ 2K, VLM=mid, VREG=5.5V vs. HDR TID for the RT6804HG-1.

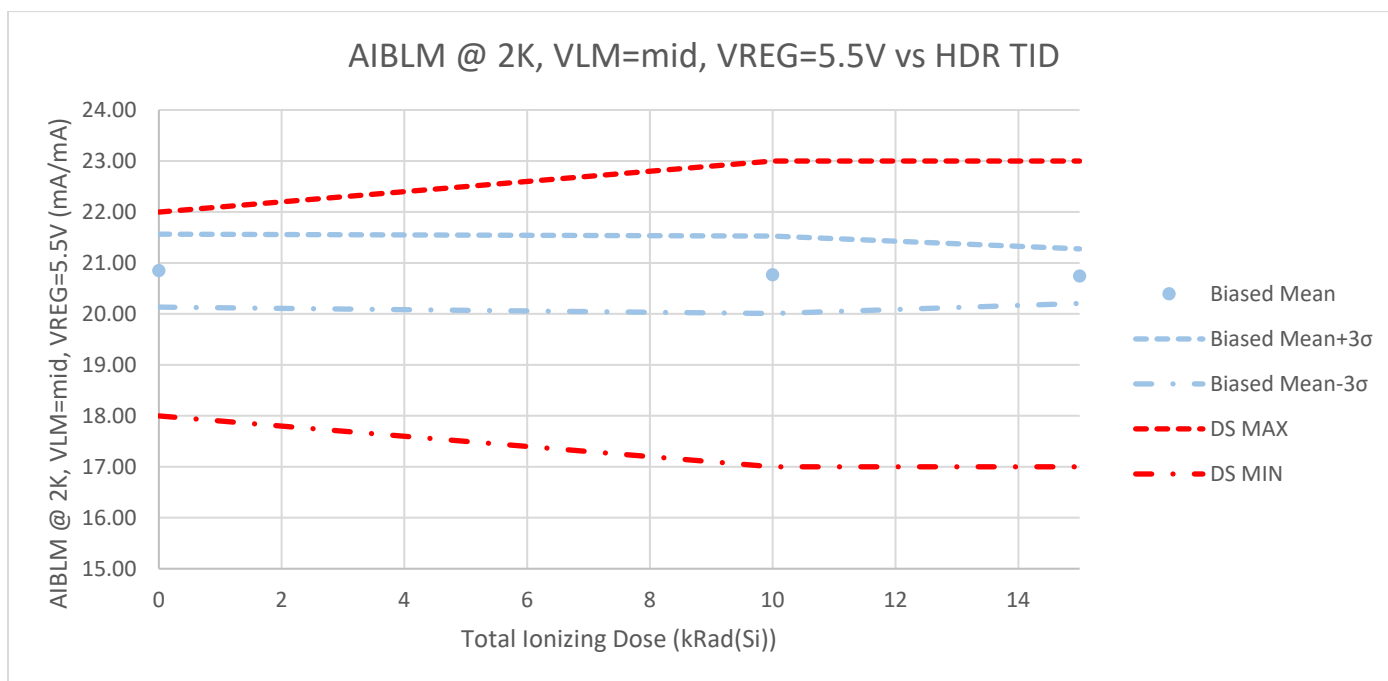

Table A-113-1. AIBLM @ 2K, VLM=mid, VREG=5.5V vs. HDR TID for the RT6804HG-1.

HDR TID Biased				
Total Ionizing Dose (kRad(Si))	0	10	15	Units
Biased Mean	20.8486	20.7673	20.7413	mA/Ma
Std Dev	0.2385	0.2534	0.1780	
Biased Mean+3σ	21.5641	21.5275	21.2752	
Biased Mean-3σ	20.1332	20.0071	20.2074	
DS MIN	1.80E+01	1.70E+01	1.70E+01	mA/mA
	PASS	PASS	PASS	
DS MAX	2.20E+01	2.30E+01	2.30E+01	mA/mA
	PASS	PASS	PASS	

Figure A-113-2. AIBLM @ 2K, VLM=mid, VREG=5.5V vs. LDR TID for the RT6804HG-1.

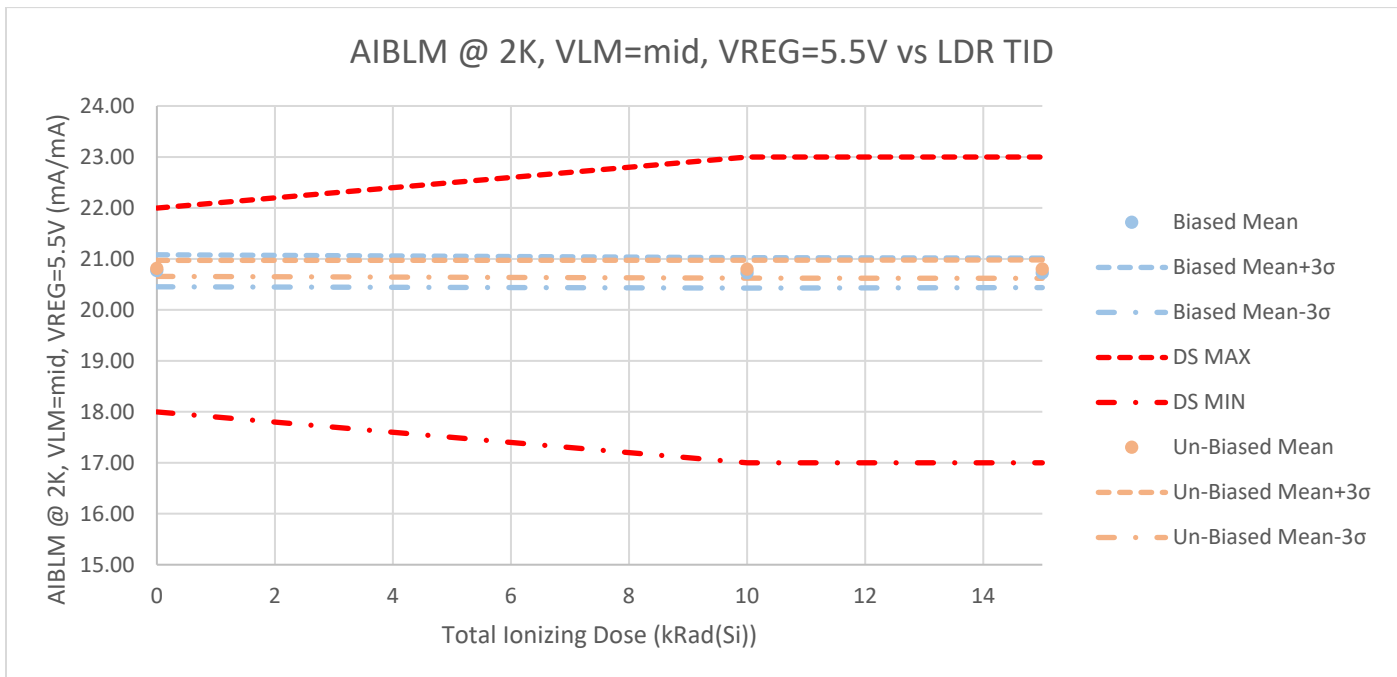

Table A-113-2. AIBLM @ 2K, VLM=mid, VREG=5.5V vs. LDR TID for the RT6804HG-1.

Total Ionizing Dose (kRad(Si))	0	10	15	Units
LDR TID Biased				
Biased Mean	20.7682	20.7262	20.7269	mA/mA
Std Dev	0.1049	0.0993	0.0966	
Biased Mean+3σ	21.0828	21.0242	21.0168	
Biased Mean-3σ	20.4535	20.4281	20.4371	
LDR TID Un-Biased				
Un-Biased Mean	20.8140	20.7976	20.7997	mA/mA
Std Dev	0.0524	0.0586	0.0602	
Un-Biased Mean+3σ	20.9712	20.9734	20.9802	
Un-Biased Mean-3σ	20.6567	20.6217	20.6193	
DS MIN				
DS MIN	1.80E+01	1.70E+01	1.70E+01	mA/mA
	PASS	PASS	PASS	
DS MAX				
DS MAX	2.20E+01	2.30E+01	2.30E+01	mA/mA
	PASS	PASS	PASS	

Figure A-114-1. AIBHM @ 2K, VHM=mid, VREG=4.5V vs. HDR TID for the RT6804HG-1.

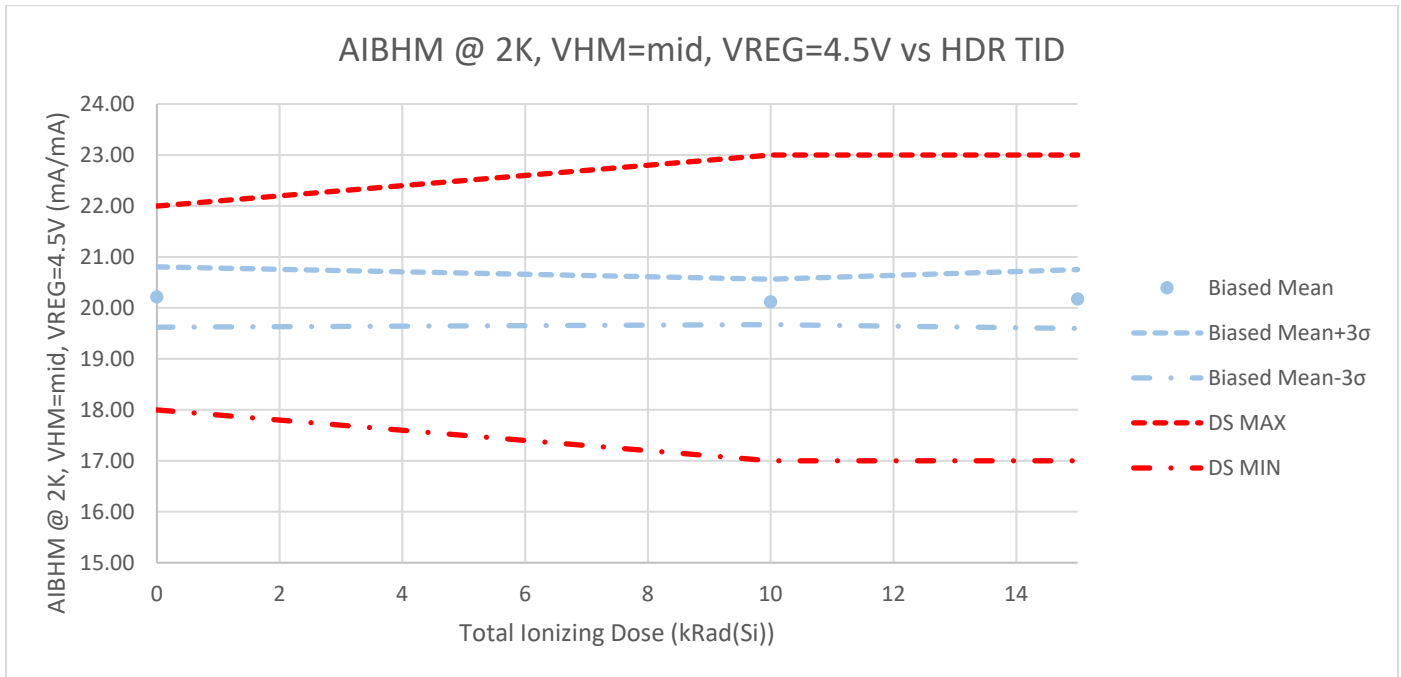

Table A-114-1. AIBHM @ 2K, VHM=mid, VREG=4.5V vs. HDR TID for the RT6804HG-1.

HDR TID Biased				
Total Ionizing Dose (kRad(Si))	0	10	15	Units
Biased Mean	20.2129	20.1177	20.1742	mA/Ma
Std Dev	0.1977	0.1482	0.1919	
Biased Mean+3σ	20.8061	20.5624	20.7500	
Biased Mean-3σ	19.6197	19.6730	19.5984	
DS MIN	1.80E+01	1.70E+01	1.70E+01	mA/mA
	PASS	PASS	PASS	
DS MAX	2.20E+01	2.30E+01	2.30E+01	mA/mA
	PASS	PASS	PASS	

Figure A-114-2. AIBHM @ 2K, VHM=mid, VREG=4.5V vs. LDR TID for the RT6804HG-1.

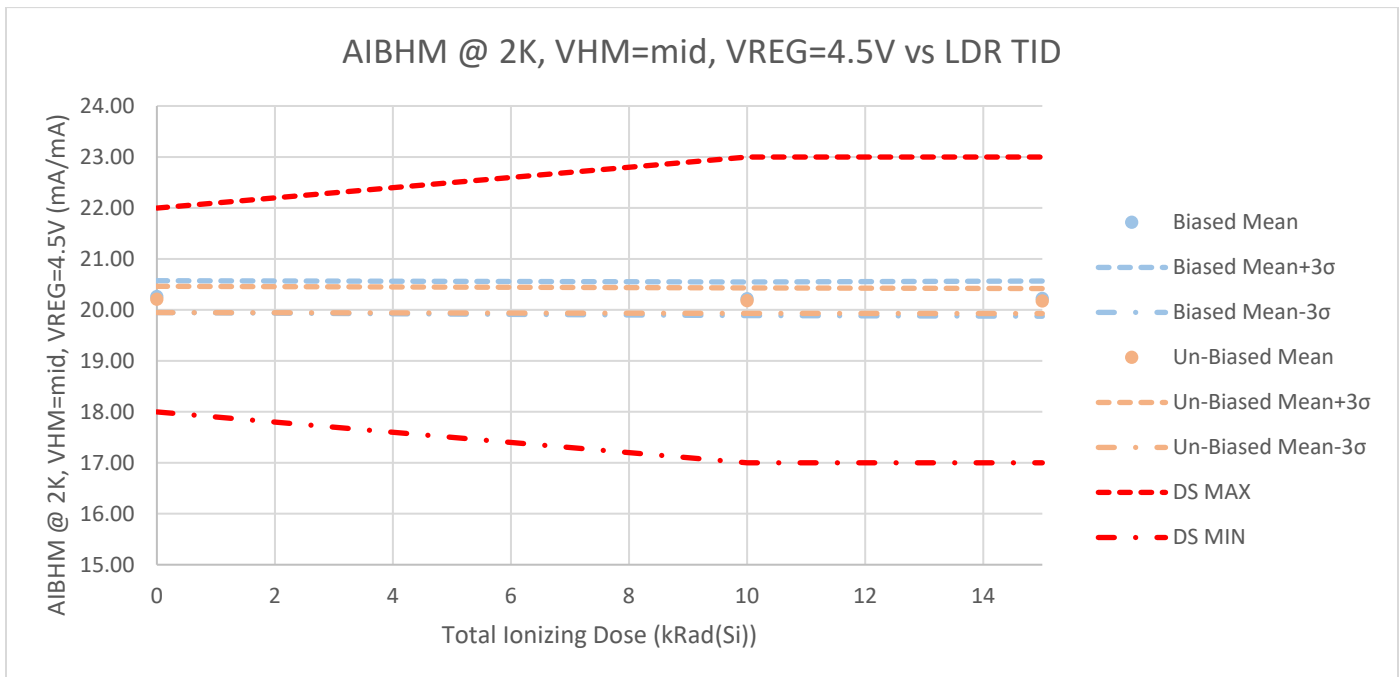

Table A-114-2. AIBHM @ 2K, VHM=mid, VREG=4.5V vs. LDR TID for the RT6804HG-1.

Total Ionizing Dose (kRad(Si))	0	10	15	Units
LDR TID Biased				
Biased Mean	20.2617	20.2182	20.2221	mA/mA
Std Dev	0.1039	0.1104	0.1150	
Biased Mean+3σ	20.5735	20.5494	20.5670	
Biased Mean-3σ	19.9499	19.8869	19.8773	
LDR TID Un-Biased				
Un-Biased Mean	20.2069	20.1807	20.1744	mA/mA
Std Dev	0.0858	0.0836	0.0817	
Un-Biased Mean+3σ	20.4644	20.4314	20.4196	
Un-Biased Mean-3σ	19.9494	19.9300	19.9291	
DS MIN				
DS MIN	1.80E+01	1.70E+01	1.70E+01	mA/mA
	PASS	PASS	PASS	
DS MAX				
DS MAX	2.20E+01	2.30E+01	2.30E+01	mA/mA
	PASS	PASS	PASS	

Figure A-115-1. AIBHM @ 2K, VHM=mid, VREG=5.5V vs. HDR TID for the RT6804HG-1.

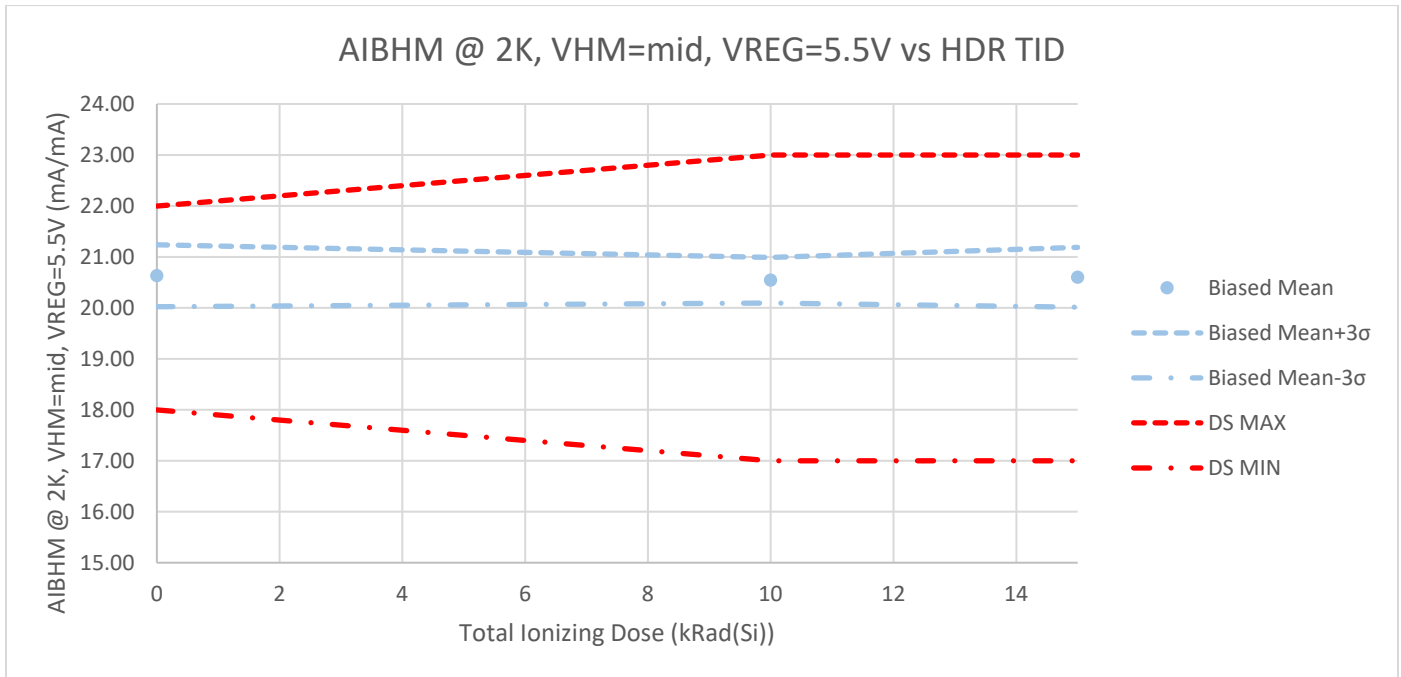

Table A-115-1. AIBHM @ 2K, VHM=mid, VREG=5.5V vs. HDR TID for the RT6804HG-1.

HDR TID Biased				
Total Ionizing Dose (kRad(Si))	0	10	15	Units
Biased Mean	20.6302	20.5425	20.6011	mA/Ma
Std Dev	0.2026	0.1490	0.1951	
Biased Mean+3σ	21.2378	20.9895	21.1864	
Biased Mean-3σ	20.0225	20.0956	20.0158	
DS MIN	1.80E+01	1.70E+01	1.70E+01	mA/mA
	PASS	PASS	PASS	
DS MAX	2.20E+01	2.30E+01	2.30E+01	mA/mA
	PASS	PASS	PASS	

Figure A-115-2. AIBHM @ 2K, VHM=mid, VREG=5.5V vs. LDR TID for the RT6804HG-1.

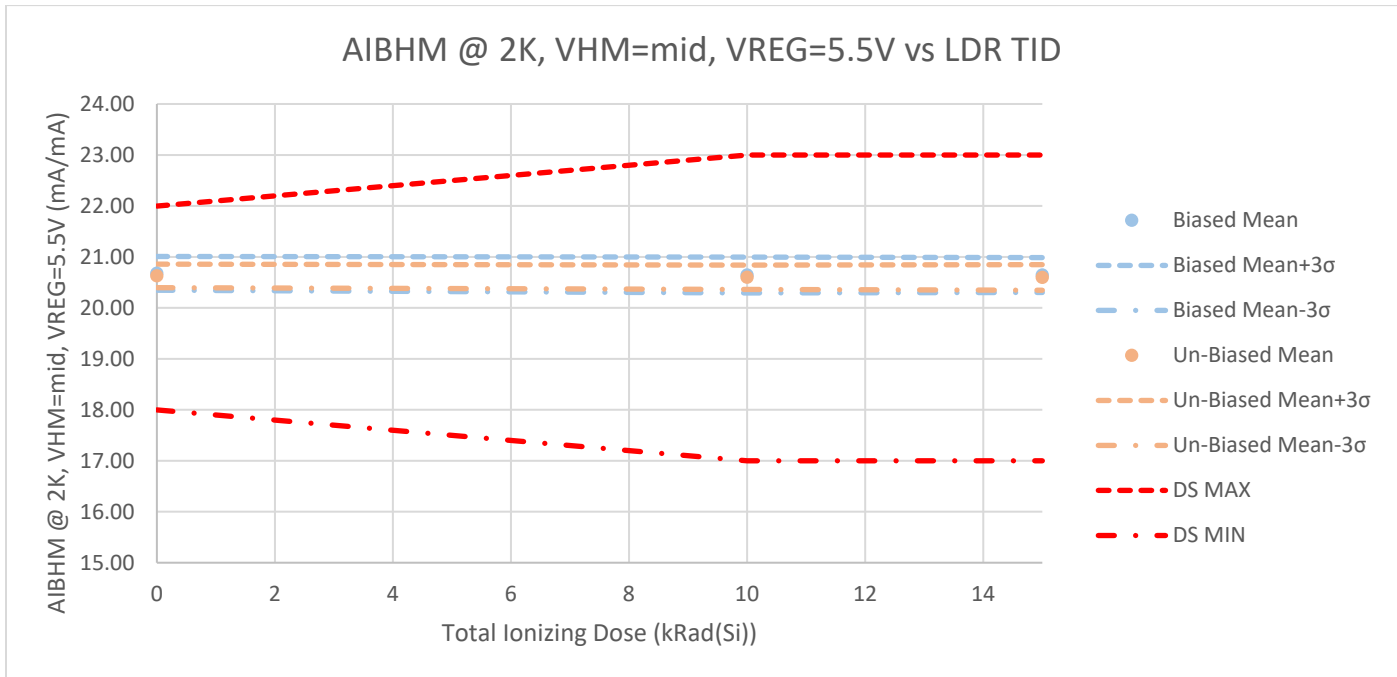

Table A-115-2. AIBHM @ 2K, VHM=mid, VREG=5.5V vs. LDR TID for the RT6804HG-1.

Total Ionizing Dose (kRad(Si))	0	10	15	Units
LDR TID Biased				
Biased Mean	20.6787	20.6453	20.6439	mA/mA
Std Dev	0.1103	0.1168	0.1144	
Biased Mean+3σ	21.0095	20.9958	20.9872	
Biased Mean-3σ	20.3479	20.2949	20.3006	
LDR TID Un-Biased				
Un-Biased Mean	20.6276	20.6014	20.5968	mA/mA
Std Dev	0.0768	0.0796	0.0835	
Un-Biased Mean+3σ	20.8580	20.8404	20.8473	
Un-Biased Mean-3σ	20.3973	20.3625	20.3464	
DS MIN				
DS MIN	1.80E+01	1.70E+01	1.70E+01	mA/mA
	PASS	PASS	PASS	
DS MAX				
DS MAX	2.20E+01	2.30E+01	2.30E+01	mA/mA
	PASS	PASS	PASS	

Figure A-116-1. DATA positive pulse width, IHP vs. HDR TID for the RT6804HG-1.

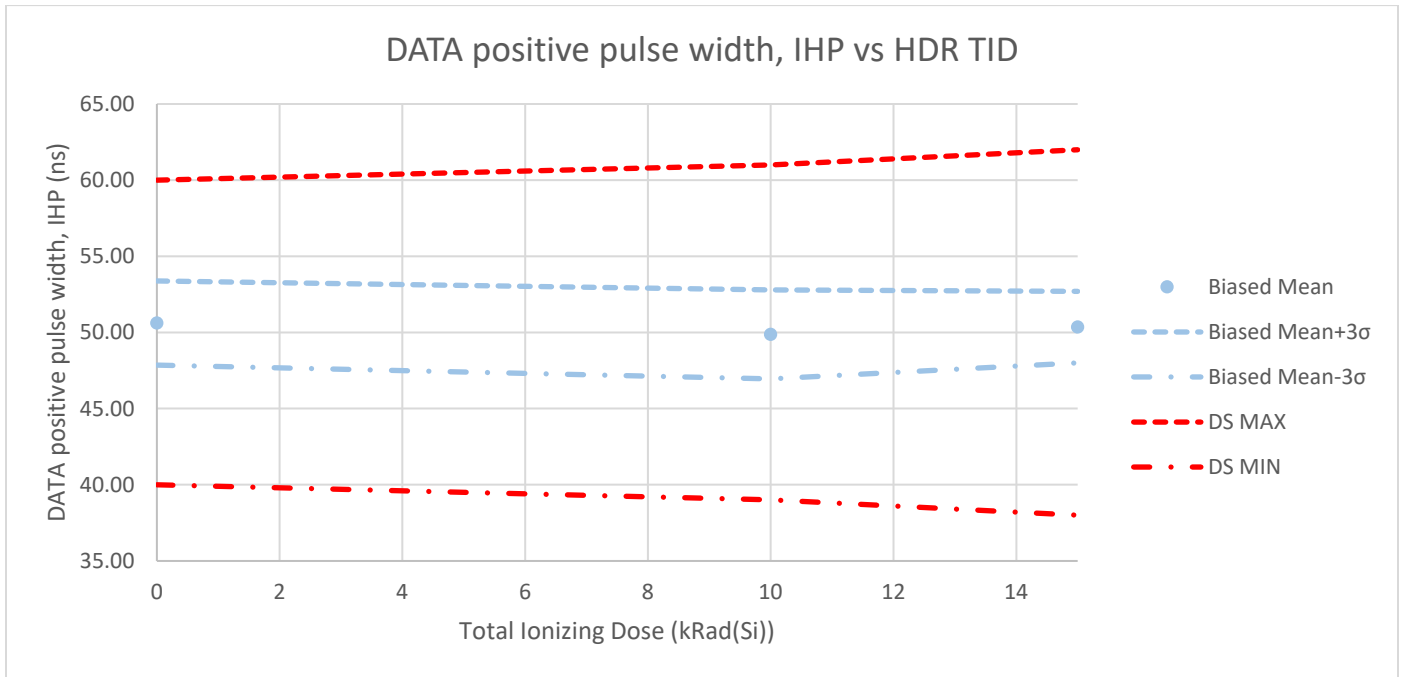

Table A-116-1. DATA positive pulse width, IHP vs. HDR TID for the RT6804HG-1.

HDR TID Biased				
Total Ionizing Dose (kRad(Si))	0	10	15	Units
Biased Mean	50.6195	49.8703	50.3511	ns
Std Dev	0.9216	0.9735	0.7819	
Biased Mean+3σ	53.3842	52.7907	52.6969	
Biased Mean-3σ	47.8547	46.9498	48.0054	
DS MIN	4.00E+01	3.90E+01	3.80E+01	ns
	PASS	PASS	PASS	
DS MAX	6.00E+01	6.10E+01	6.20E+01	ns
	PASS	PASS	PASS	

Figure A-116-2. DATA positive pulse width, IHP vs. LDR TID for the RT6804HG-1.

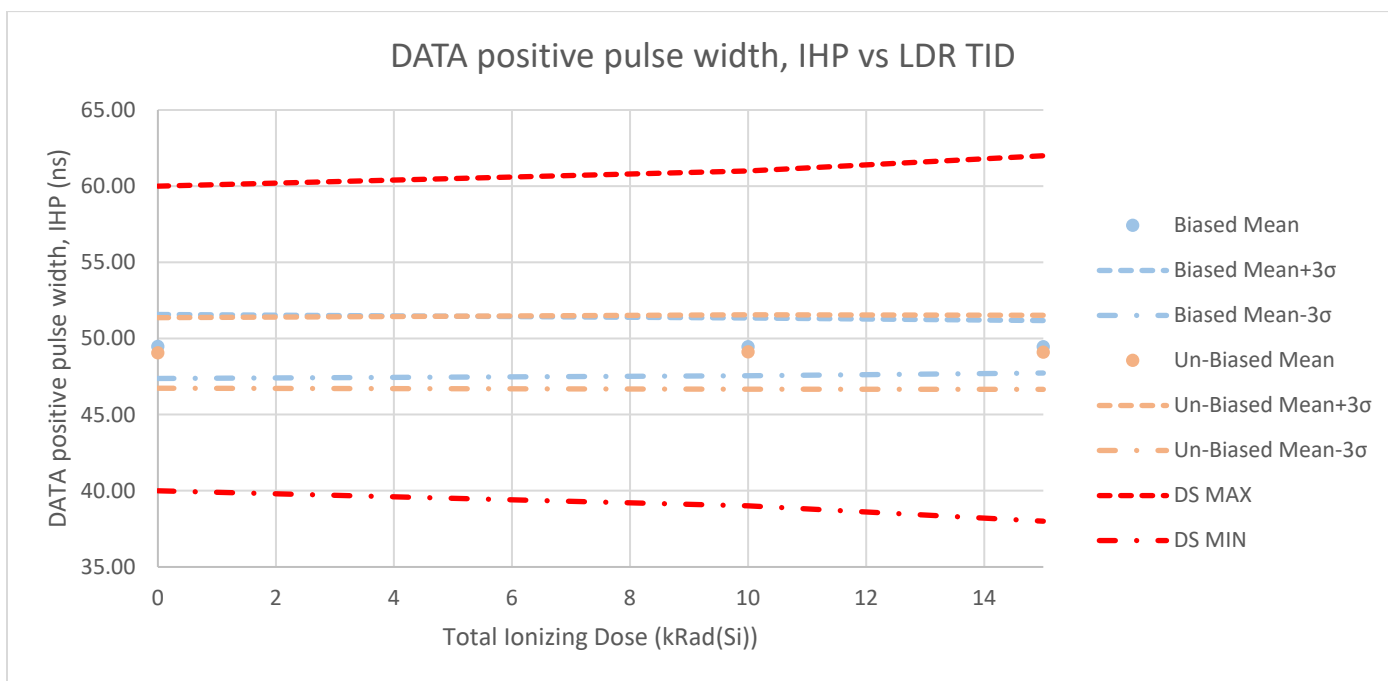

Table A-116-2. DATA positive pulse width, IHP vs. LDR TID for the RT6804HG-1.

Total Ionizing Dose (kRad(Si))	0	10	15	Units
LDR TID Biased				
Biased Mean	49.4734	49.4473	49.4527	ns
Std Dev	0.7016	0.6322	0.5755	
Biased Mean+3σ	51.5783	51.3438	51.1792	
Biased Mean-3σ	47.3686	47.5507	47.7262	
LDR TID Un-Biased				
Un-Biased Mean	49.0497	49.1114	49.0865	ns
Std Dev	0.7721	0.8147	0.8107	
Un-Biased Mean+3σ	51.3659	51.5555	51.5186	
Un-Biased Mean-3σ	46.7335	46.6674	46.6544	
DS Limits				
DS MIN	4.00E+01	3.90E+01	3.80E+01	ns
	PASS	PASS	PASS	
DS MAX	6.00E+01	6.10E+01	6.20E+01	ns
	PASS	PASS	PASS	

Figure A-117-1. DATA positive pulse width, IHM vs. HDR TID for the RT6804HG-1.

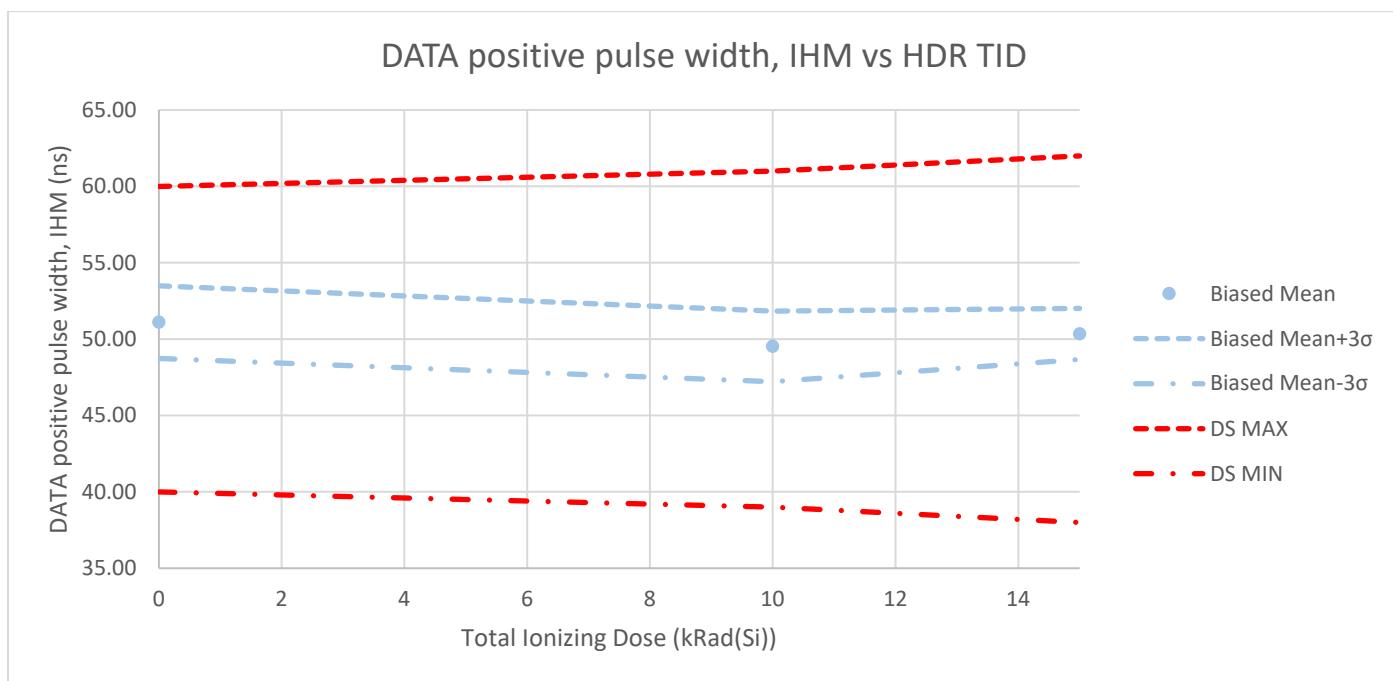

Table A-117-1. DATA positive pulse width, IHM vs. HDR TID for the RT6804HG-1.

HDR TID Biased				
Total Ionizing Dose (kRad(Si))	0	10	15	Units
Biased Mean	51.1091	49.5281	50.3394	ns
Std Dev	0.7924	0.7705	0.5565	
Biased Mean+3σ	53.4863	51.8395	52.0090	
Biased Mean-3σ	48.7319	47.2166	48.6698	
DS MIN	4.00E+01	3.90E+01	3.80E+01	ns
	PASS	PASS	PASS	
DS MAX	6.00E+01	6.10E+01	6.20E+01	ns
	PASS	PASS	PASS	

Figure A-117-2. DATA positive pulse width, IHM vs. LDR TID for the RT6804HG-1.

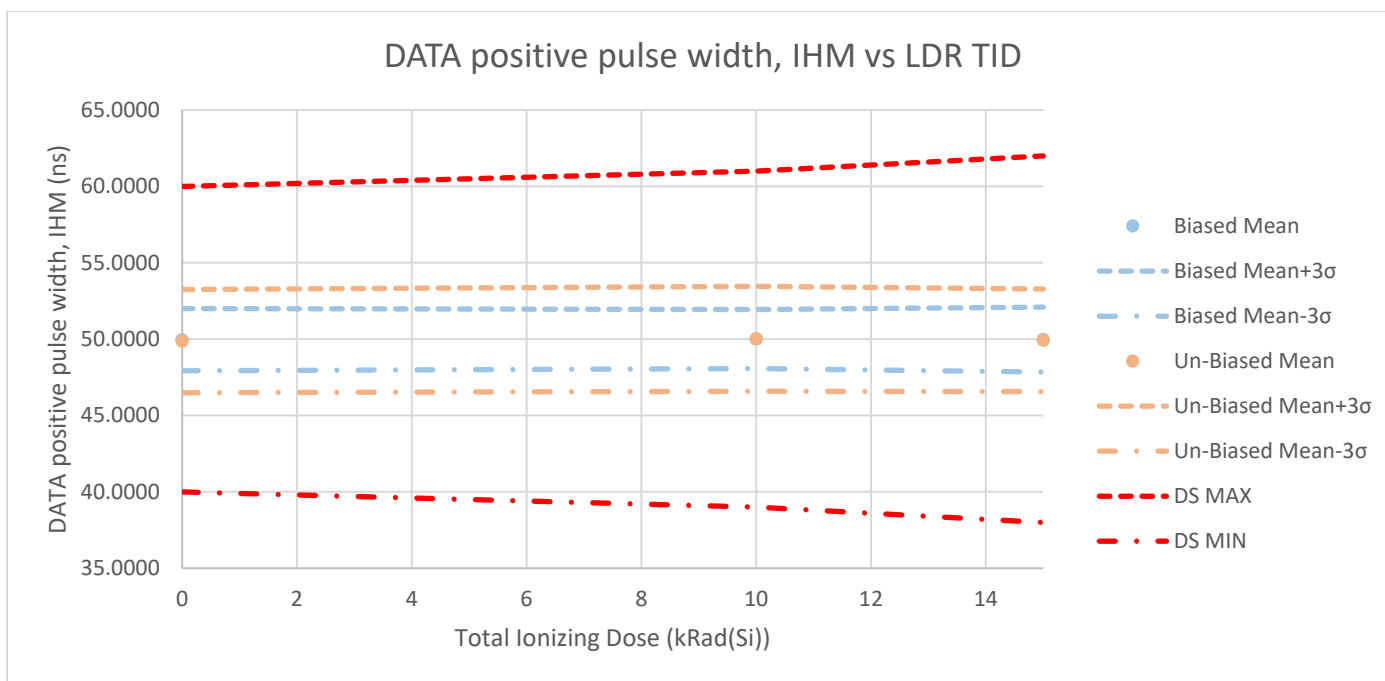

Table A-117-2. DATA positive pulse width, IHM vs. LDR TID for the RT6804HG-1.

Total Ionizing Dose (kRad(Si))	0	10	15	Units
LDR TID Biased				
Biased Mean	49.9585	50.0102	49.9721	ns
Std Dev	0.6798	0.6447	0.7100	
Biased Mean+3σ	51.9979	51.9442	52.1021	
Biased Mean-3σ	47.9192	48.0762	47.8421	
LDR TID Un-Biased				
Un-Biased Mean	49.8680	50.0204	49.9208	ns
Std Dev	1.1255	1.1459	1.1186	
Un-Biased Mean+3σ	53.2445	53.4580	53.2765	
Un-Biased Mean-3σ	46.4916	46.5827	46.5650	
DS MIN				
DS MIN	4.00E+01	3.90E+01	3.80E+01	ns
	PASS	PASS	PASS	
DS MAX				
DS MAX	6.00E+01	6.10E+01	6.20E+01	ns
	PASS	PASS	PASS	

Figure A-118-1. DATA negative pulse width, IHP vs. HDR TID for the RT6804HG-1.

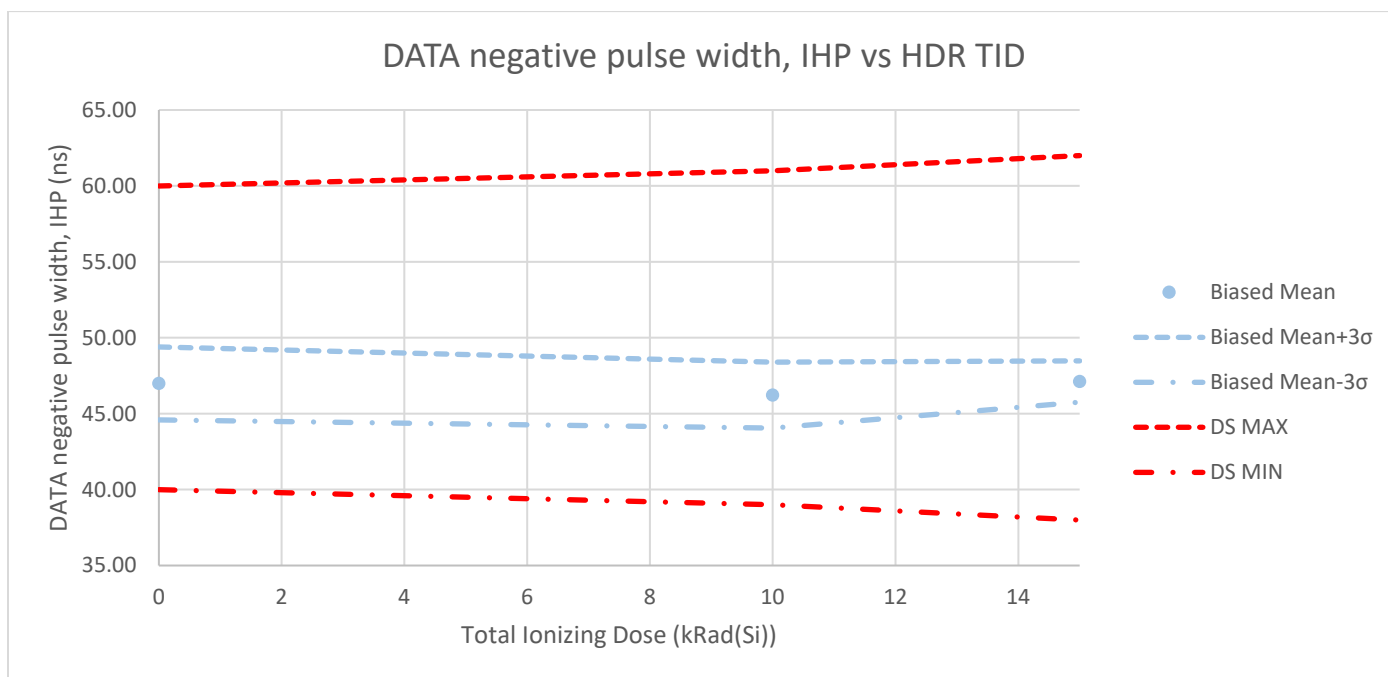

Table A-118-1. DATA negative pulse width, IHP vs. HDR TID for the RT6804HG-1.

HDR TID Biased				
Total Ionizing Dose (kRad(Si))	0	10	15	Units
Biased Mean	46.9946	46.2247	47.1190	ns
Std Dev	0.8011	0.7250	0.4529	
Biased Mean+3σ	49.3980	48.3997	48.4778	
Biased Mean-3σ	44.5913	44.0496	45.7601	
DS MIN	4.00E+01	3.90E+01	3.80E+01	ns
	PASS	PASS	PASS	
DS MAX	6.00E+01	6.10E+01	6.20E+01	ns
	PASS	PASS	PASS	

Figure A-118-2. DATA negative pulse width, IHP vs. LDR TID for the RT6804HG-1.

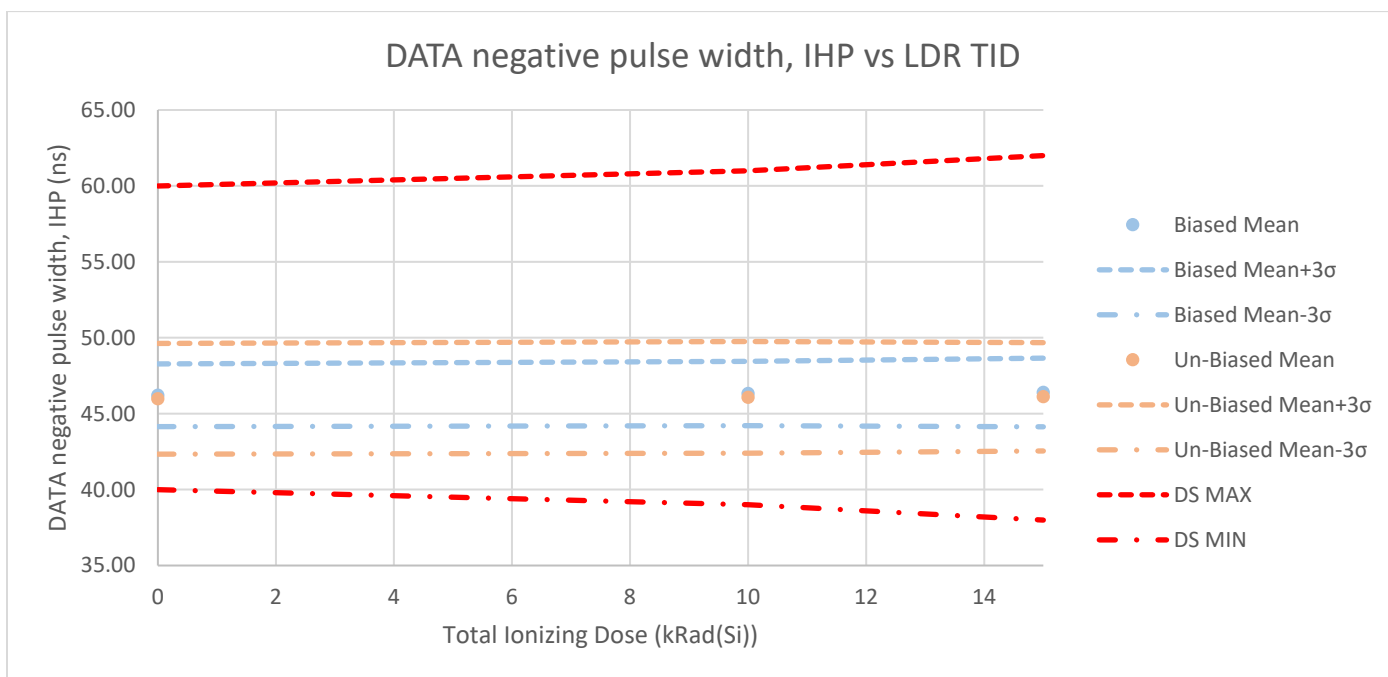

Table A-118-2. DATA negative pulse width, IHP vs. LDR TID for the RT6804HG-1.

Total Ionizing Dose (kRad(Si))	0	10	15	Units
LDR TID Biased				
Biased Mean	46.2099	46.3263	46.3996	ns
Std Dev	0.6891	0.7061	0.7532	
Biased Mean+3σ	48.2772	48.4445	48.6591	
Biased Mean-3σ	44.1426	44.2081	44.1401	
LDR TID Un-Biased				
Un-Biased Mean	45.9834	46.0781	46.1154	ns
Std Dev	1.2167	1.2266	1.1875	
Un-Biased Mean+3σ	49.6335	49.7579	49.6781	
Un-Biased Mean-3σ	42.3332	42.3982	42.5528	
DS MIN				
DS MIN	4.00E+01	3.90E+01	3.80E+01	ns
	PASS	PASS	PASS	
DS MAX				
DS MAX	6.00E+01	6.10E+01	6.20E+01	ns
	PASS	PASS	PASS	

Figure A-119-1. DATA negative pulse width, IHM vs. HDR TID for the RT6804HG-1.

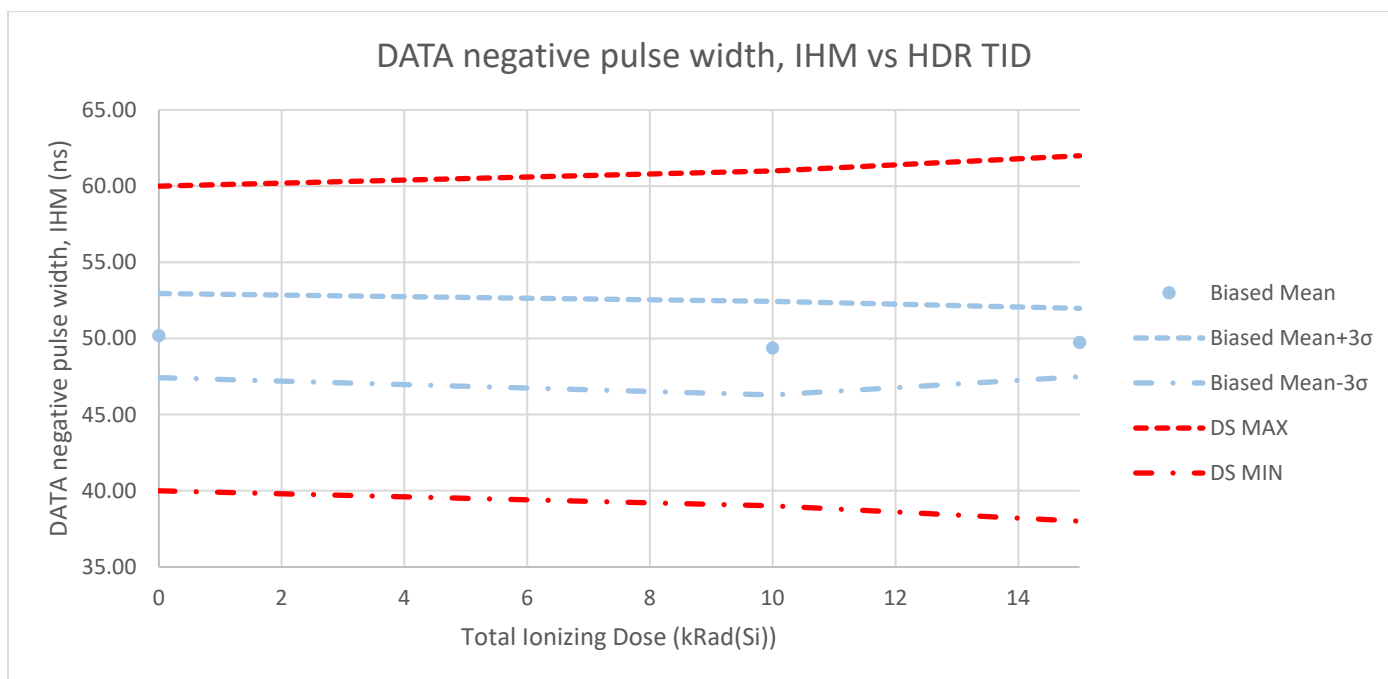

Table A-119-1. DATA negative pulse width, IHM vs. HDR TID for the RT6804HG-1.

HDR TID Biased				
Total Ionizing Dose (kRad(Si))	0	10	15	Units
Biased Mean	50.1890	49.3632	49.7349	ns
Std Dev	0.9218	1.0230	0.7483	
Biased Mean+3σ	52.9543	52.4323	51.9800	
Biased Mean-3σ	47.4236	46.2941	47.4899	
DS MIN	4.00E+01	3.90E+01	3.80E+01	ns
	PASS	PASS	PASS	
DS MAX	6.00E+01	6.10E+01	6.20E+01	ns
	PASS	PASS	PASS	

Figure A-119-2. DATA negative pulse width, IHM vs. LDR TID for the RT6804HG-1.

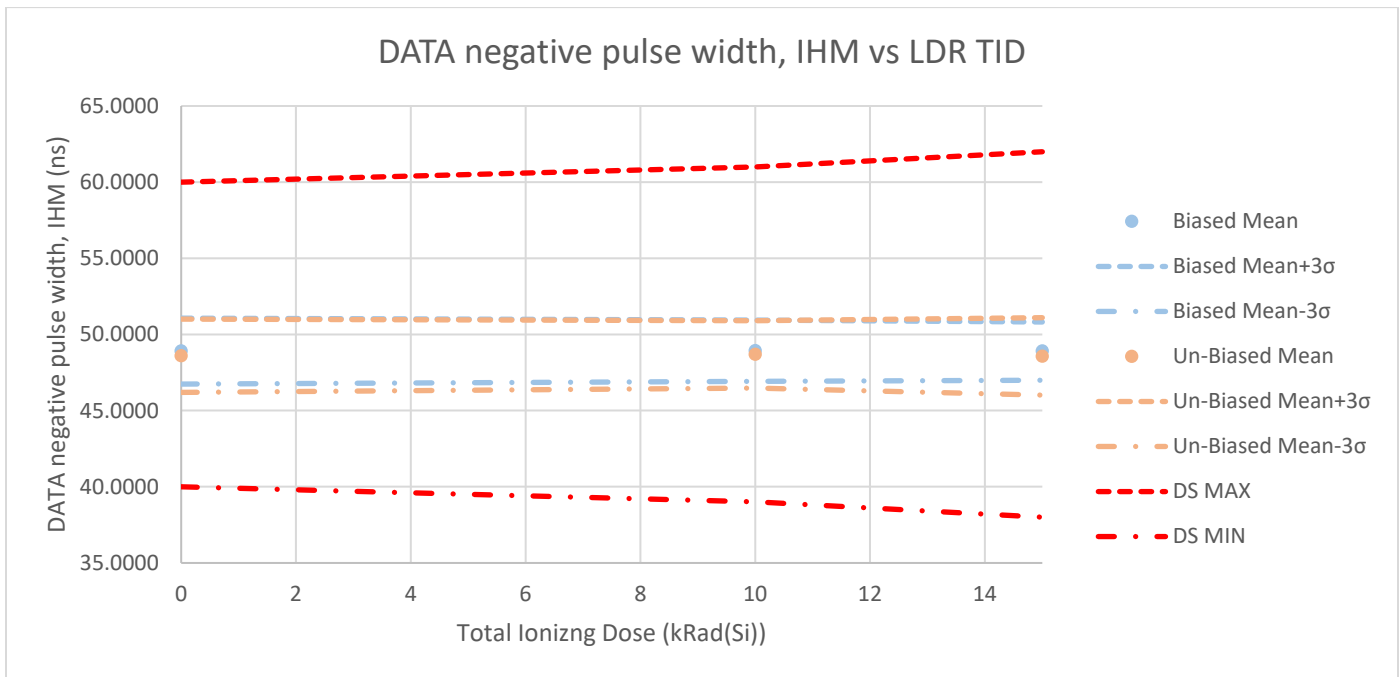

Table A-119-2. DATA negative pulse width, IHM vs. LDR TID for the RT6804HG-1.

Total Ionizing Dose (kRad(Si))	0	10	15	Units
LDR TID Biased				
Biased Mean	48.9116	48.9318	48.9090	ns
Std Dev	0.7217	0.6713	0.6379	
Biased Mean+3σ	51.0767	50.9456	50.8226	
Biased Mean-3σ	46.7465	46.9180	46.9954	
LDR TID Un-Biased				
Un-Biased Mean	48.5972	48.6932	48.5618	ns
Std Dev	0.8022	0.7362	0.8472	
Un-Biased Mean+3σ	51.0037	50.9019	51.1033	
Un-Biased Mean-3σ	46.1906	46.4845	46.0203	
DS MIN				
DS MIN	4.00E+01	3.90E+01	3.80E+01	ns
	PASS	PASS	PASS	
DS MAX				
DS MAX	6.00E+01	6.10E+01	6.20E+01	ns
	PASS	PASS	PASS	

Figure A-120-1. DATA negative pulse width, ILP vs. HDR TID for the RT6804HG-1.

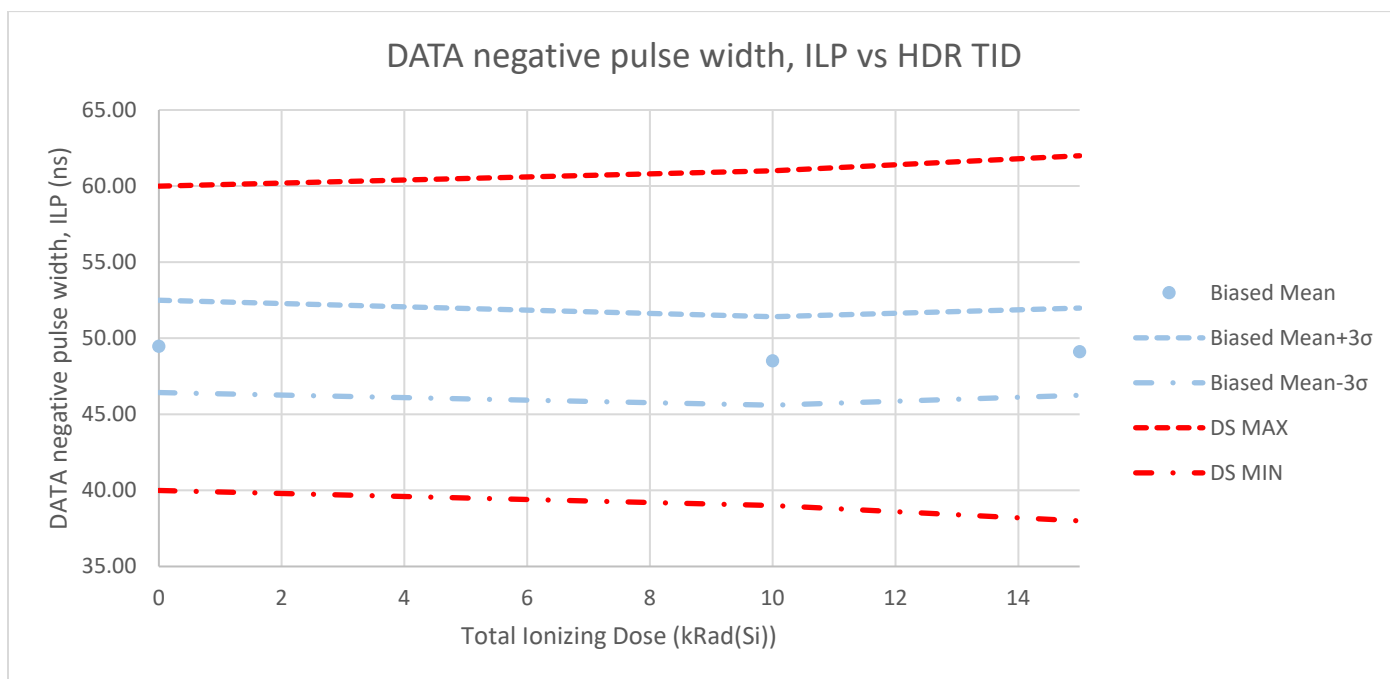

Table A-120-1. DATA negative pulse width, ILP vs. HDR TID for the RT6804HG-1.

HDR TID Biased				
Total Ionizing Dose (kRad(Si))	0	10	15	Units
Biased Mean	49.4630	48.5112	49.1118	ns
Std Dev	1.0115	0.9702	0.9551	
Biased Mean+3σ	52.4974	51.4216	51.9771	
Biased Mean-3σ	46.4286	45.6007	46.2466	
DS MIN	4.00E+01	3.90E+01	3.80E+01	ns
	PASS	PASS	PASS	
DS MAX	6.00E+01	6.10E+01	6.20E+01	ns
	PASS	PASS	PASS	

Figure A-120-2. DATA negative pulse width, ILP vs. LDR TID for the RT6804HG-1.

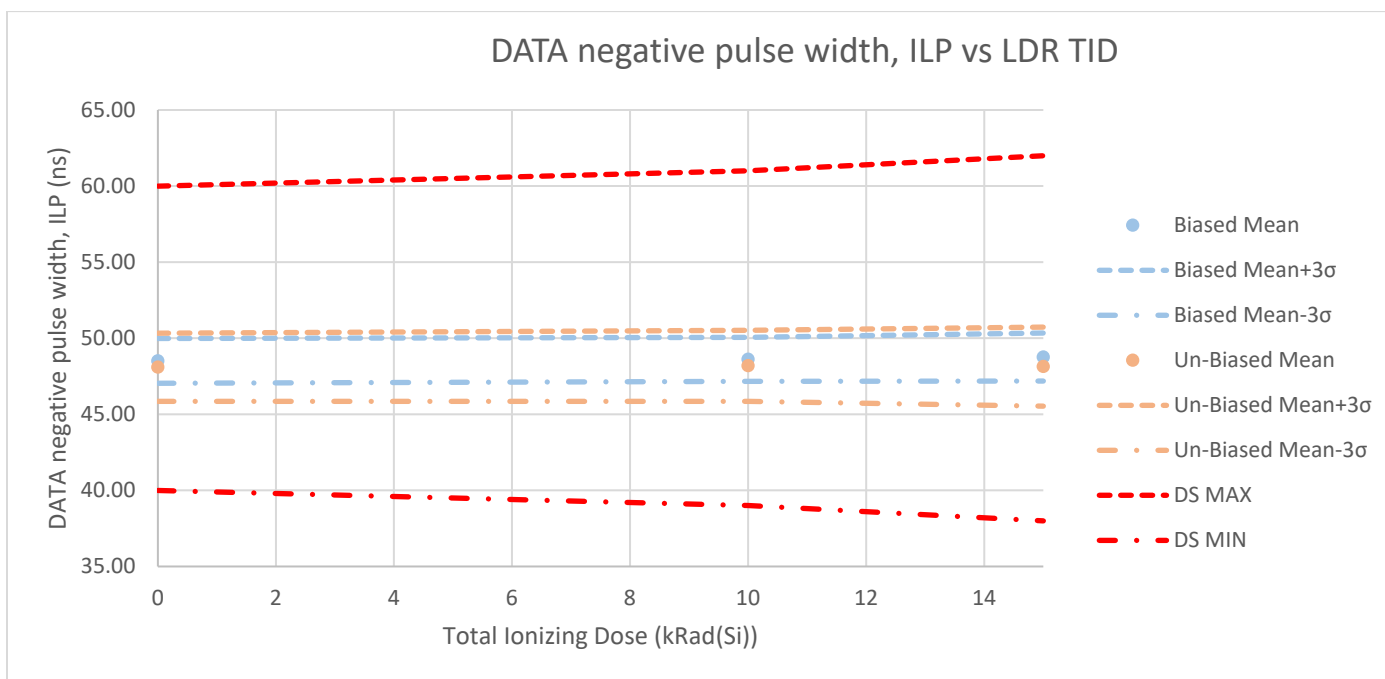

Table A-120-2. DATA negative pulse width, ILP vs. LDR TID for the RT6804HG-1.

Total Ionizing Dose (kRad(Si))	0	10	15	Units
LDR TID Biased				
Biased Mean	48.5143	48.6142	48.7620	ns
Std Dev	0.4915	0.4819	0.5258	
Biased Mean+3σ	49.9887	50.0599	50.3393	
Biased Mean-3σ	47.0399	47.1685	47.1846	
LDR TID Un-Biased				
Un-Biased Mean	48.0950	48.1894	48.1396	ns
Std Dev	0.7480	0.7769	0.8658	
Un-Biased Mean+3σ	50.3391	50.5200	50.7371	
Un-Biased Mean-3σ	45.8509	45.8588	45.5421	
DS MIN				
DS MIN	4.00E+01	3.90E+01	3.80E+01	ns
	PASS	PASS	PASS	
DS MAX				
DS MAX	6.00E+01	6.10E+01	6.20E+01	ns
	PASS	PASS	PASS	

Figure A-121-1. DATA negative pulse width, ILM vs. HDR TID for the RT6804HG-1.

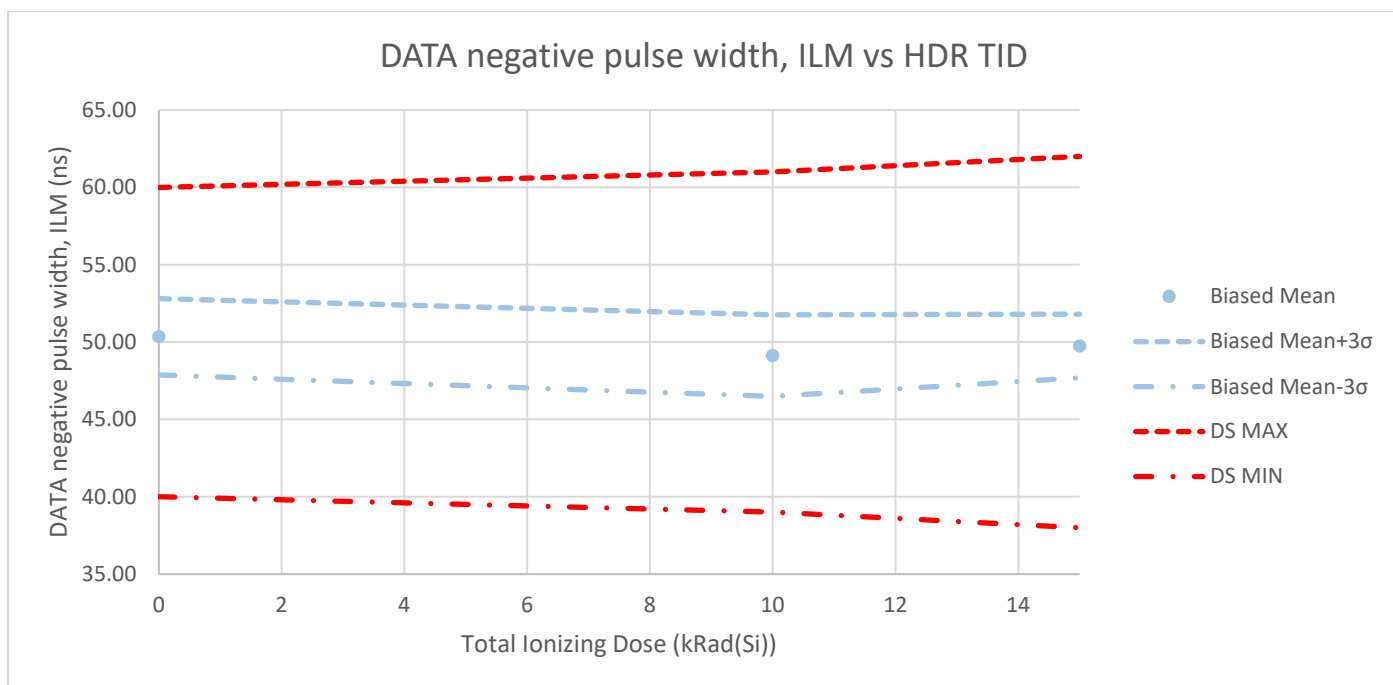

Table A-121-1. DATA negative pulse width, ILM vs. HDR TID for the RT6804HG-1.

HDR TID Biased				
Total Ionizing Dose (kRad(Si))	0	10	15	Units
Biased Mean	50.3383	49.1250	49.7436	ns
Std Dev	0.8223	0.8800	0.6861	
Biased Mean+3σ	52.8051	51.7651	51.8020	
Biased Mean-3σ	47.8715	46.4849	47.6852	
DS MIN	4.00E+01	3.90E+01	3.80E+01	ns
	PASS	PASS	PASS	
DS MAX	6.00E+01	6.10E+01	6.20E+01	ns
	PASS	PASS	PASS	

Figure A-121-2. DATA negative pulse width, ILM vs. LDR TID for the RT6804HG-1.

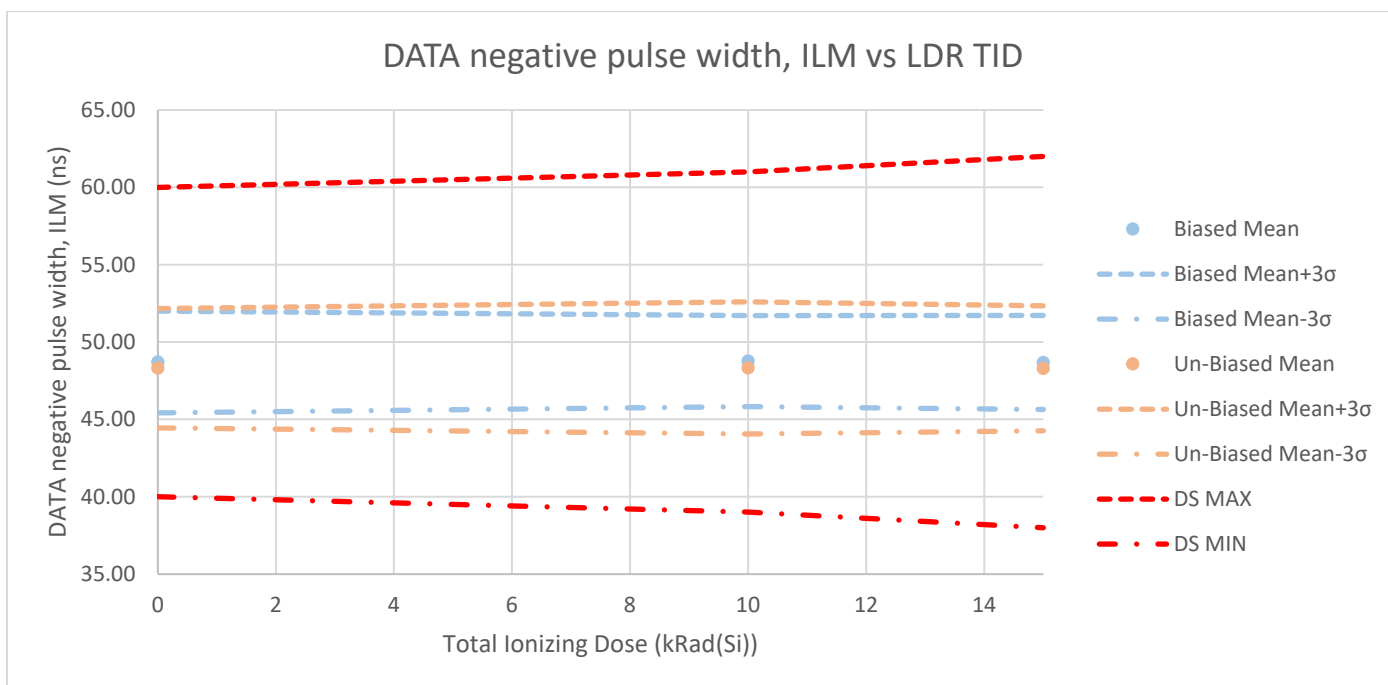

Table A-121-2. DATA negative pulse width, ILM vs. LDR TID for the RT6804HG-1.

Total Ionizing Dose (kRad(Si))	0	10	15	Units
LDR TID Biased				
Biased Mean	48.7105	48.7681	48.6791	ns
Std Dev	1.0967	0.9798	1.0131	
Biased Mean+3σ	52.0006	51.7074	51.7184	
Biased Mean-3σ	45.4204	45.8287	45.6399	
LDR TID Un-Biased				
Un-Biased Mean	48.3118	48.3256	48.2985	ns
Std Dev	1.2857	1.4239	1.3471	
Un-Biased Mean+3σ	52.1690	52.5972	52.3398	
Un-Biased Mean-3σ	44.4546	44.0541	44.2572	
DS Limits				
DS MIN	4.00E+01	3.90E+01	3.80E+01	ns
	PASS	PASS	PASS	
DS MAX	6.00E+01	6.10E+01	6.20E+01	ns
	PASS	PASS	PASS	