

R8340/8340A
Digital Ultra High Resistance/
Micro Current Meters

INSTRUCTION MANUAL

OPERATIONS

ADVANTEST®
ADVANTEST CORPORATION

ADVANTEST®
ADVANTEST CORPORATION

R8340/8340A

Digital Ultra High Resistance/

Micro Current Meters



INSTRUCTION MANUAL

MANUAL NUMBER OED00 9302

Before reselling to other corporations
or re-exporting to other countries, you
are required to obtain permission from
both the Japanese Government under its
Export Control Act and the U.S. Govern-
ment under its Export Control Law.

NOTICE

ADVANTEST provides the following power cables for each country.
If there was any inconvenience on your use, please contact our subsidiaries or ADVANTEST representatives.

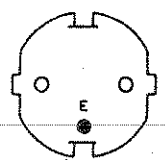
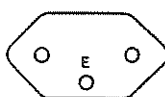
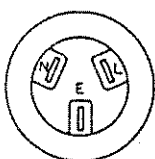
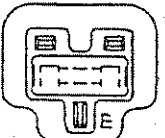
| | Plugs | Standards/Countries | Ratings/Color/ Length | Accessory Codes |
|---|---|---|--|------------------------------|
| 1 |  | JIS : JAPAN | Rating :125V 7A Color :Black Length :2m | A01402 A01412 |
| 2 |  | UL : USA CSA : CANADA | Rating :125V 7A Color :Black Length :2m | A01403 (Opt.95) A01413 |
| 3 |  | CEE : EUROPE VDE : FRG OVE : AUSTRIA SEMKO : SWEDEN DEMKO : DENMARK KEMA : NETHERLANDS FIMKO : FINLAND NEMKO : NORWAY CEBEC : BELGIUM | Rating :250V 6A Color :Gray Length :2m | A01404 (Opt.96) A01414 |
| 4 |  | SEV : SWITZERLAND | Rating :250V 6A Color :Gray Length :2m | A01405 (Opt.97) A01415 |
| 5 |  | SAA : AUSTRALIA NEWZELAND | Rating :250V 6A Color :Gray Length :2m | A01406 (Opt.98) |
| 6 |  | BS : UK | Rating :250V 6A Color :Black Length :2m | A01407 (Opt.99) A01417 |

Note : "E" shows earth (ground).

Table of Contents

| | |
|---|--------|
| 1. INTRODUCTION | 1 - 1 |
| 1.1 How to Use the Operation Manual | 1 - 2 |
| 1.2 Outline of the Meter | 1 - 4 |
| 1.3 Before Operating Meter | 1 - 5 |
| 1.3.1 Checking Accessories | 1 - 5 |
| 1.3.2 Operating Ambient Conditions | 1 - 6 |
| 1.3.3 Supply Voltage | 1 - 7 |
| 1.3.4 Power Cable | 1 - 8 |
| 1.3.5 Fuse | 1 - 9 |
| 1.3.6 Input/Output Cable | 1 - 10 |
| 1.3.7 Preheating Time | 1 - 10 |
| 2. DESCRIPTION OF METER PANEL | 2 - 1 |
| 2.1 Marking Safety Symbols | 2 - 2 |
| 2.2 Description of Front Panel | 2 - 3 |
| 2.3 Display Panel on Front Panel | 2 - 8 |
| 2.4 Description of Rear Panel | 2 - 9 |
| 3. HOW TO OPERATE | 3 - 1 |
| 3.1 Measurement Preparation | 3 - 2 |
| 3.1.1 Power On | 3 - 2 |
| 3.1.2 Various Messages | 3 - 4 |
| 3.1.3 Table of Initialize Setting States | 3 - 9 |
| 3.2 Basic Operation Method | 3 - 11 |
| 3.2.1 How to Use Short bar of Earthed/Isolated | 3 - 11 |
| 3.2.2 Discharge, Charge, and Measure | 3 - 15 |
| 3.2.3 DC Measurement (IM) | 3 - 17 |
| 3.2.4 Voltage Applying Current Measurement (VSIM) | 3 - 17 |
| 3.2.5 Resistance Measurement (VSRM) | 3 - 22 |
| 3.2.6 Measurement of Volume Resistivity and Surface Resistivity | 3 - 26 |
| 3.3 Various Functions | 3 - 33 |
| 3.3.1 Null | 3 - 33 |
| 3.3.2 Compare | 3 - 34 |
| 3.3.3 Integration Time | 3 - 35 |
| 3.3.4 AD CAL | 3 - 35 |
| 3.3.5 Input Amplifier Gain | 3 - 36 |
| 3.3.6 Current Limiter (Current Compliance) | 3 - 40 |
| 3.3.7 Auto Range Up/Down Level | 3 - 41 |
| 3.3.8 Contact Checking | 3 - 43 |
| 3.3.9 Trigger Delay | 3 - 50 |
| 3.3.10 Autorange Delay | 3 - 51 |
| 4. DESCRIPTION OF PARAMETER KEYS | 4 - 1 |
| 4.1 Basic Usage of Parameter Keys | 4 - 2 |
| 4.2 Various MEAS-Key Setting Methods | 4 - 8 |
| 4.2.1 Integral Time | 4 - 8 |
| 4.2.2 AD CAL | 4 - 10 |
| 4.2.3 Input Amplifier Gain | 4 - 11 |
| 4.2.4 Current Limiter (Current Compliance) | 4 - 12 |
| 4.2.5 Auto Range Up/down Level | 4 - 13 |
| 4.2.6 Unit Indication | 4 - 14 |

| | | |
|--------|--|--------|
| 4.2.7 | Trigger Delay | 4 - 15 |
| 4.2.8 | Autorange Delay | 4 - 16 |
| 4.3 | Various CAL-Key Setting Methods | 4 - 17 |
| 4.3.1 | Zero Cancel | 4 - 17 |
| 4.3.2 | Contact Initialization Offset Measurement | 4 - 18 |
| 4.3.3 | Contact Initialization | 4 - 19 |
| 4.3.4 | Self-test | 4 - 20 |
| 4.4 | Various COEF-Key Setting Methods | 4 - 22 |
| 4.4.1 | Upper Level | 4 - 22 |
| 4.4.2 | LOWER Level | 4 - 26 |
| 4.4.3 | Resistance Measurement Indication | 4 - 30 |
| 4.4.4 | Setting of Volume-/Surface Resistivity Electrode | 4 - 31 |
| 4.4.5 | Optional Electrode Coefficient | 4 - 32 |
| 4.4.6 | Sample Thickness | 4 - 34 |
| 4.4.7 | Contact Level | 4 - 35 |
| 4.4.8 | Buzzer | 4 - 37 |
| 4.4.9 | Data Indicator | 4 - 38 |
| 4.4.10 | Contact Initial Integral Time | 4 - 39 |
| 4.5 | Various I/O-Key Setting Methods | 4 - 41 |
| 4.5.1 | DA OUTPUT (R8340A Only) | 4 - 41 |
| 4.5.2 | BCD OUTPUT (R8340A Only) | 4 - 43 |
| 4.5.3 | GPIB | 4 - 44 |
| 4.5.4 | Power Frequency | 4 - 46 |
| 4.6 | Various MEM-Key Setting Methods | 4 - 47 |
| 4.6.1 | Data Storage | 4 - 47 |
| 4.6.2 | Data Recall | 4 - 49 |
| 5. | SEQUENCE PROGRAM | 5 - 1 |
| 5.1 | Sequence | 5 - 2 |
| 5.2 | Execution of Sequence Program | 5 - 8 |
| 5.3 | Setting of Program Parameters | 5 - 12 |
| 5.4 | Sequence Program Operation Example | 5 - 19 |
| 6. | GPIB INTERFACE | 6 - 1 |
| 6.1 | Outline | 6 - 2 |
| 6.2 | GPIB Standard | 6 - 3 |
| 6.3 | Connection with Component Units | 6 - 5 |
| 6.4 | Address Setting and Header on/off Selection | 6 - 6 |
| 6.5 | Talker Specification (Data Output) | 6 - 7 |
| 6.5.1 | Basic Format | 6 - 7 |
| 6.5.2 | Response to Query Command | 6 - 9 |
| 6.5.3 | Binary Packed Format | 6 - 11 |
| 6.5.4 | Format of Recall Data with Data Number | 6 - 12 |
| 6.6 | Listener Specification | 6 - 14 |
| 6.6.1 | Header Part | 6 - 14 |
| 6.6.2 | Data Part | 6 - 15 |
| 6.6.3 | Terminator | 6 - 15 |
| 6.6.4 | Query Command | 6 - 15 |
| 6.6.5 | Command Buffer and Measured Data Buffer | 6 - 24 |
| 6.6.6 | Controller Interruption During Data Transfer Between Units | 6 - 24 |
| 6.7 | Status Byte | 6 - 25 |
| 6.7.1 | Structure of Status Byte Register | 6 - 25 |
| 6.7.2 | Structure of Standard Event Status Register | 6 - 28 |

| | | |
|-------|---|---------|
| 6.7.3 | Structure of Device Event Status Register | 6 - 30 |
| 6.7.4 | Error Register | 6 - 32 |
| 6.7.5 | Self-test Error Register | 6 - 33 |
| 6.8 | Status at Initialization and Command Reception | 6 - 34 |
| 6.9 | Program Example | 6 - 35 |
| 7. | INPUT/OUTPUT SIGNALS | 7 - 1 |
| 7.1 | Handler Interface | 7 - 2 |
| 7.2 | COMPLETE Output Signal | 7 - 9 |
| 7.3 | TRIGGER Input Signal | 7 - 10 |
| 7.4 | LID SIGNAL Input Signal | 7 - 11 |
| 8. | BCD OUTPUT AND D/A OUTPUT (R8340A ONLY) | 8 - 1 |
| 8.1 | Selection of BCD OUTPUT | 8 - 2 |
| 8.1.1 | BCD Output | 8 - 2 |
| 8.1.2 | Binary Output | 8 - 7 |
| 8.2 | D/A Output | 8 - 10 |
| 9. | TROUBLESHOOTING AND CALIBRATION | 9 - 1 |
| 9.1 | Before Requesting Repair | 9 - 2 |
| 9.2 | Calibration | 9 - 3 |
| 9.2.1 | Preparation and Precaution for Calibration | 9 - 3 |
| 9.2.2 | Calibration Data Initialization | 9 - 5 |
| 9.2.3 | Calibration Method | 9 - 6 |
| 10. | DESCRIPTION OF OPERATION | 10 - 1 |
| 10.1 | Outline of Operation | 10 - 2 |
| 10.2 | IV Converter | 10 - 4 |
| 10.3 | A/D Converter | 10 - 5 |
| 11. | CONNECT INPUT/OUTPUT CABLES | 11 - 1 |
| 11.1 | Connection the Instrument to R12702A/B | 11 - 2 |
| 11.2 | Connection the Instrument to R12704 | 11 - 4 |
| 11.3 | Connection the Instrument to TR42 | 11 - 5 |
| 11.4 | Connecting the Instrument to TR43C | 11 - 7 |
| 11.5 | Connecting the Instrument to TR44 | 11 - 9 |
| 11.6 | Connecting the Instrument to R12706A | 11 - 10 |
| 11.7 | Connecting Multiple Samples with R12705A, R7210 and R72101J | 11 - 12 |
| 11.8 | Connecting the Instrument to R12604 | 11 - 15 |
| 12. | SPECIFICATION | 12 - 1 |
| 12.1 | Direct Current Measurement | 12 - 2 |
| 12.2 | Resistance Measurement | 12 - 3 |
| 12.3 | Input Specification | 12 - 4 |
| 12.4 | Direct Current Generation | 12 - 5 |
| 12.5 | Measurement Speed and Maximum Indication | 12 - 7 |
| 12.6 | Input/Output Function | 12 - 8 |
| 12.7 | Other Function | 12 - 9 |
| 12.8 | General Specification | 12 - 10 |
| 12.9 | Accessories (Optional) | 12 - 11 |

| | |
|---|--------|
| APPENDIX | A1 - 1 |
| A1.1 GPIB Remoto Execution Time (representative value)..... | A1 - 2 |
| INDEX | I - 1 |
| EXTERNAL VIEW | |

LIST OF ILLUSTRATIONS

| Figure No. | Title | Page |
|------------|---|--------|
| 1 - 1 | Operating Ambient Conditions | 1 - 6 |
| 1 - 2 | Set Supply Voltage Marked on Rear Panel | 1 - 7 |
| 1 - 3 | Plug and Aadapter of Power Cable | 1 - 8 |
| 1 - 4 | Structure of Input/Output Cable | 1 - 10 |
| 2 - 1 | Safety-symbol Marking Position on Meter Panel | 2 - 2 |
| 2 - 2 | Description of Front Panel | 2 - 10 |
| 2 - 3 | Description of Display Panel on Front Panel | 2 - 10 |
| 2 - 4 | Description of Rear Panel | 2 - 10 |
| 3 - 1 | Connection of Isolated Sample | 3 - 11 |
| 3 - 2 | Connection of Earthed Sample for Current Measurement | 3 - 12 |
| 3 - 3 | Connection of Earthed Sample for Resistance Measurement and VSIM | 3 - 13 |
| 3 - 4 | Connection for Coexistence of Isolated and Earthed Smples | 3 - 14 |
| 3 - 5 | Basic Flow of Operation | 3 - 15 |
| 3 - 6 | Equivalent Circuit Under Discharge, Charge, and Measure States | 3 - 16 |
| 3 - 7 | Basic Measurement | 3 - 16 |
| 3 - 8 | Electrode Connection (For volume resistivity measurement) | 3 - 28 |
| 3 - 9 | Electrode Connection (For surface resistivity measurement) | 3 - 29 |
| 3 - 10 | AD CAL Timing | 3 - 35 |
| 3 - 11 | Timing When Measurement Starts During Execution of AD CAL Function | 3 - 36 |
| 3 - 12 | Equivalent Circuit for Measurement of Capacitor Leak Current | 3 - 36 |
| 3 - 13 | Feedback-system Equivalent Circuit | 3 - 37 |
| 3 - 14 | Charge and Discharge Speed | 3 - 41 |
| 3 - 15 | Contact Checking | 3 - 43 |
| 3 - 16 | Trigger Delay | 3 - 50 |
| 3 - 17 | Autorange Delay | 3 - 51 |
| 4 - 1 | Basic Usage of Parameter Keys | 4 - 7 |
| 6 - 1 | GPIB Connector Pin Arrangement | 6 - 3 |
| 6 - 2 | Signal Conductor Termination | 6 - 3 |
| 6 - 3 | Structure of Status Byte Register | 6 - 26 |
| 6 - 4 | Standard Event Status Register | 6 - 28 |
| 6 - 5 | Device Event Status Register | 6 - 30 |
| 7 - 1 | Description of Handler Interface Connector Pins | 7 - 2 |
| 7 - 2 | LID SIGNAL Timing | 7 - 3 |
| 7 - 3 | Handler Interface Timing | 7 - 4 |
| 8 - 1 | Description of BCD Data Output Connection Pins | 8 - 2 |
| 8 - 2 | Description of Binary-output Connector Pins | 8 - 9 |
| 8 - 3 | Output Voltage of DA OUTPUT | 8 - 10 |

| Figure No. | Title | Page |
|------------|--|---------|
| 9 - 1 | Key Functions in Calibration Mode | 9 - 6 |
| 9 - 2 | Connection for Current Measurement Calibration | 9 - 17 |
| 9 - 3 | Connection for Voltage Generation Calibration | 9 - 19 |
| 10 - 1 | Block Diagram of R8340 and R8340A | 10 - 3 |
| 10 - 2 | IV Converter | 10 - 4 |
| 10 - 3 | Outline of A/D Converter Operation | 10 - 5 |
| 11 - 1 | R12702A/B Setup | 11 - 2 |
| 11 - 2 | R12702A/B Connecting Diagram | 11 - 3 |
| 11 - 3 | R12704 Setup | 11 - 4 |
| 11 - 4 | R12704 Connecting Diagram | 11 - 4 |
| 11 - 5 | TR42 Setup (Measuring volume resistance) | 11 - 5 |
| 11 - 6 | TR42 Setup (Surface resistance) | 11 - 6 |
| 11 - 7 | TR42C Setup | 11 - 7 |
| 11 - 8 | TR42 or 43C Connecting Diagram | 11 - 8 |
| 11 - 9 | TR44 Setup | 11 - 9 |
| 11 - 10 | Installation Terminals | 11 - 10 |
| 11 - 11 | R12706A Setup | 11 - 10 |
| 11 - 12 | R12706A Connecting Diagram | 11 - 11 |
| 11 - 13 | Installation Terminals | 11 - 12 |
| 11 - 14 | R12705A, R7210, and R72101J Setup | 11 - 13 |
| 11 - 15 | R12705A, R7210, and R72101J Connection Diagram | 11 - 14 |
| 11 - 16 | R12604 Setup | 11 - 15 |

LIST OF TABLES

| Table No. | Title | Page |
|-----------|--|--------|
| 1 - 1 | Standard Accessories | 1 - 5 |
| 1 - 2 | Fuse Specification | 1 - 9 |
| 2 - 1 | Safety Symbols | 2 - 2 |
| 2 - 2 | Parameter Key Functions | 2 - 6 |
| 3 - 1 | Error Messages | 3 - 8 |
| 3 - 2 | Electrode Dimensions Specified in JIS | 3 - 26 |
| 3 - 3 | COMPARE Operation Results and Indication | 3 - 34 |
| 3 - 4 | Input Resistance and Input Voltage Drop for Full Scale | 3 - 39 |
| 3 - 5 | Output Voltage and Current Limiter | 3 - 40 |
| 3 - 6 | Setting Range and Count Values | 3 - 42 |
| 3 - 7 | Status Fluctuations Due to Level Selection While Measuring 13.142nA (when the input resistance is GAINXI) | 3 - 42 |
| 3 - 8 | Contact Checking Judgment Level Range and Step Voltage | 3 - 46 |
| 3 - 9 | The Range Where Comparison of Contact Initial and Contact Check is Available | 3 - 48 |
| 3 - 10 | Delay Time in Each Range when Setting Autorange Delay | 3 - 52 |
| 4 - 1 | Parameter Keys | 4 - 2 |
| 4 - 2 | Parameter Key Function | 4 - 3 |
| 4 - 3 | Setting Contact Initial Integral Time Per Noise level | 4 - 39 |
| 5 - 1 | Keys Effective for Each Mode | 5 - 10 |
| 5 - 2 | Status Change of Each Mode | 5 - 11 |
| 5 - 3 | CAL Key Function (In program mode) | 5 - 12 |
| 6 - 1 | Interfaces and Their Functions | 6 - 4 |
| 6 - 2 | Standard Bus Cable | 6 - 5 |
| 6 - 3 | Mantissa- and Exponent-part Data | 6 - 8 |
| 6 - 4 | Program Code | 6 - 16 |
| 6 - 5 | Status Byte Register | 6 - 27 |
| 6 - 6 | Standard Event Status Register | 6 - 29 |
| 6 - 7 | Device Event Status Register | 6 - 31 |
| 6 - 8 | Error Register | 6 - 32 |
| 6 - 9 | Self-test Error Register | 6 - 33 |
| 6 - 10 | Status Change by Each Command | 6 - 34 |
| 8 - 1 | Data Output Codes | 8 - 5 |
| 8 - 2 | Data Output Example | 8 - 6 |
| 9 - 1 | Troubleshooting Items | 9 - 2 |
| 9 - 2 | Equipment Necessary for Calibration | 9 - 3 |
| 9 - 3 | Cables Necessary for Calibration | 9 - 4 |
| 9 - 4 | Setting of Standard Direct-current Generator for Calibration | 9 - 20 |
| 9 - 5 | Each Calibration Item Setting Range | 9 - 21 |
| 9 - 6 | Calibration Checking Error Range | 9 - 23 |
| 11 - 1 | Coefficient Setting | 11 - 9 |

1. INTRODUCTION

This section describes the configuration of the operation manual, outline of the meter, and precautions for operation. Therefore, be sure to read the manual before operating the meter.

1.1 How to Use the Operation Manual

(1) Configuration of the Operation Manual

| | |
|---|--|
| 1. Introduction | The outline of the meter and precautions for operation are described be sure to read this section before operating the meter. |
| 2. Description of Meter Panel | Each part of the front and rear panels and safety symbols on the panels are described. |
| 3. How to Operate | The measurement preparation and basic operation method and described. |
| 4. Description of Parameter Keys | The parameter keys are described. |
| 5. Sequence program | Sequence program creation, program execution and program parameter settings are described. |
| 6. GPIB (General Purpose Interface Bus) | How to control the meter using the GPIB is described. |
| 7. Input/Output Signals | Four types of input/output signals for control are described. |
| 8. BCD Output and D/A Output | This function is given to the R8340A. |
| 9. Checking and Calibration | The methods are described to check the meter when a trouble occurs during operation and to calibrate the meter to hold the measuring accuracy. |
| 10. Description of Operation | The outline of the meter operation theory is described. |
| 11. Applied Measurement | The measurement methods are described when the meter is combined with a fixture or scanner. |
| 12. Specification | The standards and accessories(optional) of the meter are summarized. |
| APPENDIX | The GPIB remote execution time is described. |

External View

External view of meter with dimensions is shown.

- (2) This manual shows the display panel conditions as follows:

Example:

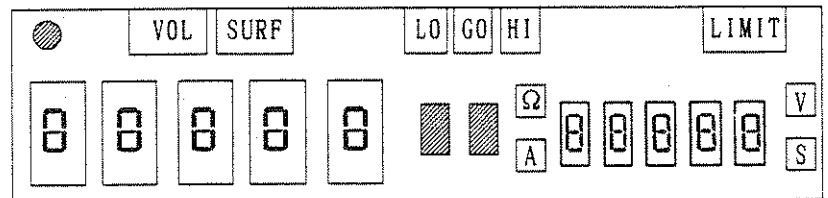
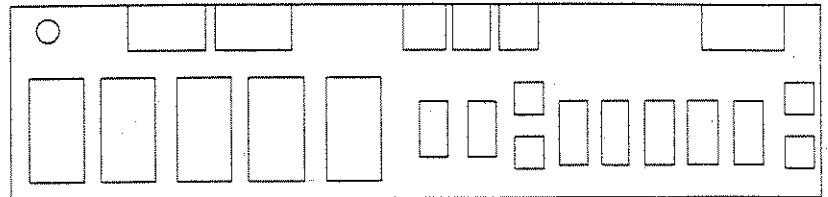

1.2 Outline of The Meter

The R8340 and R8340A are the digital ultra-high-resistance/micro-current meter storing a voltage generation source of 0 to 1000V respectively.

The current measurement range is 10fA to 19.999mA and the resistance measurement range is 10 to $3 \times 10^{16} \Omega$.

The meter can easily measure large resistance at a high speed because it has such intelligent functions as contact checking and sequence program in addition to high-speed measurement of 100 samples/sec.

The R8340A is normally equipped with BCD (binary-coded decimal notation) output and D/A (digital to analog conversion) output.

[Features]

- ① High-resolution and wide-range measurement
Current : 10fA to 19.999mA
Resistance : 10Ω to $3 \times 10^{16} \Omega$
- ② High-speed charge and discharge with the voltage source realizing 10W-class sink
0V to 30V : $\pm 0.3A$
30V to 100V : $\pm 0.1A$
100V to 1000V : $\pm 0.01A$
- ③ Sequence program function :
Stores the measurement based on JIS C5102 (Test Methods of Fixed Capacitors for Electric Equipment).
- ④ Contact checking function :
Checks sample connected conditions.
- ⑤ Integral-time varying function :
Realizes high-speed (100 samples/sec) and high-accuracy measurement.
- ⑥ Operation function :
Computes NULL, COMPARE, volume resistivity, and surface resistivity.
- ⑦ Data storing function :
Stores up to 1000 data values.
- ⑧ The R8340 realizes 550-VDC floating measurement and the R8340A realizes 1100-VDC floating measurement.
- ⑨ A handler interface is normally installed to control the auto handler and fixture.
- ⑩ The GPIB is normally installed.

1.3 Before Operating Meter

1.3.1 Checking Accessories

When the meter is delivered to you, check the following.

Check

- ① Check if the meter surface is damaged.
- ② Check the quantity and specification of the standard accessories according to Table 1-1.

In the event of any damage, missing standard accessory, or equivalent, contact a nearby sales office, or your dealer.

Notice : For additional order of accessories, designate the model (or stock No.).

Table 1 - 1 Standard Accessories

| Product Name | Model | Stock No. | Quantity | Remarks |
|--------------------------|------------------------------------|---------------|----------|--|
| Power Cable | A01402 | DCB-DD2428X01 | 1 | |
| Input/Output Cable | A01019-100 | DCB-FM3526X02 | 1 | For R8340 |
| | A01018-100 | DCB-FM3525X02 | | For R8340A |
| Power Fuse | 0.8A slow-blow fuse (EAWK 0.8A) | DFT-AAR8A | 2 | For specification of 100, 115, or 120 VAC |
| | 0.4A slow-blow fuse (EAWK 0.4A) | DFT-AAR4A | | For specification of 220, 230, or 240 VAC |
| Input Protection Fuse | 1A slow-blow fuse (EAWK 1A) | DFT-AA1A | 2 | |
| Operation Manual | — | JR8340/8340A | 1 | Japanese Version |
| | — | ER8340/8340A | | English Version |

1.3.2 Operating Ambient Conditions

- (1) Operate the meter at the place free from dust, vibration, direct sunlight or corrosive gas. Keep the ambient temperature between 0 and 40°C and the relative humidity at 85% or less.
- (2) The meter uses a discharge-type cooling fan to avoid internal temperature rise. Therefore, keep the meter 10cm or more from the wall and things behind the meter to improve ventilation. Do not place any thing closely to the back of the meter, stand the meter, or interrupt the top or bottom ventilating hole.
- (3) Though the meter is designed by adequately considering noises from the AC power line, operate it by minimizing noises. If noises cannot be avoided, use a noise elimination filter.
- (4) Store the meter by keeping temperature between -25°C and +70°C. When the meter is not used for a long time, store it at a dry place free from sunlight by covering it with a vinyl sheet or putting it in a carton.
- (5) When transporting the meter, use the packing materials which are first delivered to you. If you do not have the packing materials, pack the meter as follows.
 - ① Cover the meter with vinyl sheet.
 - ② Put the meter in a carton with the thickness of 5mm or more together with a cushioning material so that the meter will be wrapped by the cushion.
 - ③ Then put accessories in the carton together with the cushioning material after wrapping the meter with the cushion, close the carton, and secure the carton surface with a packing string.

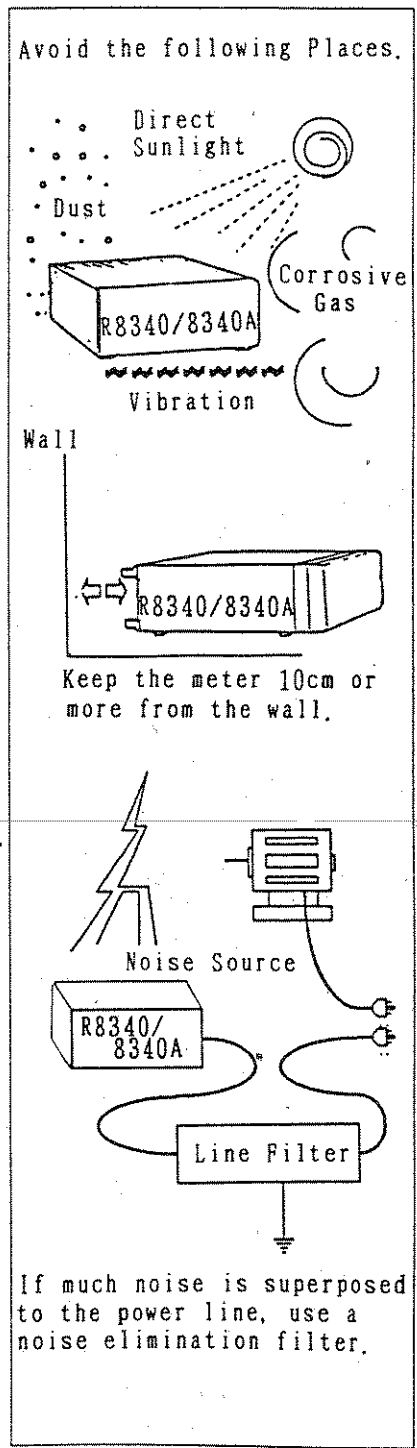

Figure 1 - 1 Operating Ambient Conditions

1.3.3 Supply Voltage

Before connecting the power cable, be sure to check if the power switch is turned off.

The supply voltage is factory-set and marked on the rear panel. (See Figure 1-2.) Check if the supply voltage to be used is matched with the displayed value.

Use 50 or 60Hz for the power frequency.

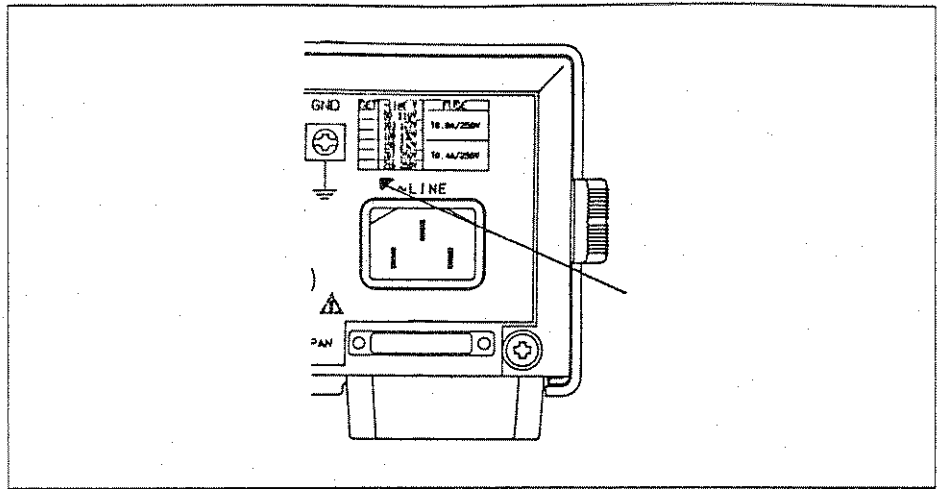

Figure 1 - 2 Set Supply Voltage Marked On Rear Panel

1.3.4 Power Cable

The power cable plug has three pins and the round pin is used for earthing. See Figure 1-3 (a). Use the outlet equipped with an earth terminal. When using a 2 pin plug, connect it to the outlet using the adapter A09034 attached to the plug. In this case, be sure to connect the earth lead wire extended from the adapter or the GND terminal on the rear panel with the external earth terminal or to earth it to the ground.

To insert the adapter A09034 into the outlet, confirm the directions of the plug and the outlet because two electrodes of the adapter are different in width as shown in Figure 1-3(b).

If the adapter A09034 cannot be connected to the outlet used, use the adapter KPR-13 (separately sold product).

CAUTION

Carefully connect the earth wire extended from the adapter so that the wire will not contact the AC power supply.

If the wire is carelessly contacted to the AC power supply, the meter or other connected equipment may be damaged.

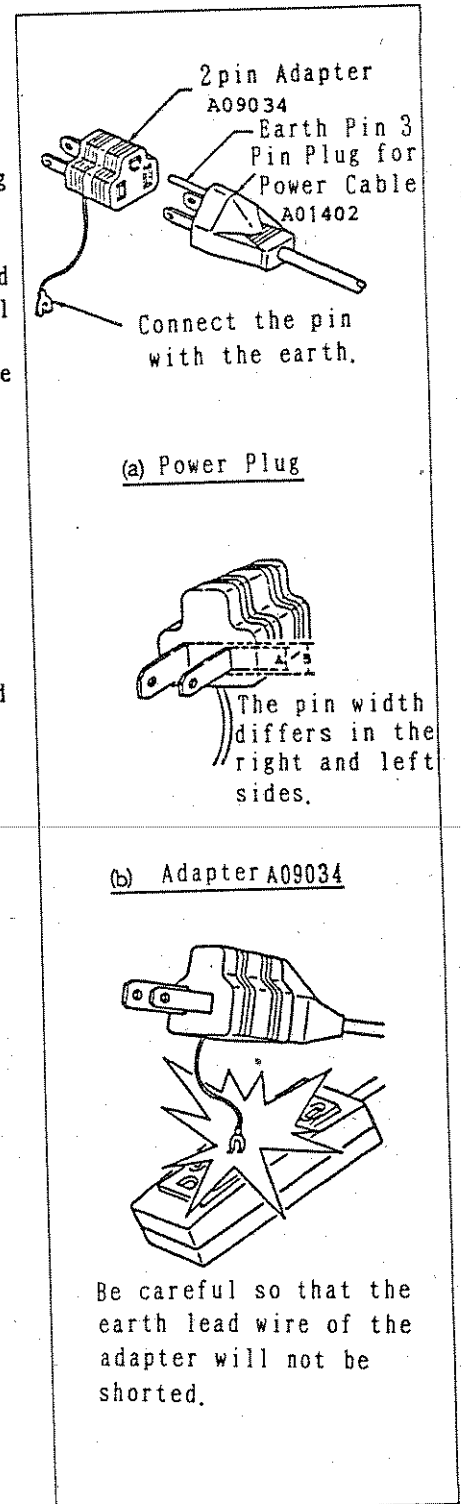

Figure 1 - 3 Plug and Adapter of Power Cable

1.3.5 Fuse

(1) Power Fuse and input Protection Fuse

The meter has a power fuse and an input protection fuse to protect the internal circuit under charge/discharge states. The power fuse is installed on the rear panel and the input protection fuse is housed in the fuse holder on the front panel.

(2) How to Replace Fuse

CAUTION

1. Be sure to turn off the power switch and remove the power cable from the outlet before replacing fuses.
2. Not only visually check each fuse but measure the resistance of each fuse. A fuse is normal when its resistance is 15 Ω or less.

Operation (① through ③)

- ① When slightly pressing a slotted screwdriver against the fuse holder cap to turn it approx. 60 $^{\circ}$ counterclockwise and releasing it, the rotary element is protruded approx. 3mm toward you.
- ② Pull out the rotary element to replace the installed fuse with a new one.
- ③ Re-install the rotary element by pressing the screwdriver against the element and turning it approx. 60 $^{\circ}$ clockwise. Shows the Fuse Specification.

Table 1 - 2 Fuse Specification

| Fuse | Specification | | Remarks |
|-----------------------|--------------------------------|-----------|---|
| | Model | Stock No. | |
| Power Fuse | 0.8A slow-blow fuse (BAWK0.8A) | DFT-AAR8A | For specification of 100, 115, or 120 VAC |
| | 0.4A slow-blow fuse (BAWK0.4A) | DFT-AAR4A | For specification of 220, 230, or 240 VAC |
| Input protection fuse | 1A slow-blow fuse (BAWK1A) | DFT-AA1A | |

WARNING

For constant protection from fire, use the fuse with the same type and rating.

1.3.6 Input/Output Cable

Use the attached input/output cable A01019 for the R8340 and the A01018 for the R8340A.
The input/output cable is a double-coaxial cable. Figure 1-4 shows the cable structure.
Connect the triaxial connector with the INPUT terminal and the banana tip with the LO or V-SOURCE terminal.
The triaxial connector A01019 has the dielectric strength of 550 VDC and the A01018 has that of 1100 VDC.
When the floating measurement of 550 VDC or more is necessary for measurement of earthed samples, use the meter R8340A and the cable A01018.
For how to connect the input/output cable, see Item 3.2.1

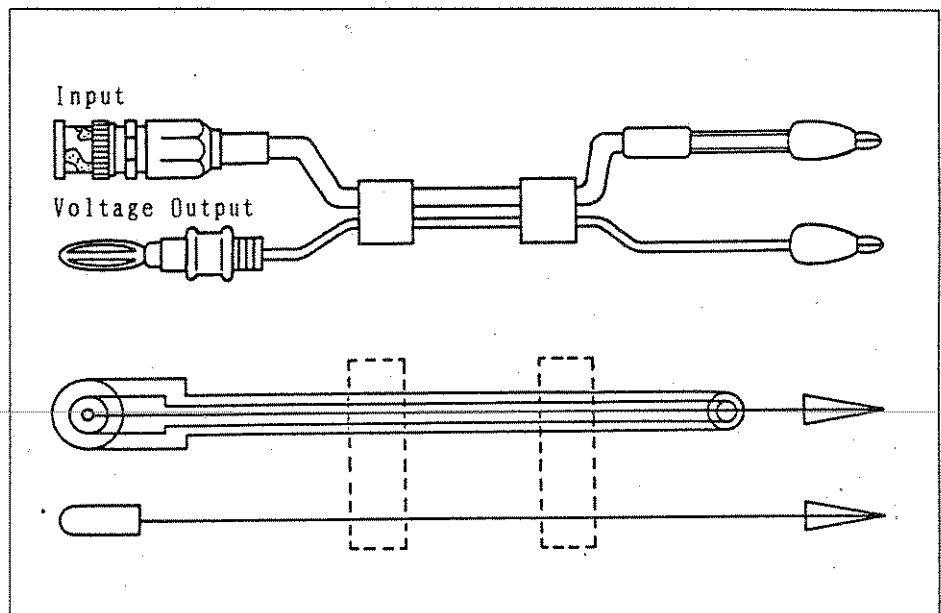

Figure 1 - 4 Structure of Input/Output Cable

1.3.7 Preheating Time

Though all functions of the meter start as soon as the power is turned on, it is recommended to take the preheating time of 30 min or more to obtain the specified accuracy.





2. DESCRIPTION OF METER PANEL

This section describes each part of the front and rear panels and the safety symbols marked on the panel surface.

2.1 Marking Safety Symbols

The following is the description of each safety symbol marked on the front and rear panels. Table 2-1 shows the meaning of various safety symbols and Figure 2-1 shows the safety-symbol marking positions on the meter panel.

Table 2 - 1 Safety Symbols

| No. | Symbol | Name | Description |
|-----|---|------------------------|---|
| ① |  | Warning symbol | This is marked on the positions where it is needed to see the operation manual to protect the meter from being damaged. |
| ② |  | Flash symbol | This shows dangerous high voltage. The symbol is marked on the terminals outputting a voltage exceeding 1kV. |
| ③ |  | Earth terminal symbol | This is marked on general earth terminals. Connect the terminals with the ground. |
| ④ |  | AC power supply symbol | This shows an AC power supply. |

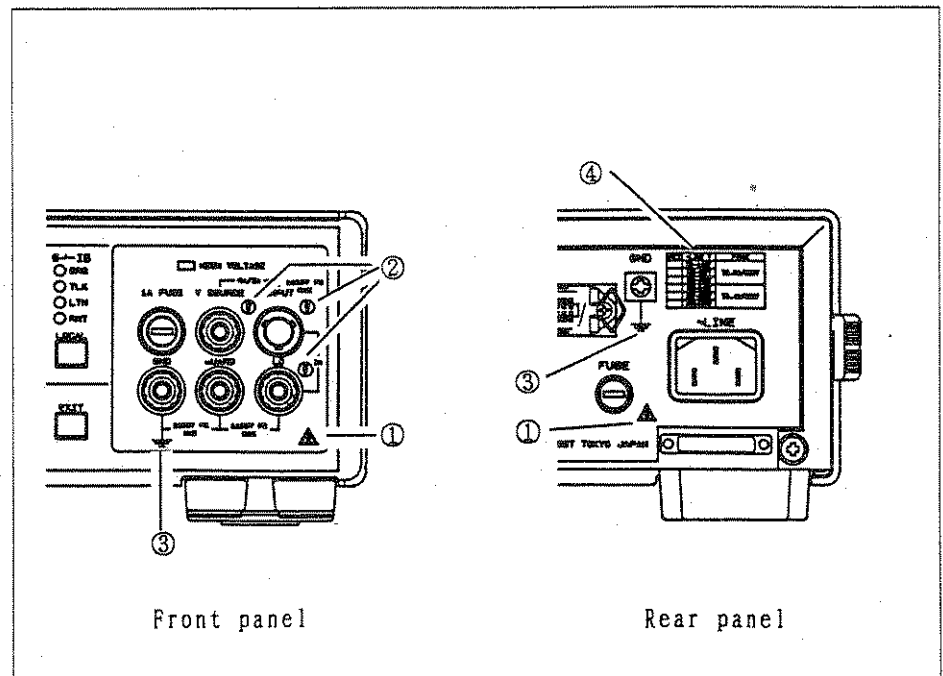

Figure 2 - 1 Safety-symbol Marking Position on Meter Panel

2.2 Description of Front Panel

Figure 2-2 shows the front panel. Each part is described in order of numbers ① through ⑫ on the panel surface. The R8340 and R8340A are the same other than the marking of R8340 instead of R8340A and the dielectric strength of the LO to GUARD terminals.

- ① POWER switch : Used to turn on/off the power.
- ② IM/RM key : Used to select the current or resistance value.
In the numerical value input mode, the input key "0" is effective.
- ③ AUTO key : Used to select the auto or manual range. When the auto range is set, the LED on the key lights.
In the numerical value input mode, the input key "1" is effective.
- ④ DOWN key : Used to lower the current measuring range by one step from the present level.
In the numerical value input mode, the input key "2" is effective.
- ⑤ UP key : Used to raise the current measuring range by one step from the present level.
In the numerical value input mode, the input key "3" is effective.

CAUTION

To measure resistance, change the range using the current measuring range.

When pressing the DOWN or UP key, the range is changed in the direction opposite to current measurement.

- ⑥ RUN/HOLD key : Used to select FREE RUN or HOLD for sampling. When FREE RUN is set, the LED on the key lights.
In the numerical value input mode, the input key "4" is effective.
- ⑦ TRIG key : Used to make sampling once under the sampling hold state.
In the numerical value input mode, the key "5" is effective.

- ⑧ NULL key : Used to set the NULL mode.
In the numerical value input mode, the key "6" is effective.
- ⑨ COMPARE key : Used to set the COMPARE mode.
In the numerical value input mode, the key "7" is effective.
- ⑩ DISCHARGE key : Used to bring the meter under the discharge state.
In the numerical value input mode, the key is used to select the polarity "+" or "-".
- ⑪ CHARGE key : Used to bring the meter under the charge state.
In the numerical value input mode, the key is used to input the decimal point ".".
- ⑫ MEASURE key : Used to bring the meter under the measure state.
In the numerical value input mode, the key is used to cancel "CE".
- ⑬ CONTACT key : Used to execute contact checking.
- ⑭ PRGM/NORMAL key : Used to select the sequence program mode or normal measurement mode. When the sequence program mode is set, the LED on the key lights.
In the numerical value input mode, the input key "8" is effective.
- ⑮ START key : Used to start program measurement.
In the numerical value input mode, the key "9" is effective.
- ⑯ SET key : Used to set the generation voltage value.
When pressing the key, other keys function as a numerical key.
- ⑰ OPERATE key : Used to select voltage generation on or off.
- ⑱ LOCAL key and GPIB status lamp
 - LOCAL key : Used to cancel the remote state. However, the remote state cannot be canceled when the mode is set to LOCAL LOCK OUT by the GPIB.
 - SRQ lamp : Lights when the meter sends the service request to the controller.
 - TLK lamp : Lights when the meter is under the talker state to send data.

- LTN lamp : Lights when the meter is under the listener state to receive data.
- RMT lamp : Lights when the meter is under the remote state.
- ⑬ PARAMETER key : Used to set various parameters or execute functions. The function depends on each mode. See Table 2-2.
- ⑭ Fuse holder : Used for input protection.
- ⑮ V SOURCE terminal : Used as a generated voltage output terminal.
- ⑯ INPUT connector : Used as an input connector.
- ⑰ GND terminal : Used as an earth terminal. The terminal is connected to the meter frame.
- ⑱ GUARD terminal : Used to guard the input unit. The terminal is connected with the internal guard case.
- ⑳ LO terminal : Used as a terminal common to input and output.
- ㉑ HIGH VOLTAGE lamp : Lights when the generation voltage is set to 100V or more or the V SOURCE terminal voltage is approx. 100V or more.
-

Table 2 - 2 Parameter Key Functions

| Mode Key | Normal measurement mode | Sequence program mode |
|----------------------------------|--|---|
| CAL <input type="checkbox"/> | 1. Zero cancel execution 2. Contact initial execution 3. Self-test execution | 1. Selection of program No. 2. Setting of autostart value 3. Setting of charge time 4. Setting of discharge time 5. Setting of measure time |
| MEAS <input type="checkbox"/> | 1. Setting of integration time 2. Setting of AD CAL 3. Setting of input amplifier gain 4. Setting of VS current limiter 5. Setting of auto-range up/down level 6. Setting of unit indication 7. Setting of trigger delay 8. Setting of autorenge delay | |
| I/O <input type="checkbox"/> | 1. Setting of D/A Out (R8340A only) 2. Setting of BCD Out (R8340A only) 3. Setting of GPIB address 4. Setting of power frequency | Same with the normal measurement mode |
| COEF <input type="checkbox"/> | 1. Setting of COMPARE-operation high level 2. Setting of COMPARE-operation low level 3. Setting of resistance value indication 4. Setting of electrodes for volume and surface resistivities 5. Setting of optional electrode coefficient 6. Setting of sample thickness for volume resistivity measurement | |

Table 2 - 2 Parameter Key Functions (Cont'd)

| Mode Key | Normal measurement mode | Sequence program mode |
|------------------------------------|--|---------------------------------------|
| COEF <input type="checkbox"/> | 7. Setting of contact level 8. Setting of buzzer ON/OFF 9. Setting of indication ON/OFF 10. Setting of contact initial integration time | Same with the normal measurement mode |
| MEM <input type="checkbox"/> | 1. Execution of data store 2. Execution of data recall | |
| CHANGE <input type="checkbox"/> | 1. Changes the setting of each parameter. | |
| EXIT <input type="checkbox"/> | 2. Catalogs the setting of each parameter and exits from the setting mode. | |

2.3 Display Panel on Front Panel

Figure 2-3 shows the display panel on the front panel. The following is the description of each part on the display panel in order of numbers ㉗ through ㉛.

- ㉗ Sampling indicator
: Lights when measurement sampling is executed.
- ㉘ VOL display
: Lights when the mode is set to volume resistivity measurement.
- ㉙ SURF display
: Lights when the mode is set to surface resistivity measurement.
- ㉚ LO, GO, and HI display
: Displays the results of COMPARE operation.
- ㉛ Ω display : Displays the unit for resistance, volume resistivity, or surface resistivity.
- ㉜ LIMIT display
: Displays when the current limiter for voltage generation is detected.
- ㉝ V display : Displays the unit of the generated voltage value.
- ㉞ Measured value indicator
: Displays a measured value.
- ㉟ Unit indicator
: Displays an exponent value in exponents or symbol unit.
- ㊱ A display : Displays the unit for current.
- ㊲ Generated voltage indicator
: Displays the set generation voltage.
- ㊳ S display : Displays when a time parameter is set or data is stored.

2.4 Description of Rear Panel

Figure 2-4 shows the rear panel. The following is the description of each part on the panel in order of numbers ㉓ through ㉙. The R8340 has neither DA OUTPUT connector ㉕ nor BCD OUTPUT connector ㉖.

- ㉓ TRIGGER INPUT connector
: Used as an input connector to control the start of measurement with external symbols.
- ㉔ COMPLETE OUTPUT connector
: Used to output the signal to notify the end of measurement to the outside.
- ㉕ LID SIGNAL INPUT connector
: Used to input the fixture lid operation signal.
- ㉖ EXT CAL switch
: Used to calibrate the meter.

CAUTION

Be sure to normally turn off the EXT CAL switch to operate the meter.

- ㉗ HANDLER INTERFACE connector
: Used for input/output signals synchronizing with the external equipment including the auto handler and fixture.
- ㉘ GPIB connector
: Used for external control with the GPIB.
- ㉙ DA OUTPUT connector (R8340A only)
: Used to output a displayed measured value by D/A converting optional number of digits of the value.
- ㉚ BCD OUTPUT connector (R8340A only)
: Used to output BCD codes of measurement results to the outside.
- ㉛ GND terminal
: Used as an earth terminal. The terminal is connected to the meter chassis.
- ㉜ Fuse holder
: Used as the fuse holder for power supply.
- ㉝ Power connector
: Used to connect the power supply. Use the attached power cable A01402.

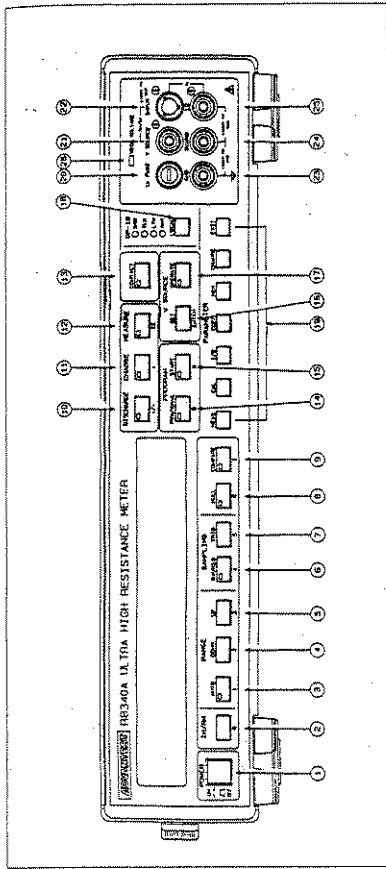

Figure 2 - 2 Description of Front Panel

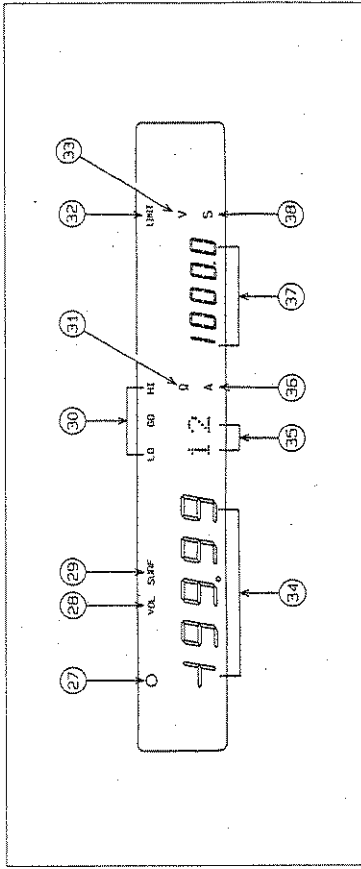

Figure 2 - 3 Description of Display Panel on Front Panel

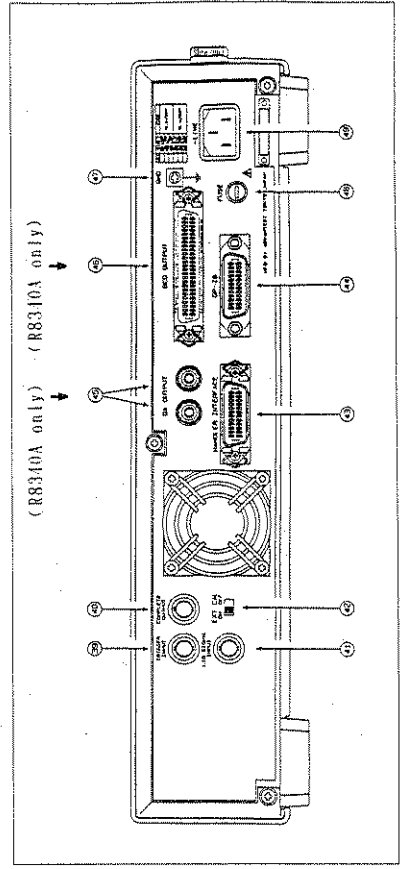

Figure 2 - 2 Description of Rear Panel

3. HOW TO OPERATE

This section describes the measurement preparation and basic operation method.

3.1 Measurement Preparation

3.1.1 Power On

(1) Initial Operation

Operation (① and ②)

- ① Connect the attached power cable to the power connector on the rear panel of the meter.
- ② Turn on the power switch on the front panel.
When the power switch is turned on, the following operation starts.

Turn on the power switch.

↓
Self-test starts. All LEDs go out.

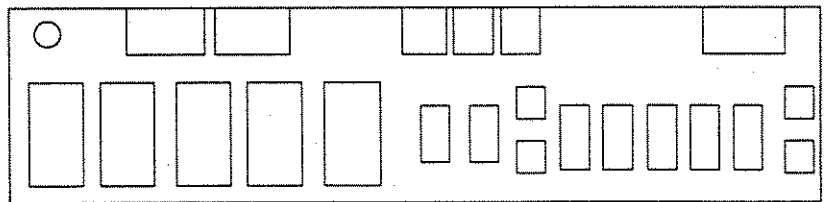

↓
Self-test is being executed. All LEDs light.

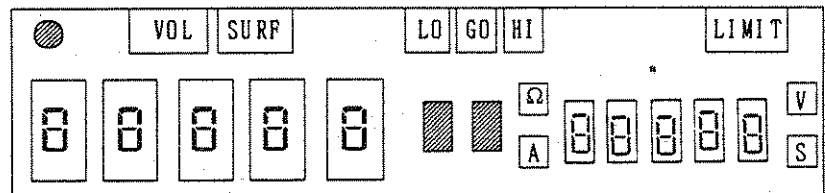

↓
Self-test ends. All LEDs go out.

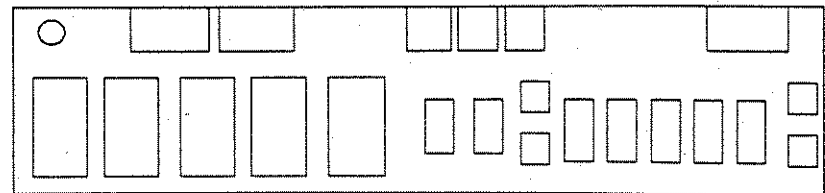

Ⓐ

Ⓐ

Software revision update is displayed.

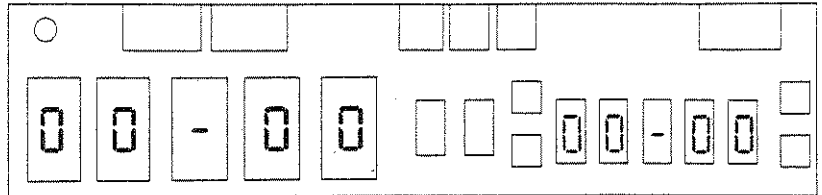

Logic
software
revision

Logic
software
update

Analog
software
revision

Analog
software
update

Normal operation

The range and parameter used when previously turning off the power switch are automatically set.

- (2) Be sure to set the power frequency to be used by operating the parameter key. For the setting method, see Item 4.5.4 "Power frequency".
Once the power frequency to be used is set, the power-frequency parameter is not canceled even if the power is turned off.

3.1.2 Various Messages

The meter displays various messages for abnormal input during operation. In this case, if the buzzer is set to ON, it sounds. The following is the description of various messages.

(1) Over-range Message

When the over-range message appears, raise the measurement range.

(Press the ^{UP} key.)

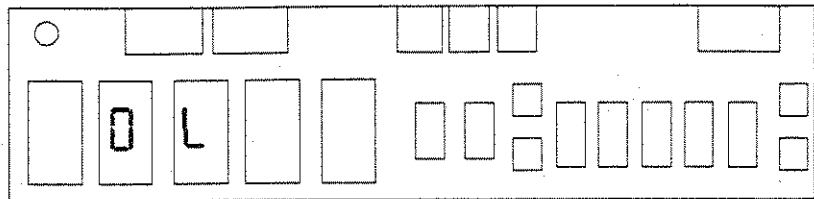

The above message appears in the following cases but the buzzer does not sound.

- The full scale for current measurement of the meter is "19999". However, when a value exceeding the full scale "19999" is input.
- For resistance measurement, operation is executed when the current value is kept between 3 and 19999. However, when the current measured value is equal to or less than "2" for the resistance measurement.
- When the input terminal is released for change of range or measurement of resistance, the message may appear.

(2) Overload Message

When the overload message appears, lower the measurement range.

(Press the ^{DOWN} key.)

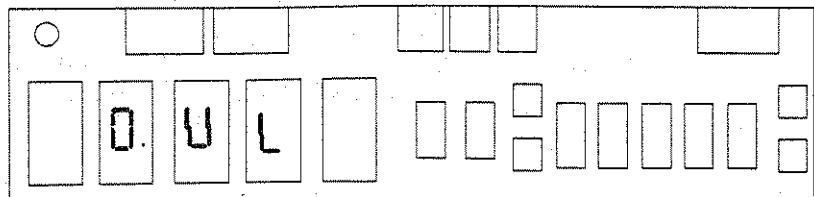

The above message appears in the following cases but the buzzer does not sound.

- When the current value exceed the range for resistance measurement, that is, when the current measured value exceeds "19999".

(3) Resistance Operation Error Message

When the resistance operation error message appears, set the output voltage.

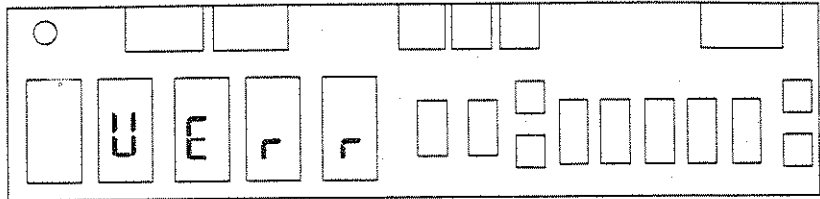

The above message appears in the following case but the buzzer does not sound.

- When the output voltage is set to 0V for measurement of resistance, volume resistivity, and surface resistivity.

(4) Fuse Open Detection Message

When the fuse open detection message appears, replace the input protection fuse.

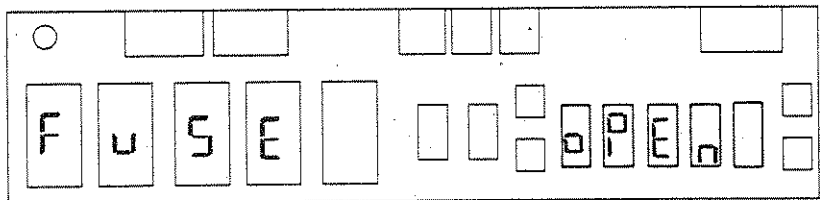

The above message appears in the following case and the high-pitched tone buzzer sounds.

- When overcurrent is input and the input protection fuse (1A) is gone.

(5) Limiter Message

When the limiter message appears, power is charged into or discharged from the sample. Start sample measurement after the message disappears.

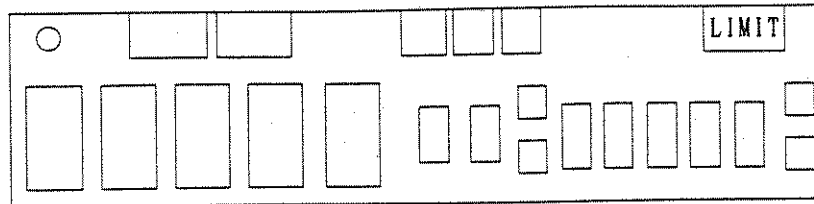

The above message appears in the following case but the buzzer does not sound.

- When the V SOURCE current limiter is detected.

(6) Overvoltage Detection Message

When the overvoltage detection message, remove the cable from V SOURCE terminal to eliminate overvoltage applied from the outside.

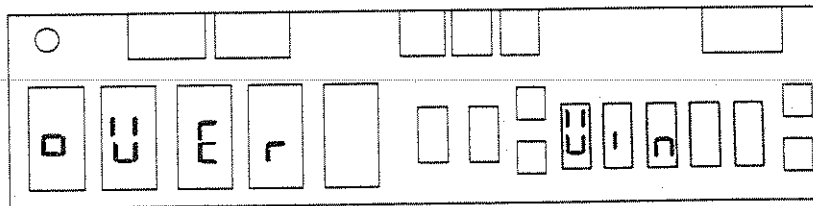

The above message appears in the following case and the high-pitched tone buzzer sounds and the V SOURCE becomes stand-by.

- When overvoltage is applied to the V SOURCE terminal (when negative voltage is applied or voltage of approx. 100V or more is applied for the setting between 0 and 100.00V).

(7) Overheat Detection Message

When the overheat detection message appears, immediately turn off the power switch.

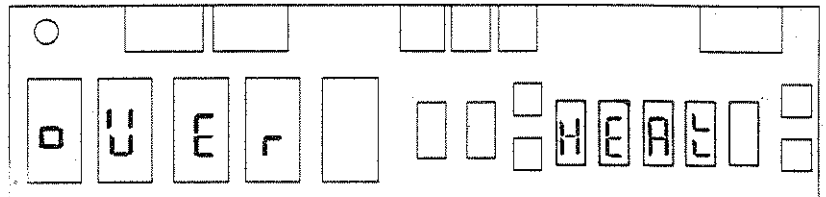

The above message appears in the following case and the high-pitched tone buzzer sounds and the V SOURCE becomes stand-by.

- When the internal circuit is overheated.

(8) Input Error

When a value impossible to set is input; the value flickers three times, the low-pitched tone buzzer sounds, and the state is ready for input again. In this case, input a correct value or press the  key to return the value to the previous one.

(9) If an error occurs, execute the following operation.

- ① When errors other than Err2 occur:

①-1 Turn off the power switch.

①-2 Immediately after turning on the power switch, press the

AUTO



key. This operation is called "power on initialize". The "power on initialize" operation can also be made by the GPIB command "*RST" or "Z".

If an error still occurs after the "power on initialize" operation, the tester may be faulty. In this case, consult the nearest dealer or the sales and support offices.

- ② When Err2 occurs:

When Err2 occurs, make calibration according to the procedure in Item 9.2 "Calibration".

Table 3-1 shows various error messages and their descriptions.

Table 3 - 1 Error Messages

| Error code | Error | Description |
|------------|-------------------------------|---|
| Err 1 | Backup parameter damage | Contents of a parameter such as panel backup are rewritten. |
| Err 2 | CAL DATA1 damage | Calibration primary data is rewritten. |
| Err 3 | CAL DATA2 damage | Calibration secondary data is rewritten. |
| Err 4 | Transfer error | Transfer error between internal CPUs |
| Err 5 | Operation error | Operation error on measured values |
| Err IA | Input amplifier failure | Trouble of input amplifier or IV converter |
| Err AD | A/D failure | Trouble of AD converter |
| Err HV | 100V amplifier failure | Trouble of amplifier for 10/100V range of V SOURCE output |
| Err KV | 1000V amplifier failure | Trouble of amplifier for 1000V range of V SOURCE output |
| Err RA | RAM R/W error | Read/write trouble of logic RAM |
| Err EP | E ² PROM R/W error | Read/write trouble of logic E ² PROM |
| Err LR | LOGIC ROM error | Trouble of logic ROM |
| Err AR | ANALOG ROM error | Trouble of analog ROM |

3.1.3. Table of Initialize Setting States

When the R8340 and R8340A press the AUTO key immediately after power-on, setting will be initialized as follows.

| Setting item | Normal state (When EXT CAL on the rear panel is turned off) | Calibration state (When EXT CAL on the rear panel is turned on) |
|--|--|--|
| IM/RM | IM(DC measurement) | Same with normal state |
| RANGE | AUTO | |
| SAMPLING | RUN | |
| NULL | OFF | |
| COMPARE | OFF | |
| MODE | MEASURE | |
| CONTACT | OFF | |
| PRGM/NORM | NORMAL | |
| START | STOP | |
| VS | 00.000V | |
| OPERATE | STANDBY | |
| Integration time | 10PLC | |
| AD CAL | ON | |
| Input amplifier gain | × 10 | × 10000 |
| Current limiter | 300mA | Same with normal state |
| Auto-range | UP 20000 | |
| UP/DOWN level | DOWN 1799 | |
| Unit indication | Symbol | |
| Trigger delay | 0sec | |
| Autorange delay | 0sec | |
| Zero cancel | OFF | |
| Contact initial | OFF | |
| Self-test | OFF | |
| DA OUT | OFF | |
| BCD OUT | OFF | |
| GPIB | Header ON, address- able address -- | Header ON, address- able address 01 |
| Power frequency | — | 50Hz |
| UPPER | 19.999mA | Same with normal state |
| LOWER | 000.00pA | |
| Resistance measurement indication | Resistance value | |
| Setting of electrodes for volume and surface resistivities | 50mm-dia main electrode | |
| Optional electrode coefficient | Same with the coefficient of 50mm-dia main electrode | |
| Sample thickness | 1mm | |
| Contact checking level | × 1 | |

(Cont'd)

| Setting item | Normal state (When EXT CAL on the rear panel is turned off) | Calibration state (When EXT CAL on the rear panel is turned on) |
|-------------------------------------|--|--|
| Buzzer | ON | } Same with normal state |
| Indication | ON | |
| Contact initial integration time | 2ms | |
| Data store | OFF | |
| Data recall | OFF | |
| Stored data | Clear | |
| Program No. | 0 | |
| Charge time | 60sec | |
| Discharge time | 1sec | |
| Measurement time | 0sec | |
| Automatic start value | 001.00pA | |

3.2 Basic Operation Method

The following describes the method for DC measurement (IM), voltage applying current measurement (VSIM), resistance measurement (VSRM), volume resistivity measurement, and surface resistivity measurement which are basic measurement functions.

Turn on the power switch to set the power frequency to be used before starting the following operation.

3.2.1 How to Use Short bar of Earthed/Isolated Sample

WARNING

1. The R8340/8340A store the circuit to generate high voltage. Therefore, you are dangerous unless the frame is earthed.
2. Be sure to earth the frame using the three-pin connector of the attached power cable or the GND terminal on the front or rear panel.

(1) Connection of Isolated Sample

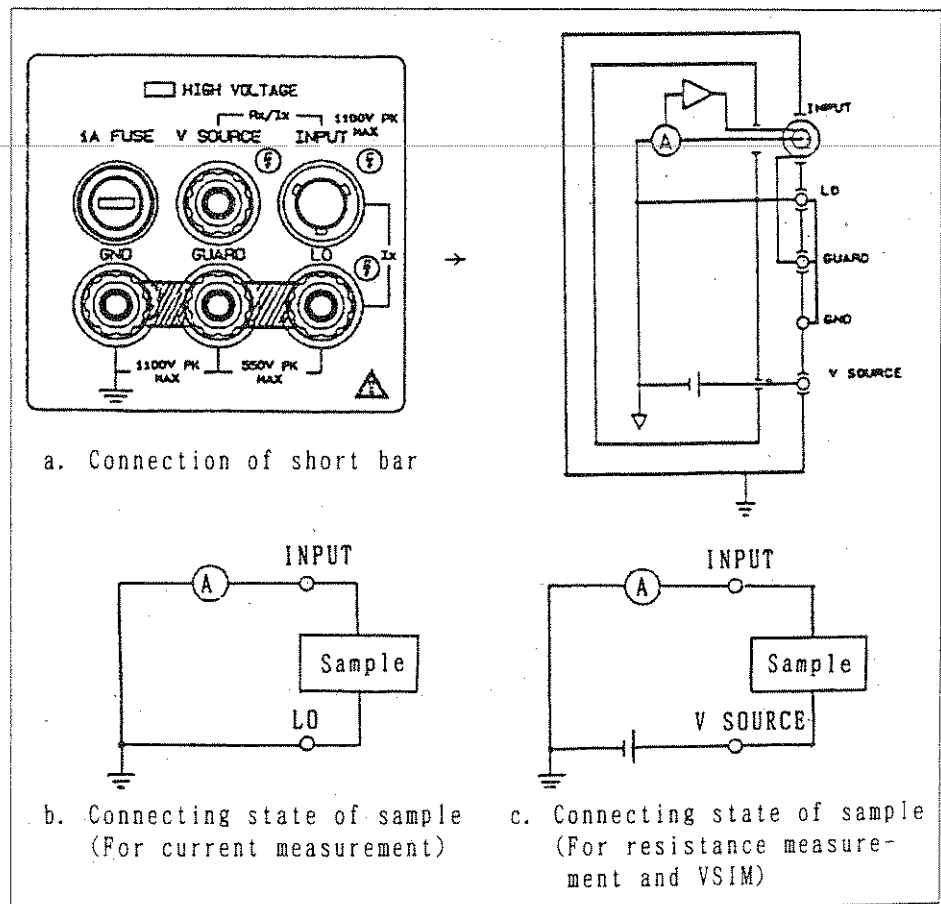

Figure 3 - 1 Connection of Isolated Sample

Operation(① through ③)

- ① Connect the short bar as shown in Figure 3-1a.
- ② For current measurement
 Connect a sample between the INPUT and the LO terminals as shown in Figure 3-1b.
- ③ For resistance measurement and VSIM
 Connect a sample between the INPUT and V SOURCE terminals as shown in Figure 3-1c.

(2) Connection of Earthed Sample (For current measurement)

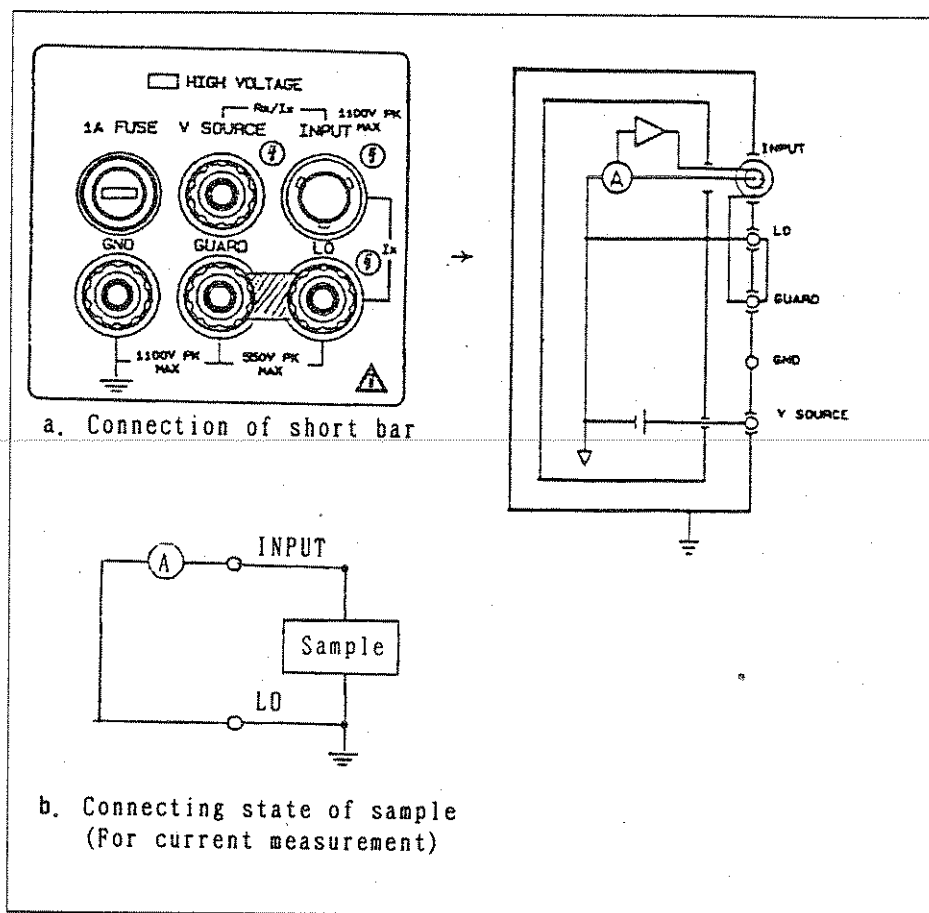

Figure 3 - 2 Connection of Earthed Sample for Current Measurement

Operation(① and ②)

- ① Connect the short bar as shown in Figure 3-2a.
- ② Connect a sample between the INPUT and LO terminals as shown in Figure 3-2b.

(3) Connection of Earthed Sample (For resistance measurement and VSIM)

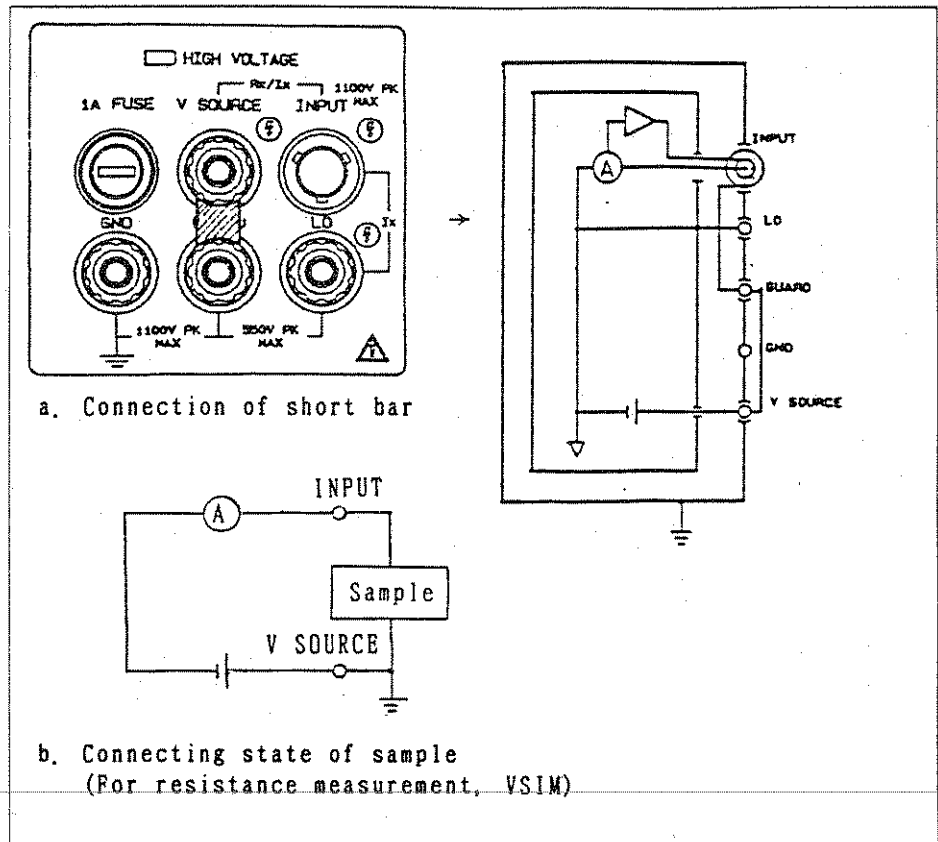

Figure 3 - 3 Connection of Earthed Sample for Resistance Measurement and VSIM

Operation(① and ②)

- ① Connect the short bar as shown in Figure 3-3a.
- ② Connect a sample between the INPUT and V SOURCE terminals as shown in Figure 3-3b.

CAUTION

1. When the V SOURCE and GUARD terminals are connected by the short bar, the voltage of -VS is applied to the core wire of the LO and INPUT terminals and the inside shield. This is the state when up to -1000V is applied.
2. You are dangerous if you connect an isolated sample according to the connection method in Figure 3-3.
3. Up to 550V can be applied to the R8340. To apply the voltage of more than 550V, use the R8340A.

(4) Connection for Coexistence of Isolated and Earthed Samples
(For resistance measurement and VSIM)

When earthed and isolated samples are mixed or unknown for resistance measurement and VSIM, connect the sample as follows:

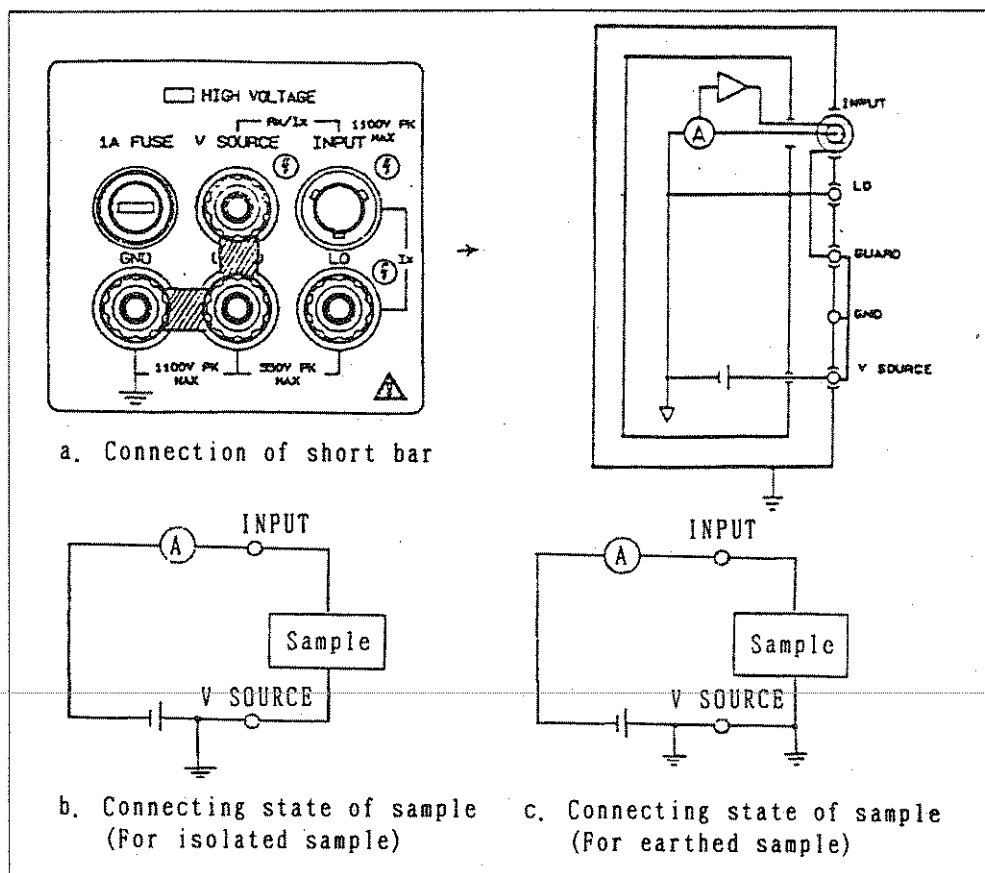

Figure 3 - 4 Connection for Coexistence of Isolated and Earthed Samples
Operation(① and ②)

- ① Connect the short bar as shown in Figure 3-4a.
- ② Connect a sample between the INPUT and V SOURCE terminals as shown in Figure 3-4b.
Connect an isolated sample as shown in Figure 3-4b and an earthed samples as shown in Figure 3-4c.

CAUTION

If you connect the short bar when the sample is isolated as shown in Figure 3-3, you are dangerous because voltage is applied to the external metal of the INPUT terminal and the GUARD terminal. Therefore, connect the sample as shown in Figure 3-4.

3.2.2 Discharge, Charge, and Measure

Figure 3-5 shows the basic flow of operation for DC measurement (IM), voltage applying current measurement (VSIM), resistance measurement (VSRM), volume resistivity measurement, and surface resistivity measurement of the meter.

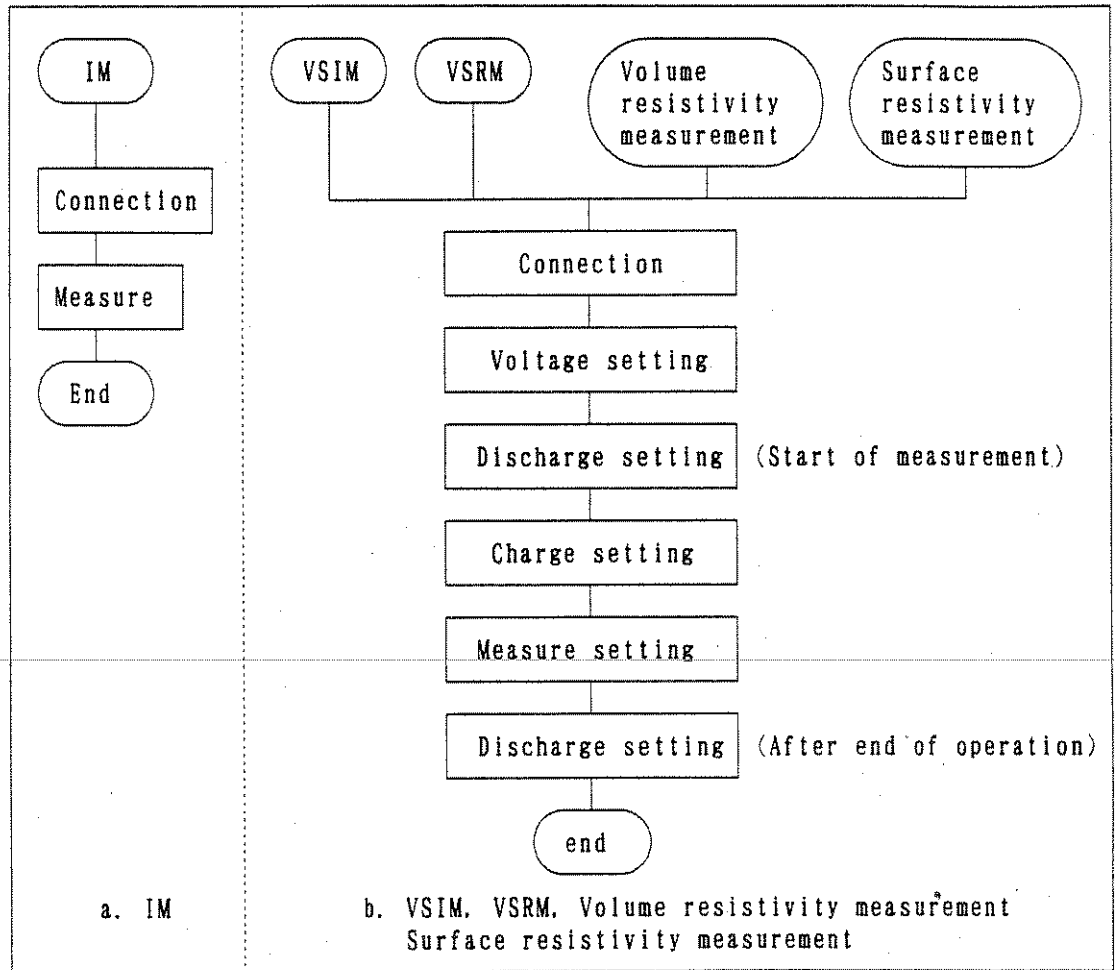

Figure 3 - 5 Basic Flow of Operation

The following describes discharge, charge, and measure shown in Figure 3-5. Also reference the equivalent circuit in Figure 3-6.

(1) Discharge

No voltage is applied to the sample. Because the V_s stores a current limiter, it constantly flows the sample discharge current.
 Under the discharge state, no voltage is applied to the V_s and the S_1 is turned on as shown in Figure 3-6.

(2) Charge

The voltage of the V_s is applied to the sample. The charge current is limited similarly to discharge in Item (1). Under the charge state, the V_s voltage is kept at the set value and the S_1 is turned on as shown in Figure 3-6.

(3) Measure

The current flowing through the sample is measured under the state in which the voltage of the V_s is applied to the sample. Under the measure state, the V_s voltage is kept at the set value and the S_1 is turned off.

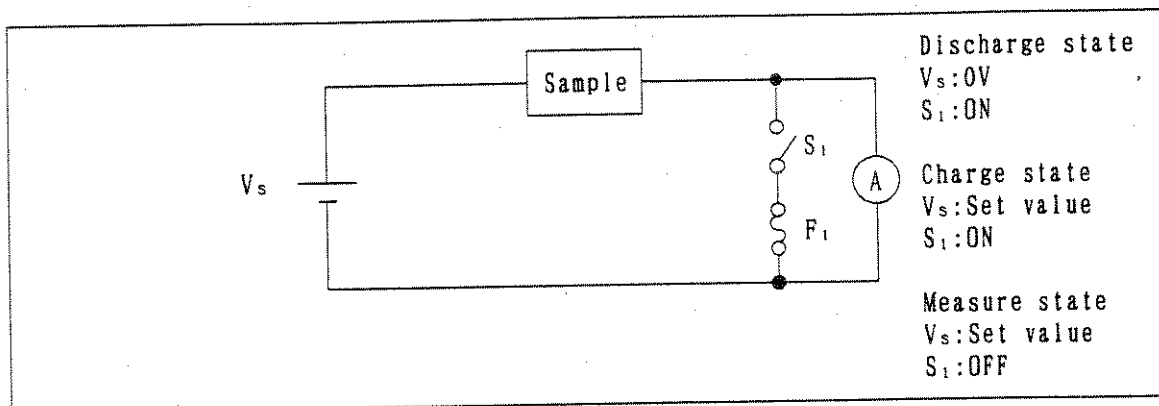

Figure 3 - 6 Equivalent Circuit Under Discharge, Charge, and Measure States

Note: The fuse in Figure 3-6 protects the F_1 when overcurrent is applied from an external power supply under discharge or charge state.

Figure 3-7 shows the basic method to measure voltage applying current, resistance, volume resistivity, and surface resistivity.

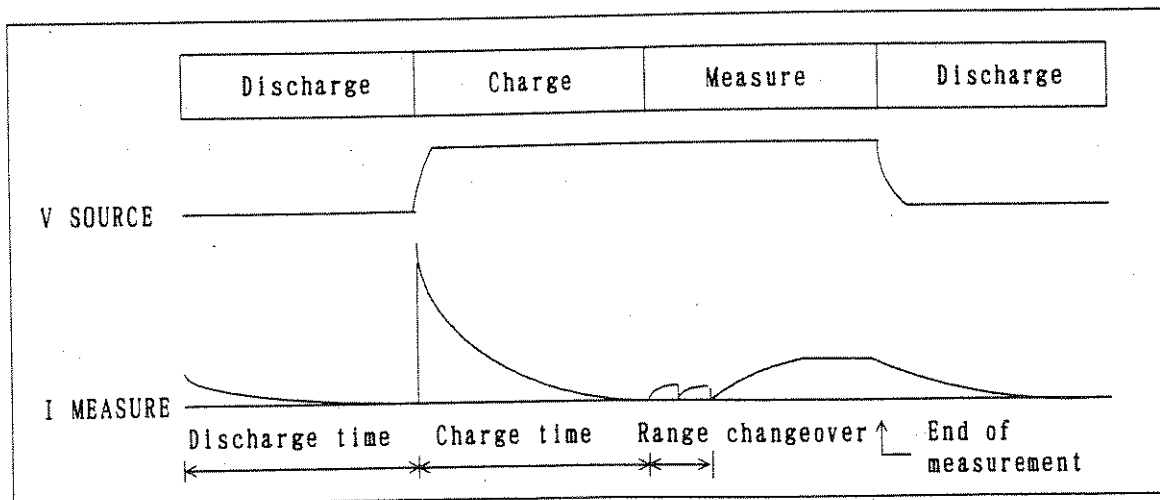

Figure 3 - 7 Basic Measurement

3.2.3 DC Measurement (IM)

The following describes the basic flow of operation for DC measurement shown in Figure 3-5a in detail.

Operation((1) through (3))

(1) Setting of Current Measured Value Indication

Set the ^{IM/RM}
 key to the current measured value indication IM.

(2) Connection of Input/Output Cables

Follow the connection procedure in Item 3.2.1 Sub-item (1) or (2).

CAUTION

The V SOURCE terminal on the meter outputs up to 1000V. Therefore, connect the input/output cables and the sample to be measured under any one of the following states for safety.

- Power-off state
- Discharge state (The LED of the DISCHARGE key lights.)
- V SOURCE stand-by state (The LED on the OPERATE key goes out.)

(3) MEASURE Setting

- ① Check if the V SOURCE is stand-by (the LEDs of the OPERATE key go out).

If not, press the ^{OPERATE}
 key.

- ② Press the ^{MEASURE}
 key to set the measure state (the LED of the MEASURE key lights).

- ③ Read the measured value indication.

3.2.4 Voltage Applying Current Measurement (VSIM)

The following describes the basic flow of operation for voltage applying current measurement shown in Figure 3-5b in detail. Reference Figure 3-7 according to necessity.

Operation((1) through (7))

(1) Setting of Current Measured Value Indication

Set the ^{IM/RM}
 key to the current measured value indication IM.

(2) Connection of Input/Output Cables

See the connection procedure in Item 3.2.1 Sub-items (1), (3), and (4).

CAUTION

The V SOURCE terminal on the meter outputs up to 1000V. Therefore, connect the input/output cables and the sample to be measured under any one of the following states for safety.

- Power-off state
- Discharge state (The LED of the DISCHARGE key lights.)
- V SOURCE stand-by state (The LED on the OPERATE key goes out.)

(3) Voltage Setting

① Setting of generated voltage value

①-1 Press the key.

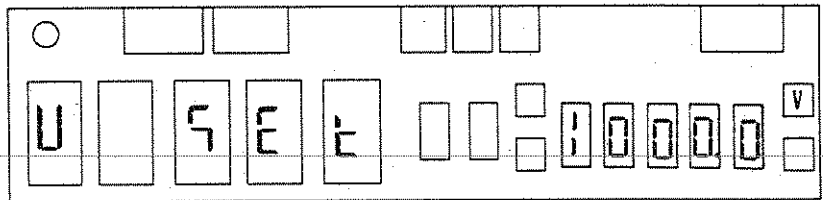

Present set voltage

①-2 Set the value to 123.4V.

Press the ₁ ₂ ₃ ₄ key.

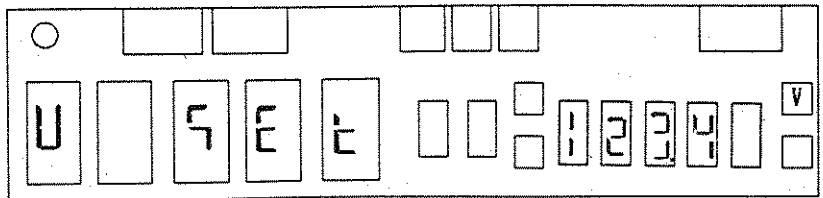

①-3 Press the key.

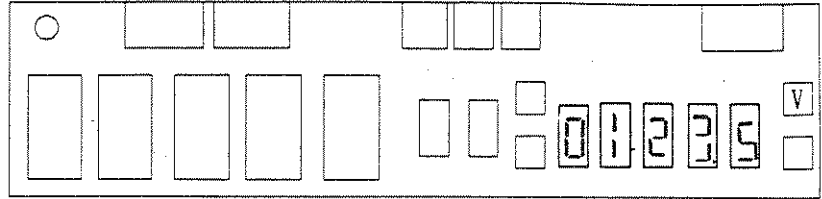

Newly as voltage

CAUTION

- Resolution for voltage setting
 The resolution for voltage setting is 2.5 counts.
 Therefore, the set value of the input final digit, is set as follows:

| Input value | | Set value |
|-------------|---|-----------|
| 0,1 | → | 0 |
| 2,3 | → | 3 |
| 4,5,6 | → | 5 |
| 7,8 | → | 8 |
| 9 | → | 0 |

- Input error
 The setting range is 0.0 to 1000.0V. If a value exceeding the range is set (when the ENTER key is pressed); an input error occurs, the input value flickers three times, and the state is ready for value input again.
- Value change
 If inputting an incorrect value, press the key and the preceding set value is displayed and a new value can be set.
- HIGH VOLTAGE LED
 When the set value is 100.3V or more, the HIGH VOLTAGE LED lights.

② Output of set voltage

OPERATE

When the key is pressed, the set voltage is output. The LED of the key lights during operation.

(4) Discharge Setting

DISCHARGE
 When the key is pressed, the discharge state is set, the V SOURCE is brought to 0V, input is shorted, and the electric charge in the sample is discharged.

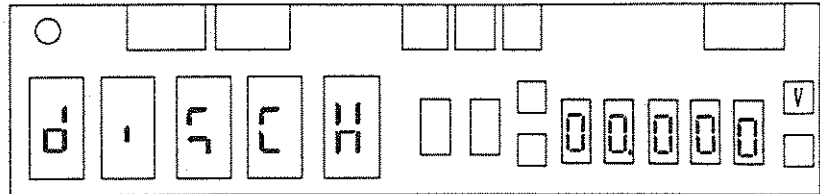

The above state can be canceled only by the **CHARGE** and **MEASURE** keys.

(5) Charge Setting

CHARGE
 When the key is pressed, the charge state is set, the set value of V SOURCE is output, input is shorted, and the sample to be measured is charged.

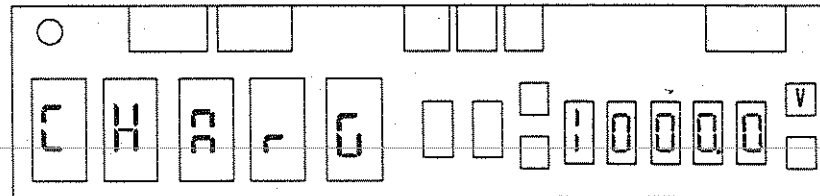

Set voltage value

The above state can be canceled only by the **DISCHARGE** and **MEASURE** keys. If the **OPERATE** key is stand-by, no voltage is generated.

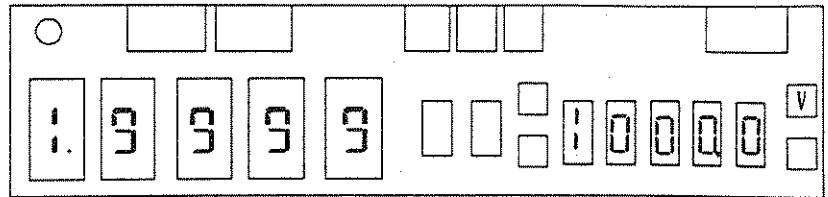

(6) Measure Setting

When the ^{MEASURE}  key is pressed, the measure state is set, the set value of V SOURCE is output, input is ready for measurement, and measurement is started.



Measurement state

Set voltage value

The above state can be canceled only by the ^{DISCHARGE}  and ^{MEASURE}  keys. If the ^{OPERATE}  key is stand-by, no voltage is generated.

(7) Discharge Setting

After measurement, press the ^{DISCHARGE}  key and the electric charge in the sample is discharged.

3.2.5 Resistance Measurement (VSRM)

The resistance of the meter is expressed as the value obtained by dividing the generated voltage by the measured current as shown below.

$$\text{Resistance value} = \text{Generated voltage} / \text{measured current}$$

The following describes the basic flow of operation for resistance measurement (VSRM) shown in Figure 3-5b in detail. Reference Figure 3-7 according to necessity.

Operation((1) through (7))

(1) Setting of Resistance Measured Value Indication

Set the ^{IM/RM} key to the resistance measured value indication RM.

(2) Connection of Input/Output Cables

For connection of input/output cables, see Item 3.2.1 Sub-items (1), (3), and (4).

(3) Voltage Setting

① Setting of generated voltage

①-1 Press the ^{SET} key.

Display panel state

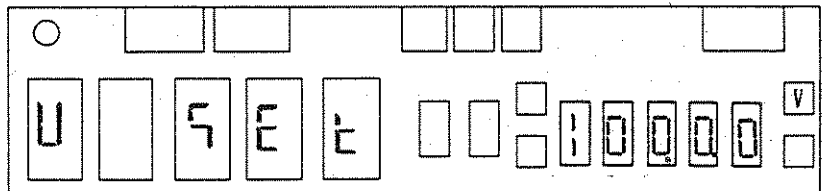

Present set voltage

①-2 Set the value to 123.4V.

Press the ₁ ₂ ₃ ₄ keys.

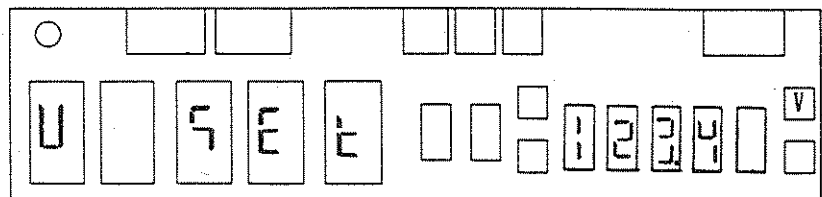

①-3. Press the key.

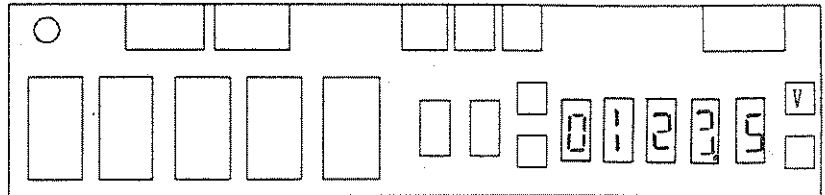

Newly set voltage

CAUTION

- Resolution for voltage setting
 The resolution for voltage setting is 2.5 counts.
 Therefore, the set value of the input final digit is set as follows:

| Input value | Set value |
|-------------|-----------|
| 0.1 → | 0 |
| 2.3 → | 3 |
| 4.5, 6 → | 5 |
| 7, 8 → | 8 |
| 9 → | 0 |

- Input error
 The setting range is 0.0 to 1000.0V. If a value exceeding the range is set (when the ENTER key is pressed); an input error occurs, the input value flickers three times, and the state is ready for value input again.
- Value change
 If inputting an incorrect value, press the key and the preceding set value is displayed and a new value can be set.
- HIGH VOLTAGE LED
 When the set value is 100.3V or more, the HIGH VOLTAGE LED lights.

② Output of set voltage

When the key is pressed, the set voltage is output. The LED of the key lights during operation.

(4) Discharge Setting

DISCHARGE
 When the key is pressed, the discharge state is set, the V SOURCE is brought to 0V, input is shorted, and the electric charge in the sample is discharged.

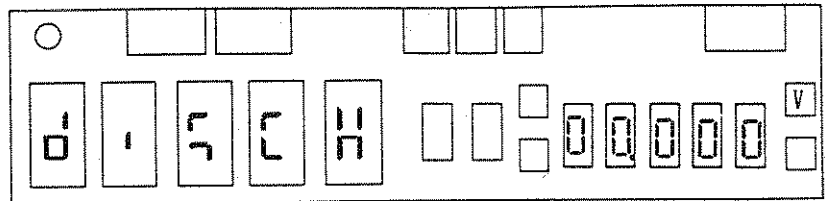

The above state can be canceled only by the **CHARGE** and **MEASURE** keys.

(5) Charge Setting

CHARGE
 When the key is pressed, the charge state is set, the set value of V SOURCE is output, input is shorted, and the sample to be measured is charged.

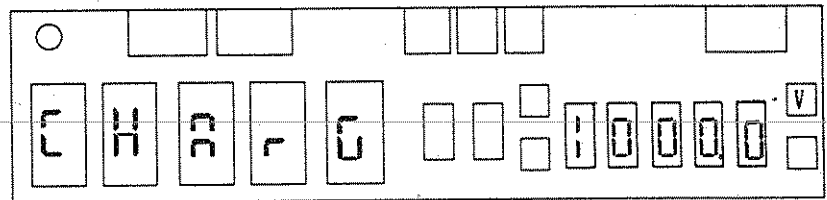

Set voltage value



The above state can be canceled only by the **DISCHARGE** and **MEASURE** keys. If the **OPERATE** key is stand-by, no voltage is generated.

(6) Measure Setting

When the ^{MEASURE}  key is pressed, the measure state is set, the set value of V SOURCE is output, input is ready for measurement, and measurement is started.

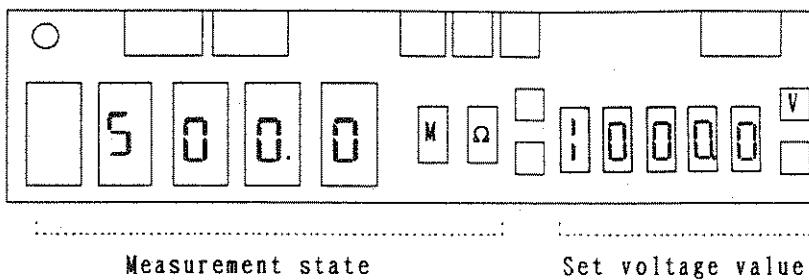
Display panel state



The above state can be canceled only by the ^{DISCHARGE}  and ^{MEASURE}  keys. If the ^{OPERATE}  key is stand-by, no voltage is generated.

(7) Discharge Setting

After measurement, press the ^{DISCHARGE}  key and the electric charge in the sample is discharged.

3.2.6 Measurement of Volume Resistivity and Surface Resistivity

(1) How to Obtain Volume and Surface Resistivities

Obtain the volume and surface resistivities with the measuring electrodes specified in JIS K-6911 and K-6723 shown in Figure 3-8 and 3-9 by measuring resistances and using the following formulas.

$$\text{Volume resistivity } \rho v = \frac{\pi d^2}{4t} \times Rv \quad \text{--- ①}$$

$$\text{Surface resistivity } \rho s = \frac{\pi (D+d)}{D-d} \times Rs \quad \text{--- ②}$$

- ρv : Volume resistivity [Ω cm]
- ρs : Surface resistivity [Ω]
- Rv : Volume resistance [Ω] ← Measured value
- Rs : Surface resistance [Ω] ← Measured value
- π : Ratio of the circumference of a circle to its diameter = 3.14
- t : Sample thickness [cm]
- D : Inside diameter of guard electrode [cm]
- d : Diameter of main electrode [cm]

The electrode dimensions are specified in JIS as shown in Table 3-2. When substituting these values for the above formulas ① and ②, the following formulas ③ through ⑥ are obtained. (The above-mentioned units is used for calculation.)

Table 3 - 2 Electrode Dimensions Specified in JIS

| | JIS-K6911 | JIS-K6723 |
|---|-----------|-----------|
| Outside diameter of main electrode d-dia | 50mm | 70mm |
| Inside diameter of guard electrode D-dia | 70mm | 90mm |

• For JIS-K6911 (Main-electrode outside diameter of 50mm-dia)

$$\text{Volume resistivity } \rho v = 19.63 \times \frac{Rv}{t} \quad [\Omega \text{ cm}] \quad \text{--- ③}$$

$$\text{Surface resistivity } \rho s = 18.84 \times Rs \quad [\Omega] \quad \text{--- ④}$$

- For JIS-K6723 (Main-electrode outside diameter of 70mm-dia)

$$\text{Volume resistivity } \rho v = 38.47 \times \frac{Rv}{t} \quad (\Omega \text{ cm}) \quad \text{--- ⑤}$$

$$\text{Surface resistivity } \rho s = 25.12 \times Rs \quad (\Omega) \quad \text{--- ⑥}$$

The volume and surface resistivities can be obtained by substituting measured values for the above formulas ③ through ⑥.

- (2) Volume Resistivity Measuring Functions and Surface Resistivity Measuring Functions of the Meter

The meter calculates the volume and surface resistivities with resistance measured values through internal operation using the formulas ③ through ⑥.

The measurement using the electrode in JIS-K6911 (main-electrode outside diameter of 50mm-dia) or JIS-K6723 (main-electrode outside diameter of 70mm-dia) is selected by setting parameters.

It is also possible to set the constant (electrode factor) in ③ and ④ formulas to an optional value. Set an optional value for the measurement using electrodes with any dimensions out of JIS.

For the volume resistivity measurement, it is needed to set the thickness of the sample to be measured. In these set values, unit is mm.

The following describes the basic flow of operation for volume and surface-resistivity measurement in Figure 3-5b in detail. Reference the basic measurement in Figure 3-7 according to necessity.

Operation((1) through (9))

- (1) For how to select volume resistivity measurement indication or surface resistivity measurement indication, see Item 4.4.3.
- (2) For how to set electrode to be used, see Items 4.4.4 and 4.4.5.
- (3) To measure volume resistivity, set the sample thickness by referencing Item 4.4.6.

(4) Connecting the instrument to test fixtures, refer to chapter 11.

- ① For volume resistivity measurement
Connect the electrode as shown in Figure 3-8.
- ② For surface resistivity measurement
Connect the electrode as shown in Figure 3-9.

When the TR42 and TR43C test fixtures are connected to the meter, volume or surface resistivity can be selected by connecting a short bar.

When the R12702A/B and R12704 test fixtures are connected to the meter, resistivity selection can be made with a switch.

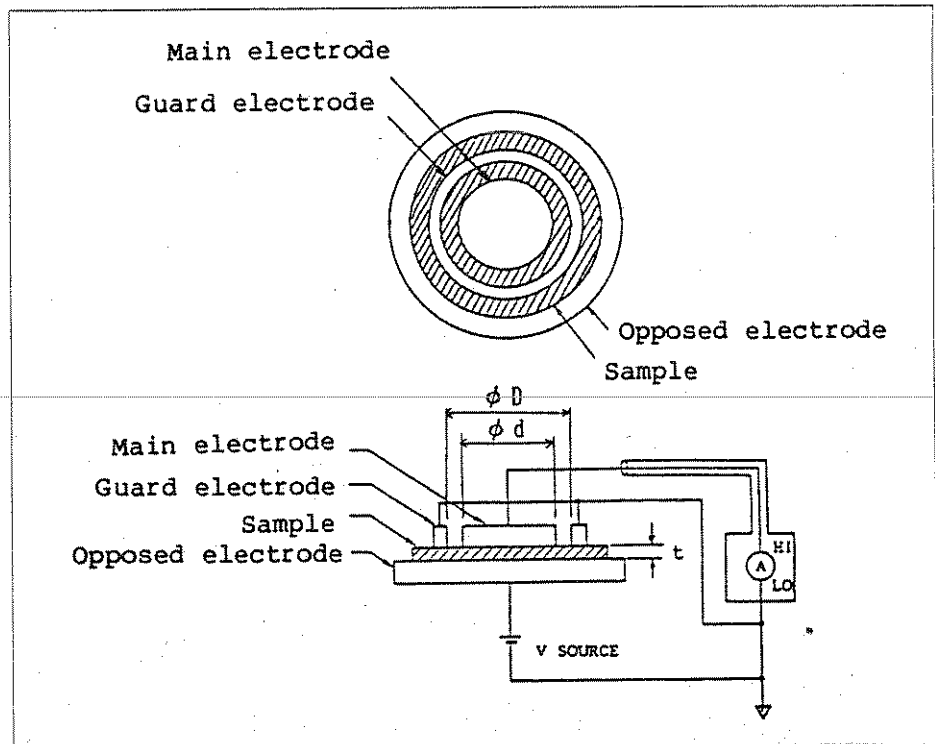

Figure 3 - 8 Electrode Connection (For volume resistivity measurement)

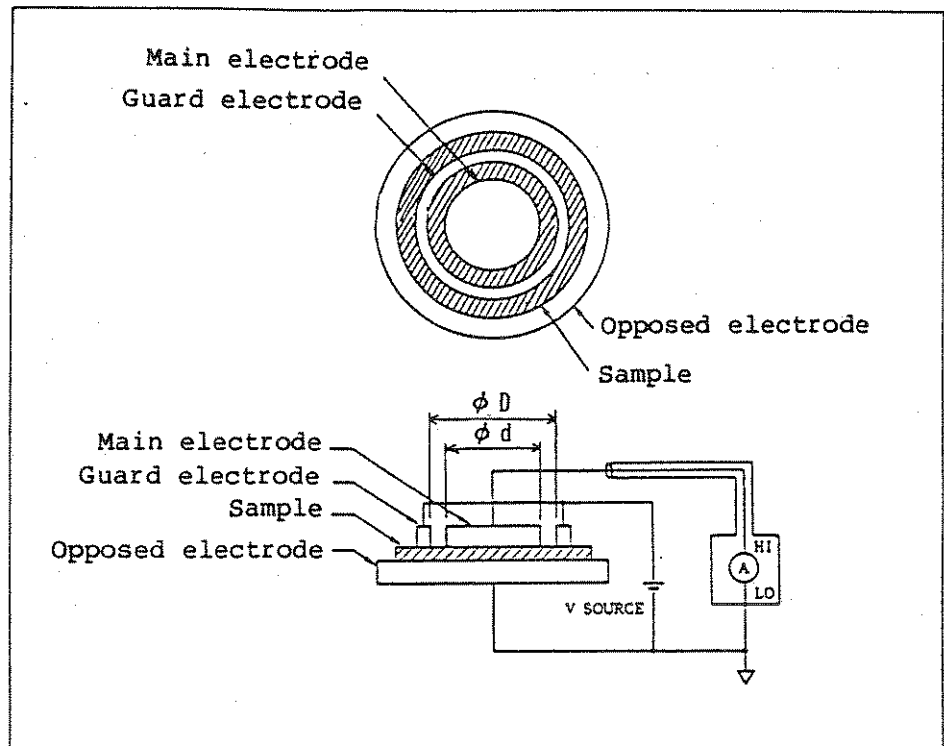

Figure 3 - 9 Electrode Connection (For surface resistivity measurement)

(5) Voltage Setting

① Setting of Generated Voltage Value

①-1 Press the key.

Display panel state

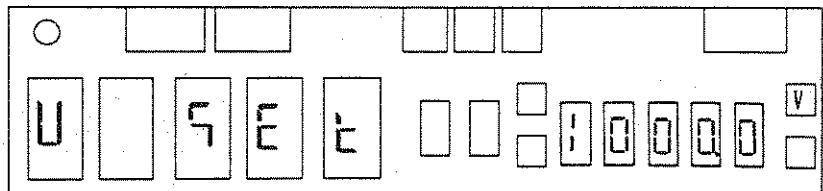

Present set voltage

①-2 Set the value to 123.4V.

Press the keys.

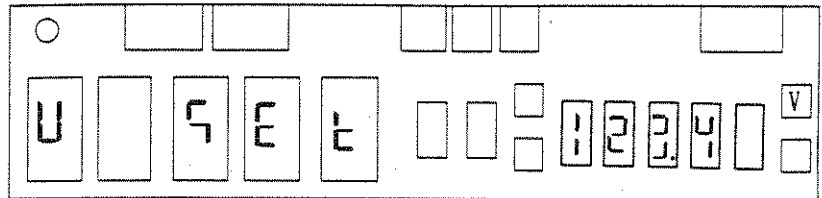

①-3 Press the key.

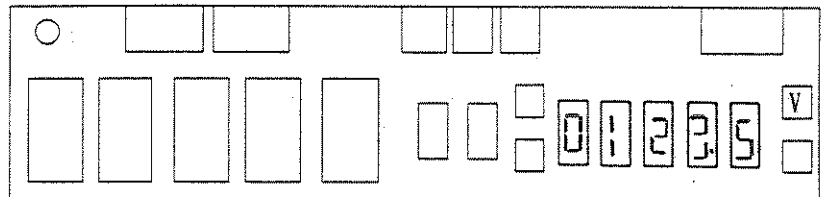

Newly set voltage

② Output of set voltage

When the key is pressed, the set voltage is output. The LED of the key lights during operation.

CAUTION

1. Resolution for voltage setting

The resolution for voltage setting is 2.5 counts.
Therefore, the set value of the input final digit is set as follows:

| Input value | Set value |
|-------------|-----------|
| 0.1 | → 0 |
| 2.3 | → 3 |
| 4.5.6 | → 5 |
| 7.8 | → 8 |
| 9 | → 0 |

2. Input error

The setting range is 0.0 to 1000.0V. If a value exceeding the range is set (when the ENTER key is pressed); an input error occurs, the input value flickers three times, and the state is ready for value input again.

CAUTION

(cont'd)

3. Value change
 If inputting an incorrect value, press the  key and the preceding set value is displayed and a new value can be set.

4. HIGH VOLTAGE LED
 When the set value is 100V or more, the HIGH VOLTAGE LED lights.



(6) Discharge Setting

DISCHARGE

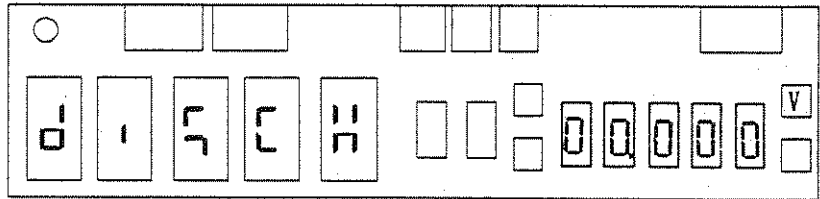
When the  key is pressed, the discharge state is set, the V SOURCE is brought to 0V, input is shorted, and the electric charge in the sample is discharged.



CHARGE MEASURE

The above state can be canceled only by the  and  keys.

(7) Charge Setting

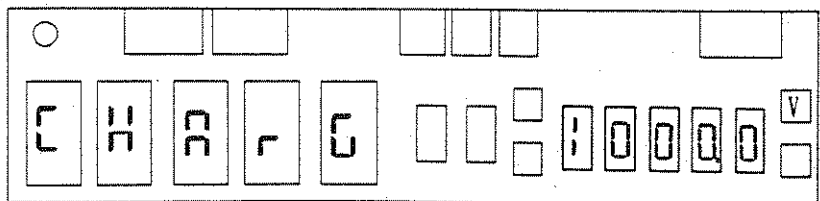

CHARGE

When the  key is pressed, the charge state is set, the set value of V SOURCE is output, input is shorted, and the sample to be measured is charged.



Set voltage value

DISCHARGE MEASURE

The above state can be canceled only by the  and  keys. If the  key is stand-by, no voltage is generated.

(8) Measure Setting

When the ^{MEASURE} key is pressed, the measure state is set, the set value of V SOURCE is output, input is ready for measurement, and measurement is started.

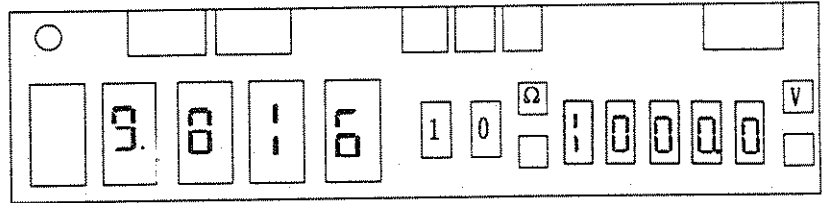

Measurement state

Set voltage value

The above state can be canceled only by the ^{DISCHARGE} and ^{MEASURE} keys. If the ^{OPERATE} key is stand-by, no voltage is generated.

(9) Discharge Setting

After measurement, press the ^{DISCHARGE} key and the electric charge in the sample is discharged.

3.3 Various Functions

3.3.1 Null

This mode is effective for cancel of contact resistance, compensation of dark current, and cancel of background current.

This mode has the function to subtract the data displayed when pressing the NULL key from the next data and display the operation result as data. The operation includes polarity and range.

When assuming:

X(NULL): Measured data for NULL setting

X : Next measured data

R : NULL operation data

The NULL operation is expressed as $R = X - X(\text{NULL})$.

(Example1)

When assuming $X(\text{NULL}) = -10.00\text{pA}$ (200pA range) and
 $X = 1.0000\text{nA}$ (2-nA range), the following
expression is obtained.
 $R = 1.0100\text{nA}$ (2nA range)

(Example2)

When assuming $X(\text{NULL}) = 1.0000\text{nA}$ (2nA range) and
 $X = 0.0100\text{nA}$ (2nA range), the following
expression is obtained.
 $R = -0.9900\text{nA}$ (2nA range)

Operation(① and ②)

- ① When the ^{NULL} key is pressed, the NULL mode is set and the LED on the key lights.
- ② When the ^{NULL} key is pressed again, the NULL mode is canceled and the LED goes out.

CAUTION

1. When the NULL mode is set, the range is not lowered regardless of the auto and manual ranges.
2. When the ^{IM/RM} key is pressed to change the volume resistivities, the surface resistivities and the auto range level, the NULL mode is canceled.
3. If the data when the NULL mode is set is out of the range, it is out of the range also in the NULL mode.

3.3.2 Compare

This mode has the function to compare the size of measured data with the upper level/lower level preset values and display the results. When the buzzer mode is set at ON, the buzzer sounds at the end of comparison. The following table shows the relationship between the operation results (comparison results) and indication.



Table 3 - 3 COMPARE Operation Results and Indication

| Operation results | Indication | Buzzer |
|-------------------|------------|-------------------|
| $X > Y$ | HI | High-pitched tone |
| $Z \leq X \leq Y$ | GO | No sound |
| $X < Z$ | LO | Low-pitched tone |

X: Measured data
 Y: UPPER level set value
 Z: LOWER level set value

The upper level/lower level set values can be set to the current measurement, resistance measurement, volume resistivity measurement, and surface resistivity measurement respectively, including polarity, range, decimal point, and exponential data. For how to set upper and lower levels, see Items 4.4.1 "Upper level" and 4.4.2 "Lower level".

Operation(① and ②)

- ① When the  key is pressed, the COMPARE mode is set and the LED on the key lights.
- ② When the  key is pressed again, the COMPARE mode is canceled and the LED goes out.

3.3.3 Integration Time

The input signal integration time of the A/D converter can be selected among the following seven types: 2ms, 1PLC, 5PLC, 10PLC, 10PLC × 4, 10PLC × 8, and 10PLC × 16. In this case, "PLC" stands for "Power Line Cycle" which means one cycle of AC power supply. The time of 1PLC equals 20ms for 50Hz and approx. 16.667ms for 60Hz. The time of "10PLC × 4" to "10PLC × 16" is the value obtained by averaging the data for 10PLC integration time 4 to 16 times respectively. If the integration time is increased by input noises when data variation is large, data with a small variation can be obtained.

For the integration time of 1PLC to 10PLC × 16, NMR of 60dB or more is obtained and the measured data is 4.5 digits. For the integration time of 2ms, NMR becomes 0dB and the measured data is 3.5 digits.

When the integration time is changed between 2ms and 10PLC, the AD CAL function operates and calibration measurement for 2 samples is executed.

For how to set integration time, see Item 4.2.1 "Integral time".

3.3.4 AD CAL

When the AD CAL function is set to ON, the A/D converter calibration is executed every approx. 10 sec.

This cycle is kept independently of integration time and RUN/HOLD.

Because calibration cancels the offset drift of A/D converter,

Set this switch to ON when the measurement conditions change or when the meter has been used in the AD CAL OFF setting for a long time.

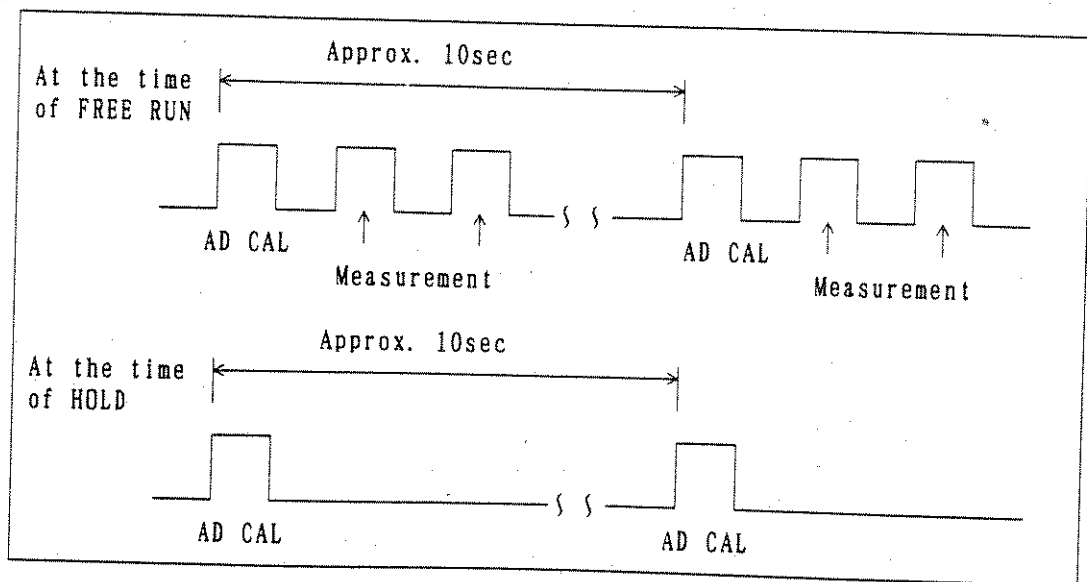

Figure 3 - 10 AD CAL Timing

When measurement is externally started during execution of the AD CAL function at the time of HOLD, it starts after the AD CAL function being executed finishes.

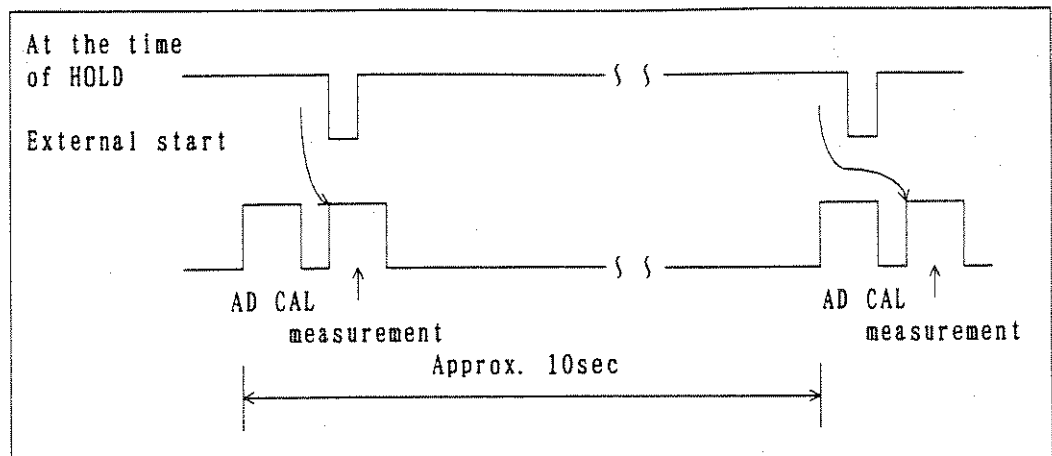

Figure 3 - 11 Timing When Measurement Starts During Execution of AD CAL Function

For how to set AD CAL function to ON or OFF, see Item 4.4.2 "AD CAL".

3.3.5 Input Amplifier Gain

The speed of measurement for leak current and insulation resistance of high-resistance samples, especially capacitors, is determined by the capacity C_x of the sample and the input resistance of the measuring instrument. Figure 3-12 shows the equivalent circuit.

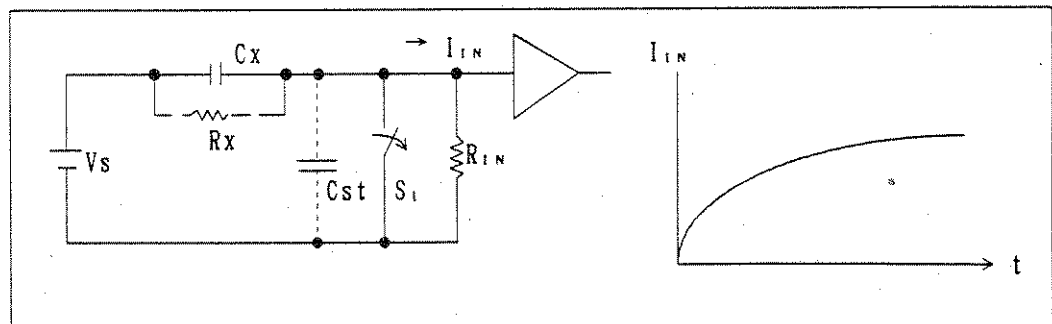

Figure 3 - 12 Equivalent Circuit for Measurement of Capacitor Leak Current

Figure 3-12 shows the response when S_1 is set to ON in the charge state and then the measure state starts by turning S_1 off after completion of charge.

For micro-current measurement, R_{IN} becomes a large value and its response takes a long time. When R_{IN} is set to $1 \times 10^{10} \Omega$ in 100pA measurement, for example, the time of approx. 5×10^4 sec is required according to the then constant if " C_x " equals 1 μ F.

Even if the sample has a pure resistance, the response is delayed because of the cable capacitance "C_x". For a coaxial cable, "C_x" is generally equal to approx. 100pF/m. Therefore, in the above case, the time of approx. 5sec is required even for a pure resistance.

General electrometers use the feedback-system input circuit to decrease input resistance and improve response. Figure 3-13 shows the feedback-system equivalent circuit.

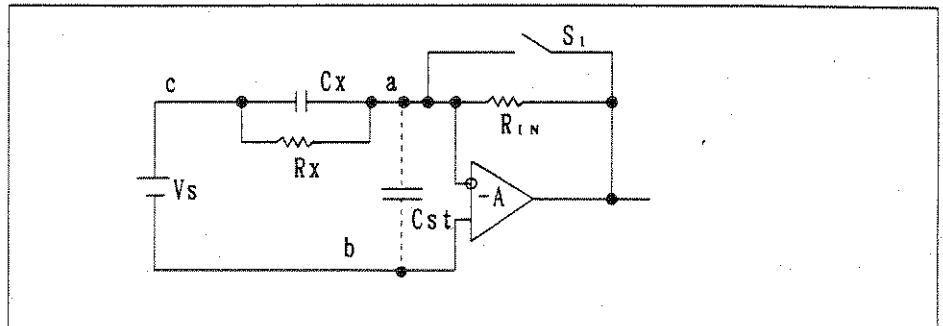





Figure 3 - 13 Feedback-system Equivalent Circuit

The feedback system greatly decreases the input resistance up to R_{IN}/A . In addition, because the potential difference between the points "a" and "b" is zero, there is no influence of C_x. Therefore, response is much faster than that in Figure 3-12. However, because the AC noise at the points "a" and "c" is multiplied by "A", it is needed to completely shield the point "a" or minimize the V_s noise. Especially for a large "C_x" as in capacitor measurement, the noise between "c" and "a" is directly multiplied by "A" and even a very low noise becomes an issue.

Because the gain "A" in Figure 3-13 can be externally changed for the R8340 and R8340A, the input resistance can be selected according to the system noise condition and necessary measurement speed. For A = 1 in Figure 3-13, the equivalent circuit functions as the circuit same as that in Figure 3-12, which is strong in noises. When "A" is increased, the input resistance decreases and response quickens. The value of "A" can be selected among four cases of x 1, x 10, x 100, and x 10000 or more. To perform quick-response high-accuracy measurement, it is better to make "A" larger. However, the noise of the measurement system and V_s must be decreased.

The initial set value is set to "x 10" by considering noise and response. For how to set input amplifier gain, see Item 4.2.3 "Input amplifier gain".

| Input amplifier gain | X1 | X10 | X100 | X10000 |
|-----------------------------|-------|---|------|--------|
| Response | Slow |  | | Fast |
| Input resistance deviations | Large |  | | Small |
| Noise resistance | Good |  | | Bad |

CAUTION

Error due to input resistance

In Figure 3-12, the error is produced because the voltage to be applied to the sample varies due to the voltage drop " $V_{IN} = R_{IN} \times I_{IN}$ " according to the input resistance. When the input amplifier gain is set to "x 1", the input voltage drop reaches up to 3.6V for full scale. Therefore, the V_s should be set to a value much larger than the above value. Table 3-4 shows the input resistance value when varying the input amplifier gain and the input voltage drop for full scale. Apply the voltage much larger than the above to a sample.

Table 3 - 4 Input Resistance and Input Voltage Drop for Full Scale

| Input amplifier gain | × 1 | | × 10 | | × 100 | | × 10000 | |
|----------------------|------------------|-------------------|------------------|-------------------|------------------|-------------------|------------------|-------------------|
| | Input resistance | F. S voltage drop | Input resistance | F. S voltage drop | Input resistance | F. S voltage drop | Input resistance | F. S voltage drop |
| Current range | | | | | | | | |
| 200pA | 10GΩ | 2V | 1GΩ | 200mV | 100MΩ | 20mV | 10KΩ or more | 500μV |
| 2nA | 1GΩ | 2V | 100MΩ | 200mV | 10MΩ | 20mV | 1KΩ or more | 500μV |
| 20nA | 100MΩ | 2V | 10MΩ | 200mV | 1MΩ | 20mV | 100Ω or more | 500μV |
| 200nA | 10MΩ | 2V | 1MΩ | 200mV | 100kΩ | 20mV | 11Ω or more | 500μV |
| 2μA | 1MΩ | 2V | 100kΩ | 200mV | 10kΩ | 20mV | 2Ω or more | 500μV |
| 20μA | 100kΩ | 2V | 10kΩ | 200mV | 1kΩ | 20mV | 1Ω or more | 500μV |
| 200μA | 10kΩ | 2V | 1kΩ | 200mV | 100Ω | 20mV | 1Ω or more | 700μV |
| 2mA | 1.1kΩ | 2.2V | 110Ω | 220mV | 11Ω | 22mV | 1Ω or more | 2.5mV |
| 20mA | 180Ω | 3.6V | 18Ω | 360mV | 3Ω | 60mV | 1Ω or more | 20mV |

3.3.6 Current Limiter (Current Compliance)

Table 3-5 shows the V SOURCE current limiter according to the set voltage and current compliance setting.

Table 3 - 5 Output Voltage and Current Limiter

| Output Voltage | Current Compliance Setting | | |
|------------------|----------------------------|---------|--------|
| | 300mA | 100mA | 10mA |
| 0.000V to 30.00V | ± 300mA | ± 100mA | ± 10mA |
| 30.03V to 100.00 | ± 100mA | ± 100mA | ± 10mA |
| 100.3V to 1000.0 | ± 10mA | ± 10mA | ± 10mA |

The V SOURCE realizes source and sink of current, which is convenient for charge and discharge like capacitor leak current measurement.

In addition, because the current limit value (compliance) can be selected, the sample limited in rush current such as a chemical capacitor can safely be charged and or discharged. In this case, an advantage lies in the fact that the charge/discharge speed increases compared with the existing speed of charge and discharge through resistance.

For example, the following shows the cases in which a 22μF 100mAMAX capacitor is charged up to 100V, 99% by passing through resistance and using compliance.

- ① When passing through resistance

$$t = 4.6\tau = 4.6CR = 4.6 \times 22\mu \times \frac{100V}{100mA} = 100ms$$

- ② When using compliance

$$t = CV/I = (22\mu \times 99V)/100mA = 22ms$$

From the above, it is found that the time can be saved when using compliance.

The discharge speed also increases.

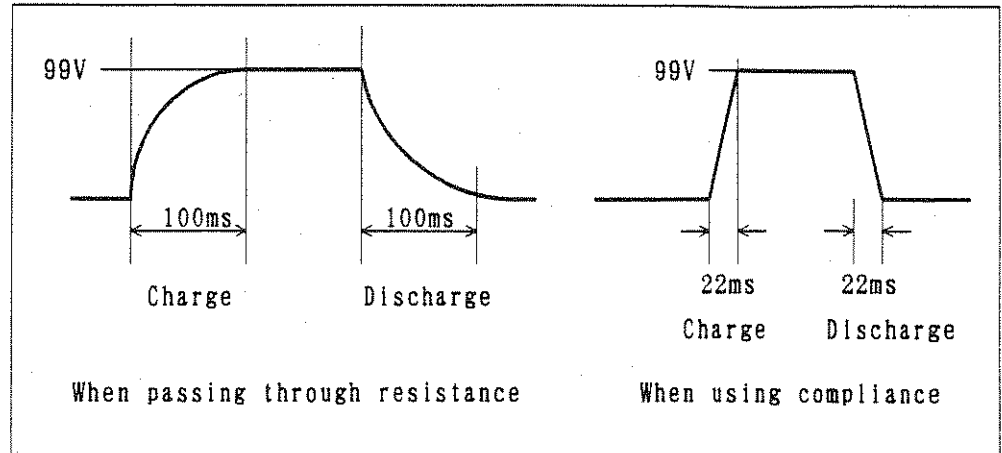

Figure 3 - 14 Charge and Discharge Speed

For how to set current limiter, see Item 4.2.4 "Current limiter" (Current compliance).

CAUTION

The current compliance value is automatically selected according to the output voltage of V SOURCE as shown in Table 3-5. When the current limiter is set to 300mA, for example, the compliance current is kept at 300mA for the voltage between 0 and 30.00V. However, the current automatically changes to 100mA for the voltage between 30.03 and 100.00V and to 10mA for the voltage between 100.3 and 1000.0V internally.

3.3.7 Auto Range Up/Down Level

The auto range is used to automatically go to an adjacent range to measure its value when the measure value in a range is too small or too large. (If a measured value is outside the range, measurement moves on to the next range. Measured values are not displayed during range switching.)

The "count value" is used to make this assessment. The count value is an integer made by eliminating the decimal point and the exponent from the display values.

Example) Displayed value : 1.3142×10^{-8} Count value : 13142

The auto range up/down level selects one of the three levels used to assess a value for a given range to handle.

Table 3 - 6 Setting Range and Count Values

| Setting level | 20000 (default) | 2000 | 200 | Remarks |
|--|--------------------|--------------|-------------|---------------|
| Range up count value | 20000 or more | 2000 or more | 200 or more | Not displayed |
| Count value that can be processed by the set range | 19999 to 1800 | 1999 to 180 | 199 to 18 | |
| Range down count value | 1799 or less | 179 or less | 17 or less | Not displayed |

Note : This assessment is based on the measured current value even in resistance display mode. Thus the above values are not applicable during the resistance indication (Since the resistance value is calculated and displayed by dividing the applied voltage with the current.)

Depending on which level is set, the range where the measurement is made may differ even when the measured current is the same during an auto range measurement. (See table below.)
 When the level is lowered, the number of digits used to express the measurement is reduced while the input resistance is also reduced as the next higher range is used.

Table 3-7 Status Fluctuations Due to Level Selection While Measuring 13.142nA (when the input resistance is GAINXI)

| Level setting | Displayed measurement | Measurement range | Count value | Input resistance |
|---------------|-----------------------|-------------------|-------------|------------------|
| 20000 | 13.142nA | 20nA | 13142 | 100MΩ |
| 2000 | 13.14nA | 200nA | 1314 | 10MΩ |
| 200 | 13.1nA | 2 μA | 131 | 1MΩ |

As described in Item 3.3.5 "Input amplifier gain", the measurement speed is determined by the capacitance and input resistance of the sample to be measured. Therefore, the speed increases as the input resistance decreases.

When attempting to obtain the same number of measurement digits by decreasing the input resistance, the input amplifier gain increases to be weak in noises. Therefore, the function is effective to increase the measurement speed though large number of measurement digits is not needed.

For auto range, it takes time for ranging because of each sense resistance and sample capacitance if the range is too wide. In this case, the speed can be increased through ranging with a small sense resistance by decreasing the ranging level. For example, when measurement current changes from 10nA to 100pA in the auto range:

- ① For auto range up/down level of 20000
 Because the measured value changes from 10.000nA to 100.00pA, the input resistance changes from 100M Ω to 1G Ω .
- ② For auto range up/down level of 2000
 Because the measured value changes from 10.00nA to 100.0pA, the input resistance changes from 10M Ω to 1G Ω .

As above mentioned, the response is accelerated up to 10 times by making measurement with the 1/10 input resistance.
 For how to set auto range up/down level, see Item 4.2.5 "Auto range up/down level".

3.3.8 Contact Checking

Make sure that the sample is properly connected to the terminals when measuring the insulation resistance of capacitive samples (capacitors or the like). This can easily be done by performing a contact check.

The contact checking function judges the contact state of a sample by measuring the sample capacitance as shown in Fig. 3-15.

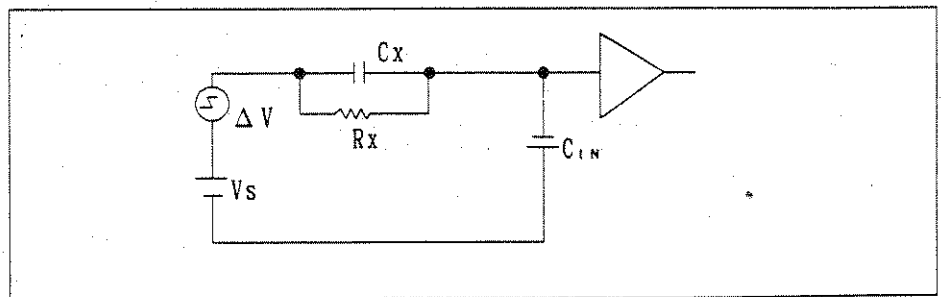

Figure 3 - 15 Contact Checking

C_{IN} is a standard built-in capacitor. Step voltage ΔV is applied to the V SOURCE output. The C_x value is derived from the difference between the voltages at both terminals of C_{IN} before and after the voltage is applied. The C_x value is evaluated by comparing it with the value measured at "contact initialization".
 The level to be compared is the C_{IN1} value measured at initialization multiplied by coefficient n set for contact level.

Connect a standard capacitor and perform contact initialization. Although a comparison is made with this value during the contact check, the capacity of the measurement cables and the jigs may cause errors. For this reason, a contact initial offset measurement should be made first.

The contact check is successful if $C_x \geq n \times (C_{INI} - C_{IO}) + C_{IO}$.

The contact check failed if $C_x < n \times (C_{INI} - C_{IO}) + C_{IO}$.

Here, C_x : Value measured at the time of a contact check
 C_{INI} : Value measured at the time of a contact initialization
 C_{IO} : Value measured at the time of a contact initialization offset
 n : Contact level

Perform the contact check as described below.

- ① Set the integral time of contact initialization and the contact level
- ② Specify that V SOURCE is to be used as the voltage source.
- ③ Connect a jig only and set it to charge status.
- ④ Set the instrument to operate on status and measure the initial contact offset value.
- ⑤ Set the instrument to operate off status and connect a standard capacitor (sample).
- ⑥ Set the instrument to operate on and perform contact initialization.
- ⑦ Connect the sample to be evaluated and perform a contact check.

Procedures ① to ⑥ are used to determine the level of contact evaluation. This value will remain in memory even after a power down.

The internal data can be read when the "CNX?", "CI1?" or "CI2?" GPIB commands are used to perform the contact check and the contact initialization. The "CNX?" command outputs the C_x value and the "CI1?" and "CI2?" commands output the $n \times (C_{INI} - C_{IO}) + C_{IO}$ value.

CAUTION

1. The integral time of the contact check is determined when a contact initialization or contact initialization offset measurement is executed. The integral time of CNT? and CNX? after executing the CI2, CI2? and CO2 commands is 1PLC.
2. Contact initialization and contact initialization offset should be performed according to the same conditions (regarding generating voltage, jig, and cable) as the contact check.
3. A low insulation resistance in a jig or sample used in a contact initialization offset, contact initialization or contact check causes a large measurement error. If the resistance exceeds the range specified in table 3-7, measurements cannot be performed.
4. The response data of the "CNX?", "CI1?" or "CI2?" GPIB commands are internal measurement data whose accuracy is not guaranteed.

The V SOURCE step voltage for contact checking is automatically determined by the contact-checking judgment level and the V SOURCE generated voltage internally as shown in Table 3-8.

Select the sample and contact factor for contact initialization so that the contact-checking judgment level will be kept at the following range.

When V_s ranges between 0 and 100.00V → $0 \leq C_{INI} \times n \leq$ approx. 10nF

When V_s ranges between 100.3 and 1000.0V

→ $0 \leq C_{INI} \times n \leq$ approx. 3nF

(When the level is out of the above range, an error occurs.)

Table 3 - 8 Contact Checking Judgment Level Range and Step Voltage

| Generated voltage | Judgment level (C _{INI} × n) | | | |
|-------------------|---------------------------------------|-------------------------------|------------------------------|-----------------------------|
| | 0 to approx. 90pF | approx. 90pF to approx. 900pF | approx. 900pF to approx. 3nF | approx. 3nF to approx. 10nF |
| 0V to 10.000V | approx. 1V | approx. 100mV | approx. 10mV | approx. 10mV |
| 10.03V to 100.00V | approx. 1V | approx. 100mV | approx. 100mV | approx. 100mV |
| 100.3V to 1000.0V | approx. 1V | approx. 1V | approx. 1V | Impossible |

For sample with no capacitance component or the capacitance of 0.5pF or less, judgment cannot be made. For the sample with the component "L" or when a large resistance is connected with the C_i in series, judgment may be erroneously made.

- (1) The contact checking method.

Operation(① through ③)

[Before checking]

- ① Execute contact initialization.
(See Item 4.3.2.)
- ② Set a contact level.
(See Item 4.4.7.)

[Start of checking]

③ Press the ^{CONTACT}  key, and the LED on the key lights.

③-1 Display panel state when contact is judged to be OK.

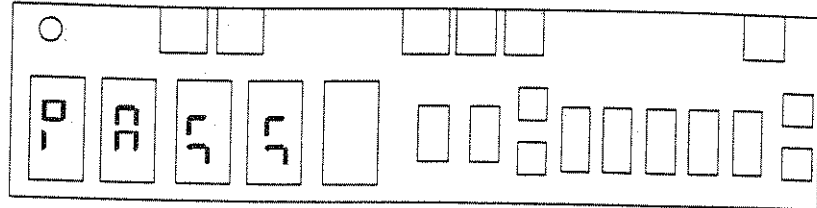

③-2 Display panel state when contact is judged to be NG

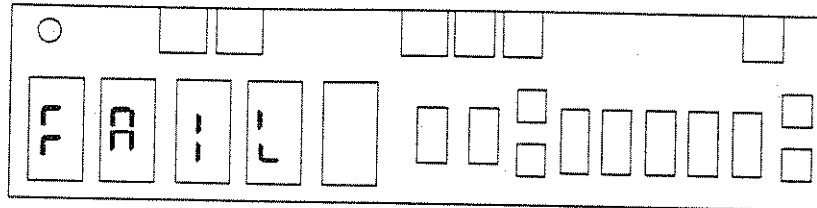

The high-pitched tone buzzer sounds.

③-3 Display panel state when contact cannot be judged

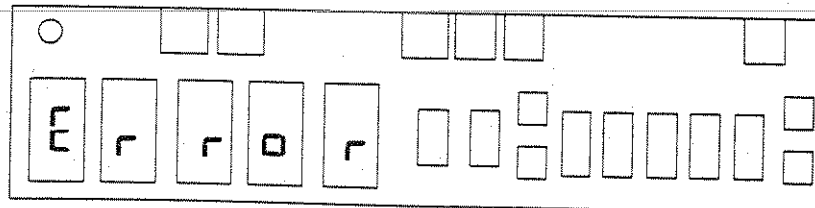

The high-pitched tone buzzer sounds.

Contact checking cannot be made when the standard sample exceeds the measurement range for contact initialization or the set contact level exceeds the judgment range. In the above cases, change the contact level or retry the contact initialization.

(The buzzer sounds only when it is set to ON.)
After judgment on contact is displayed, the contact checking finishes and the panel returns to the normal measurement state. The LED on the key goes out.

(2) Limitations of contact check

The limitations are as follows :

- Check that only the material contacts by performing the contact initial with cable only.

No Limitations

- Compare the test piece contact initial capacity C_{INI} and the test piece capacity C_x in the contact check by connecting jigs to the test piece.

The insulation resistances of the test piece and jig have the following limitations :

① $I_x = \frac{V_s}{R_x}$ shall be within the range as shown in Table 3-9.

V_s = Input voltage

R_x = Insulation resistances of jig and test piece

② R_x shall be more than the value shown in Table 3-9.

Table 3-9 The Range Where Comparison of Contact Initial and Contact Check is Available

| Integral time of Contact Initial | C_x, C_{IN} | V_s | | | |
|----------------------------------|-------------------|-----------------|------------------|------------------|------------------|
| | | 0 to 1.000V | 1.000 to 10.000V | 10.03 to 100.00V | 100.3 to 1000.0V |
| 2ms | 0 to 100pF | More than 150MΩ | Less than 15nA | Less than 8nA | Less than 8nA |
| | 100 to 1000pF | | Less than 10nA | | Less than 80nA |
| | 1000 to 3000pF | More than 100MΩ | | Less than 100nA | Less than 8nA |
| | 3000 to 10000pF | | | Less than 80nA | — |
| | More than 10000pF | — | — | — | — |
| 1PLC | 0 to 100pF | More than 50MΩ | Less than 25nA | Less than 25nA | Less than 10nA |
| | 100 to 1000pF | | | | Less than 25nA |
| | 1000 to 3000pF | | | | Less than 10nA |
| | 3000 to 10000pF | | | | — |
| | More than 10000pF | — | — | — | — |

The symbol "-" indicates that the contact initial is impossible.

<Example> When the integral time of contact initialization is 2ms at $V_s=50V$, the following insulation resistance is required when a 200pF contact check evaluation (in which the result is compared with the result of the 100pF check) is performed after a 100pF contact initialization.

$$R_x > 50V/8nA=6250M\Omega$$

(3) Noise in contact check or contact initial stage

2ms or 1PLC can be selective for the contact initial integral time of the AD converter when the contact occurs. The integral time in the contact check is determined by the contact initial integral time. While 2ms is usually set, it will be converted to 1PLC when the measurement is unstable due to noises. See "4.4.10" contact initial integral time" for this conversion. When you reset the integral time, carry out the contact initial again.

(4) Data output in contact check or contact initial

When the GPIB command "CI1?", "CI?" or "CNX?" is executed, the data of the contact check and contact initial. By processing these data with the external computer, upper and lower limits of the test piece capacity dispersion can be obtained. The data are output in [pF]. Since the accuracy of the data's absolute value is not guaranteed, use them as relative value.

3.3.9 Trigger Delay

Using this function, delay the time from when the trigger operation (internal trigger, trigger key, trigger command or external trigger signal) is completed to when the sampling starts.

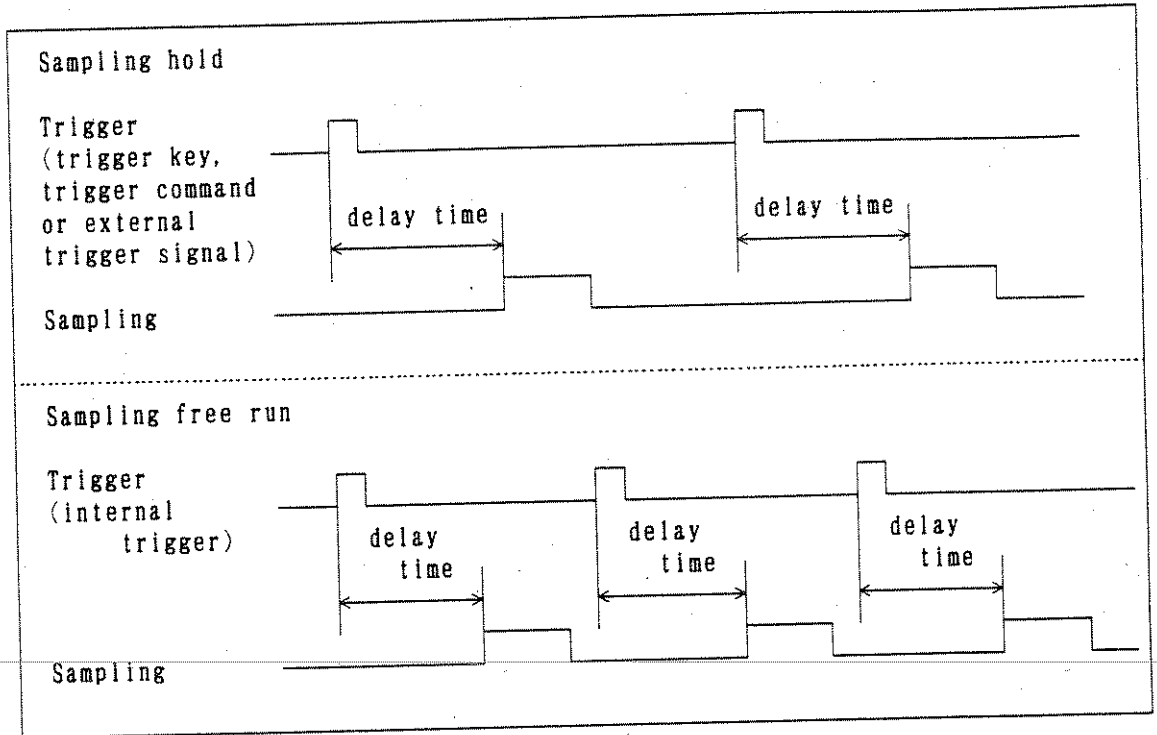

Figure 3 - 16 Trigger Delay

This function is used in the following measurement:

- Device measurement waiting for setting the setting time.
- Measurement of condenser I-t characteristic or R-t characteristic.
- Measurement of long-time insulation resistance characteristic using data memory function.

3.3.10 Autorange Delay

Using this function, the delay time, from when the measurement range is reset by the autorange operation mode to when the subsequent sampling starts, is set.

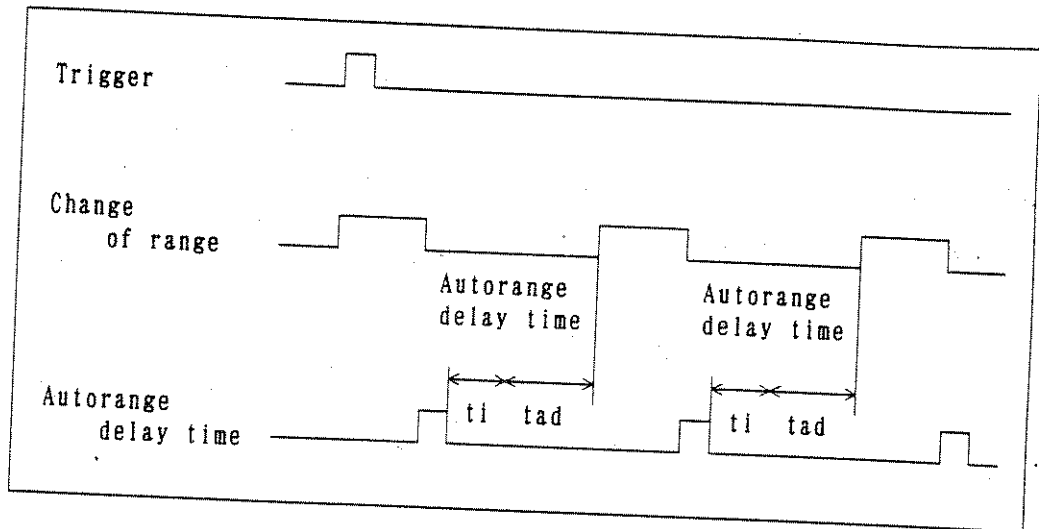

Figure 3 - 17 Autorange Delay

The autorange delay time is set based on the 200pA range, a standard, and the actual delay time in each range is as follows :

for $tad/5^n \leq t_i$ $t = t_i + 10ms$
 for $tad/5^n > t_i$ $t = tad/5^n + 10ms$
 ($tad \cdot 5^n \geq 1ms$)

- t_i : Internal setting time
- tad : Autorange delay setting time
- n : Range number (see Table 3-10)

Table 3 - 10 Delay Time in Each Range when Setting Autorange Delay

| n | Current range after reset | Autorange delay time | Internal setting time t_i | Example of Actual delay time t (Integration time 2ms) | | |
|---|---------------------------|----------------------|-----------------------------|--|--------|-----------|
| | | | | tad=1ms | tad=1s | tad=9999s |
| 0 | 200pA | Sat value tad | 350ms | 380ms | 1030ms | 9999030ms |
| 1 | 2nA | tad/5 | 25ms | 55ms | 230ms | 1999830ms |
| 2 | 20nA | tad/5 ² | 5ms | 35ms | 70ms | 399990ms |
| 3 | 200nA | tad/5 ³ | 5ms | 35ms | 38ms | 80022ms |
| 4 | 2 μ A | tad/5 ⁴ | 2ms | 32ms | 32ms | 16028ms |
| 5 | 20 μ A | tad/5 ⁵ | 2ms | 32ms | 32ms | 3230ms |
| 6 | 200 μ A | tad/5 ⁶ | 2ms | 32ms | 32ms | 670ms |
| 7 | 2mA | tad/5 ⁷ | 2ms | 32ms | 32ms | 158ms |
| 8 | 20mA | tad/5 ⁸ | 2ms | 32ms | 32ms | 56ms |

This function is used in the following conditions :

- When an error occurs in the measurement since the internal settling time cannot provide a sufficient setting time after changing over the range at measurement of condenser in the autorange mode.
- When correct measurement data is obtained despite repeating the change-over the range.

When the range is changed over just before the final measurement after passing the charge time and measure time set in the measurement using the sequence program, the error may occur in the measurement data.

Set the autorange delay time to approx. quarter of the charge time in programs 0 through 4. Set it to approx. half of measured time in program 5.

4. DESCRIPTION OF PARAMETER KEYS

This section describes parameters keys.

4.1 Basic Usage of Parameter Keys

Parameter keys have several functions respectively. Each key changes various settings and executes functions. Functions depend on the normal measurement mode, sequence program mode, and calibration mode.

The following describes parameter keys under the normal measurement mode.

For the sequence program mode, see Section 5.3 "Program Parameter setting". For the calibration mode, see Section 9.2 "Calibration". Table 4-1 shows various parameter keys.

Table 4 - 1 Parameter Keys

| | | |
|------------------------------------|--|--|
| Parameter keys | MEAS <input type="checkbox"/> CAL <input type="checkbox"/> COEF <input type="checkbox"/> I/O <input type="checkbox"/> MEM <input type="checkbox"/> | Used to change various settings and execute functions. |
| Parameter setting change key | CHANGE <input type="checkbox"/> | Used to change over predetermined setting. |
| Parameter setting registration key | EXIT <input type="checkbox"/> | Used to exit from the setting mode after registration. |

See Table 4-2 "Parameter Key Functions" and Figure 4-1 "Basic Usage of Parameter Keys".

Operation (① through ④)

- ① Press a parameter key under the normal measurement mode.
- ② The present set state of the specified parameter is displayed according to the pressed parameter key and the number of pressing times. (See Table 4-2.)
- ③ Setting change includes the following three methods.
 - Select an item among the predetermined settings with the ^{CHANGE} .
 - Input optional value using the keys to , , ₀ ₉ ₊/₋.
 - Make setting using the above two methods.
- ④ Resetting after changing to a required setting
Register a new setting to complete the setting. Resetting includes the following two methods.
 - When the ^{EXIT} is pressed, a new setting is registered and the state exits from the setting mode to return to the normal measurement mode.

- When the parameter key pressed in the above Item ② is pressed again, a new setting is registered and the state moves to the next setting mode.

Table 4 - 2 Parameter Key Functions

| 1. Parameter key : <input type="checkbox"/> ^{MEAS} | | |
|--|---|---|
| Setting contents | Operation 1 | Operation 2 |
| ① Setting of integration time | Press the <input type="checkbox"/> ^{MEAS} once. | INTEG → 2ms → 1PLC → 5PLC → 10PLC → 10PLC×4 → 10PLC×8 → 10PLC×16 } Change them with the CHANGE <input type="checkbox"/> for selection. |
| ② Setting of AD CAL | Press the <input type="checkbox"/> ^{MEAS} twice. | AD CAL → ON → OFF } Change them with the CHANGE <input type="checkbox"/> for selection. |
| ③ Setting of input amplifier gain | Press the <input type="checkbox"/> ^{MEAS} three times. | GAIN → ×1 → ×10 → ×100 → ×10000 } Change them with the CHANGE <input type="checkbox"/> for selection. |
| ④ Setting of output-voltage current limiter | Press the <input type="checkbox"/> ^{MEAS} four times. | LIMIT → 300mA → 100mA → 10mA } Change them with the CHANGE <input type="checkbox"/> for selection. |
| ⑤ Setting of autorange up/down level | Press the <input type="checkbox"/> ^{MEAS} five times. | A. R. LVL → 20000 → 2000 → 200 } Change them with the CHANGE <input type="checkbox"/> for selection. |
| ⑥ Setting of unit indication | Press the <input type="checkbox"/> ^{MEAS} six times. | UNIT → Symble → Exponent } Change them with the CHANGE <input type="checkbox"/> for selection. |
| ⑦ Setting of trigger delay time | Press the <input type="checkbox"/> ^{MEAS} seven times. | DELAY T data — Input data with numeric keys. |
| ⑧ Setting of autorange delay time | Press the <input type="checkbox"/> ^{MEAS} eight times. | A. R. DLYT data — Input data with numeric keys. |
| ⑨ Press the <input type="checkbox"/> ^{MEAS} nine times, and the state returns to ①. | | |

Table 4 - 2 Parameter Key Functions (Cont'd)

| 2. Parameter : <input type="checkbox"/> ^{CAL} | | | |
|---|--|---|---|
| Setting contents | Operation 1 | Operation 2 | |
| ① Execute zero cancel. | Press the <input type="checkbox"/> ^{CAL} once. | ZC <input type="checkbox"/> OFF <input type="checkbox"/> Execution } CHANGE <input type="checkbox"/> for execution. | |
| ② Execute contact initialization offset measurement. | Press the <input type="checkbox"/> ^{CAL} twice. | C-inoF <input type="checkbox"/> OFF <input type="checkbox"/> Execution } CHANGE <input type="checkbox"/> for execution. | |
| ③ Execute contact initialization. | Press the <input type="checkbox"/> ^{CAL} three. | C-INIT <input type="checkbox"/> OFF <input type="checkbox"/> Execution } CHANGE <input type="checkbox"/> for execution. | |
| ④ Execute self-test. | Press the <input type="checkbox"/> ^{CAL} four times. | TEST <input type="checkbox"/> OFF <input type="checkbox"/> Execution } CHANGE <input type="checkbox"/> for execution. | |
| ⑤ Press the <input type="checkbox"/> ^{CAL} five times, and the state returns to ①. | | | |
| 3. Parameter : <input type="checkbox"/> ^{I/O} | | | |
| Setting contents | Operation 1 | Operation 2 | |
| F o r R 8 3 4 0 | ① Setting of GPIB address | Press the <input type="checkbox"/> ^{I/O} once. | GPIB <input type="checkbox"/> A-XX(data) <input type="checkbox"/> HA-XX(data) <input type="checkbox"/> 0- <input type="checkbox"/> HO- } CHANGE <input type="checkbox"/> for selection. |
| | ② Setting of power frequency | Press the <input type="checkbox"/> ^{I/O} twice. | LINE F <input type="checkbox"/> 50Hz <input type="checkbox"/> 60Hz } CHANGE <input type="checkbox"/> for selection. |
| | ③ Press the <input type="checkbox"/> ^{I/O} three times, and the state returns to ①. | | |
| F o r R 8 3 4 0 A | ① Setting of DA OUTPUT | Press the <input type="checkbox"/> ^{I/O} once. | DA <input type="checkbox"/> OFF <input type="checkbox"/> AAA99 <input type="checkbox"/> 1AAA9 <input type="checkbox"/> 19AAA <input type="checkbox"/> 199AA <input type="checkbox"/> BBB99 <input type="checkbox"/> 1BBB9 <input type="checkbox"/> 19BBB <input type="checkbox"/> 199BB } CHANGE <input type="checkbox"/> for selection. |

Table 4 - 2 Parameter Key Functions (Cont'd)

| Setting contents | Operation 1 | Operation 2 | |
|---|--|---|---|
| F o r R 8 3 4 0 A | ② Setting of BCD OUTPUT | Press the $\overset{I/O}{\square}$ twice. | BCD <ul style="list-style-type: none"> → OFF → BCD → BIN Change them with the $\overset{\text{CHANGE}}{\square}$ for selection. |
| | ③ Setting of GPIB address | Press the $\overset{I/O}{\square}$ three times. | GPIB <ul style="list-style-type: none"> → A-XX (data) → HA-XX (data) → 0- → HO- Change them with the $\overset{\text{CHANGE}}{\square}$ for selection. |
| | ④ Setting of power frequency | Press the $\overset{I/O}{\square}$ four times. | LINE F <ul style="list-style-type: none"> → 50Hz → 60Hz Change them with the $\overset{\text{CHANGE}}{\square}$ for selection. |
| | ⑤ Press the $\overset{I/O}{\square}$ five times, and the state returns to ①. | | |
| 4. Parameter key : $\overset{\text{COEF}}{\square}$ | | | |
| Setting contents | Operation 1 | Operation 2 | |
| ① Selection of COMPARE upper level | Press the $\overset{\text{COEF}}{\square}$ once. | UPPER polarity + data + unit — Change them with the $\overset{\text{CHANGE}}{\square}$ for selection. | |
| ② Setting of COMPARE lower level | Press the $\overset{\text{COEF}}{\square}$ twice. | LOWER polarity + data + unit — Change them with the $\overset{\text{CHANGE}}{\square}$ for selection. | |
| ③ Setting of resistance measurement indication | Press the $\overset{\text{COEF}}{\square}$ three times. | RM <ul style="list-style-type: none"> → NORMAL → VOLUME → SURFACE Change them with the $\overset{\text{CHANGE}}{\square}$ for selection. | |
| ④ Setting of electrode for volume and surface resistivities | Press the $\overset{\text{COEF}}{\square}$ four times. | E. DIM <ul style="list-style-type: none"> → ϕ 50 (JIS) → ϕ 70 (JIS) → Optional dimension Change them with the $\overset{\text{CHANGE}}{\square}$ for selection. | |

Table 4 - 2 Parameter Key Functions (Cont'd)

| Setting contents | Operation 1 | Operation 2 |
|---|--|---|
| ⑤ Setting of optional electrode coefficient | Press the ^{COEF} <input type="checkbox"/> five times. | V. COEF/S. COEF } Change them with the ^{CHANGE} <input type="checkbox"/> for selection. <input type="checkbox"/> Volume resistivity <input type="checkbox"/> Surface resistivity + data — Input data with numeric keys. |
| ⑥ Setting of sample thickness for measurement of volume resistivity | Press the ^{COEF} <input type="checkbox"/> six times. | SAMPL t data — Input data with numeric keys. |
| ⑦ Selection of contact level | Press the ^{COEF} <input type="checkbox"/> seven times. | CONTACT <input type="checkbox"/> ×10 <input type="checkbox"/> ×5 <input type="checkbox"/> ×2 <input type="checkbox"/> ×1 <input type="checkbox"/> ×0.5 <input type="checkbox"/> ×0.2 <input type="checkbox"/> ×0.1 } Change them with the ^{CHANGE} <input type="checkbox"/> for selection. |
| ⑧ Setting of buzzer | Press the ^{COEF} <input type="checkbox"/> eight times. | BZ <input type="checkbox"/> ON <input type="checkbox"/> OFF } Change them with the ^{CHANGE} <input type="checkbox"/> for selection. |
| ⑨ Setting of indication | Press the ^{COEF} <input type="checkbox"/> nine times. | DISP <input type="checkbox"/> ON <input type="checkbox"/> OFF } Change them with the ^{CHANGE} <input type="checkbox"/> for selection. |
| ⑩ Setting of contact initial integration time | Press the ^{COEF} <input type="checkbox"/> ten times. | CNT, IT <input type="checkbox"/> 2ms <input type="checkbox"/> 1PLC } Change them with the ^{CHANGE} <input type="checkbox"/> for selection. |
| ⑪ | Press the ^{COEF} <input type="checkbox"/> eleven times, and the state returns to ①. | |
| 5. Parameter : ^{MEM} <input type="checkbox"/> | | |
| Setting contents | Operation 1 | Operation 2 |
| ① Store measured data. | Press the ^{MEM} <input type="checkbox"/> once | STORE <input type="checkbox"/> OFF <input type="checkbox"/> ON } Change them with the ^{CHANGE} <input type="checkbox"/> for selection. |
| ② Recall the stored measured data. | Press the ^{MEM} <input type="checkbox"/> twice. | RECALL <input type="checkbox"/> OFF <input type="checkbox"/> Recall data No. } Make setting with the ^{CHANGE} <input type="checkbox"/> or numeric keys. |
| ③ | Press the ^{MEM} <input type="checkbox"/> three times, and the state returns to ①. | |

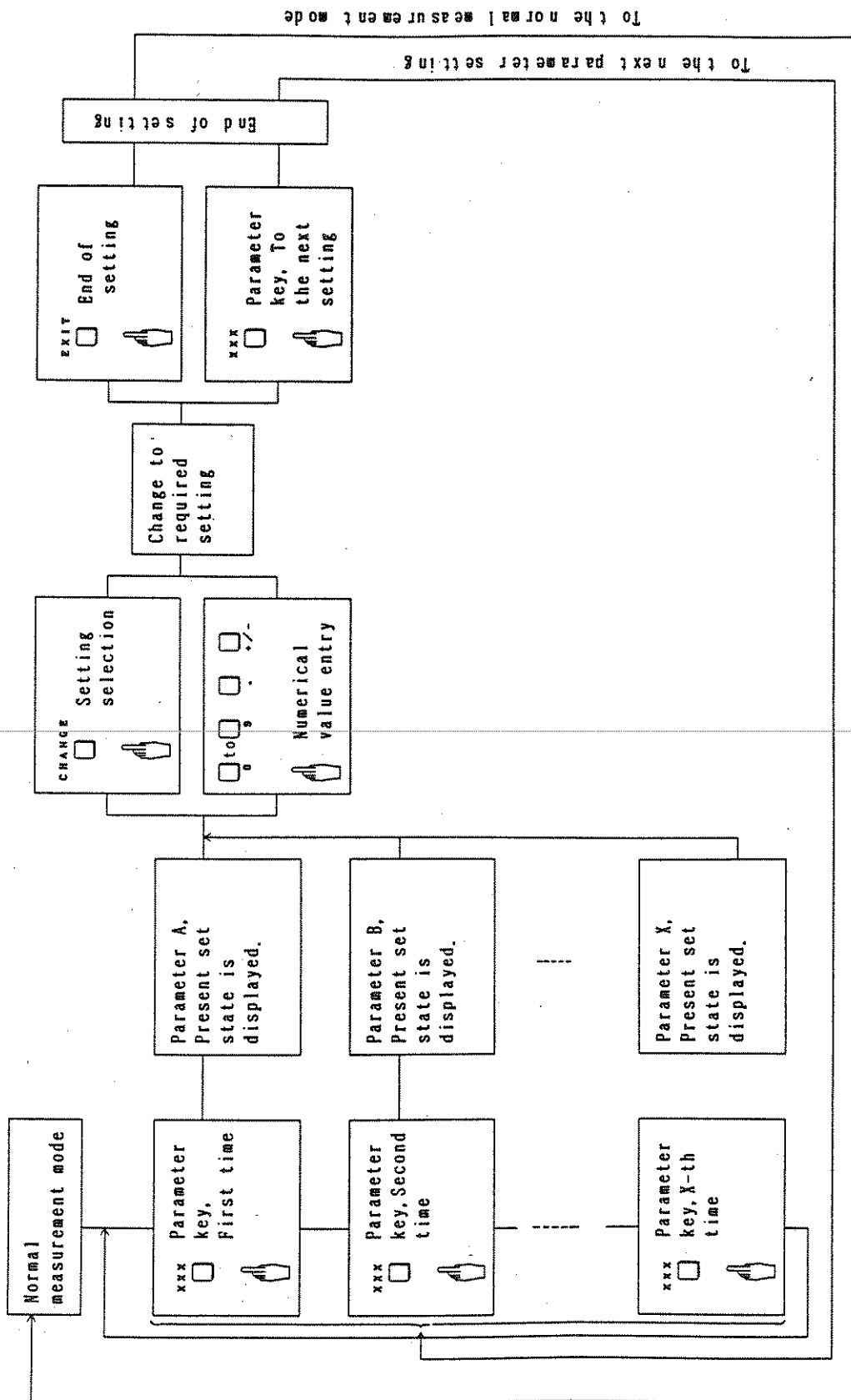

Figure 4 - 1 Basic Usage of Parameter Keys

4.2 Various MEAS-Key Setting Methods

4.2.1 Integral Time

The following describes how to set the input-signal integration time of the A/D converter.

Operation (① through ③)

- ① Press the ^{MEAS} once, and the indication `INTEG` appears.
- ② Press the ^{CHANGE} until the required integration time appears.

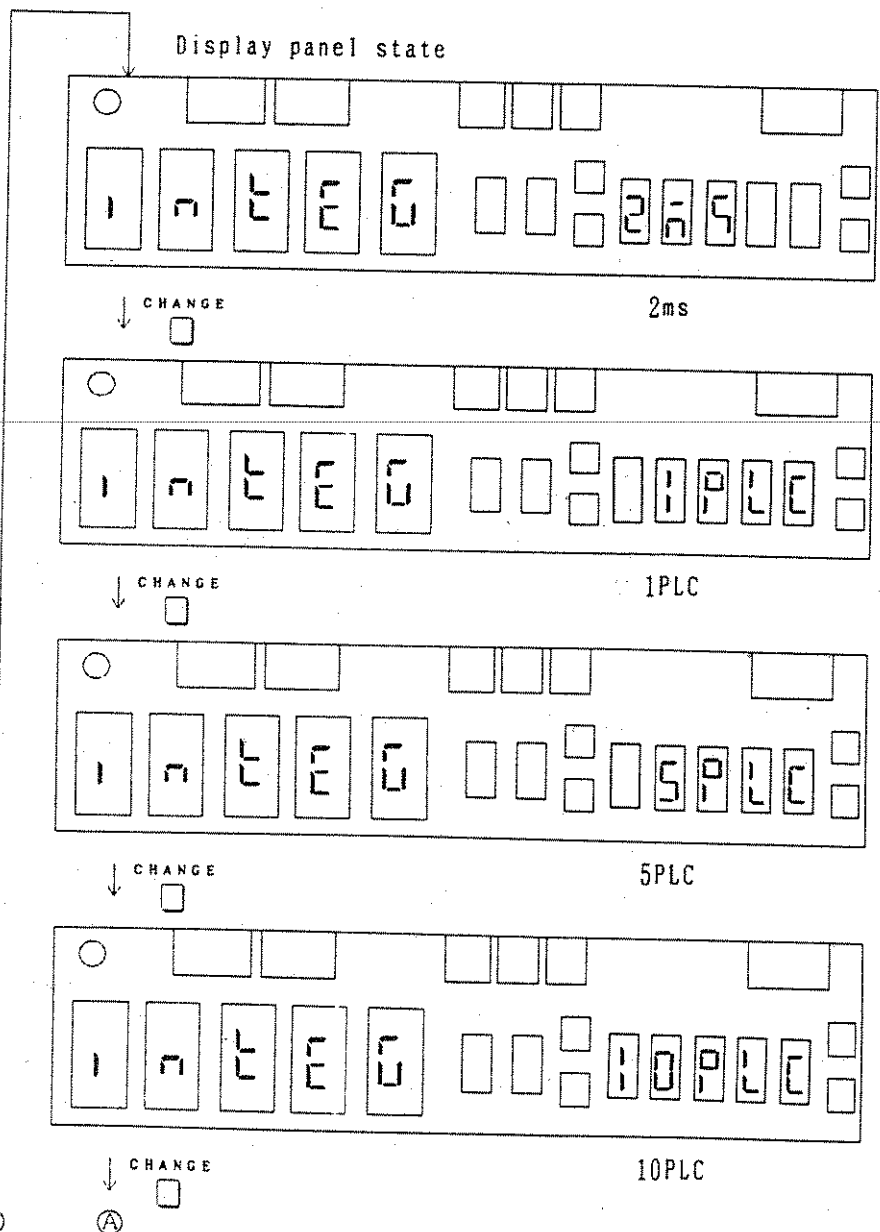

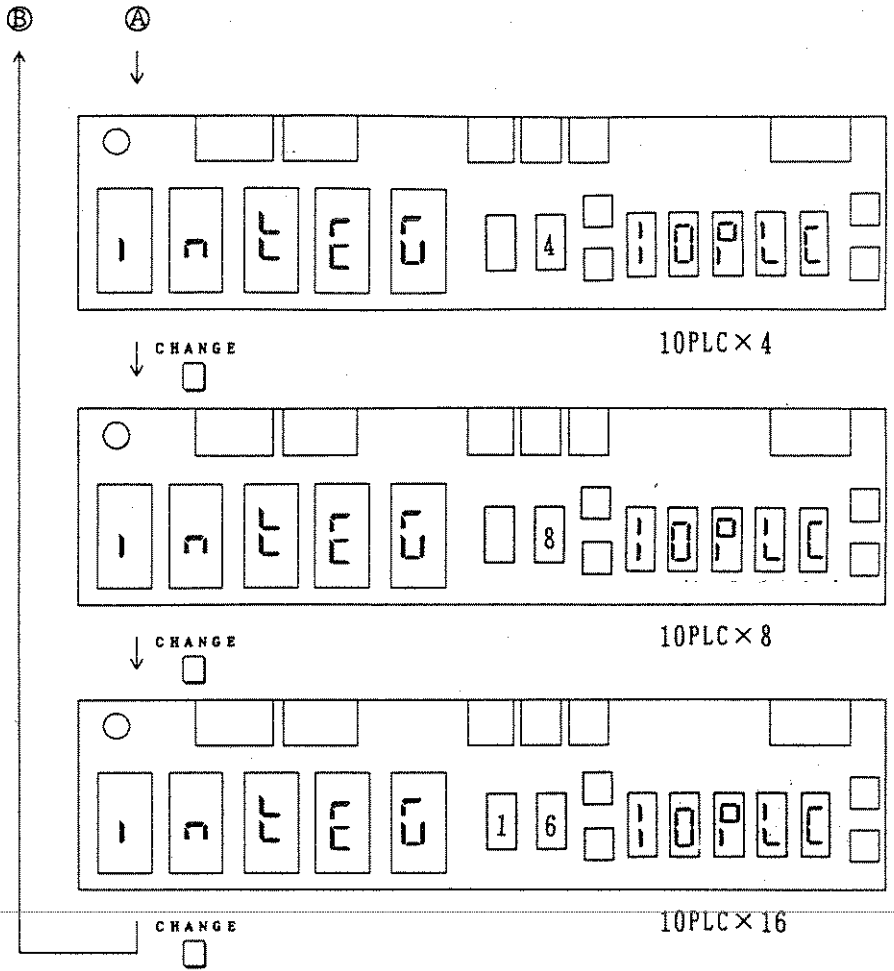

③ When the key is pressed, the setting ends.

4.2.2 AD CAL

The following describes how to set AD CAL to ON or OFF.

Operation (① through ③)

① Press the ^{MEAS} twice, and the indication
A D C A L appears.

② Press the ^{CHANGE} to set ON or OFF. Whenever the ^{CHANGE} is pressed, the setting is changed over.

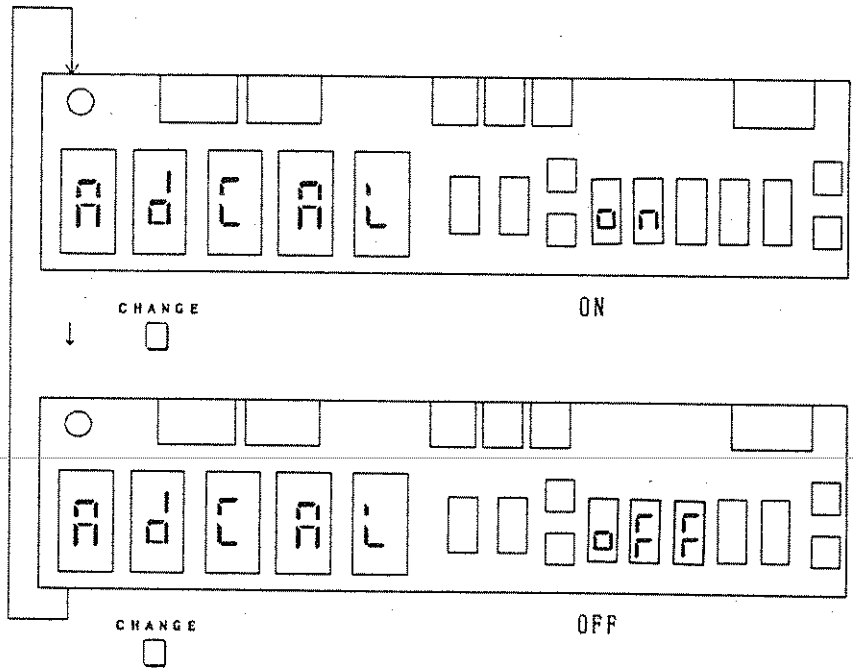

③ When the ^{EXIT} is pressed, the setting ends.

4.2.3 Input Amplifier Gain

The following describes how to set input amplifier gain.

Operation (① through ③)

- ① Press the ^{MEAS} three times, and the indication

G A I N appears.

- ② Press the ^{CHANGE} until the required input amplifier gain appears.

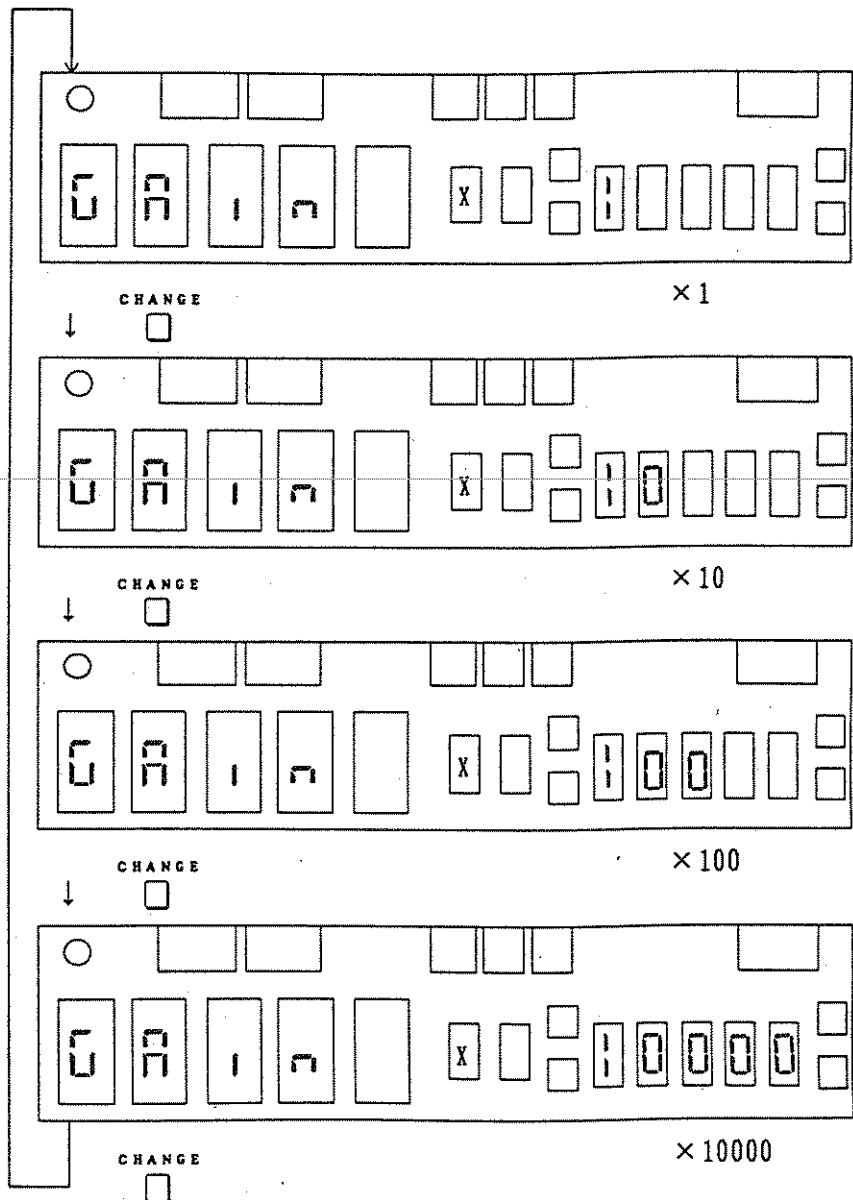

- ③ When the ^{EXIT} is pressed, the setting ends.

4.2.4 Current Limiter (Current Compliance)

The following describes how to set V-SOURCE current limiter.

Operation (① through ③)

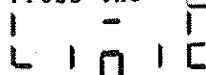
- ① Press the ^{MEAS} four times, and the indication
 appears.

- ② Press the ^{CHANGE} until the required current limiter appears.

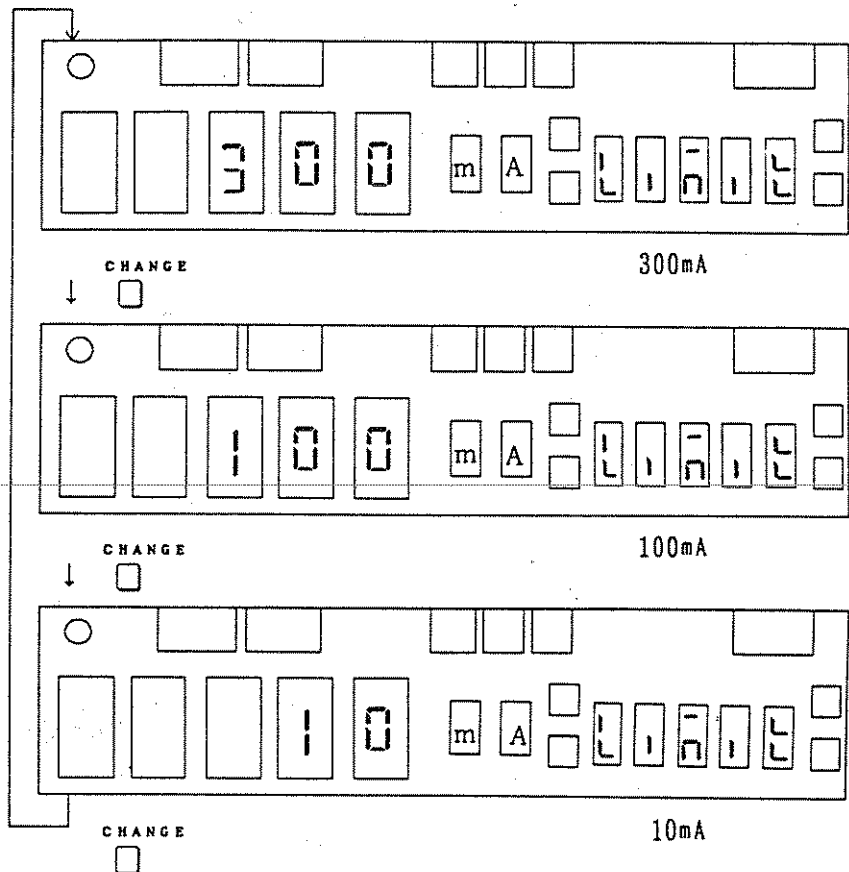

- ③ When the ^{EXIT} is pressed, the setting ends.

4.2.5 Auto Range Up/down Level

The setting realizes quick-response measurement corresponding to the necessary number of digits.

The judgment value includes the following three types.

- (1) : Up 20000 Down 1799
- (2) : Up 2000 Down 179
- (3) : Up 200 Down 17

When "IT=2ms" is set, however, the operation same with that in Item (2) is executed even if the data in Item (1) is set because "1999" is the full scale. For the highest range and manual range, "19999" is the full scale regardless of settings. The following describes how to set auto range up/down level.

Operation (① through ③)

- ① Press the ^{MEAS} five times, and the indication

A . r . L U L appears.

- ② Press the ^{CHANGE} until the required auto range up/down level appears.

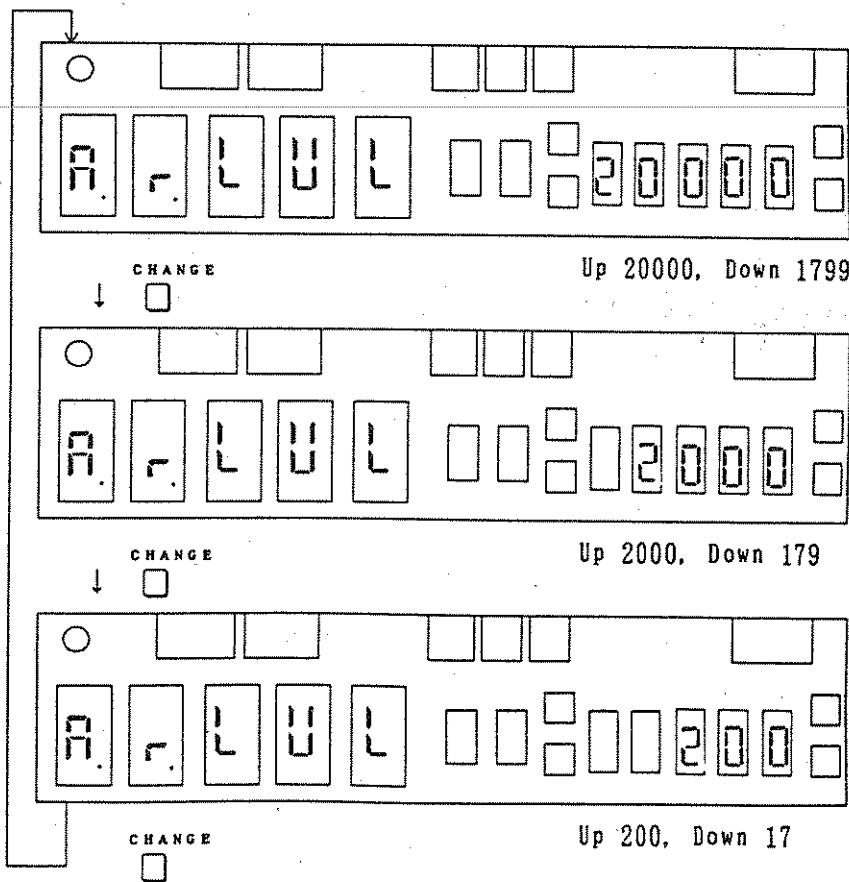

- ③ When the ^{EXIT} is pressed, the setting ends.

4.2.6 Unit Indication

The unit indication includes the exponent and symbol units. The exponent unit indication is used for the measurement of volume and surface resistivities regardless of settings. The following describes how to set the unit indication of measured values.

Operation (① through ③)

① Press the ^{MEAS} six times, and the indication **u n i t** appears.

② Press the ^{CHANGE} to set the symbol or exponent unit. Whenever the ^{CHANGE} is pressed, the setting is changed over.

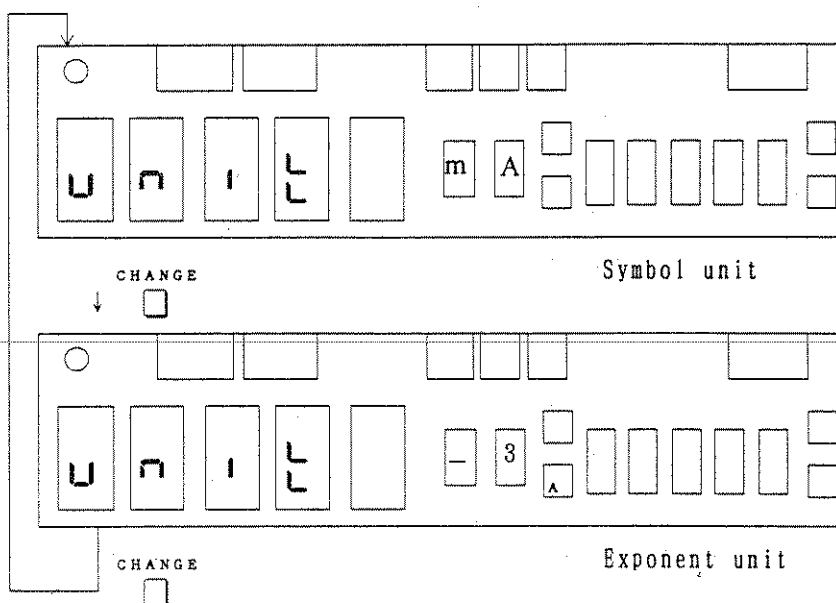

③ When the ^{EXIT} is pressed, the setting ends.

4.2.7 Trigger Delay

The following describes how to set trigger delay time.

Operation (① through ③)

- ① Press the ^{MEAS} seven times, and the indication

DELA Y appears.

- ② Change the present set value to the required set value. To change the setting to "12.345sec", for example:

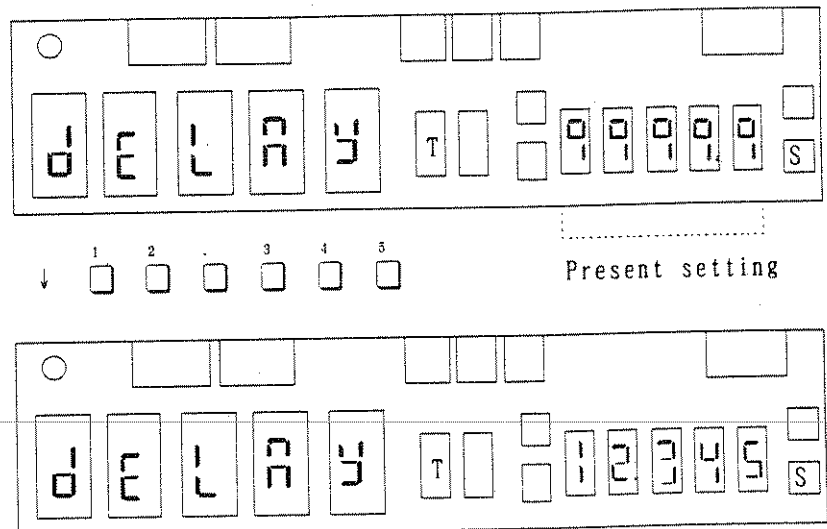

- ③ When the ^{EXIT} is pressed, the setting ends.

CAUTION

- The trigger delay time setting range is 0 to 9999.9 sec. If a value out of the range is set, an input error occurs when the ^{EXIT} is pressed.
- If you input an incorrect value, press the _{CE}. Then the preceding set value appears and you can input a new value.

4.2.8 Autorange Delay

The following describes how to set Autorange delay time.

Operation (① through ③)

- ① Press the ^{MEAS} eight times, and the indication

A r . d L Y appears.

- ② Change the present set value to the required set value. To change the setting to "12.345sec", for example:

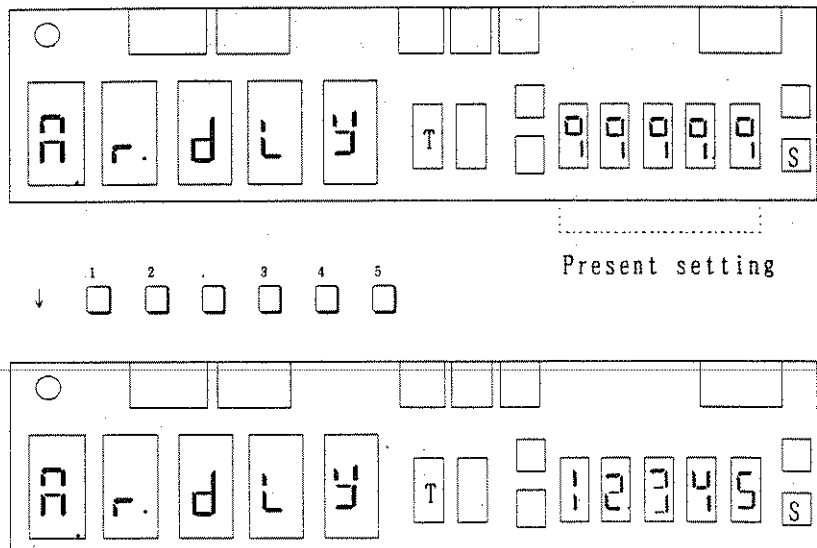

- ③ When the ^{EXIT} is pressed, the setting ends.

CAUTION

1. The autorange delay time setting range is 0 to 9999.9 sec. If a value out of the range is set, an input error occurs when the ^{EXIT} is pressed.
2. If you input an incorrect value, press the _{CE}. Then the preceding set value appears and you can input a new value.

4.3 Various CAL-key Setting Methods

4.3.1 Zero Cancel

When the zero cancel operation is executed, the input amplifier is reset and the input-amplifier offset is canceled. Execute the zero cancel operation when zero is deviated.

The following describes how to execute zero cancel.

Operation (① through ③)

- ① Press the ^{CAL} once, and the indication Z C appears.
- ② Press the ^{CHANGE} for execution.

Display panel state for execution

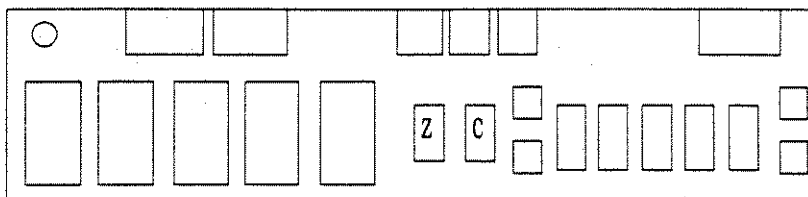

CHANGE

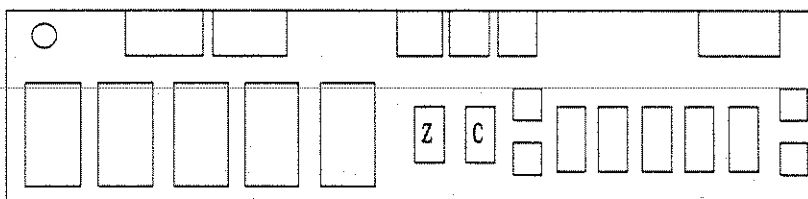

During execution of
zero cancel operation

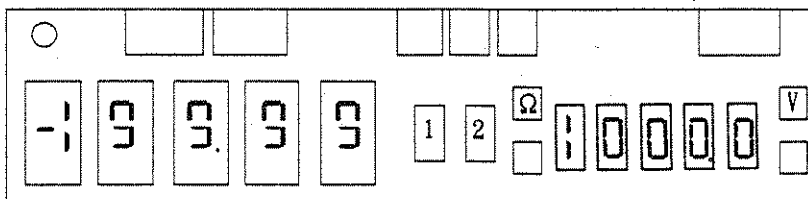

End of zero cancel operation

- ③ When the zero cancel operation ends, the state returns to the normal measurement mode.

4.3.2 Contact Initialization Offset Measurement

The following is a description of contact initialization offset measurement procedures.

Operation (① though ③)

① Press ^{CAL} twice to display "E. i n o f".

② Press ^{CHANGE} to execute the program.

Panel display screens during operation

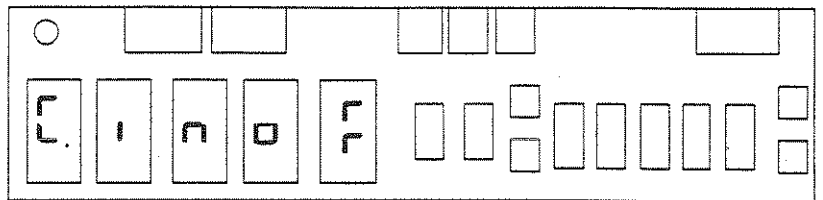

^{CHANGE}
↓

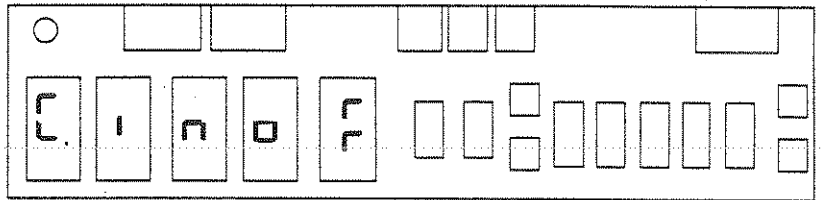

Screens displayed during execution of contact initialization offset measurement

↓

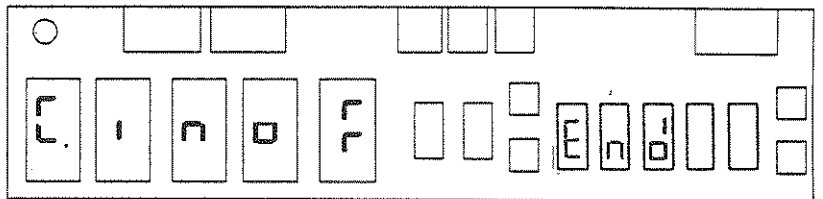

Terminating contact initialization offset measurement

③ Press ^{EXIT} to terminate measurement.

The following screen is displayed when the contact initialization offset measurement ends abnormally.

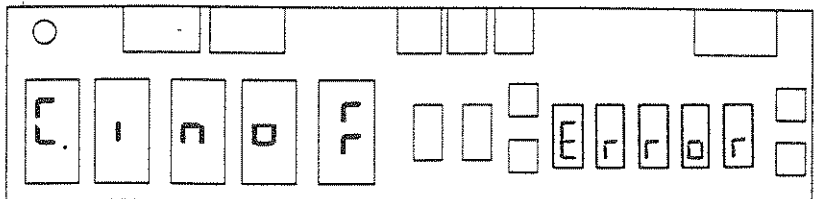

Contact initialization offset measurement error
(High pitch buzzer goes off.)

4.3.3 Contact Initialization

The following describes how to execute contact initialization.

Operation (① through ③)

- ① Press the ^{CAL} twice, and the indication

[i n i t] appears.

- ② Press the ^{CHANGE} for execution.

Display panel state for execution

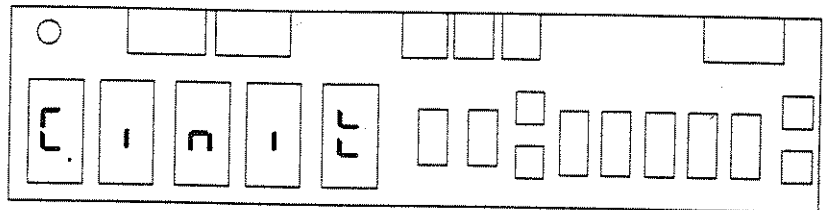

CHANGE

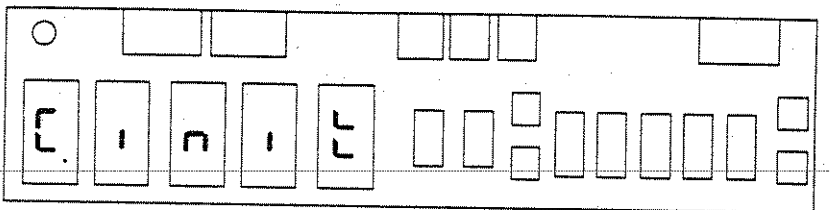

During execution of
contact initialization

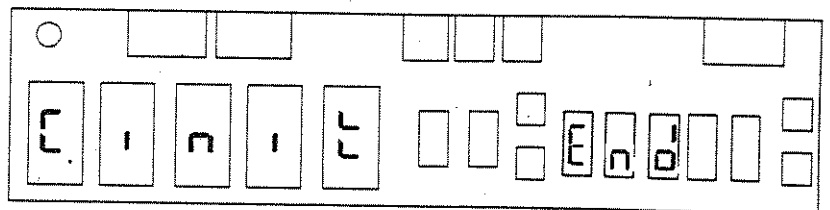

End of contact initialization

- ③ When the ^{EXIT} is pressed, the operation ends. If the contact initialization does not normally end, the following indication appears.

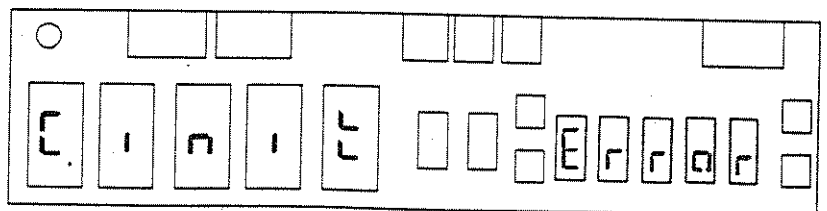

Contact initialization error
(The high-pitched tone buzzer sounds.)

To decrease the error in the contact check and contact initial, use the same test piece and set the same voltage generating value (V SOURCE.)

When the connecting condition between the meter and a sample is changed, execute the contact initialization again. The measured data for contact initialization is stored even if the power is turned off.

4.3.4 Self-test

When the self-test is executed, the following test items are displayed in order of number.

1. LOGIC ROM sum checking
2. E²PROM R/W checking
3. RAM R/W checking
4. ANALOG ROM sum checking
5. SCI checking
6. CAL primary sum checking
7. CAL secondary sum checking
8. Panel parameter sum checking
9. A/D checking
10. Input-, 100V-, and 1000V-amplifier checking

If each test is NG after it is executed, the error is displayed and the self-test ends. For error contents, see Item 3.1.2 "Various messages". The following describes how to execute self-test.

Operation (① through ③)

- ① Press the ^{CAL} fore times, and the indication

Ⓛ ⓔ ⓢ Ⓛ appears.

- ② Press the ^{CHANGE} for execution.

Display panel state for execution

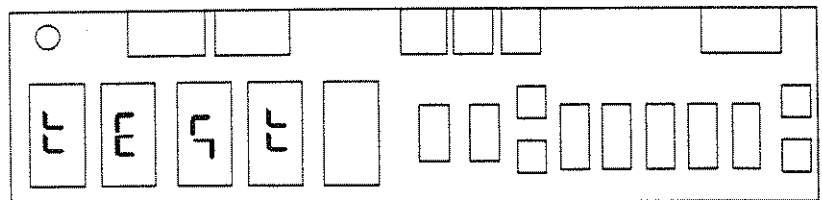

^{CHANGE}

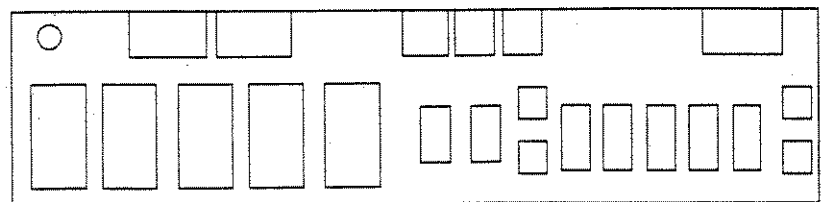

During execution of self-test,
All LEDs go out.

Ⓐ ↓

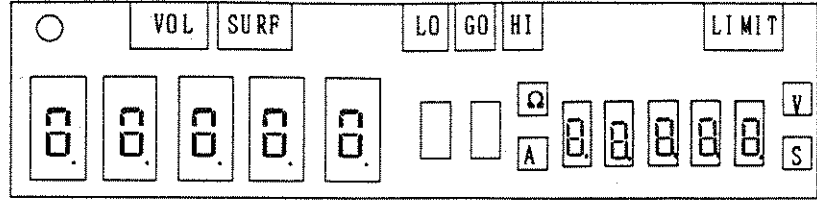

During execution of each test,
ALL LEDs light.

↓

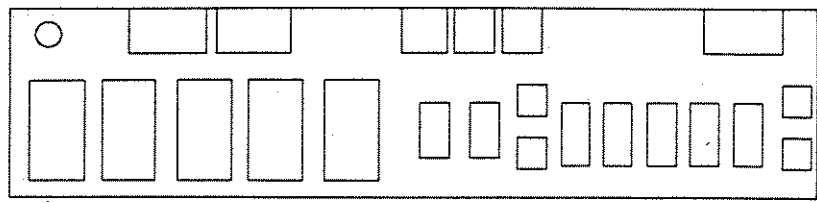

End of each test,
All LEDs go out.

↓

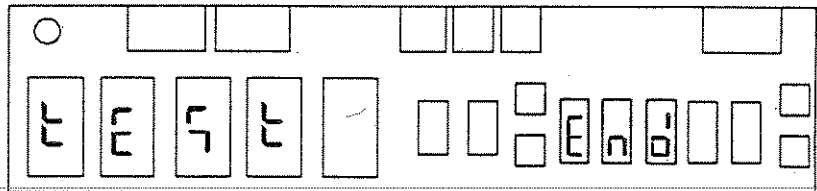

End of self-test

- ③ When the ^{EXIT} is pressed, the state exits from the mode and returns to the normal measurement state.

4.4 Various COEF-key Setting Methods

4.4.1 Upper Level

The following describes how to set the upper level for comparison in the COMPARE mode. The setting unit indication includes the symbol and exponent units. For how to set unit indication, see Item 4.2.6 "Unit indication".

(1) For symbol unit indication

Operation (① through ③)

① Press the ^{COEF} once, and the indication

U P P E R appears.

The set value of the present upper level is displayed.

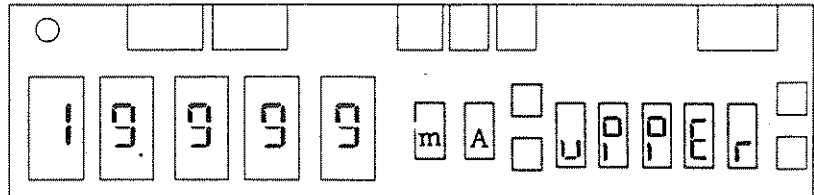

Present setting

② To change the present set value, input a new value with numerical keys. To change the setting to 123.45 pA, for example:

②-1 Input numeric values as follows:

Press the and .

1 2 3 4 5

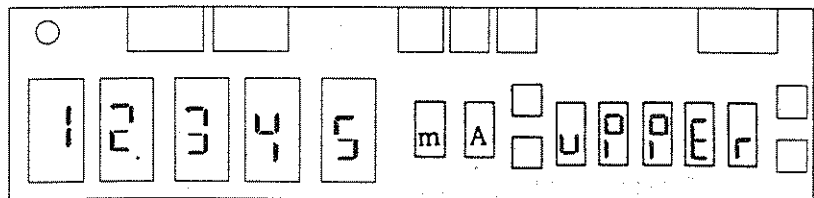

②-2 Set the range.

Press the ^{CHANGE} until the required range appears.

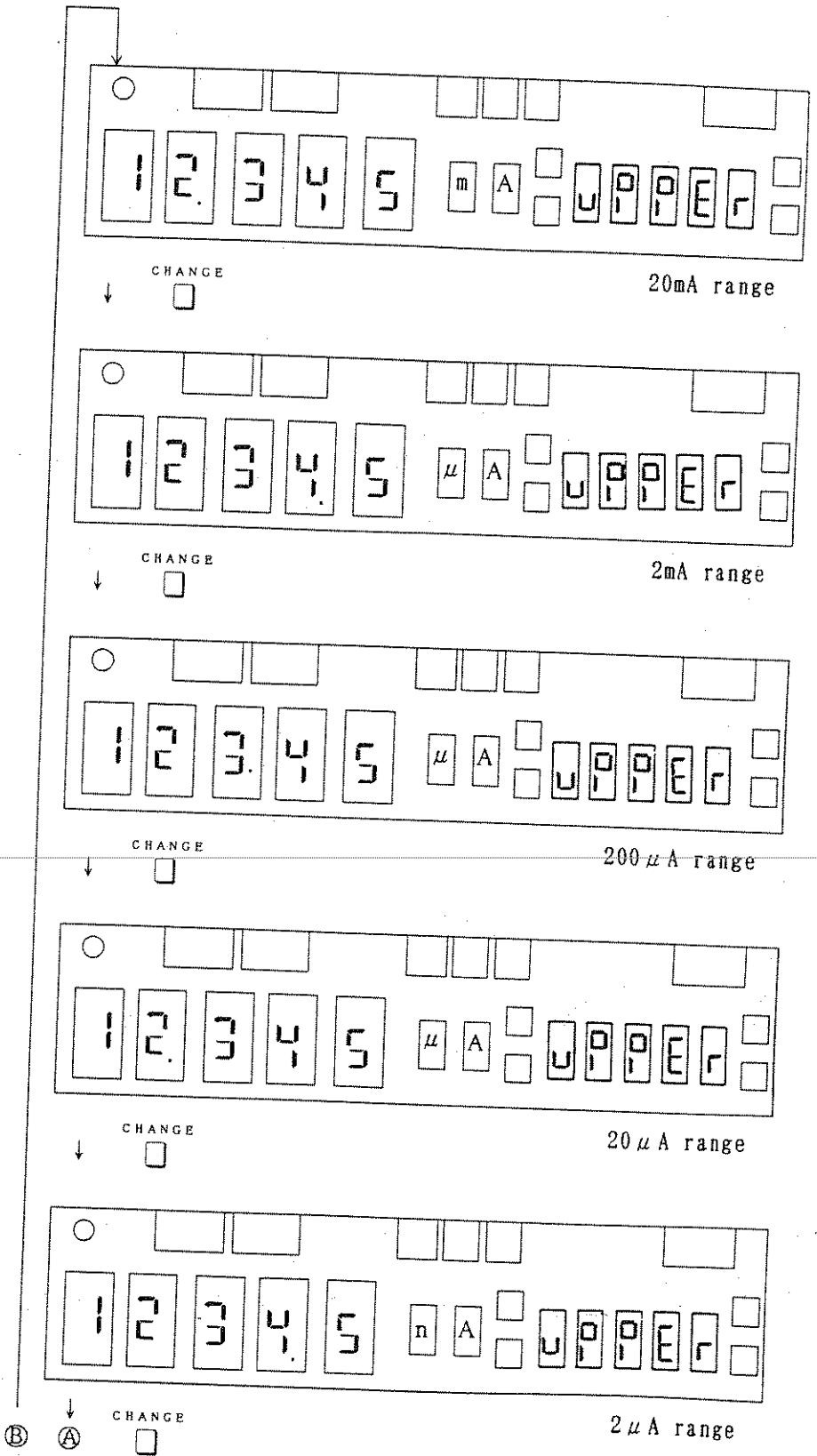

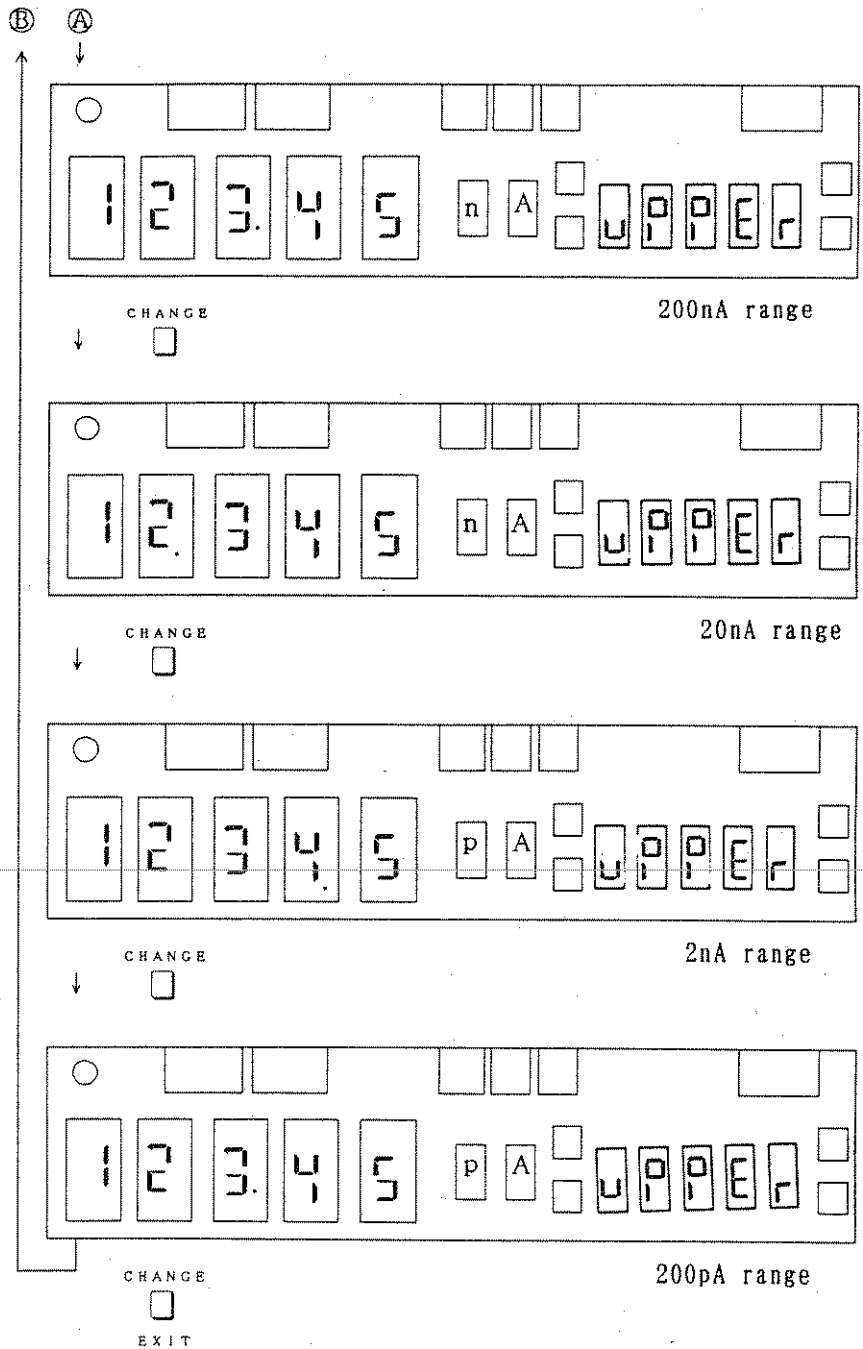

③ When the is pressed, the unit indication changes to symbol unit and the setting ends.

(2) For Exponent Unit Indication

The symbol unit indication is described in Item (1). Also for the exponent unit indication, change the exponent value with

the ^{CHANGE}.

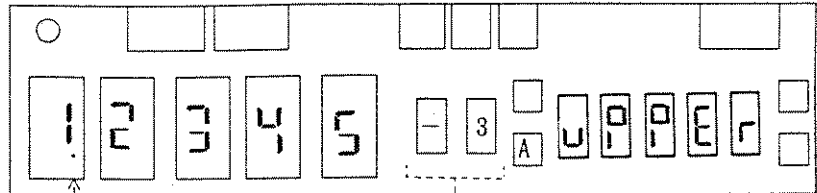

The decimal point position is fixed.

Change them with the

^{CHANGE}.

CAUTION

1. The following shows the setting range of each measured value.

Current measured value :
 -19.999mA ($-1.9999 \times 10^{-2} \text{A}$) to
 19.999mA ($1.9999 \times 10^{-2} \text{A}$)

Resistance measured value:
 000.0m Ω ($0.000 \times 10^{-1} \Omega$) to
 30.00E Ω ($3.000 \times 10^{10} \Omega$)

Volume resistivity : $0.000 \times 10^{-6} \Omega$ to $3.000 \times 10^{24} \Omega$

Surface resistivity : $0.000 \times 10^{-4} \Omega$ to $3.000 \times 10^{20} \Omega$

If a value exceeding the above range is set, an input

error occurs when pressing the ^{EXIT} or the ^{CHANGE}.

2. Be sure to set the upper-level and lower-level values so that they will meet the following inequality.
 Upper level value \geq Lower level value
3. If an upper-level set value smaller than a lower-level set value is set, an input error occurs.

In this case, press the ^{COEF} to move to the lower level setting state and set a lower-level value smaller than the upper level value.

4. If you input an incorrect value, press the _{CE}. Then the preceding set value appears and you can input a new value.

4.4.2 LOWER Level

The following describes how to set lower level for comparison in the COMPARE mode.

(1) For Symbol Unit Indication

Operation (① through ③)

- ① Press the ^{COEF} twice, and the indication **LOWER** appears.
The present lower-level set value is displayed.

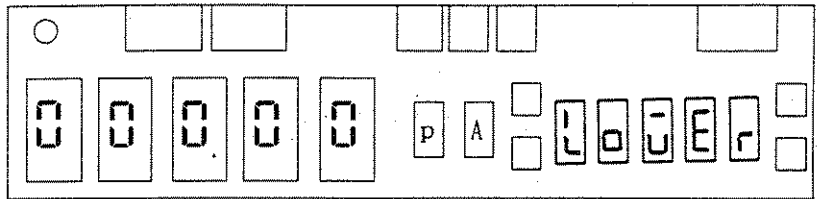

.....
Present set value

- ② To change the present set value, input a new value with numeric keys. To change the setting to -123.45, for example:

- ②-1 Input numeric values as follows:
Press the and
 +/- 1 2 3 4 5

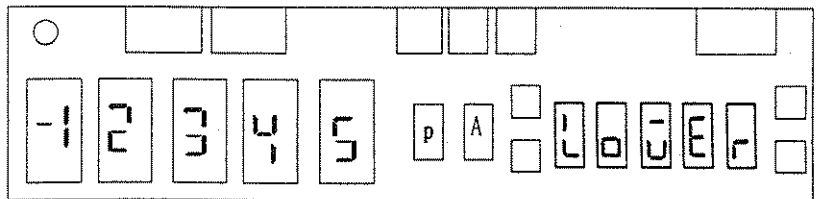

②-2 Set the range.

Press the ^{CHANGE} until the required range appears.

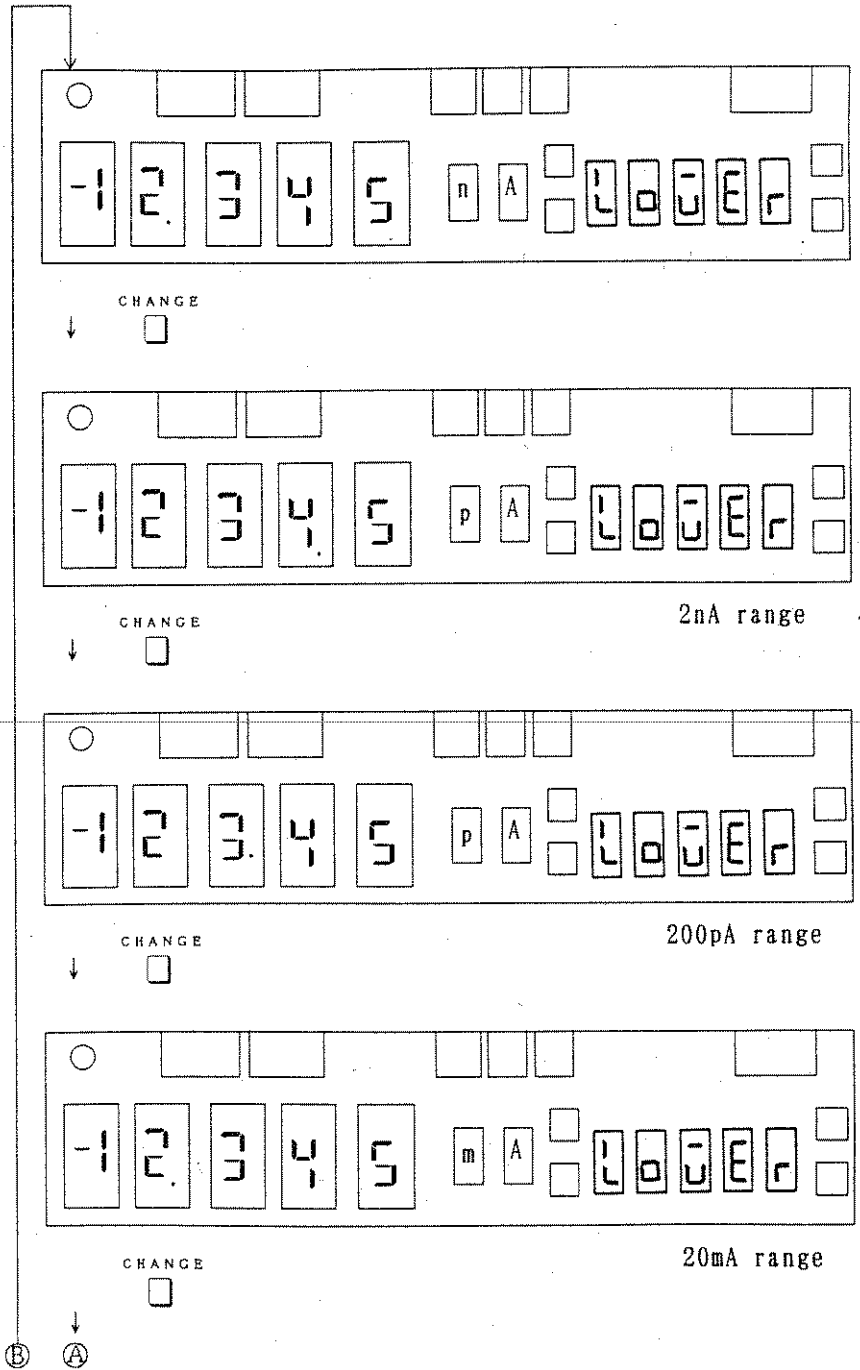

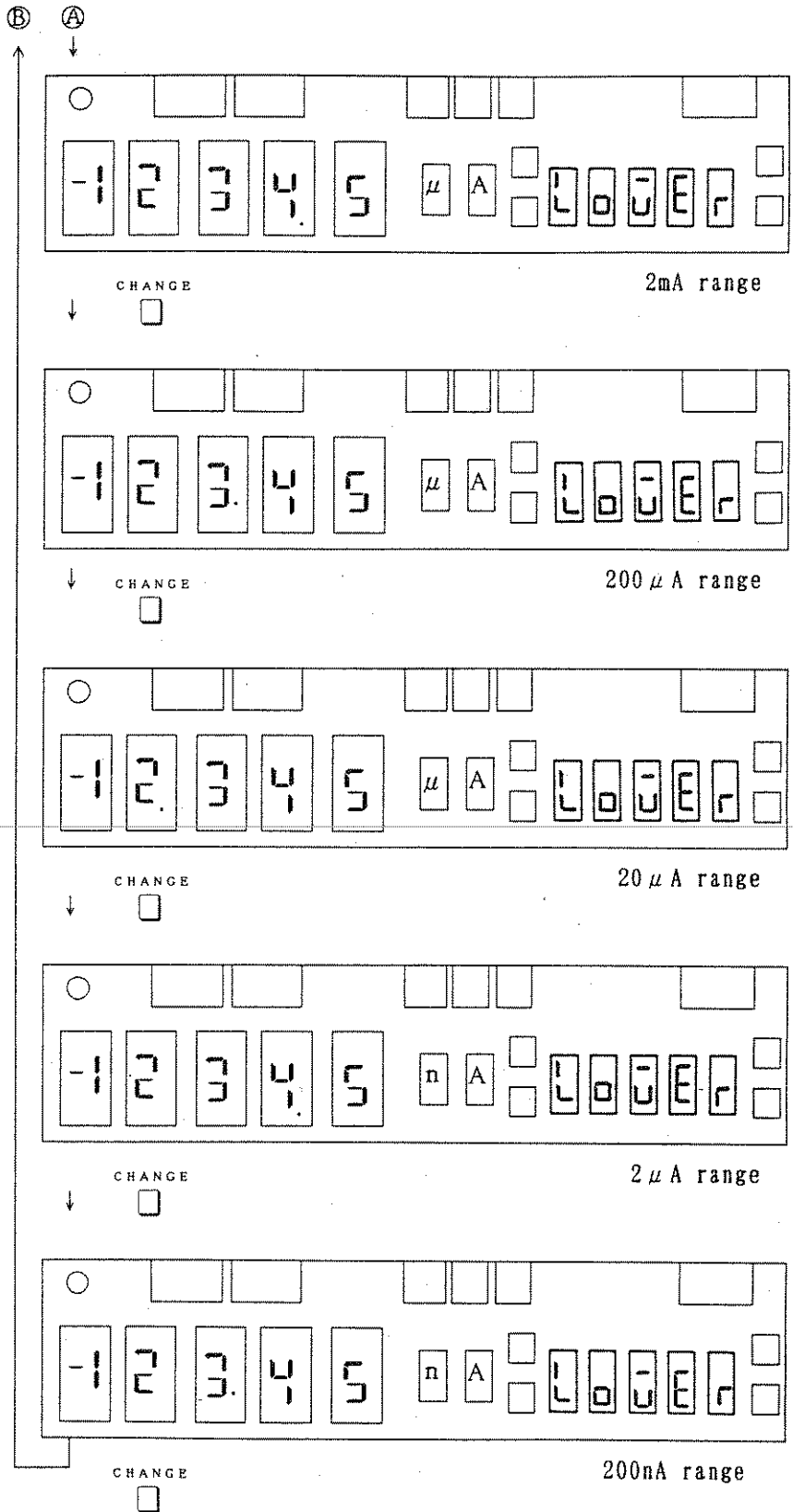

- ③ When the ^{EXIT} is pressed, the unit indication changes to symbol unit and the setting ends.

(2) For Exponent Indication

The symbol unit indication is described in Item (1). Also for the exponent unit indication, change the exponent value with

the ^{CHANGE}.

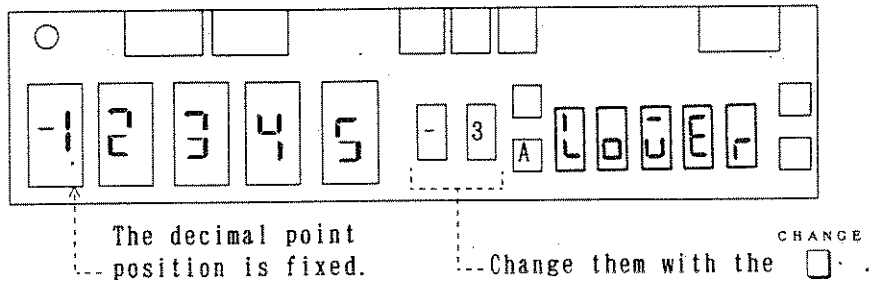

CAUTION

- The following shows the setting range of each measured value.

Current measured value:

-19.999mA (-1.9999×10^{-2} A) to
19.999mA (1.9999×10^{-2} A)

Resistance measured value:

000.0m Ω (0.000×10^{-1} Ω) to
30.00E Ω (3.000×10^{10} Ω)

Volume resistivity : 0.000×10^{-6} Ω to 3.000×10^{24} Ω

Surface resistivity: 0.000×10^{-4} Ω to 3.000×10^{20} Ω

If a value exceeding the above range is set, an input

error occurs when pressing the ^{EXIT} or the ^{CHANGE}.

- Be sure to set the upper-level and lower-level values so that they will meet the following inequality.
Upper level value \geq Lower level value
- If an lower-level set value larger than a upper-level set value is set, an input error occurs.
In this case, re-input the correct value.

4.4.3 Resistance Measurement Indication

In the resistance measurement state; the resistance-value, volume resistivity, or surface resistivity indication is set. The following describes how to set resistance measurement indication.

Operation (① through ③)

- ① Press the ^{COEF} three times, and the indication ρ \bar{n} appears.
- ② Press the ^{CHANGE} until the required indication appears.

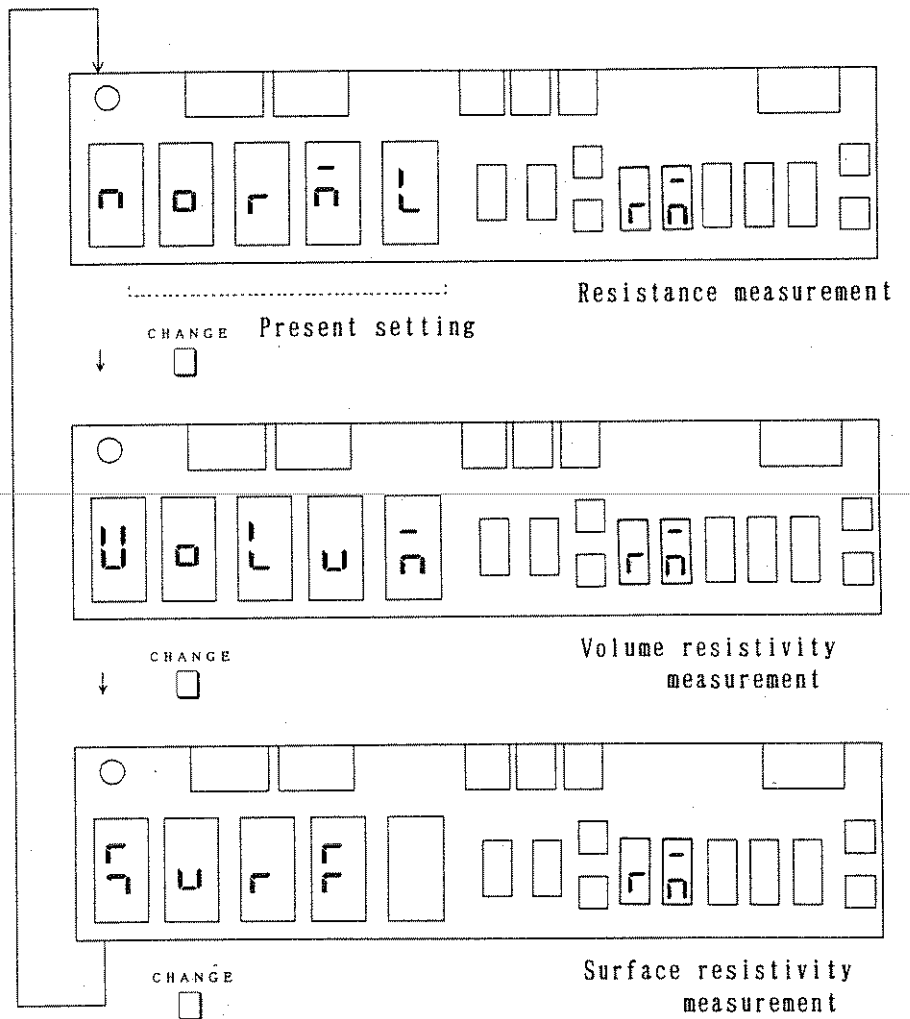

- ③ When the ^{EXIT} is pressed, the setting ends.

4.4.4 Setting of Volume- / Surface-Resistivity Electrode

The following describes how to set electrode used for measurement of volume and surface resistivities.

Operation (① through ③)

- ① Press the ^{COEF} four times, and the indication

E. 0 1 n̄ appears.

- ② Press the ^{CHANGE} until the required electrode appears.

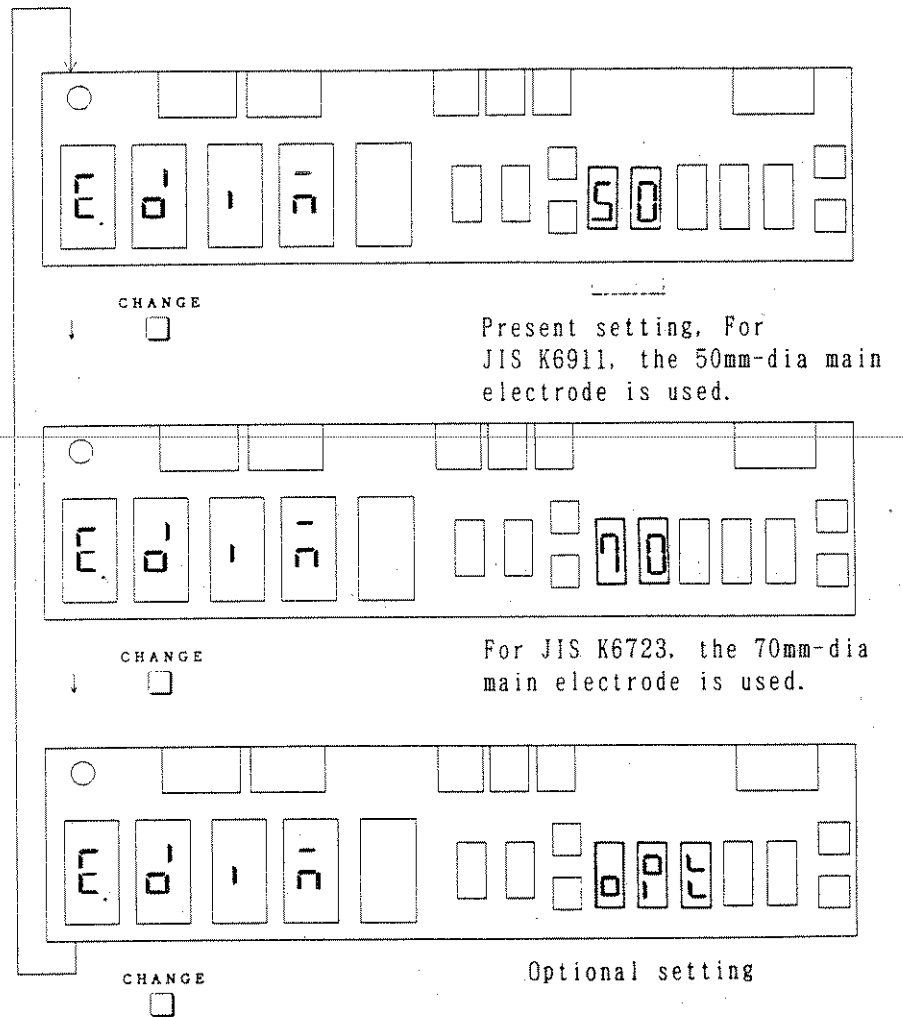

- ③ When the ^{EXIT} is pressed, the setting ends.

4.4.5 Optional Electrode Coefficient

The following describes how to set electrode coefficient for optional setting in Item 4.4.4 "Setting of volume-/surface resistivity electrode".

Operation (① through ④)

① Press the ^{COEF} five times, and the indication **U. C O E F** or **Σ. C O E F** appears.

② Press the ^{CHANGE} to set a volume or surface resistivity.
Whenever the ^{CHANGE} is pressed, the setting is changed over.

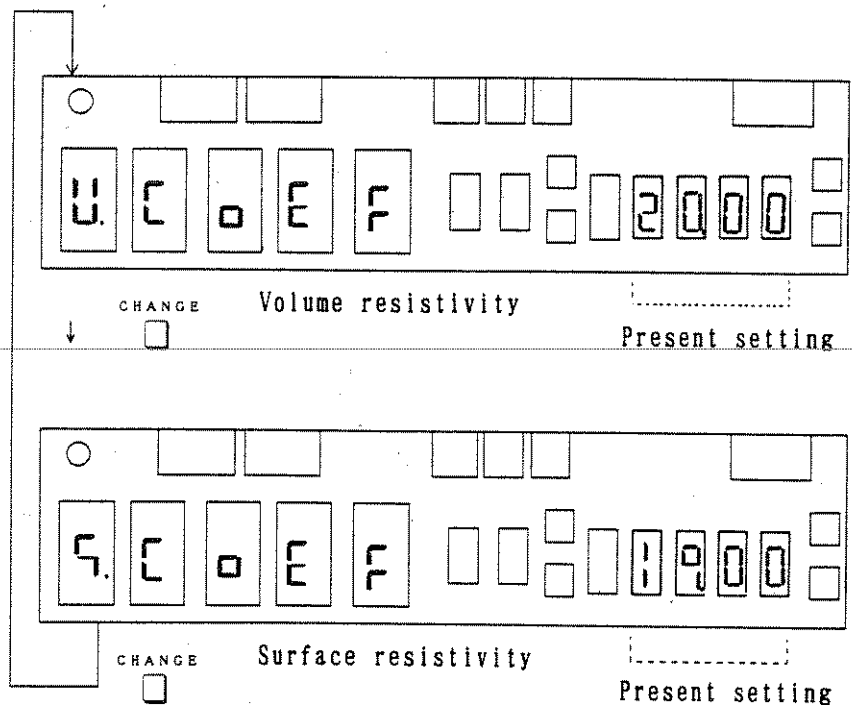

③ Input an electrode coefficient value.

③-1 For Volume Resistivity

To change the setting to "34.56", for example:

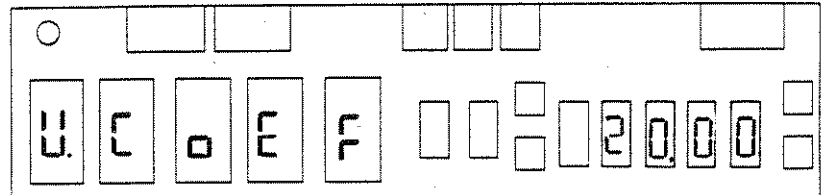

Present setting

↓ Press the ₃ ₄ ₅ and ₈.

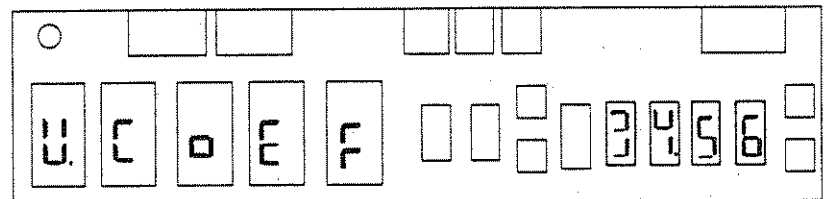

③-2 For Surface Resistivity

To change the setting to "23.45", for example:

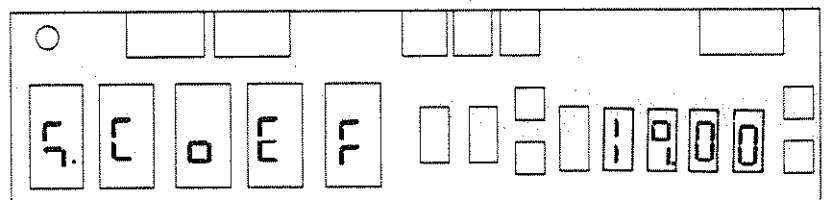

Present setting

↓ Press the ₂ ₃ ₄ and ₅.

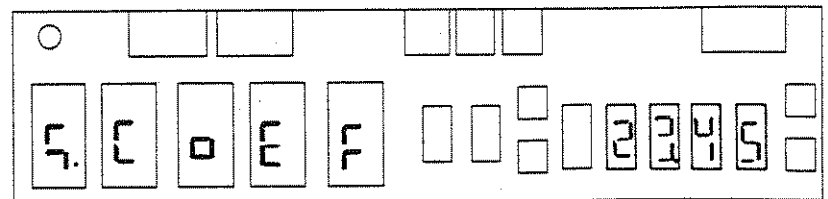

④ When the ^{EXIT} is pressed, the setting ends.

CAUTION

1. The coefficient setting range is 0.001 through 9999. If a value out of the range is set, an input error occurs when the ^{EXIT} is pressed.
2. The electrode coefficient for either volume or surface resistivity can be set.
3. If you input an incorrect value, press the _{CE}. Then the preceding set value appears and you can input a new value.

4.4.6 Sample Thickness

The following describes how to set sample thickness necessary for measurement of volume resistivity. The sample thickness unit uses "mm".

Operation (① through ③)

- ① Press the ^{COEF} six times, and the indication

S A M P L appears.

- ② Input the sample thickness value. To change the setting to "12.34 mm", for example:

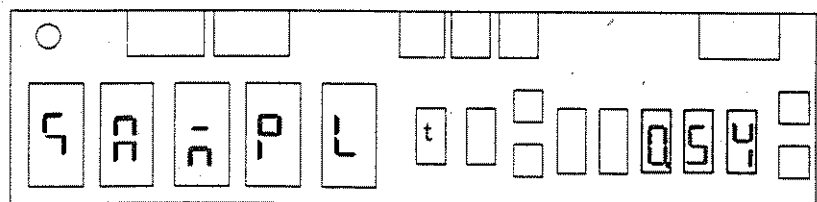

↓ Press the ₁ ₂ ₃ and ₄. Present setting

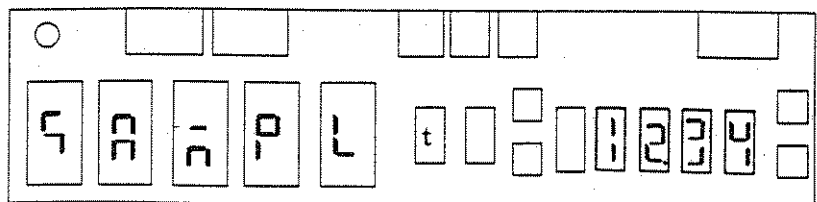

- ③ When the ^{EXIT} is pressed, the setting ends.

CAUTION

1. The sample thickness setting range is 0.001 through 999.9. If a value out of the range is set, an input error occurs when the ^{EXIT} is pressed.
2. If you input an incorrect value, press the . Then the preceding set value appears and you can input a new value.

4.4.7 Contact Level

For the description of contact level, see Item 3.3.8 "Contact checking". The following describes how to set contact level.

Operation (① through ③)

- ① Press the ^{COEF} seven times, and the indication appears.

- ② Press the ^{CHANGE} until the required contact level appears.

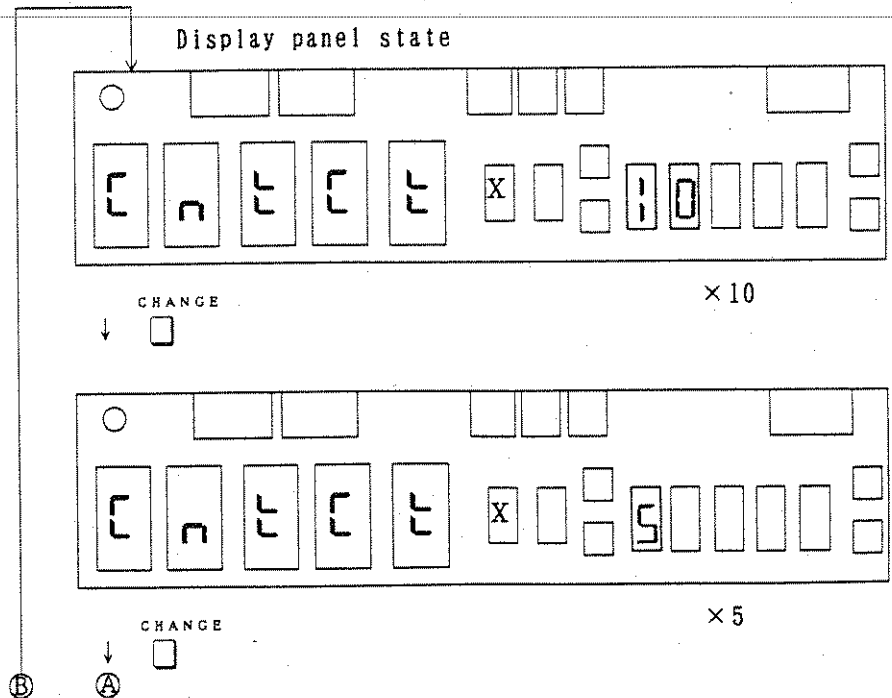

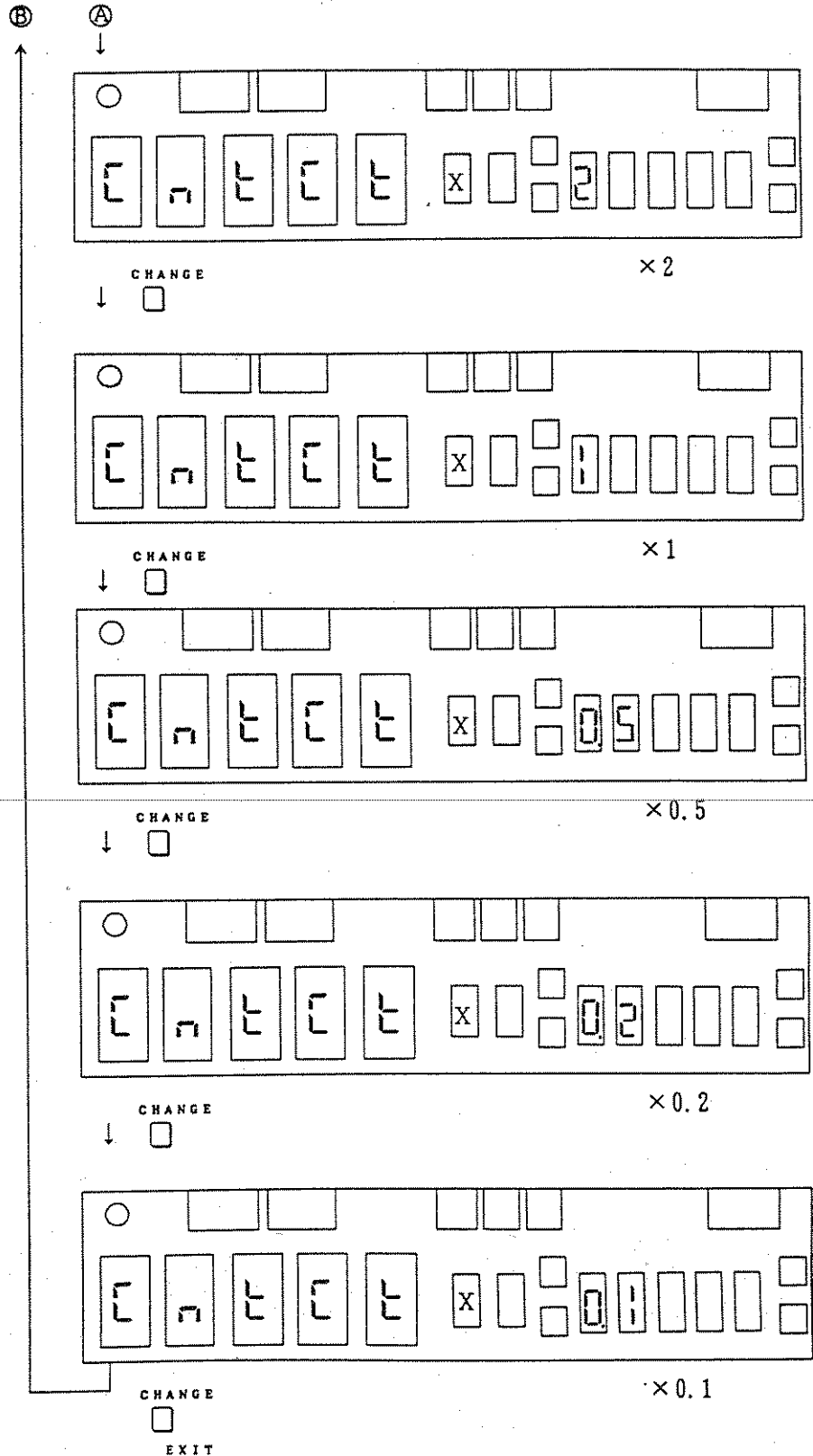

③ When the is pressed, the setting ends.

4.4.8 Buzzer

When the buzzer is set to ON, it sounds in a high-pitched or low-pitched tone under the following conditions.

- COMPARE operation results HI:High-pitched tone
LO:Low-pitched tone
- Fuse open :High-pitched tone
- Overheat detection :High-pitched tone
- Circuit failure :High-pitched tone
- Various errors :Low-pitched tone

The following describes how to set buzzer function.

Operation (① through ③)

- ① Press the ^{COEF} eight times, and the indication B Z appears.
- ② Press the ^{CHANGE} to set the buzzer to ON or OFF. Whenever the ^{CHANGE} is pressed, the setting is changed over.

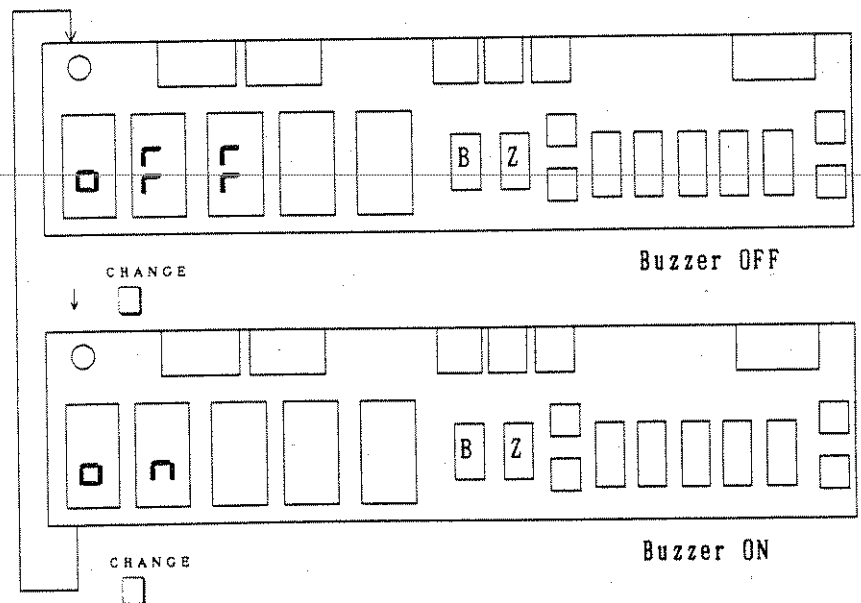

- ③ When the ^{EXIT} is pressed, the setting ends.

4.4.9 Data Indicator

When the indicator is set to OFF, measurement cycle is quickened because no measured data is output to the indicator. Under the OFF state, however, the decimal point and unit of measured values are displayed. The following describes how to set data indicator to ON or OFF.

Operation (① through ③)

- ① Press the ^{COEF} nine times, and the indication

appears.

- ② Press the ^{CHANGE} to set the indicator to ON or OFF.

Whenever the ^{CHANGE} is pressed, the setting is changed over.

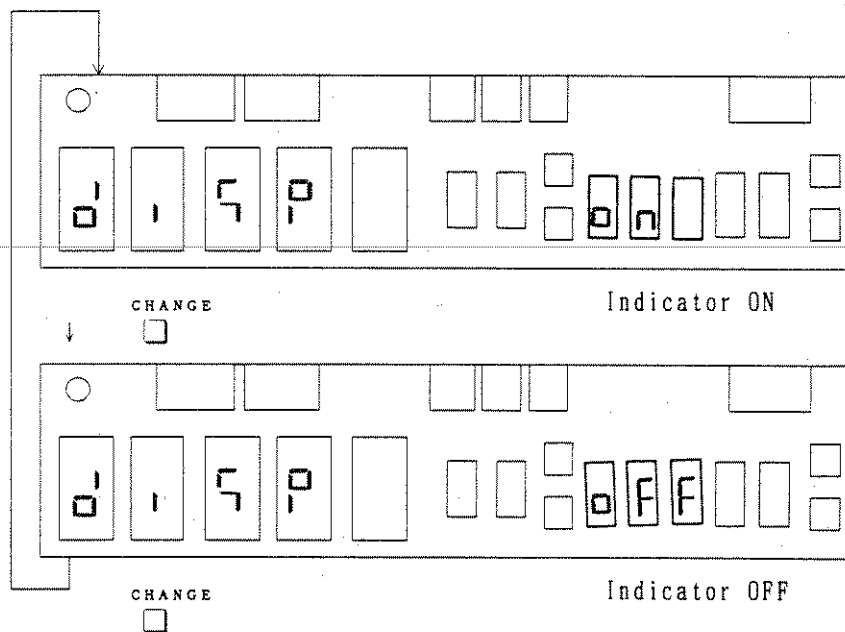

- ③ When the ^{EXIT} is pressed, the setting ends.

4.4.10 Contact Initial Integral Time

The noise may cause the measurement data unstable in the contact check and contact initial. This time, reset the contact initial integral time.

Integral time ——— 2ms : Set this value when the noise is low and the integration speed is high to do a correct judgment.
 ——— 1PLC: Set this value when there are much noises.

In the contact check and contact initial, since the measured data is not displayed, check the noise level by measuring the current described below and determine the contact initial integral time.

- (1) Connect the test piece to the measuring device and set the current range to 20 nA.
- (2) Set the gain to x10000 and select the measurement condition and free run condition.
- (3) Check the dispersions of the current measured when the integrate time (IT) is set to 2ms or 1PLC and compare the contact initial integral times with them in Table 4-3.

Table 4-3 Setting Contact Initial Integral Time Per Noise Level

| Integral Time (IT) | Dispersion of current measured | Setting contact initial integral time |
|--------------------|--------------------------------|---------------------------------------|
| 2ms | Less than 10 counts | 2mS, 1PLC |
| | More than 10 counts | 1PLC |
| 1PLC | Less than 100 counts | |
| | More than 100 counts | |

CAUTION

1. If you reset the contact initial integral time, execute the contact initial. The contact check integration time is determined by the contact initial integral time.
2. If the dispersion of current measured exceeds 100 counts when 1PLC is set (Table 4-3), the contact check will be unstable. Perform shielding so that the dispersion should be less than 100 counts.

The following describes how to set contact initial integration time.

Operation (① through ③)

- ① Press the ^{COEF} ten times, and the indication

[n t . , t] appears.

- ② Press the ^{CHANGE} until the required integration time appears.

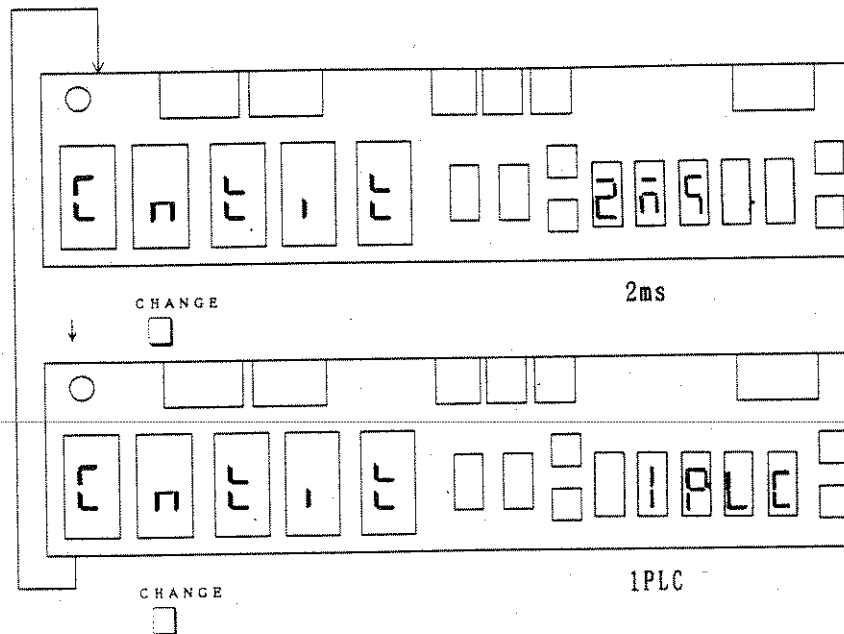

- ③ When the ^{EXIT} is pressed, the setting ends.

4.5 Various I/O-key Setting Methods

4.5.1 DA OUTPUT (R8340A Only)

This function is not given to the R8340. The following describes how to set D/A output to ON (selection of number of digits) or OFF.

Operation (① through ③)

- ① Press the ^{I/O} once, and the indication

0 1 0 0 0 appears.

- ② Press the ^{CHANGE} to set D/A output to the required number of digits or OFF. Whenever the ^{CHANGE} is pressed, the setting is changed over.

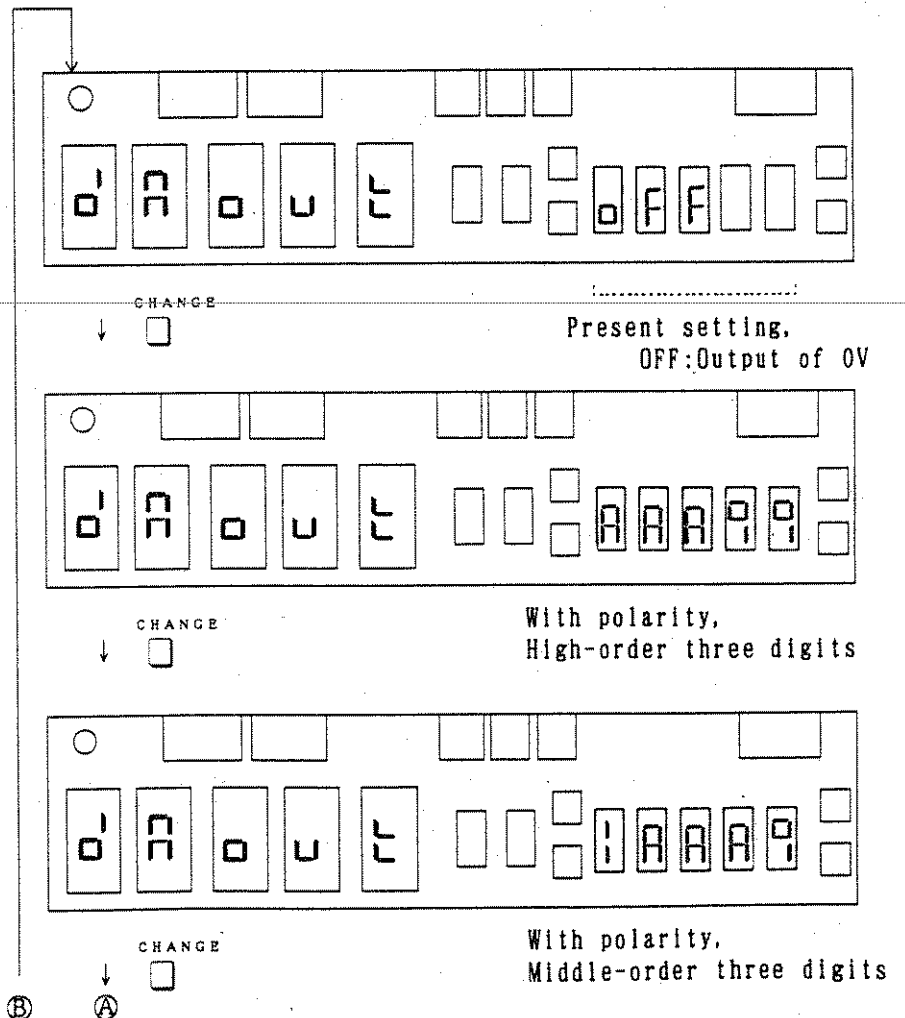

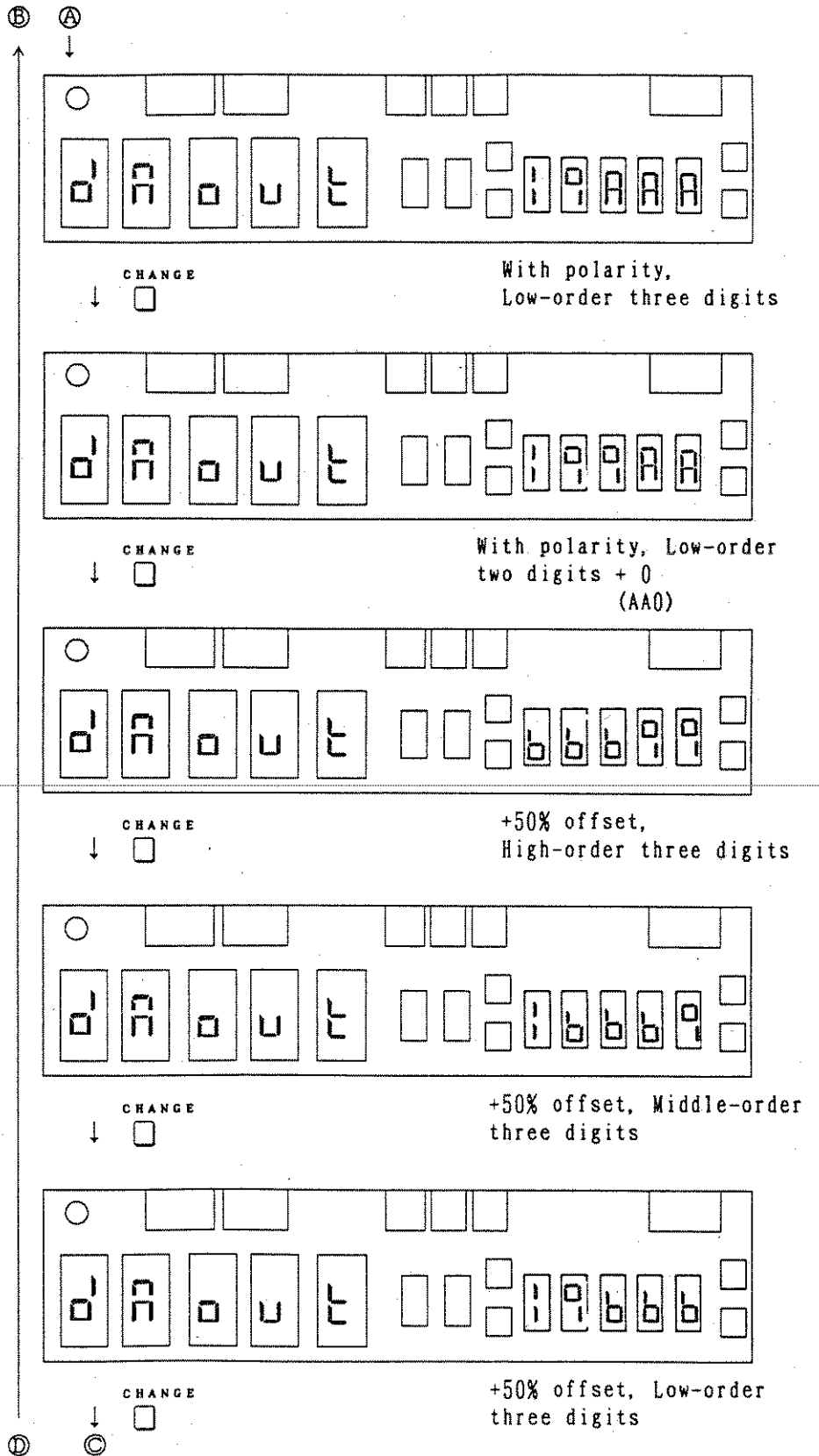

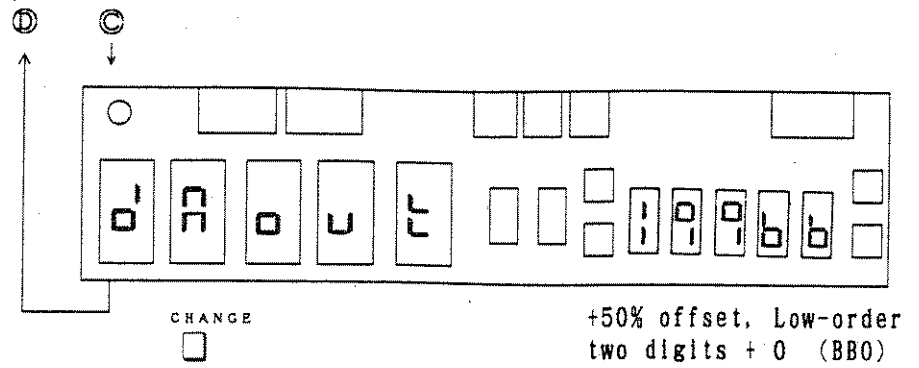

③ When the is pressed, the setting ends.

4.5.2 BCD OUTPUT (R 8 3 4 0 A Only)

This function is not given to the R8340. The following describes how to set the BCD OUTPUT terminal on the rear panel of R8340A to OFF (all high), BCD, or binary output.

Operation (① through ③)

- ① Press the twice, and the indication '0' 'C' '0' appears.
- ② Press the until the required output appears.

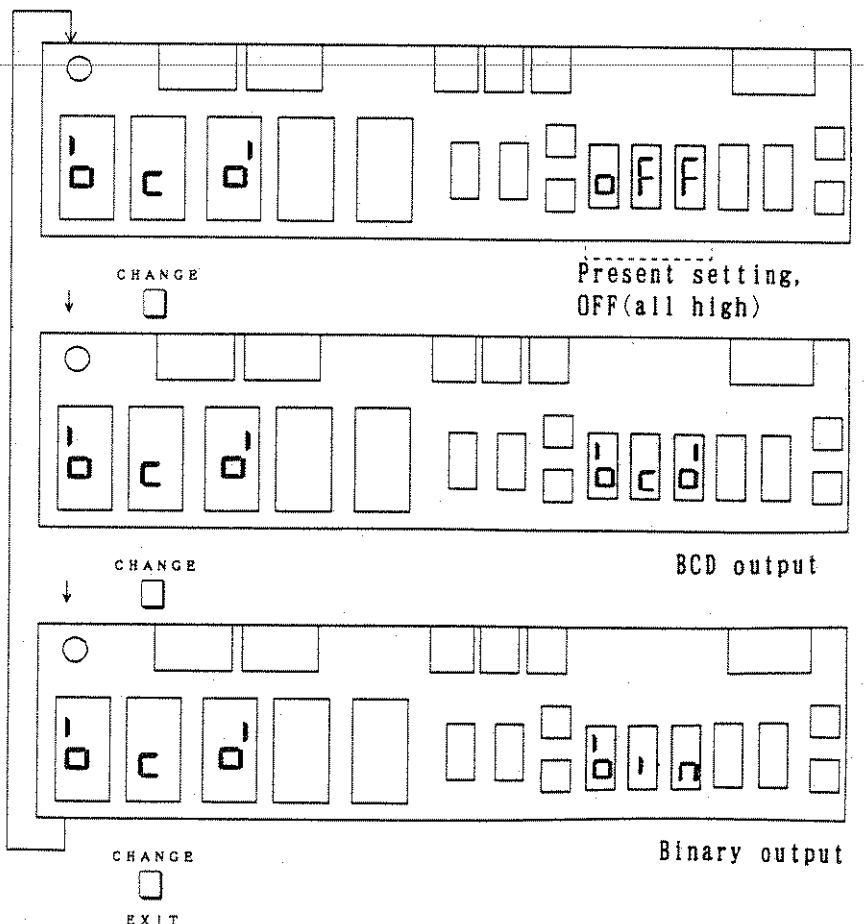

③ When the is pressed, the setting ends.

4.5.3 GPIB

The following describes how to set GPIB header to ON or OFF and how to set address.

Operation (① through ④)

- ① Press the ^{I/O} three times, and the indication

G P - | b appears.

- ② Header setting

Press the ^{CHANGE} until the required header appears.

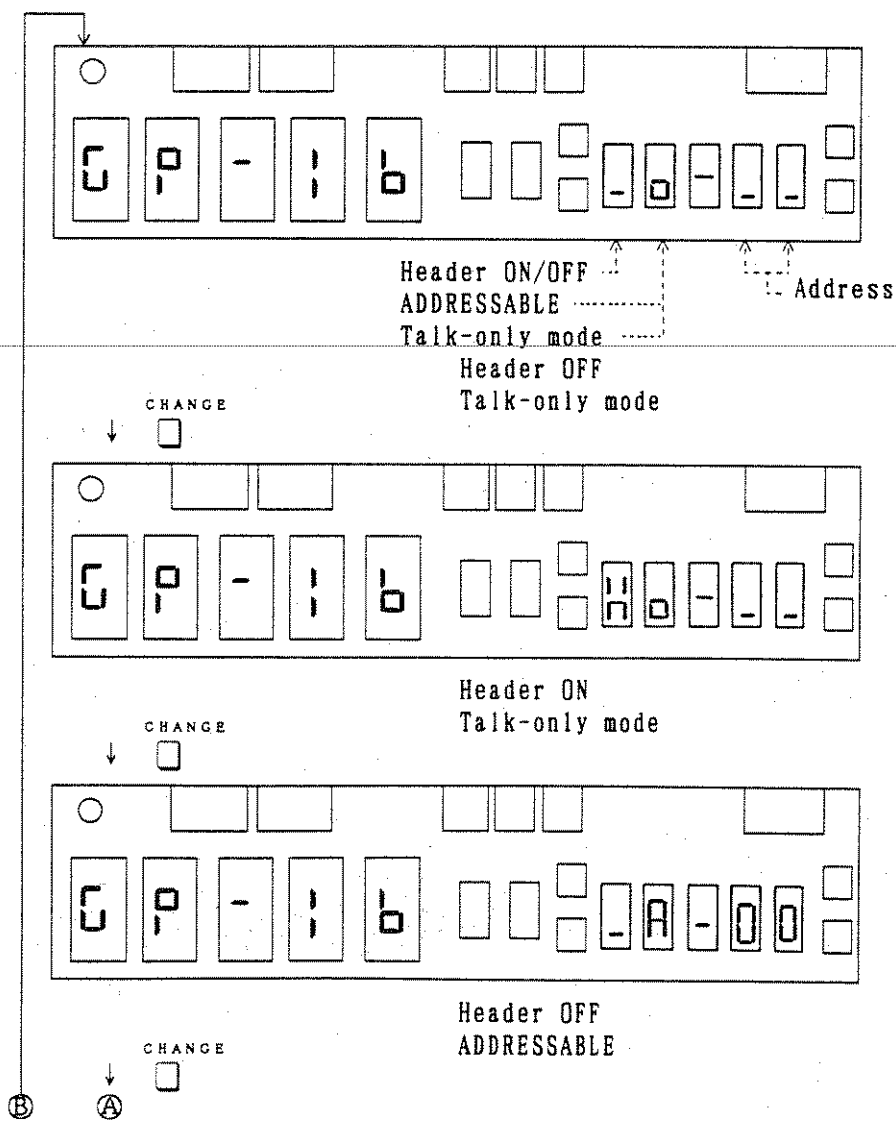

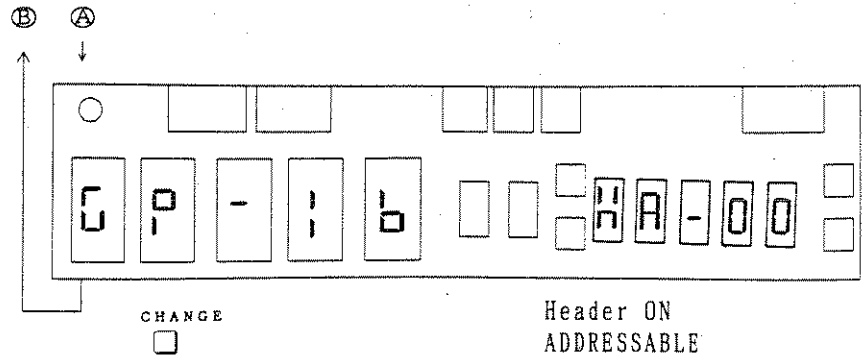

- ③ Address Setting
To set the address to 15, for example:

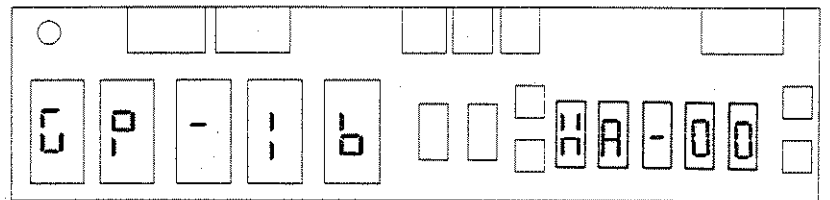

↓ Press the ₁ and ₅.

Present address

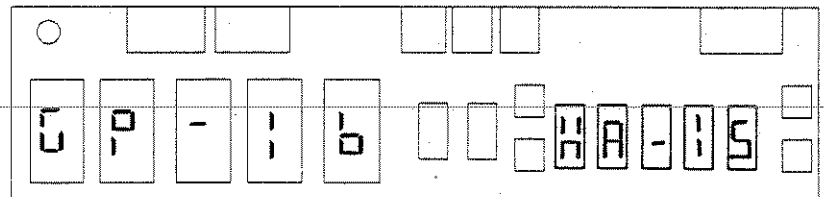

- ④ When the ^{EXIT} is pressed, header ON/OFF and address setting end.

CAUTION

1. If the address is set to 31 or more, an error occurs.
2. No address can be set in the talk-only mode.
3. When the talk-only mode is set, data can directly be output to a listener such as a printer without any controller. In this case, also set the listener to the talk-only mode but do not operate the controller at the same time.

4.5.4 Power Frequency

The following describes how to set power frequency to 50 or 60 Hz.

Operation (① through ③)

- ① Press the ^{I/O} four times, and the indication

L I n E F appears.

- ② Press the ^{CHANGE} to set the frequency to 50 or 60 Hz.

Whenever the ^{CHANGE} is pressed, the setting is changed over.

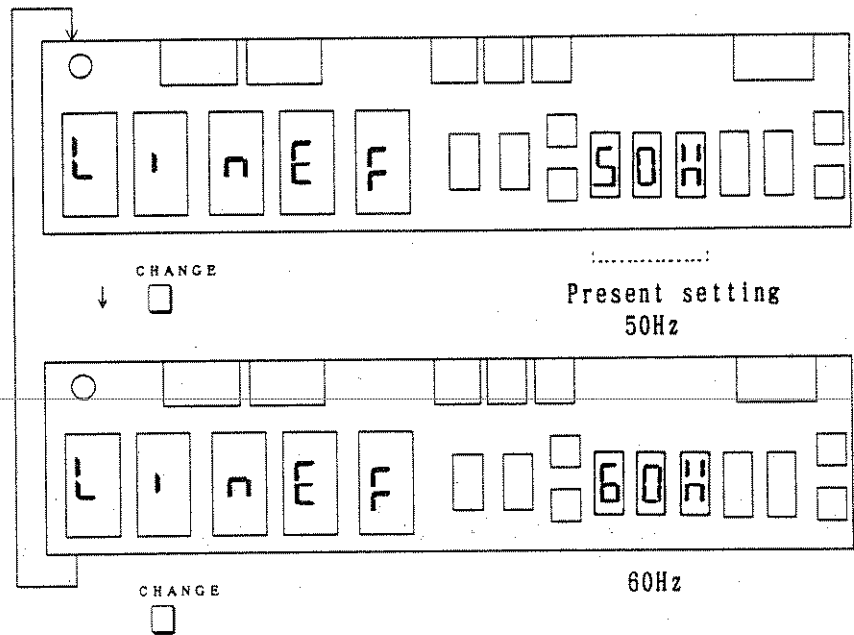

- ③ When the ^{EXIT} is pressed, the setting ends.

4.6 Various MEM-key Setting Methods

4.6.1 Data Storage

Data storage is the function to store measured data in the internal memory. Up to 1000 data values can be stored. When the data storage is executed, data is stored every sample in order and the stored data is provided with a data number respectively. The following describes how to set data storage function to ON or OFF.

Operation (① through ③)

- ① Press the ^{MEM} once, and the indication **S t o r E** appears.
- ② Press the ^{CHANGE} to set the function to ON or OFF.
Whenever the ^{CHANGE} is pressed, the setting is changed over.

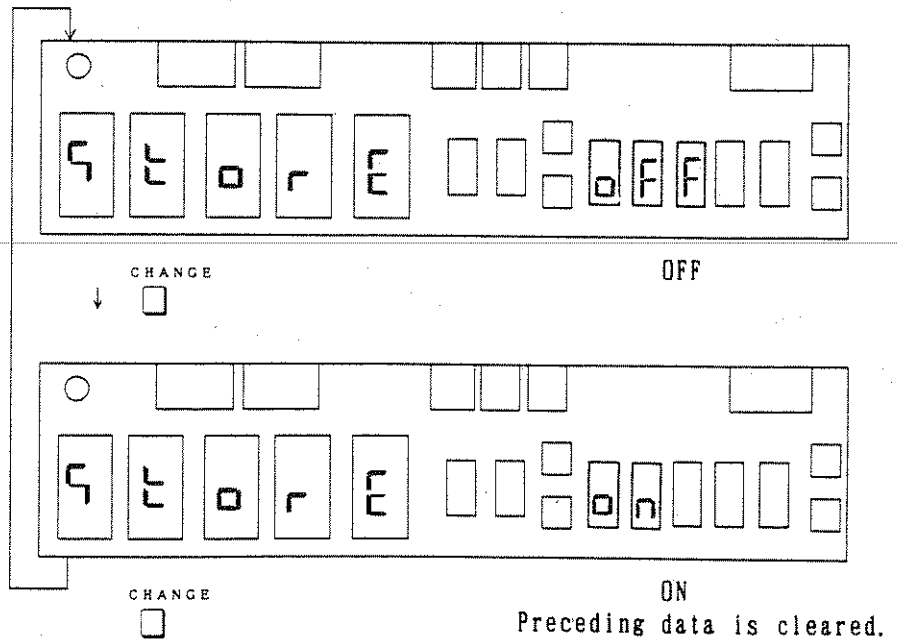

③ To end the setting or store data:

③-1 Press the ^{EXIT}, and the setting ends.

③-2 When the function is set to ON, the following data storage operation is executed.

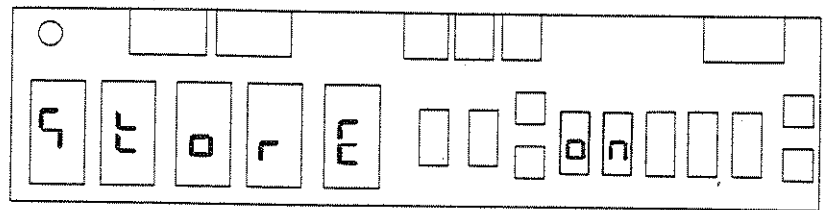

EXIT
↓

ON

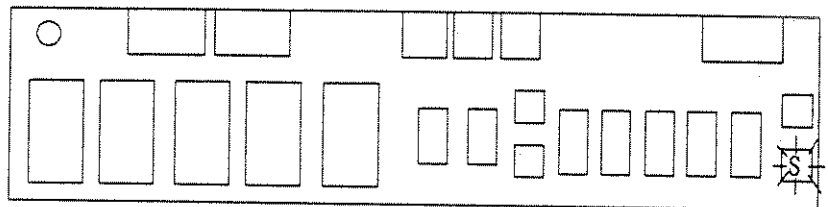

During execution of data storage
 (1000 data values are stored.)

Flickering

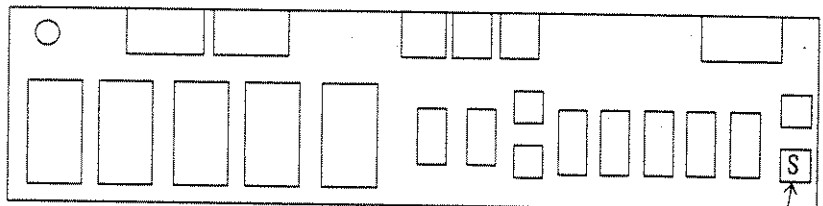

End of data storage

Lighting: Shows that stored data is present.

CAUTION

1. When data storage is executed, the operation ends after 1000 data values are stored. To end the operation before 1000 data values are stored, set the data storage function to OFF.
2. Stored data is deleted in the following cases.
 - When the power is turned off
 - When the data storage function is set to ON again

4.6.2 Data Recall

Data recall is the function to read measured data from the internal memory. The read method includes two types-continuous output and stepping output. The following describes the setting method. The continuous output is the method to read data one value by one value in order of the data number. The stepping output is the method to read required data among stored data one value by one value.

(1) Continuous Output

Operation (① through ③)

- ① Press the ^{MEM} twice, and the indication

R E C A L L appears.

- ② Whenever the ^{CHANGE} is pressed, data is output one value by one

value. When the ^{CHANGE} is pressed again after the final data is displayed, return to the data number 1.

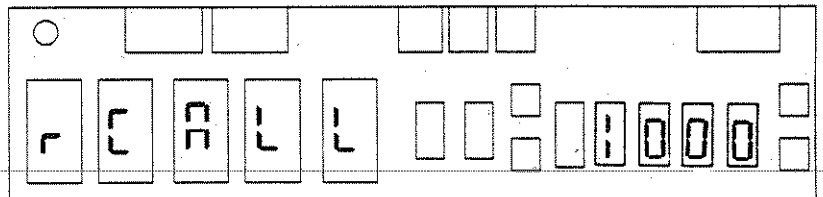

^{CHANGE}

Number of stored data values

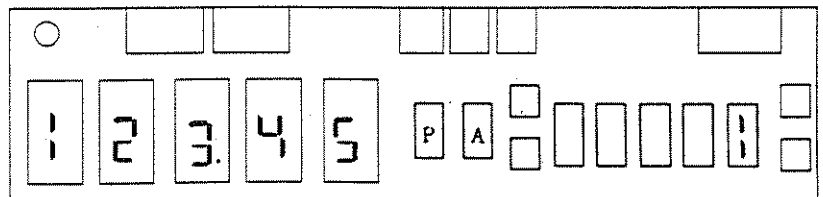

^{CHANGE}

Recall data

Data number

^{CHANGE}

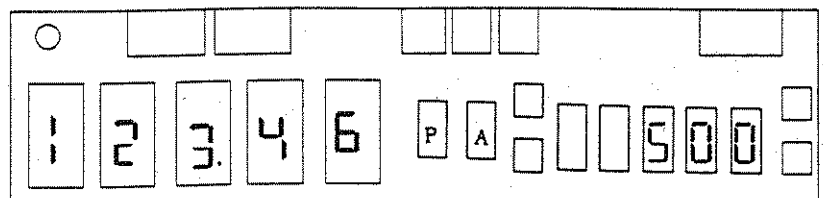

^{CHANGE}

Ⓐ

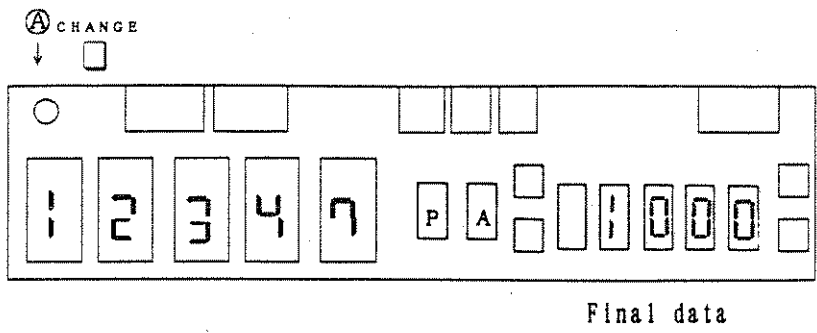

EXIT
 ③ When the is pressed, the state exits from the mode and returns to the normal measurement state.

(2) Stepping Output

Operation (① through ④)

- ① Press the ^{MEM} twice.
- ② Press the ^{CHANGE} to output data.

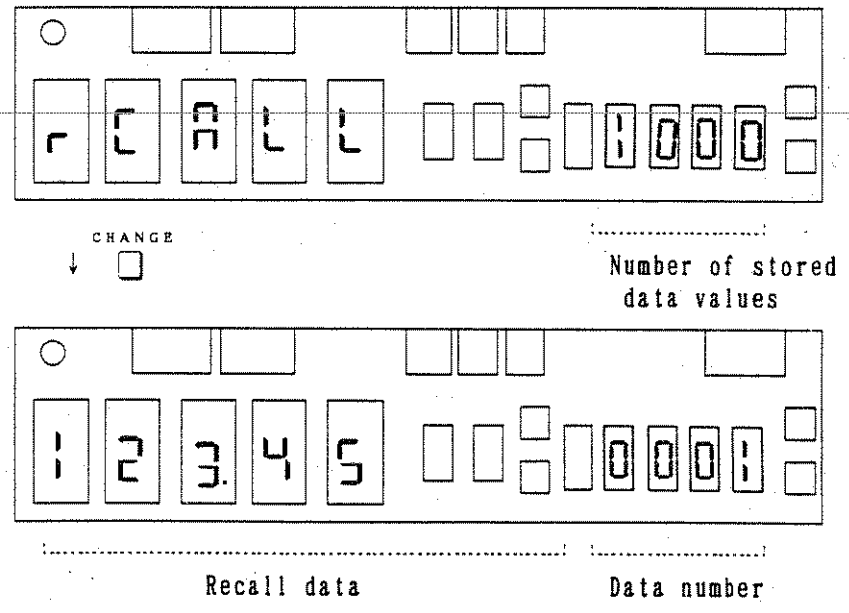

- ③ Input the data number to be recalled and press the ^{CHANGE}.
 To output the data No. 50, for example:

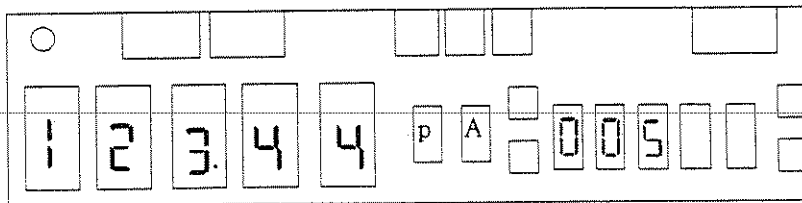
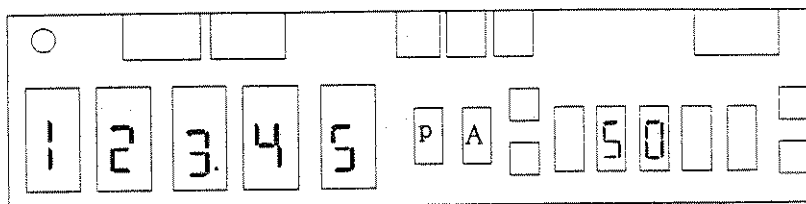
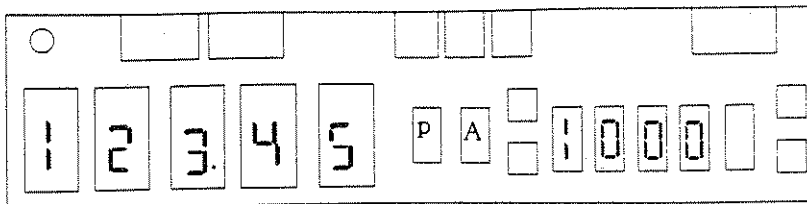

Indication of data No. 50

When the ^{CHANGE} is pressed again, the continuous output mode is set and the next data is output. When a value is input again, the stepping output mode is set.

- ④ When the ^{EXIT} is pressed, the state exits from the mode and returns to the normal measurement state.

5. SEQUENCE PROGRAM

This chapter describes the operation, execution methods and program parameter setting procedures of the sequence program.

Read "3. Operation Procedures" and "4. Parameter Key Description" before reading this chapter.

5.1 Sequence

Sequence program is the function to store the measuring conditions and procedure and execute the measurement under the same condition again by one touch operation. The measuring procedure has six types of sequences from No. 0 to No. 5. For the measuring conditions, it is possible to set the charge time, discharge time, measurement time and auto-start value to automatically judge the end of discharge. The function also makes it possible to measure the insulation resistance specified in JIS C5102 (Test Methods of Fixed Capacitors for Electronic Equipment) by setting the charge time to 1 min.

The following describes six types of sequences from the measuring procedure No.0 through No.5.

(1) Program No.0

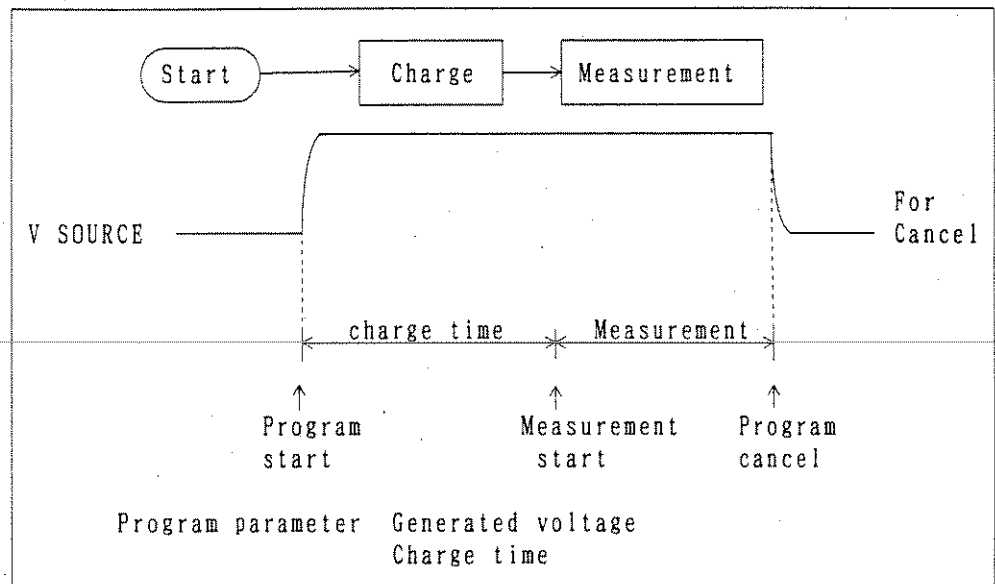

When the program No. 0 is started, charge is made, one-time measurement starts simultaneously with elapse of the charge time, and keep measuring in the measurement state until the program is canceled.

(2) Program No. 1

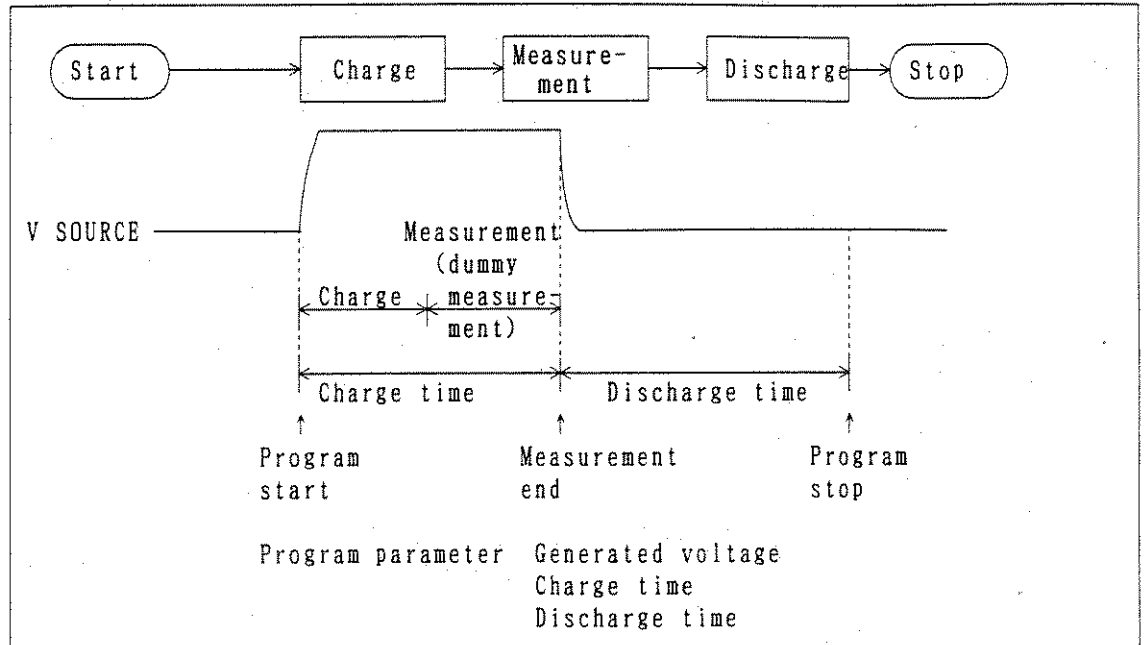

When the program No. 1 is started, charge is made and one-time measurement ends simultaneously with elapse of the charge time. When the measurement ends, the discharge state is set and the program ends.

CAUTION

1. For the charge time 2.001 seconds or more, the dummy measurement will be started at half time of the charge time.
2. For the charge time 2.000 seconds or less, the dummy measurement is not done.

(3) Program No. 2

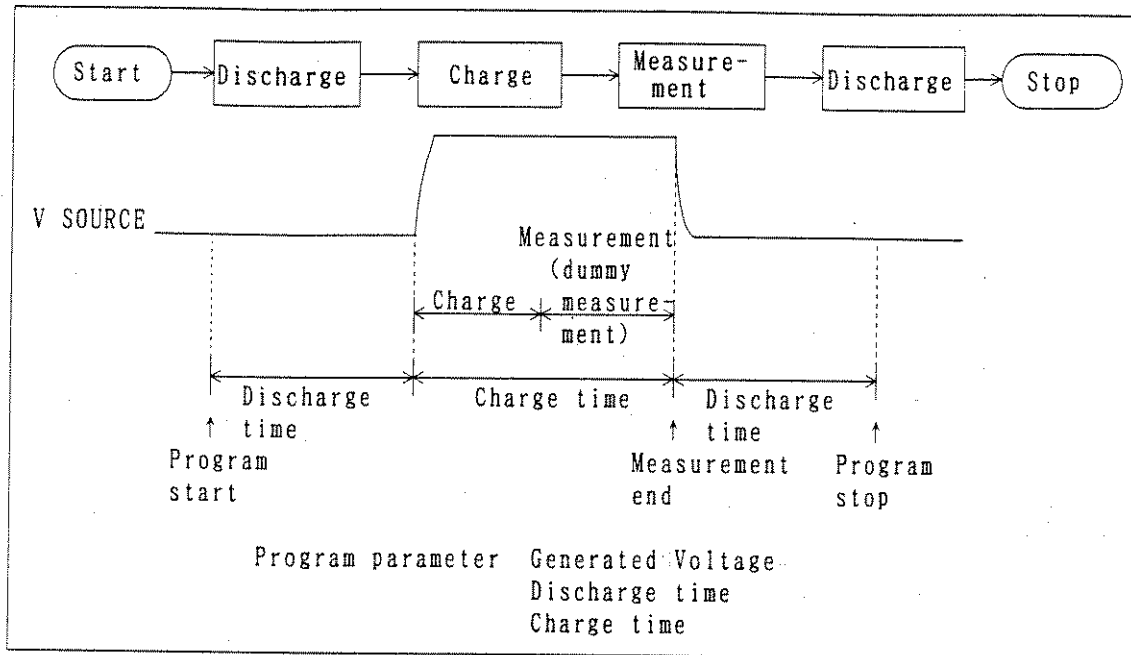

When the program No.2 is started, discharge is made and the charge state is set when the discharge time ends. One-time measurement ends simultaneously with elapse of the charge time, discharge is made, and the program ends.

CAUTION

1. For the charge time 2.001 seconds or more, the dummy measurement will be started at half time of the charge time.
2. For the charge time 2.000 seconds or less, the dummy measurement is not done.

(4) Program No. 3

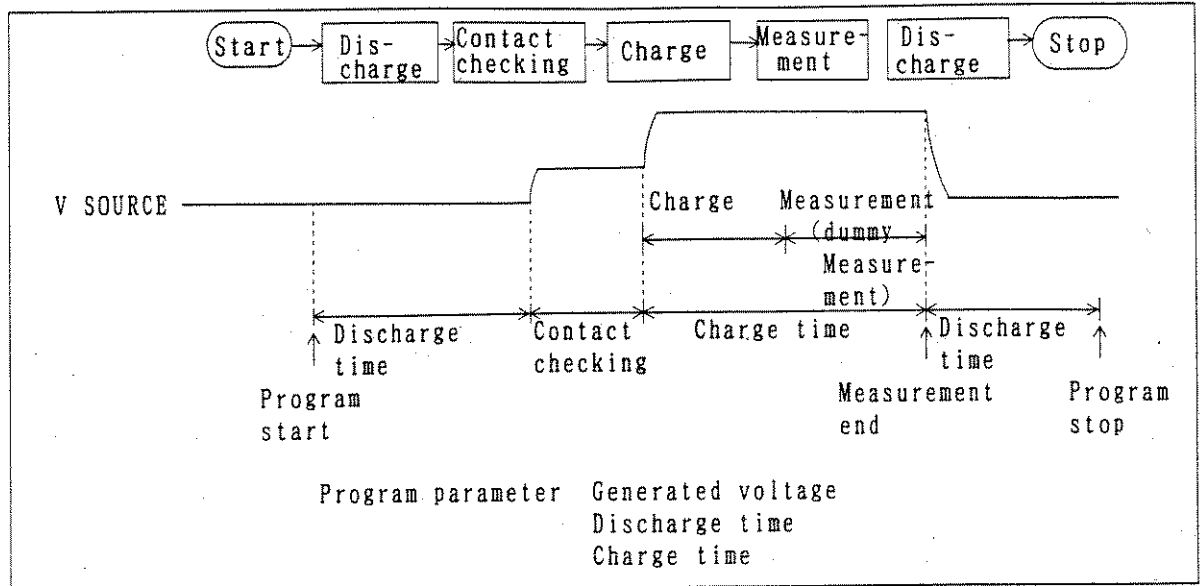

When the program No. 3 is started, discharge state is set and contact checking is made when the discharge time elapses. If contact checking is NG, the program ends immediately. When contact checking is OK; charge state is set, one-time measurement ends simultaneously with elapse of the charge time, discharge starts, and the program ends.

CAUTION

1. For the charge time 2.001 seconds or more, the dummy measurement will be started at half time of the charge time.
2. For the charge time 2.000 seconds or less, the dummy measurement is not done.

(5) Program No. 4

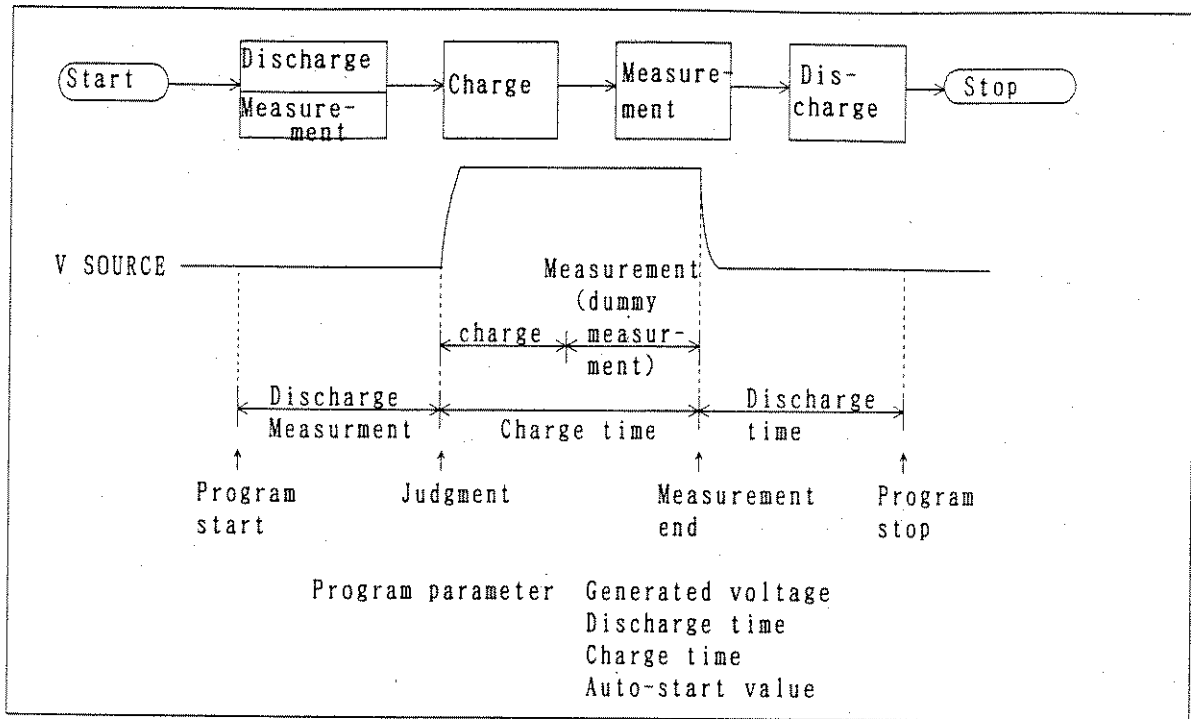

When the program No.4 is started, current is measured while executing discharge. When the measured current value is lower than the preset auto-start value, discharge is judged to be ended and charge starts. When the charge time elapses; one-time measurement ends, discharge starts, and the program ends.

CAUTION

1. For the charge time 2.001 seconds or more, the dummy measurement will be started at half time of the charge time.
2. For the charge time 2.000 seconds or less, the dummy measurement is not done.

(6) Program No. 5

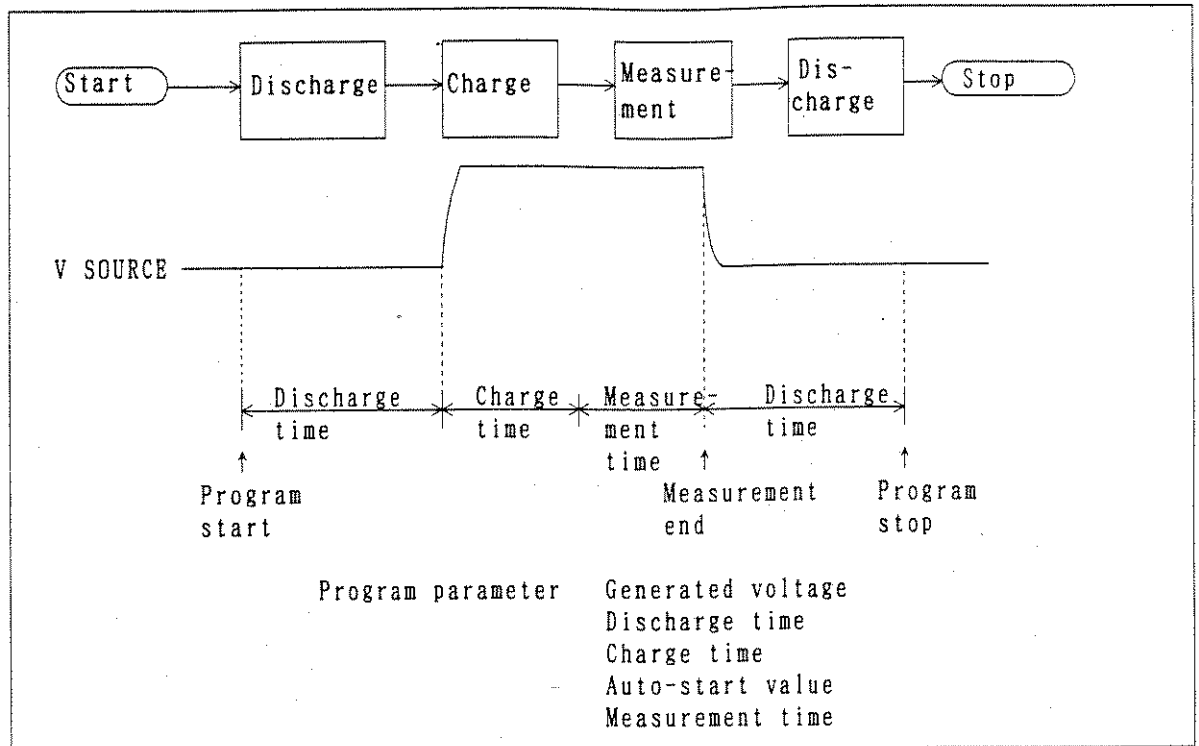

When the program No. 5 is started, discharge is made and the charge state is set when the discharge time ends. The measurement state is set when the charge time ends.

When the measurement is completed, perform the final measurement. Then, perform the discharge and complete the program.

On the measurement, the data measured is not displayed. If an autorange mode is set, the measurement range is automatically set to an optimum value.

5.2 Execution of Sequence Program

The following shows how to execute sequence program and operations during execution.

Operation (① through ⑤)

- ① When the ^{PRGM/NORMAL} is pressed; the LED lights, the program mode is set, and the following indication appears.

Display panel state for execution

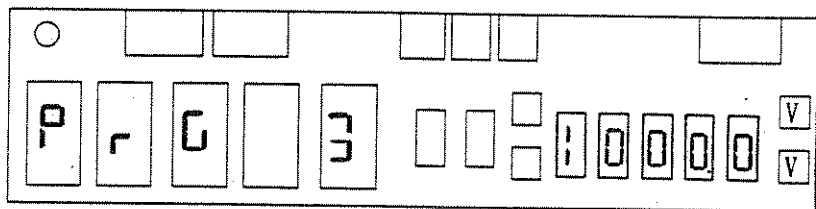

Program mode

The presently set program No. and set voltage are displayed. Subsequently, description is continued by using the program No.3 as an example. In the program mode, discharge state is

set before execution of the program. When the ^{PRGM/NORMAL} is pressed again, the program mode is canceled and the state returns to the normal measurement mode.

- ② Press the ^{OPERATE} to set the V-SOURCE to OPERATE state (LED lights). If the V-SOURCE is stand-by (LED goes out), no program can be executed. Therefore, be sure to set OPERATE state.
- ③ When the ^{START} is pressed, the LED lights and the program starts.

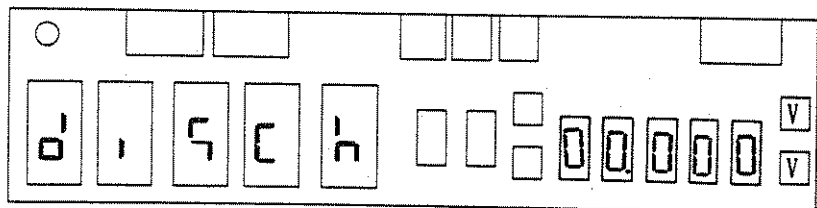

Discharge

Discharge continues for the time set by parameters. The discharge-key LED lights.

↓
A

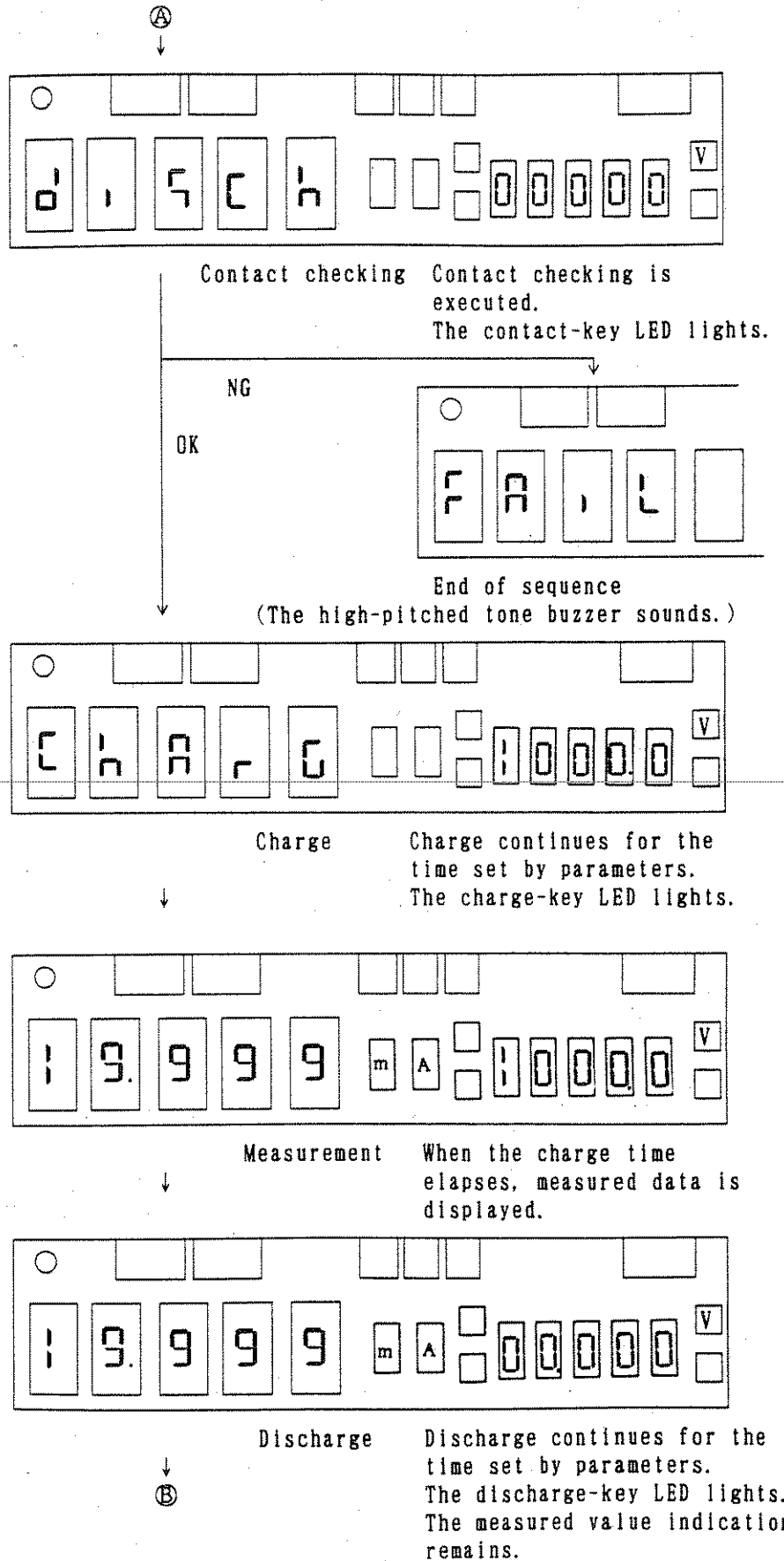

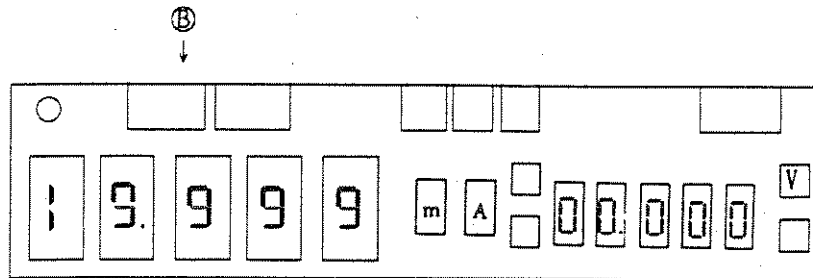



End of sequence Start-key LED goes out.
(The low-pitched tone buzzer sounds.)

The operation ends with the measured value displayed.
When the buzzer is set to ON, it sounds.

④ Cancel During Execution of Program

To cancel the program during execution of it, execute the operation as follows:

- PRGM/NORMAL
- ④-1 Press the , and the program mode is canceled and also the program is canceled.
- START
- ④-2 Press the , and the LED goes out to stop the sequence and discharge state is set. When measurement is already ended, measured data is displayed.
- OPERATE
- ④-3 Press the  to make V-SOURCE stand-by, and the sequence ends and the initial program No. is displayed.

⑤ Start/stop Using LID SIGNAL

The program can also be started or stopped with the LID SIGNAL. The program can be started or stopped by operating the lid on the fixture of the R12701 and R12704 with the signal. For detailed usage, see Section 7 "INPUT/OUTPUT SIGNALS" and Section 11 "APPLIED MEASUREMENT".

Table 5-1 shows keys effective for each mode.

Table 5-2 shows the status change of each mode.

Table 5 - 1 Keys Effective for Each Mode
(Excluding the case in which the GPIB is controlled)





| Normal measurement mode | Program mode (During stop of program) | During execution of program |
|-------------------------|--|--|
| All keys | All keys. However, the CAL  function changes. See Table 5-3. | PRGM/NORMAL  START  OPERATE  |

Table 5 - 2 Status Change of Each Mode

| | Normal measurement mode | Program mode | During execution of program |
|------------------------|-------------------------|------------------------|--|
| IM/RM | Follow the key setting | Follow the key setting | ← |
| Range | Follow the key setting | Follow the key setting | ← |
| Sampling | Follow the key setting | HOLD | HOLD |
| NULL | Follow the key setting | OFF | ← |
| COMPARE | Follow the key setting | Follow the key setting | ← |
| State | Follow the key setting | Discharge | Follow the sequence |
| V SOURCE | Follow the key setting | Follow the key setting | Follow the sequence |
| Operation/ stand-by | Follow the key setting | Follow the key setting | No execution can be made under stand-by state. |

Note: The arrow " ← " shows that the state depends on the left state

5.3 Setting of Program Parameters

Program parameters other than generated voltage value can be set because the CAL key function changes only in the program mode

(LED lights). It is also possible to set only necessary parameters according to the set program No. Set the generated voltage value and so on similarly to normal measurement. No parameter can be set during execution of the program.

The following is the initialization value of each program parameter.

- Generated voltage :0V
- Program No. :No.0
- Auto-start value :1.00pA
- Charge time :60 sec
- Discharge time :1 sec
- Measurement time :0 sec

The initialization value is obtained by executing the "power-on initialize" operation (press the immediately after turning on the power switch).

Table 5-3 shows the CAL key function in the program mode.

Table 5 - 3 CAL key Function (In program mode)

| Contents | Operation1 | Operation2 |
|---|---|--|
| 1. Setting of program No. | Press the <input type="checkbox"/> once. | PRGM No. <input type="checkbox"/> 0 <input type="checkbox"/> 1 <input type="checkbox"/> 2 <input type="checkbox"/> 3 <input type="checkbox"/> 4 <input type="checkbox"/> 5 Whenever <input type="checkbox"/> is pressed, the setting is changed over. |
| 2. Setting of auto-start value (PRGM No.4 only) | Press the <input type="checkbox"/> twice. | A. STAT Set data with numerical keys. |
| 3. Setting of charge time | Press the <input type="checkbox"/> three times. (For PRGM No.4) Press the <input type="checkbox"/> twice. (Other than PRGM No.4) | CHARG T Set data with numerical keys. |

Table 5 - 3 CAL key Function (In program mode) (Cont'd)

| Contents | Operation1 | Operation2 |
|---|--|--|
| 4. Setting of discharge time (Other than PRGM No. 0) | Press the ^{CAL} <input type="checkbox"/> four times. (For PRGM No. 4) Press the ^{CAL} <input type="checkbox"/> three times. (Other than PRGM No. 4) | DISCH T Set data with numerical keys. |
| 5. Setting of measurement time (PRGM No. 5 only) | Press the ^{CAL} <input type="checkbox"/> five times. | MEAS T Set data with numerical keys. |
| 6. When the ^{CAL} <input type="checkbox"/> is pressed again, the state returns to "1". | | |

(1) How to Set Program No.

Operation (① through ④)

① Press the ^{PRGM/NORMAL} to set the program mode (LED lights).

② Press the ^{CAL} once.

③ Press the ^{CHANGE} to set the required program No.

Whenever the ^{CHANGE} is pressed, the setting is changed over.

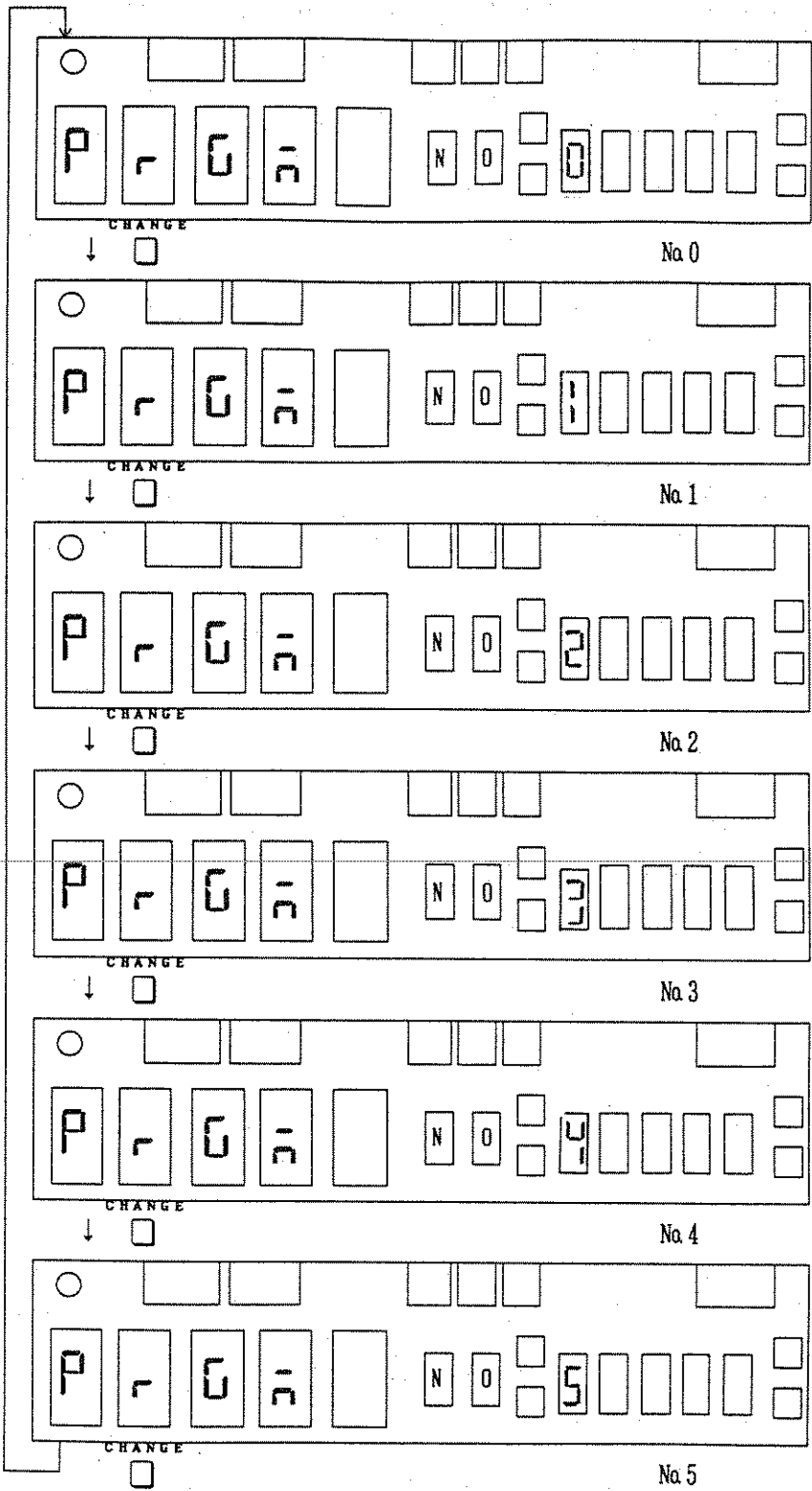

④ When the is pressed, the setting ends.

(2) How to Set Auto-start Value (Program No.4 only)

Operation (① through ④)

- ① Press the ^{PRGM/NORMAL} to set the program mode (LED lights).
- ② Select the program No.4 in the above Item (1).
- ③ Press the ^{CAL} twice.

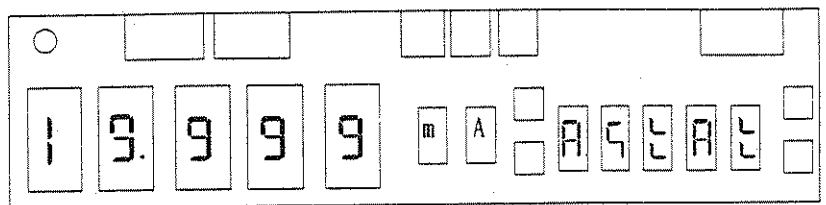

Present set value

- ④ Set a value according to the procedure in Item 4.4.1 "Upper level".

CAUTION

1. The auto-start value setting range is -19.999mA to +19.999mA. If a value exceeding the above range is set, an error occurs when the ^{EXIT} is pressed.
2. If you input an incorrect value, press the _{CE}. Then the preceding set value appears and you can input a new value.
3. The auto after function start for $|IM| \leq |set\ value|$.
4. If a small auto-start value such as 0.00pA is set, discharge state may continue for a long time.

(3) How to Set Charge Time

Operation (① through ④)

- ① Press the ^{PRGM/NORMAL} to set the program mode (LED lights).
- ② Press the ^{CAL} twice if a program other than the program No.4 is set or three times if the program No.4 is set.
- ③ Change the present set value to the required set value. To change the to setting to 12.345 set, for example:

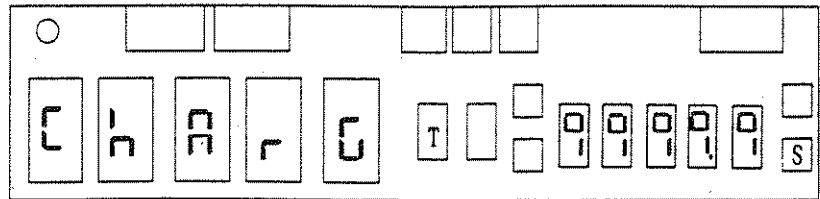

↓ Press the ₁ ₂ ₃ ₄ and ₅.

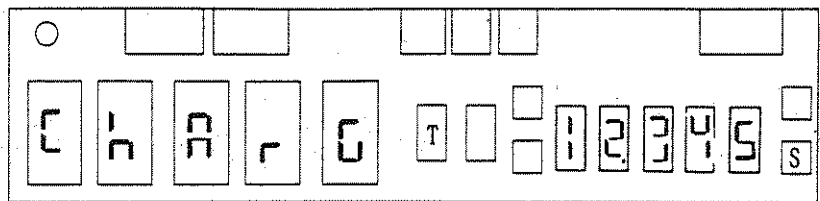

- ④ When the ^{EXIT} is pressed, the setting ends.

CAUTION

1. The charge-time setting range is 00.000 to 9999.9 sec. If a value exceeding the above range is set, an error occurs.
2. If you input an incorrect value, press the _{CE}. Then the preceding set value appears and you can input a new value.

(4) How to Set Discharge Time

Operation (① through ④)

- ① Press the ^{PRGM/NORMAL} to set the program mode (LED lights).
- ② Press the ^{CAL} three times if a program other than the program No.4 is set or four times if the program No.4 is set.
- ③ Change the present set value to the required set value.
To change the setting to 12.345 sec, for example:

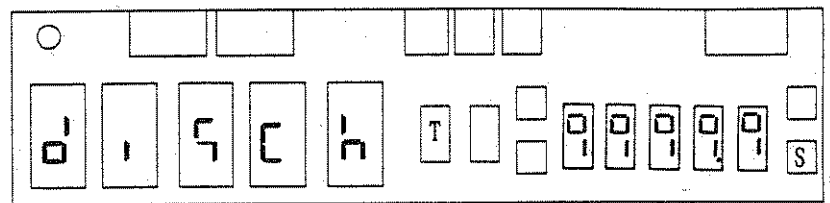

Present set value

↓ Press the and .

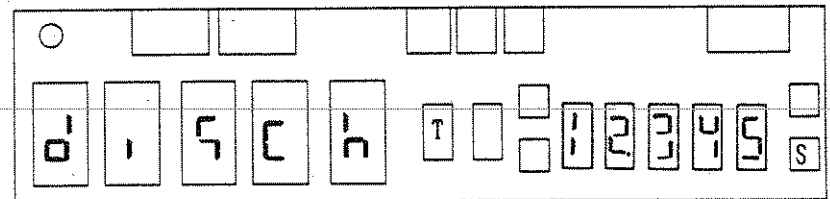

- ④ When the ^{EXIT} is pressed, the setting ends.

CAUTION

1. The discharge-time setting range is 00.000 to 9999.9 sec. If a value exceeding the above range is set, an error occurs when the ^{EXIT} is pressed.
2. If you input an incorrect value, press the ^{CE} . Then the preceding set value appears and you can input a new value.

(5) How to Set measurement time (Program No. 5 only)

Operation (① through ⑤)

- ① Press the ^{PRGM/NORMAL} to set the program mode (LED lights).
- ② Select the program No.5 in the above Item (1).
- ③ Press the ^{CAL} four times.
- ④ Change the present set value to the required set value.
To change the setting to 12.345 sec. for example:

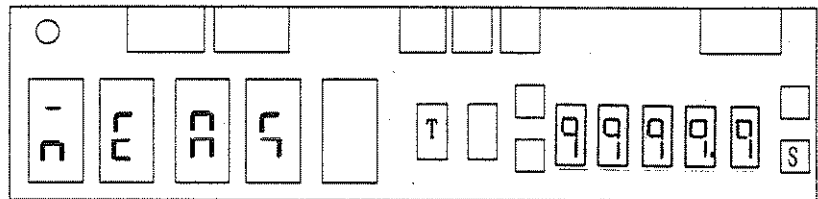

Present set value

↓ Press the ₁ ₂ ₃ ₄ and ₅.

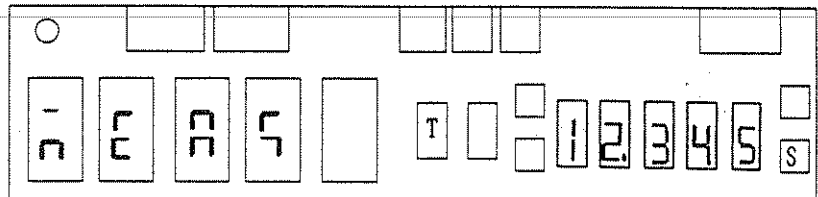

- ⑤ When the ^{EXIT} is pressed, the setting ends.

CAUTION

- The Measurement time setting range is 0 to 9999.9 sec. If a value exceeding the above range is set, an error occurs when the ^{EXIT} is pressed.
- If you input an incorrect value, press the _{CE}. Then the preceding set value appears and you can input a new value.

5.4 Sequence Program Operation Example

The following example describes sequence program operations from sample connection to end of program.

Example 1 Resistance measurements using program 0, 1 and 2

| | | |
|--------------|----------------|--|
| Requirements | IM/RM | RM (Resistance measurement) |
| | RANGE | AUTO |
| | VS | 25V |
| | Integral time | 5PLC |
| | GAIN | $\times 10000$ |
| | Charge time | 30 seconds |
| | Discharge time | 60 seconds (except program 0) |
| | Other settings | The same as during power on initialization |

(1) Input Cable Connections

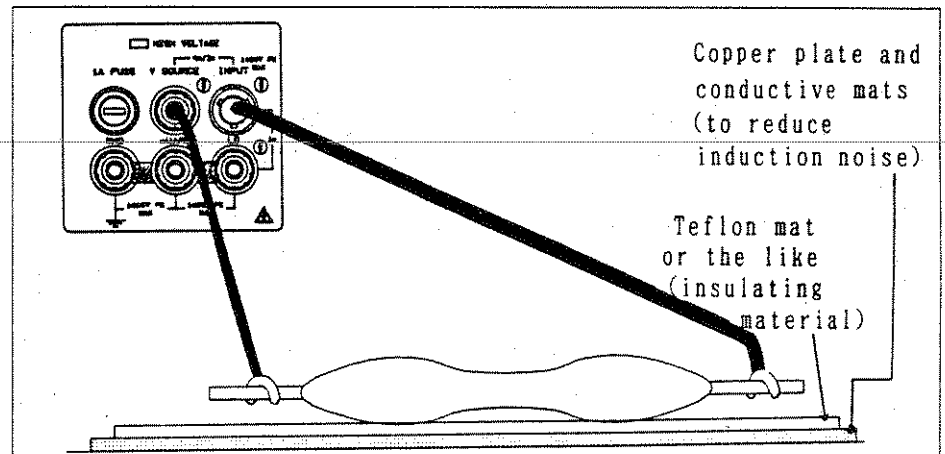

A shielding plate or shielding box is required when the measured current is 10^{-8} A or less since the meter is particularly susceptible to induction noise in this range.

(2) Resistance Measurement

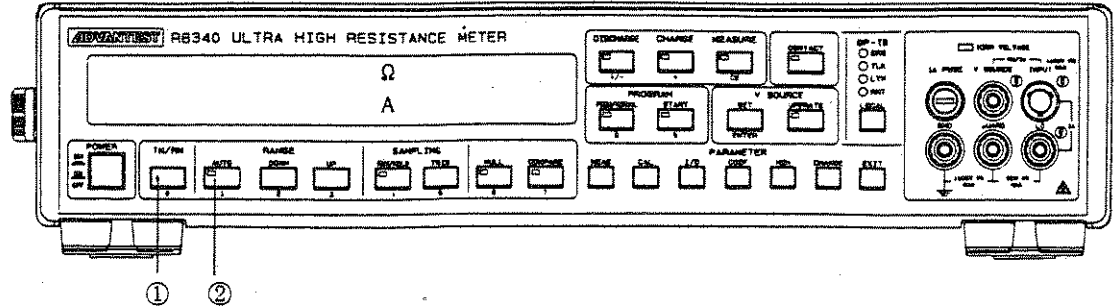

- ① Press ^{IM/RM} to display the ohm mark.
- ② Set the instrument to auto range by pressing ^{AUTO}. Make sure that the key LED goes on.

(3) Applied Voltage Setting (25V)

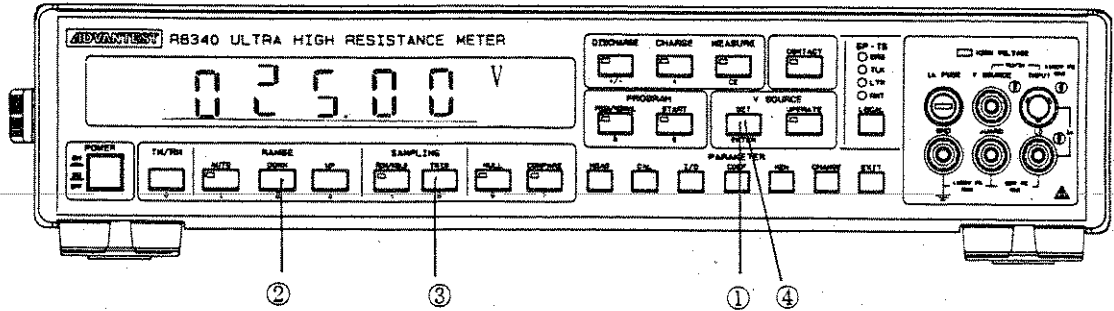

Press ① ^{SET} ② ③ and ④ ^{ENTER} to display 025.00V.

(4) Integral Time Setting

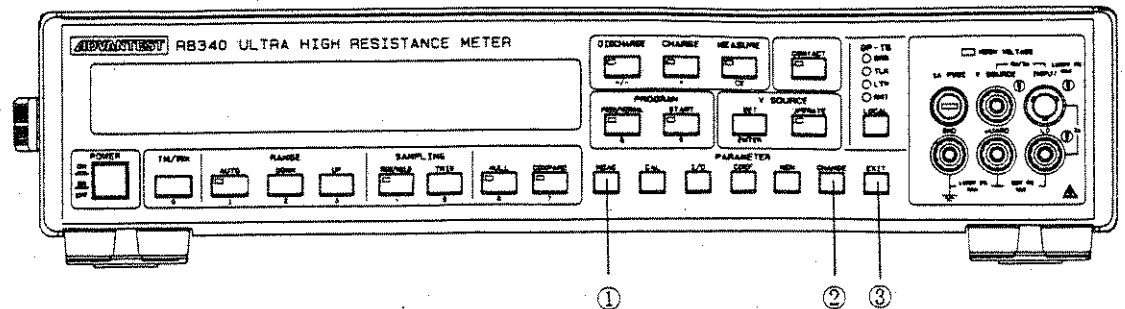

MEAS CHANGE
Press ① and ② to set 5PLC.

EXIT
Press ③ to cancel or terminate the setting.

(5) Gain Measurement

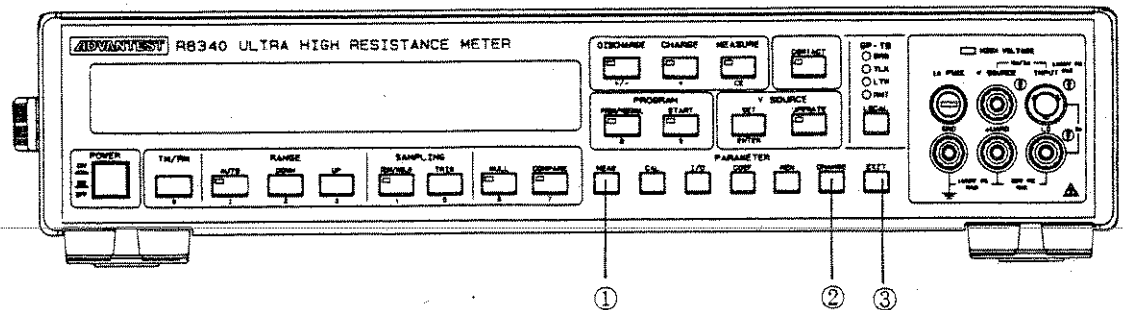

MEAS
Press ① three times and set the meter to $\times 10000$ with

CHANGE
②

EXIT
Press ③ to cancel or terminate the setting.

(8) Discharge Setting

Note : This setting cannot be made in program No. 0.

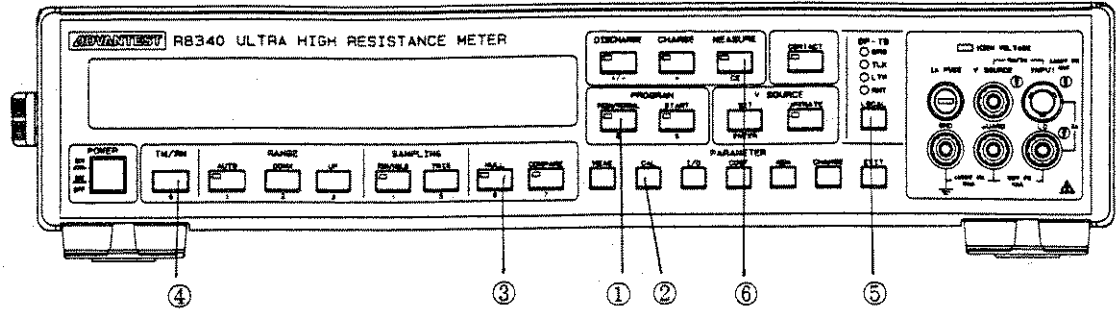

PRGM/NORMAL
 Press ① and make sure that the key LED goes on.

CAL
 Press ② three times.

EXIT
 Press ③ ④ ⑤ .

MEASURE
 The previous setting is redisplayed when ⑥ is pressed while a setting is made.

(9) Setting Sequence Program No. 0

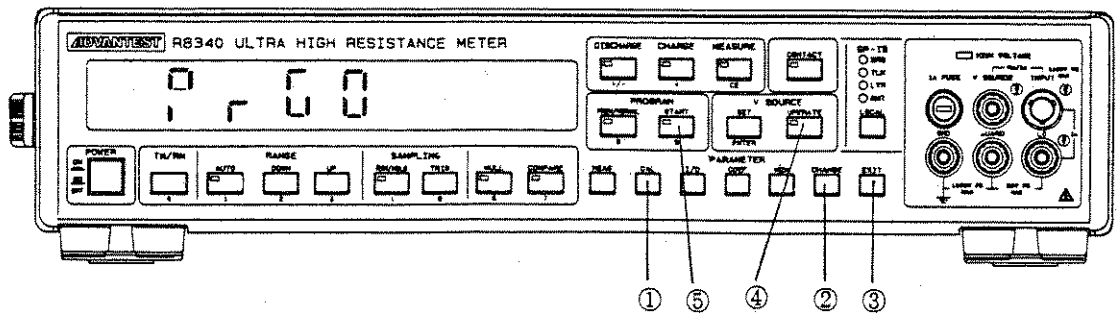

Make sure that "0 r 00" is displayed. If not, press

CAL CHANGE EXIT
 ① and ② to make the setting. Then press ③ .

OPERATE START
 Press ④ and ⑤ .

(10) Setting Sequence Program No.1 and 2

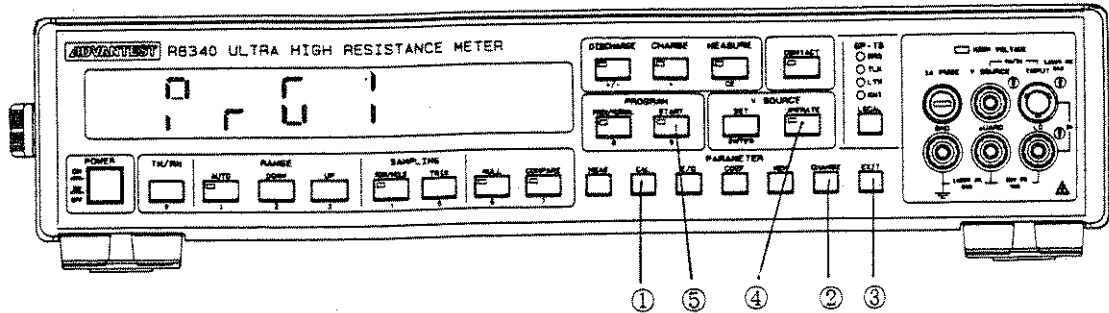

Make sure that "1.201" or "1.202" is displayed. If not, press ① and ② to set 1 or 2.
 Press ③ .

If the previous setting was "1.200" or the like, perform procedures (6) and (8) to set the time of the disk.
 Press ④ and ⑤ .

Example 2 Measuring insulation resistance between capacitor terminals using program No.3

| Requirements | IM/RM | RM (Resistance measurements) |
|--------------|-------------------------|--|
| | RANGE | AUTO |
| | VS | 100V |
| | Integral time | 10PLC |
| | GAIN | × 10 |
| | Autorange UP/DOWN level | 2000 |
| | Charge time | 60 seconds |
| | Discharge time | 120 seconds |
| | Other settings | The same as during power on initialization |

(1) Input Cable Contact

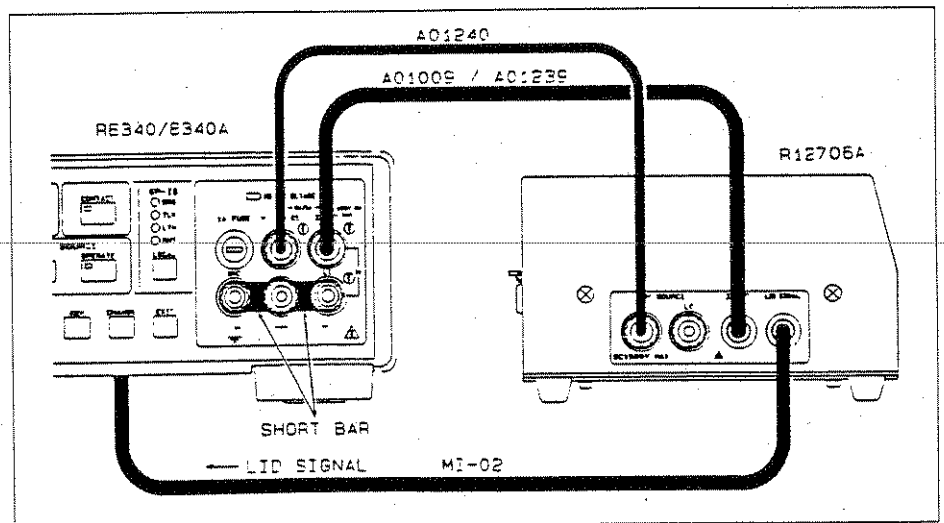

The voltage to be measured in a measurement of the insulation resistance between capacitor terminals is extremely small and therefore susceptible to induction noise. Use of the R12701 or R12706A test fixture are recommended. Since a contact check is made in the program No.3 sequence, a contact initialization offset measurement (See Section 4.3.2) and contact initialization measurement (See Section 4.3.3) should be made before starting this sequence.

(2) Resistance Measurement Setting

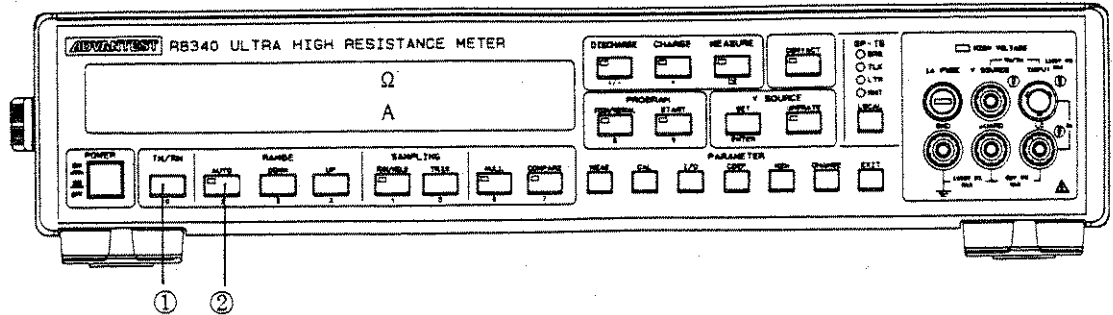

Press ① to display the ohm mark.

Press ② to make auto range setting. Make sure that the LED goes on.

(3) Setting the Applied Voltage (100V)

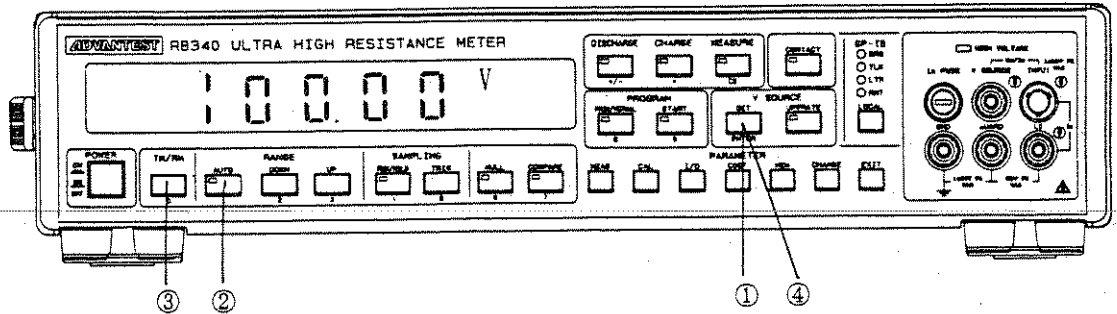

Press ① ② ③ ③ and ④ to display 100.00V.

(4) Integral Time Setting

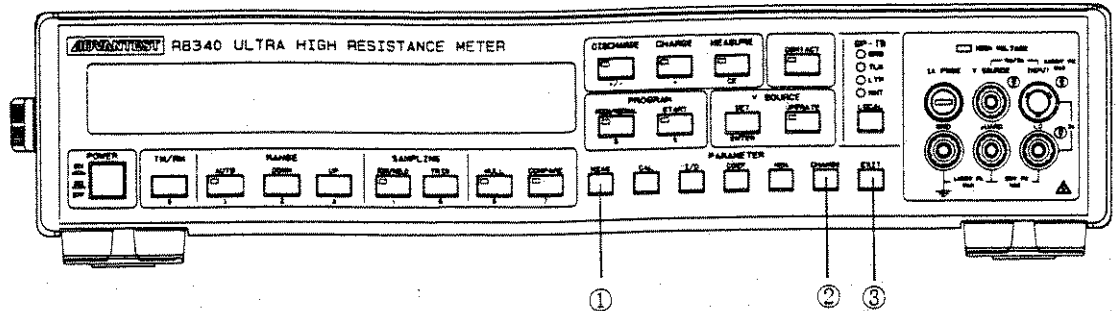

Press ① MEAS and ② CHANGE to set 10PLC.

Press ③ EXIT to cancel or terminate the setting.

(5) Gain Setting

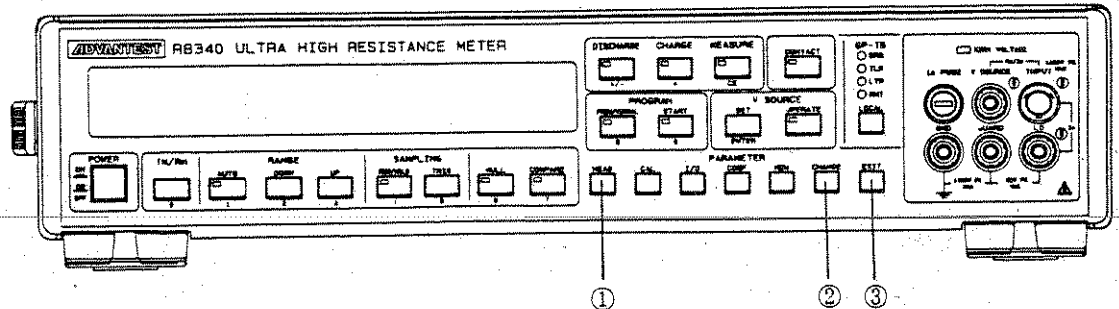

Press ① MEAS three times and use ② CHANGE to set $\times 10$.

Press ③ EXIT to cancel or terminate the setting.

(6) Autorange UP/DOWN Level Setting

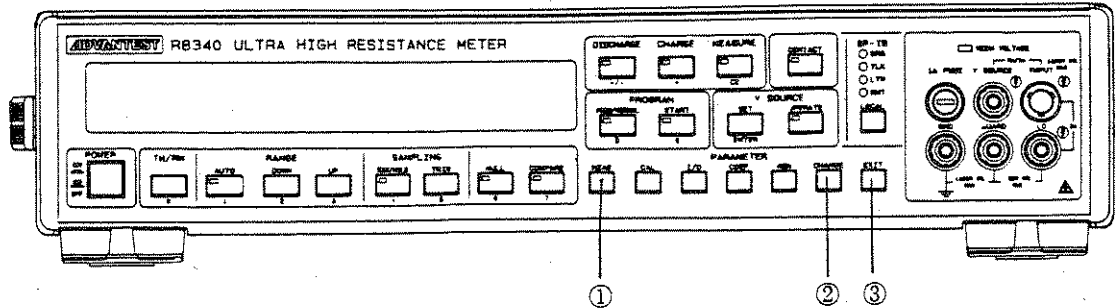

MEAS CHANGE
 Press ① five times and use ② to set 2000.
 EXIT
 Press ③ to cancel or terminate the setting.

(7) Program No. Setting

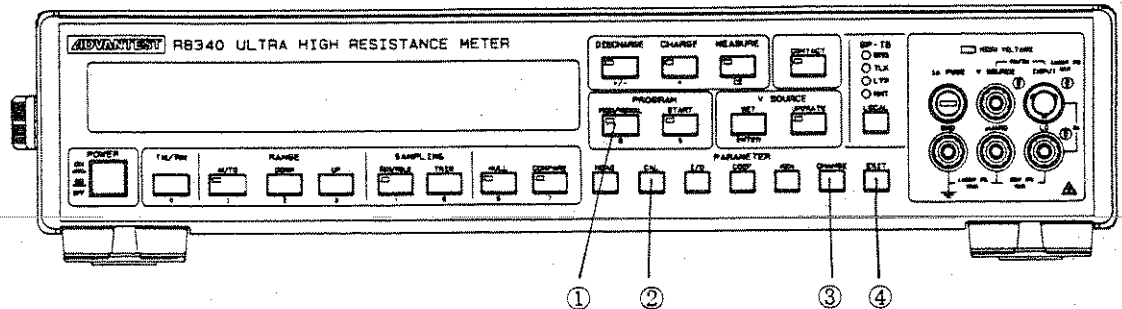

PRGM/NORMAL
 Press ① and make sure that the key LED goes on.
 CAL CHANGE
 Press ② . Use ③ to set 3.
 EXIT
 Press ④ to cancel or terminate the setting.

(8) Charge Time Setting

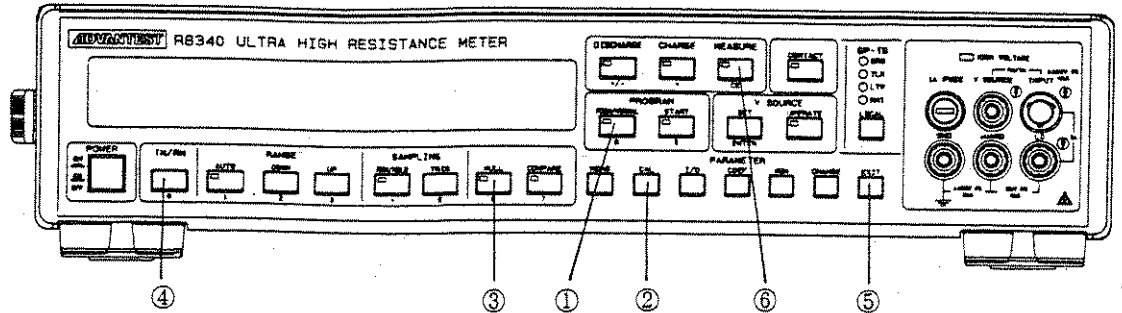

Press ① and make sure that the key LED goes on.

Press ② twice. Press ③ ④ and ⑤ .

Previously set values are displayed when ⑦ is pressed during setting.

(9) Discharge Time Setting

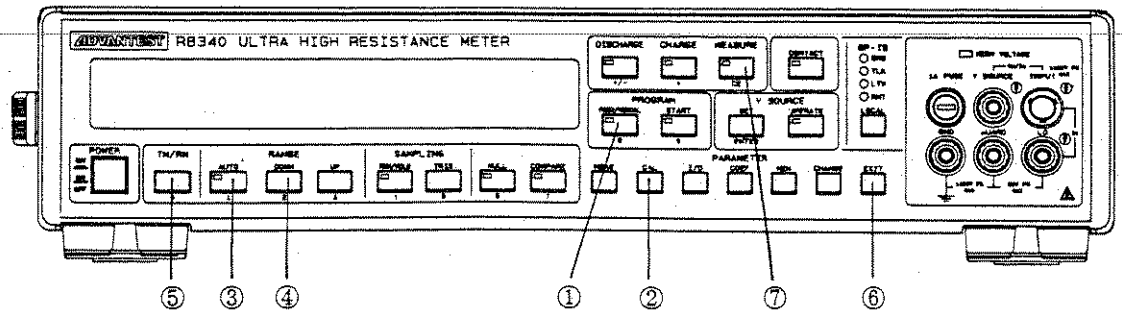

Press ① and make sure that the key LED goes on.

Press ② three times. Press ③ ④ ⑤ and .

Previously set values are displayed when ⑦ is pressed during setting.

(10) Sequence Program No. 3 Measurements

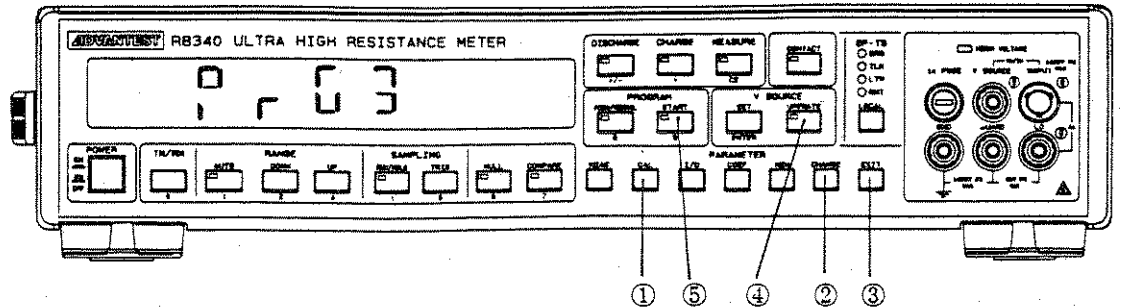

Make sure that "0.03" is displayed. If not, press

① CAL and ② EXIT to set 3. Then press ③ OPERATE.

Press ④ CHANGE and ⑤ START.

Example 3 Surface resistivity measurement of sheet samples using program No. 4

| | | |
|--------------|----------------------------|--|
| Requirements | IM/RM | RM (Resistance measurement) |
| | Display | Surface resistivity |
| | Diameter of main electrode | 50 ϕ |
| | RANGE | AUTO |
| | VS | 500V |
| | Integral time | 10PLC |
| | GAIN | $\times 10$ |
| | Unit display | Exponents |
| | Automatic start value | 10PA |
| | Charge time | 60 seconds |
| | Discharge time | 60 seconds |
| | Other settings | The same as during power on initialization |

(1) Input Cable Connections

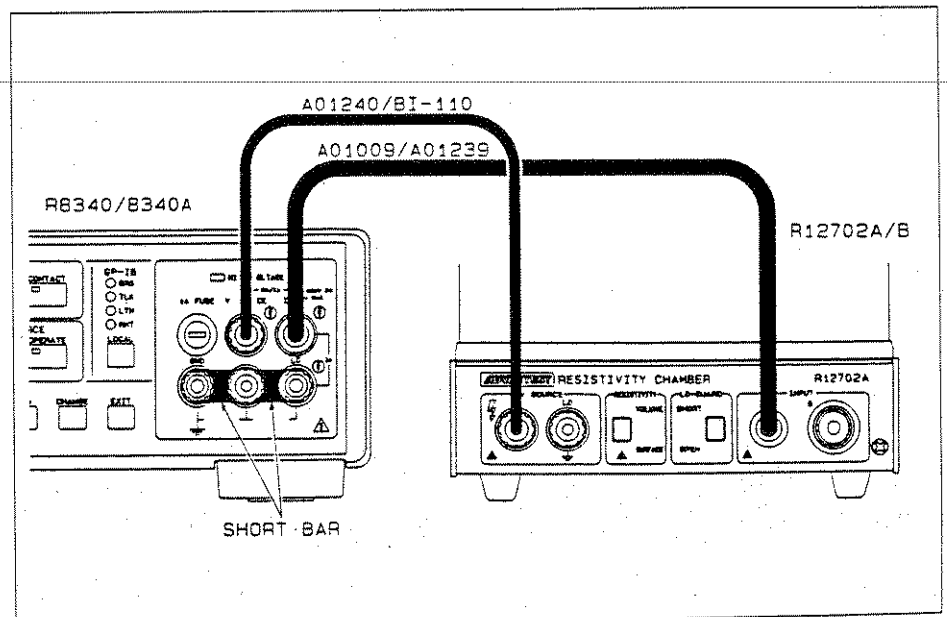

The R12702A/B, R12704, TR42 and TR43C allow surface resistivity measurements and volume resistivity measurements of sheet samples.

When the R12702A/B or R12704 are used, set to SURFACE (surface resistivity). When the TR42 and TR43C, use the short bar to set to SURFACE (surface resistivity).

(2) Setting Resistance Measurement

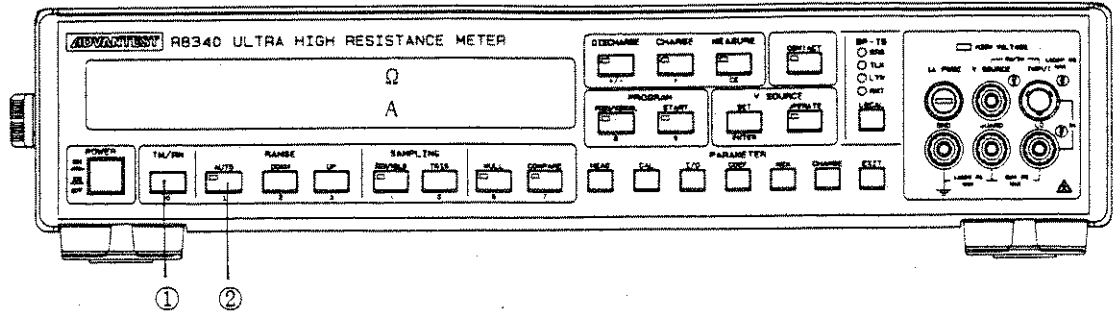

Press ① IM/RM to display the ohm mark.

Press ② AUTO and make sure that the key LED goes on.

(3) Applied Voltage Setting (500V)

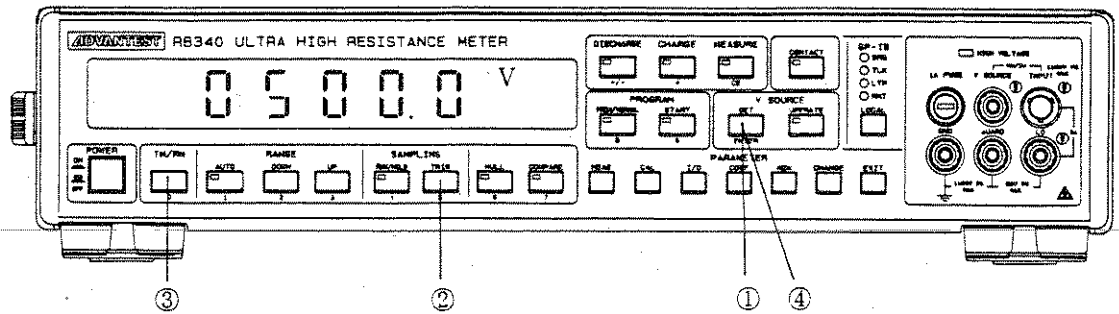

Press ① 5 ② 0 ③ 0 ③ 0 and ④ ENTER to display 0.500.0V.

(4) Integral Time Setting

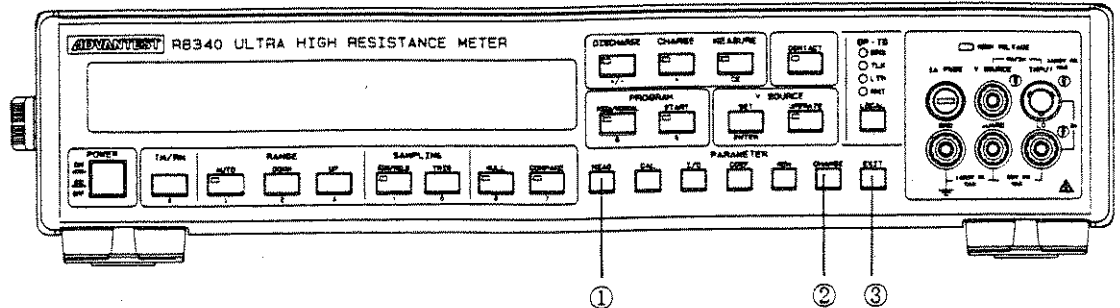

MEAS CHANGE
Press ① and ② to set 10PLC.

EXIT
Press ③ to cancel or terminate the setting.

(5) Gain Setting

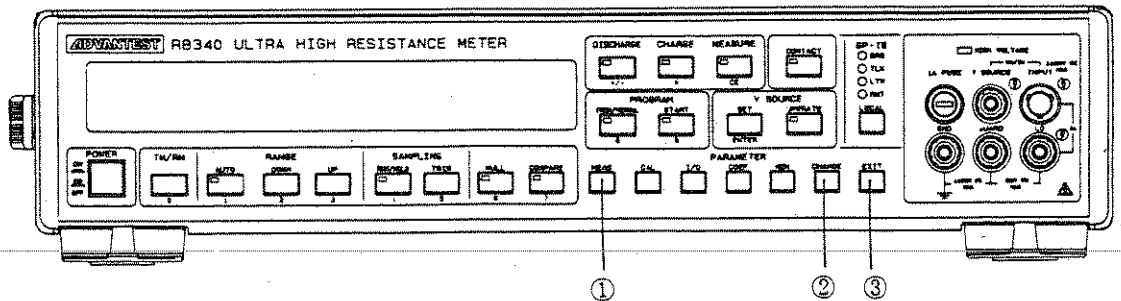

MEAS CHANGE
Press ① three times and use ② to set $\times 10$.

EXIT
Press ③ to cancel or terminate the setting.

(6) Setting Exponent Unit Display

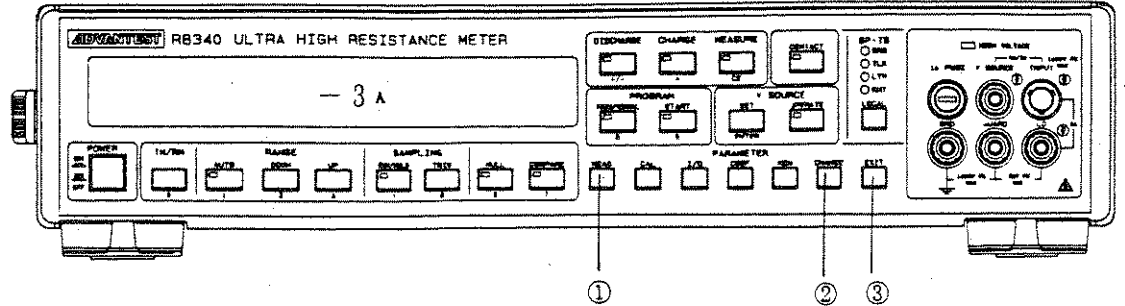

MEAS CHANGE
 Press ① six times and set -3A with ② .
 EXIT
 Press ③ to cancel or terminate the setting.

(7) Surface Resistivity Display Setting

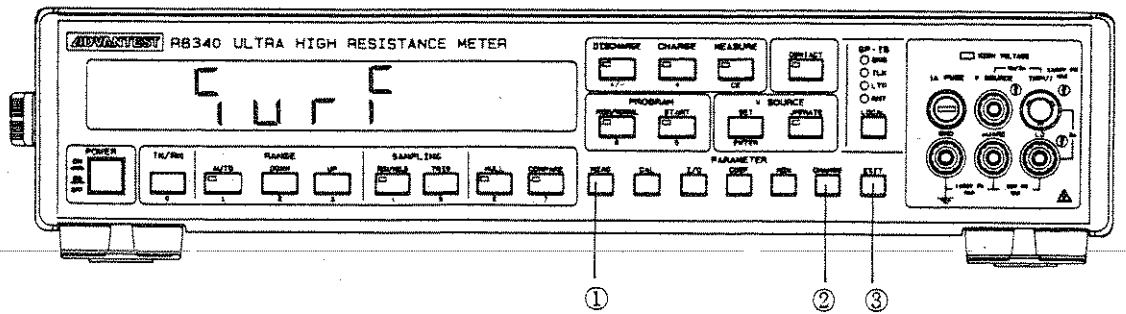

COEF CHANGE
 Press ① three times and ② to set "SURF"
 (surface resistivity)
 EXIT
 Press ③ to cancel or terminate the setting.

(8) Electrode Diameter Setting

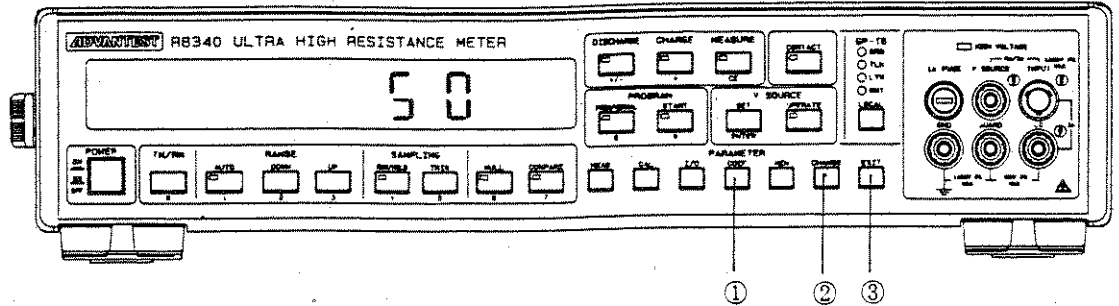

Press ① COEF four times and use ② CHANGE to set to 50.
 Press ③ EXIT to cancel or terminate the setting.

(9) Program No. Setting

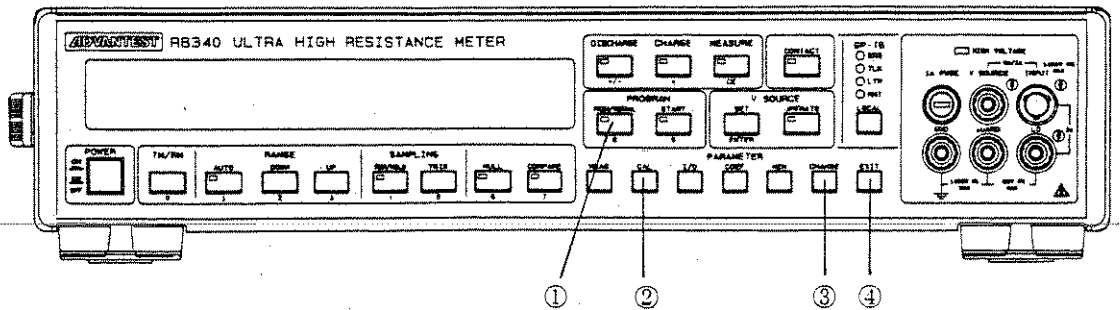

Press ① PRGM/NORMAL and make sure that the key LED goes on.
 Press ② CAL. Use ③ CHANGE to set 4.
 Press ④ EXIT to cancel or terminate the setting.

(10) Automatic Start Value Setting (10pA)

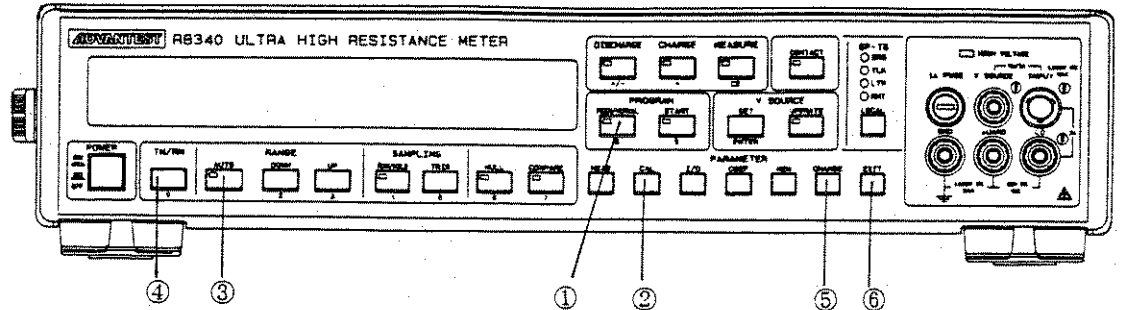

PRGM/NORMAL
Press ① and make sure that the key LED goes on.

CAL
Press ② twice. Press ③ ④ and use ⑤ CHANGE
to set the range to 10.00pA. Then press ⑥ EXIT

(11) Charge Time Setting

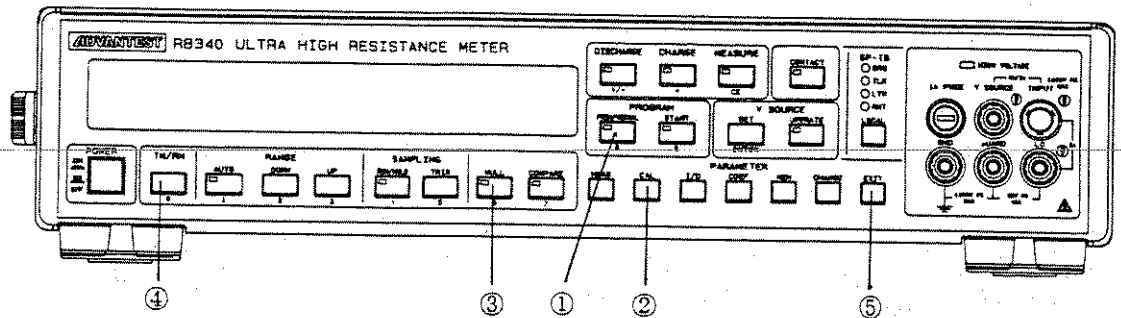

PRGM/NORMAL
Press ① and make sure that the key LED goes on.

CAL
Press ② three times.

Press ③ ④ and ⑤ EXIT

(12) Discharge Time Setting

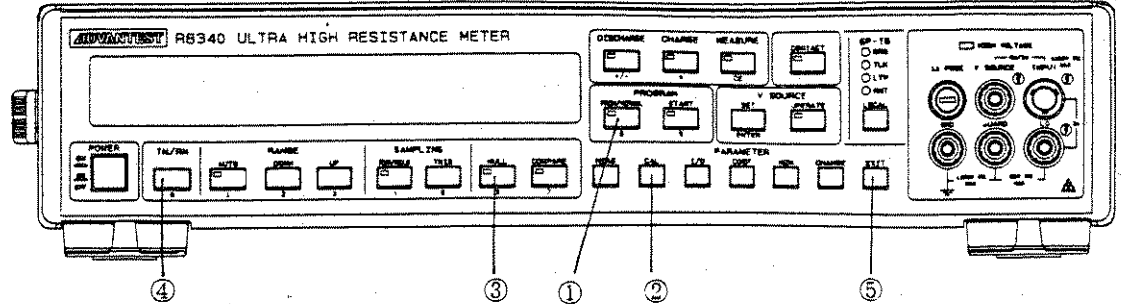

Press ① and make sure that the key LED goes on.
 Press ② four times. Press ③ ④ and ⑤

(13) Sequence Program No. 4 Measurements

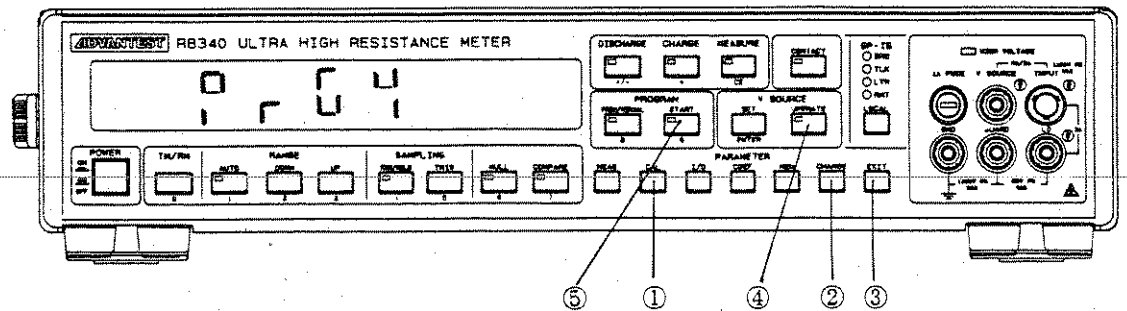

Make sure that "P r 0 4" is displayed. If not, press ① and ② to set 4. Then press ③ .

Press ④ and ⑤ .

Example 4 Measuring insulation resistance between capacitor terminals using program No.5

| Requirements | IM/RM | RM (Resistance measurement) |
|--------------|-------------------------|--|
| | RANGE | AUTO |
| | VS | 160V |
| | Integral time | 10PLC |
| | GAIN | ×1 |
| | Autorange UP/DOWN level | 200 |
| | Autorange delay | 2 seconds |
| | Charge time | 30 seconds |
| | Discharge time | 120 seconds |
| | Measuring time | 30 seconds |
| | Other settings | The same as during power on initialization |

(1) Input Cable Connections

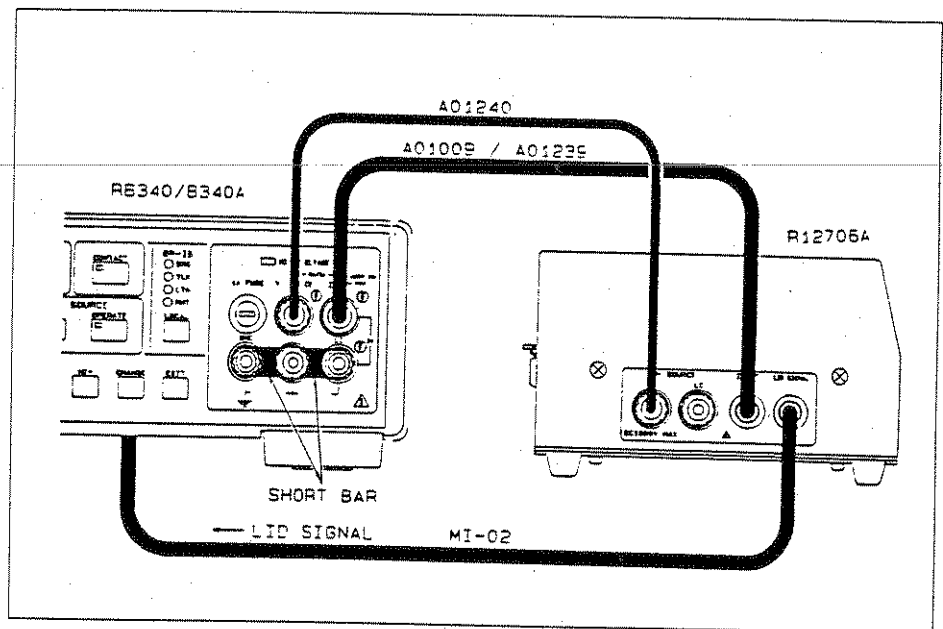

When the capacity of the sample is of the order of μF , the input resistance and capacity lengthens the time constant so much that the ranging function cannot operate normally leading to errors in the measurements made after charging. In order to prevent ranging error operation, reduce the auto range UP/DOWN level lower the input resistance and enter an auto range delay. When program No.5 is used, perform internal sampling after charging to set optimum range to ensure highly accurate measurement results.

(2) Resistance Measurement Setting

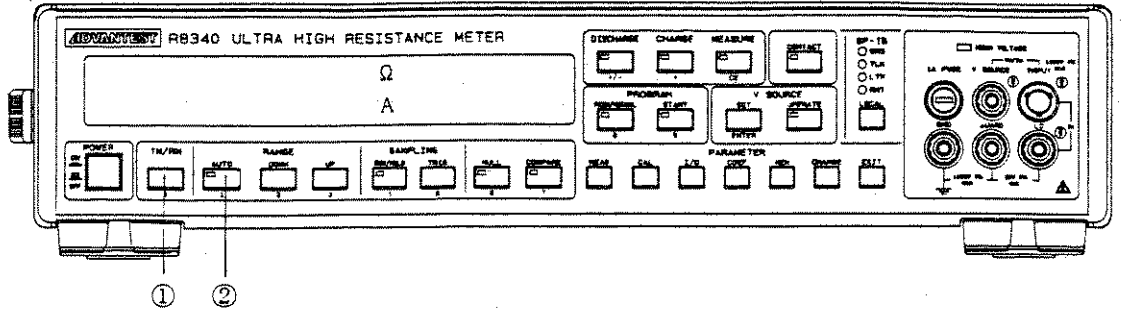

Press ① I/M/RM to display the ohm mark.

Press ② AUTO and make sure that the LED goes on.

(3) Setting the Applied Voltage (160V)

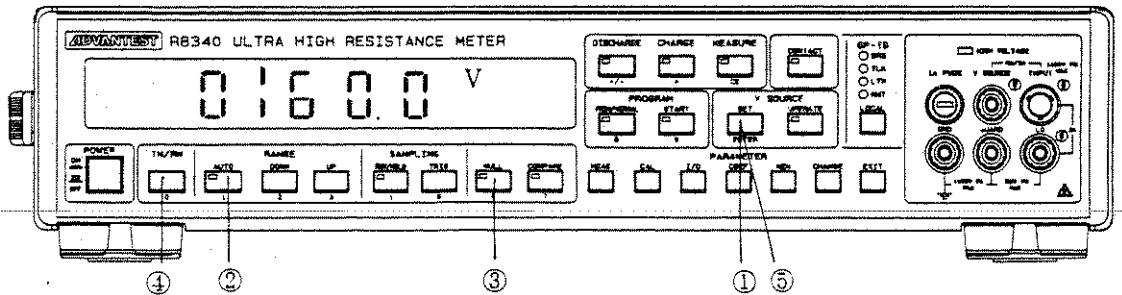

Press ① SET ② 1 ③ 6 ④ 0 and ⑤ ENTER to display 0160.0V.

(4) Integral Time Setting

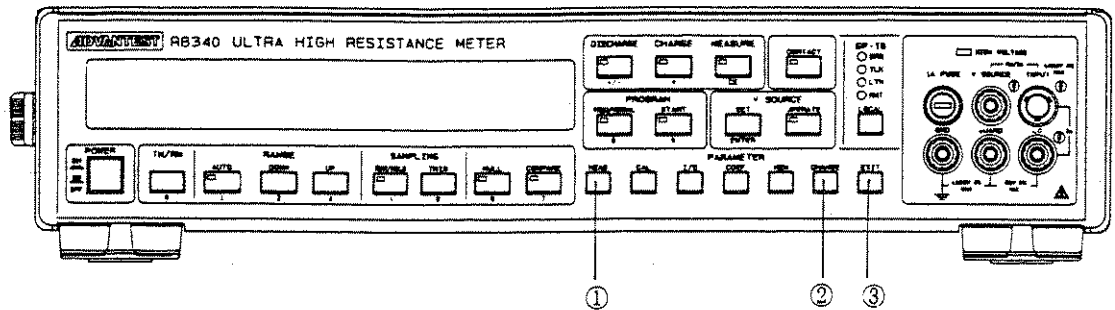

MEAS CHANGE
 Press ① and ② to set 10PLC.
 EXIT
 Press ③ to cancel or terminate the setting.

(5) Gain Measurement

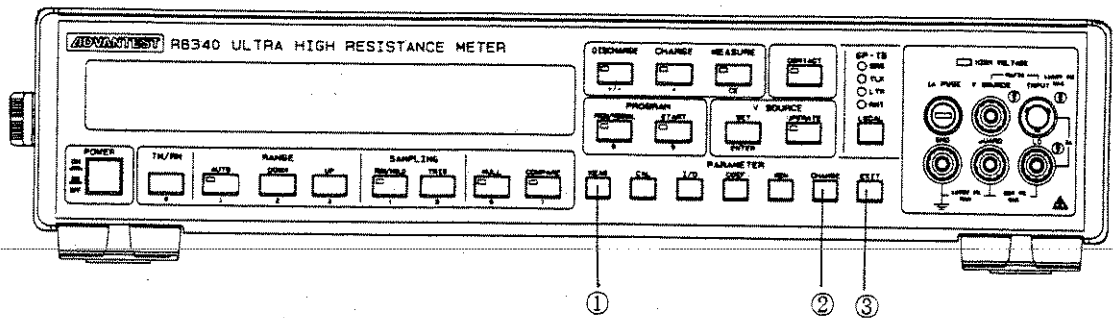

MEAS
 Press ① three times and set the meter to $\times 1$ with
 CHANGE
 ② .
 EXIT
 Press ③ to cancel or terminate the setting.

(6) Autorange UP/DOWN Level Setting

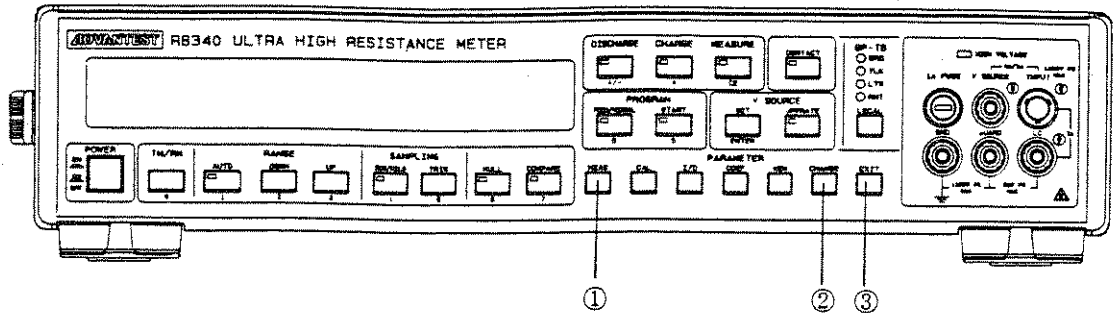

Press ① MEAS five times and use ② CHANGE to set 200.

Press ③ EXIT to cancel or terminate the setting.

(7) Autorange Delay Setting

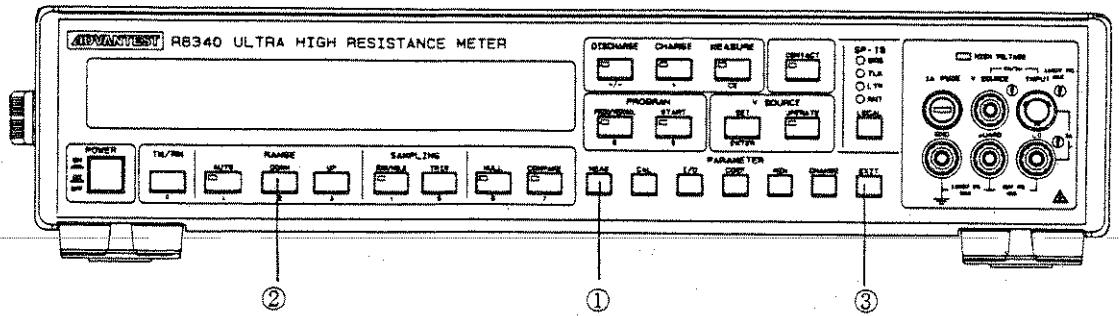

Press ① MEAS eight times and ② RANGE.

Press ③ EXIT to cancel or terminate the setting.

(8) Program No. Setting

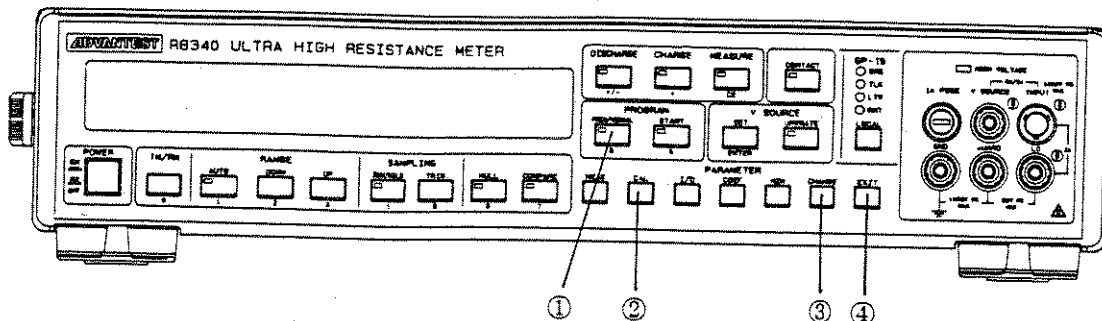

PRGM/NORMAL
 Press ① and make sure that the key LED goes on.
 CAL CHANGE
 Press ② . Use ③ to set 5.
 EXIT
 Press ④ to cancel or terminate the setting.

(9) Charge Time Setting

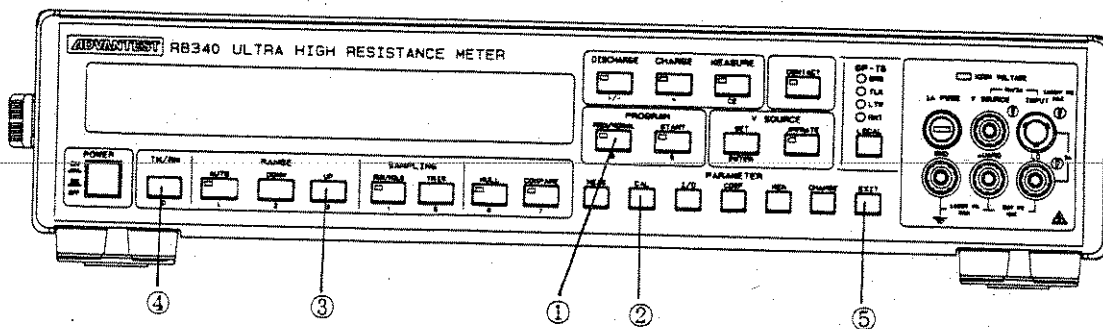

PRGM/NORMAL
 Press ① and make sure that the key LED goes on.
 CAL
 Press ② twice. Press ③ ④ and ⑤ .

(10) Discharge Time Setting

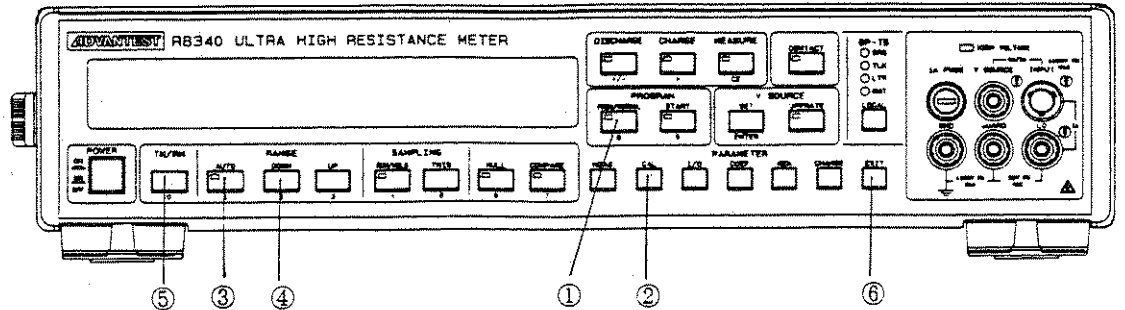

PRGM/NORMAL
 Press ① and make sure that the key LED goes on.

CAL
 Press ② three times.

EXIT
 Press ③ ④ ⑤ and ⑥ .

(11) Setting the Measurement Time

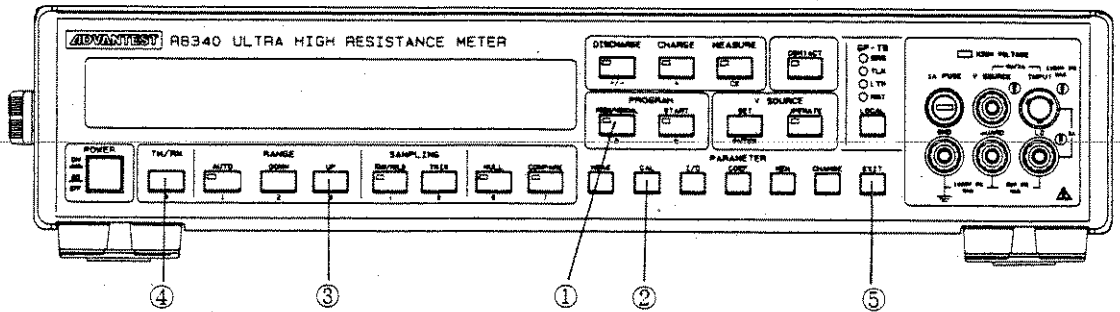

PRGM/NORMAL
 Press ① and make sure that the key LED goes on.

CAL
 Press ② four times, then press ③ ④ and
 EXIT
 ⑤ .

(2) Sequence Program Measurement

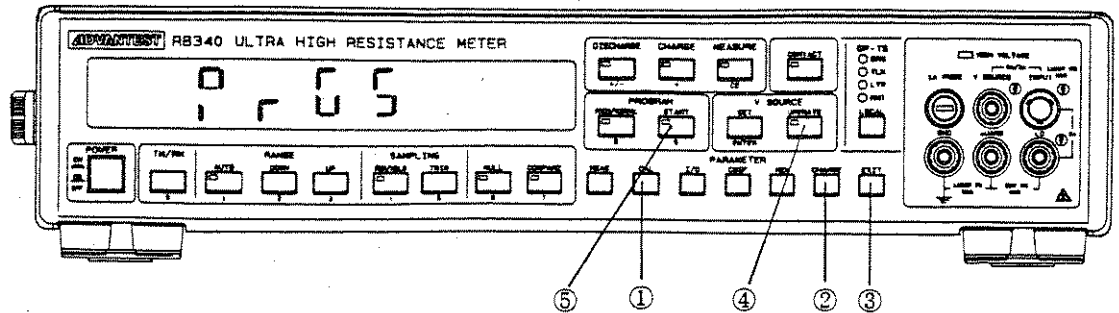

Check that "0.05" is displayed. If not, press ① and ② to display "0.05". Then press ③ . Then press ④ and ⑤ .

6. GPIB INTERFACE

This section describes control of the meter with the GPIB.

6.1 Outline

The GPIB interface is used to connect the meter with the measuring bus based on the IEEE488-1978.

The meter is normally equipped with the GPIB interface, easily configuring a measuring system storing the GPIB using personal computers. Therefore, measurement automation and data processing can be easily realized. Because the remote program through the GPIB can control almost all set items given to the meter panel switch, the interface can correspond to wide applications.

6.2 GPIB Standard

Standard used : IEEE Standard 488-1978
Code used : ASCII code
Connector pin arrangement :

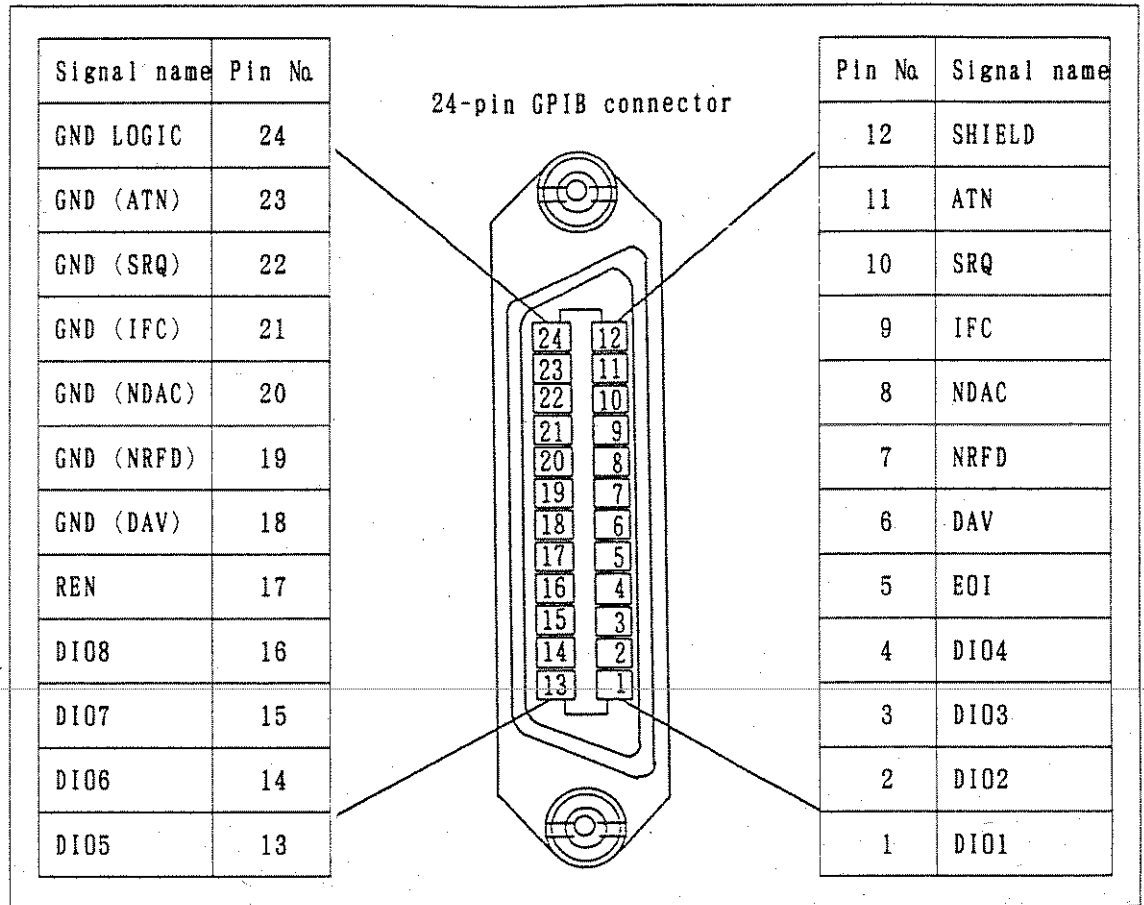

Figure 6 - 1 GPIB Connector Pin Arrangement

Logic level : Logic 0(HIGH state) +2.4V or higher
Logic 1(Low state) +0.4V or lower
Signal conductor termination: Sixteen bus lines are terminated as shown in Figure 6-2.

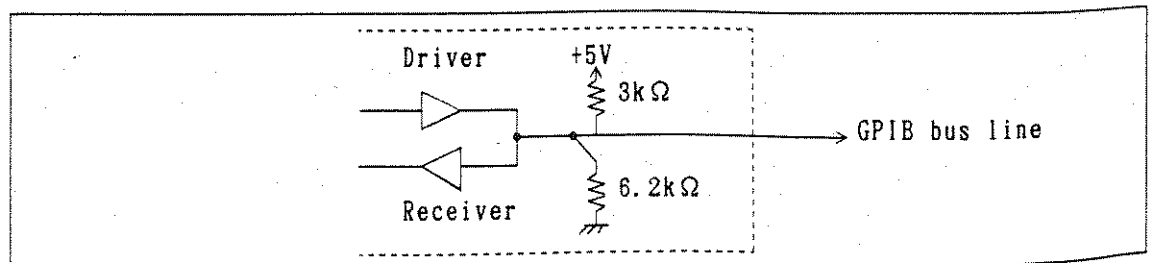

Figure 6 - 2 Signal Conductor Termination

- Driver specification: Tristate system
 Low-state output voltage: +0.4V or lower 48mA
 High-state output voltage: +2.4V -5.2mA
- Receiver specification: Low state for +0.6V or lower
 High state for +2.0V or higher
- Bus cable length : The overall bus cable length should be
 (number of units connected to bus) × 2m or
 less and must not exceed 20m.
- Addressing : Talk address and listen address of 31 types
 can optionally be set according to the GPIB
 address setting on the front panel.
- Interface function : Table 6-1 shows interfaces and their functions.

Table 6 - 1 Interfaces and Their Functions

| Code | Function |
|------|---|
| SH1 | Source handshake function |
| AH1 | Acceptor handshake function |
| T5 | Basic talker function, Talk-only mode function, Serial polling function, Listener-designated talker cancel function |
| L4 | Basic listener function, Talker-designated listener cancel function |
| SR1 | Service request function |
| RL1 | Remote/local changeover function |
| PPO | With no parallel polling function |
| DC1 | Device clearing function ("SDC" and "DCL" commands can be used.) |
| DT1 | Device trigger function ("GET" command can be used.) |
| CO | With no controller function |
| E2 | Tristate output |

6.3 Connection with Component Units

Because the GPIB system consists of several units, configure the system by paying attention to the following points.

Precautions for configuring the system

- (1) Check the condition (preparation) and operation of each unit before connection according to the operation manual of the meter, controller, and peripheral equipment.
- (2) Minimize the length of cables connecting with measuring instruments and bus cables connecting with controllers. Keep the cable length at 20m or less.
We prepare the cables in Table 6-2 as the standard bus cable.

Table 6 - 2 Standard Bus Cable

| Length | Name |
|--------|-----------|
| 0.5m | 408JE-1P5 |
| 1m | 408JE-101 |
| 2m | 408JE-102 |
| 4m | 408JE-104 |

- (3) Bus cable connectors are the piggyback type, which can be used by overlapping them because one connector has a male and female connectors.
When connecting the bus cables, do not overlap three or more cables. Be sure to secure them with connector setscrews.
- (4) Check the power condition, earthing state, and, if necessary, setting condition of each component unit before turning it on. Be sure to turn on every unit connected to the bus. If any unit is not turned on, the operation of the whole system may not be guaranteed.

6.4 Address Setting and Header on/off Selection

Perform the GPIB talk/listen addressing and header on/off selection with the panel key on the meter. For addressing and header setting, see Item 4.5.3 "GPIB". It is possible to set the header to ON or OFF using an external controller.

6.5 Talker Specification (Data Output)

6.5.1 Basic Format

Basic Format

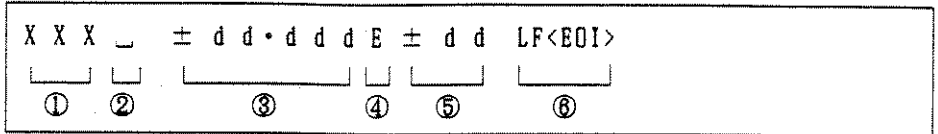

① Header

For header OFF, no space is given before the mantissa part of data but data is left-justified.

Three digits (The third digit is a sub-header.)

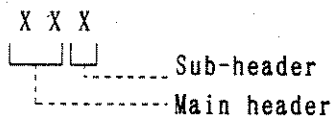

Main Header

DI: DC measurement
 RM: Resistance measurement
 RV: Volume resistivity
 RS: Surface resistivity

Sub-header

O : Over-range *
 D : Data after NULL operation.
 H : COMPARE-operation result "HI"
 G : COMPARE-operation result "GO"
 L : COMPARE-operation result "LO"
 E : Measured data error *
 M : Data when VS is caught by the current limiter
 _ : Cases other than the above

*: For the above "O" and "E", both data and exponent part are expressed as 99999.99 like D10_+99.999E+99 because data is incorrect.

The following is the sub-header priority:

High priority Low priority
 O → E → L/G/H → M → D

② Space

For header ON, one space is always given after the header.

③ Mantissa part data

The polarity "+" or "-" is always given to the top of data. Data consists of a value shown as a decimal point plus four- or five digit number. However, only current measured values are expressed as a four-digit number if the integration time is set to 2ms.

- ④ E
The character "E" represents an exponent.
- ⑤ Exponent Part Data
The polarity "+" or "-" is always given to the top of data. Data consists of a value shown as the polarity plus two-digit number according to the unit indication (exponent and symbol). Table 6-3 shows the mantissa- and exponent-part data under each measuring condition.
- ⑥ Block Delimiter
This can be changed with the program command "DLd" as follows.
DL0:CRLF (<EOI> (<EOI> simultaneously with L))
DL1:LF
DL2:<EOI> simultaneously with the final byte
DL3:LF<EOI> (<EOI> simultaneously with L)

Table 6 - 3 Mantissa- and Exponent-part Data

| | Range | Unit=Symbol (Indication) | | Unit=Exponent (Indication) | |
|---|------------------------------------|--------------------------|---------------|----------------------------|---------------|
| | | Mantissa part | Exponent part | Mantissa part | Exponent part |
| Direct current (DI) | 200pA | ± ddd. dd | -12 | ± d. dddd | -10 |
| | 2nA | ± dddd. d | -12 | ± d. dddd | -09 |
| | 20nA | ± dd. ddd | -09 | ± d. dddd | -08 |
| | 200nA | ± ddd. dd | -09 | ± d. dddd | -07 |
| | 2 μA | ± dddd. d | -09 | ± d. dddd | -06 |
| | 20 μA | ± dd. ddd | -06 | ± d. dddd | -05 |
| | 200 μA | ± ddd. dd | -06 | ± d. dddd | -04 |
| | 2mA | ± dddd. d | -06 | ± d. dddd | -03 |
| | 20mA | ± dd. ddd | -03 | ± d. dddd | -02 |
| Resistance measurement (RM RV RS) | One-digit indica- tion | +0000d. | 00 to 15 | +0000d. | 01 to 23 |
| | Two-digit indica- tion | +000dd. | 00 to 15 | +000d. d | 01 to 16 |
| | Three- digit indica- tion | +00dd. d to +00ddd. | 00 to 15 | +00d. dd | 02 to 15 |
| | Four- digit indica- tion | +0dd. dd to +0dddd. | 00 to 15 | +0d. ddd | 03 to 14 |

When the integration time is set to 2ms, no above least significant digit of current measured data is output.

6.5.2 Response to Query Command

(1) Status Query Response

| | | | | |
|---|---|---|----|-------|
| X | X | X | LF | <EOI> |
| ① | | | ② | |

- ① For three-digit integer data, the integer data is output with the range between 000 and 255.
For two-digit integer data, the integer data is output with the range between 010 and 099.
For one-digit integer data, the integer data is output with the range between 001 and 009.

② Terminator

The terminator is set with the "DLd" command.

(2) Set Query Response

| | | | | | | |
|---|---|---|---|---|----|-------|
| X | X | X | X | X | LF | <EOI> |
| ① | | | | | ② | |

- ① The response is expressed by alphabetical upper-case and numeric characters. Integer data ranges between -32768 and +32768.

② Terminator

The terminator is set with the "DLd" command.

(3) Data Query Response

| | | | | | | | | | | | | | | |
|---|---|---|---|---|---|---|---|---|---|---|---|---|----|-------|
| X | X | X | | X | X | X | X | , | X | X | X | X | LF | <EOI> |
| ① | | ② | ③ | | | ④ | ③ | | ⑤ | | | | | |

- ① The response is expressed by alphabetical upper-case characters.

② One space is always given.

③ Data is expressed as any one of integer data, data with decimal point, and decimal-point data + exponent data.
The number of data values and data format depend on commands.

- ④ Data Separator
A comma "," is given.
- ⑤ Terminator
The terminator is set with the "DLd" command.

6.5.3 Binary Packed Format

Binary packed format

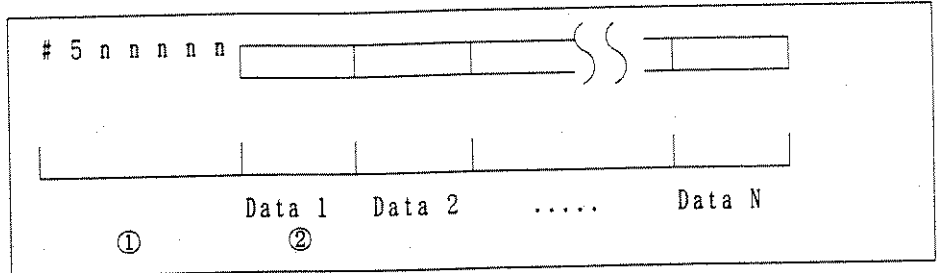

① Preface

This consists of ASCII data and is sent with the following format.

5 n n n n n

- Shows 8-bit byte data length. In the above example, a value of 4 x N is given here as a 5-digit ASCII integer because number of data values equals "N" and one data value consists of 4 bytes. 00001 to 99999
- Shows the number of digits of data representing the next data length.
- The sign "#" shows the packed format.

② Data format

Data is sent as 32-bit floating-point notation based on IEEE754-1985.

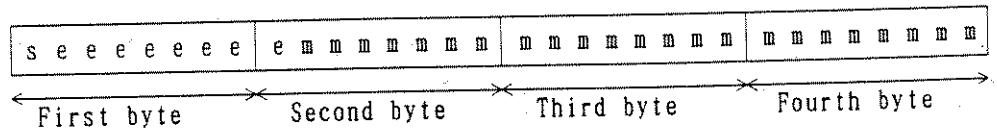

s : Sign bit 0: Positive 1: Negative
 e : Exponent part of "2" based on 127 (2⁰) 8bit
 m : Mantissa part 23bit

Where,

1. For e=255 and m≠0: Non-numeric value (Over-range or error data)
2. For e=255 and m=0 : X=-1^e (∞)
3. For 0<e<255 : X=-1^e (2^{e-127})(1+m) Normalization
4. For e=0 and m≠0 : X=-1^e (2⁻¹²⁶)(0+m) Non-normalization
5. For e=0 and m=0 : X=-1^e (0) +/- zero

This meter outputs any one of data in Item ①, ③, and ⑤ but does not output data in Item ② or ④. For Item ①, error data such as over-range and operation error is shown. For Item ⑤, the value "-0" is not generated.

Example)

```

1 0 1 1 1 0 1 1 1 1 0 0 1 0 0 0 0 1 0 0 1 0 0 0 1 0 0 1 0 0 0 0
|-----|-----|-----|-----|-----|-----|-----|-----|
s         e         m

```

In the above case, the exponent and mantissa parts are expressed respectively as follows:

$$\text{Exponent part: } 2^8 + 2^5 + 2^4 + 2^2 + 2^1 + 2^0 = 119 \rightarrow e = 119 - 127 = -8$$

$$\text{Mantissa part: } 2^{-1} + 2^{-4} + 2^{-9} + 2^{-12} + 2^{-16} + 2^{-19} = 0.56471443177$$

$$\rightarrow m = 1 + 0.56471443177 = 1.56471443177$$

$$X = 1.56471443177 \times 2^{-8} = -6.1121657491E-3$$

As for 1, "e" and "m" bits of data are 1.

6.5.4 Format of Recall Data with Data Number

Format of recall data with data number

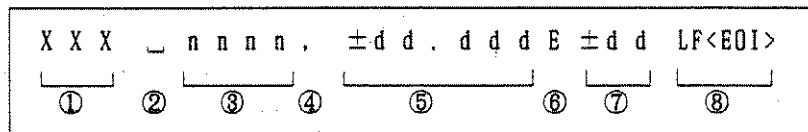

① Header

For header OFF, no space is given before the mantissa part of data but data is left-justified.

Three digits (The third digit is a sub-header.)

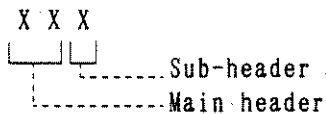

Main header

DI: DC measurement

RM: Resistance measurement

RV: Volume resistivity

RS: Surface resistivity

Sub-header

O : Over-range *
 D : Data after NULL operation
 H : COMPARE-operation result "HI"
 G : COMPARE-operation result "GO"
 L : COMPARE-operation result "LO"
 E : Measured data error *
 M : Data when VS is caught by the current limiter
 _ : Cases other than the above

* : For the above "O" and "E", both data and exponent part are expressed as 99999.99 like D10_+99.999E+99 because data is incorrect.

The following is the sub-header priority:

Hith priority Low priority

O → E → L/G/H → M → D

② Space

For header ON, one space is always given after the header.

③ Data Number

The number consists of a 4-digit integer between 0001 and 1000.

④ Data Separator

A comma "," is given.

⑤ Mantissa Part Data

The polarity "+" or "-" is always given to the top of data. Data consists of a value shown as a decimal point plus 5-digit number.

⑥ E

The character "E" represents an exponent.

⑦ Exponent Part Data

The polarity "+" or "-" is always given to the top of data. Data follows the present unit setting.

Table 6-3 shows the mantissa or exponent-part data under each measuring condition.

⑧ Block Delimiter

This can be changed with the program command "DLd" as follows:

DL0:CRLF<EOI> (<EOI> simultaneously with LF)

DL1:LF

DL2:<EOI> simultaneously with the final byte

DL3:LF<EOI> (<EOI> simultaneously with LF)

6.6 Listener Specification

The listener command of the meter is roughly divided into the following three types.

(1) Command Consisting of Only Header

Example) ① Command to designate device parameters such as R10 and R0

② Command to execute measurement and AD CAL function such as *TRG, ADO, and E

(2) Command Consisting of "Header + Data"

Example) ① Command to set data such as PVS $\pm 1.0E+2$ and PHL-199.99E-10

② Command used for setting related to status register such as *SRE24 and DSE1

(3) Query Command

Example) RNG?, CNT?, and *STB?

When the meter receives the above commands, it outputs the response for them to the output buffer.

6.6.1 Header Part

(1) Space in Header

The space in header results in a syntax error.

Example) ① R1 OK
R_1 Syntax error

② *STB? OK
*STB_ Syntax error

(2) One-character Command

Be sure to give the block delimiter after one-character commands "E", "C", and "Z".

Example) AC1ELF<EOI> OK
AC1EBERR?LF<EOI> Syntax error

6.6.2 Data Part

- (1) Separator Between Data
Be sure to give a comma "," to the separator between data.

Example) PGM_1, 1.2E-2, 3E-1

- (2) Space in Data
Among spaces in data, the space in mantissa and exponent data results in a syntax error.

例) PVS_1.99_99_E-1_2

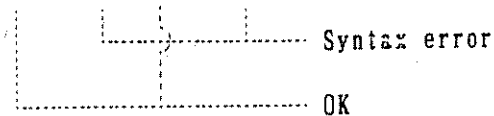

- (3) Data
Data can be set with NR1 (integer), NR2 (fixed-point data excluding exponents), and NR3 (floating-point data including exponents).

If data with the specified effective number of digits or more is received, the digit one-order lower than the effective digit is rounded to the nearest whole number.

Example) 1.234E-99 → 0
-1.23456789 → -1.2346

6.6.3 Terminator

The block delimiter detects the following:
LF<EOI>, <EOI>, CRLF, LF,
CR<EOI>, CRLF<EOI>

6.6.4 Query Command

The query command is defined as the command to execute the set parameters, status information, and self-tests and obtain the results of execution. When a query command is received, information corresponding to the command is output to the output buffer. Data is output in the form of NR1, NR2, or NR3. For response data to be output, see the program code in Table 6-4.

Example) ① PVS? (VS set value?)
→ Response data : PVS_10.000

② STB? (Status byte?)
→ Response data : 8

Table 6 - 4 Program Code

| Header | Contents | Initial value |
|--------|--|---------------|
| R10 | IM (Current measurement) | ○ |
| R11 | RM (Resistance measurement) | |
| R12 | RV (Volume resistivity measurement) | |
| R13 | RS (Surface resistivity measurement) | |
| R1X? | The query for the present measurement contents, response is R10 through R13. | |
| R0 | AUTO Range | ○ |
| R2 | 200pA Range | |
| R3 | 2nA Range | |
| R4 | 20nA Range | |
| R5 | 200nA Range | |
| R6 | 2 μ A Range | |
| R7 | 20 μ A Range | |
| R8 | 200 μ A Range | |
| R9 | 2mA Range | |
| R10 | 20mA Range | |
| RNG? | The query for range, response is R0 and R2 through R10. | |
| M00 | Sampling:RUN | ○ |
| M01 | Sampling:HOLD | |
| MOX? | The query for sampling, response is M00 and M01. | |
| AD0 | AD auto calibration:ON | ○ |
| AD1 | AD auto calibration:OFF | |
| ADX? | The query for AD auto calibration, response is AD0 and AD1. | |
| AZ1 | Input zero cancel execution | |
| IT0 | Integration time:2mS | |
| IT1 | Integration time:1PLC | |
| IT2 | Integration time:5PLC | |
| IT3 | Integration time:10PLC | ○ |
| IT4 | Integration time:10PLC \times 4 | |
| IT5 | Integration time:10PLC \times 8 | |
| IT6 | Integration time:10PLC \times 16 | |
| ITX? | IT Query, response is IT0 through IT6. | |

Table 6 - 4 Program Code (Cont'd)

| Header | Contents | Initial value |
|--------|--|---------------|
| ALO | Auto range level:UP20000 DOWN 1799 | ○ |
| AL1 | Auto range level:UP2000 DOWN 179 | |
| AL2 | Auto range level:UP200 DOWN 17 | |
| ALX? | AL Query, response is AL0 through AL2. | |
| LFO | Power frequency:50Hz | |
| LF1 | Power frequency:60Hz | |
| LFX? | LF Query, response is LFO and LF1. | |
| GA0 | Input amplifier gain: ×1 | |
| GA1 | Input amplifier gain: ×10 | ○ |
| GA2 | Input amplifier gain: ×100 | |
| GA3 | Input amplifier gain: ×10000 | |
| GAX? | GA Query, response is GA0 through GA3. | |
| MDO | MEASURE | ○ |
| MD1 | CHARGE | |
| MD2 | DISCHARGE | |
| MDX? | MD Query, response is MDO through MD2. | |
| OTO | Stand-by | ○ |
| OT1 | Operate | |
| OTX? | OT Query, response is OT0 and OT1. | |
| NMO | NULL operation:OFF | ○ |
| NM1 | NULL operation:ON | |
| NMX? | NM Query, response is NMO and NM1. | |
| RMO | Compare operation:OFF | ○ |
| RM1 | Compare operation:ON | |
| RMX? | RM Query, response is RMO and RM1. | |
| DS0 | Indication:ON, Unit indication=Symbol (mA, etc.) | ○ |
| DS1 | Indication:ON, Unit indication=Exponent ($\times 10^{-3}$, etc.) | |
| DS2 | Indication:OFF | |
| DSX? | DS Query, response is DS0 through DS2. | |

Table 6 - 4 Program Code (Cont'd)

| Header | Contents | Initial value |
|---|--|--|
| BZ0 | Buzzer:ON | ○ |
| BZ1 BZX? | Buzzer:OFF BZ Query, response is BZ0 and BZ1. | |
| ST0 | Data storage:OFF | ○ |
| ST1 STX? | Data storage:ON ST Query, response is ST0 and ST1. | |
| OM0 | Data output mode Basic format Header:ON | ○ |
| OM1 OM2 OM3 OM9 OMX? | Data output mode Basic format Header:OFF Data output mode Recall data with data No. Header:ON Data output mode Recall data with data No. Header:OFF Data output mode Binary packed format IEEE754 OM Query, response is OM0 through OM3 and OM9. | |
| DL0 | Block delimiter CRLF<EOI> (<EOI> simultaneously with LF) | ○ |
| DL1 DL2 DL3 DLX? | Block delimiter LF Block delimiter <EOI> (<EOI> simultaneously with final byte) Block delimiter LF<EOI> (<EOI> simultaneously with LF) DL Query, response is DL0 through DL3 | |
| S0 | SRQ ON | |
| S1 SRQ? | SRQ OFF S0 and S1 Query, response is S0 and S1. | ○ |
| IL0 | VS current limiter:300mA | ○ |
| IL1 IL2 ILX? | VS current limiter:100mA VS current limiter:10mA IL Query, response is IL0 through IL2. | |
| DA0 DA1 DA2 DA3 DA4 DA5 DA6 DA7 DA8 DAX? | ANALOG OUT (D/A OUT) OFF ANALOG OUT (D/A OUT) ON AAA99 ANALOG OUT (D/A OUT) ON 1AAA9 ANALOG OUT (D/A OUT) ON 19AAA ANALOG OUT (D/A OUT) ON 199AA ANALOG OUT (D/A OUT) ON BBB99 ANALOG OUT (D/A OUT) ON 1BBB9 ANALOG OUT (D/A OUT) ON 19BBB ANALOG OUT (D/A OUT) ON 199BB DA Query, response is DA0 through DA8. | * R8340A only, A syntax error occurs for R8340. |

Table 6 - 4 Program Code (Cont'd)

| Header | Contents | Initial value |
|---------------------------|--|--|
| BD0 BD1 BD2 BDX? | BCD OUT OFF BCD OUT BCD BCD OUT BINARY (16bit+10 ^a) BD Query, response is BD0 through BD2. | * R8340A only. A syntax error occurs for R8340. |
| CL0 CL1 CL2 | Contact checking level:×10 Contact checking level:×5 Contact checking level:×2 | |
| CL3 | Contact checking level:×1 | ○ |
| CL4 CL5 CL6 CLX? | Contact checking level:×0.5 Contact checking level:×0.2 Contact checking level:×0.1 CL Query, response is CL0 through CL6. | |
| CI1 CI2 CI1? | Contact initialization measurement execution (2ms) Contact initialization measurement execution (1PLC) Contact initialization measurement is executed and outputs the data at initialization (2ms) Response is to 0 to 32767. measurement data | |
| CI2? | (0000.0 to 32767(unit : pF)) (99999 at an initial error) Contact initialization measurement is executed and outputs the data at initialization (1PLC) Response is to 0 to 32767. measurement data (0000.0 to 32767(unit : pF)) (99999 at an initial error) | |
| ABT | Sequence program operation is interrupted. | |
| | Special command (Terminator is always needed after the command.) | |
| E | Measurement start and program start. Same with *TRG and GET | |
| C | Device initialization. Same with SDC and DCL | |
| Z | Device and parameter initialization. Same with *RST | |

CAUTION

The command to interrupt the sequence program operation includes SDC and DCL in addition to ABT. The operation is not interrupted by other commands.

Table 6 - 4 Program Code (Cont'd)

| Header | Format | Contents |
|-------------|---|--|
| PVS PVS? | PVS +dd.dddE ±dd PVS → Data → | Voltage generation data It is allowed to use <NR1>, <NR2> and <NR3> for the data part. PVS Query, response is PVS_XX.XXX |
| PHL PHL? | PHL ±hh.hhhE ±hh, ±ll.111E ±ll PHL → h → , → l → | Compare Upper/Lower setting h :Upper data l :Lower data Error except for h>l It is allowed to use <NR1>, <NR2> and <NR3> for the data part. PHL Query, response is PHL±hh.hhhE ±hh ±ll.111E±ll |
| PEL PEL? | PEL 0. tt.tt PEL 1. tt.tt PEL 2. tt.tt.vv.vv, ss.ss PEL 0. → t → PEL 1. → t → PEL 2. → t → , → v → , → s → | 50mm-dia-electrode coefficient 70mm-dia-electrode coefficient Optional-electrode coefficient t;Thickness (Unit:mm) v;Volume-resistivity electrode coefficient s;Surface-resistivity electrode coefficient The previously set value is used when "t", "v", and "s" are omitted. It is allowed to use <NR1>, <NR2>, and <NR3> for the data part. Response uses <NR1> or <NR2> PEL_d, tt.tt.vv.vv,ss.ss d=0 to 2 There is no omission. |
| PTD PTD? | PTD dd.ddd PTD → Data → | Trigger delay It is allowed to use <NR1>, <NR2>, and <NR3> for the data part. PTD Query, response is PTD_dd.ddd. |
| PAD PAD? | PAD dd.ddd PAD → Data → | Autoreng delay It is allowed to use <NR1>, <NR2>, and <NR3> for the data part. PAD Query, response is PAD_dd.ddd. |

<NR1> : Integer data (Example: +123)
 <NR2> : Fixed-point data (Example: +12.34)
 <NR3> : Floating-point data (Example: 123.4E -10)

Table 6 - 4 Program Code (Cont'd)

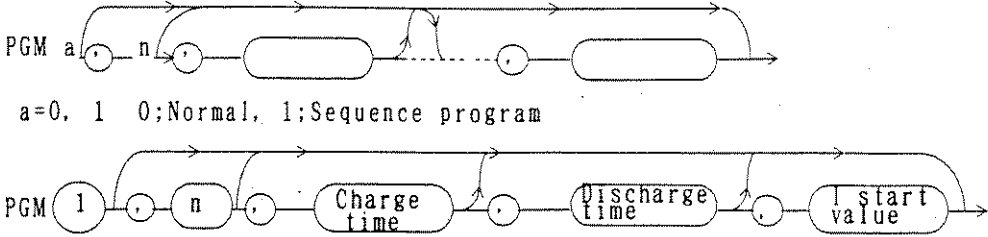
| Header | Contents |
|--------|---|
| PGM |  <p>a=0, 1 0;Normal, 1;Sequence program</p> <p>For n=1 to 3 : Charge time and discharge time only For n=4 : Charge time, discharge time, and I start value For n=5 : Charge time, discharge time, and measurement time.</p> <p>When the above is omitted, the previously set value is used.</p> <p>Example: PGM1, 4,..100E-12</p> |
| PGM? | <p>The query response for PGM is the same with the PGM command. (No omission)</p> <p>Example: PGM_1, 4, 10, 10, 100E-12</p> |
| PRE | <p>PRE dddd dddd:1 to 1000 (Data number) It is allowed to use <NR1>, <NR2>, and <NR3> for the data part. • Specify the recall data No. (When the OM2 and OM3 are specified, specify the data to be output with the command.)</p> |
| PRE? | <p>The query response for PRE is PRE_ dddd.</p> |

CAUTION

Program No. 0 of the sequence program cannot be used with GPIB.

Table 6 - 4 Program Code (Cont'd)

| Header | Data, Characters in parentheses show response. | Contents (Processing) |
|--------|--|--|
| CNT? | (0 or 1) | Contact checking is executed and the checking results are output. When the response is "0", checking is OK. If the response is "1", checking is NG. |
| CNX? | (0 to 32767) | Contact checking is executed and the checking results are output. 0, 0 to 32767 1, 0 to 32767 measurement data (0000.0 to 32767 (unit:pF)) 0 : OK (at measurement over 99999) 1 : NG |
| DNO? | (0 to 1000) | The number of recall data values in the buffer memory is output. The response is 0 through 1000. |
| ERR? | (0 to 32767) | The contents of device, execution, and self-test errors are output. The response is output by converting 16-bit error flag into ASCII data. (No error for "0") See Item 6.7.4. |
| *IDN? | (ASCII Character) | The meter ID is output. ADVANTEST, R8340, 0, 01010101. Maker Model Revision No. name (No serial No.) |
| *OPT? | (ASCII Character) | Option numbers are output. The value "0" is output when there is no option. |
| *TST? | (0 to 4095) | The self-test is executed and the results are output. The response is output by converting the error flag into ASCII data. When the value "0" is output, the self-test is OK. See Item 6.7.5. |
| *TRG | | Start of measurement and start of program is specified. GET: Same with the "E" command |
| *RST | | Reset: Same with the "Z" command. The set parameter is initialized. For details, see Section 6.8. |

Table 6 - 4 Program Code (Cont'd)

| Header | Data, Characters in parentheses show response. | Contents (Processing) |
|--------|--|---|
| *CLS | | Status byte registers other than MAV and the SESR and DESR are cleared, and also the output buffer related to status is cleared. |
| *SRE | 0 to 255 | The service request enable register is set. The service request enable register decides the bit of the status register to transmit SRQ. |
| *SRE? | (0 to 63) (128 to 191) | The contents of the service request enable register are output. Because the RQS bit (bit 6) is not set, the response results in 0 through 63 and 128 through 191. |
| *STB? | (0 to 255) | The contents of the status register are output. The bit 6 outputs ORed data of all other bits not as the RQS bit but as the MSS bit. |
| *ESE | 0 to 255 | The standard event status enable register (SESER) is set. See Item 6.7.2. |
| *ESE? | (0 to 255) | The contents of the SESER are output. The response is 0 through 255. |
| *ESR? | (0 to 255) | The contents of the standard event status register (SESR) are output. When the output data is read, the SESR is cleared. The response is 0 through 255. See Item 6.7.2. |
| DSE | 0 to 255 | The device event status enable register (DESER) is set. See Item 6.7.3. |
| DSE? | (0 to 255) | The contents of the DESER are output. The response is 0 through 255. |
| DSR? | (0 to 255) | The contents of the device event status register (DESER) are output. When the output data is read, the DESER is cleared. The response is 0 through 255. See Item 6.7.3. |

Table 6 - 4 Program Code (Cont'd)

| Header | Data, Characters in parentheses show response. | Contents (Processing) |
|--------|--|---|
| *PSC | -32768 to 32767 | The power-on clear flag is set or reset. * When PSC is "0", the power-on clear flag is reset. As a result, the service request enable registers SESER and DESER are not cleared when the power is on. * When PSC ranges between 32768 and 32767 (other than 0), the power-on clear flag is set. As a result, the service request enable registers SESER and DESER are cleared when the power is on. |
| *PSC? | (0 or 1) | The state of the power-on clear flag is output. The power-on clear flag is reset when the response is 0 and set when the response is 1. |

6.6.5 Command Buffer and Measured Data Buffer

The meter, in order to shorten the GPIB occupying time, stores program codes in the command buffer under the listener mode and receives the block delimiter before analyzing and executing the stored program codes. During execution of the codes, it is possible to control other units. By setting measured data to "ST1", the data is successively stored in the measured data buffer and the output request is set to the "OM2", "OM3", or "OM9". When the talker mode is specified, data can be transferred in order of measurement.

The buffer size is shown in the table below.

| Buffer | Size |
|----------------------|-----------------|
| Command buffer | 256 bytes |
| Measured data buffer | 1000 data value |

6.6.6 Controller Interruption During Data Transfer Between Units

The GPIB system makes it possible to transfer data between units other than controllers. When the controller executes interruption to add a new listener during data transfer between units (during handshake), data transfer between units is completed and the priority is given to the interruption by the controller. When the controller changes the mode to the serial polling mode, data transfer between units is interrupted and the priority is given to the interruption by the controller.

6.7 Status Byte

6.7.1 Structure of Status Byte Register

Figure 6-3 shows the structure of the status byte register. Table 6-5 shows the description of each bit of the register. The contents of the register are read with the serial-polling or *STB? command. Data in the bit 6 is read as MSS (logic OR of other bits) with the *STB? command.

Transmission of SRQ is controlled by the service request enable register. The register corresponds to the status byte register in 1 to 1 and SRQ can be transmitted by the bit set to "1". The setting is made with the *SRE command and the set contents can be read with the *SRE? command.

Example) When *SRE1 is set, SRQ is transmitted at the end of measurement.

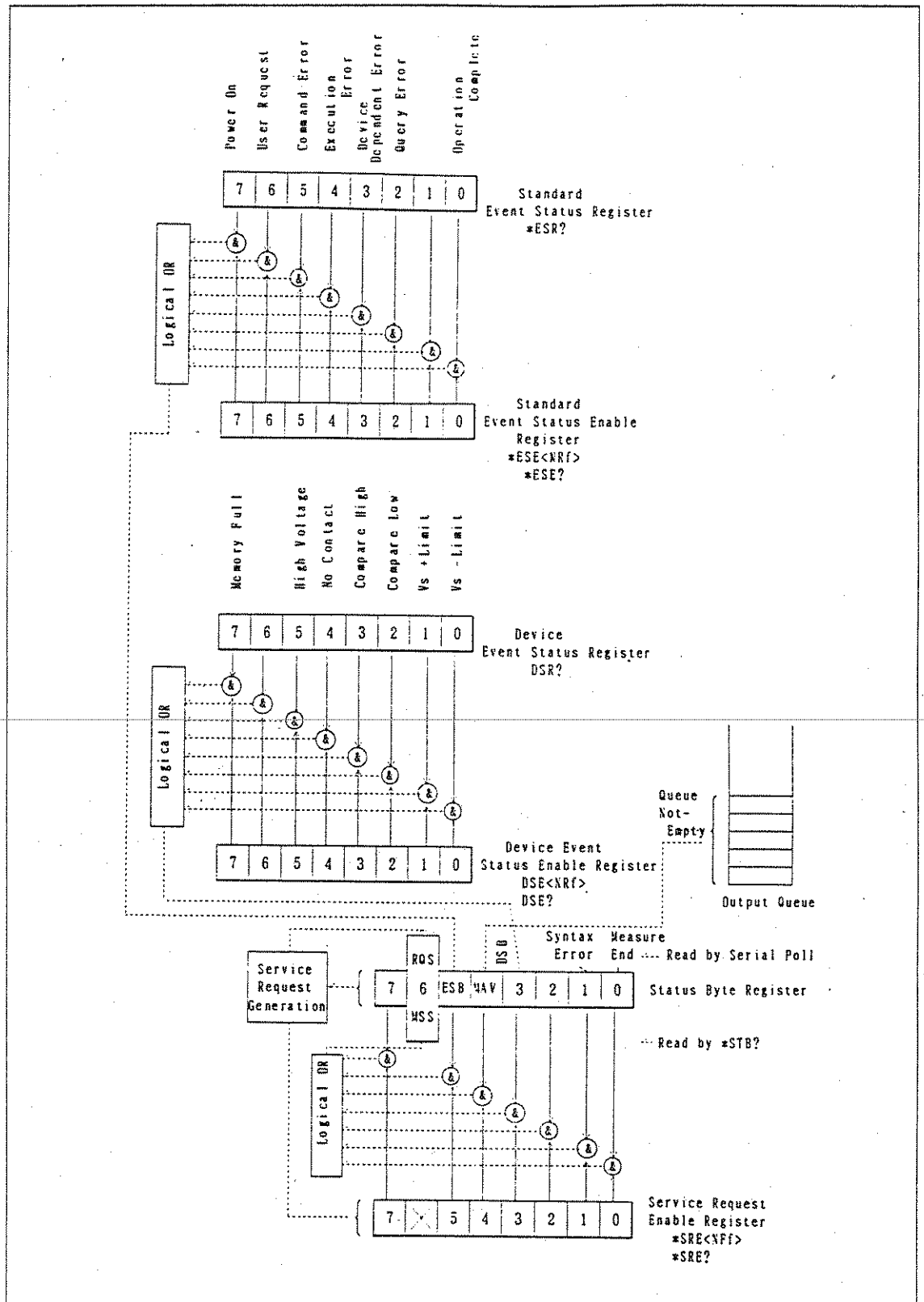

Figure 6 - 3 Structure of Status Byte Register

Table 6 - 5 Status Byte Register

| bit | Name | Contents |
|-----|--------------|--|
| 0 | Measure End | This is set at the end of measurement and reset at the start of measurement or end of measured data output. |
| 1 | Syntax Error | This is set when the command error (program data error, listener command error, or listener command buffering overflow) occurs. |
| 2 | END | This is set when contact checking, contact initialization measurement, and sequence program end. |
| 3 | DSB | This is set when a factor of the DESR bit concerned is generated while any one of DESER bits is set to ENABLE and reset when DESER is read. See Item 6.7.3. |
| 4 | MAV | This is set when output data is set to the output buffer and reset when output data is read. |
| 5 | ESB | This is set when a factor of the SESR bit concerned is generated while any one of SESER bits is set to ENABLE and reset when SESR is read. See Item 6.7.2. |
| 6 | RQS(MSS) | This is set when bits 0 through 5 are set. |
| 7 | — | Not in use. |

CAUTION

1. For the status byte register, only the RQS bit (bit6) is cleared by serial polling.
2. Though the register and output buffer related to status are cleared with the *CLS command, the measured-data output buffer is not cleared with the command. Therefore, the MAV bit (bit4) is not cleared even if the *CLS command is received when measured data is present in the output buffer.
3. If the power switch is turned on when the power-on reset flag is set for *PSC ranging between -32767 and 32768 (other than 0), the status byte enable registers SESER and DESER are cleared but SRQ is not transmitted.

6.7.2 Structure of Standard Event Status Register

Figure 6-4 shows the structure of the standard event status register (SESR). Table 6-6 shows the description of each bit of this register. The register is controlled by the standard event status enable register (SESER). When the SESER is set, the bit5 of the status byte register is set if a factor of the bit concerned is generated. In this case, if the bit5 of the status byte enable register is set to ENABLE, the bit6 of the status byte register is set and SRQ is transmitted.

The SESR can be read with the *ESR? command.

The SESER can be written with the *ESE command and read with the *ESE? command.

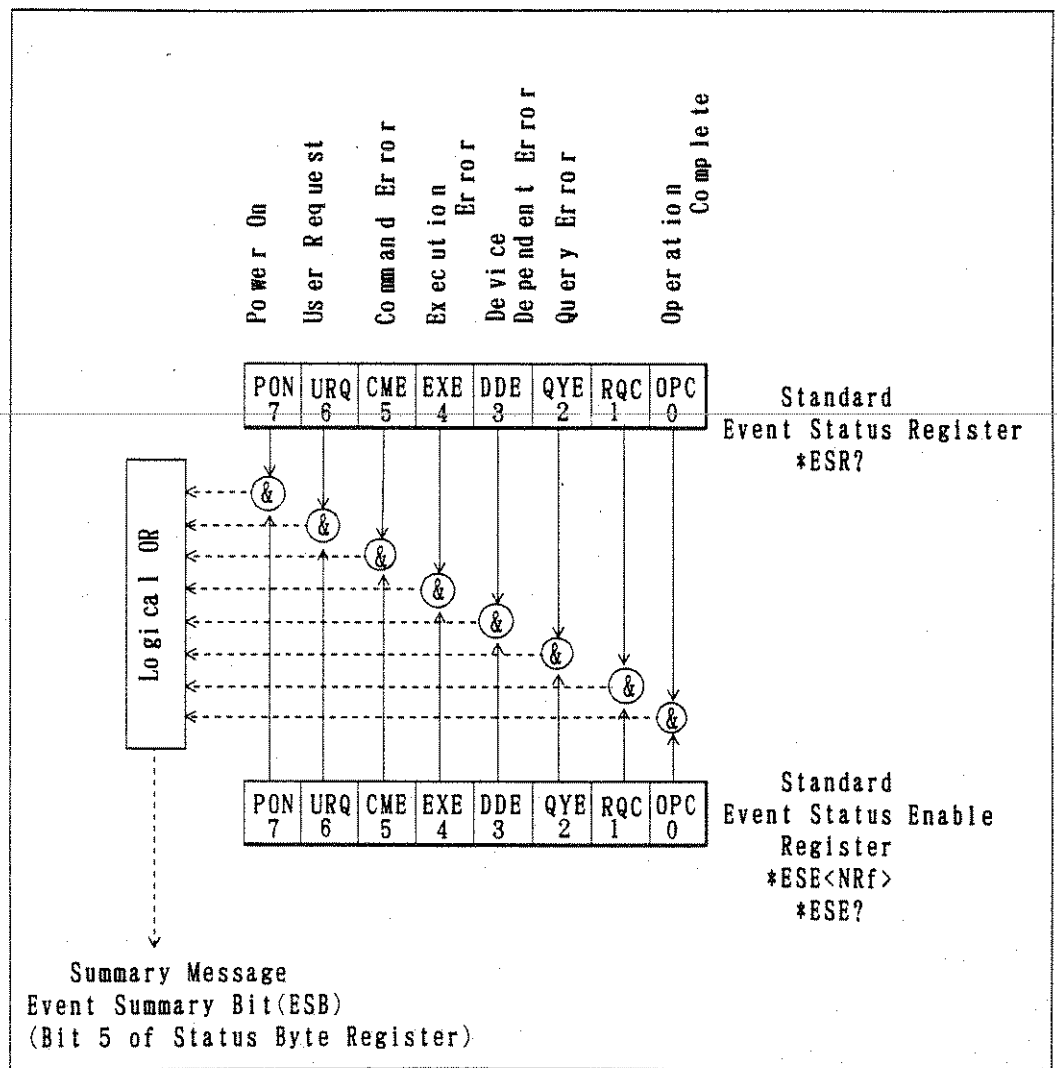

Figure 6 - 4 Standard Event Status Register

Table 6 - 6 Standard Event Status Register

| bit | Name | Contents |
|-----|---------------------------------|---|
| 0 | OPC (Operation Complete) | Not in use. |
| 1 | RQC | Not in use. |
| 2 | QYE (Query Error) | This is set when data is read though no output data is present or the output buffer is overflowed or overloaded. |
| 3 | DDE (Device Dependent Error) | This is set when an error occurs during the operation including over-range and overload or a failure occurs. |
| 4 | EXE (Execution Error) | This is set when input data is out of the internally set range or a command cannot be executed. |
| 5 | CME (Command Error) | This is set when the header is undefined, the data format is incorrect, a syntax error is found in a command, or GET arrives while a command is received. |
| 6 | URQ | Not in use. |
| 7 | PON (Power On) | This is set when the power is turned on. |

6.7.3 Structure of Device Event Status Register

Figure 6-5 shows the structure of the device event status register. Table 6-7 shows the description of each bit of this register. The register is controlled by the device event status enable register (DESER). The DESR output is collected in the bit3 of the status byte register.

The DESR is read with the DSR? command.

The DESER is written with the DSE command and read with the DSE? command. The register notifies the condition of internal operation unlike the DDE bit of the SESR which notifies errors.

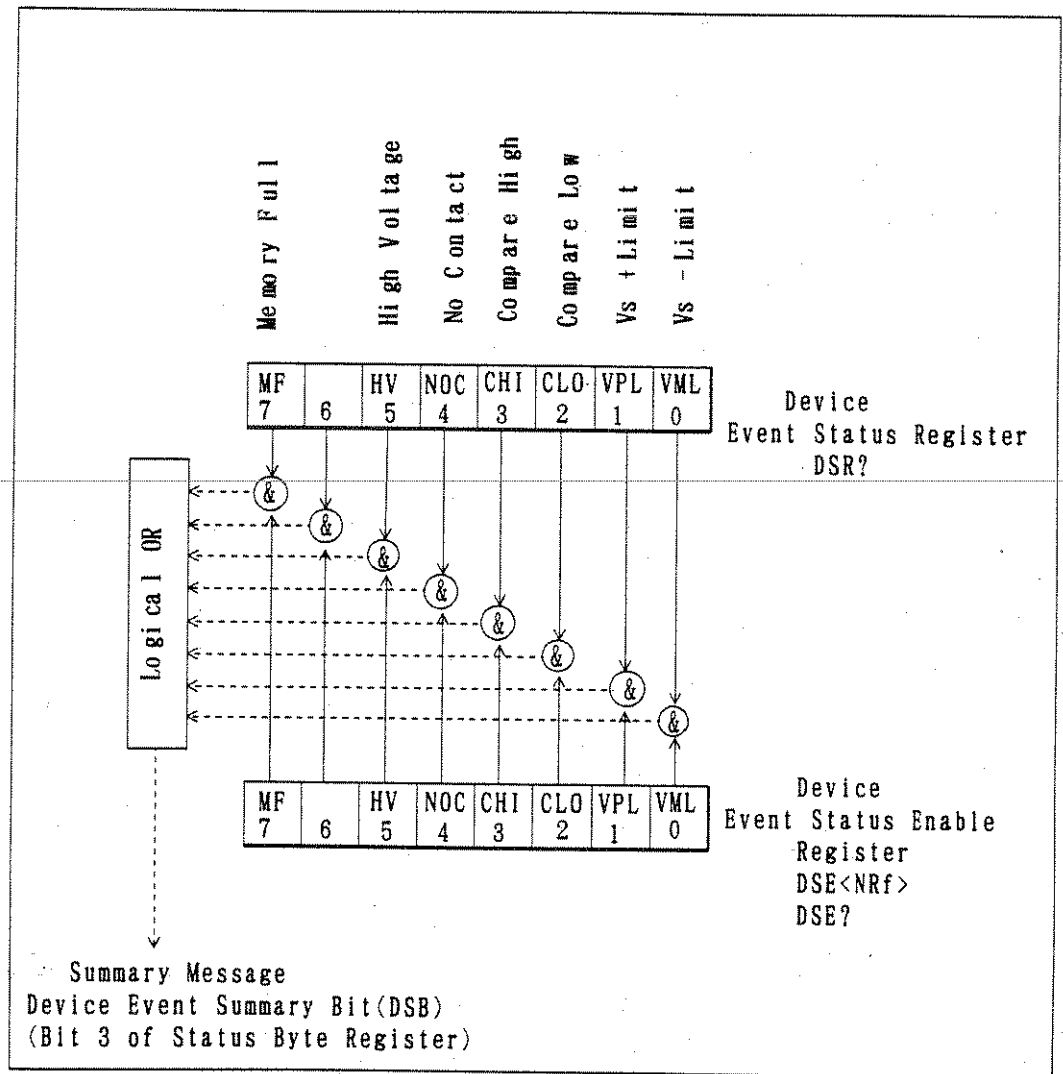

Figure 6 - 5 Device Event Status Register

Table 6 - 7 Device Event Status Register

| bit | Name | Contents |
|-----|---------------------|---|
| 0 | VML Vs -Limit | This is set when the V-SOURCE negative current limiter (sink limiter) operates. |
| 1 | VPL Vs +Limit | This is set when the V-SOURCE positive current limiter (source limiter) operates. |
| 2 | CLO Compare Low | This is set when LO is judged as the result of COMPARE operation. |
| 3 | CHI Compare High | This is set when HI is judged as the result of COMPARE operation. |
| 4 | NOC No Contact | This is set when NG (imperfect contact) is detected as the result of contact checking. |
| 5 | HV High Voltage | This is set when V SOURCE is set to 100V or more or 100V or more is applied to the V-SOURCE terminal. |
| 6 | — | Not in use. |
| 7 | MF Memory Full | This is set when the data buffer memory is full (1000 data values). |

6.7.4 Error Register

The contents of the internal error register is output as the response of the ERR? command. This register consists of 16 bits and each bit is as shown in Table 6-8. The ERR? command response is output as data value between 0 and 32767 by converting the error register contents into ASCII data.

Table 6 - 8 Error Register

| bit | Set bit of SESR | | Error contents | Error Indication |
|-----|-----------------|------|--|------------------|
| | Name | bit | | |
| 0 | EXE | bit4 | Vs is set to zero for RM measurement. | VERR |
| 1 | EXE | bit4 | Contact checking cannot be judged. | ERROR |
| 2 | EXE | bit4 | Contact initialization cannot be checked. | C. INIT ERROR |
| 3 | QYE | bit2 | Recall is executed when there is no output data. | — |
| 4 | CME | bit5 | Program data format error | — |
| 5 | | | Listener command error. | — |
| 6 | | | Listener command input buffer overflow | — |
| 7 | DDE | bit3 | Over-range | OL |
| 8 | | | Overload | OVL |
| 9 | | | Operation error | ERR 5 |
| 10 | | | Overvoltage detection | OVER VIN |
| 11 | | | Input fuse melting | FUSE OPEN |
| 12 | | | Overheat | OVER HEAT |
| 13 | | | Internal serial transfer error | ERR4 |
| 14 | | | Self-test error | See Table 6-9. |
| 15 | — | — | Not in use | — |

6.7.5 Self-test Error Register

As the response of the *TST? command, the contents of the 16-bit self-test error register are converted into ASCII data and output as the data values between 0 and 4095. When an error is detected in the self-test, the bit 3 DDE of the SESR is set. When the response is "0", the self-test is OK.

Table 6 - 9 Self-test Error Register

| bit | Error contents | Error Indication |
|-----|--|------------------|
| 0 | Defect of input amplifier | ERR IA |
| 1 | Defect of AD converter | ERR AD |
| 2 | Defect of 100V amplifier | ERR HV |
| 3 | Defect of 1000V amplifier | ERR KV |
| 4 | Serial transfer error | ERR 4 |
| 5 | Breakdown of calibration primary data | ERR 2 |
| 6 | Breakdown of calibration secondary data | ERR 3 |
| 7 | Breakdown of backup parameter (Panel backup, etc.) | ERR 1 |
| 8 | RAM read/write error | ERR RA |
| 9 | E ² PROM read/write error | ERR EP |
| 10 | Logic ROM error | ERR LR |
| 11 | Analog ROM error | ERR AR |
| 12 | Not in use | |
| 13 | Not in use | |
| 14 | Not in use | |
| 15 | Not in use | |

6.8 Status at Initialization and Command Reception

Table 6 - 10 Status Change by Each Command

| Command | Talker (TLK) | Liste- ner (LTN) | SRQ (RQS bit) | Status byte SESR DESR | SRQ enable SESER DESER | Data output buffer | Set parameter |
|--------------------------------|-----------------|------------------------|-------------------------------|--|---------------------------------|--------------------------|---------------------|
| Power On | Clear | Clear | By power -on clear flag | Bits other than PON bit are cleared. | By power -on clear flag | Clear | #1 |
| "*RST" "Z " | / | / | / | / | / | / | Initial- ization |
| DCL, SDC "C " | / | / | / | Only MAV bit is cleared. | / | Clear | / |
| IFC | Clear | Clear | / | / | / | / | / |
| "*CLS " | / | / | By MAV bit | Bits other than MAV bit are cleared. | / | / | / |
| GET, "E " "*TRG " | / | / | / | Measure end bit is cleared. | / | / | / |
| Talker designation | Set | Clear | / | / | / | / | / |
| Talker cancel designation | Clear | / | / | / | / | / | / |
| Listener designation | Clear | Set | / | / | / | / | / |
| Listener cancel designation | / | Clear | / | / | / | / | / |
| Serial polling | / | / | Clear | / | / | / | / |

DCL : Device Clear

SDC : Selected Device Clear

GET : Group Execute Trigger

#1 : When pressing the auto key immediately after the power is on,
the parameter is initialized.

6.9 Program Example

The following shows the program using HP-9816 for a personal computer and its description.

In the above program examples, the address of the meter is set to "1".

- Example of charging the insulation resistance of a sample for 10ms before measuring the resistance and outputting the measurement results. See (1)
- Example of judging the insulation resistance of a sample with a comparator when executing contact checking and starting measurement with external trigger signal. See (2)
- Example of dielectric strength test on a transistor. See (3)

- (1) Example of charging the insulation resistance of a sample for 10ms before measuring the resistance and outputting the measurement results

Measurement condition Vs:100V, Charge time:10ms

• Program example1

```

10  !
20  !      EXAMPLE 1
30  !
40  DIM A$(20)
50  CLEAR 701
60  !
70  OUTPUT 701;"R11,RO,MO1"
80  OUTPUT 701;"ITO,GA1,ALO"
90  OUTPUT 701;"PVS100"
100 !
110 OUTPUT 701;"MD2"
120 OUTPUT 701;"OT1"
130 OUTPUT 701;"MD1"
140 WAIT .01
150 OUTPUT 701;"MDO"
160 !
170 TRIGGER 701
180 ENTER 701:A$
190 PRINT A$
200 END

```

• Data example

```
RM 010.09E+09
```

• Description of program example1

| Line number | Description |
|-------------|--|
| 10 to 30 | Comment sentence |
| 40 | Reserving the measured data area |
| 50 | Initializing the GPIB interface device |
| 70 to 90 | Setting the meter parameter |
| | "R11" Resistance measurement |
| | "R0" Auto range |
| | "MO1" Sampling:HOLD |
| | "ITO" Integration time:2ms |
| | "GA1" Input amplifier gain: ×10 |
| | "ALO" Auto range level:20000 |
| | "PVS100" VS100V |
| 100 | Comment sentence |
| 110 | Setting the discharge state |
| 120 | Setting the operation state |
| 130 | Setting the discharge state |
| 140 | Waiting for 10ms |
| 150 | Setting the measurement state |
| 160 | Comment sentence |
| 170 | Starting the measurement |
| 180 | Receiving the data |
| 190 | Displaying the data |
| 200 | Ending the program |

- (2) Example of judging the insulation resistance of a sample with a comparator when executing contact checking and starting measurement with external trigger signal

Criterion: The case of $1 \times 10^7 \Omega \leq RX \leq 1 \times 10^{12} \Omega$ is judged as pass.

• Program example2

• Data example

```

10      !
20      !      EXAMPLE 2
30      !
40      !
50      ON INTR 7 GOSUB Srq
60      CLEAR 701
70      OUTPUT 701: "*CLS"
80      OUTPUT 701: "SO, RI1, RO, MO1"
90      OUTPUT 701: "IT0, GA1, AL1, RM1"
100     OUTPUT 701: "PVS50, PHL1E+12, 1E+7"
110     OUTPUT 701: "*SRE24, DSE12"
120     !
130     OUTPUT 701: "MD2"
140     OUTPUT 701: "OT1"
150     OUTPUT 701: "MD1"
160     WAIT .01
170     OUTPUT 701: "MDO"
180     !
190     OUTPUT 701: "CNT?"
200     ENTER 701;B
210     IF B=1 THEN 240
220     K$="CONTACT"
230     GOTO 250
240     K$="NO-CONTACT"
250     !
260     ENABLE INTR 7;2
270     !
280     !      EXT TRIGGER WAIT
290     !
300     GOTO 300
310 Srq: !
320     S=SPOLL(701)
325     ENTER 701;D$
330     IF BIT(S,3)=0 THEN 410
340     OUTPUT 701: "DSR?"
350     ENTER 701;A
360     IF BIT(A,2)=1 THEN 390
365     IF BIT(A,3)=0 THEN 410
370     L$="HIGH"
380     GOTO 415
390     L$="LOW"
400     GOTO 415
410     L$="GO"
415     PRINT D$, K$, L$
420     ENABLE INTR 7;2
430     RETURN
440     END

```

```

RMH +0008.9E+09
CONTACT
HIGH

```

• Description of program example2

| Line number | Description |
|-------------|---|
| 10 to 40 | Comment sentence |
| 50 | Defining the interrupt processing routine |
| 60 | Initializing the GPIB interface device |
| 70 | Clearing the status byte register |
| 80 to 110 | Setting the meter parameter |
| | "SO" Transmitting SRQ |
| | "RI1" Resistance measurement |
| | "RO" Auto range |
| | "MO1" Smpling:HOLD |
| | "ITO" Integration time:2ms |
| | "GA1" Input amplifier gain: ×10 |
| | "AL1" Auto range level:2000 |
| | "RM1" COMPARE operation ON |
| | "PVS50" VS50V |
| | "PHL1E+12, 1E+7" |
| | Upper limit value:1×10 ¹² Ω, |
| | Lower limit value:1×10 ⁷ Ω, |
| | "*SRE24" Setting the service request enable register to "24" |
| | "DSE12" Setting the device event status enable register to "12" |
| 120 | Comment sentence |
| 130 | Setting the discharge state |
| 140 | Setting the operation state |
| 150 | Setting the charge state |
| 160 | Waiting for 10ms |
| 170 | Setting the measurement state |
| 180 | Comment sentence |
| 190 | Executing the contact checking |
| 200 | Receiving the contact checking result data |
| 210 | Branching to the line number 240 if the result data is "1" (NG) |
| 220 | Saving the "CONTACT" indication |
| 230 | Branching to the line number 250 |
| 240 | Saving the "NO-CONTACT" indication |
| 250 | Comment sentence |
| 260 | Enabling the interrupt form the GPIB |
| 270 to 290 | Comment sentence |
| 300 | Waiting for the external trigger to be applied at the line number 300 |
| 310 | Interrupt processing routine name |
| 320 | Reading the status byte by polling the meter |
| 325 | Receiving measured data |
| 330 | Branching to the line number 410 if the bit 3 of the status byte is "0" |
| 340 | Executing the read command of the device event register |

• Description of program example2 (Continued)

| Line number | Description |
|-------------|---|
| 350 | Reading the device event register |
| 360 | Branching to the line number 390 if data bit 2 is "1" |
| 365 | Branching to the line number 410 if the data bit 3 is "0" |
| 370 | Saving the "HIGH" indication |
| 380 | Branching to the line number 415 |
| 390 | Saving the "LOW" indication |
| 400 | Branching to the line number 415 |
| 410 | Saving the "GO" indication |
| 415 | Displaying the measured data, and results of contact checking and COMPARE operation |
| 420 | Enabling the interrupt from the GPIB |
| 430 | Returning to the main processing routine |
| 440 | Ending the program |

(3) Example of Dielectric Strength Test on a Transistor

The current at puncture is set to 100 μ A and generated voltage is read when the applied voltage is increased 1V by 1V starting with 101V and the current exceeds 100 μ A.

• Program example3

• Data example

```

10  !
20  !      EXAMPLE 3
30  !
40  DIM A$[20]
50  CLEAR 701
60  !
70  OUTPUT 701;"S1, RIO, RO, MO1"
80  OUTPUT 701;"IT1, GA3, ALO, RM1"
90  OUTPUT 701;"PHL100E-6, 0E-12"
100 OUTPUT 701;"*SRE9, DSE8"
110 !
120 OUTPUT 701;"MD2"
125 OUTPUT 701;"PVS0"
130 OUTPUT 701;"OT1"
140 OUTPUT 701;"MD1"
150 WAIT .01
160 OUTPUT 701;"MDO"
170 OUTPUT 701;"*CLS"
180 Vs-data=101
190 OUTPUT 701;"PVS";Vs-data
200 TRIGGER 701
210 S=SPOLL(701)
220 IF BIT(S,0)=0 THEN 210
230 IF BIT(S,3)=1 THEN 270
240 Vs-data=Vs-data+1
245 IF Vs-data=1001 THEN 295
250 GOTO 190
260 !
270 OUTPUT      "PVS?"
280 ENTER 701;A$
290 PRINT A$
295 OUTPUT 701;"OTO"
300 END
  
```

PVS 0205.0

• Description of program example3

| Line number | Description |
|-------------|--|
| 10 to 30 | Comment sentence |
| 40 | Reserving the data area |
| 50 | Initializing the GPIB interface device |
| 60 | Comment sentence |
| 70 to 100 | Setting the meter parameter |
| | "S1" SRQ stop |
| | "R10" Current measurement |
| | "R0" Auto range |
| | "MO1" Sampling:HOLD |
| | "IT1" Integration time:1PLC |
| | "GAS" Input amplifier gain: ×10000 |
| | "ALO" Auto range level:20000 |
| | "RM1" COMPARE operation ON |
| | "PHL100E-6, 0E-12" |
| | Upper limit value:100 μA |
| | Lower limit value:0 pA |
| | "*SRE9" Setting the service request enable |
| | register to "9" |
| | "DSE8" Setting the device event status |
| | enable register to "8" |
| 110 | Comment sentence |
| 120 | Setting the discharge state |
| 125 | Setting the VS data to 0V |
| 130 | Setting the operation state |
| 140 | Setting the charge state |
| 150 | Waiting for 10ms |
| 160 | Setting the measurement state |
| 170 | Clearing the status byte register |
| 180 | Setting the initial value (101V) of VS data |
| | variable |
| 190 | Setting the VS data |
| 200 | Starting the measurement |
| 210 | Polling the meter to read the status byte |
| 220 | Branching to the line number 210 if the bit 0 of |
| | the status byte is "0" |
| 230 | Branching to the line number 270 if the bit 3 of |
| | the status byte is "1" |
| 240 | Adding "1" to the VS data variable data |
| 245 | Branching to the line number 295 when VS data is |
| | set up to 1000V |
| 250 | Branching to the line number 190 |
| 260 | Comment sentence |
| 270 | Executing the command to read VS data |
| 280 | Receiving the VS set data |
| 290 | Displaying the data |
| 295 | Setting the stand-by state |
| 300 | Ending the program |

7. INPUT/OUTPUT SIGNALS

The meter has the input/output signals for control shown below.

- Handler interface
- COMPLETE output signal
- TRIGGER input signal
- LID SIGNAL input signal

The following describes the above signals in order.

7.1 Handler Interface

The handler interface is the input/output signals to control the timing with the automatic equipment in the capacitor manufacturing line and external equipment including the auto prober and fixture.

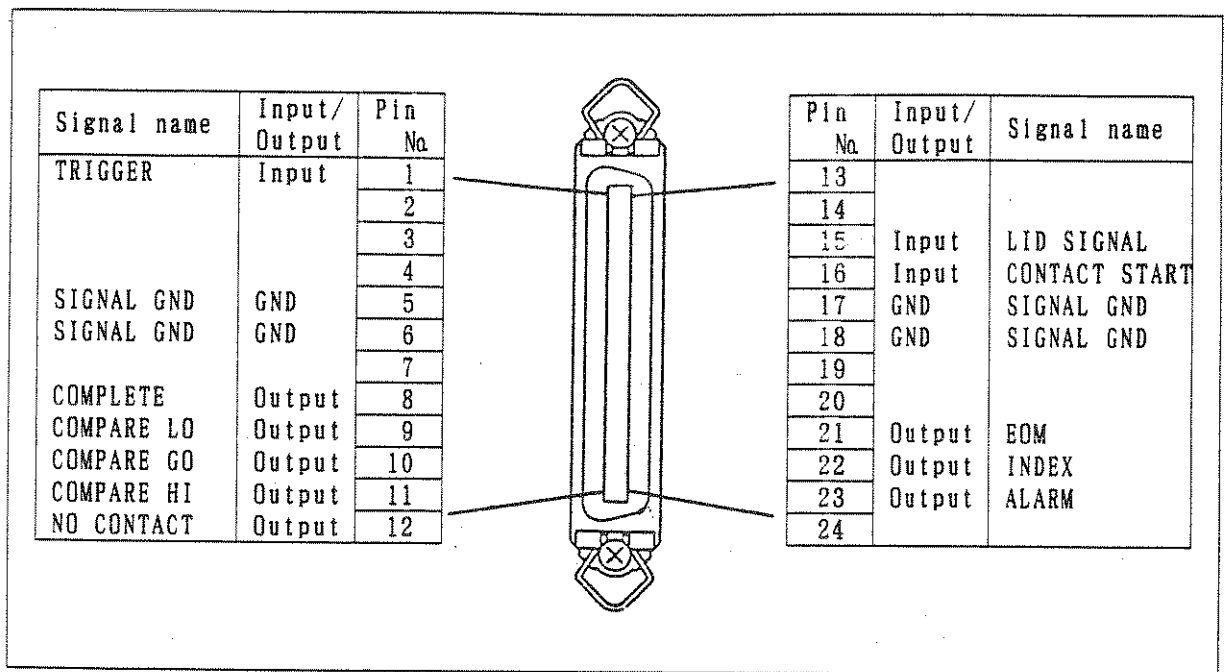

Figure 7 - 1 Description of Handler Interface Connector Pins

- (1) Connector used (Equivalent of DAIICHI DENSHIKOGYO Product)
 R8340/8340A body side:57-40240
 Connection cable side:57-30240

(2) Signal Level

The input/output signals are set to the TTL (equivalent of SN74LS series) level.

Negative logic (Active low)

HI level : +2.7V to 5.25V (Output signal)
 +3.2V to 5.25V (Input signal)

LO level : 0 to 0.6V (Output signal)
 0 to 0.5V (Input signal)

The output signal is equivalent to the SN74LS07N product and pulled up to 5V inside the open collector.

- ① TRIGGER Input : Measurement start signal
Pulse width : 100 μ S or more (Operated at the fall of pulse)
Chattering : 5ms or less
- ② CONTACT START Input : Contract-checking start signal
Pulse width : 100 μ S or more (Operated at the fall of pulse)
Chattering : 5ms or less
- ③ COMPLETE Output : Negative pulse signal is output when measurement operation ends and data can be output.
Pulse width : Approx. 500 μ S (Negative pulse)
- ④ LID SIGNAL : Lid operating signal
Operated as shown in Figure 7-2.

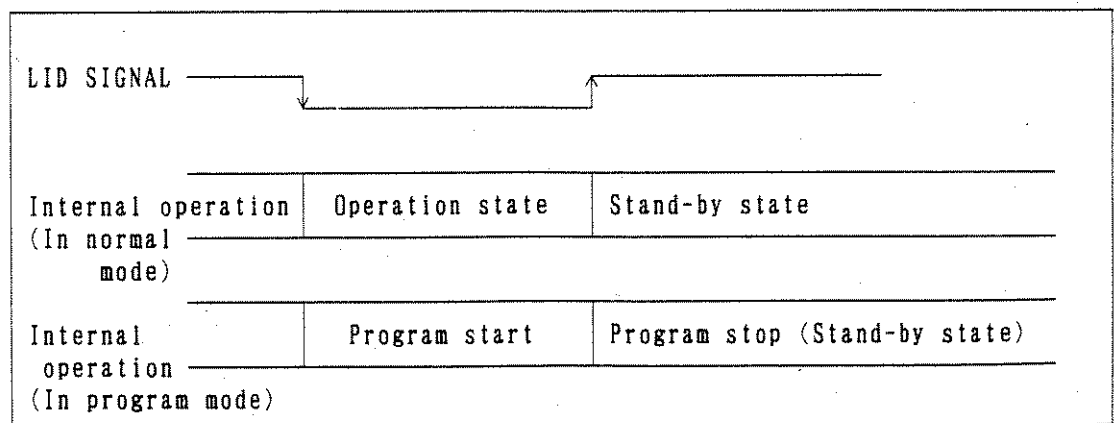

Figure 7 - 2 LID SIGNAL Timing

⑤ Other Output Signals

- COMPARE LO, GO, HI : As the result of comparator operation, any one of LO, GO, and HI signals becomes low level.
- NO CONTACT : As the result of contact checking, the signal becomes low level for judgment of imperfect contact.
- INDEX : Shows minimum time necessary for measurement.
The signal becomes low level after completion of measurement.
- EOM(End Of Measure) : Becomes low level after completion of measurement operation. (The signal is output at the same timing with COMPLETE.)
- ALARM : Becomes low level for internal trouble or breakdown.

(3) Handler Interface Timing

① At Start of Measurement

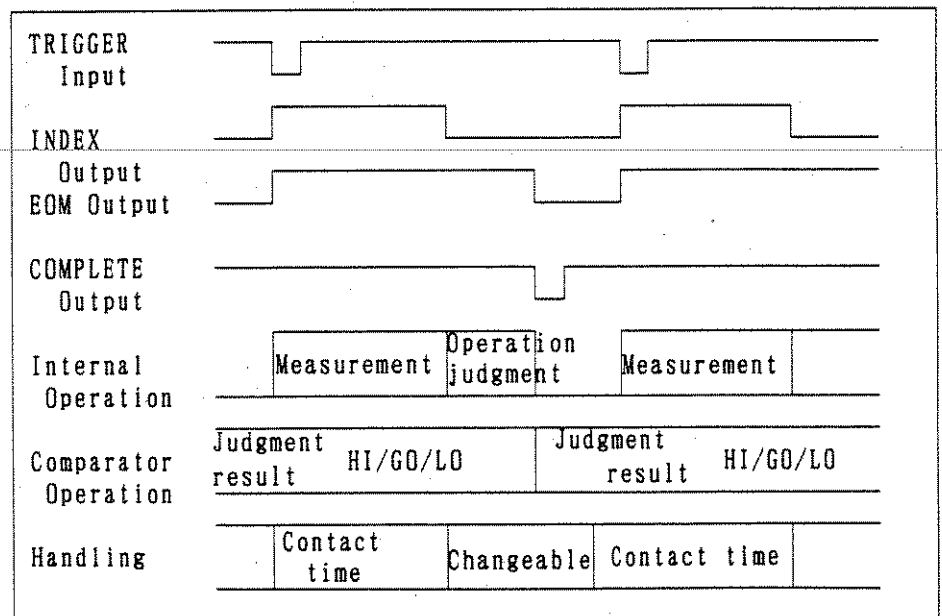

Figure 7 - 3 Handler Interface Timing

② At Start of Contact Checking

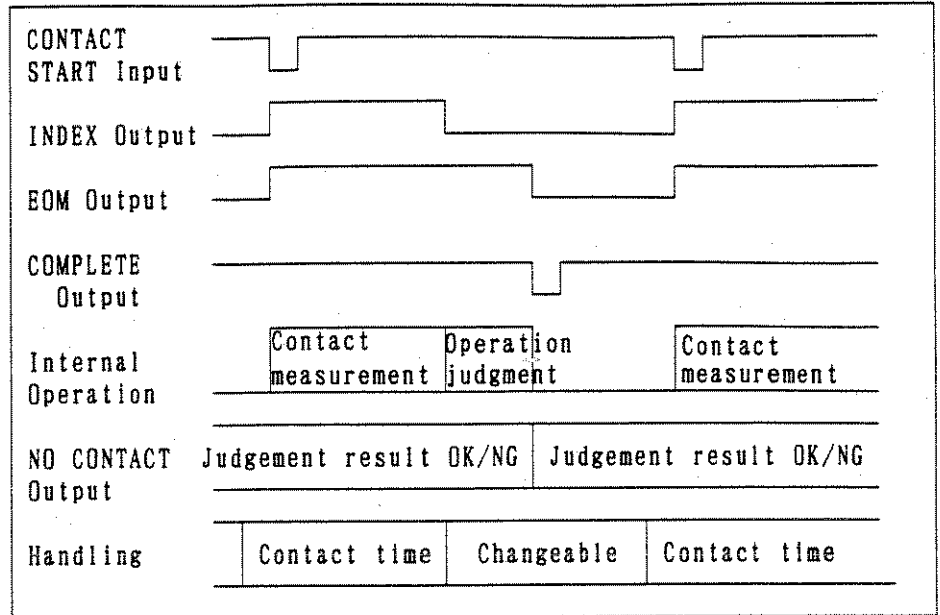

Figure 7 - 3 Handler Interface Timing (Cont'd)

- ③ When start of contact checking is detected during measurement.
 (Measurement is interrupted.)

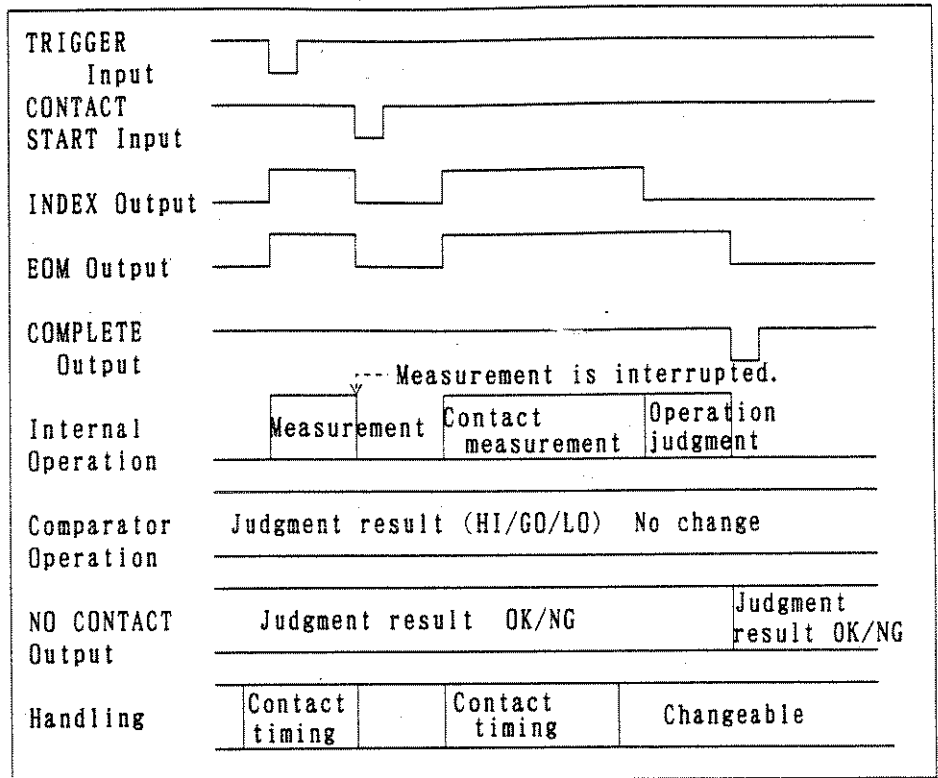

Figure 7 - 3 Handler Interface Timing (Cont'd)

④ When start of measurement is detected during contact checking.

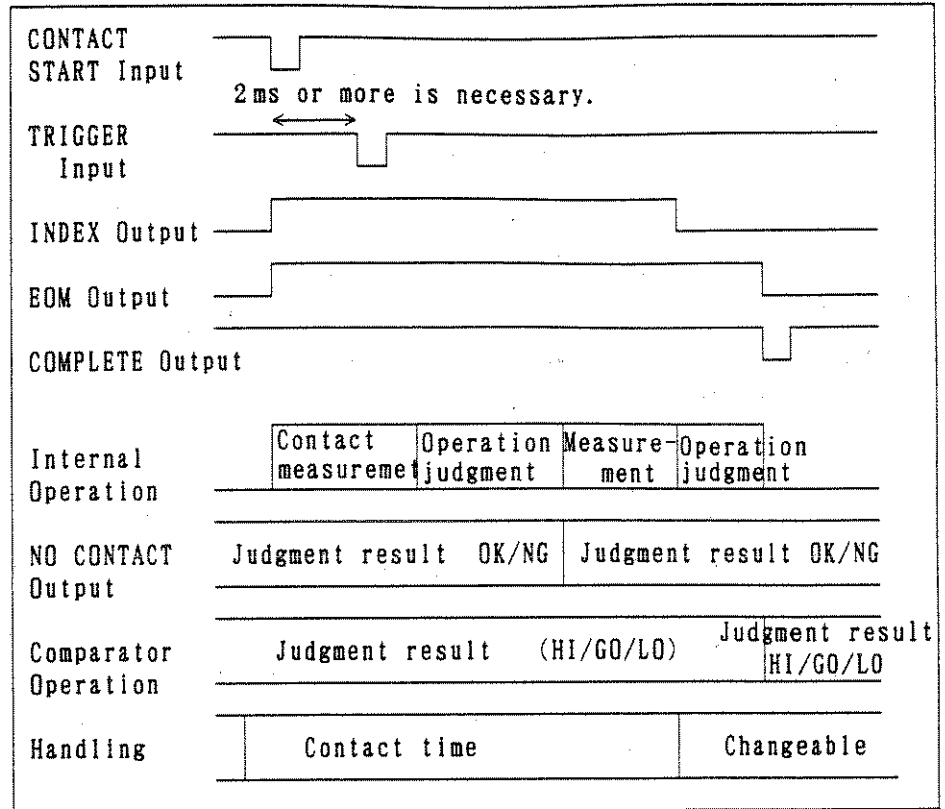

Figure 7 - 3 Handler Interface Timing (Cont'd)

- ⑤ When measurement start and contact checking are simultaneously detected.
 (Only in this case, contact checking is executed after measurement.)

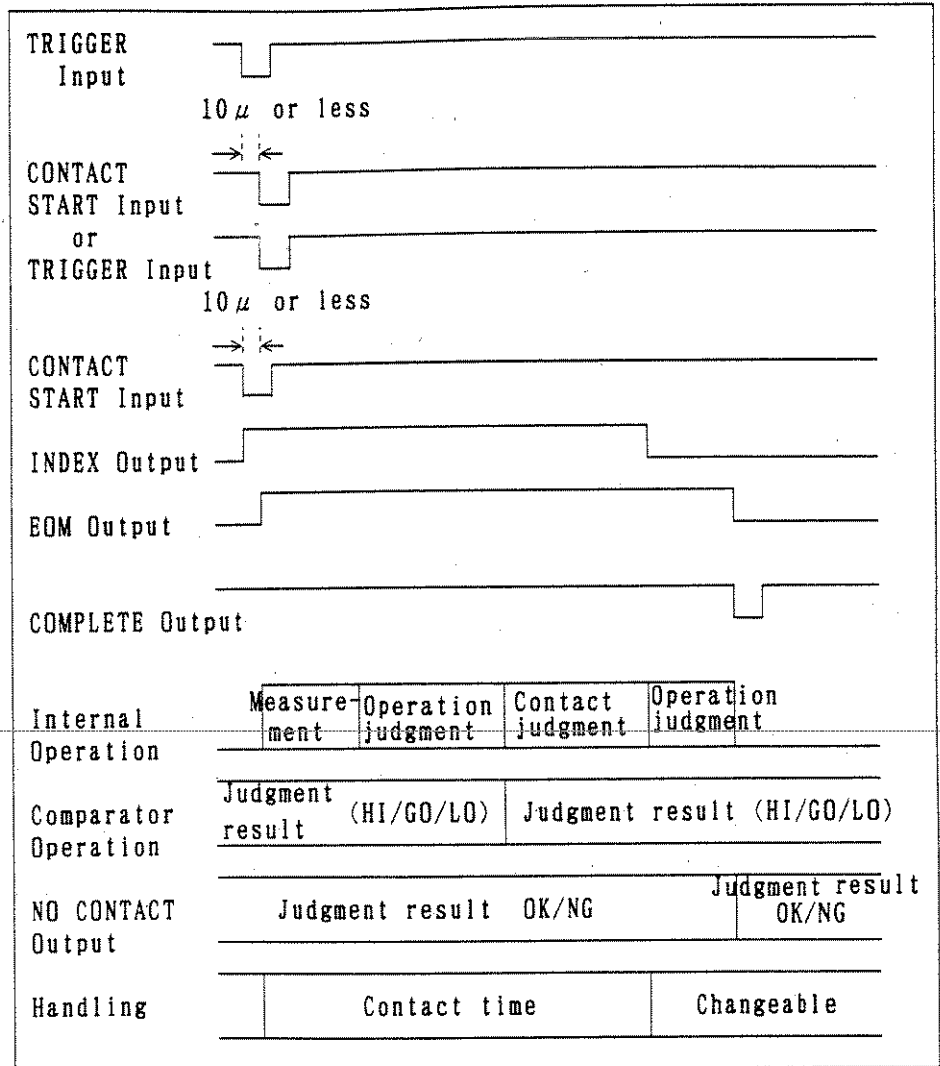

Figure 7 - 3 Handler Interface Timing (Cont'd)

7.2 COMPLETE Output Signal

The COMPLETE output signal is the output signal to notify end of measurement to the outside. The signal is also output at the end of one cycle for program measurement.

The output signal is set to the TTL (equivalent of SN74LS07N) level, which is the negative pulse signal with open collector output.

HI level : +2.7 to +5.25V 400 μ A max.
LO level : 0 to +0.6V -5mA max.
Pulse width : Approx. 500 μ s (Negative pulse)

7.3 TRIGGER Input Signal

The TRIGGER input signal is the input signal to externally start measurement, which also makes it possible to start program measurement. After measurement starts, the signal is effective when SAMPLING on the front panel of the meter is set to HOLD. The input signal is the negative pulse and starts the sampling at the trailing edge.

HI level : +3.2 to +5.25V
LO level : 0 to +0.5V
Pulse width : 100 μ s or more (Operated at the fall of pulse)
Chattering : 5ms or less

7.4 LID SIGNAL Input Signal

The LID SIGNAL input signal is the input signal to operate the fixture lid. The signal controls the operation/stand-by states in the normal measurement mode and the program start/stop in the program mode.

Figure 7-2 shows the LID SIGNAL timing.

HI level : +3.2 to +5.25V

LO level : 0 to +0.5V

8. BCD OUTPUT AND D/A OUTPUT (R8340A ONLY)

This function is given to the R8340A.

8.1 Selection of BCD OUTPUT

The R8340A realizes three types of outputs -- OFF (all high), BCD, and binary -- from the BCD OUTPUT connector on the rear panel. Select a type of output by setting parameter. For how to set parameters, see Item 4.5.2 "BCD OUTPUT". Because the signal for BCD and binary outputs is completely isolated from the analog system, the analog system is not affected by connecting external units.

8.1.1 BCD Output

Measured data is output as parallel signals in the form of the BCD (1-2-4-8) code. The BCD output is used for printout of measured data by a printer and interface for other units. Data stored in the internal memory is not output.

(1) Data Output Connector

Connector used (Equivalent of DAIICHI DENSHIKOGYO Product)
 R8340A body side : 57-40500
 Connection cable side : 57-30500

Figure 8-1 shows the relationship between output data name and pin number.

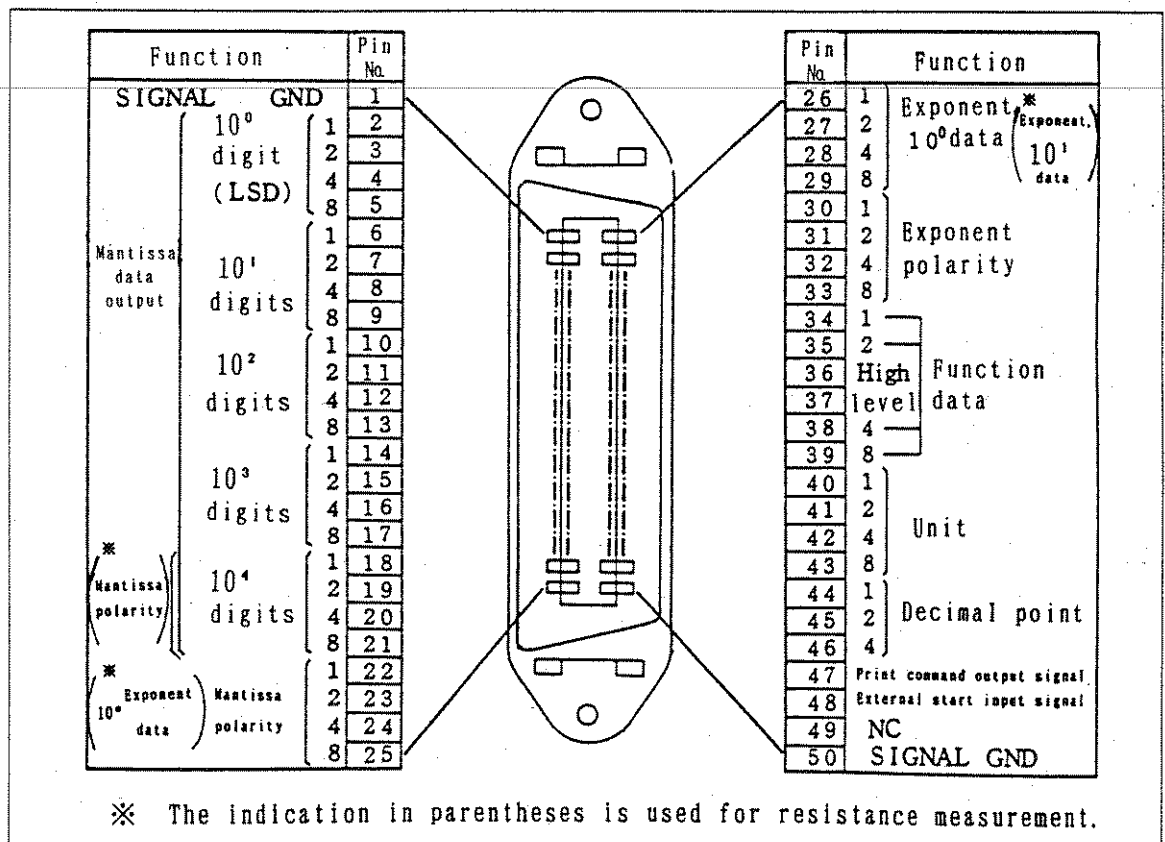
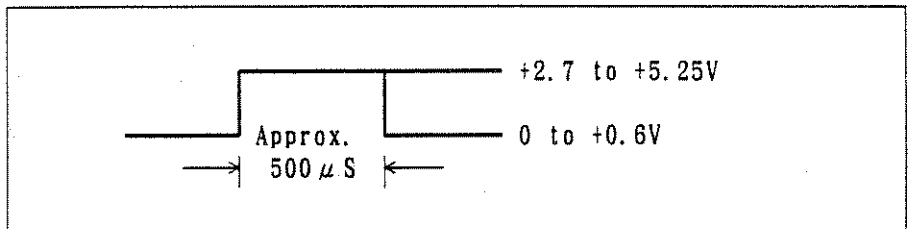

Figure 8 - 1 Description of BCD Data Output Connector Pins

(2) Signal Level

The output signal level uses the TTL (equivalent of SN74LS series) level as follows:

- ① Data Output : BCD (1-2-4-8) code
 Positive logic
 HI level : +2.7V to +5.25V
 400 μ A max.
 LO level : 0 to 0.6V
 -5mA max.
- ② Print command signal : Positive pulse
 HI level : +2.7V to +5.25V
 400 μ A max.
 LO level : 0 to 0.6V
 -5mA max.
 Pulse width : Approx. 500 μ S



③ Output Circuit

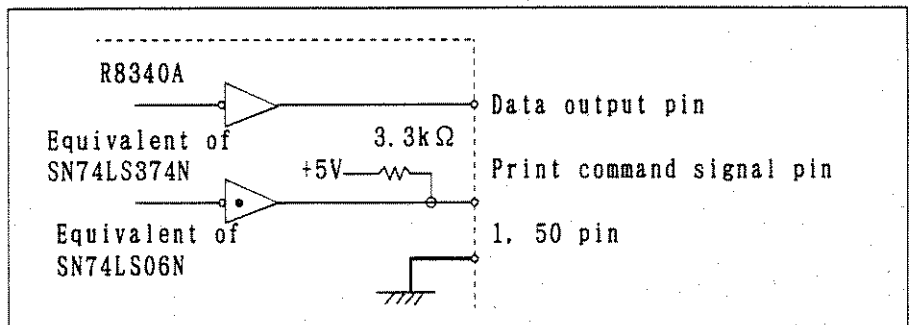

(3) Output Data Contents

① Measured Data

Value : Five digits (The following shows the relationship between digit and decimal point.)

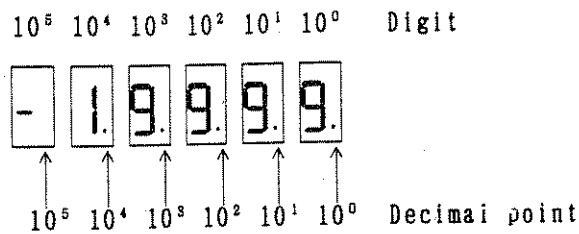

- Polarity : To be output in four bits as 10^5 digit data
- Decimal point : To be output in three bits
- Unit : To be output in four bits
- Others : To be output in four bits as function data for discrimination of type of data

Table 8-1 shows data output codes.

② Print Command Signal

The print command signal with the pulse width of approx. 500 μ s is output to the pin 47 synchronously with the end of measurement for one sample. Data contents are guaranteed by the output timing of the signal.

(4) External Start Input Signal

When SAMPLING on the front panel of the meter is set to HOLD, it is possible to externally input the measurement start signal. The external start signal inputs positive pulse between the pin 48 and the SIGNAL (1, pin 50). When inputting the start signal repeatedly, input it after the print command signal is output.

- HI level : +3.2 to +5.25V
- LO level : 0 to +0.5V
- Pulse width : 100 μ s or more (Operated at the rise of pulse)
- Chattering : 5ms or less

Table 8 - 1 Data Output Codes

| Output name | Output data | Code | | | |
|---------------|---|-------------|-------------|-------------|-------------|
| | | 8 | 4 | 2 | 1 |
| Data | 0 | 0 | 0 | 0 | 0 |
| | 1 | 0 | 0 | 0 | 1 |
| | 2 | 0 | 0 | 1 | 0 |
| | 3 | 0 | 0 | 1 | 1 |
| | 4 | 0 | 1 | 0 | 0 |
| | 5 | 0 | 1 | 0 | 1 |
| | 6 | 0 | 1 | 1 | 0 |
| | 7 | 0 | 1 | 1 | 1 |
| | 8 | 1 | 0 | 0 | 0 |
| | 9 | 1 | 0 | 0 | 1 |
| Polarity | Blank (Space) | 1 | 1 | 0 | 1 |
| | Blank (Space) | 1 | 1 | 1 | 1 |
| | Negative (-) Positive (+) Blank (Space) | 1 1 1 | 0 0 1 | 1 1 1 | 0 1 1 |
| Decimal point | 10 ⁰ | | 0 | 0 | 0 |
| | 10 ¹ | | 0 | 0 | 1 |
| | 10 ² | | 0 | 1 | 0 |
| | 10 ³ | | 0 | 1 | 1 |
| | 10 ⁴ | | 1 | 0 | 0 |
| | 10 ⁵ | | 1 | 0 | 1 |
| Function data | OVER (*) | 0 | 0 | 0 | 0 |
| | GO (Space) | 0 | 1 | 1 | 0 |
| | LO (>) | 1 | 0 | 0 | 0 |
| | HI (<) | 1 | 0 | 0 | 1 |
| | Data when limiter is applied (#) | 0 | 1 | 1 | 1 |
| | NULL (L) | 1 | 1 | 1 | 0 |
| | Others (Space) | 1 | 1 | 1 | 1 |

1 : HI level
 0 : LO level

Table 8 - 1 Data Output Codes (Cont'd)

| Output name | Output data | Code | | | |
|-------------|-----------------------|------|---|---|---|
| | | 8 | 4 | 2 | 1 |
| Unit | Ω (Ω) | 0 | 1 | 0 | 0 |
| | A (Space) | 1 | 1 | 1 | 1 |

1 : HI level
0 : LO level

Note: Data in parentheses shown by the polarity, function data, and unit is the print character when connecting the TR6198 digital printer.

When function data is simultaneously produced, the priority for indication is given as shown below.

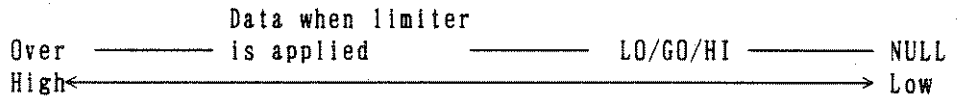

(5) Data output example of each IM/RM (For TR6198 digital printer)

Table 8 - 2 Data Output Example

| IM/RM | Indication | BCD data output |
|-------|--------------------------|---------------------|
| IM | $\pm 199.99\text{pA}$ | - 9 \pm .19999 |
| | $\pm 1.9999\text{nA}$ | - 9 \pm 1.9999 |
| | $\pm 99.99\ \mu\text{A}$ | - 6 \pm 099.99 |
| RM | $1.999 + 3\ \Omega$ | + 03 1.999 Ω |
| | $1.999 + 12\ \Omega$ | + 12 1.999 Ω |
| | 9. + 1 Ω | + 01 0009. Ω |
| | 9.9 + 13 Ω | + 13 009.9 Ω |

----- Exponent polarity
 ----- Exponent data
 ----- Mantissa polarity
 (Mantissa data
 Decimal point
 ----- Unit

8.1.2 Binary Output

Measured data is converted into binary parallel data and output. The data stored in the internal memory is not output.

(1) Data Output Connector

The connector used is common to that for BCD output. See Item (1) of 8.1.1.

Figure 8-2 shows the relationship between output data name and pin No.

(2) Signal Level

The output signal level is the same with that of BCD output. See Item (2) of 8.1.1.

(3) Output Data Contents

① Mantissa Part Data

The mantissa part data is output between 0 and 32768 in the form of 15-bit binary absolute value. The signal level uses positive logic.

② Mantissa Part Sign

The sign shows the polarity of mantissa part data. The signal level uses positive logic, which is "+" for 0 and "-" for 1.

③ Exponent Part Data

The exponent part data is output between 0 and 128 in the form of 7-bit binary absolute value. The signal level uses positive logic.

④ Exponent Part Sign

The sign shows the polarity of exponent part data. The signal level uses positive logic, which is "+" for 0 and "-" for 1.

⑤ Function Data

The data shows the measurement state. The following is the description of each pin.
 The signal level uses positive logic.

| | | | | | | | |
|----|----|----|----|----|----|----|----|
| b7 | b6 | b5 | b4 | b3 | b2 | b1 | b0 |
|----|----|----|----|----|----|----|----|

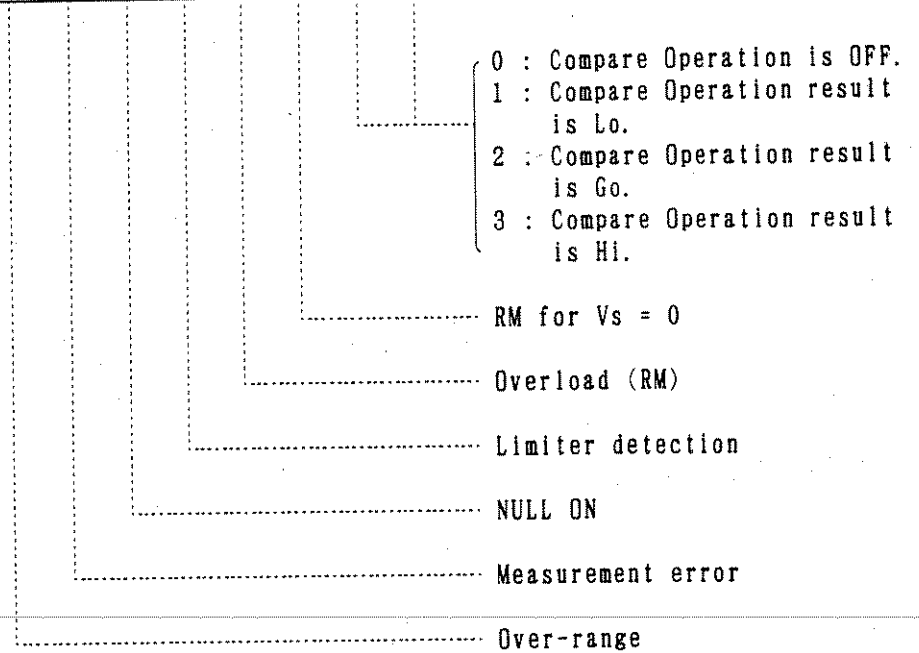

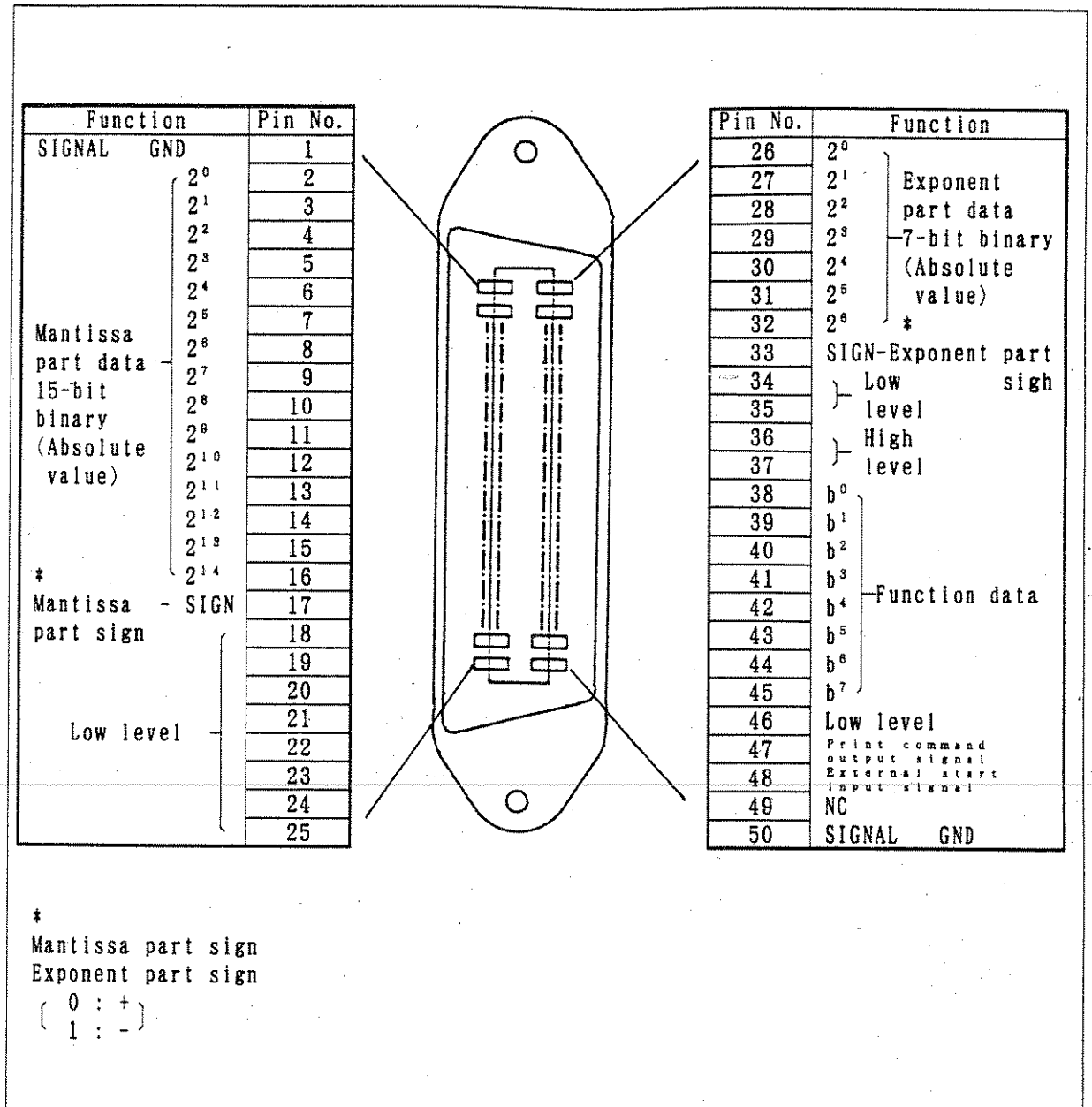

Figure 8 - 2 Description of Binary-output Connector Pins

8.2 D/A Output

Measured data is converted into analog signal by the D/A converter and output to the DA OUTPUT terminal on the rear panel. The conversion output can be set to any number of digits within three consecutive digits among data displayed by the full scale of 1V. The +50% offset voltage can also be set.

(1) Specification

Output voltage : -1 to +1V
 Conversion accuracy : $\pm 0.2\% \pm 2d$
 Output resistance : 1Ω or less
 Maximum load current : $\pm 0.5\text{mA}$
 Output terminal : Binding post

(2) Setting the number of digits for output data

See Item 4.5.1 "DA OUTPUT".

Figure 8-3 shows the relationship between indicated data and output voltage.

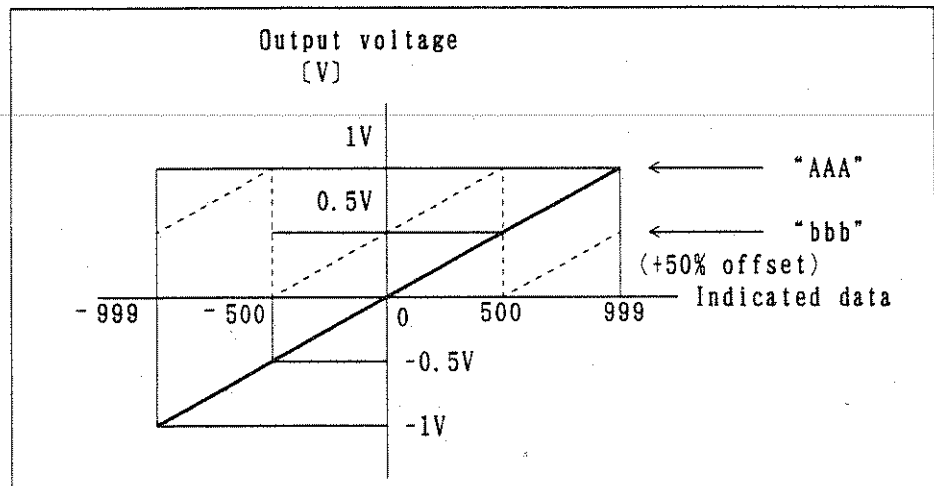

Figure 8 - 3 Output Voltage of DA OUTPUT

CAUTION:

When +50% offset voltage is set ("bbb"), output with no polarity is generated as shown by a dotted line in Figure 8-3.

9. TROUBLESHOOTING AND CALIBRATION

This section describes the troubleshooting method when a trouble occurs in the meter and the calibration method to maintain the measurement accuracy.

9.1 Before Requesting Repair

If a trouble occurs during operation of the meter, troubleshoot the meter according to Table 9-1. If the trouble is not settled even after troubleshooting, contact a nearby sales office, or your dealer.

Even for the repair of the following troubles, we will ask you for the repair charge if they are repaired by us. Therefore, make troubleshooting according to the table below before you request repair to us.

Table 9 - 1 Troubleshooting Items

| Symptom | Probable cause | Remedy |
|---|---|--|
| No indication appears. | 1. The power fuse blows. | 1. Replace the fuse with the attached one. (See Item 1.3.5.) |
| Measured value is unstable or abnormal. | 2. The IM/RM or range is incorrectly set. 3. The power frequency is erroneously set to 50 or 60Hz. | 2. Recheck the IM/RM or range setting. 3. Adjust the frequency to the AC power frequency used. (See Item 4.5.4.) |
| Though the input signal is applied, no measurement is executed. | 4. The cable is connected to an incorrect terminal. 5. The input protection fuse blows. 6. The measurement state is not set. 7. The cable is disconnected. | 4. Connect the input cable to the correct input terminal. 5. Replace the fuse with the attached one. (See Item 1.3.5.) 6. Press the MEASURE key to set the measurement state. 7. Check the cable with a multimeter and replace it if it is faulty. |
| No voltage is generated. | 8. The voltage is set to 0V. 9. The discharge state is set. 10. The state is stand-by because over-voltage input is detected. | 8. Check the generated-voltage set value. 9. Press the CHARGE/MEASURE key to set the charge/measurement state. 10. Remove the connection cable. |

9.2 Calibration

This section describes the calibration method with one cycle of measurement accuracy assurance period (six months) to maintain the measurement accuracy shown in Section 12. "Performance data".

9.2.1 Preparation and Precaution for Calibration

The following describes the equipment and precautions for calibration.

(1) Equipment Necessary for Calibration

Use the equipment in Table 9-2 or those with the performance equal to or better than that of the equipment in Table 9-2 as the standard equipment.

Table 9 - 2 Equipment Necessary for Calibration

| Calibration equipment | Range | Accuracy | Recommended equipment |
|-----------------------------------|---|--|---|
| Standard DC voltage generator | $\pm 0\text{mV}$ to ± 20 | Within $\pm 0.005\%$ | TR6120 (Made by ADVANTEST CORPORATION) |
| Standard direct-current generator | $\pm 0\ \mu\text{A}$ to $\pm 2\text{mA}$ | Within $\pm 0.01\%$ | TR6120 (Made by ADVANTEST CORPORATION) |
| Standard resistor | $0\ \Omega$ to $20\text{M}\Omega$ $100\text{M}\Omega$ $1\text{G}\Omega$ $10\text{G}\Omega$ | Within $\pm 0.01\%$ Within $\pm 0.03\%$ Within $\pm 0.14\%$ Within $\pm 0.14\%$ | |
| Digital voltmeter | 0 to 1000V | Within $\pm 0.005\%$ | TR6878, TR6871, R6871E (Made by ADVANTEST CORPORATION) |

(2) Cables Necessary for Calibration

Table 9-3 shows the cables necessary for calibration.

Table 9 - 3 Cables Necessary for Calibration

| Product name | Standard |
|-------------------------------------|---------------|
| Input/output cable | A01010 |
| Input cable | BI-109 |
| TRIAx-BNC cable +BNCJ-MP adapter | A01011+A04207 |

(3) General Cautions for Calibration

- ① Use the specified voltage for the AC power supply.
- ② Use parameters according to the power frequency to set the frequency to 50 or 60Hz.
- ③ To connect the power cable, Check if the power switch is turned off.
- ④ Perform calibration under the ambient conditions shown below.
 Temperature : $+23^{\circ}\text{C} \pm 3^{\circ}\text{C}$
 Relative humidity: 70% or less
 Perform calibration at the place free from dust, vibration, and noise.
- ⑤ Preheat each calibration equipment for the specified time.
 Preheat the meter for 1 hr or more. (For calibration)
- ⑥ After calibration, it is recommended to indicate the calibration date and the next calibration time limit using a card or sticker.

9.2.2 Calibration Data Initialization

When initializing calibration data, the whole calibration data is deleted and the typical value of calibration data is set. If "ERR2" (Breakdown of calibration primary data) occurs, initialize the calibration data. Then continue calibration according to the procedure in Item 9.2.3. The following describes how to initialize calibration data.

Operation

- ① Turn off the power switch.
- ② Set the EXIT CAL switch on the rear panel to ON.
- ③ Immediately after turning on the power switch, press the  key.

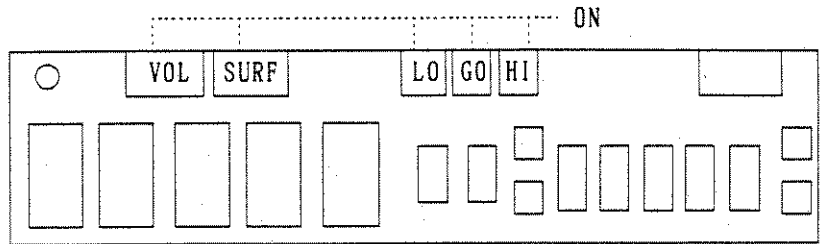

Calibration correction mode

- ④ When the  key is pressed, the initial value is set to calibration data.

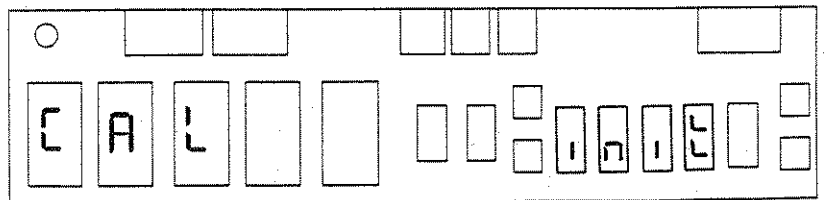

During setting the initial value

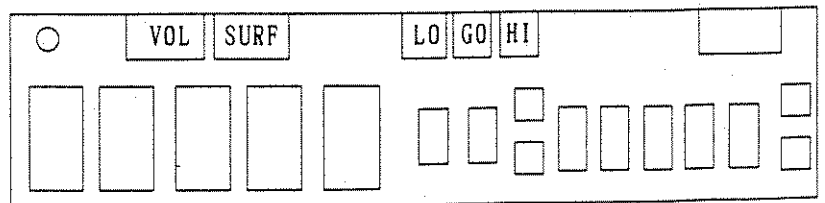

End of initial value setting.
 Calibration correction mode

9.2.3 Calibration Method

For normal calibration, the calibration in the following Item (1) is skipped and the calibration checking and adjustment in the following Item (2) is executed.

However, any condition comes under the following three items, perform the operation in both Items (1) and (2).

- When an indication of the meter is deviated 10 counts or more from that of the standard meter.
- When calibration data is initialized.
- When "ERR2" occurs.

The following shows key functions in the calibration mode.

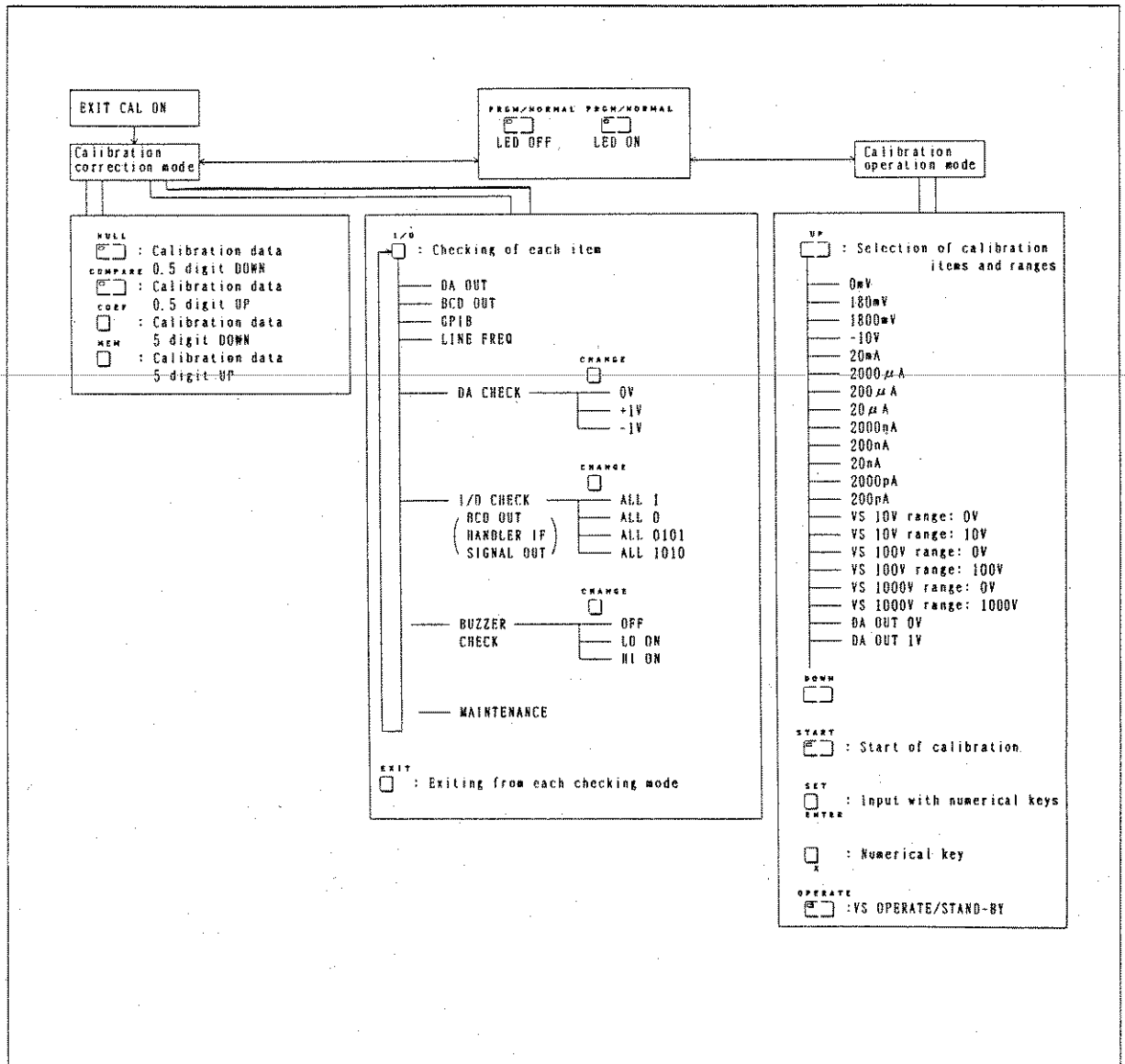

Figure 9 - 1 Key Functions in Calibration Mode

(1) Calibration (Calibration operation mode)

Perform calibration for each item and each range.

Select calibration items with the ^{UP} and ^{DOWN} keys.

One item advances by pressing the ^{UP} key and goes back by

pressing the ^{DOWN} key. The calibration items ranges between ① and ⑩. Items ① through ② are the calibration for current measurement, items ② through ④ are the calibration for voltage generation, and items ③ through ⑩ are the calibration for DA OUTPUT (R8340A only).

For items ① through ⑧, the calibration is made by applying the internal standard voltage to the AD converter.

(1-1) Calibration for Current Measurement

Operation (① through ②)

- ① Turn on the power switch.
- ② Set the EXIT CAL switch on the rear panel to ON.

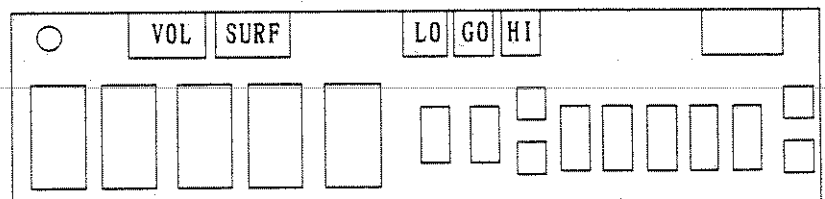

Calibration correction mode

- ③ Connect the input/output cable (A01010) to the meter and connect the short bar as shown in Figure 9-2.

- ④ Press the ^{PRGM/NORMAL} key, and the LED on the key lights.

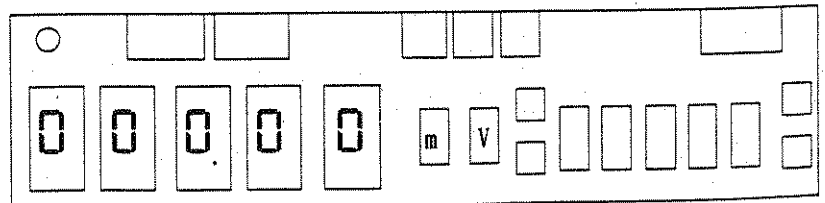

Calibration correction mode

- ④-1 Connect the red and blue input cables to short-circuit the input and perform the following procedures.
(Disconnect the black cable.)
- ④-2 Press the ^{START} key, and the LED on the key lights and the calibration starts.
When the LED on the key goes out, the calibration for 0mV ends.

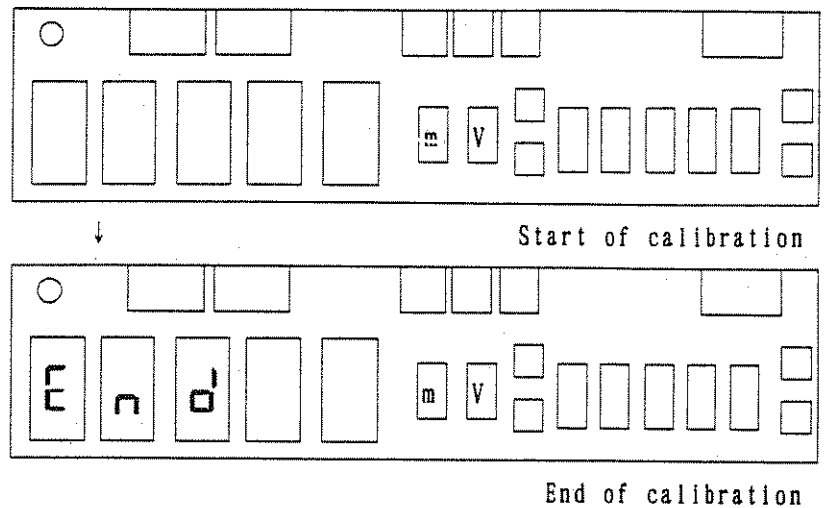

- ⑤ Connect the standard DC voltage/current generators with the meter as shown in Figure 9-2 (C). (Disconnect the black cable.)
- ⑥ Press the ^{UP} key.
- ⑥-1 Set the standard DC voltage generator to +180.00mV.

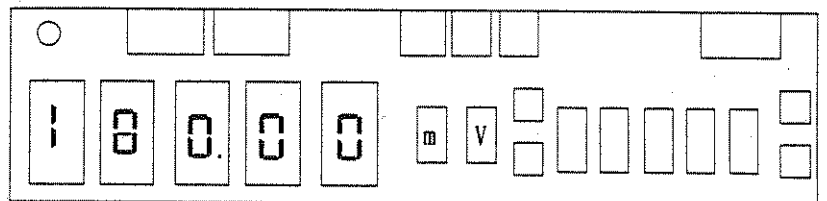

Unless the standard DC voltage generator can be set to the indication value of the meter, adjust the value to the output value of the standard DC voltage generator through key-in operation.

When the standard DC voltage generator outputs 170.00mV, for example, set the value by pressing the keys

SET

Subsequently, unless the standard equipment output value can be set to the indication value, set the value according to the above procedure. For the setting range, see Table 9-5 to use the standard equipment within the range.

⑥-2 Press the ^{START} key to execute the calibration for 180.00mV according to the procedure in Item ④.

⑦ Press the ^{UP} key.

When pressing the ^{DOWN} key instead of the ^{UP} key, the preceding item appears.

⑦-1 Set the standard DC voltage generator to +1800.0mV.

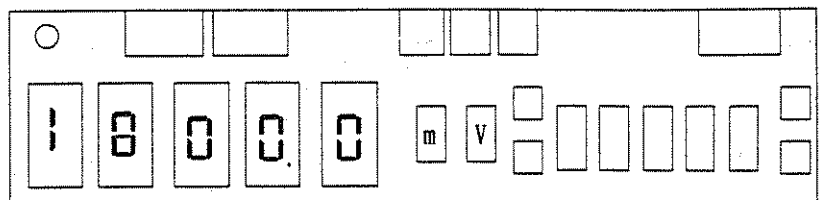

⑦-2 Press the ^{START} key to execute the calibration for 1800.00mV according to the procedure in Item ④.

⑧ Connect the black clip and the blue clip to the same terminal.

⑨ Press the ^{UP} key.

⑨-1 Set the standard DC voltage generator to -10.000V.

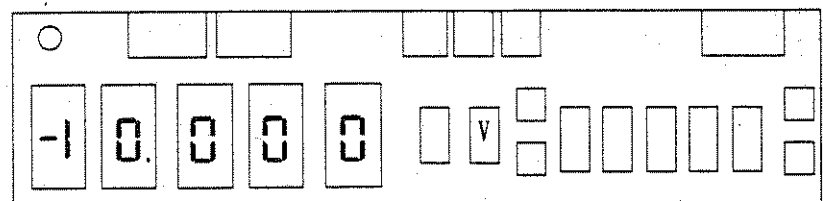

⑨-2 Press the ^{START} key to execute the calibration for -10.000V according to the procedure in Item ④.

⑩ Disconnect the black clip.

⑪ Press the ^{UP} key.

⑪-1 Set the standard direct-current generator to +20.000mA.

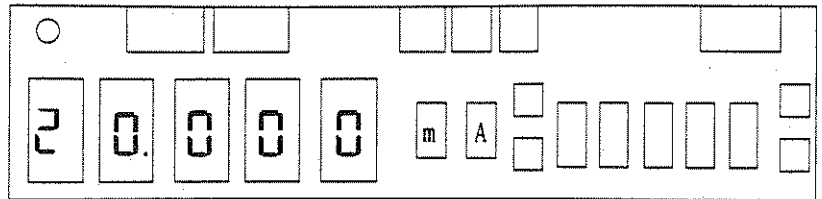

⑪-2 Press the ^{START} key to execute the calibration for +20.000mA according to the procedure in Item ④.

⑫ Press the ^{UP} key.

⑫-1 Set the standard direct-current generator to +2000.0 μA.

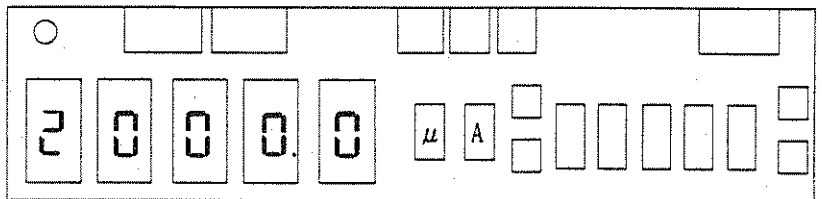

⑫-2 Press the ^{START} key to execute the calibration for +2000.0 μA according to the procedure in Item ④.

⑬ Press the ^{UP} key.

⑬-1 Set the standard direct-current generator to +200.00 μA.

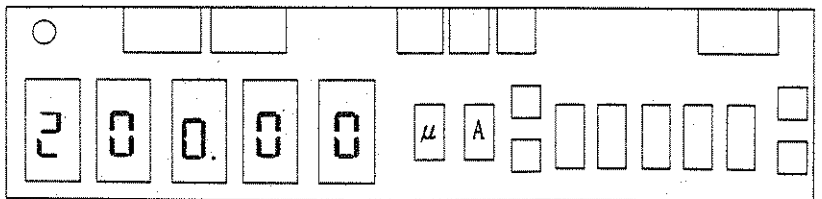

⑬-2 Press the ^{START} key to execute the calibration for +200.00 μA according to the procedure in Item ④.

⑭ Connect the standard direct-current generator with the standard resistance as shown in Figure 9-2 (b).

15 Press the ^{UP} key.

15-1 Set the standard direct-current generator so that the input current will be $+20.000 \mu\text{A}$ according to Table 9-4.

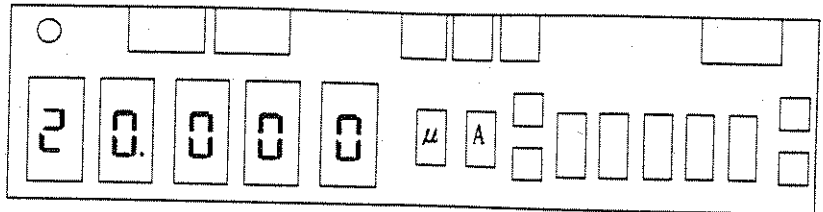

15-2 Press the ^{START} key to execute the calibration for $+20.000 \mu\text{A}$ according to the procedure in Item 4.

16 Press the ^{UP} key.

16-1 Set the standard direct-current generator so that the input current will be $+2000.0\text{nA}$ according to Table 9-4.

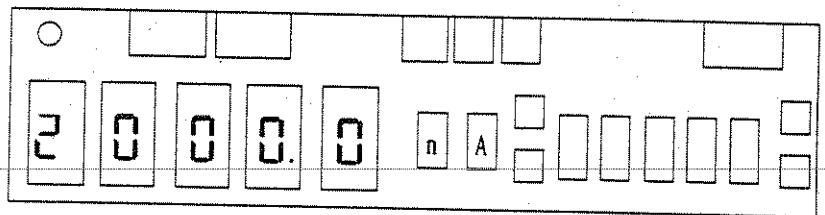

16-2 Press the ^{START} key to execute the calibration for $+2000.0 \text{nA}$ according to the procedure in Item 4.

17 Connect the standard direct-current generator with the standard resistance as shown in Figure 9-2 (a).

18 Press the ^{UP} key.

18-1 Set the standard direct-current generator so that the input current will be $+200.00\text{nA}$ according to Table 9-4.

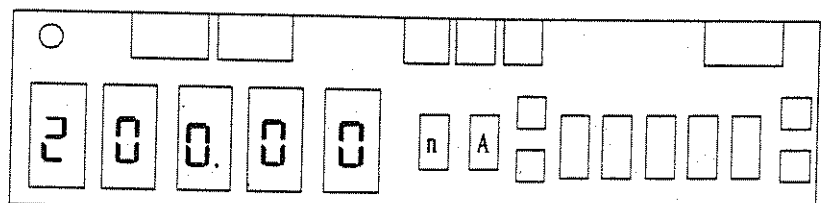

18-2 Press the ^{START} key to execute the calibration for $+200.00 \text{nA}$ according to the procedure in Item 4.

⑱ Press the ^{UP} key.

⑱-1 Set the standard direct-current generator so that the input current will be +20.000nA according to Table 9-4.

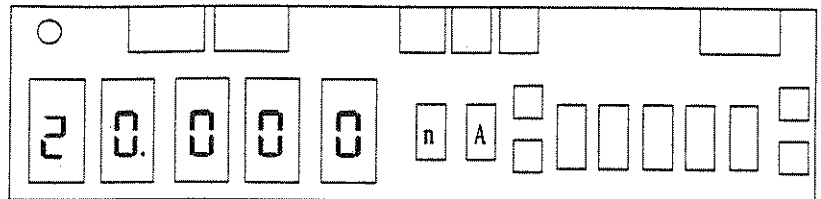

⑱-2 Press the ^{START} key to execute the calibration for +20.000 nA according to the procedure in Item ④.

⑳ Press the ^{UP} key.

⑳-1 Set the standard direct-current generator so that the input current will be +2000.0pA according to Table 9-4.

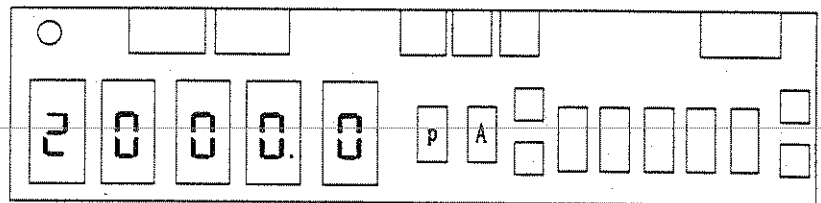

⑳-2 Press the ^{START} key to execute the calibration for +2000.0 pA according to the procedure in Item ④.

㉑ Press the ^{UP} key.

㉑-1 Set the standard direct-current generator so that the input current will be +200.00pA according to Table 9-4.

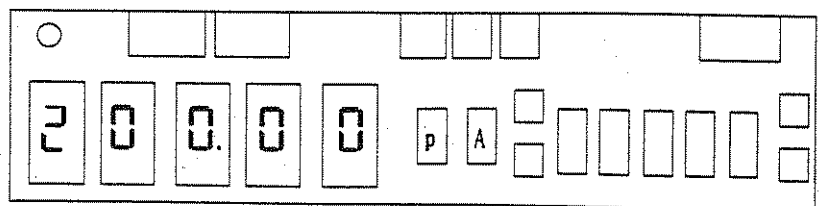

㉑-2 Press the ^{START} key to execute the calibration for +200.00 pA according to the procedure in Item ④.

(1-2) Calibration for Voltage Generation

Operation (22 through 24)

22 Make connection as shown in Figure 9-3.

23 Press the ^{UP} key.

23-1 Press the ^{OPERATE} key, and the LED on the key lights.

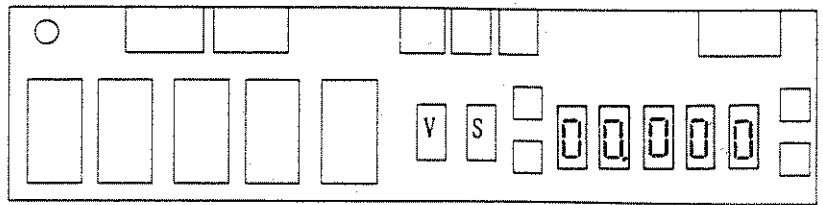

24 Read the indication value on the digital voltmeter to input the value. When the voltmeter reads "-0.012 V", for example:

24-1 Set the ^{SET} key.

24-2 Key in ^{+/-} 0 0 1 2 ENTER

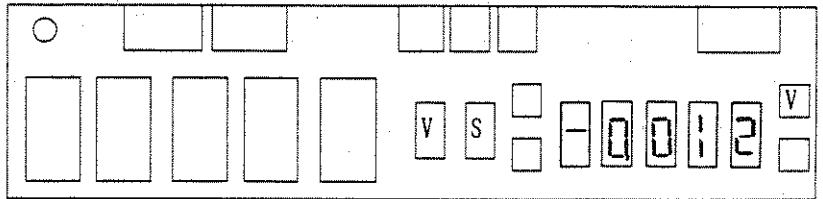

- 24-3 Press the ^{START}  key, and the LED on the key lights and the calibration starts.
When the LED on the key goes out, the calibration ends.

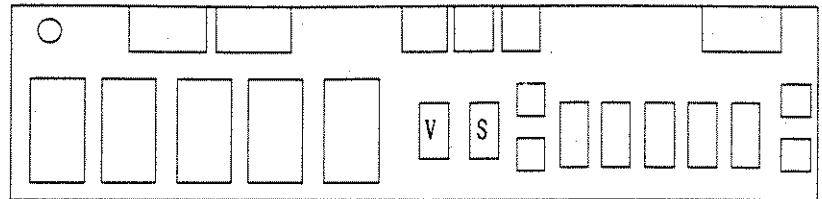

↓

Start of calibration

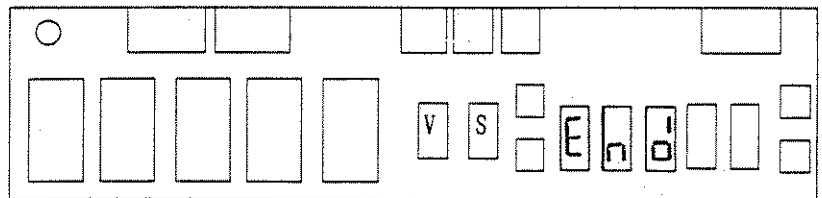

End of calibration

- 25 Press the ^{UP}  key.

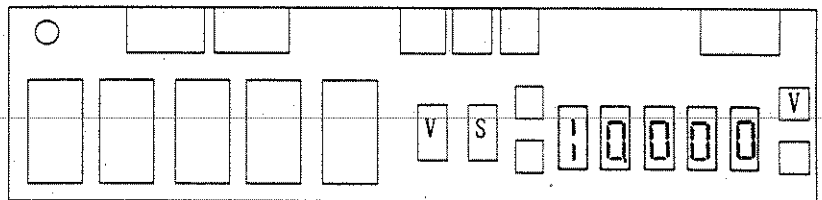

Similarly to Item 24, read the indication value on the digital voltmeter to input the value and execute the

the calibration by pressing the ^{START}  key.

CAUTION

Be sure to execute the calibration for voltage generation in order of 0V to full scale for each range.
The calibration is internally executed with the data for two points of 0V and full scale.

- 26 Press the ^{UP}  key.

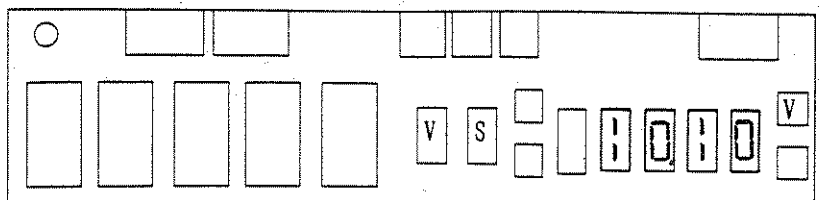

Similarly to Item 24, read the indication value on the digital voltmeter to input the value and execute the

calibration by pressing the ^{START}  key.

27 Press the ^{UP}  key.

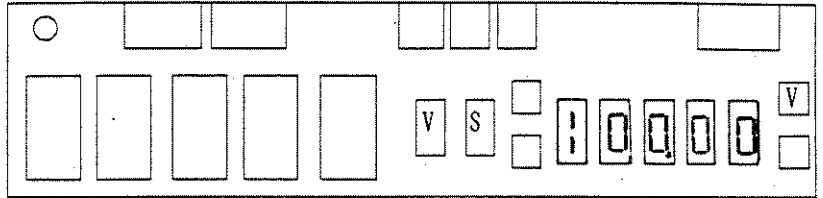

Similarly to Item 24, read the indication value on the digital voltmeter to input the value and execute the

calibration by pressing the ^{START}  key.

28 Press the ^{UP}  key.

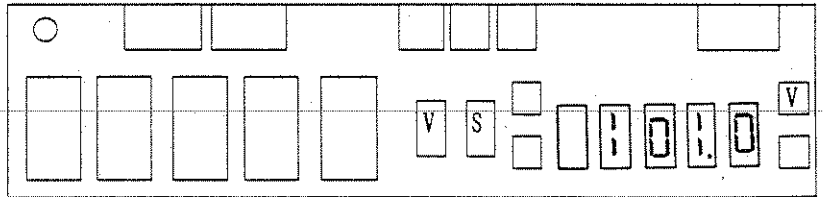

Similarly to Item 24, read the indication value on the digital voltmeter to input the value and execute the

calibration by pressing the ^{START}  key.

29 Press the ^{UP}  key.

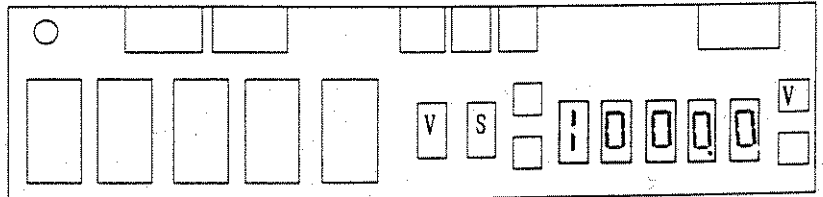

Similarly to Item 24, read the indication value on the digital voltmeter to input the value and execute the

calibration by pressing the ^{START}  key.

(1-3) Calibration for DA OUTPUT (R8340A only)

Operation

- ③ Press the key.

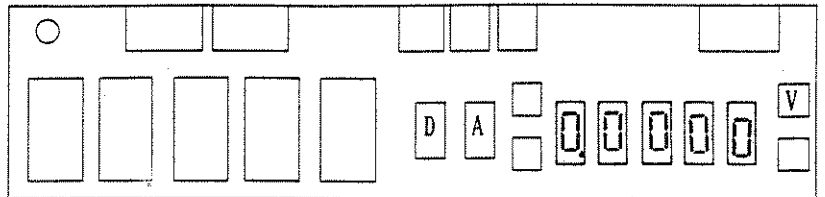

Similarly to Item ②, read the indication value on the digital voltmeter to input the value and execute the

calibration by pressing the key.

- ④ Press the key.

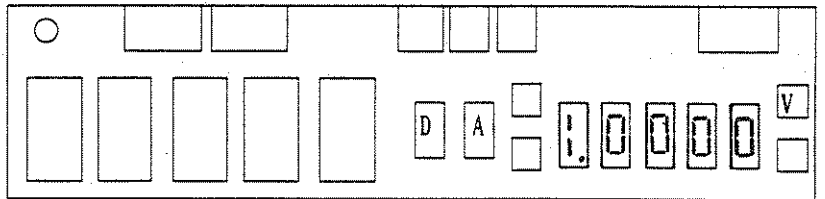

Similarly to Item ②, read the indication value on the digital voltmeter to input the value and execute the

calibration by pressing the key.

This completes the whole calibration. Then start the operation in Item (2).

CAUTION

1. To execute the calibration for current measurement with the TR6120, use only the ranges 200 μ A, 2mA, and 20mA.
2. For the calibration for the range of 200 μ A or less, use the V function of TR6120 and the standard resistor.
3. For the calibration for the range of 200nA or less, it is recommended to use the input cables A01011 and A04207 for the TR6120 and TR45 to decrease the influence of induction noise.
4. The calibration for the range of 200nA or less (especially for the range of 2nA or less) requires the time between several seconds and several tens of seconds. Protect the cable and body from vibration.

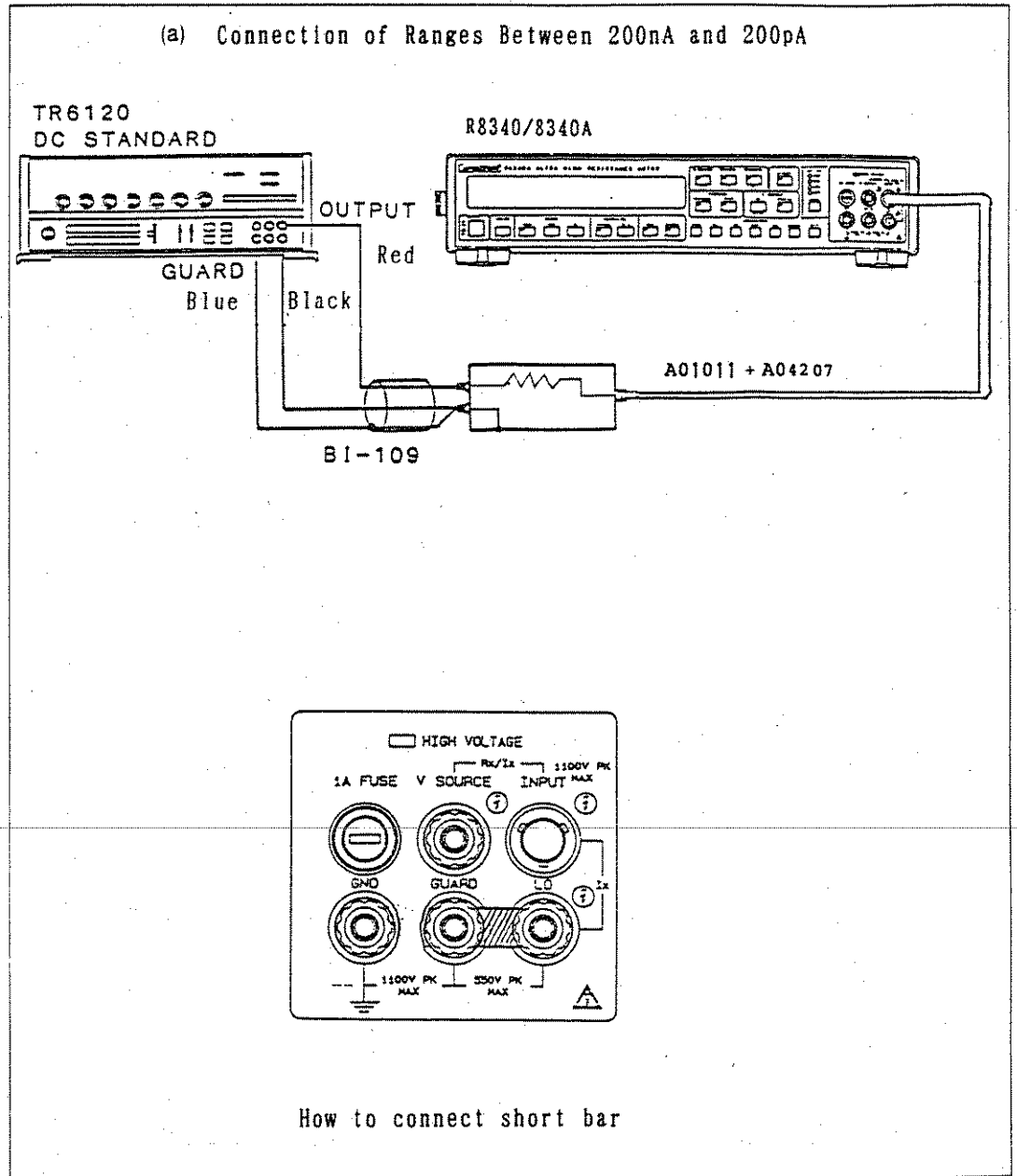

Figure 9 - 2 Connection for Current Measurement Calibration

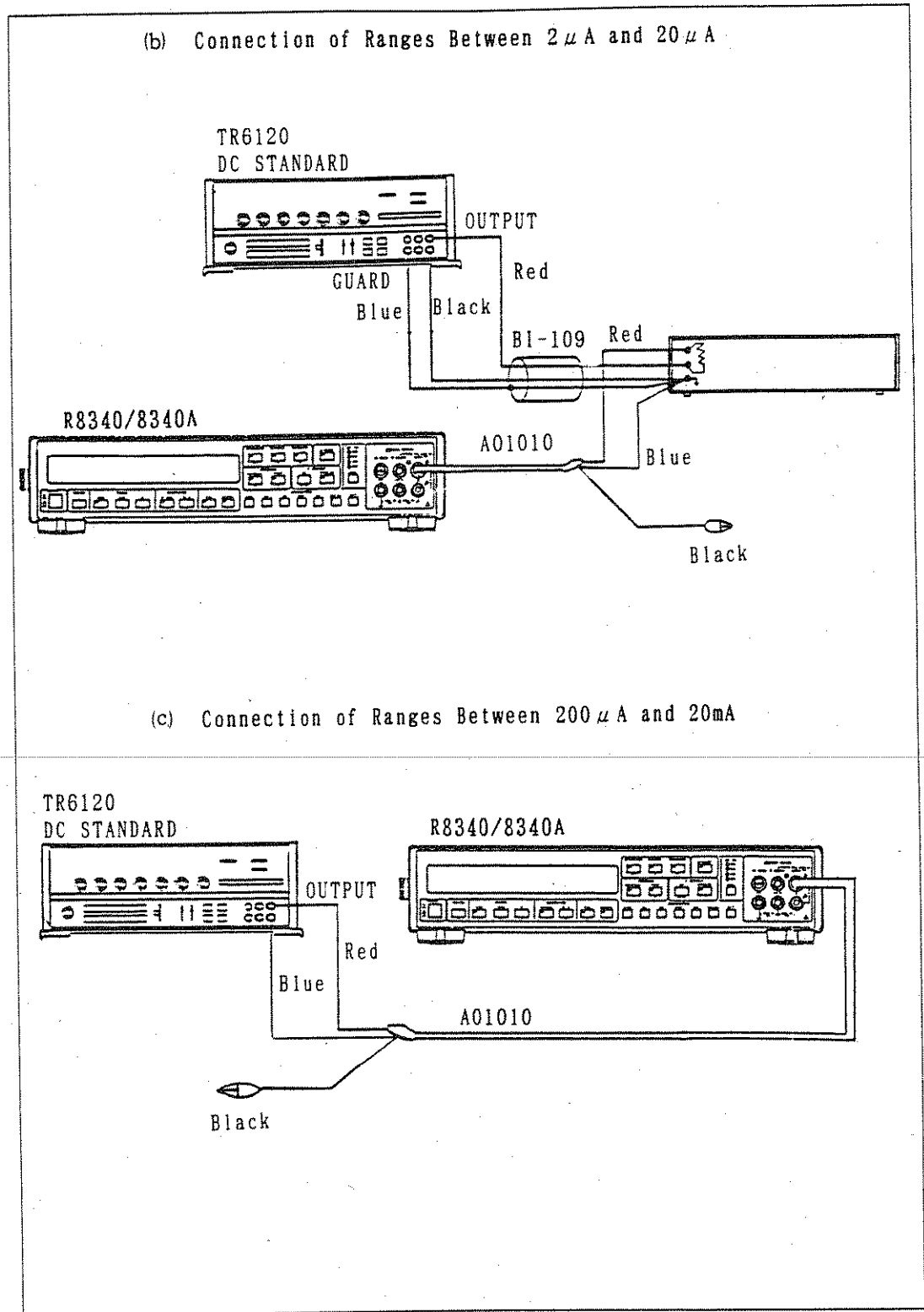

Figure 9 - 2 Connection for Current Measurement Calibration (Cont'd)

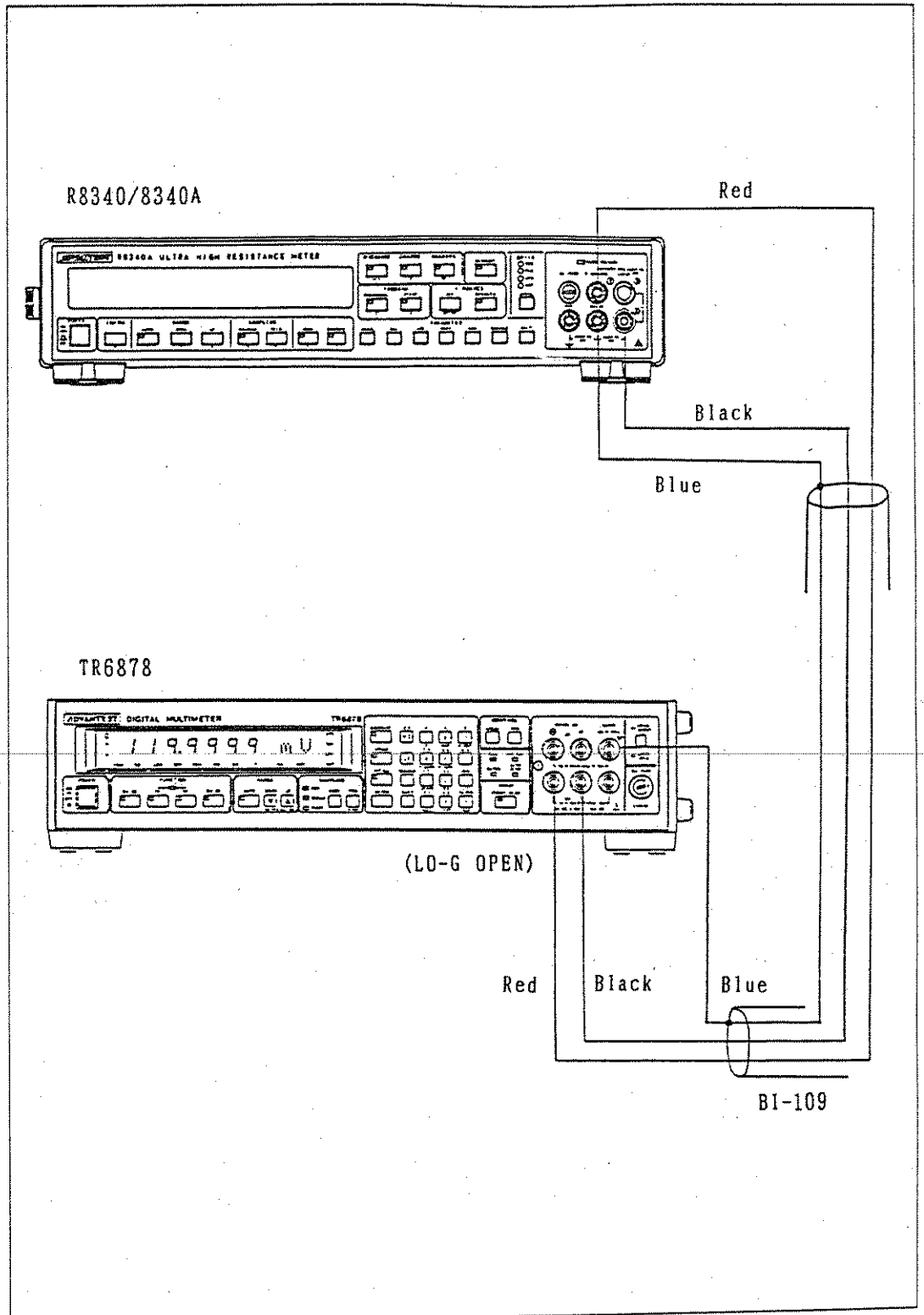

Figure 9 - 3 Connection for Voltage Generation Calibration

Table 9 - 4 Setting of Standard Direct-current Generator for Calibration

| Indication | Standard equipment | Setting of TR6120 #1 |
|------------|-------------------------------------|--------------------------------|
| 200pA | TR6120+Standard resistor (10GΩ) | $2 \times R \times 10^{-10}V$ |
| 2000pA | TR6120+Standard resistor (10GΩ) | $20 \times R \times 10^{-10}V$ |
| 20nA | TR6120+Standard resistor (100MΩ) | $2 \times R \times 10^{-8}V$ |
| 200nA | TR6120+Standard resistor (100MΩ) | $20 \times R \times 10^{-8}V$ |
| 2000nA | TR6120+Standard resistor (1MΩ) | $2 \times R \times 10^{-8}V$ |
| 20 μA | TR6120+Standard resistor (1MΩ) | $20 \times R \times 10^{-8}V$ |
| 200 μA | TR6120 | 0.20000mA |
| 2000 μA | TR6120 | 2.00000mA |
| 20mA | TR6120 | 20.0000mA |
| -10V | TR6120 | -10.0000V |
| 1800mV | TR6120 | 1.80000V |
| 180mV | TR6120 | 0.18000V |

R:Calibration value of standard resistor

*1: When the calibration value of the standard resistor is $0.9988 \times 10^{10} \Omega$, for example:
Set the voltage of the TR6120 to the following value using the formula in Table 9-4.

$$V = 20 \times 0.9988 = 19.976V$$

In this case, check if the meter reads

"2000.0" pA before pressing the ^{START} key.

Table 9 - 5 Each Calibration Item Setting Range

| Item | Indication | Setting range | Item | Indication | Setting range |
|-------------|----------------|--------------------------------------|-------------------|------------|-------------------------|
| 0mV | 000.00mV | Only "000.00mV" cannot be set. | VS 10V 0V | VS 00.000V | -2.000V to +2.000V |
| 180mV | 180.00mv | +70.00mV to +220.00mV | VS 10V 10V | VS 10.000V | +7.000V to +11.999V |
| 1.8V | 1800.0mv | +700.0mV to +2200.0mV | VS 100V 0V | VS 010.10V | -20.00V to +20.00V |
| -10V | -10.000v | -7.000V to -10.000V | VS 100V 100V | VS 100.00V | +70.00V to +119.99V |
| 20mA | 20.000mA | +7.000mA to +22.000mA | VS 1000V 0V | VS 0101.0V | -200.0V to +200.0V |
| 2mA | 2000.0 μ A | +700.0 μ A to +2200.0 μ A | VS 1000V 1000V | VS 1000.0V | +700.0V to +1199.9V |
| 200 μ A | 200.00 μ A | +70.00 μ A to +220.00 μ A | DA OUT 0V | DA 0.0000V | -0.2000V to +0.2000V |
| 20 μ A | 10.000 μ A | +7.000 μ A to +22.000 μ A | DA OUT 1V | DA 1.0000V | +0.7000V to +1.1999V |
| 2 μ A | 1000.0nA | +700.0nA to +2200.0nA | | | |
| 200nA | 100.00nA | +70.00nA to +220.00nA | | | |
| 20nA | 10.000nA | +7.000nA to +22.000nA | | | |
| 2nA | 1000.0pA | +700.0pA to +2200.0pA | | | |
| 200pA | 100.00pA | +70.00pA to +220.00pA | | | |

CAUTION

1. If a value exceeding the above range is set, an input error occurs when the key is pressed.
2. If you input an incorrect value, press the key. Then the preceding data appears and you can set new data.

(2) Calibration checking and adjustment (Calibration correction mode)

After completing the calibration in Item (1), start the following operation.

Operation

- ① Press the ^{PRGM/NORMAL}  key, and the LED on the key lights.

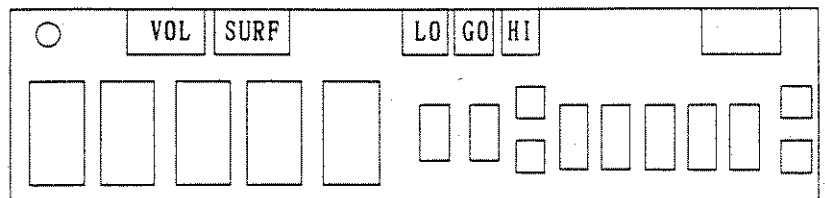

Calibration correction mode

When performing only the calibration checking and adjustment without executing the calibration in Item (1), start the following operation because the calibration correction mode is set when setting the EXIT CAL switch to ON.

The calibration correction mode and the calibration operation mode are changed over whenever the ^{PRGM/NORMAL}  key is pressed.

- ② Table 9-6 shows the adjustment error range of each range. Check the current range after executing zero cancel for each range (see Item 4.3.1). Though calibration is possible for full scale of up to 22000 in the calibration operation mode, the maximum measurement indication is "19999" in the calibration correction mode similarly to normal measurement. Therefore, for the checking in Table 9-6, set the full scale to approx. 18000.

For 180.00pA, for example:

$$\begin{aligned} \text{Set the voltage to } V &= 180.00\text{pA} \times 0.9988 \times 10^{10} \Omega \\ &= 1.79784\text{V} \end{aligned}$$

by assuming the calibration value of the standard resistor as $0.9988 \times 10^{10} \Omega$.

Table 9 - 6 Calibration Checking Error Range

| Range | Error range | |
|---------|-------------|--------------|
| | Zero point | + Full scale |
| 20mA | ± 1d | ± 3d |
| 2mA | ± 1d | ± 3d |
| 200 μ A | ± 1d | ± 3d |
| 20 μ A | ± 1d | ± 3d |
| 2 μ A | ± 1d | ± 3d |
| 200nA | ± 1d | ± 3d |
| 20nA | ± 1d | ± 3d |
| 2nA | ± 1d | ± 5d |
| 200pA | ± 2d | ± 10d |
| 10V | ± 2.5mV | ± 2.5mV |
| 100V | ± 25mV | ± 25mV |
| 1000V | ± 250mV | ± 250mV |

③ If measured values are out of the error range in Table 9-6, make adjustment using the keys shown below.

NULL

: Rewrites the calibration data in the presently-indicated measurement range so that it will be decreased by approx. 0.5 digits.

COMPARE

: Rewrites the calibration data in the presently-indicated measurement range so that it will be increased by approx. 0.5 digits.

COEF

: Rewrites the calibration data in the presently-indicated measurement range so that it will be decreased by approx. 5 digits.

MEM

: Rewrites the calibration data in the presently-indicated measurement range so that it will be increased by approx. 5 digits.

When make adjustment zero point of 200pA range, after pressing the above-mentioned key, executing zero cancel (See item 4.3.1).

CAUTION

1. It is impossible to adjust the zero point for current measurement and the voltage generation for ranges other than the 200pA range.
2. For the 200pA range, it takes several minutes until measured value is stabilized after the set voltage of the standard equipment is changed over. Start the calibration checking and adjustment after the value is completely stabilized.

(3) Storing of Calibration Data

After completion of calibration, store the calibration data through the following operation. However, it is not needed to store the data when only the operation in Item (2) "calibration checking and adjustment" is executed and measured values are kept within the error range but not corrected.

Operation

- ① Press the  key.

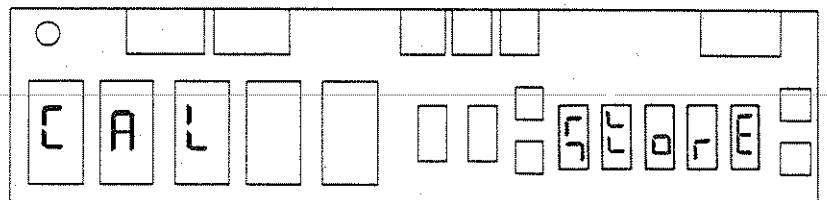

↓ During storage of calibration data

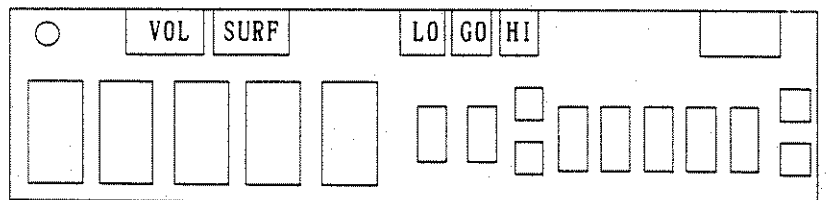

End of calibration data storage,
 Calibration correction mode

(4) Cancel of Calibration Mode

Operation

- ① Turn off the EXIT CAL switch, and all calibration modes are canceled and the state is changed to the normal measurement mode.

(5) Key Functions in Calibration Mode

In the calibration mode, key functions differs from those in the normal mode. However, keys other than those in Figure 9-1 show normal functions.

10. DESCRIPTION OF OPERATION.

This section describes the outline of operation theory of the meter.

10.1 Outline of Operation

Figure 10-1 shows the block diagram of the meter. The meter uses two CPUs (microprocessors) one for control of the AD converter, V-SOURCE, and I-V converter, and the other for interface with external units and indication of data. Data is transferred between CAPs by an optoisolator.

R8340A is different from R8340 in the fact that the R8340A uses 1100V parts with a high dielectric strength capable of floating for the input connector, input/output cable, and photoisolator and has the BCD and DA output terminals to output data to external units.

This section describes the guard section which functions as a measurement part.

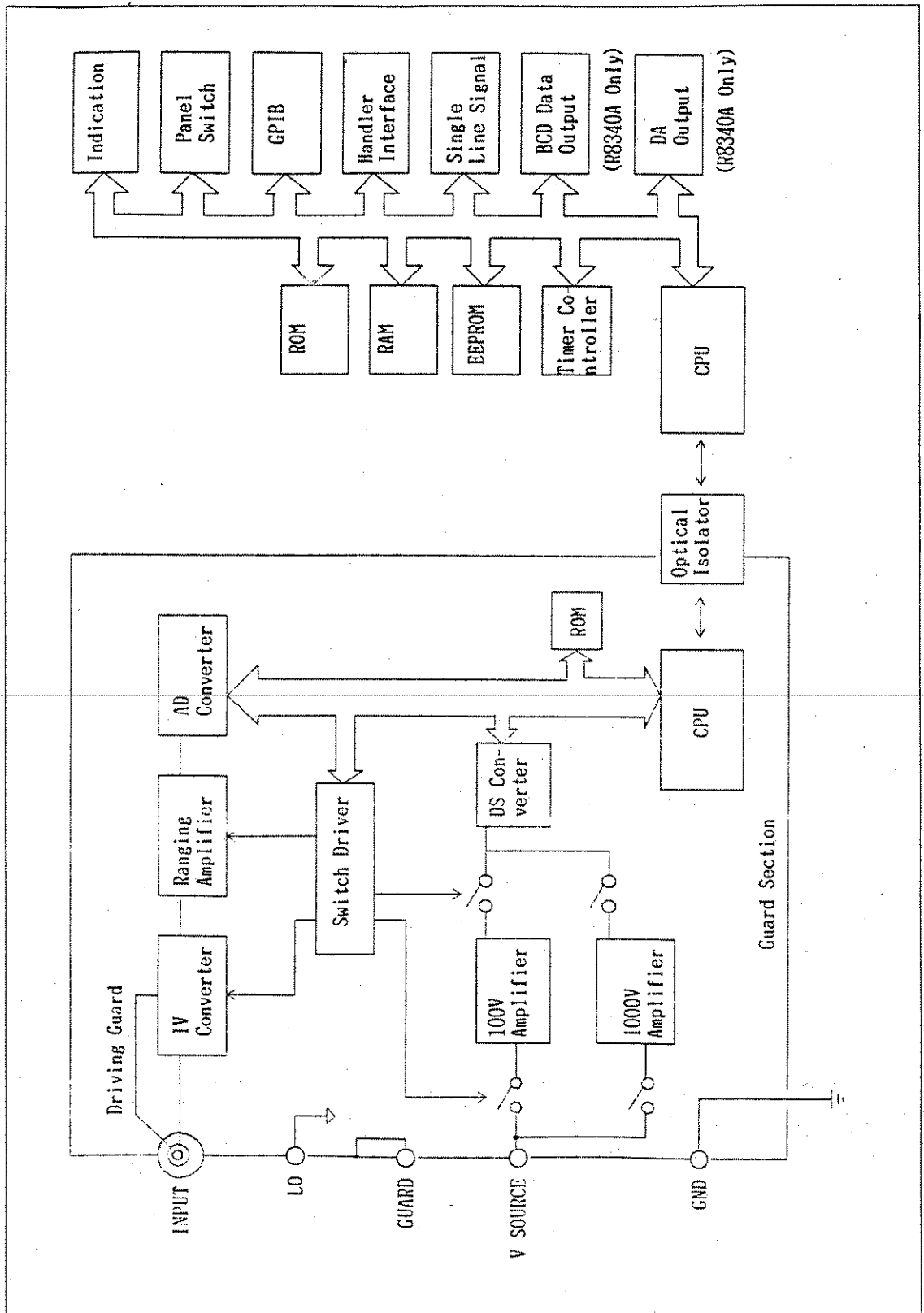

Figure 10 - 1 Block Diagram of R8340 and R8340A

10.2 IV Converter

Figure 10-2 shows the basic circuit diagram of the IV converter.

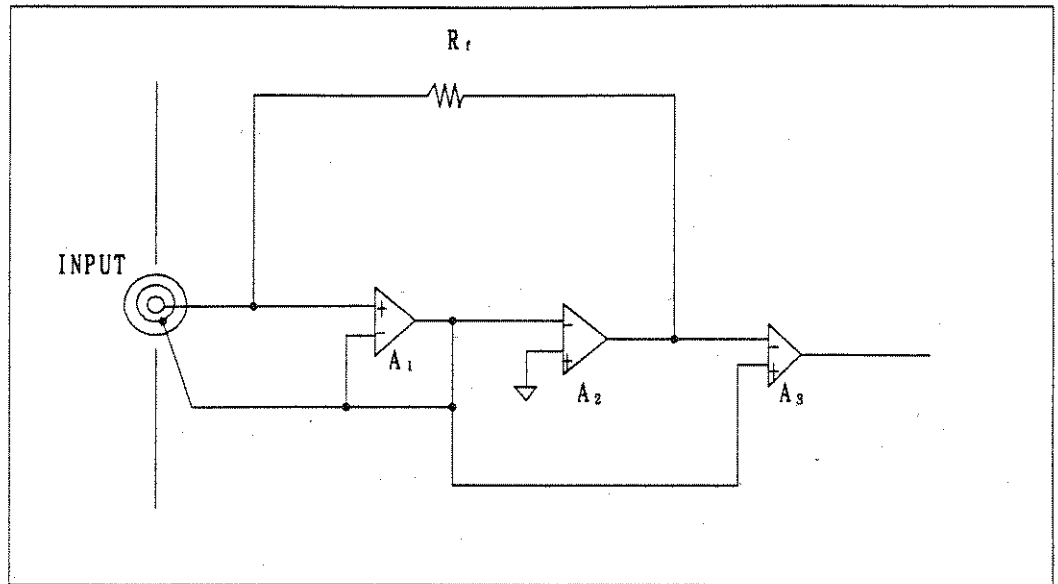

Figure 10 - 2 IV Converter

The amplifier A_1 functions as a buffer amplifier to obtain high input impedance and as a driving guard to guard input lines. The amplifier A_2 changes equivalent input resistance by changing the gain because the gain is variable. The amplifier A_3 is a differential amplifier to sense the voltage at the both ends of the resistor R_f .

10.3 A/D Converter

The meter uses the input integration variable type A/D converter. By selecting the integration time of 200ms, 100ms, 20ms (for commercial power frequency of 50 Hz), or 2ms; it is possible to set stable measurement with a high noise-rejection ratio or highspeed sampling according to the measurement purpose.

Figure 10-3 shows the outline of A/D converter operation. When S_1 is turned on and the input voltage V_{in} is integrated and a certain time elapses, the converter turns S_2 on, applies the reference voltage V_{ref} , until the integrator output is turned positive, and measures the duration if the output value of the integrator U_1 is negative.

The converter repeats the above operation during the integration time and turns S_1 off when the input integration time elapses. In addition, the converter keeps turning S_2 on until the integrator polarity turns positive and ends the integration. The polarity of the integrator output is judged by the comparator U_2 connected to the integrator output.

The results of counting the total time while S_2 is turned on are used for the A/D conversion data.

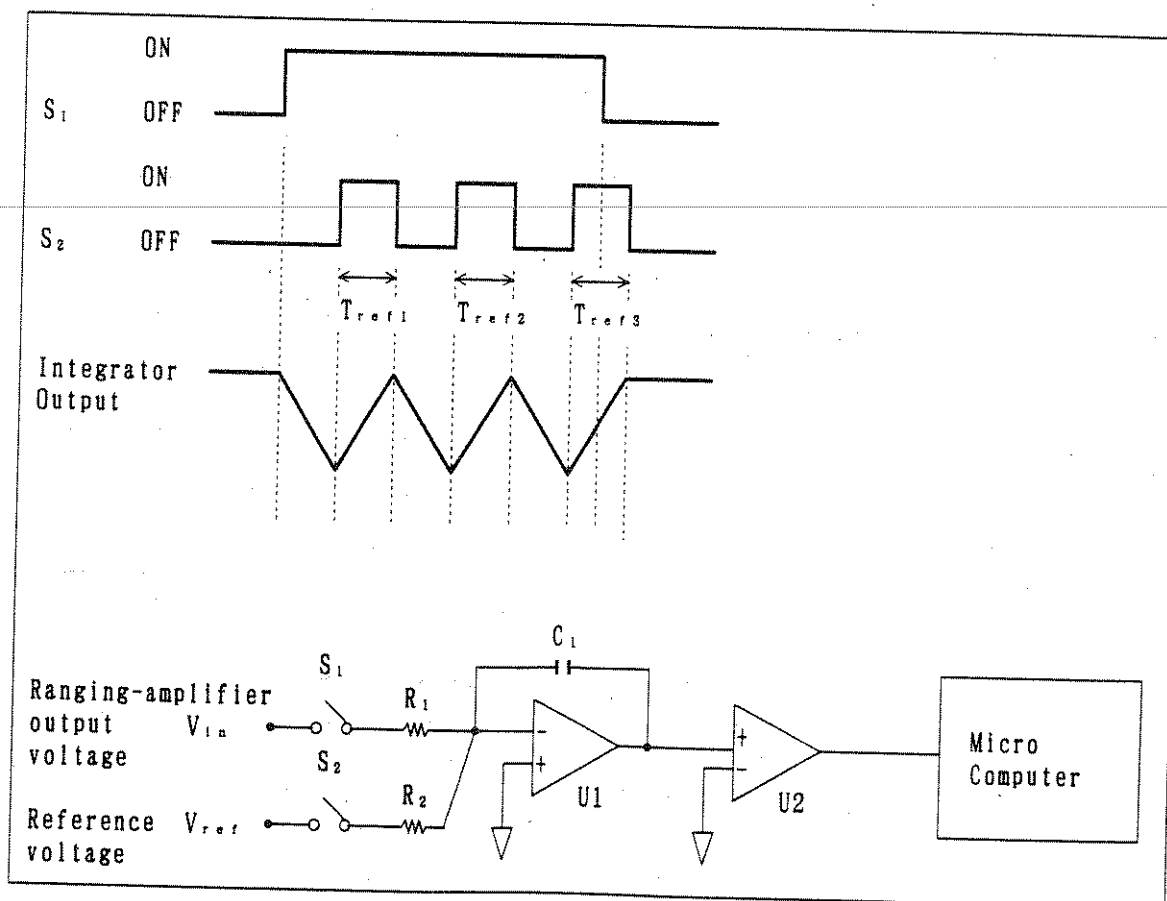

Figure 10 - 3 Outline of A/D Converter Operation

11. CONNECT INPUT/OUTPUT CABLES

This section describes the connection when the meter is combined with a fixture or scanner.

11.1 Connecting the Instrument to R12702A/B

The R12702A/B resistivity chamber is an electrode and shield chamber used for measuring volume resistance (ratio) and surface resistance (ratio) of sheet, film and panel type samples. The pressure of the electrodes can be adjusted to allow close connection of samples of any hardness. A dial gauge makes it possible to measure the thickness of the sample which is a requirement for calculating volume resistance. The chamber is also provided with a switch for selecting between volume and surface resistance and a switch which turns off and on the applied current as the lid is opened and closed.

R12702A : ϕ 50 electrode

R12702B : ϕ 70 electrode

Refer to section "3.2.6 Volume and Surface Resistivity measurements" for information on volume resistance (ratio) and surface resistance (ratio).

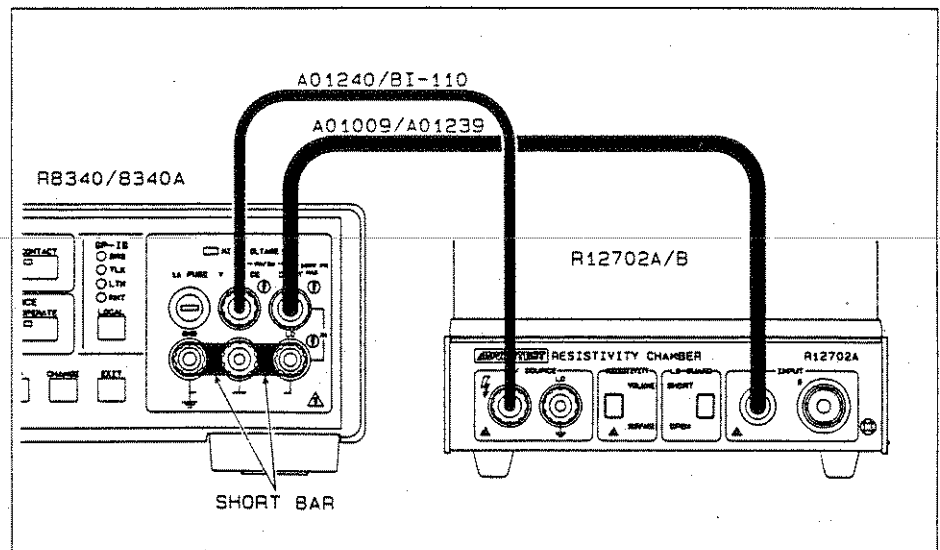

Figure 11 - 1 R12702A/B Setup

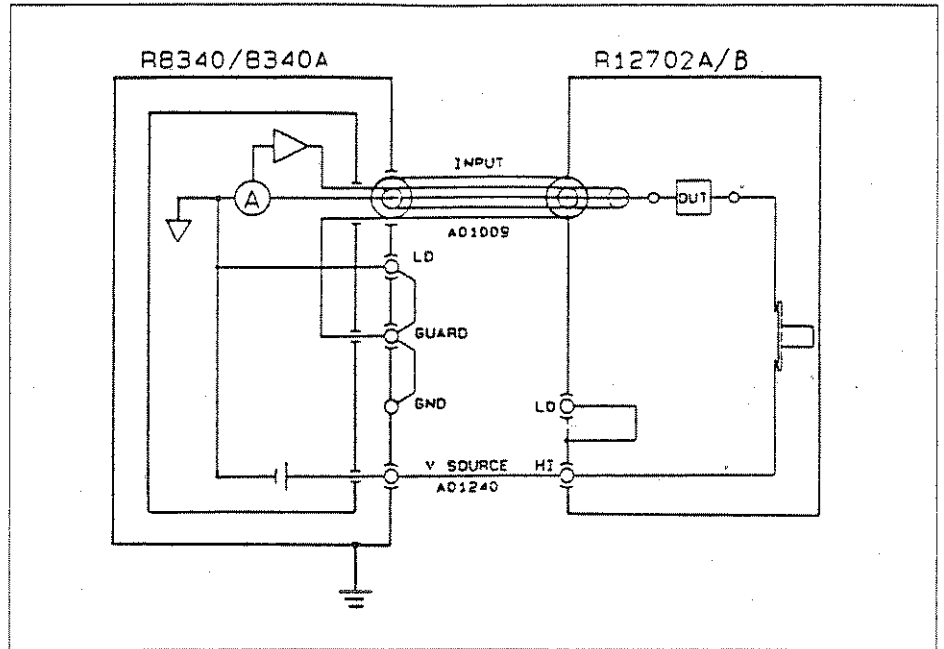

Figure 11 - 2 R12702A/B Connecting Diagram

11.2 Connecting the Instrument to R12704

The R12704 resistivity chamber is a shield chamber used for measuring volume resistance (ratio) and surface resistance (ratio) of shield insulated samples. Sample installation is easy. The chamber is also provided with a switch for selecting between volume and surface resistance and a switch which turns off and on the applied current as the lid is opened or closed. The diameter of the main electrode is 50 ϕ . Refer to section "3.2.6 Volume and Surface Resistivity Measurements" for information on volume resistance (ratio) and surface resistance (ratio).

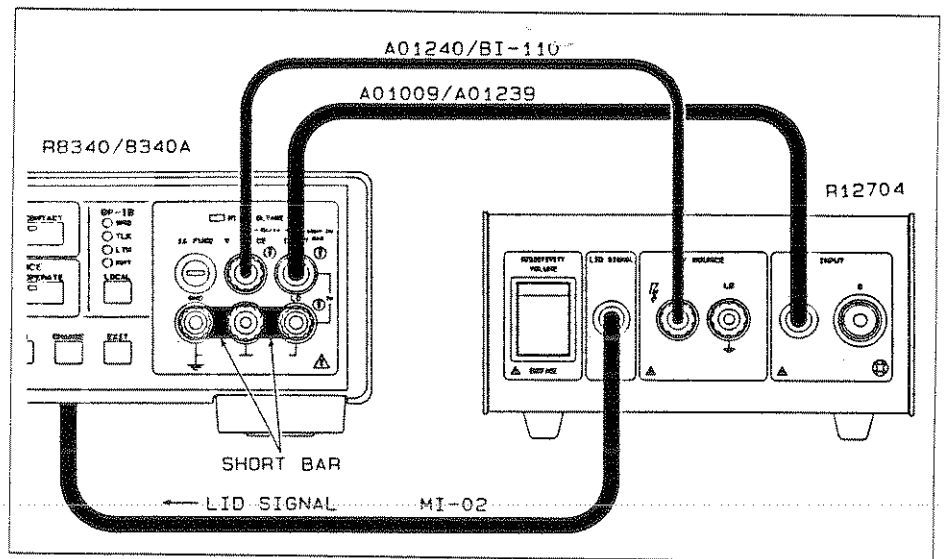

Figure 11 - 3 R12704 Setup

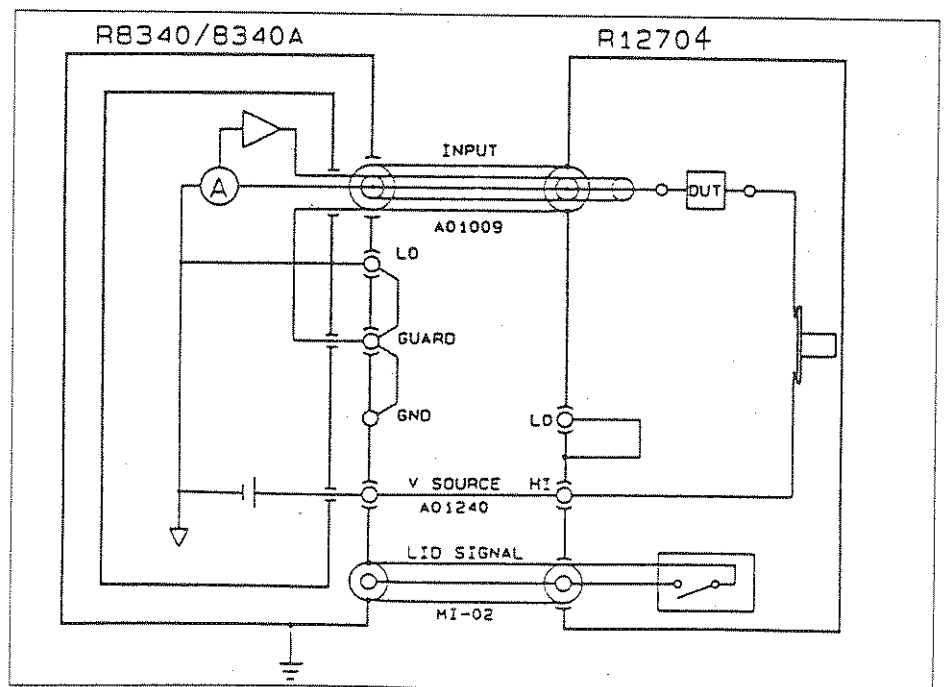

Figure 11 - 4 R12704 Connecting Diagram

11.3 Connecting the Instrument to TR42

The TR42 resistivity sample chamber is a shield box used for measuring volume resistance (ratio) and surface resistance (ratio) of shield insulated samples. A short bar is provided for selecting between volume and surface resistance. The internal electrode can be removed to allow measurement of samples with leads. The diameter of the main electrode is 50ϕ . Refer to section "3.2.6 Volume and Surface Resistivity Measurements" for information on volume resistance (ratio) and surface resistance (ratio).

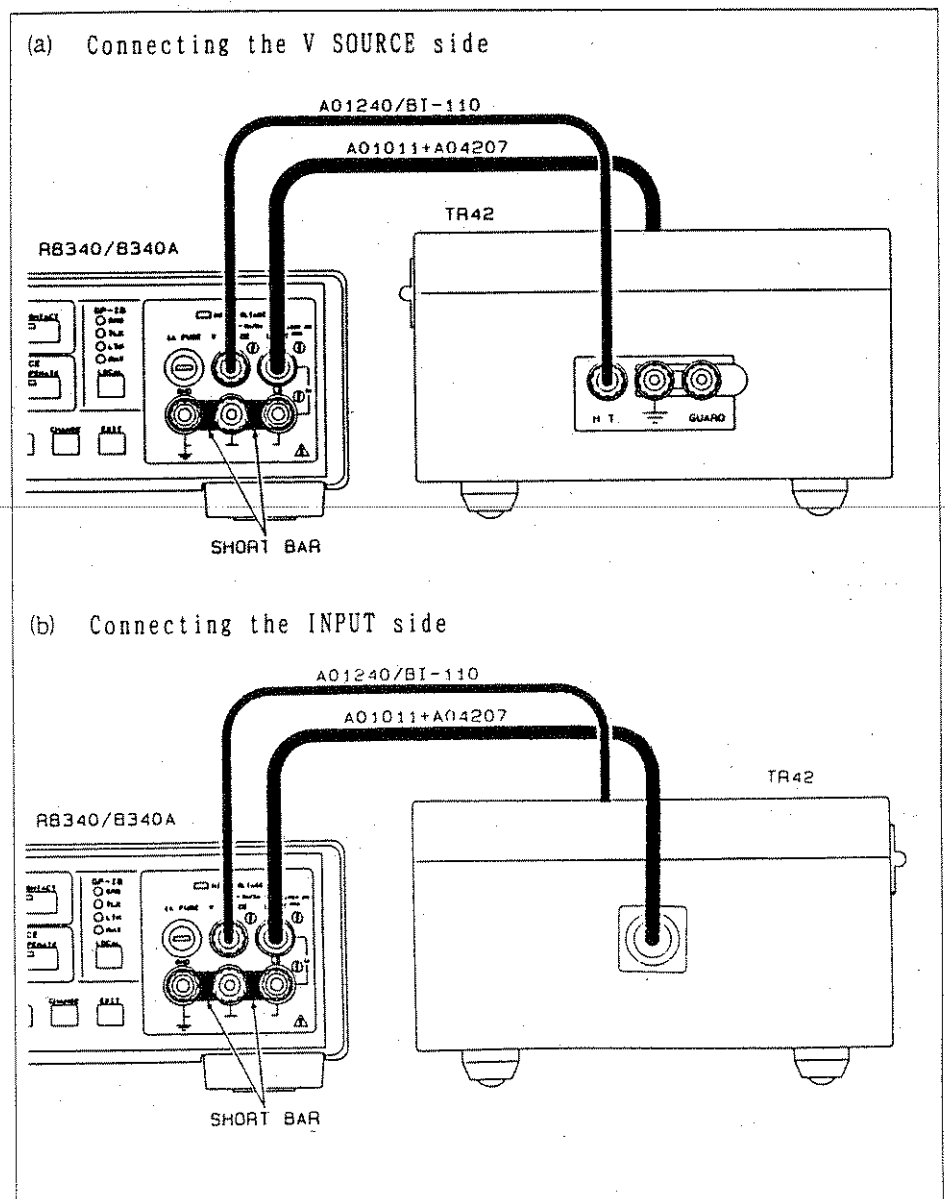

Figure 11 - 5 TR42 Setup
(Measuring volume resistance)

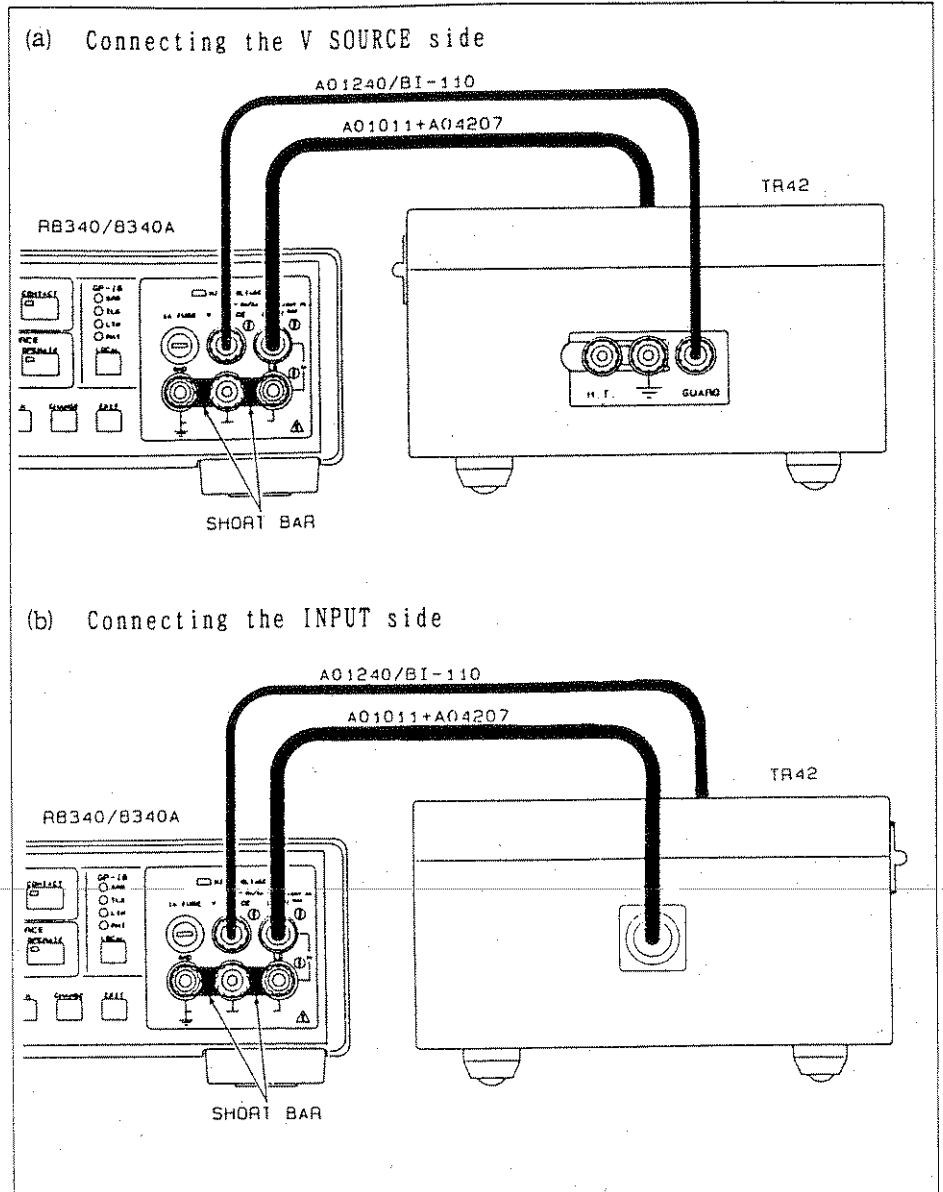

Figure 11 - 6 TR42 Setup
(Surface resistance)

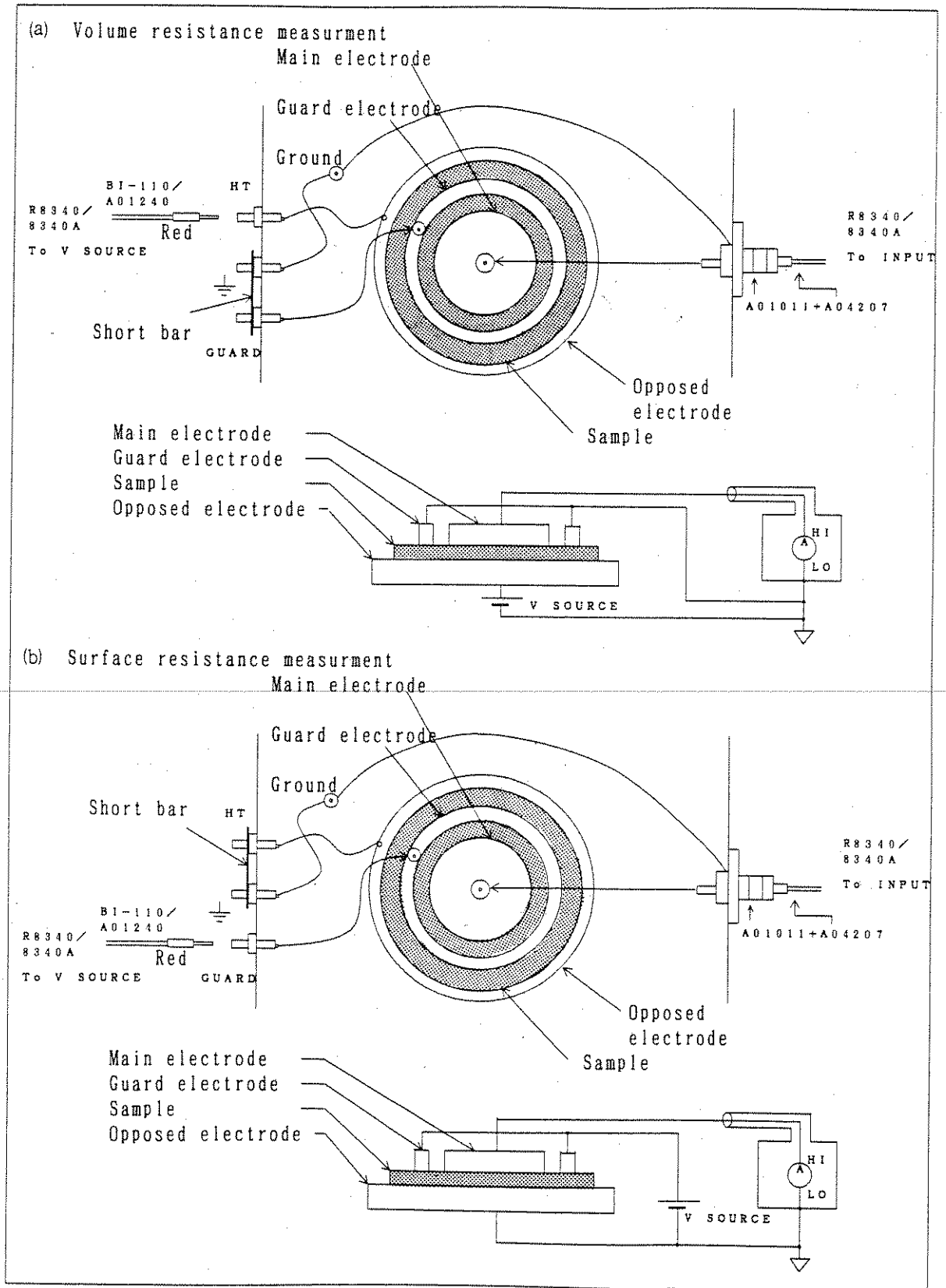

Figure 11 - 8 TR42 or 43C Internal Connecting Diagram

11.5 Connecting the Instrument to TR44

The TR44 is a sample chamber for measuring the volume resistance of insulating oil and liquid samples. The sample must have a volume of approximately 50cc.

Table 11 - 1 Coefficient Setting

| | | |
|-----------------------|-----|--|
| Electrode setting | OPT | Refer to section "4.4.4 Setting of Volume-/Surface-Resistivity Electrode". |
| Electrode coefficient | 637 | Refer to section "4.4.5 Optional Electrode Coefficient". |
| Thickness | 10 | Refer to section "4.4.6 Sample Thickness". |

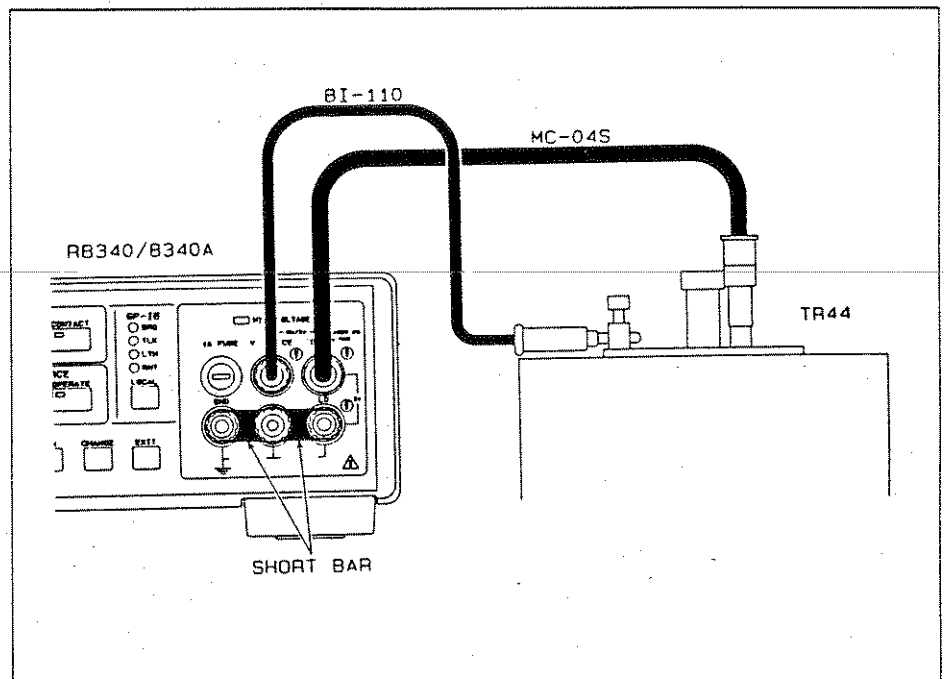

Figure 11 - 9 TR44 Setup

11.6 Connecting the Instrument to R12706A

The R12706A test fixture is a sample chamber for measuring the insulation resistance and voltage applied current of capacitors and diodes.

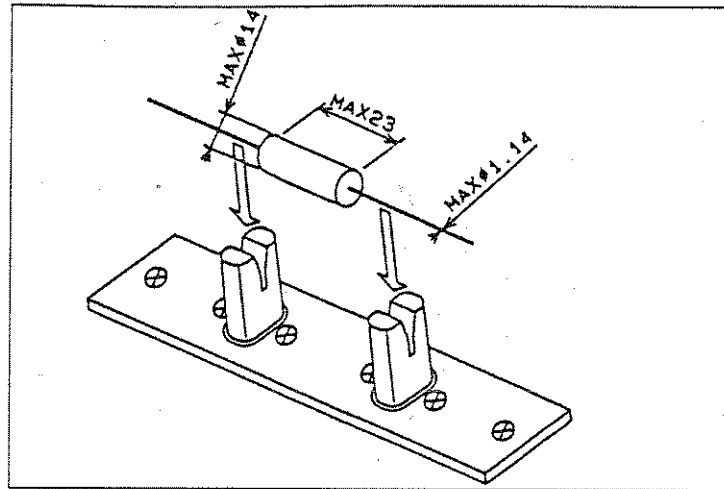

Figure 11 - 10 Installation Terminals

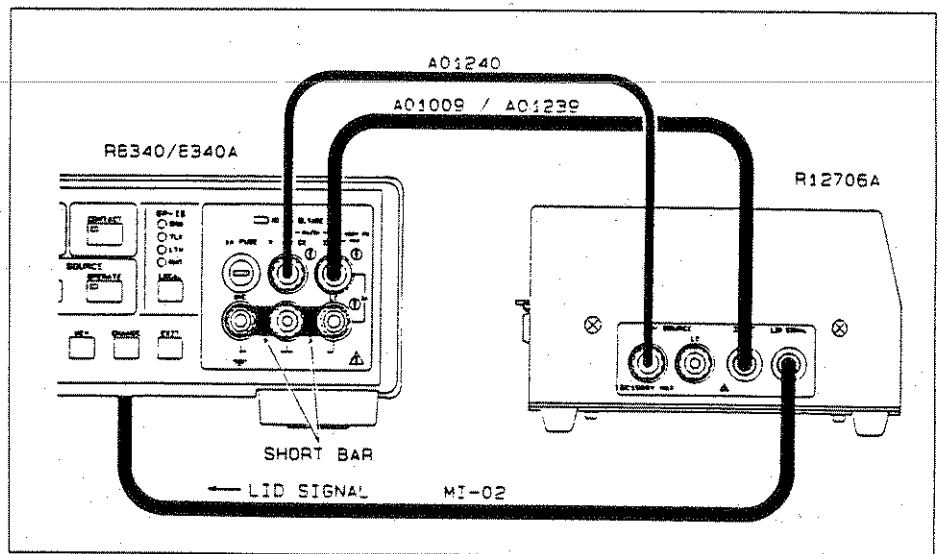

Figure 11 - 11 R12706A Setup

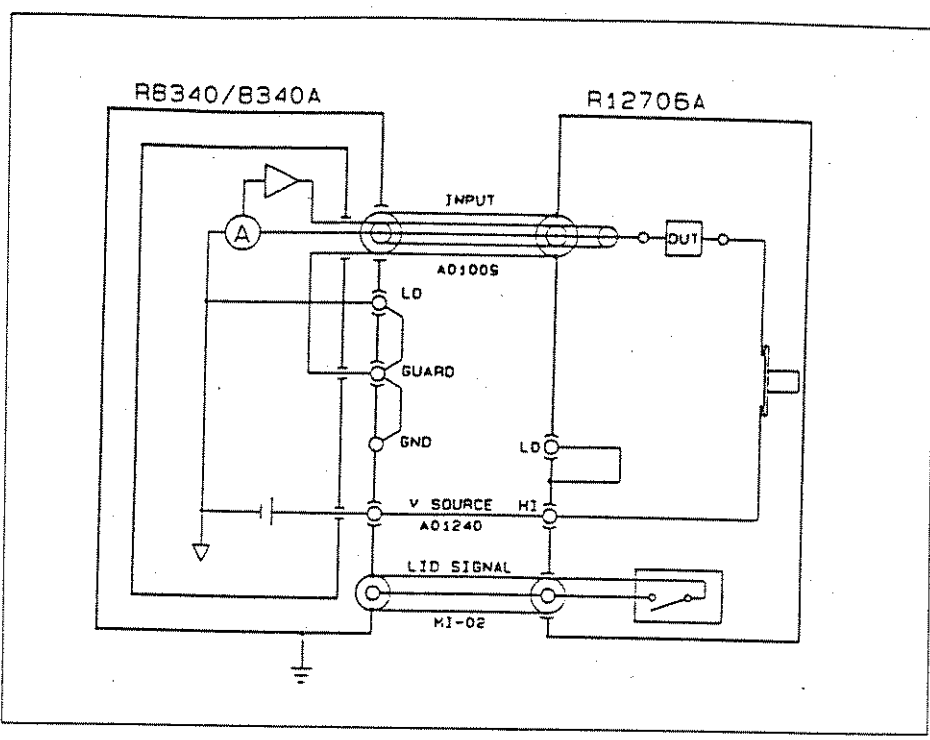

Figure 11 - 12 R12706A Connecting Diagram

11.7 Connecting Multiple Samples with R12705A, R7210 and R72101J

The R12705A 20CH test fixture is a sample chamber for measuring the insulation resistance and voltage applied current of capacitors and other electrical components. It allows the connection of up to 20 samples. It can be used with the R8340/8340A (measuring instrument), the R7210 and R72101J (scanner). In this configuration, the system can be controlled by a personal computer equipped with a GPIB interface to perform device evaluation, selection, edging and high-speed measurement simulations.

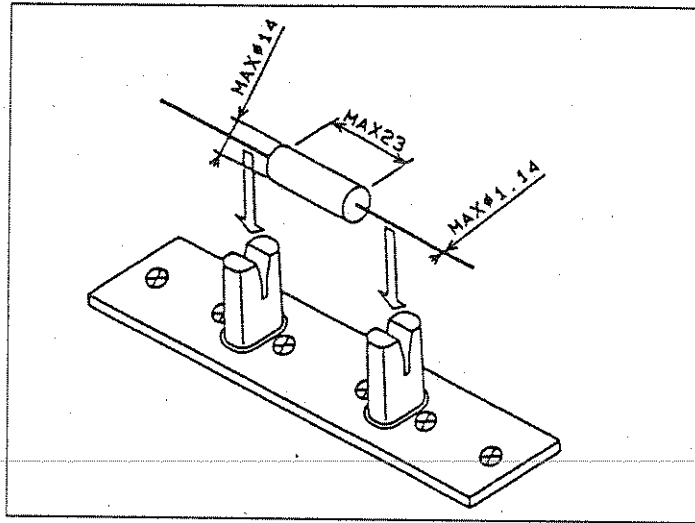

Figure 11 - 13 Installation Terminals.

11.7 Connecting Multiple Samples with R12705A, R7210 and R72101J

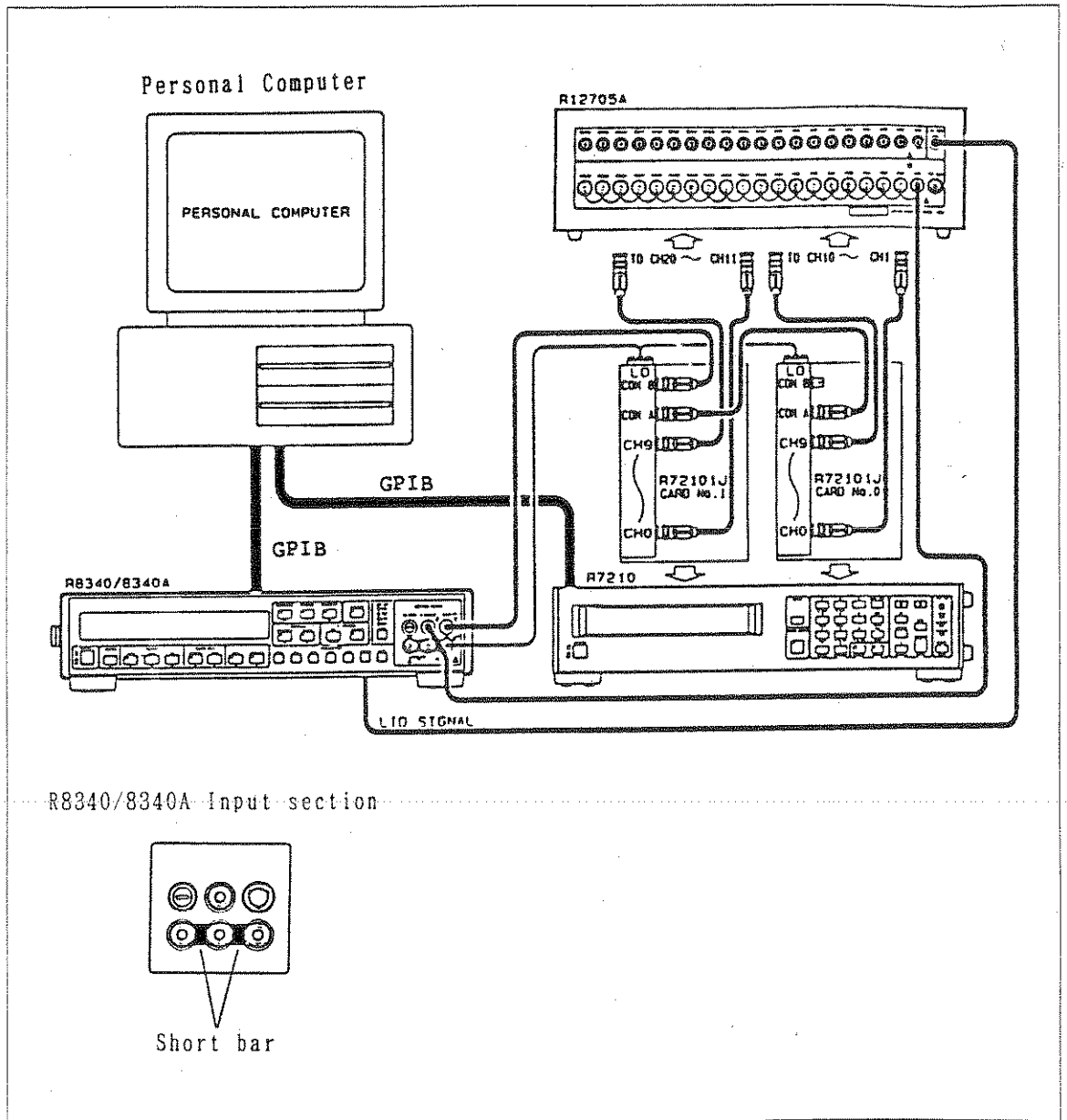

Figure 11 - 14 R12705A, R7210 and R72101J Setup

11.7 Connecting Multiple Samples with R12705A, R7210 and R72101J

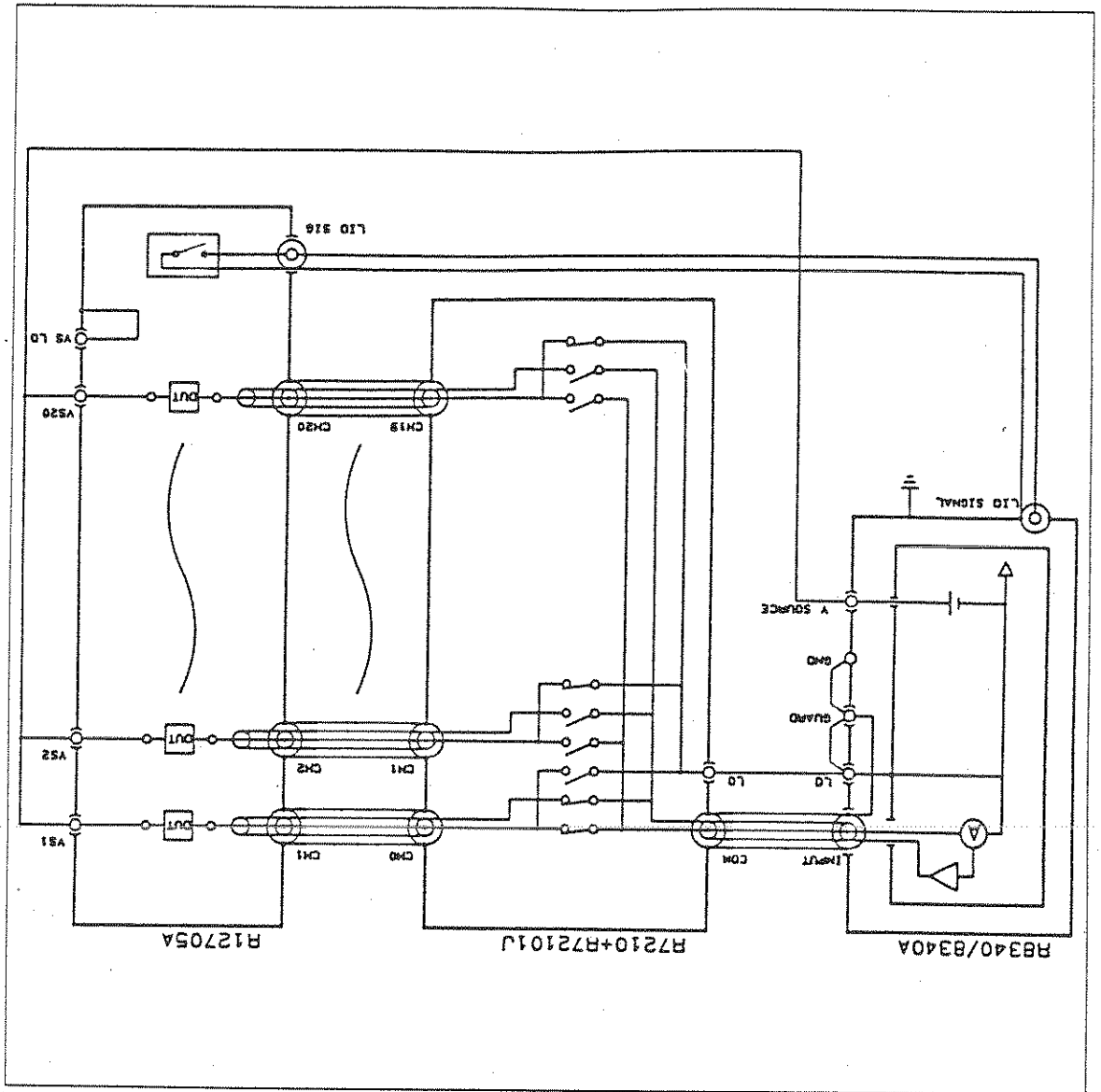

Figure 11 - 15 R12705A, R7210 and R72101J Connection Diagram

11.8 Connecting the Instrument to R12604

The R12604 tweezer probe is used for insulation resistance measurements of chip capacitors and other components. The tweezer type probe of the measurement probe and voltage application probe allows efficient measurement of small chip components. These kind of measurements should be performed on a shield plate to reduce the effect of induction noise. The A08076 Teflon insulated measuring shield plate (200 × 200mm) is provided as an option.

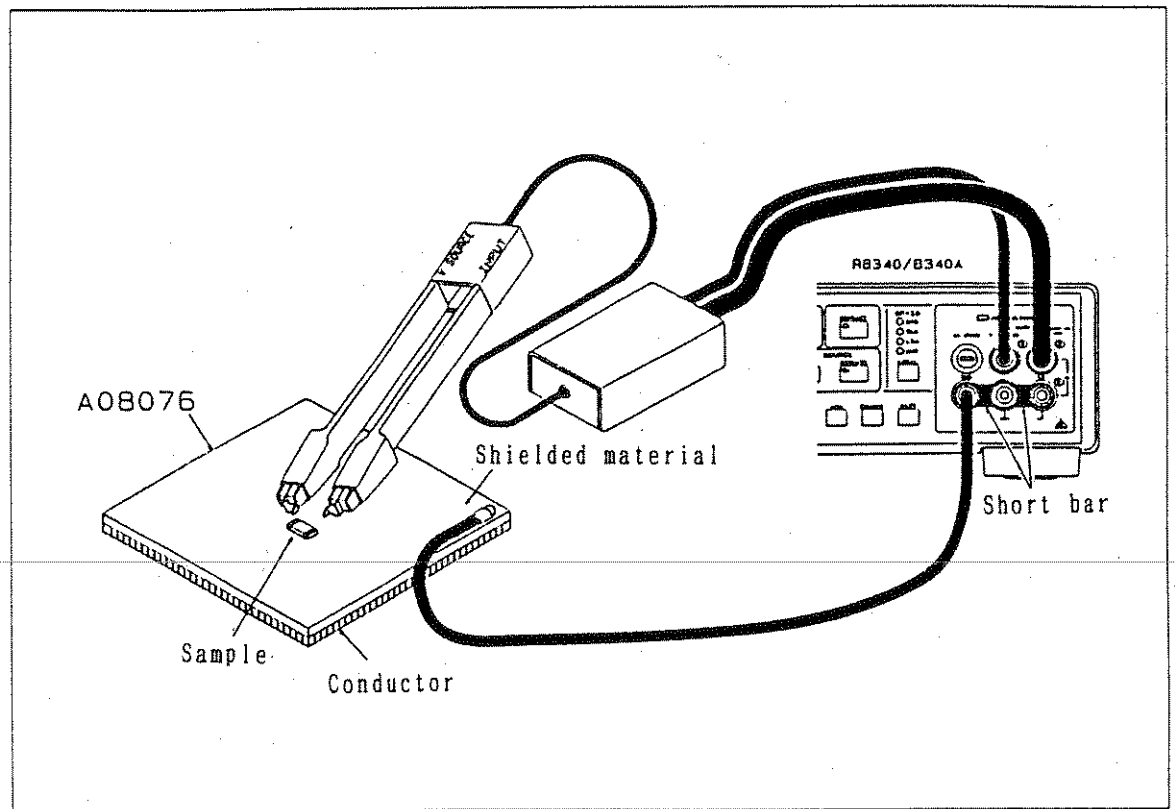

Figure 11 - 16 R12604 Setup

12. SPECIFICATION

This section summarizes the standards and accessories (optional) of the meter.

12.1 Direct Current Measurement

| Measurement Range | Maximum Indication Value | Resolution | Measurement Accuracy \pm (% of rdg+digit) | Temperature Coefficient \pm (% of rdg+digit)/ $^{\circ}$ C | Settling Time |
|-------------------|--------------------------|------------|--|---|---------------|
| 200pA | 199.99pA | 10fA | 0.7 + 6d | 0.02 + 0.5d | 250mS |
| 2nA | 1999.9pA | 100fA | 0.7 + 3d | 0.02 + 0.2d | 25mS |
| 20nA | 19.999nA | 1pA | 0.3 + 3d | 0.01 + 0.2d | 5mS |
| 200nA | 199.99nA | 10pA | 0.3 + 3d | 0.01 + 0.2d | |
| 2 μ A | 1999.9nA | 100pA | 0.15 + 3d | 0.005 + 0.2d | 2mS |
| 20 μ A | 19.999nA | 1nA | 0.15 + 2d | 0.005 + 0.1d | |
| 200 μ A | 199.99 μ | 10nA | 0.1 + 2d | 0.005 + 0.1d | |
| 2mA | 1999.9 μ A | 100nA | 0.1 + 2d | 0.005 + 0.1d | |
| 20mA | 19.999mA | 1 μ A | 0.1 + 2d | 0.005 + 0.1d | |

- The measurement accuracy is shown as the value for six months at the temperature of $+23^{\circ}\text{C} \pm 5^{\circ}\text{C}$ and the relative humidity of 70% or less with the auto calibration set to ON converted into \pm (% of reading + digit)
- The temperature coefficient is shown as the value at the temperature of 0 to 40°C and the relative humidity of 70% or less converted into \pm (% of reading + digit)/ $^{\circ}\text{C}$
- The settling time shows the time until it reaches $\pm 1\%$ of the final value when the input amplifier gain is set to " $\times 10000$ ", excluding the range changeover time.

12.2 Resistance Measurement

| Current Range | Measurement Range (Ω) | Measurement Accuracy (Example for VS of 100V and input amplifier gain of $\times 10$ or more) |
|---------------|---------------------------------------|---|
| 200pA | 1×10^9 to 3×10^{10} | 0.8% + 14d |
| 2nA | 1×10^8 to 3×10^{10} | 0.8% + 11d |
| 20nA | 1×10^7 to 3×10^{10} | 0.4% + 11d |
| 200nA | 1×10^6 to 3×10^{10} | 0.4% + 11d |
| 2 μ A | 1×10^5 to 3×10^{10} | 0.25% + 11d |
| 20 μ A | 1×10^4 to 3×10^{10} | 0.25% + 10d |
| 200 μ A | 1×10^3 to 3×10^{10} | 0.2% + 10d |
| 2mA | 1×10^2 to 3×10^9 | 0.2% + 10d |
| 20mA | 1×10^1 to 3×10^9 | 0.2% + 10d |

Measurement Accuracy

: \pm [(current-range reading term + 0.1% + input voltage drop/generated voltage) + (current-range digit term + voltage-generation digit term)]

Temperature Coefficient

: \pm [(current-range reading term + 0.008%) / $^{\circ}\text{C}$ + (current-range digit term + voltage-generation digit term) / $^{\circ}\text{C}$]

Maximum Indication Value

: 1 to 4 digits (1 to 9.999)

Settling Time

: Follows the current measurement range.

12.3 Input Specification

Input Resistance

| Current range | input amplifier gain | | | |
|---------------|----------------------|-------|-------|--------------|
| | ×1 | ×10 | ×100 | ×10000 |
| 200pA | 10GΩ | 1GΩ | 100MΩ | 10KΩ or less |
| 2nA | 1GΩ | 100MΩ | 10MΩ | 1KΩ or less |
| 20nA | 100MΩ | 10MΩ | 1MΩ | 100Ω or less |
| 200nA | 10MΩ | 1MΩ | 100KΩ | 11Ω or less |
| 2 μ A | 1MΩ | 100KΩ | 10KΩ | 2Ω or less |
| 20 μ A | 100KΩ | 10KΩ | 1KΩ | 1Ω or less |
| 200 μ A | 10KΩ | 1KΩ | 100Ω | 1Ω or less |
| 2mA | 1.1KΩ | 110Ω | 11Ω | 1Ω or less |
| 20mA | 180 Ω | 18Ω | 3Ω | 1Ω or less |

Input Voltage drop : ± (measured current x input resistance + 500 μ V)

Input bias current : 30 fA or less (At the temperature of +23°C ± 1°C and the relative humidity of 50% or less)

Input capacitance : 30pF or less (Excluding the input cable)

Maximum allowable supply voltage
 : 1.1kV peak

12.4 Direct Current Generation

| Output voltage | Set resolution | Generation accuracy \pm (% of setting + digit) | Temperature coefficient \pm (% of setting + digit)/ $^{\circ}$ C | Output noise (10-500Hz) |
|-------------------------|----------------|---|---|----------------------------|
| 0.000V to 10.000V | 2.5mV | 0.1 + 10d (10mV) | 0.008 + 0.5d (500 μ V) | 1mV p-p |
| 10.03V to 100.00V | 25mV | 0.1 + 8d (80mV) | 0.008 + 0.3d (3mV) | 2mV p-p |
| 100.3V to 1000.0V | 250mV | 0.1 + 8d (800mV) | 0.008 + 0.3d (30mV) | 5mV p-p |

- The generation accuracy is shown as the value for six months at the temperature of $+23^{\circ}\text{C} \pm 5^{\circ}\text{C}$ and the relative humidity of 70% or less converted into \pm (% of setting + digit).
- The temperature coefficient is shown as the value at the temperature of 0 to 40°C and the relative humidity of 70% or less converted into \pm (% of setting + digit)/ $^{\circ}\text{C}$.

| Output voltage | Current Compliance Setting | | |
|-------------------|----------------------------|--------------------|-------------------|
| | 300mA | 100mA | 10mA |
| 0.000V to 30.00V | $\pm 300\text{mA}$ | $\pm 100\text{mA}$ | $\pm 10\text{mA}$ |
| 30.03V to 100.00V | $\pm 100\text{mA}$ | $\pm 100\text{mA}$ | $\pm 10\text{mA}$ |
| 100.3V to 1000.0V | $\pm 10\text{mA}$ | $\pm 10\text{mA}$ | $\pm 10\text{mA}$ |

Current compliance accuracy (both source and sink) should be as shown below at the temperature of $+23^{\circ}\text{C} \pm 5^{\circ}\text{C}$ and the relative humidity of 70% or less:

300mA: $\pm 300\text{mA}$ to $\pm 500\text{mA}$

100mA: $\pm 100\text{mA}$ to $\pm 150\text{mA}$

10mA: $\pm 10\text{mA}$ to $\pm 20\text{mA}$

Settling time : Genuine resistance load $t=3\text{ms}(\text{MAX})$

Capacitive load

$$t = \underbrace{\frac{CV}{I}} + \underbrace{t_0}$$

Charge time Converging time

- t : Settling time (the time it takes to reach $\pm 1\%$ of the value excluding the time required for range switching)
- C : Load capacity
- V : Output voltage
- i : Charge current (the maximum value is the compliance value)
- t_0 : Convergence time (see table below)

| Output voltage \ Capacity | Capacity | | |
|---------------------------|--------------|------------|------------|
| | 0.22 μ F | 22 μ F | 33 μ F |
| 0.000V to 100.00V | 0.1 | 3.0 | 7.0 |
| 100.3V to 1000.0V | 4.2 | 15 | 150 |

(msec)

Overshoot voltage :

| Load Output voltage | Genuine resistance | Capacity | | |
|---------------------|--------------------|--------------|-------------|------------|
| | | 0.22 μ F | 2.2 μ F | 33 μ F |
| 0.000V to 100.00V | 0.05 | 0.05 | 3.0 | 3.0 |
| 100.3V to 10000. V | 0.05 | 36 | 24 | 10 |

(V)

12.5 Measurement Speed and
Maximum Indication
(For Current Measurement)

| Integration time | Sample size for free run | Maximum indocation |
|------------------|----------------------------------|--------------------|
| 2mS | 100 times/sec | 3½ digits 1999 |
| 1PLC | 50Hz times/sec 60Hz times/sec | 4½ digits 19999 |
| 5PLC | 8.5 times/sec | |
| 10PLC | 4.5 times/sec | |
| 4×10PLC | 1 times/sec | |
| 8×10PLC | 0.5 times/sec | |
| 16×10PLC | 0.3 times/sec | |

*1: When indication is set to OFF, auto calibration to OFF, and memory store to ON.

12.6 Input/Output Function

GPIB ; Follows IEEE std 488-1978.

It is possible to output measured data, generated voltage, status, and error messages.

It is possible to use the binary packed format (IEEE 754, Floating point).

Handler interface ;

Input/output signals timing with such external equipment as the auto handler and fixture (24-pin Amphenol connector)

Input ; *TRIGGER, LID SIGNAL, *CONTACT START

output ; *COMPLETE, *EOM, *INDEX, *ALARM, *LO, *GO, *HI, *NO CONTACT

Single wire signal (BNC connector)

*TRIGGER (Input)

LID SIGNAL (Input)

*COMPLETE (Output)

BCD OUTPUT (Given to only R8340A);

Makes it possible to select the OFF, BCD or BINARY output format. (50-pin Amphenol connector), TTL positive logic

D/A OUTPUT (Given to only R8340A);

Two or three optional digits of indicated data are DA-converted and output.

Output voltage ; $\pm 1V$

Conversion output ; Three-digit indication 000 to $\pm 999 \rightarrow$
0V to $\pm 0.999V$
Setting of 50% offset is possible.
Output for offset (-500 \rightarrow 0V, 000 \rightarrow 0.5V,
+499 \rightarrow 0.999V)

Digit selection ; 19999 19999 19999 19999

Conversion accuracy ; $\pm 0.2\% \pm 2d$
(Guaranteed for six months at the temperature of $+23^{\circ}C \pm 5^{\circ}C$ and the relative humidity of 70%)

Output resistance ; 1Ω or less

Maximum load current ; $\pm 0.5mA$

Output connector ; Binding post

12.7 Other Function

NULL

$R = X - X_{NULL}$

The measured data when NULL is set is subtracted from measured data.

X; Measured value, X_{NULL} ; Measured data when NULL is set

COMPARE

R(HI) ; $X > Y$

R(GO) ; $Y \geq X \geq Z$

R(LO) ; $X < Z$

Measured data is compared with set data.

X; Measured value, Y; High-level set value, Z; Low-level set value

PRGM (Sequence program)

Typical sequence including capacitor lead measurement and JIS C5102 are stored.

Setting item IS ; Automatic start current value

TC ; Charge time

TD ; Discharge time

TM ; measurement time

CONTACT(Contact checking)

Sample contact state is checked through C-measurement. Missing capacitance of capacitors can also be checked by initializing the standard sample.

Setting item ; Contact level. To be judged with n-fold of standard sample.

AUTO RANGE LEVEL

Auto range for current measurement can be selected in the following three types ; 20000, 2000, and 200 for UP and 1799, 179, and 17 for DOWN.

This allows high-speed response measurement corresponding to necessary number of digits.

DATA MEMORY

One thousand data values can be memorized.

BUZZER

The buzzer sounds in two tones (high-and low-pitched tones) for HI/LO for COMPARE operation results, end of program, error detection.

12.8 General Specification

Normal-mode noise rejection ratio
: (For 50/60Hz ±0.09%)

| INTEGRATION TIME | NMRR | ECMRR |
|------------------|--------|---------------|
| 2ms | 0dB | 60dB or more |
| 1PLC to 16×10PLC | 60dB以上 | 120dB or more |

Effective-common-mode noise rejection ratio
: Above ECMRR(At DC and 50/60Hz±0.09% for 1kΩ unbalanced impedance between LO and GND terminals)

Measuring System : Integration System
Input System : Floating System
Data Indication : Seven-segment green LED
Unit/Exponent Indication : 5×7 dot matrix green LED
Input Terminal : TRIAXIAL Connector (INPUT)
Black binding post (LO, GND)
Blue binding post (GUARD)
Voltage Output Terminal : Red binding post (V SOURCE)

Input Protection Fuse : 1A Fuse

Maximum application voltage between terminals :

INPUT Between INPUT terminal and other terminals ; 1100V peak (for 1 min)

LO Between LO and GUARD terminals ; 550V peak (1100V peak for R8340A)

LO Between LO and GND terminals ; 550V peak (1100V peak for R8340A)

GUARD Between GUARD and GND terminals ; 1100V peak

V SOURCE Between V-SOURCE and other terminals ; 100Vpeak (Set voltage of 0 to 100.0V), 1000Vpeak(Set voltage of 100.03 to 1000.0V)

Preheating time : Approx. 30min(Until measured value falls into the specified accuracy)

Operating environment range

: Temperature of 0 to 40°C, Relative humidity of 85% or less

Storing environment range

: -25°C to +70°C

Power supply

: Set to the value specified when you ordered

| Option No. | Standard | 31 | 32 | 42 | 43 | 44 |
|-----------------|------------|------------|------------|------------|------------|------------|
| Supply Voltage | 90 to 110 | 103 to 127 | 108 to 132 | 198 to 242 | 207 to 250 | 216 to 250 |
| Power Frequency | 48 to 66Hz | | | | | |

Power consumption : 90VA or less

Outside dimensions : Approx. 424(Width)x88(Height)x350(Depth)mm

Weight : 8kg or less

12.9 Accessories (Optional)

(1) Equipment

R12701 test fixture
R12702A/B resistivity chamber
(Variable pressure, Thickness measurement)
R12704 resistivity chamber
TR42 ultra-high resistance measurement sample case
TR43 ultra-high resistance measurement sample case
(For high temperature)
TR44 liquid resistance measurement sample container
R12603 test lead

(2) Input Cable

A01009-50, -100, -150, -200 (TRIAX-TRIAX connector)
MC-04SX01, X02, X03, X04, X05 (TRIAX-TR44 connection)
A01239-50, -100, -150, -200 (High-dielectric-strength TREAX
-TRIAX connector)
A01011-50, -100, -150, -200 (TRIAX-BNC connector)
A04207 (BNCJ-MP adapter)

APPENDIX

A1.1 GPIB Remote Execution Time (representative value)

Applicable computer ; HP9000 series, Model 216, BASIC 2.0

Program code execution time

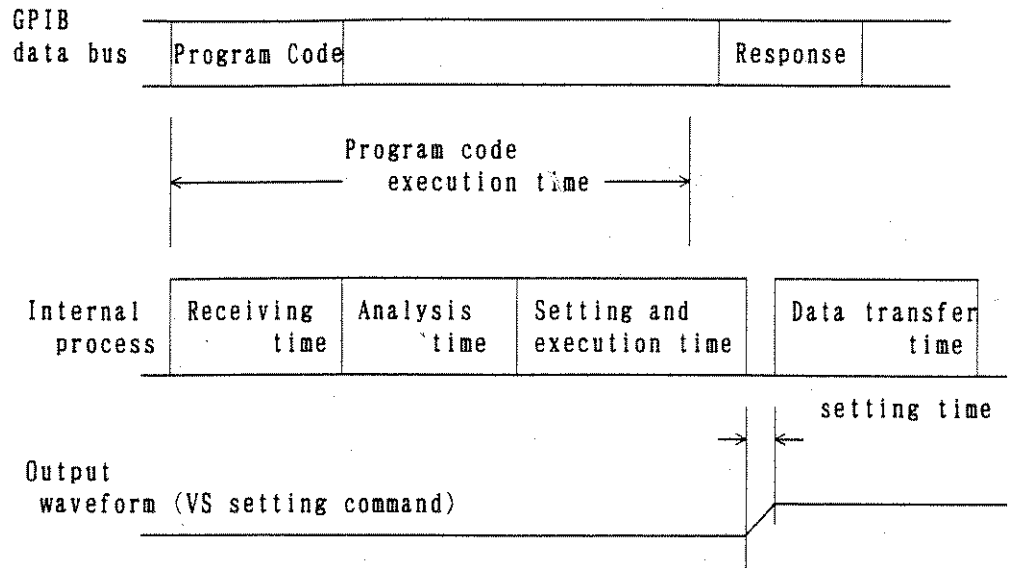

(1) VS Setting

| Program code | Receiving and analysis time | Setting time | Total (representative value) | Measurement condition |
|--------------|-----------------------------|--------------|------------------------------|-----------------------|
| PVS10.000 | 3ms | 2.0ms | 5.0ms | Operate |
| PVS100.00 | 3ms | 17.0ms | 20.0ms | |
| PVS1000.0 | 3ms | 16.0ms | 19.0ms | |

※ The setting time is not included.

(2) Setting Operate/Standby

| Program code | Receiving and analysis time | Setting time | Total (representative value) |
|--------------|-----------------------------|--------------|------------------------------|
| DTX | 2.0ms | 13.5ms | 15.5ms |

(3) Contact check (When the contact initial integral time is 2ms)

| Program code | Receiving and analysis time | Execution time | Data transfer time | Total (representative value) | Measurement condition |
|--------------|-----------------------------|----------------|--------------------|------------------------------|-----------------------|
| CNT? | 2.0ms | 51.5ms | 0.6ms | 54.1ms | Charge mode |

(4) C, Z command

| Program code | Receiving and analysis time | Execution time | Total (representative value) |
|--------------|-----------------------------|----------------|------------------------------|
| C | 1.3ms | 619ms | 620.3ms |
| Z | 1.4ms | 832ms | 833.4ms |

(5) Change-over of range

The range change-over time is calculated by adding the receiving and analysis time and execution time described below.

| Program code | Receiving and analysis time |
|--------------|-----------------------------|
| R2 to R9 | 1.7ms |
| R10 | 2.0ms |

Execution time (representative value) [Unit:ms]

| Before modification After modification | 200pA | 2nA | 20nA | 200nA | 2 μ A | 20 μ A | 200 μ A | 2mA | 20mA |
|---|-------|------|------|-------|-----------|------------|-------------|------|------|
| 200pA | | 10.4 | 10.4 | 10.4 | 10.4 | 10.4 | 10.4 | 10.4 | 10.4 |
| 2nA | 10.3 | | 10.4 | 10.4 | 10.4 | 10.4 | 10.4 | 10.4 | 10.4 |
| 20nA | 10.3 | 10.4 | | 10.4 | 10.4 | 10.4 | 10.4 | 10.4 | 10.4 |
| 200nA | 10.3 | 24.5 | 16.4 | | 10.4 | 10.4 | 10.4 | 10.4 | 10.4 |
| 2 μ A | 10.4 | 24.5 | 30.5 | 16.4 | | 10.4 | 10.4 | 10.4 | 10.4 |
| 20 μ A | 10.3 | 24.5 | 30.5 | 16.4 | 10.4 | | 8.3 | 8.3 | 8.3 |
| 200 μ A | 10.3 | 24.5 | 30.5 | 16.4 | 10.4 | 8.3 | | 8.3 | 8.3 |
| 2mA | 10.3 | 24.5 | 30.5 | 16.4 | 10.4 | 8.3 | 8.3 | | 8.3 |
| 20mA | 10.3 | 24.5 | 30.5 | 16.4 | 10.4 | 8.3 | 8.3 | 8.3 | |

Measurement execution time (HOLD-TRIGGER)

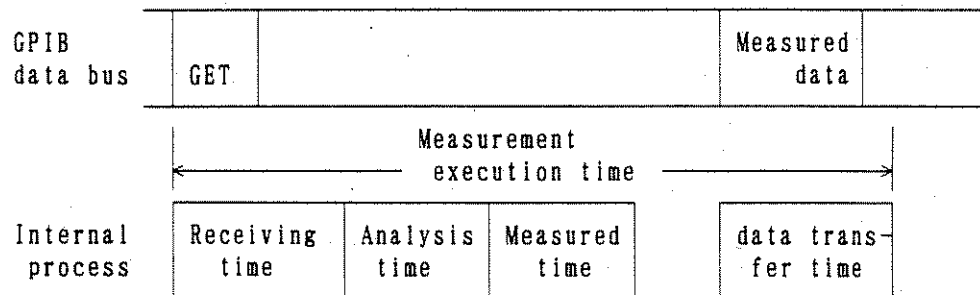

| Measurement of current | Receiving and analysis time | Measurement time | Data trans- fer time | Total (repre- sentative value) | Measurement condition |
|---------------------------|--------------------------------|---------------------|-------------------------|-----------------------------------|--|
| 2ms | 0.5ms | 9.8ms | 3.8ms | 14.1ms | Measurement of current NULL OFF COMPARE OFF AD CAL OFF STORE OFF Data output mode OMO |
| 1PLC | 0.5ms | 27.8ms | 3.8ms | 32.1ms | |

I N D E X

[A]

| | |
|----------------------------------|---------|
| A display | 2 - 8 |
| A/D Converter | 10 - 5 |
| Accessories (Optional) | 12 - 11 |
| Accessories | 1 - 5 |
| AD CAL (MEAS key) | 4 - 10 |
| AD CAL | 3 - 35 |
| Adapter | 1 - 8 |
| Address Setting | 6 - 6 |
| APPLIED MEASUREMENT | 11 - 1 |
| AUTO key | 2 - 3 |
| AUTO RANGE LEVEL | 12 - 9 |
| Auto Range Up/down Level | 4 - 13 |
| (MEAS key) | |
| Auto Range Up/Down Level | 3 - 41 |
| Autorange Delay (MEAS key) | 4 - 16 |
| Autorange Delay | 3 - 51 |

[B]

| | |
|--------------------------------|--------|
| Basic Format | 6 - 7 |
| BCD OUTPUT (I/O key) | 4 - 43 |
| BCD OUTPUT connector | 2 - 9 |
| BCD Output | 8 - 1 |
| | 8 - 2 |
| Before Requesting Repair | 8 - 2 |
| Binary Output | 8 - 7 |
| Binary Packed Format | 6 - 11 |
| Block Diagram | 10 - 3 |
| bus cable | 6 - 5 |
| Buzzer (COEF key) | 4 - 37 |
| BUZZER | 12 - 9 |

[C]

| | |
|--------------------------|--------|
| Cable | 1 - 10 |
| CAL key | 4 - 4 |
| Calibration Data | |
| Initialization | 8 - 5 |
| Calibration Method | 8 - 6 |
| Calibration state | 3 - 9 |
| Calibration | 8 - 3 |
| CHARGE key | 2 - 4 |
| Charge | 3 - 16 |
| COEF key | 4 - 5 |
| Command Buffer | 6 - 24 |
| COMPARE key | 2 - 4 |
| Compare | 3 - 34 |
| | 12 - 9 |

| | |
|---|--------|
| COMPLETE OUTPUT connector | 2 - 9 |
| COMPLETE Output Signal | 7 - 9 |
| Connection for Coexistence of Isolated and Earthed Samples | 3 - 14 |
| Connection of Earthed Sample | 3 - 12 |
| Connection of Isolated Sample | 3 - 11 |
| Contact Checking | 3 - 43 |
| | 12 - 9 |
| Contact Initial Integral Time (COEF key) | 4 - 39 |
| Contact Initialization (CAL key) | 4 - 19 |
| Contact Initialization Offset Measurement (CAL key) | 4 - 18 |
| CONTACT key | 2 - 4 |
| Contact Level (COEF key) | 4 - 35 |
| CONTACT | 12 - 9 |
| Controller Interruption | 6 - 24 |
| Current Compliance (MEAS key) | 4 - 12 |
| Current Compliance | 3 - 40 |
| Current Limiter (MEAS key) | 4 - 12 |
| Current Limiter | 3 - 40 |

[D]

| | |
|------------------------------------|--------|
| D/A Output | 8 - 1 |
| | 8 - 10 |
| DA OUTPUT (I/O key) | 4 - 41 |
| DA OUTPUT connector | 2 - 9 |
| Data Indicator (COEF key) | 4 - 38 |
| DATA MEMORY | 12 - 9 |
| Data Output | 6 - 7 |
| Data Part | 6 - 15 |
| Data Recall (MEM key) | 4 - 49 |
| Data Storage (MEM key) | 4 - 47 |
| DC Measurement | 3 - 17 |
| DESCRIPTION OF OPERATION | 10 - 1 |
| Device Event Status Register | 6 - 30 |
| Direct Current Generation | 12 - 5 |
| Direct Current Measurement | 12 - 2 |
| DISCHARGE key | 2 - 4 |
| Discharge | 3 - 15 |
| DOWN key | 2 - 3 |

[E]

| | |
|-------------------------------------|--------|
| Error Messages | 3 - 8 |
| Error Register | 6 - 32 |
| Execution of Sequence Program | 5 - 8 |
| EXT CAL switch | 2 - 9 |

[F]

| | |
|---|--------|
| Format of Recall Data with Data Number | 6 - 12 |
| Front Panel | 2 - 3 |
| Fuse holder | 2 - 5 |
| | 2 - 9 |
| Fuse Open Detection Message | 3 - 5 |
| Fuse | 1 - 9 |

[G]

| | |
|-----------------------------------|---------|
| General Specification | 12 - 10 |
| Generated voltage indicator | 2 - 8 |
| GND terminal | 2 - 5 |
| | 2 - 9 |
| GPIB (I/O key) | 4 - 44 |
| GPIB connector | 2 - 9 |
| GPIB remote execution time | A1 - 2 |
| GPIB Standard | 6 - 3 |
| GPIB status lamp | 2 - 4 |
| GPIB system | 6 - 5 |
| GUARD terminal | 2 - 5 |

[H]

| | |
|-----------------------------------|--------|
| HANDLER INTERFACE connector | 2 - 9 |
| Handler Interface | 7 - 2 |
| Header on/off Selection | 6 - 6 |
| Header Part | 6 - 14 |
| HIGH VOLTAGE lamp | 2 - 5 |
| How to Set Auto-start Value | 5 - 15 |
| How to Set Charge Time | 5 - 15 |
| How to Set Discharge Time | 5 - 17 |
| How to Set measurement time | 5 - 18 |

[I]

| | |
|--|--------|
| I/O key | 4 - 4 |
| IM/RM key | 2 - 3 |
| IM | 3 - 17 |
| Initialize Setting States | 3 - 9 |
| Input Amplifier Gain (MEAS key) | 4 - 11 |
| Input Amplifier Gain | 3 - 36 |
| INPUT connector | 2 - 5 |
| Input Error | 3 - 7 |
| Input Resistance | 3 - 39 |
| Input Specification | 12 - 4 |
| Input Voltage Drop | 3 - 39 |
| Input/Output Cable | 1 - 10 |
| Input/Output Function | 12 - 8 |
| INPUT/OUTPUT SIGNALS | 7 - 1 |
| Integral Time (MEAS key) | 4 - 8 |
| Integration Time | 3 - 35 |
| IV Converter | 10 - 4 |

[L]

| | |
|----------------------------------|--------|
| LID SIGNAL INPUT connector | 2 - 9 |
| LID SIGNAL Input Signal | 7 - 11 |
| LIMIT display | 2 - 8 |
| Limiter Message | 3 - 6 |
| Listener Specification | 6 - 14 |
| LO terminal | 2 - 5 |
| LO, GO, and HI display | 2 - 8 |
| LOCAL key | 2 - 4 |
| LOWER Level (COEF key) | 4 - 26 |
| LTN lamp | 2 - 5 |

[M]

| | |
|---|---------|
| MEAS key | 4 - 3 |
| MEASURE key | 2 - 4 |
| Measured Data Buffer | 6 - 24 |
| Measured value indicator | 2 - 8 |
| Measurement of Surface Resistivity | 3 - 26 |
| Measurement of Volume Resistivity | 3 - 26 |
| Measurement Speed and Maximum Indication | 12 - 7 |
| Measuring Multiple Samples | 11 - 12 |
| MEM key | 4 - 6 |
| Mesure | 3 - 16 |

[N]

| | |
|--------------------|--------|
| Normal state | 3 - 9 |
| NULL key | 2 - 4 |
| Null | 3 - 33 |
| | 12 - 9 |

[O]

| | |
|--|--------|
| OPERATE key | 2 - 4 |
| Operating Ambient Condition | 1 - 6 |
| Optional Electrode Coefficient (COEF key) | 4 - 32 |
| Over-range Message | 3 - 4 |
| Overheat Detection Message | 3 - 7 |
| Overload Message | 3 - 4 |
| Overvoltage Detection Message | 3 - 6 |

[P]

| | |
|---------------------------------|--------|
| Parameter Key Functions | 2 - 6 |
| | 4 - 3 |
| PARAMETER key | 2 - 5 |
| Plug | 1 - 8 |
| Power Cable | 1 - 8 |
| Power connector | 2 - 9 |
| Power Frequency (I/O key) | 4 - 46 |
| Power On | 3 - 2 |
| POWER switch | 2 - 3 |
| Preheating Time | 1 - 10 |
| PRGM/NORMAL key | 2 - 4 |
| PRGM | 12 - 9 |
| Program Code | 6 - 16 |
| Program Example | 6 - 35 |
| Program No. 0 | 5 - 2 |
| Program No. 1 | 5 - 3 |
| Program No. 2 | 5 - 4 |
| Program No. 3 | 5 - 5 |
| Program No. 4 | 5 - 6 |
| Program No. 5 | 5 - 7 |

[Q]

| | |
|---------------------|--------|
| Query Command | 6 - 15 |
|---------------------|--------|

[R]

| | |
|---|---------|
| R12604 Setup | 11 - 15 |
| R12702A/B Setup | 11 - 2 |
| R12704 Setup | 11 - 4 |
| R12706A Setup | 11 - 10 |
| Rear Panel | 2 - 9 |
| Resistance Measurement Indication (COEF key) | 4 - 30 |
| Resistance Measurement | 3 - 22 |
| | 12 - 3 |
| Resistance Operation Error Message | 3 - 5 |
| Response to Query Command | 6 - 9 |
| RMT lamp | 2 - 5 |
| RUN/HOLD key | 2 - 3 |

[S]

| | |
|--|--------|
| S display | 2 - 8 |
| Safety Symbols | 2 - 2 |
| Sample Thickness (COEF key) | 4 - 34 |
| Sampling indicator | 2 - 8 |
| Self-test (CAL key) | 4 - 20 |
| Self-test Error Register | 6 - 33 |
| Sequence Program Operation Example | 5 - 19 |
| Sequence program | 12 - 9 |
| Sequence | 5 - 2 |
| SET key | 2 - 4 |
| Setting of Program Parameters | 5 - 12 |
| Setting of Volume-/ Surface-Resistivity Electrode (COEF key) | 4 - 31 |
| SPECIFICATION | 12 - 1 |
| SRQ lamp | 2 - 4 |
| Standard Accessories | 1 - 5 |
| Standard Bus Cable | 6 - 5 |
| Standard Event Status Register | 6 - 28 |
| START key | 2 - 4 |
| Status Byte Register | 6 - 25 |
| Supply Voltage | 1 - 7 |
| SURF display | 2 - 8 |

[T]

| | |
|--------------------------------|--------|
| Talker Specification | 6 - 7 |
| Terminator | 6 - 15 |
| TLK lamp | 2 - 4 |
| TR42 Setup | 11 - 5 |
| TR43C Setup | 11 - 7 |
| TR44 Setup | 11 - 9 |
| TRIG key | 2 - 3 |
| Trigger Delay (MEAS key) | 4 - 15 |
| Trigger Delay | 3 - 50 |
| TRIGGER INPUT connector | 2 - 9 |
| TRIGGER Input Signal | 7 - 10 |

[U]

| | |
|----------------------------------|--------|
| Unit Indication (MEAS key) | 4 - 14 |
| Unit indicator | 2 - 8 |
| UP key | 2 - 3 |
| Upper Level (COEF key) | 4 - 22 |

[V]

| | |
|---|--------|
| V display | 2 - 8 |
| V SOURCE terminal | 2 - 5 |
| Various Messages | 3 - 4 |
| VOL display | 2 - 8 |
| Voltage Applying Current Measurement | 3 - 17 |
| VSIM | 3 - 17 |
| VSRM | 3 - 22 |

[Z]

| | |
|-----------------------------|--------|
| Zero Cancel (CAL key) | 4 - 17 |
|-----------------------------|--------|

[Ω]

| | |
|------------------------|-------|
| Ω display | 2 - 8 |
|------------------------|-------|

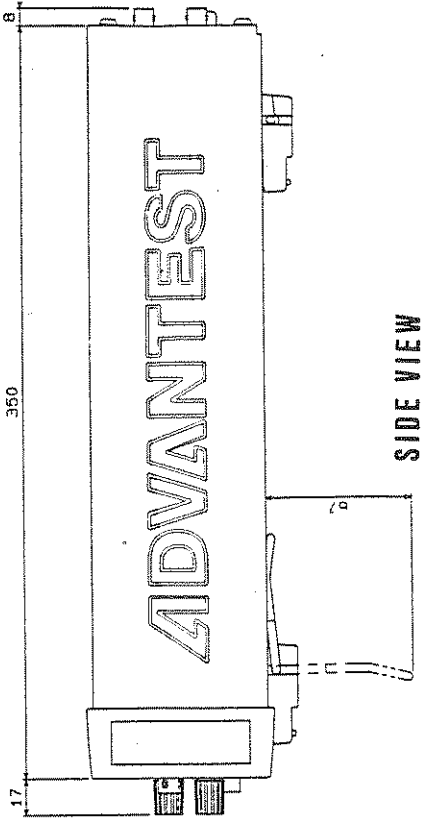

Unit:mm

SIDE VIEW

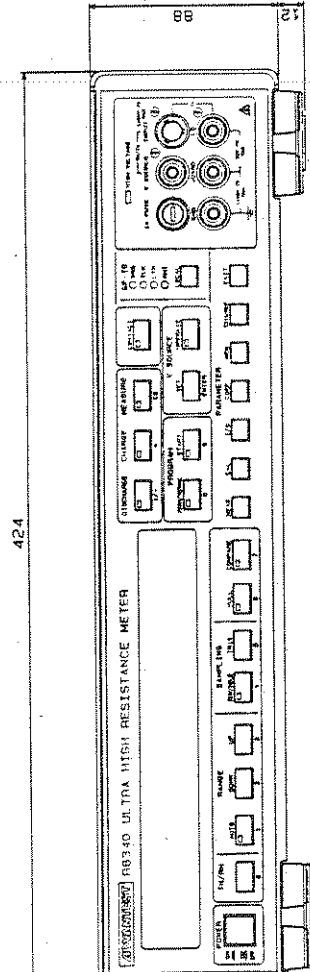

FRONT VIEW

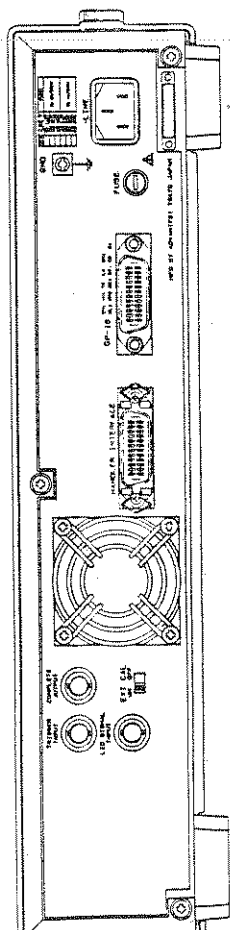

REAR VIEW

R8340

EXTERNAL VIEW

