

Anritsu

Precision RF & Microwave Components



The Industry Leader for High Frequency Components

RF MEASUREMENT CHART

SWR	Reflection Coefficient	Return Loss (dB)	Relative to Unity Reference			
			X dB Below Reference	Ref +X (dB)	Ref -X (dB)	Ref ±X (dB)
17.3910	0.8913	1	1	5.5350	19.2715	24.8065
8.7242	0.7943	2	2	5.0780	13.7365	18.8145
5.8480	0.7079	3	3	4.6495	10.6907	15.3402
4.4194	0.6310	4	4	4.2489	8.6585	12.9073
3.5698	0.5623	5	5	3.8755	7.1773	11.0528
3.0095	0.5012	6	6	3.5287	6.0412	9.5699
2.6146	0.4467	7	7	3.2075	5.1405	8.3480
2.3229	0.3981	8	8	2.9108	4.4096	7.3204
2.0999	0.3548	9	9	2.6376	3.8063	6.4439
1.9250	0.3162	10	10	2.3866	3.3018	5.6884
1.7849	0.2818	11	11	2.1567	2.8756	5.0322
1.6709	0.2512	12	12	1.9465	2.5126	4.4590
1.5769	0.2239	13	13	1.7547	2.2013	3.9561
1.4985	0.1995	14	14	1.5802	1.9331	3.5133
1.4326	0.1778	15	15	1.4216	1.7007	3.1224
1.3767	0.1585	16	16	1.2778	1.4988	2.7766
1.3290	0.1413	17	17	1.1476	1.3227	2.4703
1.2880	0.1259	18	18	1.0299	1.1687	2.1986
1.2528	0.1122	19	19	0.9237	1.0337	1.9574
1.2222	0.1000	20	20	0.8279	0.9151	1.7430
1.1957	0.0891	21	21	0.7416	0.8108	1.5524
1.1726	0.0794	22	22	0.6639	0.7189	1.3828
1.1524	0.0708	23	23	0.5941	0.6378	1.2319
1.1347	0.0631	24	24	0.5314	0.5661	1.0975
1.1192	0.0562	25	25	0.4752	0.5027	0.9779
1.1055	0.0501	26	26	0.4248	0.4466	0.8714
1.0935	0.0447	27	27	0.3798	0.3969	0.7765
1.0829	0.0398	28	28	0.3391	0.3529	0.6919
1.0736	0.0355	29	29	0.3028	0.3138	0.6166
1.0653	0.0316	30	30	0.2704	0.2791	0.5495
1.0580	0.0282	31	31	0.2414	0.2483	0.4897
1.0515	0.0251	32	32	0.2155	0.2210	0.4365
1.0458	0.0224	33	33	0.1923	0.1967	0.3890
1.0407	0.0200	34	34	0.1716	0.1751	0.3467
1.0362	0.0178	35	35	0.1531	0.1558	0.3090
1.0322	0.0158	36	36	0.1366	0.1388	0.2753
1.0287	0.0141	37	37	0.1218	0.1236	0.2454
1.0255	0.0126	38	38	0.1087	0.1100	0.2187
1.0227	0.0112	39	39	0.0969	0.0980	0.1949
1.0202	0.0100	40	40	0.0864	0.0873	0.1737
1.0180	0.0089	41	41	0.0771	0.0778	0.1548
1.0160	0.0079	42	42	0.0687	0.0693	0.1380
1.0143	0.0071	43	43	0.0613	0.0617	0.1230
1.0127	0.0063	44	44	0.0546	0.0550	0.1096
1.0113	0.0056	45	45	0.0487	0.0490	0.0977
1.0101	0.0050	46	46	0.0434	0.0436	0.0871
1.0090	0.0045	47	47	0.0387	0.0389	0.0776
1.0080	0.0040	48	48	0.0345	0.0346	0.0692
1.0071	0.0035	49	49	0.0308	0.0309	0.0616
1.0063	0.0032	50	50	0.0274	0.0275	0.0549
1.0057	0.0028	51	51	0.0244	0.0245	0.0490
1.0050	0.0025	52	52	0.0218	0.0218	0.0436
1.0045	0.0022	53	53	0.0194	0.0195	0.0389
1.0040	0.0020	54	54	0.0173	0.0173	0.0347
1.0036	0.0018	55	55	0.0154	0.0155	0.0309
1.0032	0.0016	56	56	0.0138	0.0138	0.0275
1.0028	0.0014	57	57	0.0123	0.0123	0.0245
1.0025	0.0013	58	58	0.0109	0.0109	0.0219
1.0022	0.0011	59	59	0.0097	0.0098	0.0195
1.0020	0.0010	60	60	0.0087	0.0087	0.0174

- The first three columns are conversion tables for return loss, reflection coefficient, and SWR.
- The last four columns are values for interactions of a small phasor X with a large phasor (unity reference) expressed in dB related to reference.

The RF Measurement Chart can be used to determine the uncertainty due to bridge/autotester VNA directivity. The "X dB Below Reference" column represents the difference between the directivity and the measured reflection (return loss). The "ref + X dB" and "ref - X dB" values are the algebraic sum of the error signal and the measured reflected signal as their phase relationship varies over 360°. Therefore, the peak-to-peak ripple (1 ± X) is the total measurement uncertainty caused by the error signal.

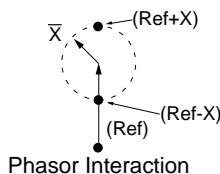

For example, if a 30 dB return loss is measured with a 40 dB directivity autotester, the X dB Below Reference value is 10 dB. Ref + X dB is 2.3866 dB and ref - X dB is 3.3018 dB. The actual return loss is between 27.6134 dB (-30 + 2.3866) and 33.3018 dB (-30 - 3.3018). The peak to peak ripple on a swept measurement will be 5.6884 dB. If the error and directivity signals are equal, ref + X dB equals 6 dB (voltage doubled causes 6 dB change) and ref - X dB becomes infinite, since the two signals are equal in amplitude and 180° out of phase (zero voltage).

ANSI Standard

X mm	±5 mm
X.X mm	±0.5 mm
X.XX mm	±0.15 mm
X.XXX mm	±0.05 mm

Above ANSI Standard tolerance applies to all components unless otherwise noted.

TABLE OF CONTENTS

High Return Loss Connectors and Cables

<i>K Connector</i> [®]	4
<i>V Connector</i> [®]	9
<i>Integrated V Connectors</i>	14
<i>VP Connector</i> [™]	15
<i>WI Connector</i> [®]	18
<i>RF Cables K120, V120</i>	20
<i>Armored Semi-Rigid Test Port Cables</i>	23

Instrumentation Grade Adapters

<i>Coaxial Adapters K, V, K to V</i>	24
<i>Panel Coaxial Adapters</i>	25
<i>Calibration Grade Adapters 33 Series</i>	26
<i>Instrumentation Grade Adapters 34 Series</i>	29
<i>Precision Adapters</i>	29
<i>Ruggedized Adapters</i>	29
<i>Instrumentation Grade Adapters 34 Series W to V</i>	30
<i>Instrumentation Grade Waveguide Adapters 35WR Series</i>	31
<i>Instrumentation Grade Waveguide Adapters 35U, 35C Series</i>	35

Precision Terminations

<i>Coaxial Terminations 28, 29 Series</i>	39
<i>Coaxial Terminations K210, V210</i>	40
<i>Fixed Attenuators 41, 43 Series</i>	41
<i>Step Attenuators 4400, 4500, 4600 Series</i>	43

Measurement Components and Accessories

<i>SWR Bridges 87 Series</i>	45
<i>SWR Autotesters 97 Series, 560-97, 560-98 Series</i>	46
<i>SWR Autotesters 5400-6 Series</i>	48
<i>Convertible SWR Autotesters 560-98C50A and Test Port Heads</i>	49
<i>Airlines 18, 19 Series</i>	51
<i>Open/Shorts 22 Series</i>	52
<i>Open/Shorts/Loads OSL Series</i>	53
<i>Microwave Detectors 70, 75 Series</i>	54
<i>Field Replacement Diode Module</i>	56
<i>Microwave Detectors 5400-71, 560-7 Series</i>	57
<i>Power Sensors MA2400A/D Series</i>	58
<i>Power Dividers 11 Series</i>	62
<i>Power Dividers K240, V240 Series</i>	63
<i>Power Splitters K241, V241 Series</i>	64
<i>Power Splitters N241 Series</i>	65
<i>SPDT Switch</i>	66
<i>Bias Termination DBT60, DBTCPW</i>	67
<i>Bias Tee K250, V250 Series</i>	68
<i>Ultra-Wideband Bias Tee K251, V251 Series</i>	69
<i>Kelvin Connection Bias Tee K252, V252</i>	71
<i>Ultra-Wideband Bias Tee V255</i>	72
<i>Precision DC Blocks K261, V261</i>	74
<i>DC Blocks V265</i>	76
<i>Universal Test Fixture 3680 Series</i>	78
<i>Limiters 1 Series</i>	81
<i>Matching Pads 12 Series</i>	82
<i>VNA and VNMS Calibration Kits</i>	83
<i>VNA and VNMS Verification Kits</i>	85
<i>Part Number Index</i>	86

OUTLINE OF PRECISION MEASUREMENT COMPONENTS



Precision Components-Precision Measurements

Anritsu is a leader in the design and production of precision microwave components.

- *Precision Coaxial Connector Systems to 65 GHz*
- *Precision Coaxial and Waveguide to Coax Adapters*
- *High Directivity SWR Autotesters and Bridges*
- *RF Detectors*
- *Precision Terminations and Air lines*
- *Precision Fixed Attenuators*
- *Precision Step Attenuators*
- *Precision Power Dividers and Splitters*
- *Precision Bias Tees*
- *Broadband Microwave Limiters*

Connector Design Leadership

Anritsu is the leader of high frequency microwave connector technology and is driven by an ongoing commitment to exceed customer needs. Anritsu created and trademarked the K Connector® with coverage to 40 GHz, along with a complete family of 40 GHz test equipment. It was an immediate success and today is used on many commercial components, test fixtures, and military systems.

The V Connector® offers coaxial coverage to 65 GHz and uses a 1.85 mm geometry endorsed by the International Electrotechnical Commission (IEC). It mates with commercially available 2.4 mm connectors.

Anritsu continues its leadership role with the introduction of the Integrated V Connector, which combines compatibility with V Connectors with easy installation and consistent excellent performance.

The VP™ Connector delivers push-on simplicity with excellent performance to 65 GHz.

The W1 Connector™ provides mode-free performance to 110 GHz and uses a 1.00 mm coaxial connector front side interface.

Coaxial and Waveguide to Coax Adapters

A series of precision measurement adapters are available to adapt one connector type to another. Poor adapter VSWR (or poor return loss) can be a major source of measurement error and, therefore adapters, must be carefully selected. Anritsu precision adapters typically have 6-12 dB better return loss than competitive units. Waveguide-to-Coax Adapters are available to 65 GHz.

Precision Terminations and Air Lines

Anritsu is recognized as the leader in the field of impedance standards. Anritsu air lines and terminations are unsurpassed for accuracy and impedance match. Not only do these products increase measurement accuracy, they also provide the only method of certifying the performance of SWR Autotesters, bridges, directional couplers, and other devices.

Precision Fixed Attenuators

Anritsu attenuators offer superior performance in a low cost package. The low VSWR (excellent return loss) minimizes signal reflections and simultaneously reduces ripple effects in the output frequency response. This assures flat, consistent attenuation characteristics regardless of other devices reflection characteristics. One of the simplest ways to improve impedance match is to insert a precision attenuator between the device under test and the source or RF detector. The 41K and 41V Series attenuators are specifically designed for such applications where accuracy is a basic requirement.

In addition to being available as individual units of 3, 6, 10, or 20 dB, the 41K and 41V Series Fixed Attenuators are also available in sets with certified calibration data. Available frequency ranges cover DC to 26.5 GHz, 40 GHz, or 65 GHz.

Many other attenuator applications have as their principal objective the reduction of power. Since the attenuator might not be inserted at a measurement point, the measurement precision discussed earlier is not required. In such a power-reducing system application, attenuators are often required in large quantities, making price an important consideration. The 43K Series includes models covering DC to 26.5 GHz, and DC to 40 GHz. All are available with 3, 6, 10, or 20 dB attenuation values. All have the Anritsu K Connectors and are compatible with SMA connectors.

Whatever your fixed attenuator needs might be, Anritsu provides the solution.



Precision Step Attenuators

Anritsu offers low loss, high precision step attenuators. These programmable step attenuators are available with 10 dB steps from 0 to 70 dB or 0 to 110 dB ranges. DC to 40 GHz frequency range ensures the broadest attenuation and frequency coverage available. Contact Anritsu for needs above 40 GHz.

Precision Power Dividers and Splitters

Anritsu produces precision V Connector® dividers and splitters to 65 GHz and precision K Connector® dividers and splitters to 40 GHz.

All Anritsu power dividers are 3-resistor symmetrical designs with excellent amplitude and phase tracking. Anritsu power splitters are 2-resistor designs, used to accurately split signals for ratio measurements.

Precision Bias Tees

Anritsu Bias Tees are used to combine DC and RF for active device measurements. Low RF throughline loss and low SWR ensure negligible effect on measurements from 50 kHz to 60 GHz.

Broadband Microwave Limiters

Anritsu broadband microwave limiters provide the widest frequency range available in a limiter. Designed to protect sensitive microwave equipment, these limiters incorporate unique single-side limiting to provide soft limiting characteristics over 10 MHz to 26.5 GHz.

High Directivity SWR Autotesters and Bridges

SWR Autotesters and SWR Bridges are directional measurement devices that separate the incident and the reflected signals of a device under test. The reflected component can then be compared to the incident signal to determine the difference between the device's impedance and its characteristic impedance.

An SWR bridge has a precision termination inside the bridge, eliminating the need for an external reference. An autotester further simplifies the user interface by incorporating a detector into the RF output that provides a DC output proportional to the DUT mismatch.

The directivity of the SWR Autotester or bridge is the measure of how well the incident and reflected signals can be separated. For example, 40 dB directivity means that the error signal in the output is 40 dB below the reflected signal to be measured.

Anritsu's high directivity bridges and autotesters set the standards for reflection measurements. High directivity translates to accurate measurements. Anritsu high directivity bridges are available for GPC-7, 50 Ω and 75 Ω Type N. High directivity autotesters are available with GPC-7, Type N, and SMA, 3.5, K Connectors®, and V Connectors®.

RF Detectors

Just as directivity is the principal error contributor in reflection measurements, the impedance match of the signal source and RF detector is a significant error contributor in transmission measurements.

Anritsu offers a complete line of coaxial RF detectors covering from 100 kHz to 50 GHz with the lowest SWR available. The excellent impedance match of the detectors, along with that of the test port on the SWR Autotesters and bridges, minimize errors when making simultaneous transmission and measurements.

Calibration and Verification Kits

Anritsu offers calibration kits which contain all the precision components and tools required to calibrate an Anritsu VNA in a connector style of your choice.

Specials

Anritsu also manufactures assemblies and components to meet specific customer requirements in both coaxial and waveguide structures. These include such components as Connectors, Bias Tee, Step Attenuator, Detector, Power Sensors, Waveguide, Coaxial Adapters, and RF Cables etc.

When requesting quotations on special assemblies, as a minimum please provide this information: frequency range, electrical characteristics, mechanical details and outline dimensions if any.

K CONNECTOR®

DC to 40 GHz

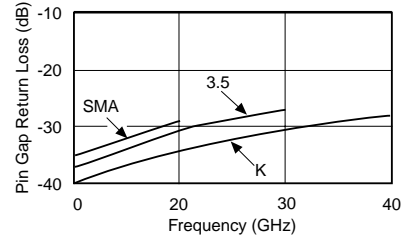
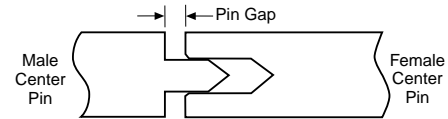

Effect of Pin Gap

The K Connector® is a precision coaxial connector system that operates up to 40 GHz. It is compatible with SMA, WSMA, and 3.5 mm connectors. It is well suited to applications in components, systems, or instrumentation.

K Connector® features

- Excellent performance up to 40 GHz
- Performance exceeding SMA below 18 GHz
- Superior reliability
- Compatibility with SMA, WSMA, and 3.5 mm
- Complete testability on existing network analyzers

Exceptional reliability and repeatability

Microwave connector reliability is affected by insertion force, outer conductor strength, stress relief while mating, and mating alignment. The K Connector exhibits exceptional performance in all of these areas.

For proper seating, a standard SMA or 3.5 mm connector can require in excess of 27N* of insertion force. In contrast, the K Connector requires only 2.3N*. The reduced wear on the female center conductor improves reliability. In addition, the K Connectors outer conductor is four times thicker than that of SMA. Taken together, the lower insertion force and the thicker wall offer more reliable connections than available from an SMA connector. Life tests show that the K Connector makes greater than 10,000 connections with negligible change in electrical characteristics.

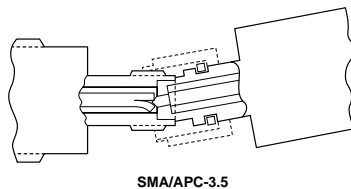

SMA/APC-3.5

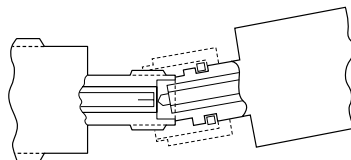

K Connector

Shortened Male Pin Eliminates Damage to Female K Connector

*Force is measured in Newtons (N).

All K Connectors, including the cable connectors, incorporate a feature that eliminates a major cause of connector failure; misalignment of the male pin with respect to the female contacts. To solve the problems the K Connector male pin is deliberately made shorter than the SMA or 3.5 mm pin. With this arrangement, the outer housing is properly aligned prior to the mating of the center conductors. Thus a proper, non-destructive alignment before mating is ensured.

The effect of pin gap on a connection is often overlooked, but is the dominant source of error in many connection systems. Pin gap is the short length of smaller diameter caused when a connector pair is mated. Pin gap causes a discontinuity at the connector interface. The K Connector has considerably less susceptibility to pin gap than either SMA or 3.5 mm connectors.

Many connector manufacturers specify connector performance assuming no pin gap, an unrealistic assumption. K Connectors are specified assuming pin gap to be at its maximum tolerance, to provide you the assurance of real-world specifications.

Compatibility

The K Connector interfaces electrically and mechanically with 3.5 mm connectors, including SMA and 3.5 mm without degradation in performance.

Launcher design

At the heart of the K Connector product line are the launchers. As their name implies, the launchers “launch” (make the transition) from a microwave circuit (microstrip, suspended substrate, stripline, or coplanar waveguide) to a coaxial connector and an outside transmission line. The key to making the transition without compromising electrical and mechanical objectives is the glass bead in the launcher assembly.

K CONNECTOR®

DC to 40 GHz

Low-reflection bead

The K Connector®'s standard glass bead has a 0.30 mm center conductor and readily connects to fragile devices. The bead is appropriate for most applications employing Duroid® and ceramic (Alumina) microstrip, such as the 0.25 mm wide transmission line on a 0.25 mm thick Alumina substrate. Applications using suspended substrate geometry are equally well satisfied. The bead is constructed of Corning 7070 glass and has a gold-plated center conductor and a gold-plated Kovar® collar.

The outstanding design of the bead is largely accountable for the excellent performance of the K Connector launchers. Because the small 0.30 mm pin introduces minimal discontinuity, return loss is typically better than 20 dB at 40 GHz and better than 25 dB below 18 GHz. In addition, the design provides for soldering the bead to achieve a hermetic seal. 310°C max. soldering temperature is recommended.

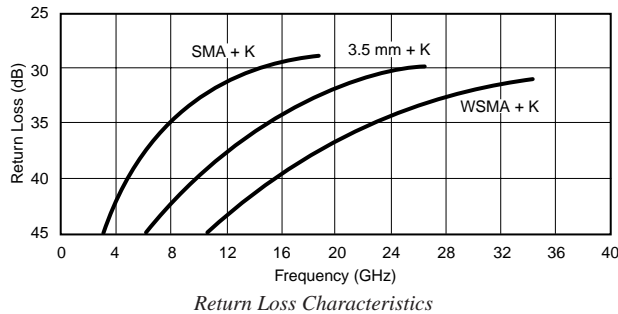

Both the sparkplug (screw-in) and the flange-mount K Connector launchers offer an additional advantage over existing designs. These launchers do not use an epoxy pin to secure the center conductor, as used in some SMA designs. Without an epoxy pin, the outer conductor remains solid, and thereby eliminates the leakage path common to pin-captivated designs. Furthermore, K launchers have a wall thickness that is four times that of typical launchers (0.8 vs. 0.2 mm). The heavier wall results in superior resistance to over-torquing. Finally, the K Connector launcher can be removed for repair without removal of the glass bead. This ensures that during removal the critical microcircuit-to-glass bead interface is not disturbed, hermeticity is preserved, and the micro-circuit will not be subjected to the additional stress caused by heating to soldering temperature. Hardware locking compound such as "Removable Loctite®" should be used to further secure the screw-in launcher in its housing.

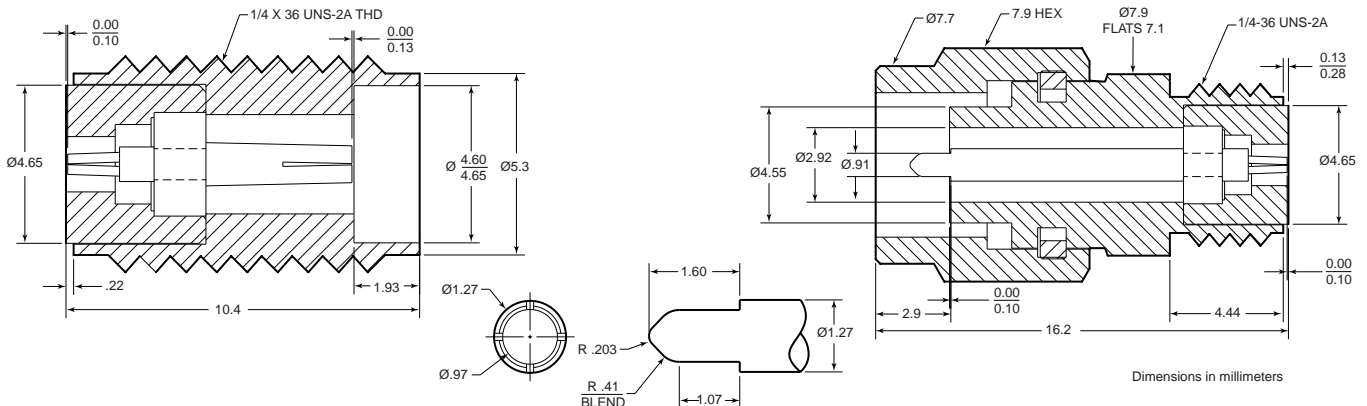

K Connector® interface dimensions in metric measurements

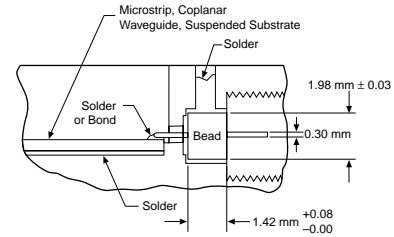

Transition from Microcircuit to External Transmission Line

Complete family

Virtually every interface need can be satisfied by one or more of the K Connector items offered. There are six different models of K Connector launchers. Two sparkplug (screw-in) launchers are available, the K102F female version and the K102M male version. Both screw into the housing that encloses the microwave circuit, and, like all Anritsu launchers, they can be easily removed for replacement or repair without unsoldering the glass bead and its interface to the microwave circuit.

When the housing that encloses the microwave circuit is not thick enough to support a threaded, screw-in launcher, flush-mounted (flange) launchers are required. Models with two mounting holes are available in both male and female versions, K103M and K103F. Two other models, the K104F and K104M, have four mounting holes. Mounting hole spacing is identical to that of similar SMA flange launchers. The glass bead interface, of course, is the same design used for the sparkplug launcher.

Cable connectors

Both male and female cable connectors are available. The cable connectors, K101M and K101F, use gold-plated, beryllium-copper center conductors for optimum performance and wear characteristics. Typical return loss at 40 GHz for finished cables exceeds 16 dB (1.35 SWR).

K CONNECTOR®

DC to 40 GHz



Evaluation kit

01-101A

Evaluation Kit

Kit contains one K120 25 cm Male/Male Cable Assembly, two K102F Female Sparkplug Launcher Connector Assemblies, two K104F Female Flange Launcher Connector Assemblies, five K100 Glass Beads, one 01-102A Test Fixture, one 01-104 Drill and Tap Set, five K110-1 Microstrip Sliding Contacts, and all other parts and fixtures required to assemble launchers with or without sliding contacts.

Tools and fixtures



01-103

Soldering Fixture for sparkplug launcher glass beads, package of 10



01-104

Drill and Tap Set

for precision machining of concentric holes for mounting K Connector® in microwave housing. (Drill Part No. B14094) (Tap Part No. 783-255)



01-105A

Male and Female Sparkplug Torquing Kit



01-106

K Soldering Fixture for flange launcher glass bead, package of 5.



01-107M or 01-107F

Cable Sleeve Soldering Fixture for K101M Male and K101F Female Cable Connectors, package of 10.



01-108

Drill and Tap Set

For precision machining of concentric holes for mounting K Connector® in microwave housing in applications where stress relief contacts are used. (Drill Part No. B16526) (Tap Part No. 783-255)



01-118

K Connector® Cable Assembling Fixture Kit for K118 semi-rigid coaxial cable.



01-201

Anritsu provides two connector tools that make connecting and disconnecting tiny connectors more easily and surely accomplished. These tools are featured below.



01-204

Features

- 01-201 Torque wrench: 0.9 N-M (8 in-lb) for standard SMA and 3.5 mm connectors, and for the Anritsu K Connector® and V Connector®.
- 01-204 Handy stainless steel connector wrench for standard SMA, 3.5 mm, and 2.4 mm connectors, and for the Anritsu K Connector® and V Connector®.

Semi-rigid coaxial cable

Type	Semi-rigid coaxial, tin-plated copper outer conductor, silver-plated copper center conductor.
Impedance	50 ± 2 Ω
Dielectric type	Microporous Teflon, 0.24 cm diameter
Dielectric constant	1.687
Relative velocity	0.77
Outside diameter	3.00 mm
Center conductor diameter	0.81 mm
Minimum bend radius	0.65 cm
Attenuation	1.6 dB/m at 10 GHz 2.3 dB/m at 20 GHz 3.3 dB/m at 30 GHz 4.7 dB/m at 40 GHz



K118

Semi-rigid Coaxial Cable

1.5m length of 3.00 mm semi-rigid cable for K101 series connector

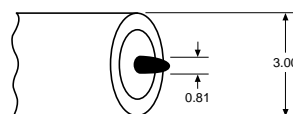

Dimensions in millimeters

K CONNECTOR®

DC to 40 GHz

Launchers and cable connectors

Coupling nut tightening torque	1.36 N-m max
Material	Passivated stainless steel with heat-treated beryllium copper center conductors
Pin depth	0.000 to -0.13 mm for male and female connectors
Temperature range	-55°C to +125°C (200°C available; contact factory)



K101M^{④⑥}
K Male In-Line Cable Connector, DC-40 GHz for 3 mm cable
K101M-085^④
for 2.16 mm cable

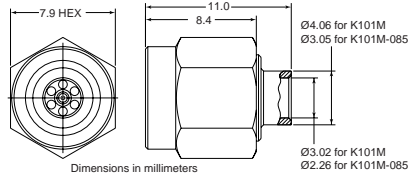

K101F^{⑤⑥}
K Female In-Line Cable Connector, DC-40 GHz for 3 mm cable

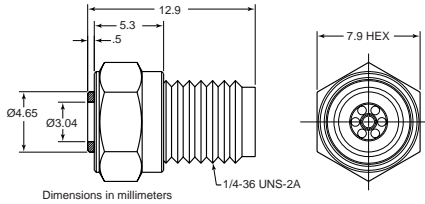

K102M^③
K Male Sparkplug Launcher Connector, DC-40 GHz

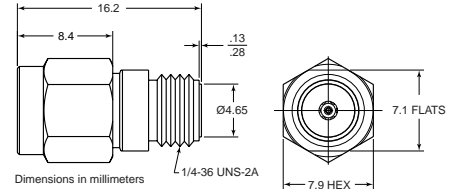

K102F^③
K Female Sparkplug Launcher Connector, DC-40 GHz

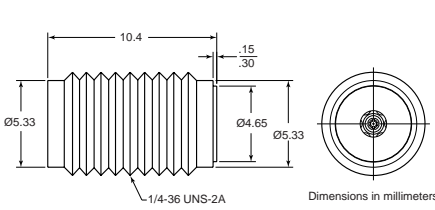

K103M
K Male Flange Launcher, two-hole, DC-40 GHz

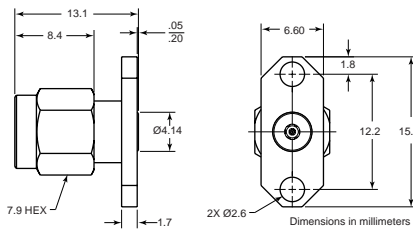

K103F
K Female Flange Launcher, two-hole, DC-40 GHz

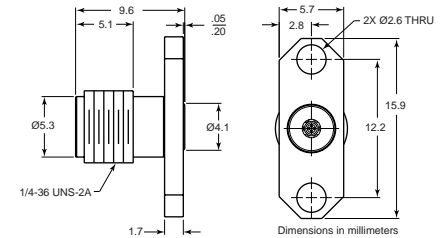

K104M
K Male Flange Launcher, four-hole, DC-40 GHz

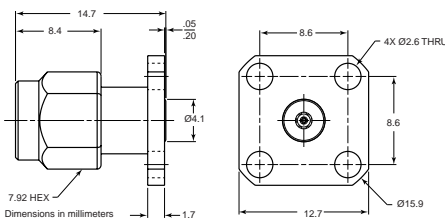

K104F
K Female Flange Launcher, four-hole, DC-40 GHz

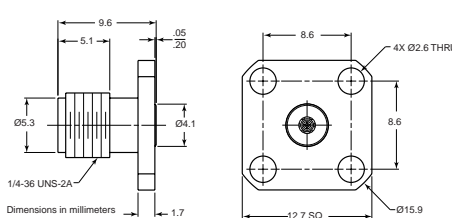

- ① Use with 01-104 or 01-108 Drill and Tap Sets
- ② Use with 01-103 or 01-106 Soldering Fixtures
- ③ Use with 01-105A Male and Female Sparkplug Torquing Kit
- ④ Use with 01-107M Cable Sleeve Fixture
- ⑤ Use with 01-107F Cable Sleeve Fixture
- ⑥ Use with 01-118 Cable Assembly Fixture Kit

K CONNECTOR®

DC to 40 GHz



K100^{①②}
Glass Beads for K102, K103, and K104 connectors
Note: Glass Beads can be purchased through recommended vendors. For more information visit www.anritsu.com.



K100B^{①②}
High Hermeticity* Glass Beads for K102, K103, and K104 connectors
Note: Glass Beads can be purchased through recommended vendors. For more information visit www.anritsu.com.

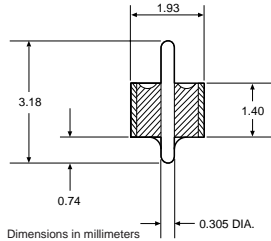
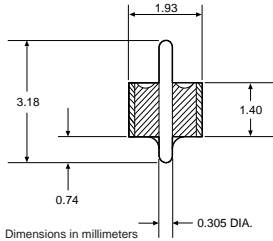

*Glass Bead Hermeticity Spec: Hermetic to 1×10^{-8} std cc He/sec at 1 atm differential

Stress relief contacts

Stress Relief Contacts provide an elegant yet simple solution to relieving stress at the interface of the microcircuit and its connecting coaxial conductor. These contacts simply slide onto the standard K100 and K100B glass bead pins.

Frequency range	DC to 40 GHz
Material	0.025 mm heat-treated BeCu
Plating	Bondable gold over nickel

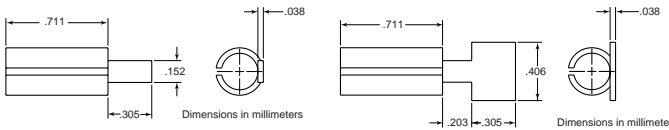

K110-1^① Microstrip and Coplanar Waveguide

K110-3^① Microstrip

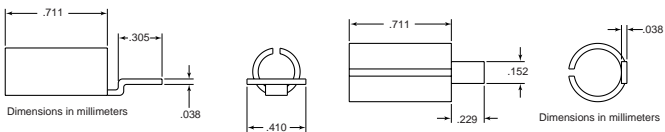

K110-2^① Stripline

S110-1 Microstrip and Coplanar Waveguide for 0.38 mm glass feedthru center conductor

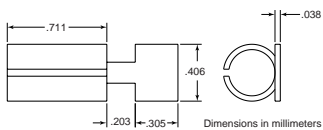

S110-3 Microstrip and Coplanar Waveguide for 0.38 mm glass feedthru center conductor

Ordering information

Please specify model/order number, name, and quantity when ordering.

Model/Order No.	Name
01-101A	K Connector® (evaluation kit)
01-103	Soldering fixture for sparkplug launcher glass bead
01-104	Drill and tap set
01-105A	Male and female sparkplug torquing kit
01-106	Soldering fixture for flange launcher glass bead
01-107F	Cable sleeve soldering fixture, female connector
01-107M	Cable sleeve soldering fixture, male connector
01-108	Drill and tap set
01-118	Cable assembling fixture for K118 semi-rigid coax cable
01-201	Torque wrench, for SMA, 3.5mm, and K Connector and V Connector
01-204	Anritsu stainless steel connector wrench
K110-1	Microstrip stress relief contact
K110-2	Stripline stress relief contact
K110-3	Microstrip stress relief contact
K101M	K(m) in-line cable connector, DC to 40 GHz for K118 cable
K101M-085	K(m) in-line cable connector, DC to 40 GHz for V085 cable
K101F	K(f) in-line cable connector, DC to 40 GHz
K102M	K(m) sparkplug launcher connector, DC to 40 GHz
K102F	K(f) sparkplug launcher connector, DC to 40 GHz
K103M	K(m) flange launcher connector, DC to 40 GHz, 2 mounting holes
K103F	K(f) flange launcher connector, DC to 40 GHz, 2 mounting holes
K104M	K(m) flange launcher connector, DC to 40 GHz, 4 mounting holes
K104F	K(f) flange launcher connector, DC to 40 GHz, 4 mounting holes
K118	Coaxial cable, 1.5m of 3.00 mm semi-rigid cable for K101 series connector
S110-1	Microstrip and coplanar waveguide stress relief contact for 0.38 mm glass feedthru center conductor
S110-3	Microstrip and coplanar waveguide stress relief contact for 0.38 mm glass feedthru center conductor

① Use with 01-108 Drill and Tap Set

V CONNECTOR®

DC to 65 GHz

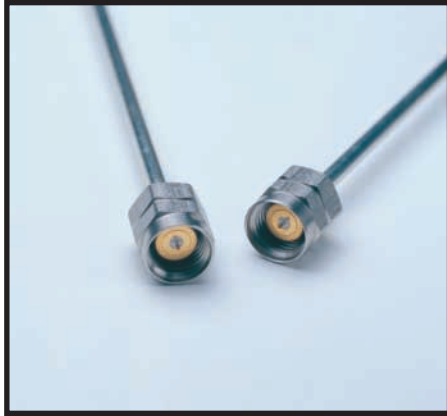

The V Connector® is a reliable 1.85 mm device that operates up to 65 GHz. It is compatible with 2.4 mm connectors and is assembled using procedures that are similar to those used on K Connectors. It is well suited to applications in components, systems, or instrumentation.

V Connector® features

- Excellent performance up to 65 GHz
- Low VSWR
- Superior reliability
- Low Loss

Exceptional reliability and repeatability

Microwave connector reliability is affected by insertion force, outer conductor strength, stress relief while mating, and mating alignment. The V Connector exhibits exceptional performance in all of these areas.

For proper seating, the V Connector requires only 1/2 the insertion force of a 2.4 mm connector. The reduced wear on the center conductor equates to greater reliability. All V Connectors, including the cable connectors, incorporate another feature that eliminates a major cause of connector failure; misalignment of the male pin with respect to the female. To solve the problem, the V Connector male pin is deliberately made sufficiently short to prevent damage to the female connector by misalignment. With this arrangement, the outer housing must be properly aligned prior to the mating of the center conductors. Thus a proper, non-destructive alignment before mating is ensured.

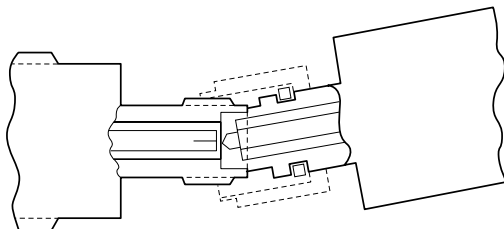

V Connector

Shortened Male Pin Eliminates Damage to Female V Connector

The effect of pin gap on a connection is often overlooked, but is the dominant source of error in many connection systems. Pin gap is the short length of smaller diameter created when a connector pair is mated. Pin gap causes a discontinuity at the connector interface. The V Connector has considerably less susceptibility to pin gap than 2.4 mm connectors.

Many connector manufacturers specify connector performance assuming no pin gap, an unrealistic assumption. V Connectors are specified assuming pin gap to be at its maximum tolerance, to provide you the assurance of real-world specifications.

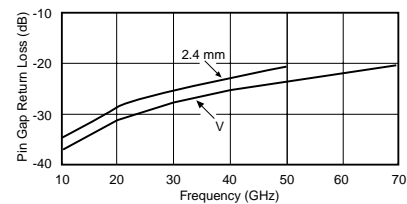
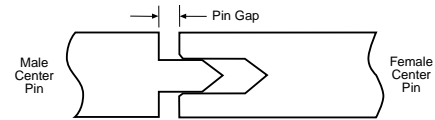

Effect of Pin Gap

Launcher design

At the heart of the V Connector product line are the launchers. As their name implies, the launchers “launch” (make the transition) from a microwave circuit (microstrip, suspended substrate, stripline, or coplanar waveguide) to a coaxial connector and an outside transmission line. The key to making the transition without compromising electrical and mechanical objectives is the glass bead in the launcher assembly.

Low-reflection glass bead

The V Connector’s standard glass bead has a unique 0.24 mm center conductor and readily connects to fragile devices. The bead is appropriate for most applications employing Duroid and ceramic (Alumina) microstrip, such as the 0.25 mm wide center conductor on a 0.25 mm thick Alumina substrate. Applications using suspended substrate geometry are equally well satisfied. The bead is constructed of Corning 7070 glass and has a gold-plated center conductor and a gold-plated Kovar® collar.

The outstanding design of the bead is largely accountable for the excellent performance of the V Connector launchers. In addition, the design provides for soldering the bead to achieve a hermetic seal. 310°C max. soldering temperature is recommended. The V Connector® launchers can be removed for repair without removal of the glass bead. This ensures that during removal the critical microcircuit-to-glass bead interface is not disturbed, that hermeticity is preserved, and that the microcircuit will not be subjected to the additional stress caused by heating to soldering temperature. Hardware locking compound such as “Removable Loctite®” should be used to further secure the launcher in its housing.

V CONNECTOR®

DC to 65 GHz

Complete family

Anritsu's family of V Connector® products is large and growing. Virtually every interface need can be satisfied by one or more of the items offered. As a convenience to the design engineer, each item is completely specified with both guaranteed and typical performance. There are four different models of V Connector launchers. Two types of sparkplug (screw-in) launchers are available; the V102F female version and the V102M male version. Both screw into the housing that encloses the microwave circuit. And, like all Anritsu launchers, they can be easily removed for replacement or repair without unsoldering the glass bead and its interface to the microwave circuit.

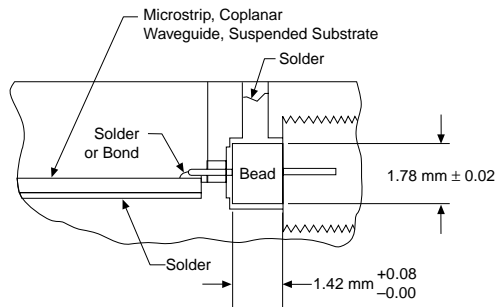

Transition from Microcircuit to Outside Transmission Line

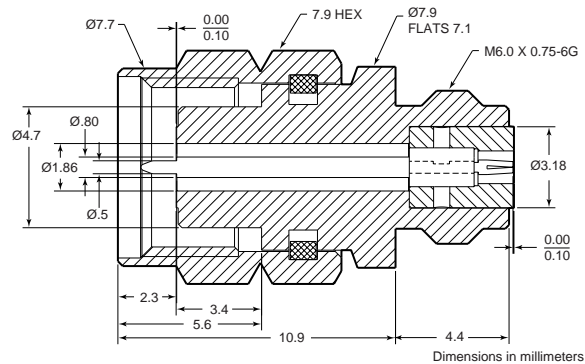
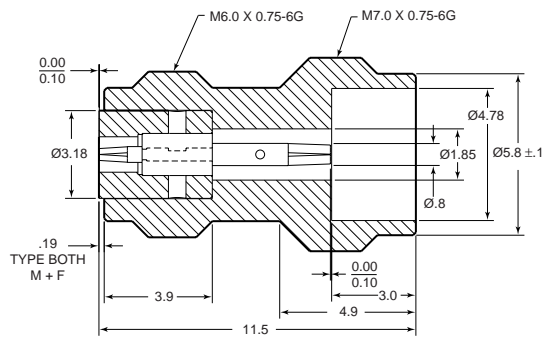

V Connector interface dimensions

When the housing that encloses the microwave circuit is not thick enough to support a threaded, screw-in launcher, flush-mounted (flange) launchers are required. Models with two mounting holes are available in both male and female versions, V103M and V103F. The mounting hole spacing is identical to that of similar SMA flange launchers. The glass bead interface, of course, is the same design used for the sparkplug launcher.

Cable connectors

To complement high performance V085 cable, both male and female cable connectors are available. Typical return loss at 65 GHz for finished cables exceeds 16 dB (1.35 SWR).

The V Connector® coaxial cable connectors use a 2.16 mm cable with a microporous Teflon dielectric and a copper center conductor. The cable assemblies use the center conductor of the coax as the male pin. This is similar to the UT-141 SMA-type assembly and 2.4 mm cable assemblies. The microporous Teflon dielectric has maximum phase stability and minimum insertion loss. This type of cable assembly allows for easy assembly and maximum RF performance; however, since the male pin is copper, the cable assemblies are not suitable for repeated connections. In applications where the cable will be subject to more than 100 connections, we recommend that a connector saver be used.

Evaluation kit

01-301

V Connector Evaluation Kit contains one V120MM - 25CM Male/Male Cable Assembly, two V102F Female Sparkplug Launcher Connector Assemblies, two V103F Female Flange Launcher Connector Assemblies, two V101M Male In-line Cable Connector Assemblies, five V100 Glass Beads, one 01-304 Drill and Tap Set, one 01-302 Test Fixture, two 01-303 Soldering Fixtures.



Tools and fixtures

01-303

Soldering Fixture for sparkplug launcher glass beads, package of 10.



01-304

Drill and Tap Set for precision machining of concentric holes for mounting V Connector in microwave housing. (Drill Part No. 783-568) (Tap Part No. 783-569)



V CONNECTOR®

DC to 65 GHz

01-105A

K and V Connector® Male and Female Sparkplug Torquing Kit.



01-306

Soldering Fixture for flange launcher glass bead, package of 5.



01-307M or 01-307F

Cable Sleeve Soldering Fixture for V101M Male and V101F Female Cable Connectors, package of 10.



01-308

Drill and Tap set for precision machining of concentric holes for mounting V Connector in microwave housing in applications where stress-relief contacts are used. (Drill Part No. 55300) (Tap Part No. 783-569)



01-309

V Connector Cable Assembling Fixture for V085 semi-rigid cable.



Anritsu provides two connector tools that make connecting and disconnecting tiny connectors more easily and surely accomplished. These tools are featured below.



Features

- 01-201 Torque wrench: 0.9 N-M (8 in-lb) for standard SMA and 3.5 mm connectors, and for the Anritsu K Connector® and V Connector®.
- 01-204 Handy stainless steel connector wrench for standard SMA, 3.5 mm, and 2.4 mm connectors, and for the Anritsu K Connector® and V Connector®.

Semi-rigid coaxial cable

Type	Semi-rigid coaxial, tin-plated copper outer conductor, silver-plated copper center conductor.
Impedance	50 ± 2 Ω
Dielectric type	Microporous Teflon, 0.14 cm diameter
Dielectric constant	1.687
Relative velocity	0.77
Outside diameter	2.16 mm
Center conductor diameter	0.51 mm
Minimum bend radius	0.65 cm
Attenuation	2.3 dB/m at 10 GHz 3.6 dB/m at 20 GHz 4.3 dB/m at 30 GHz 5.2 dB/m at 40 GHz 7.2 dB/m at 60 GHz

V085

semirigid coaxial cable

1.5m length of 2.16 mm semirigid cable for V101 series connector

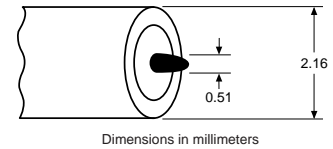

Stress relief contacts

Stress Relief Contacts provide an elegant yet simple solution to relieving stress at the interface of the microcircuit and its connecting coaxial conductor. These contacts simply slide onto the standard glass bead pins and can be soldered, bonded or parallel-gap welded to a circuit trace.

Frequency range	DC to 67 GHz
Material	0.025 mm heat-treated BeCu
Plating	Bondable gold
Packaging	Lots of 25

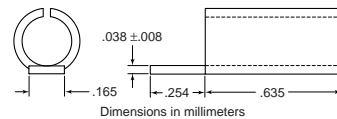

V110-1

Microstrip and Coplanar Waveguide when using the V110-1, use 01-308 Drill and Tap set to make the required concentric holes.

Launchers and cable connectors

Return loss (launchers only)	15 dB up to 65 GHz
Coupling nut tightening torque	1.36 N-m max
Material	Passivated stainless steel with heat-treated beryllium copper center conductors
Pin depth	0.000 to -0.130 mm for male and female connectors
Temperature range	-55°C to +125°C

V CONNECTOR®

DC to 65 GHz



V101M^{②④}
V Male In-Line Cable
Connector, DC-65 GHz
for V085 cable

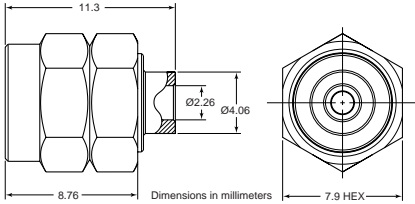

V101F^{③④}
V Female In-Line Cable
Connector, DC-65 GHz
for V085 cable

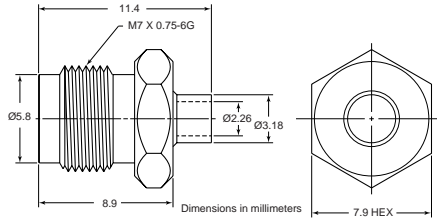

V102M^①
V Male Sparkplug
Launcher
Connector,
DC-65 GHz

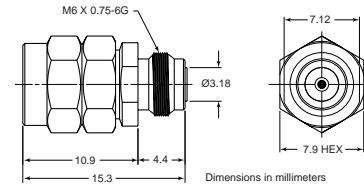

V102F^①
V Female Sparkplug
Launcher Connector,
DC-65 GHz

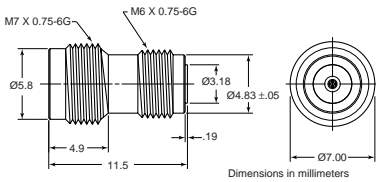

V103M
V Male Flange Launcher,
two-hole, DC-65 GHz

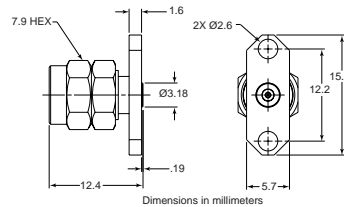

V103F
V Female Flange
Launcher, two-hole,
DC-65 GHz

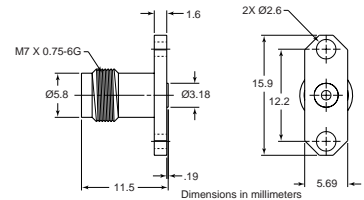

V103M-012
V Male Flange Launcher,
two-hole for 0.30 mm
glass bead pin,
DC-65 GHz

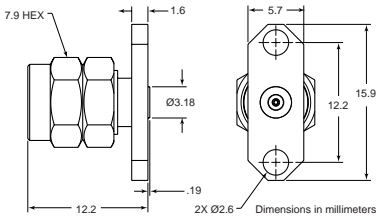

V103F-012
V Female Flange
Launcher, two-hole for
0.30 mm glass bead pin,
DC-65 GHz

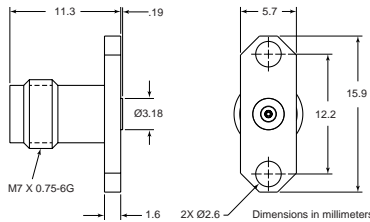

- ① Use with 01-105A Male and Female Sparkplug Torquing Kit
- ② Use with 01-307M Cable Sleeve Fixture
- ③ Use with 01-307F Cable Sleeve Fixture
- ④ Use with 01-309 Cable Assembling Fixture

V CONNECTOR®

DC to 65 GHz



V100^{①②}
Glass Beads for V102, and V103 connectors (package of 5)
Note: Glass Beads can be purchased through recommended vendors. For more information visit www.anritsu.com.



V100B^{①②}
High Hermeticity* Glass Beads for V102, and V103 connectors (package of 5)
Note: Glass Beads can be purchased through recommended vendors. For more information visit www.anritsu.com.

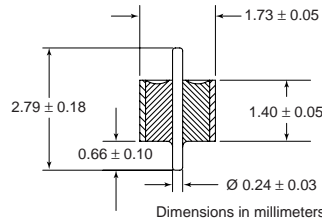
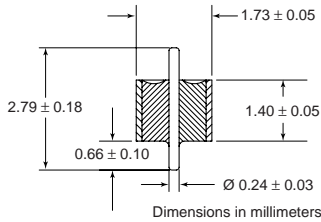

*Glass Bead Hermeticity Spec: Hermetic to 1×10^{-8} std cc He/sec at 1 atm differential

- ① Use with 01-303 or 01-306 Soldering Fixtures
- ② Use with 01-304 or 01-308 Drill and Tap Sets

Environmental information

Tests are performed per MIL-STD-202F.

Operating Temperature Range	-55°C to +125°
Temperature Shock	-55°C to +150°
Humidity	95% at 40°C, 96 hours, Test 103B, Condition B
Shock	100 G peak sawtooth, method 213, Test condition 1
Vibration	Sinewave: 10 Hz to 2000 Hz, 0.06" DA, method 204, test condition D Random: 50 Hz to 2000 Hz, 11.6 Grms, Power Spectral Density 0.1 Grms 2 Hz, Method 214, Test Condition 1, Letter D
Salt Spray	5% concentration for 48 hours, Method 101D, Condition B
Voltage withstanding	500 Vac RMS, 60 seconds, method 301

Ordering information

Please specify model/order number, name, and quantity when ordering.

Model/Order No.	Name
01-105A	Male and female sparkplug torquing kit
01-201	Torque wrench, for SMA, 3.5mm, and K Connector and V Connector
01-204	Anritsu stainless steel connector wrench
01-301	V Connector® (evaluation kit)
01-303	Soldering fixture for sparkplug launcher glass bead
01-304	Drill and tap set
01-306	Soldering fixture for flange launcher glass bead
01-307M	Cable sleeve soldering fixture, male connector
01-307F	Cable sleeve soldering fixture, female connector
01-308	Drill and tap set
01-309	Cable assembling fixture
V085	Coaxial cable, 152 cm (5 feet) length of 2.16 mm semi-rigid cable
V101M	V(m) in-line cable connector, DC to 65 GHz
V101F	V(f) in-line cable connector, DC to 65 GHz
V102M	V(m) sparkplug launcher connector, DC to 65 GHz
V102F	V(f) sparkplug launcher connector, DC to 65 GHz
V103M	V(m) flange launcher connector, DC to 65 GHz, 2 mounting holes
V103M-012	V(m) flange launcher, 2 mounting holes for 0.30 mm glass bead pin, DC to 65 GHz
V103F-012	V(f) flange launcher, 2 mounting holes for 0.30 mm glass bead pin, DC to 65 GHz
V103F	V(f) flange launcher connector, DC to 65 GHz, 2 mounting holes
V110-1	Microstrip stress relief contact

INTEGRATED V CONNECTORS

DC to 65 GHz



V115FMS10
Integrated V Female solder-in connector, with ground lip, DC to 65 GHz. Designed for Microstrip. For use with 0.25 mm (10 mil) substrates.



V115FCPW
Integrated V Female solder-in connector, with ground lip, DC to 65 GHz. Designed for Coplanar Waveguide.



V115FMS75
Integrated V Female solder-in connector, with ground lip, DC to 65 GHz. Designed for Microstrip. For use with 0.19 mm (7.5 mil) substrates.



V116F
Integrated V Female Sparkplug (screw-in) connector, DC to 65 GHz.

The Integrated V Connector® family is a group of female connectors which have the launcher and the glass bead integrated into one piece. All compensation steps for matching to Microstrip or Coplanar Waveguide (CPW) are included in the solder-in hermetic* connectors, ensuring that they deliver excellent performance. The integrated V connectors come in two easy-to-

install styles: the solder-in version, which is the V115F group, and the V116F screw-in version, which allows more versatility of microcircuit launch design. In addition, the V116F can be soldered in for hermeticity. These connectors, except for the CPW version, are designed to be used with the V110-1 Stress Relief Contacts. The Integrated V connectors are compatible with other V Connectors.

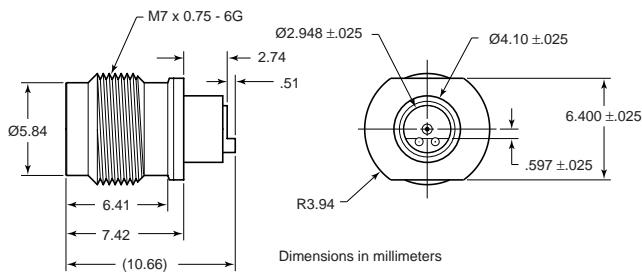

V115FMS10* outline

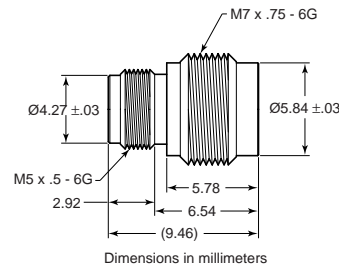

V116F* outline

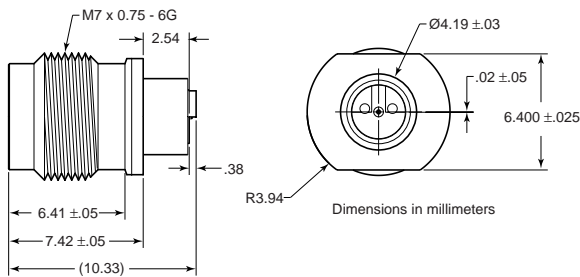

V115FCPW* outline

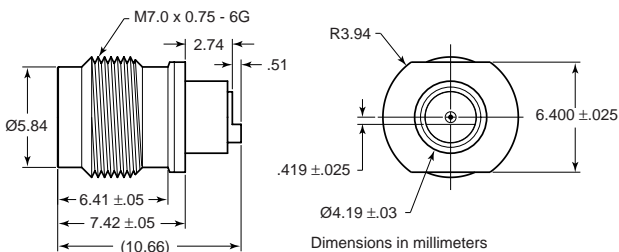

V115FMS75* outline

Environmental information

Tests are performed per MIL-STD-202F.

Operating Temperature Range	-55°C to +125°
Temperature Shock	-55°C to +150°
Humidity	95% at 40°C, 96 hours, Test 103B, Condition B
Shock	100 G peak sawtooth, method 213, Condition B, Test condition 1
Vibration	Sinewave: 10 Hz to 2000 Hz, 0.06" DA, method 204, test condition D Random: 50 Hz to 2000 Hz, 11.6 Grms, Power Spectral Density 0.1 Grms 2 Hz, Method 214, Test Condition 1, Letter D
Salt Spray	5% concentration for 48 hours, Method 101D, Condition B
Voltage withstanding	500 Vac RMS, 60 seconds, method 301

Ordering information

Please specify model/order number, name and quantity when ordering.

Model/Order No.	Name
V115FMS10	Integrated V(f) solder-in connector for use with 0.25 mm (10 mil) substrates
V115FMS75	Integrated V(f) solder-in connector for use with 0.19 mm (7.5 mil) substrates
V115FCPW	Integrated V(f) solder-in connector for Coplanar Waveguide
V116F	Integrated V(f) sparkplug connector

* Hermeticity specification: 1×10^{-8} std cc He/sec at 1 atm differential.

VP™ CONNECTOR

DC to 65 GHz



The VP Connector family, with shrouds and adapters, is well suited for applications in components, systems and instrumentation to 65 GHz. Anritsu's family of VP Connectors satisfies virtually every interface and provides excellent and reliable performance.

VP™ Connector features

- Superior RF Performance to 65 GHz
- Hermetic Connection
- Sliding Contact Connection to Microstrip
- Ground lip for handling substrates on carriers
- Testing capabilities using VP-VF Adapter
- Auto alignment capabilities on VP-VF Adapters

VP Bullet

The VP Bullet is a VP-VP adapter, designed to connect two modules with shrouds, back to back. The VP Bullet exhibits exceptional performance due to its unique design concept.

The VP Bullet is designed with six slots in the outer conductor and four slots in the center conductor. The increase in the number of slots in the outer conductor reduces the insertion and extraction force to less than one half of the force required for conventional SMP connectors and thus reduces wear and tear. In the lab VP Bullets have been tested to 1000 insertions with no degradation in performance. Anritsu guarantees at least 500 connections. In addition, the VP Bullet provides a positive stop so that fingers can not be damaged during insertion.

VP Shroud Design

Anritsu VP Shrouds are based on the design concept first used in Anritsu's Integrated V Connector®. VP Shrouds use the standard V Glass bead and the critical compensation steps required to install the glass bead in the housing are a part of the hermetic shroud design. Since Anritsu controls the critical internal dimensions, consistent performance is assured.

Additionally, the ground lip allows the substrate ground to be attached directly to the connector, eliminating the long ground path common to other connector families. This short ground path improves return loss performance, especially at the high end of the frequency range.

The VP Shrouds, except for the CPW version, are designed to be used with the Anritsu V110-1 Stress Relief Contact (sliding contact). The CPW Shrouds backside interface is a pin overlap design, so the center pin is directly connected to the transmission line and the substrate ground is directly attached to the ground lip.

Cable Connector

The VP Cable connector uses standard semi-rigid 2.16 mm cable just like the V cable Connectors. One can install a standard V Cable connector on the opposite end which makes the testing of modules much easier. The VP cable connector has a flange to ensure a rigid connection to the module. The cable connectors can also be utilized for connecting two modules back to back.

VP-VF Adapters

VP-VF Adapters are specifically designed for testing the modules using the Precision V Connector. The VP-VF Adapter can be replaced with a VP Bullet or VP Cable Connector.



01-501
Bullet Insertion and Removal Tool



01-502
Torque screwdriver adapter



VP100BCPW
Solder-in CPW hermetic shroud

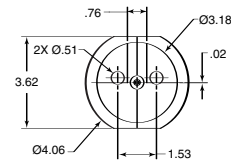
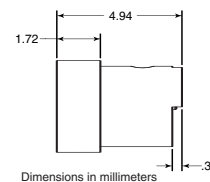

VP100B
Screw-in hermetic shroud

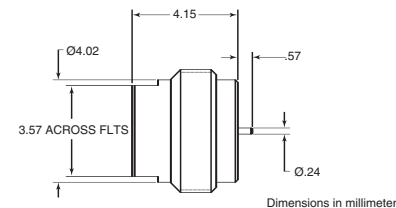

VP™ CONNECTOR

DC to 65 GHz



VP100BMS75
Solder-in
7.5 mil Microstrip
hermetic shroud

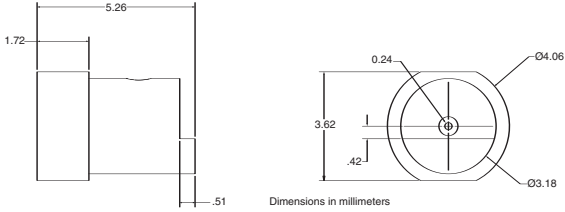

VP100BMS10
Solder-in
10 mil Microstrip
hermetic shroud

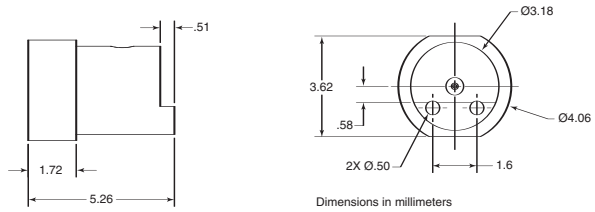

VP101F
VP cable adapter

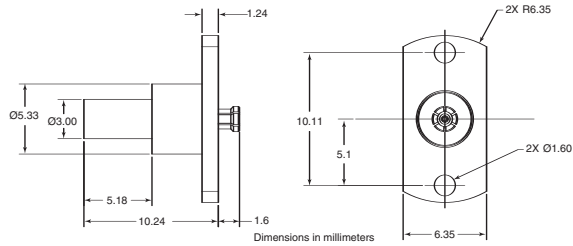

VP100BNL
No lip hermetic
shroud

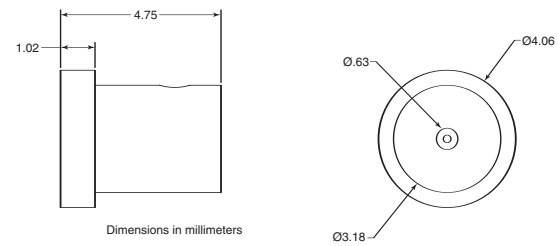

VP102F
VP Bullet

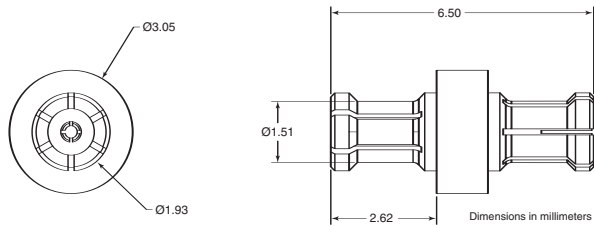

VP103F
VP-VF Adapter

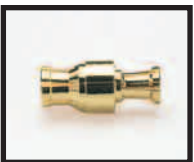
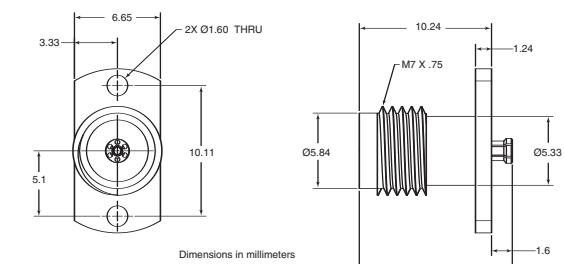

VP104F
VP to SMPM Bullet

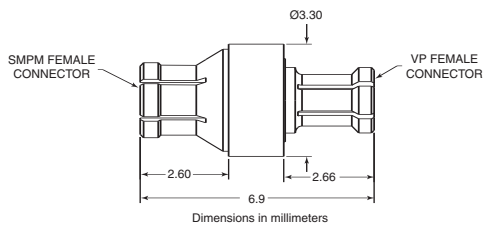

VP™ CONNECTOR

DC to 65 GHz

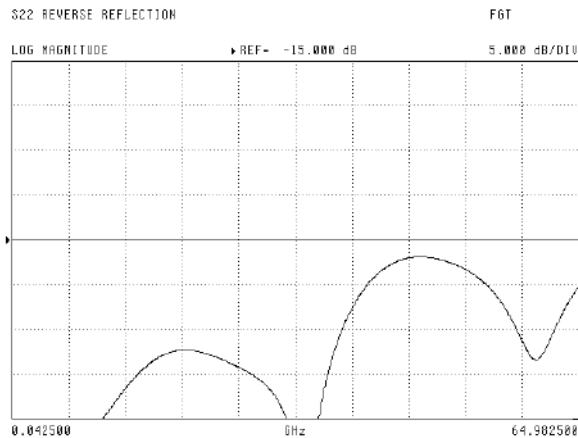

Typical High Frequency Return-Loss measured on VP102F over the range of 40 MHz to 65 GHz.

Specifications:

Impedance	50 Ω
Frequency	DC to 65 GHz
Insertion Loss	0.05 √ f (GHz)
VSWR: VP102F	1.43 typical
Insulation Resistance	> 1200 MΩ
Center conductor contact resistance	6 mΩ typical
Force to engage	4.2 N typical (1 lbf typical)
Force to disengage	7 N typical. (1.5 lbf typical)
Center contact Retention	83 N typical. (18 lbf typical)
Radial Misalignment	0.25 mm (0.010") for VP102F
Axial Misalignment	0-0.15 mm (0 to 0.006") for VP102F
Hermeticity	1 x10 ⁻⁸ std cc He/sec at 1 atmosphere differential for all shrouds

Ordering information

Please specify model/order number, name, and quantity when ordering.

Model/Order No.	Name
VP100BCPW	Solder-in CPW hermetic shroud
VP100BMS10	Solder-in 10 mil microstrip hermetic shroud
VP100BNL	No lip hermetic shroud
VP100B	Screw-in hermetic shroud
VP101F	VP cable adapter
VP102F	VP bullet
VP103F	VP-VF adapter
VP104F	VP to SMPM bullet
01-501	Bullet insertion and removal tool
01-502	V100B Torque tool adapter

Materials:

VP100B Shroud	Outer conductor: Brass, gold plated over nickel per Mil-G-45204C Bead body: Kovar, gold plated over nickel per Mil-G-45204C Center pin: Kovar, gold plated over nickel per Mil-G-45204C Bead dielectric: Corning 7070 glass
VP100BCPW, VP100BMS10, VP100BNL Shrouds	Outer conductor: Steel, gold plated over nickel per Mil-G-45204C Center pin: Kovar, gold plated over nickel per Mil-G-45204C Bead dielectric: Corning 7070 glass
VP101F VP Cable adapter	Beryllium-copper, gold plated over nickel per Mil-G-45204C
VP102F VP Bullet, VP104F VP to SMPM Bullet	Heat treated Beryllium-copper, gold plated over nickel per Mil-G-45204C Dielectric: Polyphenylene Oxide Noryl (PPO)
VP103F, VP-VF adapter	Body: Passivated stainless steel Bead: Polyphenylene Oxide Noryl (PPO) Center conductor: Beryllium-copper, gold plated over nickel per Mil-G-45204C

Environmental Information:

Tests are performed per MIL-STD-202F

Operating Temperature Range	-54° to +125°C
Temperature Shock	25° C to -55° C and 25° C to +200° C, method 107G, Condition B for shrouds to +125°C for bullet and cable adapter
Humidity	95% at 40°C, 96 hours, Test 103B, Condition B
Shock	100 G peak sawtooth, method 213, test condition 1
Vibration	Sinewave: 10 Hz to 2000 Hz, 0.06" DA, method 204, test condition D Random: 50 Hz to 2000 Hz, 11.6 Grms, Power Spectral Density 0.1 Grms ² /Hz, Method 214, Test Condition I, Letter D
Salt Spray	5% concentration for 48 hours, Method 101D, Condition B
Voltage withstanding	500 Vac RMS, 60 seconds, method 301

WI CONNECTOR®

DC to 110 GHz



The WI Connector® Family is a complete coaxial connector system with mode-free performance to 110 GHz. Based on the 1.00 mm coaxial connector front side interface as specified by IEEE Std 287, the WI Connector is well suited for high frequency applications ranging from components to systems and instrumentation.

WI Connector® features

- Excellent RF Performance to 110 GHz
- 50 Ω Impedance
- Low VSWR
- Standard 1 mm Interface
- Accurate Testing Capability
- Broadband Load for Instrument and Device Under Test

Connector Launchers

The WI Connector® launcher family includes both male and female WI Connectors. The WI Connector® has an air dielectric interface similar to K and V connectors. The center conductor is supported by Anritsu's proprietary low-loss high temperature support bead on one end and a glass bead (W1-102F and W1-102M) or a Teflon bead (W1-105F and W1-105M) on the other end. The use of the high

temperature support bead allows the connector to be subjected to temperature ranges up to 200°C for a short period. The center conductor extends outside of the connector and allows the user to make a direct pin overlap connection to the microwave circuit. The threads on the backside of the WI Connector® allow the user to install the WI Connector® by screwing it into the housing wall. Since Anritsu's proprietary low-loss high temperature plastic bead is used, the user can solder the connector which has the glass bead into the housing to achieve a hermetic connection.

Flange Mount Connector

W1 two-hole Flange Mount female Connector is also available. The center conductor of the connector is supported by a PPO® bead on the front-end and by a Teflon bead on the back end. The center conductor extends outside the connector, allowing for a direct pin overlap connection to the microwave circuit.

Cable Connector

Both the male and female cable connectors are available. Typical return loss at 110 GHz for finished cables exceeds 16 dB (1.35 SWR).

Tools



01-504, WI-6 mm
Torque Wrench



01-506, WI-7 mm
Torque Wrench



01-505, WI-6-7 mm
Open end Wrench

Connectors



W1-101M
W1 Male In-line Cable Connector, DC-110 GHz



W1-101F
W1 Female In-line Cable Connector, DC-110 GHz



W1-102M, W1-105M
W1 Male Sparkplug Connector, DC-110 GHz

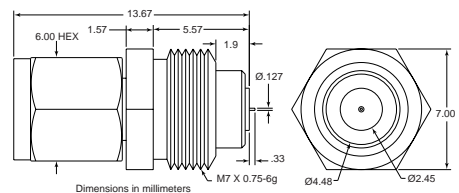
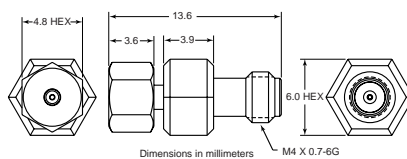
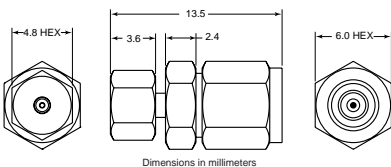

WI CONNECTOR®

DC to 110 GHz



W1-102F, W1-105F
W1 Female Sparkplug Connector, DC-110 GHz



W1-103F
W1 Female Flange Connector, DC-110 GHz



W047-2
Semi-rigid coaxial cable, 1.52 m length of 1.19 mm semi-rigid cable for W1-101 series connector

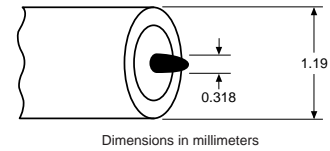
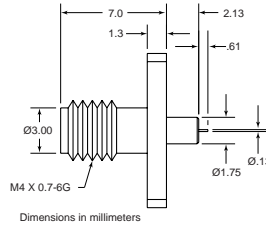
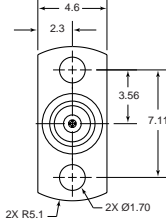
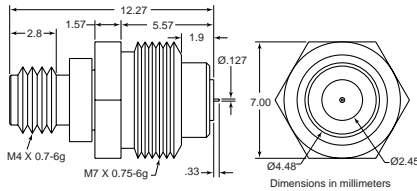

Specifications

Impedance	50 Ω
Frequency	DC to 110 GHz
Insertion Loss	0.70 dB typical
Return Loss	1.38 to 110 GHz typical 1.24 to 110 GHz typical (W1-101F, W1-101M)
Insulation Resistance	>1200 MΩ
Center Conductor Contact Resistance	6 mΩ typical
Maximum Power CW	6 W
Frontside Pin Depth	0 to 0.076 mm maximum
Backside Pin Protrusion	0.33 mm typical for W1-102F, W1-102M, W1-105F, W1-105M, 0.61 mm typical for W1-103F
Torque Coupling Nut	4 in-lb maximum
Torque W1 Connector Installation	5 in-lb maximum
Hermeticity (W1-102F, W1-102M)	1 x 10 ⁻⁸ std cc He/sec at atmosphere differential

Materials

W-101F W1-101M	Outer Conductor: Passivated Stainless Steel Center Conductor: Beryllium-copper, gold plated over nickel per Mil-G-45204C Coupling Nut: Passivated Stainless Steel Sleeve: Beryllium-copper, gold plated over nickel per Mil-G-45204C Lock Screw: Passivated Stainless Steel
W1-102F W1-102M	Outer Conductor: Beryllium-copper, gold plated over nickel per Mil-G-45204C Center Conductor: Beryllium-copper, gold plated over nickel per Mil-G-45204C Coupling Nut: Passivated Stainless Steel Glass Bead Center Pin: Kovar, gold plated over nickel per Mil-G-45204C Glass Bead Outer Conductor: Kovar, gold plated over nickel per Mil-G-45204C Glass Bead Dielectric: Corning 7070 Glass Plastic Bead Dielectric: Proprietary
W1-103F	Outer Conductor: Passivated stainless steel Center Conductor: Beryllium-copper, gold plated over nickel per Mil-G-45204C Coupling Nut: Passivated Stainless Steel Plastic Support Bead Dielectric: Polyphenylene Oxide Noryl
W1-105F W1-105M	Outer Conductor: Passivated stainless steel Center Conductor: Beryllium-copper, gold plated over nickel per Mil-G-45204C Coupling Nut: Passivated Stainless Steel Glass Bead Center Pin: Kovar, gold plated over nickel per Mil-G-45204C Glass Bead Outer Conductor: Kovar, gold plated over nickel per Mil-G-45204C Glass Bead Dielectric: Corning 7070 Glass Plastic Support Bead Dielectric: Proprietary

Environmental information

Tests are performed per MIL-STD-202F.

Operating Temperature Range	0° to +85°C
Storage Temperature Range	-54° to +125°C for W1-102F, W1-102M, W1-105F, W1-105M -54° to +85°C for W1-103F
Humidity	25° to -40° and 25° to 125°C, method 107G, condition B
Shock	100G peak sawtooth, method 213, test condition 1
Vibration	Sinewave: 10 Hz to 2000 Hz, 0.06" DA, method 204, test condition D Random: 50 Hz to 2000 Hz, 11.6 Grams, Power Spectral Density 0.1 Grams ² /Hz, Method 214, Test Condition 1, Letter D
Salt Spray	5% concentration for 48 hours, Method 101D, Condition B
Dielectric Withstanding Voltage	500 Vac RMS, 60 seconds, method 301

Ordering information

Please specify model/order number, name, and quantity when ordering.

Model/Order No.	Name
W1-101F	W1 Male In-line Cable Connector, DC-110 GHz
W1-101M	W1 Female In-line Cable Connector, DC-110 GHz
W1-102F	W1 Female Sparkplug Connector, Hermetic, DC-110 GHz
W1-102M	W1 Male Sparkplug Connector, Hermetic, DC-110 GHz
W1-103F	W1 Female Flange Connector, DC-110 GHz
W1-105F	W1 Female Sparkplug Connector, DC-110 GHz
W1-105M	W1 Male Sparkplug Connector, DC-110 GHz
W047-2	Semi-rigid Coaxial Cable
01-504	W1 6 mm Torque Wrench
01-505	W1 6-7mm Open end Wrench
01-506	W1 7 mm Torque Wrench

RF CABLES

K120, V120 DC to 65 GHz



Semi-rigid RF cable features

- Up to 65 GHz frequency ranges
- Type N, K Connector®, and V Connector®
- K Connector® compatibility with SMA and 3.5 mm
- V Connector® compatibility with 2.4 mm

Specifications

Model	Frequency range (GHz)	Impedance (Ω)	Length	Connectors
N120-6	DC to 18	50	15 cm	N(m) - N(m)
NS120MF-6	DC to 18	50	15 cm	N(m) - SMA(f)
K120MM	DC to 40	50	See table	K(m) - K(m)
K120MF	DC to 40	50	See table	K(m) - K(f)
K120FF	DC to 40	50	See table	K(f) - K(f)
V120MM	DC to 65	50	See table	V(m) - V(m)
V120MF	DC to 65	50	See table	V(m) - V(f)
V120FF	DC to 65	50	See table	V(f) - V(f)

Temperature range: -55°C to +125°C

Contact the Anritsu Company for low loss, low VSWR cable bending services.

Semi-rigid coaxial cable specifications for V Connectors®

Type	Semi-rigid coaxial, tin-plated copper outer conductor, silver-plated copper center conductor.
Impedance	50 ± 2 Ωs
Dielectric type	Microporous Teflon, 0.14 cm diameter
Dielectric constant	1.687
Relative velocity	0.77
Outside diameter	2.18 mm
Center conductor diameter	0.51 mm
Minimum bend radius	0.65 cm
Attenuation	2.3 dB/m at 10 GHz 3.6 dB/m at 20 GHz 4.3 dB/m at 30 GHz 5.2 dB/m at 40 GHz 7.2 dB/m at 60 GHz

Semi-rigid coaxial cable specifications for K Connectors®

Type	Semi-rigid coaxial, tin-plated copper outer conductor, silver-plated copper center conductor.
Impedance	50 ± 2 Ωs
Dielectric type	Microporous Teflon, 0.24 cm diameter
Dielectric constant	1.687
Relative velocity	0.77
Outside diameter	3.00 mm
Center conductor diameter	0.81 mm
Minimum bend radius	0.65 cm
Attenuation	1.6 dB/m at 10 GHz 2.3 dB/m at 20 GHz 3.3 dB/m at 30 GHz 4.7 dB/m at 40 GHz
K118 semirigid coaxial cable	1.52 m length of 3.00 mm Semirigid cable for K101 series connector

RF CABLES

K120, V120 DC to 65 GHz

Cable assembly part number reference

Length	Metric cable assemblies					
	K120MM	K120MF	K120FF	V120MM	V120MF	V120FF
5	K120MM-5CM	K120MF-5CM	K120FF-5CM	V120MM-5CM	V120MF-5CM	V120FF-5CM
10	K120MM-10CM	K120MF-10CM	K120FF-10CM	V120MM-10CM	V120MF-10CM	V120FF-10CM
15	K120MM-15CM	K120MF-15CM	K120FF-15CM	V120MM-15CM	V120MF-15CM	V120FF-15CM
20	K120MM-20CM	K120MF-20CM	K120FF-20CM	V120MM-20CM	V120MF-20CM	V120FF-20CM
25	K120MM-25CM	K120MF-25CM	K120FF-25CM	V120MM-25CM	V120MF-25CM	V120FF-25CM
30	K120MM-30CM	K120MF-30CM	K120FF-30CM	V120MM-30CM	V120MF-30CM	V120FF-30CM
35	K120MM-35CM	K120MF-35CM	K120FF-35CM	V120MM-35CM	V120MF-35CM	V120FF-35CM
40	K120MM-40CM	K120MF-40CM	K120FF-40CM	V120MM-40CM	V120MF-40CM	V120FF-40CM
45	K120MM-45CM	K120MF-45CM	K120FF-45CM	V120MM-45CM	V120MF-45CM	V120FF-45CM
50	K120MM-50CM	K120MF-50CM	K120FF-50CM	V120MM-50CM	V120MF-50CM	V120FF-50CM
60	K120MM-60CM	K120MF-60CM	K120FF-60CM	V120MM-60CM	V120MF-60CM	V120FF-60CM
70	K120MM-70CM	K120MF-70CM	K120FF-70CM	V120MM-70CM	V120MF-70CM	V120FF-70CM
80	K120MM-80CM	K120MF-80CM	K120FF-80CM	V120MM-80CM	V120MF-80CM	V120FF-80CM
90	K120MM-90CM	K120MF-90CM	K120FF-90CM	V120MM-90CM	V120MF-90CM	V120FF-90CM
100	K120MM-100CM	K120MF-100CM	K120FF-100CM	V120MM-100CM	V120MF-100CM	V120FF-100CM
125	K120MM-125CM	K120MF-125CM	K120FF-125CM	V120MM-125CM	V120MF-125CM	V120FF-125CM
150	K120MM-150CM	K120MF-150CM	K120FF-150CM	V120MM-150CM	V120MF-150CM	V120FF-150CM

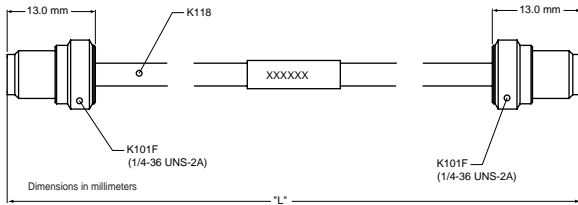

K120FF outline

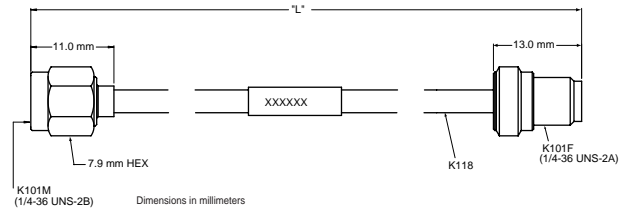

K120MF outline

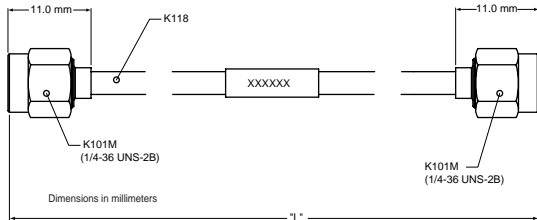

K120MM outline

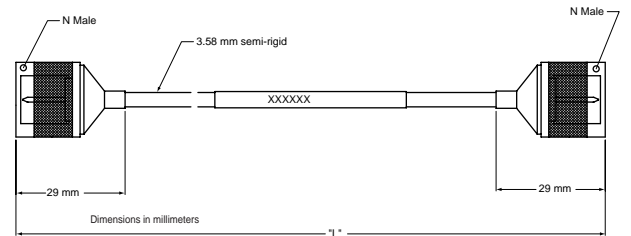

N120-6 outline

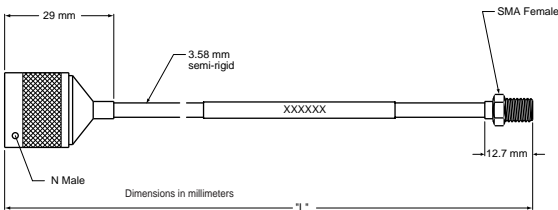

NS120MF-6 outline

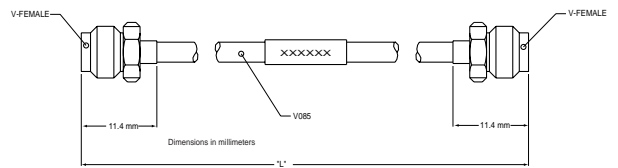

V120FF outline

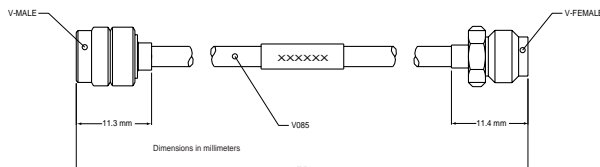

V120MF outline

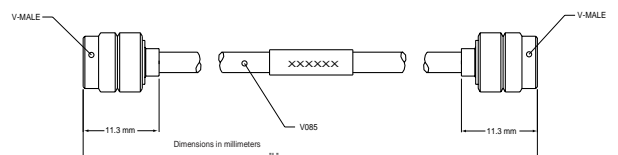

V120MM outline

For further information about these products and more, contact us at 1-800-Anritsu or visit www.us.anritsu.com

RF CABLES

K120, V120 DC to 65 GHz

Ordering information

Please specify model/order number, name and quantity when ordering.

Model/Order No.	Name
	Cable, semi-rigid
N120-6	001 to 18 GHz, 50 Ω, 15 cm, N(m) to N(m)
NS120MF-6	0.01 to 18 GHz, 50 Ω, 15 cm, N(m) to SMA(f)
K120MM-5CM	DC to 40 GHz, 50 Ω, 5 cm, K(m) to K(m)
K120MM-10CM	DC to 40 GHz, 50 Ω, 10 cm, K(m) to K(m)
K120MM-15CM	DC to 40 GHz, 50 Ω, 15 cm, K(m) to K(m)
K120MM-20CM	DC to 40 GHz, 50 Ω, 20 cm, K(m) to K(m)
K120MM-25CM	DC to 40 GHz, 50 Ω, 25 cm, K(m) to K(m)
K120MM-30CM	DC to 40 GHz, 50 Ω, 30 cm, K(m) to K(m)
K120MM-35CM	DC to 40 GHz, 50 Ω, 35 cm, K(m) to K(m)
K120MM-40CM	DC to 40 GHz, 50 Ω, 40 cm, K(m) to K(m)
K120MM-45CM	DC to 40 GHz, 50 Ω, 45 cm, K(m) to K(m)
K120MM-50CM	DC to 40 GHz, 50 Ω, 50 cm, K(m) to K(m)
K120MM-60CM	DC to 40 GHz, 50 Ω, 60 cm, K(m) to K(m)
K120MM-70CM	DC to 40 GHz, 50 Ω, 70 cm, K(m) to K(m)
K120MM-80CM	DC to 40 GHz, 50 Ω, 80 cm, K(m) to K(m)
K120MM-90CM	DC to 40 GHz, 50 Ω, 90 cm, K(m) to K(m)
K120MM-100CM	DC to 40 GHz, 50 Ω, 100 cm, K(m) to K(m)
K120MM-125CM	DC to 40 GHz, 50 Ω, 125 cm, K(m) to K(m)
K120MM-150CM	DC to 40 GHz, 50 Ω, 150 cm, K(m) to K(m)
K120MF-5CM	DC to 40 GHz, 50 Ω, 5 cm, K(m) to K(f)
K120MF-10CM	DC to 40 GHz, 50 Ω, 10 cm, K(m) to K(f)
K120MF-15CM	DC to 40 GHz, 50 Ω, 15 cm, K(m) to K(f)
K120MF-20CM	DC to 40 GHz, 50 Ω, 20 cm, K(m) to K(f)
K120MF-25CM	DC to 40 GHz, 50 Ω, 25 cm, K(m) to K(f)
K120MF-30CM	DC to 40 GHz, 50 Ω, 30 cm, K(m) to K(f)
K120MF-35CM	DC to 40 GHz, 50 Ω, 35 cm, K(m) to K(f)
K120MF-40CM	DC to 40 GHz, 50 Ω, 40 cm, K(m) to K(f)
K120MF-45CM	DC to 40 GHz, 50 Ω, 45 cm, K(m) to K(f)
K120MF-50CM	DC to 40 GHz, 50 Ω, 50 cm, K(m) to K(f)
K120MF-60CM	DC to 40 GHz, 50 Ω, 60 cm, K(m) to K(f)
K120MF-70CM	DC to 40 GHz, 50 Ω, 70 cm, K(m) to K(f)
K120MF-80CM	DC to 40 GHz, 50 Ω, 80 cm, K(m) to K(f)
K120MF-90CM	DC to 40 GHz, 50 Ω, 90 cm, K(m) to K(f)
K120MF-100CM	DC to 40 GHz, 50 Ω, 100 cm, K(m) to K(f)
K120MF-125CM	DC to 40 GHz, 50 Ω, 125 cm, K(m) to K(f)
K120MF-150CM	DC to 40 GHz, 50 Ω, 150 cm, K(m) to K(f)
K120FF-5CM	DC to 40 GHz, 50 Ω, 5 cm, K(f) to K(f)
K120FF-10CM	DC to 40 GHz, 50 Ω, 10 cm, K(f) to K(f)
K120FF-15CM	DC to 40 GHz, 50 Ω, 15 cm, K(f) to K(f)
K120FF-20CM	DC to 40 GHz, 50 Ω, 20 cm, K(f) to K(f)
K120FF-25CM	DC to 40 GHz, 50 Ω, 25 cm, K(f) to K(f)
K120FF-30CM	DC to 40 GHz, 50 Ω, 30 cm, K(f) to K(f)
K120FF-35CM	DC to 40 GHz, 50 Ω, 35 cm, K(f) to K(f)
K120FF-40CM	DC to 40 GHz, 50 Ω, 40 cm, K(f) to K(f)
K120FF-45CM	DC to 40 GHz, 50 Ω, 45 cm, K(f) to K(f)
K120FF-50CM	DC to 40 GHz, 50 Ω, 50 cm, K(f) to K(f)
K120FF-60CM	DC to 40 GHz, 50 Ω, 60 cm, K(f) to K(f)
K120FF-70CM	DC to 40 GHz, 50 Ω, 70 cm, K(f) to K(f)
K120FF-80CM	DC to 40 GHz, 50 Ω, 80 cm, K(f) to K(f)
K120FF-90CM	DC to 40 GHz, 50 Ω, 90 cm, K(f) to K(f)
K120FF-100CM	DC to 40 GHz, 50 Ω, 100 cm, K(f) to K(f)
K120FF-125CM	DC to 40 GHz, 50 Ω, 125 cm, K(f) to K(f)
K120FF-150CM	DC to 40 GHz, 50 Ω, 150 cm, K(f) to K(f)

Model/Order No.	Name
	Cable, semi-rigid
V120MM-5CM	DC to 65 GHz, 50 Ω, 5 cm, V(m) to V(m)
V120MM-10CM	DC to 65 GHz, 50 Ω, 10 cm, V(m) to V(m)
V120MM-15CM	DC to 65 GHz, 50 Ω, 15 cm, V(m) to V(m)
V120MM-20CM	DC to 65 GHz, 50 Ω, 20 cm, V(m) to V(m)
V120MM-25CM	DC to 65 GHz, 50 Ω, 25 cm, V(m) to V(m)
V120MM-30CM	DC to 65 GHz, 50 Ω, 30 cm, V(m) to V(m)
V120MM-35CM	DC to 65 GHz, 50 Ω, 35 cm, V(m) to V(m)
V120MM-40CM	DC to 65 GHz, 50 Ω, 40 cm, V(m) to V(m)
V120MM-45CM	DC to 65 GHz, 50 Ω, 45 cm, V(m) to V(m)
V120MM-50CM	DC to 65 GHz, 50 Ω, 50 cm, V(m) to V(m)
V120MM-60CM	DC to 65 GHz, 50 Ω, 60 cm, V(m) to V(m)
V120MM-70CM	DC to 65 GHz, 50 Ω, 70 cm, V(m) to V(m)
V120MM-80CM	DC to 65 GHz, 50 Ω, 80 cm, V(m) to V(m)
V120MM-90CM	DC to 65 GHz, 50 Ω, 90 cm, V(m) to V(m)
V120MM-100CM	DC to 65 GHz, 50 Ω, 100 cm, V(m) to V(m)
V120MM-125CM	DC to 65 GHz, 50 Ω, 125 cm, V(m) to V(m)
V120MM-150CM	DC to 65 GHz, 50 Ω, 150 cm, V(m) to V(m)
V120MF-5CM	DC to 65 GHz, 50 Ω, 5 cm, V(m) to V(f)
V120MF-10CM	DC to 65 GHz, 50 Ω, 10 cm, V(m) to V(f)
V120MF-15CM	DC to 65 GHz, 50 Ω, 15 cm, V(m) to V(f)
V120MF-20CM	DC to 65 GHz, 50 Ω, 20 cm, V(m) to V(f)
V120MF-25CM	DC to 65 GHz, 50 Ω, 25 cm, V(m) to V(f)
V120MF-30CM	DC to 65 GHz, 50 Ω, 30 cm, V(m) to V(f)
V120MF-35CM	DC to 65 GHz, 50 Ω, 35 cm, V(m) to V(f)
V120MF-40CM	DC to 65 GHz, 50 Ω, 40 cm, V(m) to V(f)
V120MF-45CM	DC to 65 GHz, 50 Ω, 45 cm, V(m) to V(f)
V120MF-50CM	DC to 65 GHz, 50 Ω, 50 cm, V(m) to V(f)
V120MF-60CM	DC to 65 GHz, 50 Ω, 60 cm, V(m) to V(f)
V120MF-70CM	DC to 65 GHz, 50 Ω, 70 cm, V(m) to V(f)
V120MF-80CM	DC to 65 GHz, 50 Ω, 80 cm, V(m) to V(f)
V120MF-90CM	DC to 65 GHz, 50 Ω, 90 cm, V(m) to V(f)
V120MF-100CM	DC to 65 GHz, 50 Ω, 100 cm, V(m) to V(f)
V120MF-125CM	DC to 65 GHz, 50 Ω, 125 cm, V(m) to V(f)
V120MF-150CM	DC to 65 GHz, 50 Ω, 150 cm, V(m) to V(f)
V120FF-5CM	DC to 65 GHz, 50 Ω, 5 cm, V(f) to V(f)
V120FF-10CM	DC to 65 GHz, 50 Ω, 10 cm, V(f) to V(f)
V120FF-15CM	DC to 65 GHz, 50 Ω, 15 cm, V(f) to V(f)
V120FF-20CM	DC to 65 GHz, 50 Ω, 20 cm, V(f) to V(f)
V120FF-25CM	DC to 65 GHz, 50 Ω, 25 cm, V(f) to V(f)
V120FF-30CM	DC to 65 GHz, 50 Ω, 30 cm, V(f) to V(f)
V120FF-35CM	DC to 65 GHz, 50 Ω, 35 cm, V(f) to V(f)
V120FF-40CM	DC to 65 GHz, 50 Ω, 40 cm, V(f) to V(f)
V120FF-45CM	DC to 65 GHz, 50 Ω, 45 cm, V(f) to V(f)
V120FF-50CM	DC to 65 GHz, 50 Ω, 50 cm, V(f) to V(f)
V120FF-60CM	DC to 65 GHz, 50 Ω, 60 cm, V(f) to V(f)
V120FF-70CM	DC to 65 GHz, 50 Ω, 70 cm, V(f) to V(f)
V120FF-80CM	DC to 65 GHz, 50 Ω, 80 cm, V(f) to V(f)
V120FF-90CM	DC to 65 GHz, 50 Ω, 90 cm, V(f) to V(f)
V120FF-100CM	DC to 65 GHz, 50 Ω, 100 cm, V(f) to V(f)
V120FF-125CM	DC to 65 GHz, 50 Ω, 125 cm, V(f) to V(f)
V120FF-150CM	DC to 65 GHz, 50 Ω, 150 cm, V(f) to V(f)

ARMORED SEMI-RIGID TEST PORT CABLES

3670 Series DC to 65 GHz



The 3670 series cables are laboratory quality cables that contain General Precision Connectors. These cables are used to connect VNA Test Sets to the device under test (DUT). They are also used to connect to a 3680 Universal Test Fixture or other test interface devices.

Features:

- Up to 65 GHz frequency range
- Type GPC-7, N, K Connector®, and V Connector® Precision Connectors
- Excellent return loss performance to 65 GHz

Specifications

Model	Frequency Range (GHz)	Impedance	Connector Types	Length (Feet)	Return Loss
3670A50-1	DC to 18	50	GPC-7	1	17 dB
3670A50-2	DC to 18	50	GPC-7	2	
3670N50-1	DC to 18	50	N(m)-N(f)	1	17 dB
3670N50-2	DC to 18	50	N(m)-N(f)	2	
3670NN50-1	DC to 18	50	N(m)-N(m)	1	17 dB
3670NN50-2	DC to 18	50	N(m)-N(m)	2	
3670K50-1	DC to 40	50	K(m)-K(f)	1	16 dB
3670K50-2	DC to 40	50	K(m)-K(f)	2	
3670KF50-1	DC to 40	50	K(f)-K(f)	1	16 dB
3670KF50-2	DC to 40	50	K(f)-K(f)	2	
3670V50-1	DC to 65	50	V(m)-V(f)	1	16 dB
3670V50-2	DC to 65	50	V(m)-V(f)	2	

Ordering information

Please specify model/order number, name, and quantity when ordering.

Model/Order No.	Name
3670A50-1	GPC-7, 1 Foot
3670A50-2	GPC-7, 2 Foot
3670N50-1	N(m) - N(f), 1 Foot
3670N50-2	N(m) - N(f), 2 Foot
3670NN50-1	N(m)-N(m), 1 Foot
3670NN50-2	N(m)-N(m), 2 Foot
3670K50-1	K(m)-K(f), 1 Foot
3670K50-2	K(m)-K(f), 2 Foot
3670KF50-1	K(f) - K (f) Cable, 1 Foot
3670KF50-2	K(f) - K (f) Cable, 2 Foot
3670V50-1	V(m)-V(f), 1 Foot
3670V50-2	V(m)-V(f), 2 Foot

COAXIAL ADAPTERS

K, V, K to V DC to 65 GHz



The K220 and 34V Series of precision adapters enable accurate measurements with K or V connectors. Every adapter is fully specified and 100% tested to ensure low reflections and optimum performance over the DC to 65 GHz range.

Precision K and V adapter features

- K Connector® DC to 40 GHz frequency range
- V Connector® DC to 65 GHz frequency range
- Low SWR and insertion loss

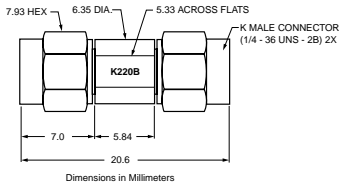

K220B outline

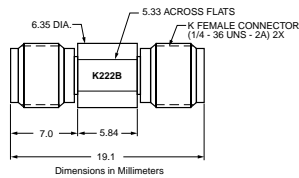

K222B outline

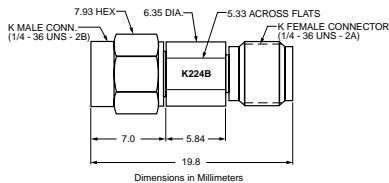

K224B outline

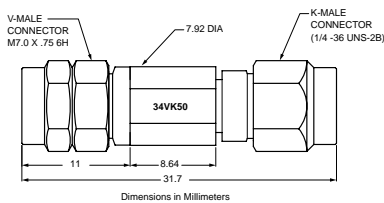

34VK50 outline

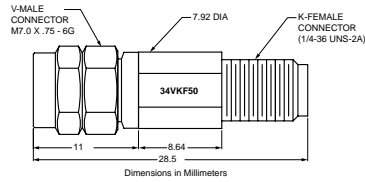

34VKF50 outline

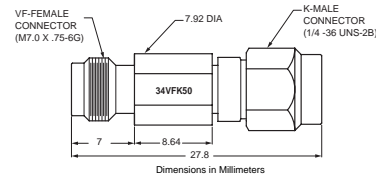

34VFK50 outline

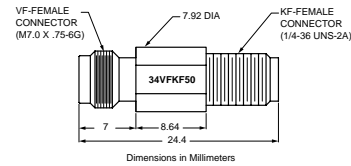

34VFKF50 outline

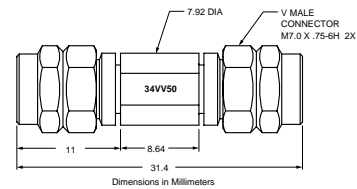

34VV50 outline

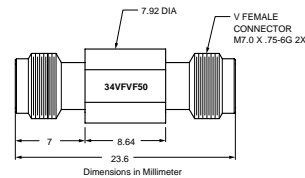

34VVF50 outline

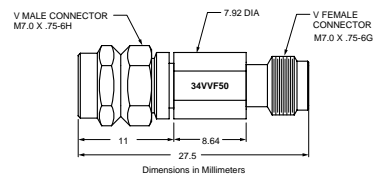

34VVF50 outline

Specifications

Model	Frequency range (GHz)	Connectors	SWR
K220B K222B K224B	DC to 40	K(m) to K(m) K(f) to K(f) K(f) to K(m)	1.12
34VK50 34VKF50	DC to 40	V(m) to K(m) V(m) to K(f)	1.3
34VFK50 34VFKF50	DC to 40	V(f) to K(m) V(f) to K(f)	1.3
34VV50 34VVF50 34VVF50	DC to 65	V(m) to V(m) V(f) to V(f) V(m) to V(f)	1.5

Temperature range: -55°C to +125°C

COAXIAL ADAPTERS

K, V, K to V DC to 65 GHz

The K230 Series is the panel-mount version of the K220 Series Adapters. These units mount in a standard 9.5 mm “D” hole.

K and V panel adapter features

- Precision, panel-mounted feedthru adapter
- Broad, DC to 65 GHz frequency range

K panel adapter specifications

Model	Frequency range (GHz)	Connectors	SWR
K230B	DC to 40	K(m) to K(m)	1.12
K232B		K(f) to K(f)	
K234B		K(f) to K(m)	

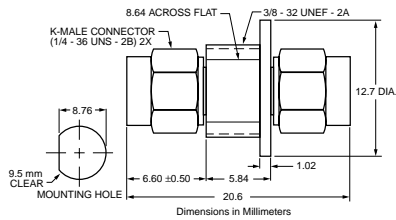

K230B outline

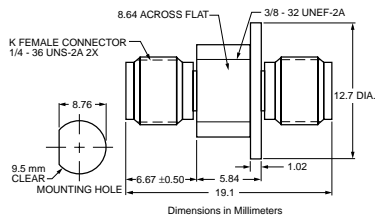

K232B outline

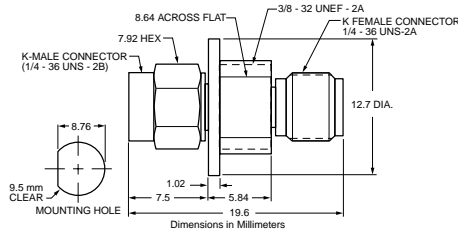

K234B outline

V panel adapter specifications

Model	Frequency range (GHz)	Connectors	SWR
V230	DC to 65	V(m) to V(m)	1.5
V232		V(f) to V(f)	
V234		V(f) to V(m)	

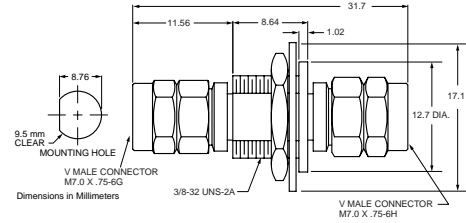

V230 outline

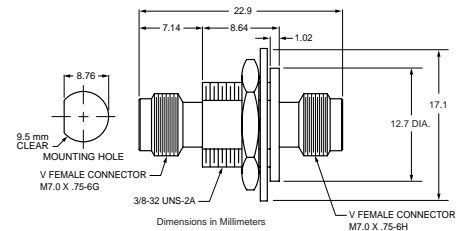

V232 outline

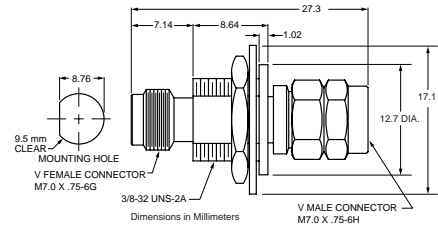

V234 outline

Ordering information

Please specify model/order number, name and quantity when ordering.

Model/Order No.	Name
	Precision adapter
K220B	DC to 40 GHz, 50 Ω, K(m)-K(m)
K222B	DC to 40 GHz, 50 Ω, K(f)-K(f)
K224B	DC to 40 GHz, 50 Ω, K(m)-K(f)
K230B	DC to 40 GHz, 50 Ω, K(m)-K(m)
K232B	DC to 40 GHz, 50 Ω, K(f)-K(f)
K234B	DC to 40 GHz, 50 Ω, K(f)-K(m)
34VKF50	DC to 46.5 GHz, 50 Ω, V(m)-K(m)
34VKF50	DC to 40 GHz, 50 Ω, V(m)-K(f)
34VFK50	DC to 40 GHz, 50 Ω, V(f)-K(m)
34VFK50	DC to 40 GHz, 50 Ω, V(f)-K(f)
34VV50	DC to 65 GHz, 50 Ω, V(m)-V(m)
34VVF50	DC to 65 GHz, 50 Ω, V(m)-V(f)
34VVF50	DC to 65 GHz, 50 Ω, V(f)-V(f)
V230	DC to 65 GHz, 50 Ω, V(m)-V(m)
V232	DC to 65 GHz, 50 Ω, V(f)-V(f)
V234	DC to 65 GHz, 50 Ω, V(f)-V(m)

CALIBRATION GRADE ADAPTERS

33 Series DC to 110 GHz



The 33 Series of precision adapters enable accurate measurements with Anritsu V Connector®, K Connector®, W1 Connector®, WSMA, and Type N interfaces. Every adapter is fully specified and 100% tested to ensure low reflections and optimum phase performance over a broad frequency range.

Features

- Low SWR and insertion loss
- DC to 110 GHz, with W1 Connector® interface
- DC to 65 GHz, with V Connector® interface
- DC to 40 GHz, with K Connector® interface
- 50 Ω impedance

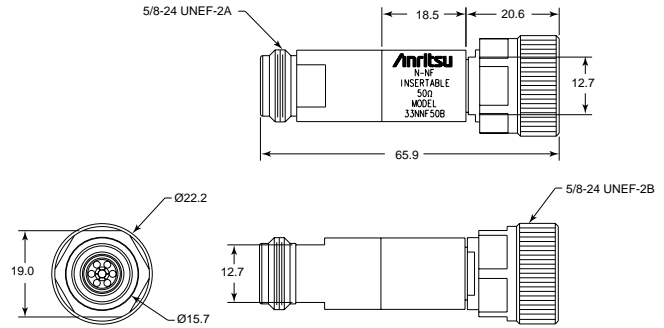

33NNF50B outline

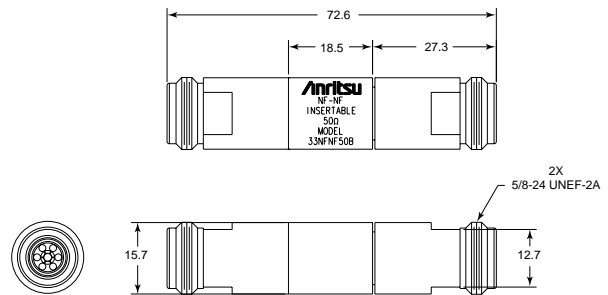

33NFF50B outline

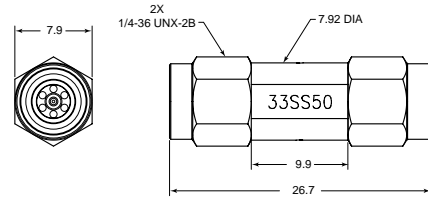

33SS50 outline

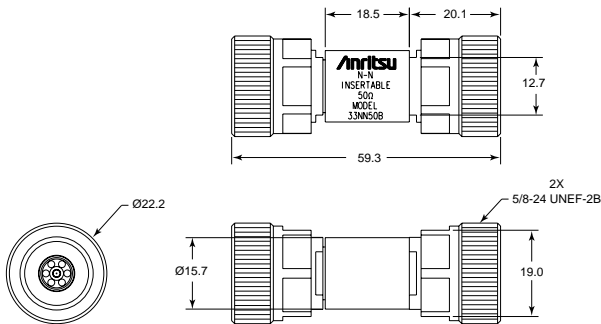

33NN50B outline

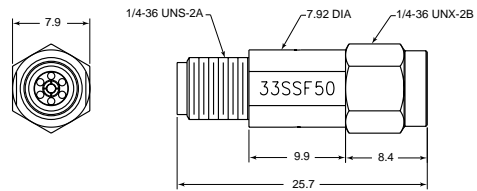

33SSF50 outline

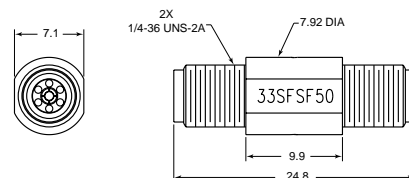

33SFSF50 outline

CALIBRATION GRADE ADAPTERS

33 Series DC to 110 GHz

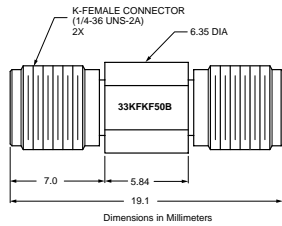

33KFKF50B outline

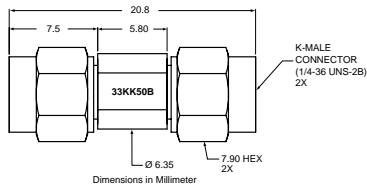

33KK50B outline

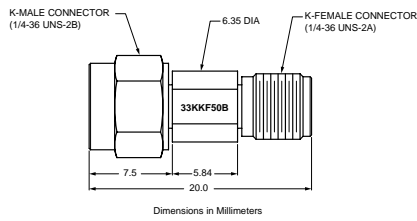

33KKF50B outline

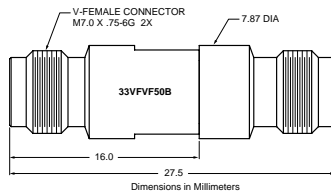

33VVF50B outline

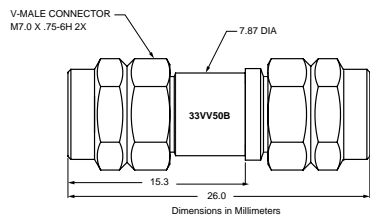

33VV50B outline

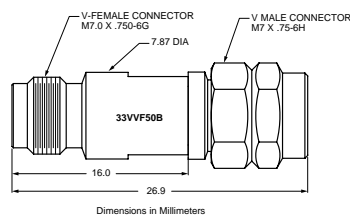

33VVF50B outline



33WW50
Precision W1 Male to W1 Male Adapter,
DC to 110 GHz

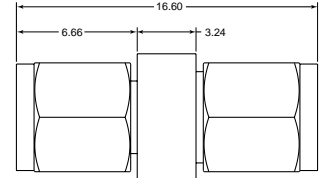
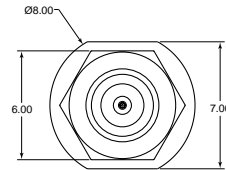

33WWF50
Precision W1 Male to W1 Female Adapter,
DC to 110 GHz

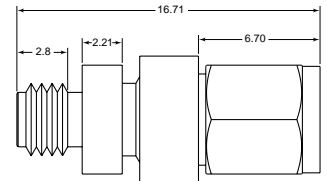
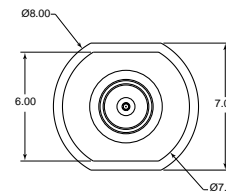

33WFWF50
Precision W1 Female to W1 Female Adapter,
DC to 110 GHz

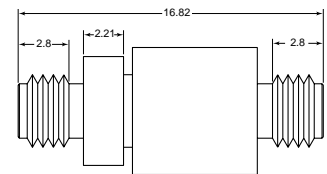
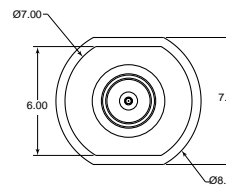

CALIBRATION GRADE ADAPTERS

33 Series DC to 110 GHz

Specifications

Model	Frequency range (GHz)	Impedance (Ω)	Connectors	SWR
33NN50B	DC to 18	50	N(m)-N(m)	1.09
33NMF50B	DC to 18	50	N(m)-N(f)	1.09
33NFN50B	DC to 18	50	N(f)-N(f)	1.09
33SS50	DC to 26.5	50	WSMA(m)-WSMA(m)	1.08 to 18 GHz 1.12 to 26.5 GHz
33SSF50	DC to 26.5	50	WSMA(m)-WSMA(f)	1.08 to 18 GHz 1.12 to 26.5 GHz
33SFF50	DC to 26.5	50	WSMA(f)-WSMA(f)	1.08 to 18 GHz 1.12 to 26.5 GHz
33KK50B	DC to 40	50	K(m)-K(m)	1.1
33KMF50B	DC to 40	50	K(m)-K(f)	1.1
33KFF50B	DC to 40	50	K(f)-K(f)	1.1
33VV50B	DC to 65	50	V(m)-V(m)	1.22
33VVF50B	DC to 65	50	V(m)-V(f)	1.33
33VFF50B	DC to 65	50	V(f)-V(f)	1.33
33WW50	DC to 110	50	W1(m)-W1(m)	1.17 to 40 GHz 1.29 to 65 GHz 1.38 to 110 GHz
33WWF50	DC to 110	50	W1(m)-W1(f)	1.17 to 40 GHz 1.29 to 65 GHz 1.38 to 110 GHz
33WFF50	DC to 110	50	W1(f)-W1(f)	1.17 to 40 GHz 1.29 to 65 GHz 1.38 to 110 GHz

Temperature range: -55°C to $+125^{\circ}\text{C}$

Ordering information

Please specify model/order number, name and quantity when ordering.

Model/Order No.	Name
	Calibration grade adapter
33NN50B	DC to 18 GHz, 50 Ω , N(m)-N(m)
33NMF50B	DC to 18 GHz, 50 Ω , N(m)-N(f)
33NFN50B	DC to 18 GHz, 50 Ω , N(f)-N(f)
33SS50	DC to 26.5 GHz, 50 Ω , WSMA(m)-WSMA(m)
33SSF50	DC to 26.5 GHz, 50 Ω , WSMA(m)-WSMA(f)
33SFF50	DC to 26.5 GHz, 50 Ω , WSMA(f)-WSMA(f)
33KFF50B	DC to 40 GHz, 50 Ω , K(f)-K(f)
33KK50B	DC to 40 GHz, 50 Ω , K(m)-K(m)
33KMF50B	DC to 40 GHz, 50 Ω , K(m)-K(f)
33VVF50B	DC to 65 GHz, 50 Ω , V(f)-V(f)
33VV50B	DC to 65 GHz, 50 Ω , V(m)-V(m)
33VVF50B	DC to 65 GHz, 50 Ω , V(m)-V(f)
33WW50	DC to 110 GHz, 50 Ω , W1(m)-W1(m)
33WWF50	DC to 110 GHz, 50 Ω , W1(m)-W1(f)
33WFF50	DC to 110 GHz, 50 Ω , W1(f)-W1(f)

INSTRUMENTATION GRADE ADAPTERS

34 Series DC to 60 GHz



34ASF50



34NN50A



34RKRK50



34RSN50

The 34 Series of precision adapters enable accurate measurements with GPC-7, Type N, or WSMA interfaces. Every adapter is fully specified and 100% tested to ensure low reflections and optimum phase performance over a broad frequency range.

Precision adapter features

- Low SWR and insertion loss
- GPC-7, Type N, and WSMA connectors
- Convenient transition with minimal effect on signal
- 50 Ω or 75 Ω impedance

Specifications

Model	Frequency range (GHz)	Impedance (Ω)	Connectors	SWR	Dimensions L(cm) x dia(cm)
34NN75B 34NFN75B	DC to 3	75	N(m) to N(m) N(f) to N(f)	1.1	6.0 x 2.2 4.7 x 1.6
34AN50 34ANF50	DC to 18	50	GPC-7 to N(m) GPC-7 to N(f)	1.02	4.2 x 2.2 4.2 x 2.2
34AS50 34ASF50	DC to 18	50	GPC-7 to WSMA(m) GPC-7 to WSMA(f)	1.033	3.8 x 2.2 3.8 x 2.2
34NN50A 34NFN50	DC to 18	50	N(m) to N(m) N(f) to N(f)	1.1	6.0 x 2.2 4.7 x 1.6
34NK50 34NKF50 34NFK50 34NFKF50	DC to 18	50	N(m) to K(m) N(m) to K(f) N(f) to K(m) N(f) to K(f)	1.12	3.8 x 2.2 3.8 x 2.2 3.8 x 1.6 3.8 x 1.6
34SFSF50	DC to 26.5	50	WSMA(f) to WSMA(f)	1.11 to 18.5 GHz 1.18 to 26.5 GHz	1.6 x 0.8

Specifications

Model	Frequency range (GHz)	Connectors	SWR	Dimensions L(cm) x dia(cm)
34RSN50	DC to 18	RS(m) to N(m)	1.40	5.1 x 2.2
34RKNF50	DC to 18	RK(m) to N(f)	1.40	5.1 x 1.7
34RVNF50	DC to 18	RV(m) to N(f)	1.40	5.1 x 1.7
34RKRK50	DC to 40	RK(m) to RK(m)	2.00	5.8 x 1.7
34RVRK50	DC to 40	RV(m) to RK(m)	2.00	5.8 x 1.7
34RVRV50	DC to 60	RV(m) to RV(m)	2.30	5.8 x 1.7

Impedance: 50 Ω

Temperature range: 0°C to +75°C

The 34R Series precision adapters provide a rugged, rigid connection between Anritsu instruments with WSMA, K Connector®, or V Connector® outputs and Anritsu SWR Autotesters and SWR Bridges or other instruments.

The adapters have an outside diameter equal to that of a Type N connector, adding mechanical strength to the test setup and making installation convenient and fast.

Ruggedized adapter features

- Enhance reliability of microwave test setup
- Easy-to-grasp Type N outside diameter
- Rigid test connections for improved test data repeatability

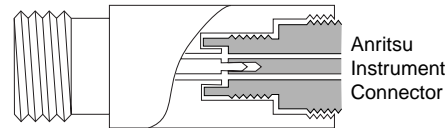

34R Series Adapter

Ordering information

Please specify model/order number, name, and quantity when ordering.

Model/Order No.	Name
	Precision adapter
34NN75B	DC to 3 GHz, 75 Ω, N(m)-N(m)
34NFN75B	DC to 3 GHz, 75 Ω, N(f)-N(f)
34AN50	DC to 18 GHz, 50 Ω, GPC-7-N(m)
34ANF50	DC to 18 GHz, 50 Ω, GPC-7-N(f)
34AS50	DC to 18 GHz, 50 Ω, GPC-7-WSMA(m)
34ASF50	DC to 18 GHz, 50 Ω, GPC-7-WSMA(f)
34NN50A	DC to 18 GHz, 50 Ω, N(m)-N(m)
34NFN50	DC to 18 GHz, 50 Ω, N(f)-N(f)
34NK50	DC to 18 GHz, 50 Ω, N(m)-K(m)
34NKF50	DC to 18 GHz, 50 Ω, N(m)-K(f)
34NFK50	DC to 18 GHz, 50 Ω, N(f)-K(m)
34NFKF50	DC to 18 GHz, 50 Ω, N(f)-K(f)
34SFSF50	DC to 26.5 GHz, 50 Ω, WSMA(f)-WSMA(f)
34RSN50	DC to 18 GHz, 50 Ω, RS(m) to N(m)
34RKNF50	DC to 18 GHz, 50 Ω, RK(m) to N(f)
34RVNF50	DC to 18 GHz, 50 Ω, RV(m) to N(f)
34RKRK50	DC to 40 GHz, 50 Ω, RK(m) to RK(m)
34RVRK50	DC to 40 GHz, 50 Ω, RV(m) to RK(m)
34RVRV50	DC to 60 GHz, 50 Ω, RV(m) to RV(m)

INSTRUMENTATION GRADE ADAPTERS

34 Series W to V DC to 65 GHz

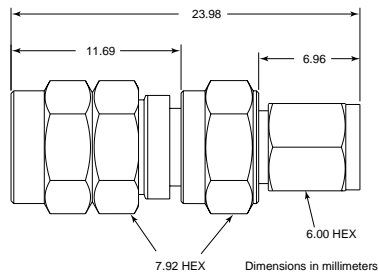

34WV50 outline

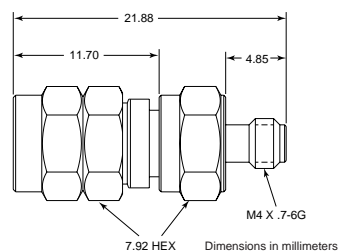

34WV50 outline

These 34 Series of precision adapter enable accurate measurement with W1 Connector® and V Connector® interfaces.

Precision adapter features

- Low SWR and insertion loss
- W1 and V Connectors®
- 50 Ω Impedance

Specifications

Model	Frequency Range (GHz)	Impedance	Connectors	Insertion Loss	SWR
34WV50	DC to 65 GHz	50	W1(m) to V(m)	0.5 dB	1.22
34WV50	DC to 65 GHz	50	W1(f) to V(m)	0.5 dB	1.22
34WV50	DC to 65 GHz	50	W1(m) to V(f)	0.5 dB	1.22
34WV50	DC to 65 GHz	50	W1(f) to V(f)	0.5 dB	1.22

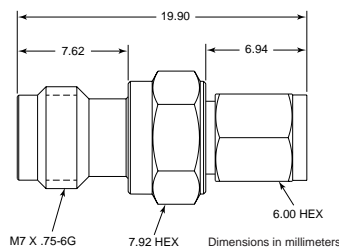

34WV50 outline

Ordering information

Please specify model/order number, name, and quantity when ordering.

Model/Order No.	Name
	Precision adapter
34WV50	DC to 65 GHz, 50 Ω, W1(m) to V(m)
34WV50	DC to 65 GHz, 50 Ω, W1(f) to V(m)
34WV50	DC to 65 GHz, 50 Ω, W1(m) to V(f)
34WV50	DC to 65 GHz, 50 Ω, W1(f) to V(f)

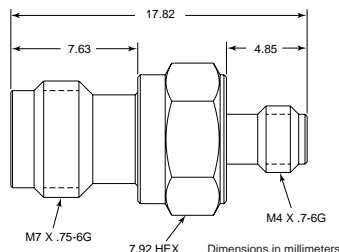

34WV50 outline

INSTRUMENTATION GRADE WAVEGUIDE ADAPTERS

35WR Series 18 to 110 GHz



The 35 Series precision adapters transform standard or double-ridge waveguide to coaxial K Connector® and V Connector®, and W1 Connector®, interfaces, thus enabling convenient millimeter wave coaxial measurements.

Features

- 18 to 65 GHz frequency coverage
- K Connector® compatibility with SMA and 3.5 mm
- V Connector® compatibility with 2.4 mm
- W1 Connector® compatibility with 1.0 mm
- Standard and double-ridge designs

Specifications

Model	Frequency range (GHz)	Connectors	W/G flange	SWR
35WRD180K 35WRD180KF	18 to 40	WRD180 to K(m) WRD180 to K(f)	N/A	1.25
35WR42K 35WR42KF	18 to 26.5	WR42 to K(m) WR42 to K(f)	595	1.25
35WR28K 35WR28KF	26.5 to 40	WR28 to K(m) WR28 to K(f)	599	1.25
35WR22K 35WR22KF	33 to 50	WR22 to K(m) WR22 to K(f)	383	1.30
35WR22V 35WR22VF	33 to 50	WR22 to V(m) WR22 to V(f)	383	1.30
35WR19K 35WR19KF	40 to 50 Usable to 54	WR19 to K(m) WR19 to K(f)	383	1.30
35WR19V 35WR19VF	40 to 60	WR19 to V(m) WR19 to V(f)	383	1.30
35WR15V 35WR15VF	50 to 65	WR15 to V(m) WR15 to V(f)	385	1.30
35WR10W 35WR10WF	75 to 110	WR10 to W(m) WR10 to W(f)	387	1.38

Impedance: 50 Ω

Temperature range: -55°C to +125°C

Ordering information

Please specify model/order number, name, and quantity when ordering.

Model/Order No.	Name
	Precision waveguide to coax adapter
35WRD180K	18 to 40 GHz, WRD180 (double ridge waveguide) to K(m)
35WRD180KF	18 to 40 GHz, WRD180 (double ridge waveguide) to K(f)
35WR42K	18 to 26.5 GHz, WR42-K(m)
35WR42KF	18 to 26.5 GHz, WR42-K(f)
35WR28K	26.5 to 40 GHz, WR28-K(m)
35WR28KF	26.5 to 40 GHz, WR28-K(f)
35WR22K	33 to 50 GHz, WR22-K(m)
35WR22KF	33 to 50 GHz, WR22-K(f)
35WR22V	33 to 50 GHz, WR22-V(m)
35WR22VF	33 to 50 GHz, WR22-V(f)
35WR19K	40 to 50 GHz (usable to 54 GHz), WR19-K(m)
35WR19KF	40 to 50 GHz (usable to 54 GHz), WR19-K(f)
35WR19V	40 to 60 GHz, WR19-V(m)
35WR19VF	40 to 60 GHz, WR19-V(f)
35WR15V	50 to 65 GHz (usable to 67 GHz), WR15-V(m)
35WR15VF	50 to 65 GHz (usable to 67 GHz), WR15-V(f)
35WR10W	75 to 110, WR10 to W(m)
35WR10WF	75 to 110, WR10 to W(f)

Outline drawings for the 35 Series Waveguide-to-Coaxial Adapters, 18 to 110 GHz, are shown on the following three pages.

INSTRUMENTATION GRADE WAVEGUIDE ADAPTERS

35WR Series 18 to 110 GHz

Outline Drawings

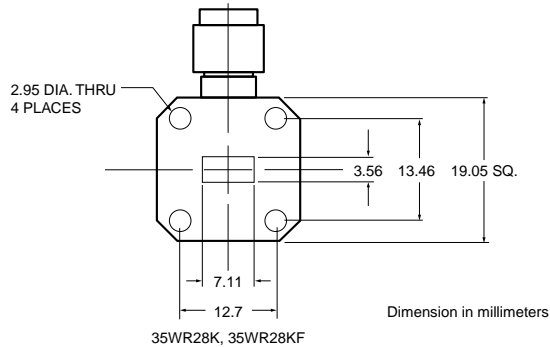
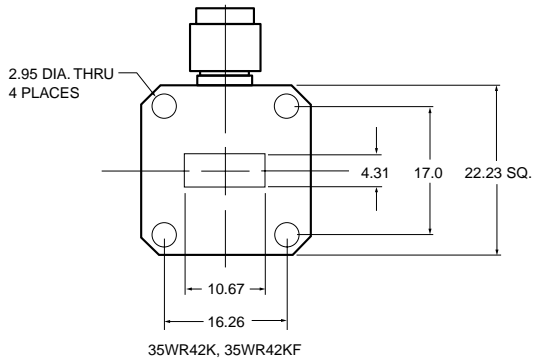
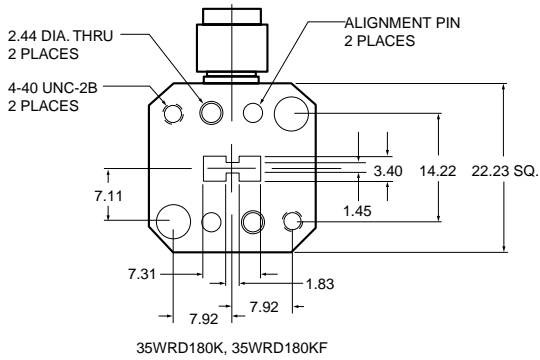
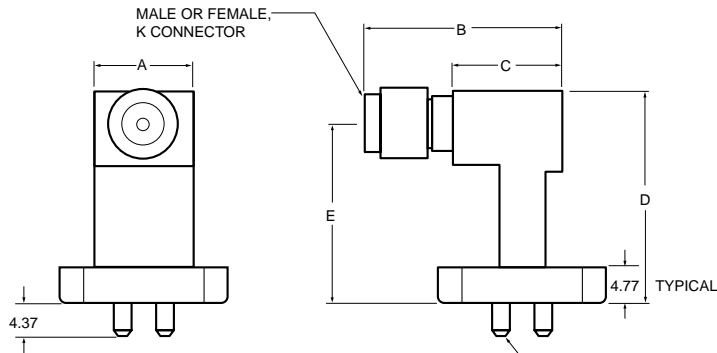

Model	Dimensions (mm)				
	A	B	C	D	E
35WRD180K	13.20	27.9	14.43	28.40	23.80
35WRD180KF	13.20	22.9	14.43	28.40	23.80
35WR42K	13.20	27.9	14.43	28.14	23.93
35WR42KF	13.20	22.9	14.43	28.14	23.93
35WR28K	10.67	27.9	14.86	28.78	23.93
35WR28KF	10.67	22.9	14.86	28.78	23.88

35WRD180K, 35WRD180KF, 35WR42K, 35WR42KF, 35WR28K, 35WR28KF outlines

INSTRUMENTATION GRADE WAVEGUIDE ADAPTERS

35WR Series 18 to 110 GHz

Outline Drawings

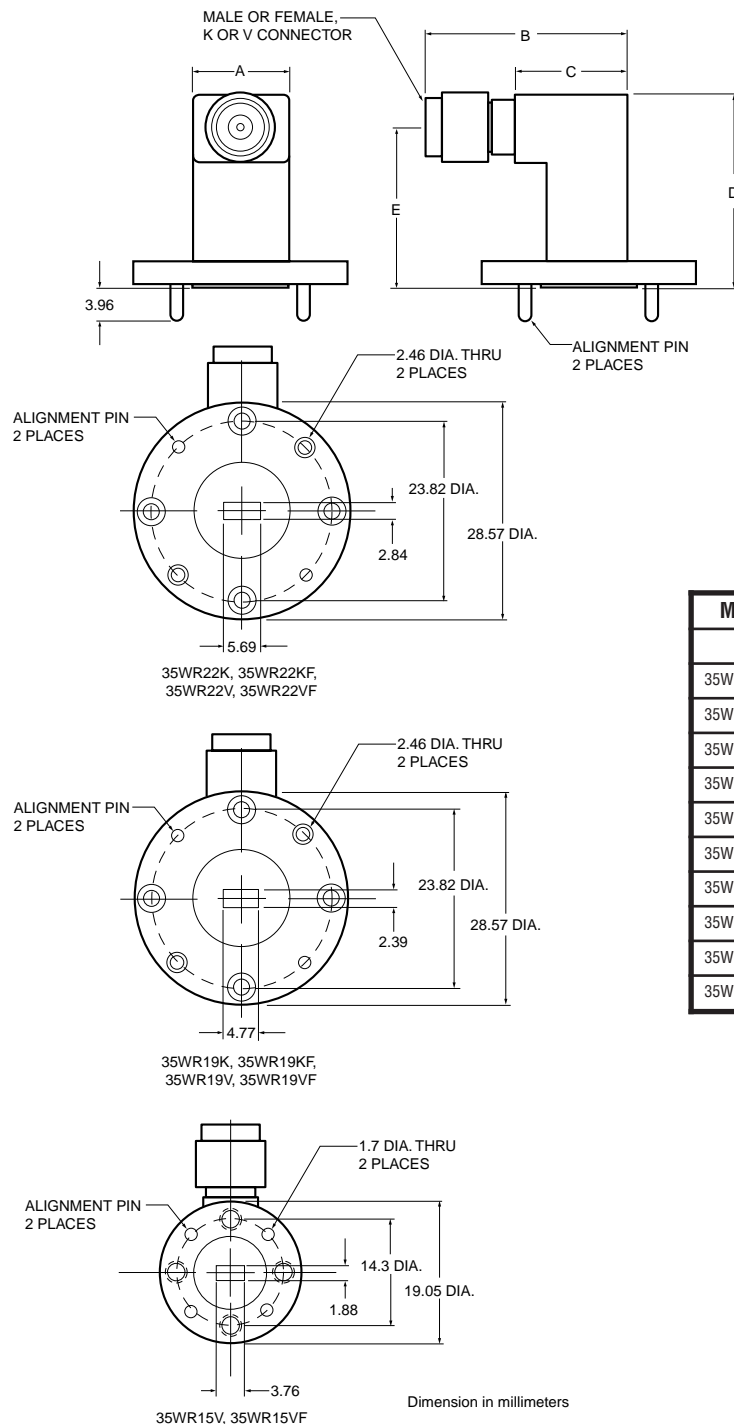

Model	Dimensions (mm)				
	A	B	C	D	E
35WR22K	12.70	26.9	14.73	25.76	21.44
35WR22KF	12.70	21.6	14.73	25.76	21.44
35WR22V	12.70	26.9	14.73	25.76	21.44
35WR22VF	12.70	21.6	14.73	25.76	21.44
35WR19K	12.70	26.9	14.73	25.76	21.44
35WR19KF	12.70	21.6	14.73	25.76	21.44
35WR19V	12.70	27.9	14.73	25.76	21.44
35WR19VF	12.70	22.6	14.73	25.76	21.44
35WR15V	12.70	24.4	12.19	26.97	21.62
35WR15VF	12.70	20.3	12.19	26.97	21.62

35WR22K, 35WR22KF, 35WR22V, 35WR22VF, 35WR19K, 35WR19KF, 35WR19V, 35WR19VF, 35WR15V, and 35WR15VF outlines

INSTRUMENTATION GRADE WAVEGUIDE ADAPTERS

35WR Series 18 to 110 GHz

Outline Drawings

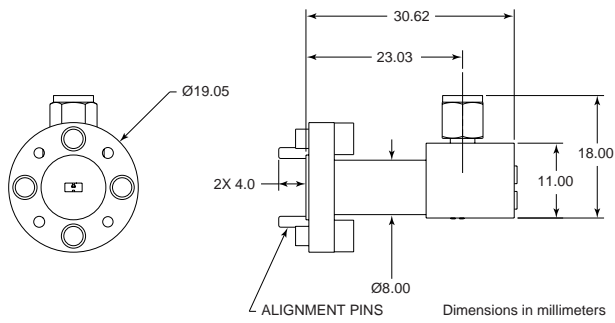

35WR10W outline

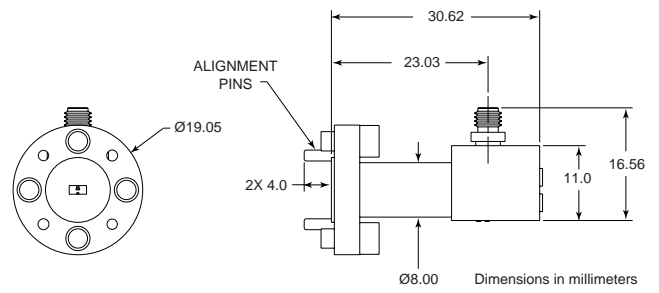

35WR10WF outline

INSTRUMENTATION GRADE WAVEGUIDE ADAPTERS

35U, 35C Series 3.3 to 26.5 GHz

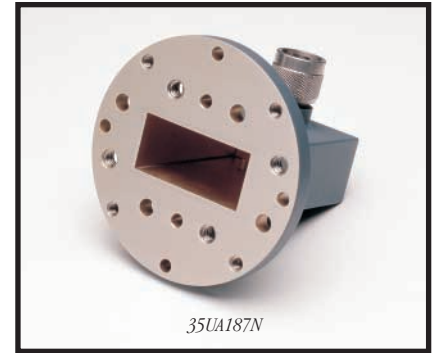
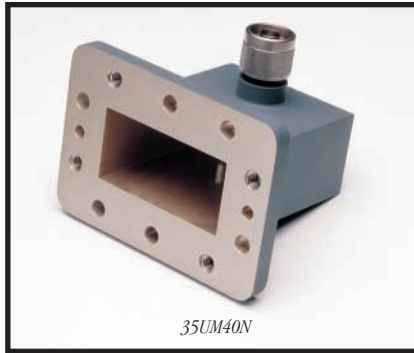

The 35U and 35C Series precision adapters transform standard waveguide to coaxial Type N and K Connector® interfaces, thus enabling convenient microwave coaxial measurements.

Features

- 3.3 to 26.5 GHz frequency coverage
- Type N connector compatibility
- K Connector® compatibility with SMA and 3.5 mm

Specifications

Model	Frequency range (GHz)	Connectors	W/G flange	SWR
35UM40N	3.3 to 4.9	WR229 to N(m) WG11A to N(m)	PDR40	1.08
35UM48N	3.9 to 5.8	WR187 to N(m) WG12 to N(m)	CAR48, PAR48, UAR48, PDR48	1.08
35UM58N	4.9 to 7.0	WR159 to N(m) WG13 to N(m)	CAR58, PAR58, UAR58, PDR58	1.08
35UM70N	5.8 to 8.2	WR137 to N(m) WG14 to N(m)	CAR70, PAR70, UAR70, PDR70	1.08
35UM84N	7.0 to 10	WR112 to N(m) WG15 to N(m)	CBR84, UBR84, PBR84, PDR84	1.08
35UM100N	8.2 to 12.4	WR90 to N(m) WG16 to N(m)	CBR100, UBR100, PBR100, PDR100	1.08
35UM120N	10 to 15	WR75 to N(m) WG17 to N(m)	CBR120, UBR120, PBR120, PDR120	1.08
35UM140N	12.4 to 18	WR62 to N(m) WG18 to N(m)	CBR140, UBR140, PBR140, PDR140	1.08
35UM220K	17 to 26.5	WR42 to K(m) WG20 to K(m)	CBR220, UBR220, PBR220, PDR220	1.20
35UA229N	3.3 to 4.9	WR229 to N(m) WG11A to N(m)	CPR229F, CPR229G, UG-1350/U, UG-1351/U, UG-1726/U, UG-1727/U	1.08
35UA187N	3.9 to 5.8	WR187 to N(m) WG12 to N(m)	CPR187F, CPR187G, UG-1352/U, UG-1353/U, UG-1728/U, UG-1729/U, UG-148/U, UG-149A/U	1.08
35UA159N	4.9 to 7.0	WR159 to N(m) WG13 to N(m)	CPR159F, CPR159G, UG-1354/U, UG-1355/U, UG-1730/U, UG-1731/U	1.08
35UA137N	5.8 to 8.2	WR137 to N(m) WG14 to N(m)	CPR137F, CPR137G, UG-1356/U, UG-1357/U, UG-1732/U, UG-1733/U, UG-343B/U, UG-344/U, UG-440B/U, UG-441/U	1.08

Specifications

Model	Frequency range (GHz)	Connectors	W/G flange	SWR
35UA112N	7.0 to 10	WR112 to N(m) WG15 to N(m)	CPR112F, CPR112G, UG-1358/U, UG-1359/U, UG-1734/U, UG-1735/U, UG-52B/U, UG-51/U, UG-137B/U, UG-138/U	1.08
35UA90N	8.2 to 12.4	WR90 to N(m) WG16 to N(m)	CPR90F, CPR90G, UG-1360/U, UG-1361/U, UG-1736/U, UG-1737/U, UG-40B/U, UG-39/U, UG-135B/U, UG-136/U	1.08
35UA75N	10 to 15	WR75 to N(m) WG17 to N(m)	WR75	1.08
35UA62N	12.4 to 18	WR62 to N(m) WG18 to N(m)	UG-541A/U, UG-419A/U, UG-1665/U, UG-1666/U	1.08
35UA42K	17 to 26.5	WR42 to K(m) WG20 to K(m)	UG-596A/U, UG-595/U, UG-597/U, UG-598A/U	1.08
35CMR229N	3.3 to 4.9	WR229 to N(m)	CMR229	1.08
35CMR187N	3.9 to 5.8	WR187 to N(m) WG12 to N(m)	CMR187, UG-1475/U, UG-148/U	1.08
35CMR159N	4.9 to 7.0	WR159 to N(m) WG13 to N(m)	CMR159	1.08
35CMR137N	5.8 to 8.2	WR137 to N(m) WG14 to N(m)	CMR137, UG-1476/U, 1UG-1481/U	1.08
35CMR112N	7.0 to 10	WR112 to N(m) WG15 to N(m)	CMR112, UG-1477/U, UG-1482/U	1.08
35CMR90N	8.2 to 12.4	WR90 to N(m) WG16 to N(m)	CMR90, UG-1478/U, UG-1483/U	1.08
35UER40N	3.3 to 4.9	WR229 to N(m) WG11A to N(m)	UER40	1.08
35UER48N	3.9 to 5.8	WR187 to N(m) WG12 to N(m)	UER48	1.08
35UER58N	4.9 to 7.0	WR159 to N(m) WG13 to N(m)	UER58	1.08
35UER70N	5.8 to 8.2	WR137 to N(m) WG14 to N(m)	UER70	1.08
35UER84N	7 to 10	WR112 to N(m) WG15 to N(m)	UER84	1.08
35UER100N	8.2 to 12.4	WR90 to N(m) WG16 to N(m)	UER100	1.08

INSTRUMENTATION GRADE WAVEGUIDE ADAPTERS

35U, 35C Series 3.3 to 26.5 GHz

Outline Drawings

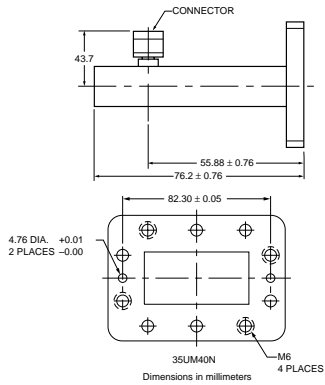

35UM40N outline

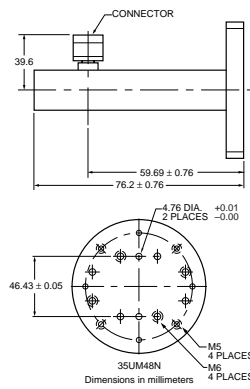

35UM48N outline

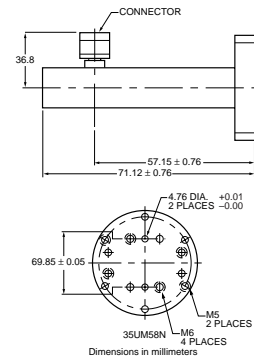

35UM58N outline

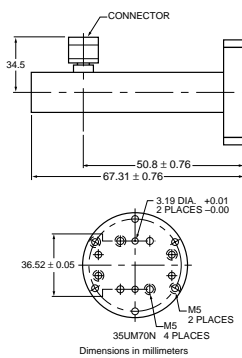

35UM70N outline

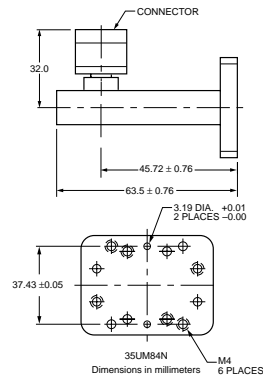

35UM84N outline

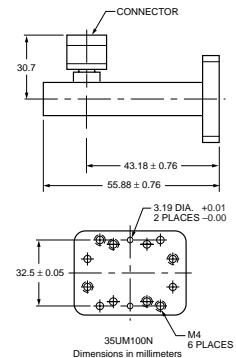

35UM100N outline

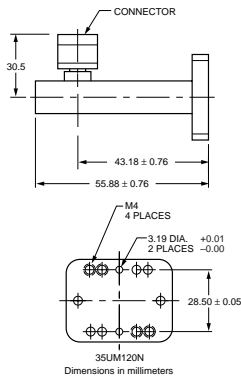

35UM120N outline

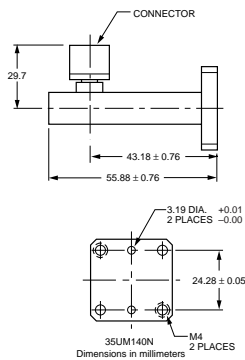

35UM140N outline

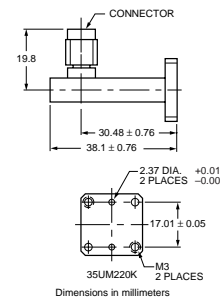

35UM220K outline

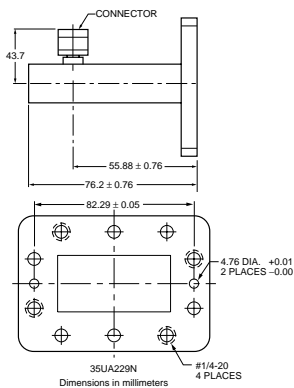

35UA229N outline

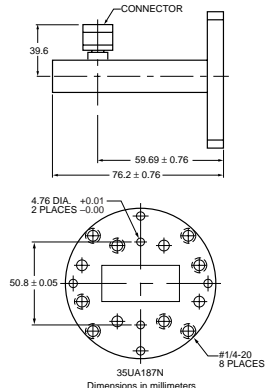

35UA187N outline

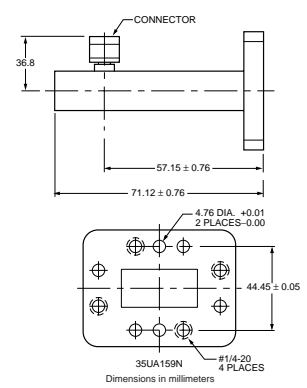

35UA159N outline

INSTRUMENTATION GRADE WAVEGUIDE ADAPTERS

35U, 35C Series 3.3 to 26.5 GHz

Outline Drawings

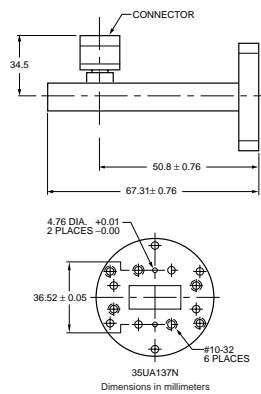

35UA137N outline

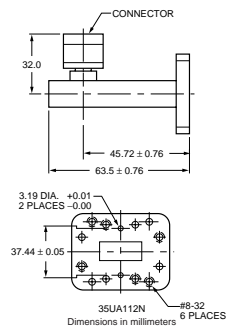

35UA112N outline

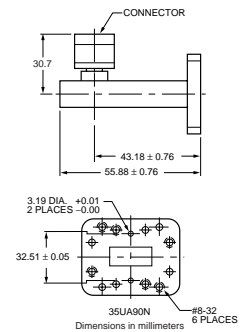

35UA90N outline

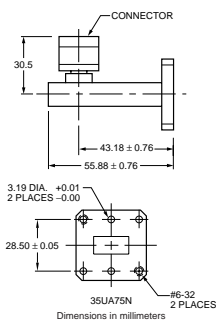

35UA75N outline

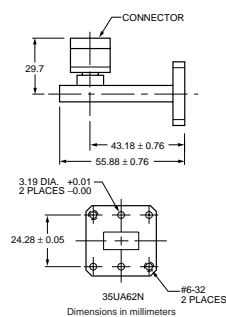

35UA62N outline

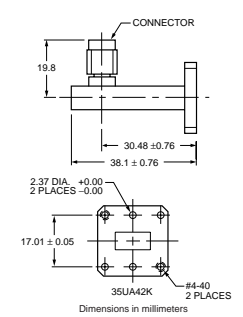

35UA42K outline

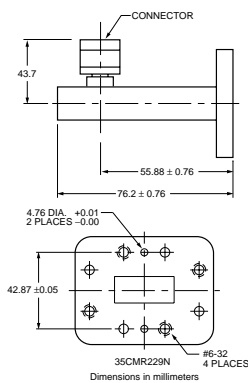

35CMR229N outline

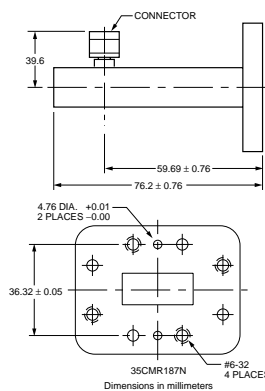

35CMR187N outline

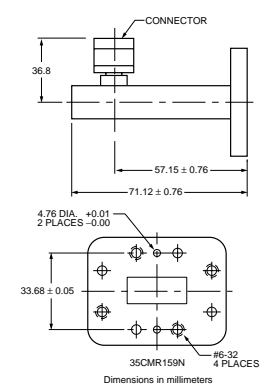

35CMR159N outline

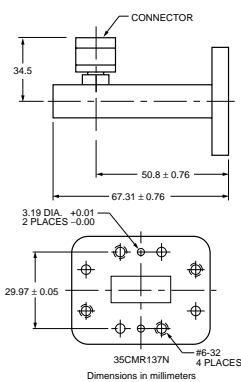

35CMR137N outline

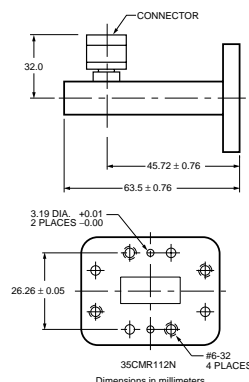

35CMR112N outline

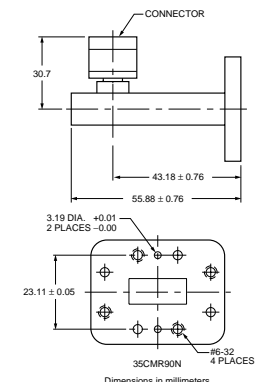

35CMR90N outline

INSTRUMENTATION GRADE WAVEGUIDE ADAPTERS

35U, 35C Series 3.3 to 26.5 GHz

Outline Drawings

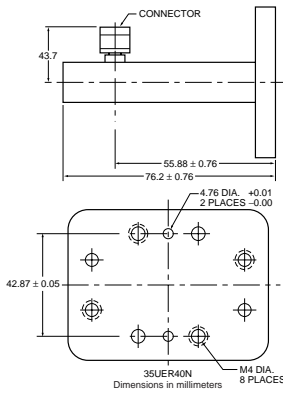

35UER40N outline

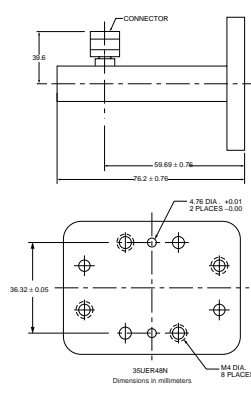

35UER48N outline

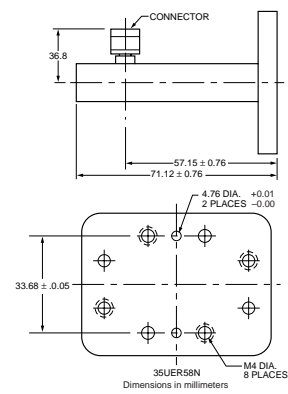

35UER58N outline

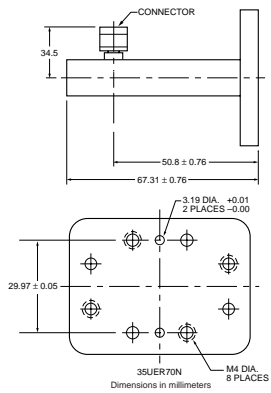

35UER70N outline

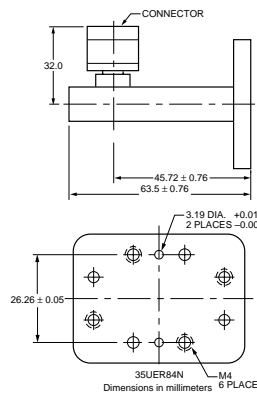

35UER84N outline

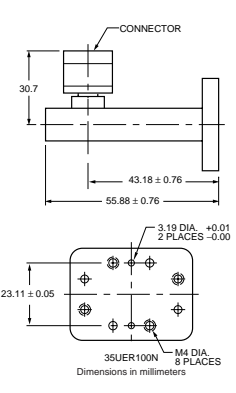

35UER100N outline

Ordering information

Please specify model/order number, name, and quantity when ordering.

Model/Order No.	Name
	Coaxial adapter
35UM40N	N(m), metric, 3.30 to 4.90 GHz
35UM48N	N(m), metric, 3.95 to 5.85 GHz
35UM58N	N(m), metric, 4.90 to 7.05 GHz
35UM70N	N(m), metric, 5.85 to 8.20 GHz
35UM84N	N(m), metric, 7.05 to 10.00 GHz
35UM100N	N(m), metric, 8.20 to 12.40 GHz
35UM120N	N(m), metric, 10.00 to 15.00 GHz
35UM140N	N(m), metric, 12.40 to 18.0 GHz
35UM220K	K(m), metric, 17.00 to 26.5 GHz
35UA229N	N(m), US, 3.30 to 4.90 GHz
35UA187N	N(m), US, 3.95 to 5.85 GHz
35UA159N	N(m), US, 4.90 to 7.05 GHz
35UA137N	N(m), US, 5.85 to 8.20 GHz
35UA112N	N(m), US, 7.05 to 10.00 GHz
35UA90N	N(m), US, 8.20 to 12.40 GHz
35UA75N	N(m), US, 10.00 to 15.00 GHz
35UA62N	N(m), US, 12.40 to 18.0 GHz
35UA42K	K(m), US, 17.00 to 26.5 GHz

Model/Order No.	Name
	Coaxial adapter
35CMR229N	N(m), CMR, 3.30 to 4.90 GHz
35CMR187N	N(m), CMR, 3.95 to 5.85 GHz
35CMR159N	N(m), CMR, 4.90 to 7.05 GHz
35CMR137N	N(m), CMR, 5.85 to 8.20 GHz
35CMR112N	N(m), CMR, 7.05 to 10.00 GHz
35CMR90N	N(m), CMR, 8.20 to 12.40 GHz
35UER40N	N(m), UER, 3.30 to 4.90 GHz
35UER48N	N(m), UER, 3.95 to 5.85 GHz
35UER58N	N(m), UER, 4.90 to 7.05 GHz
35UER70N	N(m), UER, 5.85 to 8.20 GHz
35UER84N	N(m), UER, 7.05 to 10.00 GHz
35UER100N	N(m), UER, 8.20 to 12.40 GHz

COAXIAL TERMINATIONS

28, 29 Series DC to 110 GHz



These precision, metrology-grade terminations are used in measurement systems that need to achieve the smallest possible reflections. Their excellent match makes them ideal as a reference for fault location measurements on scalar network analyzers.

Precision termination features

- Accurate reference for SWR measurements
- Precise termination for test instrument or device under test

Precision termination specifications

Model	Frequency range (GHz)	Test port connector	Input impedance (Ω)	SWR (F in GHz)	Dimensions L(cm) x dia(cm)
28A50-1	DC to 18	GPC-7	50	1.02 Max.	5.2 x 2.2
28N50-2 28NF50-2	DC to 18	N(m) N(f)	50	1.02 Max.	5.2 x 2.2 4.8 x 1.6
28N50-3 28NF50-3	DC to 8	N(m) N(f)	50	1.03 Max.	5.2 x 2.2 4.8 x 1.6
28S50-1 28SF50-1	DC to 26.5	WSMA(m) WSMA(f)	50	1.020 to 18.5 GHz 1.153 to 26.5 GHz	3.7 x 1.2 3.7 x 1.2
28K50 28KF50	DC to 40	K(m) K(f)	50	1.040 to 18.5 GHz 1.070 to 26.5 GHz 1.135 to 40 GHz	3.7 x 1.2 3.7 x 1.2
28V50B 28VF50B	DC to 67	V(m) V(f)	50	1.018 to 6 GHz 1.058 to 26.5 GHz 1.074 to 40 GHz 1.12 to 60 GHz 1.25 to 67 GHz	3.7 x 1.2 3.7 x 1.2
28W50	DC to 110	W1(m)	50	1.0458 to 20 GHz 1.058 to 65 GHz 1.33 to 110 GHz	2.5 x 0.8
28WF50	DC to 110	W1(f)	50	1.0515 to 20 GHz 1.0653 to 65 GHz 1.50 to 110 GHz	2.5 x 0.8

Maximum Input Power: 0.5 W

When used with Anritsu airlines, the 29 Series Offset Terminations permit measurements down to 1.006 SWR to 18 GHz, 1.01 SWR to 26.5 GHz, and 1.02 SWR to 40 GHz.

Offset termination features

- 50 Ω Offset Terminations for precise measurement of low SWR or high directivity
- Measurements down to 1.006 SWR to 18 GHz, 1.01 SWR to 26.5 GHz, and 1.02 SWR to 40 GHz

Offset termination specifications

Model	Frequency range (GHz)	Test port connector	Return loss (dB)	Dimensions L(cm) x dia(cm)
29A50-20	DC to 18	GPC-7	20 \pm 0.5 to 1 GHz 20 \pm 1.0 to 4 GHz 20 \pm 1.5 to 18 GHz	5.2 x 2.2
29S50-20	DC to 26.5	WSMA(m)	20 \pm 1.5 to 18.5 GHz 20 \pm 2.5 to 26.5 GHz	3.7 x 1.2
29SF50-20	DC to 26.5	WSMA(f)	20 \pm 1.5 to 18.5 GHz 20 \pm 2.5 to 26.5 GHz	3.7 x 1.2
29K50-15	DC to 40	K(m)	15 \pm 1.5 to 18.5 GHz 15 \pm 2.5 to 26.5 GHz 15 \pm 3.5 to 40 GHz	3.7 x 1.2
29KF50-15	DC to 40	K(f)	15 \pm 1.5 to 18.5 GHz 15 \pm 2.5 to 26.5 GHz 15 \pm 3.5 to 40 GHz	3.7 x 1.2

Temperature range: +25°C \pm 5°C

Ordering information

Please specify model/order number, name, and quantity when ordering.

Model/Order No.	Name
Precision termination	
28A50-1	DC to 18 GHz, 50 Ω , GPC-7, Max. SWR=1.02
28N50-2	DC to 18 GHz, 40 dB, 50 Ω , N(m)
28NF50-2	DC to 18 GHz, 40 dB, 50 Ω , N(f)
28N50-3	DC to 8.6 GHz, 50 Ω , N(m)
28NF50-3	DC to 8.6 GHz, 50 Ω , N(f)
28S50-1	DC to 26.5 GHz, 50 Ω , WSMA(m) (selected for higher accuracy)
28SF50-1	DC to 26.5 GHz, 50 Ω , WSMA(f) (selected for higher accuracy)
28K50	DC to 40 GHz, 50 Ω , K(m)
28KF50	DC to 40 GHz, 50 Ω , K(f)
28V50B	DC to 65 GHz, V(m)
28VF50B	DC to 65 GHz, V(f)
28W50	DC to 110 GHz, 50 Ω , W1(m)
28WF50	DC to 110 GHz, 50 Ω , W1(f)
Offset termination	
29A50-20	DC to 18 GHz, 50 Ω , GPC-7, 20 dB return loss
29S50-20	DC to 26.5 GHz, 50 Ω , WSMA(m), 20 dB return loss
29SF50-20	DC to 26.5 GHz, 50 Ω , WSMA(f), 20 dB return loss
29K50-15	DC to 40 GHz, 50 Ω , K(m), 15 dB return loss
29KF50-15	DC to 40 GHz, 50 Ω , K(f), 15 dB return loss

COAXIAL TERMINATIONS

K210, V210 DC to 65 GHz



K210



V210

Coaxial Termination features

- Accurate reference for SWR measurements
- Precise termination for test instrument or device under test

Specifications

Model	Frequency Range (GHz)	Test Port Connector	Input Impedance (Ω)	SWR
K210	DC to 40	K(m)	50	1.106 to 18 GHz 1.253 to 40 GHz
V210	DC to 65	V(m)	50	1.12 to 18 GHz 1.22 to 18-26.5 GHz 1.29 to 26.5-40 GHz 1.38 to 40-65 GHz

Maximum Input Power: 0.5W

Ordering information

Please specify model/order number, name, and quantity when ordering.

Model/Order No.	Name
K210	Coaxial Termination, DC to 40 GHz, K(m)
V210	Coaxial Termination, DC to 65 GHz, V(m)

FIXED ATTENUATORS

41, 43 Series DC to 65 GHz

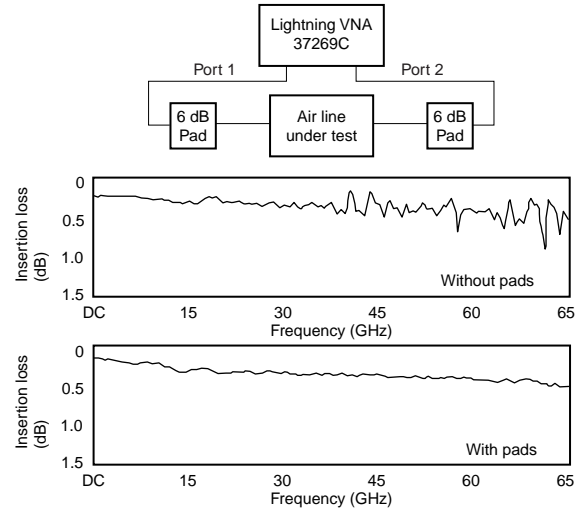

Improved Measured Accuracy

Anritsu offers two series of fixed attenuators:

- *The Gold Line (Series 41) for precision measurement applications covering DC to 65 GHz*
- *The Silver Line (Series 43) for use in systems and OEM equipment covering DC to 40 GHz*

Both series offer fixed attenuation values of 3, 6, 10, or 20 dB with models that span frequency range of DC to 26.5 GHz, 40 GHz, or 65 GHz

Features

- 3, 6, 10, or 20 dB Attenuation up to 65 GHz
- Low SWR, 1.28 Up to 40 GHz
- SMA, 3.5 mm, and 2.4 mm compatibility
- Rugged and reliable K Connector® and V Connector®

Advanced performance and reliability

Anritsu attenuators define the standard for fixed attenuator performance and reliability. Performance, however, is not their only distinguishing feature. Attenuators that use the K Connector® offer a vast improvement in reliability, compared to attenuators with SMA connectors. Attenuators that use the V Connector® can be connected directly to 2.4 mm devices.

For applications in metrology and calibration laboratories where precise characterization is essential, the Gold Line models are available in sets consisting of 3, 6, 10, and 20 dB units. Each is provided with attenuation and SWR calibration data. Calibration data is also optionally available for individual units, each of which is serialized.

The reliability of the attenuator connectors is affected by insertion force, outer conductor mating area, and mating alignment. The K Connector® is used because it has excellent performance in all of these areas. For example, a typical female SMA, 3.5 mm center conductor requires up to 27N* of insertion force compared to 2.2N* for the K Connector®. In addition, the K Connector® outer conductor is four times thicker than SMA, resulting in a conservative order-of-magnitude improvement in the number of reliable connections.

To avoid a major cause of connector failure, the K Connector® male pin is deliberately made shorter than the SMA pin. Therefore, the outer housing is properly aligned prior to center conductor mating, preventing destructive alignment.

Gold Line - improved measurement accuracy

Adding Gold Line attenuators to your attenuation measurement setup will improve your measurement accuracy. In the test setup shown, the insertion loss of an air line was measured, first without and then with matching 6 dB pads. The difference in the accuracy of the two measurements is striking. By attenuating reflections and re-reflections that occur at the input and output of the air line, the pads reduce mismatch errors and allow the system to measure more accurately the actual insertion loss.

Silver Line - improved system reliability

Fixed attenuators used in systems or OEM equipment must be small, lightweight, economical, and reliable under severe environmental conditions. The Silver Line meets these requirements. K Connectors ensure well-seated, low-reflection connections that provide consistent operation year after year.

The Series 43 (Silver Line) attenuator's small size, 8 mm dia. x 28.8 mm length, and light weight, 8g make them an attractive choice for miniaturized, lightweight systems.

* Force is measured in Newtons (N).

FIXED ATTENUATORS

41, 43 Series DC to 65 GHz

Common specifications

Impedance		50 Ω
Power rating (average)		2W at 20°C; 1W at 85°C
Temperature coefficient		0.001 dB/dB/°C
Connectors	V Connector®	Male and female compatible with 2.4 mm
	K Connector®	Male and female, compatible with SMA and 3.5 mm
Material		Passivated stainless steel housing
Size	Length	28.8 mm ±0.5 mm
	Diameter	8 mm
Weight		8g
Temperature range	Operating	-55°C to +85°C
	Nonoperating	-55°C to +125°C

Specifications

	Model ^①	Attenuation (dB)	Attenuation Accuracy				SWR					
			DC-18 GHz	18-26.5 GHz	26.5-40 GHz	40-65 GHz	DC-12 GHz	12-18 GHz	18-26.5 GHz	26.5-40 GHz	40-65 GHz	
Gold Line	DC to 60 GHz											
	41V-3	3	±0.5	±0.6	±0.9	±1.50	1.15	1.20	1.30	1.50	1.90	
	41V-6	6	±0.5	±0.6	±0.9	±1.50	1.15	1.20	1.25	1.40	1.90	
	41V-10	10	±0.5	±0.6	±0.9	±1.50	1.15	1.20	1.25	1.40	1.90	
	41V-20	20	±0.5	±0.6	±0.9	±1.50	1.15	1.20	1.25	1.40	1.90	
	DC to 40 GHz											
	41KC-3	3	±0.4	±0.5	±0.8	-	1.10	1.15	1.23	1.42	-	
	41KC-6	6	±0.4	±0.5	±0.8	-	1.10	1.15	1.18	1.28	-	
	41KC-10	10	±0.4	±0.5	±0.8	-	1.10	1.15	1.18	1.28	-	
	41KC-20	20	±0.4	±0.5	±0.8	-	1.10	1.15	1.18	1.28	-	
	DC to 26.5 GHz											
	41KB-3	3	±0.4	±0.5	-	-	1.10	1.15	1.23	-	-	
41KB-6	6	±0.4	±0.5	-	-	1.10	1.15	1.18	-	-		
41KB-10	10	±0.4	±0.5	-	-	1.10	1.15	1.18	-	-		
41KB-20	20	±0.4	±0.5	-	-	1.10	1.15	1.18	-	-		
Silver Line	Model		Attenuation Accuracy				SWR					
			DC-18 GHz	18-26.5 GHz	26.5-40 GHz	40-60 GHz	DC-12 GHz	12-18 GHz	18-26.5 GHz	26.5-40 GHz	40-60 GHz	
	DC to 40 GHz											
	43KC-3	3	±0.5	±0.6	±0.9	-	1.15	1.20	1.30	1.50	-	
	43KC-6	6	±0.5	±0.6	±0.9	-	1.15	1.20	1.30	1.40	-	
	43KC-10	10	±0.5	±0.6	±0.9	-	1.15	1.20	1.30	1.40	-	
	43KC-20	20	±0.5	±0.6	±0.9	-	1.15	1.20	1.30	1.40	-	
	DC to 26.5 GHz											
	43KB-3	3	±0.5	±0.6	-	-	1.15	1.20	1.30	-	-	
	43KB-6	6	±0.5	±0.6	-	-	1.15	1.20	1.30	-	-	
	43KB-10	10	±0.5	±0.6	-	-	1.15	1.20	1.30	-	-	
	43KB-20	20	±0.5	±0.6	-	-	1.15	1.20	1.30	-	-	

① For traceability, all Gold Line attenuators are serialized.

② ±1 dB from DC to 26.5 GHz; ±1.3 dB from >26.5 to 40 GHz, including frequency response and DC offset.

Environmental information

Tests are performed per MIL-STD-202F.

Operating Temperature Range	-55°C to +85°
Temperature Shock	-55°C to +150°
Humidity	95% at 40°C, 96 hours, Test 103B, Condition B
Shock	100 G peak sawtooth, method 213, Condition B
Vibration	Sinewave: 10 Hz to 2000 Hz, 0.06" DA, method 204, test condition D Random: 50 Hz to 2000 Hz, 11.6 Grms, Power Spectral Density 0.1 Grms 2 Hz, Method 214, Test Condition 1, Letter D
Salt Spray	5% concentration for 48 hours, Method 101D, Condition B
Voltage withstanding	500 Vac RMS, 60 seconds, method 301

Ordering information

Please specify model/order number, name, and quantity when ordering. Single fixed attenuators may be ordered from the table above.

Model/Order No.	Name
Precision Fixed Attenuator	
41KB-3, 6, 10, or 20	3 dB, 6 dB, 10 dB, 20 dB, DC to 26.5 GHz, 50 Ω, K(m)-K(f)
41KC-3, 6, 10, or 20	3 dB, 6 dB, 10 dB, 20 dB, DC to 40 GHz, 50 Ω, K(m)-K(f)
41V-3, 6, 10, or 20	3 dB, 6 dB, 10 dB, 20 dB, DC to 65 GHz, 50 Ω, V(m)-V(f)
Precision Fixed Attenuator Set	
41KB-S*	41KB Series
41KC-S*	41KC Series
41V-S*	41V Series
Fixed Attenuator	
43KB-3, 6, 10, or 20	3 dB, 6 dB, 10 dB, 20 dB, DC to 26.5 GHz, 50 Ω, K(m)-K(f)
43KC-3, 6, 10, or 20	3 dB, 6 dB, 10 dB, 20 dB, DC to 40 GHz, 50 Ω, K(m)-K(f)
Option	
Option C**	Calibration Data

* A set of 3, 6, 10, and 20 dB Gold line (Series 41). Attenuators are supplied in a handsome hardwood case. Calibration data are included for each unit.

** Attenuation and SWR test data are provided for input and output ports at 500 MHz frequency intervals.

STEP ATTENUATORS

4400, 4500, 4600 Series DC to 40 GHz



4612K



4622K

Anritsu programmable step attenuators bring a substantial increase in the frequency and attenuation range available in one small package. Using the latest technology, these units offer superior performance, reliability, and ease of use to 40 GHz. All are plug-compatible with competitive units.

Features

- DC-20 GHz, DC-26.5 GHz, DC-40 GHz
- 70 dB and 110 dB attenuation ranges
- Lowest insertion loss
- Precise repeatability
- Life of 5 million operations
- Small, rugged, light weight

Advanced technology-advanced performance

Anritsu has lowered throughline loss by designing the first 40 dB attenuator sections to operate above 18 GHz. Compared with designs that use 30 dB sections, these attenuators have a shorter thru path and fewer switching contacts. As a result, insertion loss is as much as 1.7 dB less than that of units made by other companies. RF input power requirements for systems that use these attenuators can be reduced, saving money, space, and weight.

Integrated switching structure

The push rods that switch in the attenuator modules and thru lines are driven by a solenoid actuator. By designing the solenoid as an integral part of the attenuator assembly, switching speeds of 20 ms (including settling time) are achieved. Upon completion of the switching operation, the solenoid is magnetically latched to withstand severe shock and vibration. At the same time, the solenoid current is automatically turned off to save power and to minimize temperature rise.

Also integrated in the design is solid state dc switching circuitry that avoids the relatively high failure rate of mechanical DC switches. Each attenuator section is controlled by its own driver circuit, which requires 24V, 125 mA. A typical external driver circuit for one section is shown in the figure below.

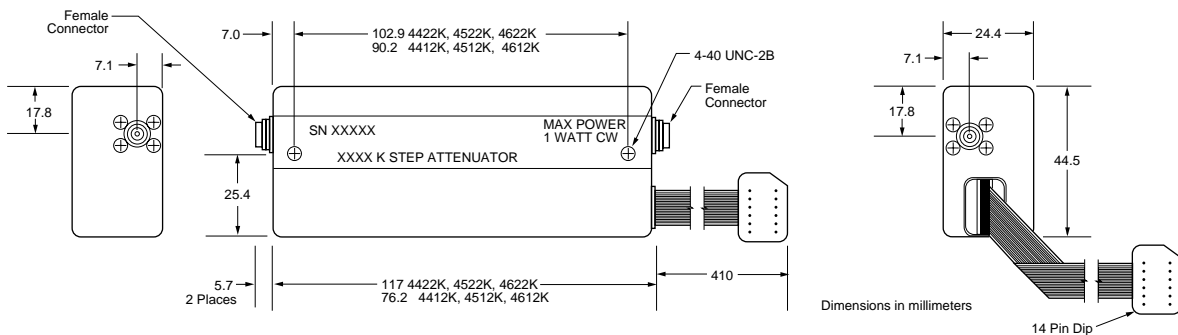
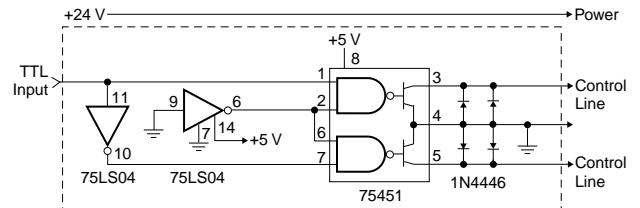

4400, 4500, and 4600 series outline

STEP ATTENUATORS

4400, 4500, 4600 Series DC to 40 GHz

Accuracy enhancing calibration data

Attenuation accuracy can be improved by using optional calibration data taken on an Anritsu vector network analyzer. The calibration data can be used to normalize the effect of frequency response and reflections. The calibration data is traceable to NIST.

Specifications

Frequency and attenuation ranges

Model	Frequency range	Attenuation range in 10 dB steps	Connectors
4412K 4422K	DC to 20 GHz	0 to 70 dB 0 to 110 dB	K(f)
4512K 4522K	DC to 26.5 GHz	0 to 70 dB 0 to 110 dB	K(f)
4612K 4622K	DC to 40 GHz	0 to 70 dB 0 to 110 dB	K(f)

Attenuator accuracy (\pm dB)

Frequency (GHz)	Attenuation (dB)							
	10	20	30	40	50	60	70	80-110
DC to 8	0.3	0.5	0.6	0.7	0.8	1.0	1.1	1.4
>8 to 12	0.4	0.5	0.7	0.9	1.0	1.3	1.5	2.0
>12 to 20	0.5	0.6	0.8	1.1	1.2	1.4	1.7	2.2
>20 to 26.5	0.7	0.8	1.0	1.5	1.6	1.9	2.3	2.8
>26.5 to 40	0.9	1.0	1.2	1.7	1.9	2.3	2.6	3.2

Electrical

Switching speed (maximum)	20 ms
Operating voltage	20 to 30 Volts
Switching control current	125 mA at 24V nominal per section 3 sections in 4412K, 4512K, 4612K 4 sections in 4422K, 4522K, 4622K
Solenoid coil impedance	190 Ω
Solenoid coil inductance	65 mH
RF input power (maximum)	1W average, 100W peak for 10 μ s
RF power sensitivity	0.001 dB/W
Life (minimum operations per section)	5 million
Repeatability (typical after 1 million operations)	\pm 0.03 dB to 18 GHz \pm 0.05 dB to 26.5 GHz \pm 0.08 dB to 40 GHz

Insertion loss (maximum)

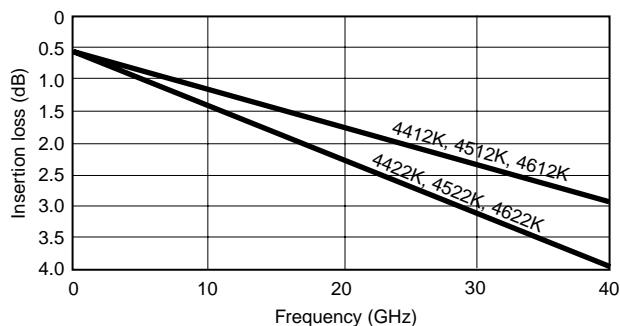

Impedance match

Frequency (GHz)	Return loss (dB)	SWR
DC to 8	19	1.25
>8 to 12	14	1.5
>12 to 20	12.7	1.6
>20 to 26.5	11	1.8
>26.5 to 40	9	2.1

Mechanical

Weight	4412K, 4512K, 4612K: 170g 4422K, 4522K, 4622K: 213g
Mounting position	Any
RF connectors	K Connectors, female, in-line
Programming connector	14 pin DIP
Programming cable length	406 mm

Environment

Temperature	Operating:	0C to +70C
	Non-operating:	-55C to +85C
Altitude	Operating:	4.6 km (440 mm Hg)
	Non-operating:	15 km
Shock	Operating:	10g, 6 ms, on 6 sides, 3 blows
	Non-operating:	500g, 1.8 ms, in 6 directions
Humidity	0 to 95% relative humidity	
EMC	Mil-Std-461, Method RE02, VDE 0871, CISPR#2	

Ordering information

Please specify model/order number, name, and quantity when ordering.

Model/Order No.	Name
4412K	Step Attenuator, DC to 20 GHz, 70 dB
4512K	Step Attenuator, DC to 26.5 GHz, 70 dB
4612K	Step Attenuator, DC to 40 GHz, 70 dB
4422K	Step Attenuator, DC to 20 GHz, 110 dB
4522K	Step Attenuator, DC to 26.5 GHz, 110 dB
4622K	Step Attenuator, DC to 40 GHz, 110 dB
Options	
Option C*	Calibration Data (4412K, 4512K, 4612K)

*Calibration data is taken every 100 MHz from DC to 900 MHz and every 500 MHz from 1 GHz to 40 GHz.

SWR BRIDGES

87 Series 2 to 18 GHz



The 87 Series SWR Bridges are precision, high directivity measurement components, ideal for SWR and return loss measurements. Models include a built-in termination, and they are provided with an overall accuracy equation. These SWR bridges can be used for making very low-level SWR measurements by amplifying the RF output prior to detection. Since both the phase and amplitude of the reflected signal are preserved in the RF output, these components can also be used to make accurate phase comparisons in a network analyzer system.

Features

- Broadband 2 to 18 GHz frequency range
- High 38 dB directivity
- Precise GPC-7 test port connector
- Built-in reference termination

Specifications

Model	Directivity (dB)	Accuracy ^①		
		2 to 3 GHz	3 to 4 GHz	4 to 18 GHz
87A50	35	$0.018 + 0.32\rho^2$	$0.018 + 0.23\rho^2$	$0.018 + 0.015\rho^2$
87A50-1	38	$0.013 + 0.32\rho^2$	$0.013 + 0.23\rho^2$	$0.013 + 0.015\rho^2$

Frequency range	2 to 18 GHz
Insertion loss	6.5 dB nominal ^②
Maximum input power	0.5W
Test port connector	GPC-7
Input and output connector	Type N(f)
Dimensions	7.3 x 5.2 x 2.9 cm plus connectors
Weight	340g

① Where ρ is the measured reflection coefficient.

② Typically 9 dB at 18 GHz from input to test port.

Ordering information

Please specify model/order number, name, and quantity when ordering.

Model/Order No.	Name
87A50	SWR Bridge, 2 to 18 GHz, GPC-7, 35 dB directivity
87A50-1	SWR Bridge, 2 to 18 GHz, GPC-7, 38 dB directivity

Temperature range: +25°C ±5°C

SWR AUTOTESTERS

97 Series and 560-97, 560-98 Series 10 MHz to 50 GHz



The Series 97, 560-97 and 560-98 SWR Autotesters integrate a high directivity bridge, a detector, a low reflection test port, and a precision reference termination. The 560-97 and -98 Series units are broadband microwave measurement components that are used with the Model 56100A Scalar Network Analyzer and with Series 54100A Scalar Measurement System for making fixed-frequency and swept-frequency return loss (SWR) measurements. Return loss measurements are used over a wide range of radio and microwave frequencies to check the performance of systems, subsystems, and microwave components such as amplifiers, directional couplers, attenuators, filters, splitters, and terminations.

560-97, 98 Series SWR autotester features

- Up to 40 dB directivity
- 10 MHz to 50 GHz range
- Test port connectors to fit most measurement applications; avoids use of adapters

97 Series SWR autotester features

- High 40 dB directivity
- Low test port reflections
- Broadband 10 MHz to 18 GHz frequency range
- Small package including bridges, termination, and detector
- Selection of GPC-7, WSMA, or Type N test port connectors

Specifications

Models	Directivity (dB)	Accuracy ^①		Frequency Sensitivity (dB)	Test Port Connection	Physical	
97 Series SWR Autotesters, 10 MHz to 18 GHz ^②							
97A50	36	10 MHz-8 GHz	8-18 GHz	±1.5 max.	GPC-7	Dimensions ^③ 7.6 x 5 x 2.8 cm plus connectors Weight: 340 g	
		0.016 ±0.06ρ ²	0.016 ±0.10ρ ²				
560-97 Series SWR Autotesters, 10 MHz to 18 GHz ^②							
560-97A50	36	0.01-8 GHz	8-18 GHz	±1.2	GPC-7		
		0.013 ±0.08ρ ²	0.016 ±0.10ρ ²				
560-97A50-1	40	0.010 ±0.06ρ ²	0.010 ±0.10ρ ²	±1.2	GPC-7		
560-97N50 560-97NF50	35	0.018 ±0.08ρ ²	0.018 ±0.12ρ ²	±1.5	Type N (m) Type N (f)		
560-97N50-1 560-97NF50-1	38	0.013 ±0.08ρ ²	0.013 ±0.12ρ ²	±1.5	Type N (m) Type N (f)		

① Where ρ is the reflection coefficient being measured. Accuracy includes the effects of test port reflections and directivity.

② Input Connector: Type N Female

③ Plus connectors and cable

Temperature range: +25°C ±5°C

Continued on next page

SWR AUTOTESTERS

97 Series and 560-97, 560-98 Series 10 MHz to 50 GHz

Models	Directivity (dB)	Accuracy ^①				Freq. Sensitivity (dB)	Test Port Connection	Physical
560-98 Series SWR Autotesters, 10 MHz to 40 GHz ^②								
560-98S50 560-98SF50	37 36	0.01-8 GHz	8-18 GHz 0.014 ±0.01ρ ²	18-26.5 GHz 0.016 ±0.13ρ ²	26.5-40 GHz	±2.0	WSMA (m) WSMA (f)	Dimensions ^④ : 1.9 x 3.8 x 2.9 cm Weight: 198 g
560-98S50-1 560-98SF50-1	40 38	0.010 ±0.07ρ ²	0.010 ±0.01ρ ²	0.013 ±0.13ρ ²		±2.0	WSMA (m) WSMA (f)	
560-98K50 560-98KF50	35 32 30	0.018 ±0.07ρ ²	0.018 ±0.07ρ ²	0.026 ±0.15ρ ²	0.032 ±0.18ρ ²	±3.0	Type K (m) Type K (f)	
560-98 Series SWR Autotesters, 10 MHz to 50 GHz ^③								
560-98VA50 560-98VFA50	30	0.01-50 GHz 0.032 ±0.11ρ ²				±4.0	Type V (m) Type V (f)	Dimensions ^④ : 2.2 x 6.6 x 5.3 cm Weight: 198 g
560-97, 560-98 Offset SWR autotesters, 10 MHz to 40 GHz								
560-97A50-20	20	500 MHz-18 GHz^⑤ 0.0015				±2.5	GPC-7	Dimensions ^④ : 7.6 x 5.1 x 2.8 cm Weight: 340 g
560-98KF50-15	15	800 MHz-40 GHz^⑥ 0.0100				±4.0	Type K (m)	Dimensions ^④ : 2.2 x 6.6 x 5.3 cm Weight: 198 g

All Models:

Input Port Impedance: 50Ω

Insertion Loss (from input to test port): 6.5 dB nominal

Detector Output Polarity: Negative

Output Time Constant: 2 ms

Maximum Power Input: 0.5 watts (+27 dBm) (560-98C50A: +24 dBm)

Cable Length: 122 cm (4 ft.)

① Where ρ is the reflection coefficient being measured. Accuracy includes the effects of test port reflections and directivity.

② Input Connector: Ruggedized Type K Female

③ Input Connector: Ruggedized Type V Female

④ Plus connectors and cable

⑤ When used with 18A50 Airline

⑥ When used with 19K50 Airline

Ordering information

Please specify model/order number, name, and quantity when ordering.

Model/Order No.	Name
	SWR Autotester
97A50	10 MHz to 18 GHz, GPC-7, 36 dB directivity
560-97A50	10 MHz to 18 GHz, GPC-7, 50 Ω, 36 dB directivity
560-97A50-1	10 MHz to 18 GHz, GPC-7, 50 Ω, 40 dB directivity
560-97N50	10 MHz to 18 GHz, N(m), 50 Ω, 35 dB directivity
560-97N50-1	10 MHz to 18 GHz, N(m), 50 Ω, 38 dB directivity
560-97NF50	10 MHz to 18 GHz, N(f), 50 Ω, 35 dB directivity
560-97NF50-1	10 MHz to 18 GHz, N(f), 50 Ω, 38 dB directivity

Model/Order No.	Name
	SWR Autotester
560-98S50	10 MHz-26.5 GHz, WSMA(m), 50 Ω, directivity = 37 dB (<18 GHz), 36 dB (18 GHz)
560-98S50-1	10 MHz-26.5 GHz, WSMA(m), 50 Ω, directivity = 40 dB (<18 GHz), 38 dB (18 GHz)
560-98SF50	10 MHz-26.5 GHz, WSMA(f), 50 Ω, directivity = 37 dB (<18 GHz), 36 dB (18 GHz)
560-98SF50-1	10 MHz-26.5 GHz, WSMA(f), 50 Ω, directivity = 40 dB (<18 GHz), 38 dB (18 GHz)
560-98K50	10 MHz-40 GHz, K(m), 50 Ω, directivity = 35 dB (<18 GHz), 32 dB (18 to 26.5 GHz), 30 dB (26.5 GHz)
560-98KF50	10 MHz-40 GHz, K(f), 50 Ω, directivity = 35 dB (<18 GHz), 32 dB (18 to 26.5 GHz), 30 dB (26.5 GHz)
560-98VA50	10 MHz-50 GHz, V(m), 50 Ω, directivity = 36 dB (<20 GHz), 30 dB (20 GHz)
560-98VFA50	10 MHz-50 GHz, V(m), 50 Ω, directivity = 36 dB (<20 GHz), 30 dB (20 GHz)
	Offset SWR Autotester
560-97A50-20	10 MHz to 18 GHz, GPC-7, 20 dB offset reference in bridge
560-98KF50-15	10 MHz to 40 GHz, K(f), 15 dB offset reference in bridge

SWR AUTOTESTERS

5400-6 Series 1 MHz to 3000 MHz



5400-6N50



5400-6NF50

The 5400-6 Series SWR Autotesters integrate a high directivity bridge, a detector, a low reflection test port, a precision reference termination, and a connecting cable. They are used with the Model 56100A Scalar Network Analyzers and with Series 54100A Scalar Measurement Systems for making fixed-frequency and swept-frequency return loss (SWR) measurements. Return loss measurements are used over a wide range of radio and microwave frequencies to check the performance of systems, subsystems, and microwave components such as amplifiers, directional couplers, attenuators, filters, splitters, and terminations.

Features

- 40 dB directivity.
- 1 MHz to 3000 MHz range
- F, N, or BNC type test port connectors

Specifications

Models	Directivity (dB)	Accuracy ^①			Test Port Connection	Physical
		10-1000 MHz	1000-3000 MHz	2000-3000 MHz		
5400-67FF75 ^{②④}	40	0.010 ±0.01ρ ²			F (f)	Dimensions ^⑤ : 2.5 x 5.1 x 7.0 cm Weight: 255 g
5400-6B50B ^③ 5400-6BF50B ^③	40	0.010 ±0.01ρ ²			BNC (m) BNC (f)	
5400-6B75B ^{③⑤} 5400-6BF75B ^{③⑤}	40	0.010 ±0.10ρ ²			BNC (m) BNC (f)	
5400-6N50 ^③ 5400-6NF50 ^③	40	1-1000 MHz 0.010 ±0.05ρ ²	1000-3000 MHz 0.010 ±0.05ρ ²	2000-3000 MHz 0.010 ±0.05ρ ²	Type N (m) Type N (f)	
5400-6N75 ^{③⑤} 5400-6NF75 ^{③⑤}	40	0.010 ±0.05ρ ²	0.010 ±0.05ρ ²	0.010 ±0.05ρ ²	Type N (m) Type N (f)	

All Models:

Input Port Impedance: 50Ω (Except as Noted)

Insertion Loss (from input to test port): 6.5 dB nominal

Detector Output Polarity: Negative

Output Time Constant: 2 ms

Maximum Power Input: 0.5 watts (+27 dBm)

Cable Length: 122 cm (4 ft.)

^① Where ρ is the reflection coefficient being measured. Accuracy includes the effects of test port reflections and directivity.

^② Input Connector: BNC Female

^③ Input Connector: Type N Female

^④ Plus connectors and cable

^⑤ Impedance 75Ω

Temperature range: +25°C ±5°C

Ordering information

Please specify model/order number, name, and quantity when ordering.

Model/Order No.	Name
	SWR Autotester
5400-6N50	1 to 3000 MHz, Type N(m), 50 Ω 40 dB Directivity
5400-6N75	1 to 3000 MHz, Type N(m), 75 Ω
5400-6NF50	1 to 3000 MHz, Type N(f), 50 Ω
5400-6NF75	1 to 3000 MHz, Type N(f), 75 Ω

CONVERTIBLE SWR AUTOTESTER

560-98C50A and Test Port Heads 10 MHz to 40 GHz

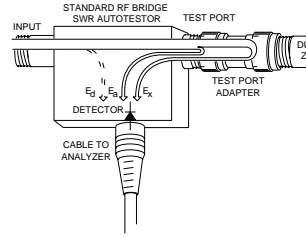
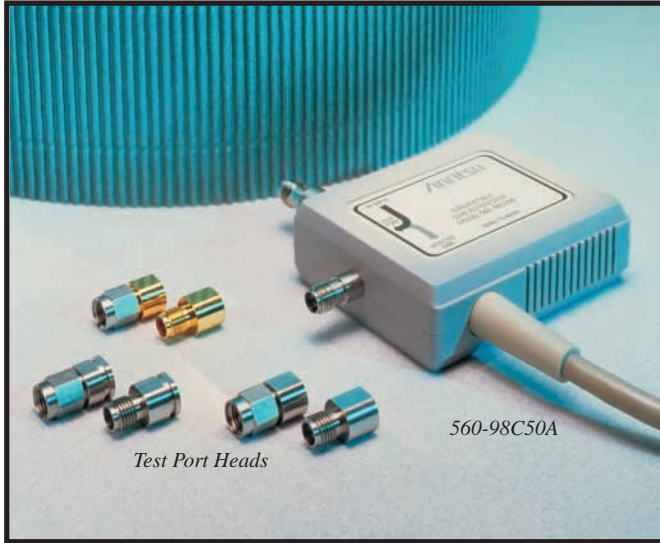

A test port adapter on a standard SWR Autotester or RF Bridge creates an error vector E_a in addition to directivity, E_d .

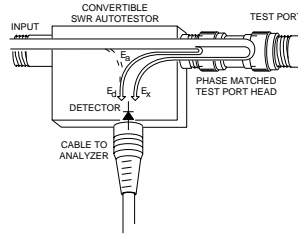

The directivity response of a Convertible SWR Autotester is tuned to cancel the vector reflection response of the phase-matched test port heads.

Convertible SWR Autotesters reduce capital equipment and maintenance costs. A single Convertible SWR Autotester accurately measures the Return Loss or SWR of devices with SMA, 3.5 mm, or K Connector®. Six interchangeable test port heads (male and female for each connector standard) are precision tuned to the Convertible SWR Autotester's internal bridge circuit.

The inexpensive test port heads save repair and calibration costs, because they are interchangeable. Repetitive connect/disconnect cycles will eventually wear out test port connectors — especially when excess torque is applied or the connector's mating surfaces are rotated against each other.

It is common practice today to avoid the subsequent maintenance cost by using adapters or "Connector Savers" on the test port of the directional device (RF Bridge, SWR Autotester, or Directional Coupler). Unfortunately, the adapters attached to a standard RF Bridge cause accuracy problems. Directional devices are tuned for optimum directivity at a specific phase reference point — this position is called the reference plane. Any test port adapter will degrade the effective directivity. The Convertible SWR Autotester's interchangeable test port heads eliminate the accuracy problem.

Adapter errors

In a standard RF bridge, measurement error increases when adapters or connector savers are used 1) to change the connector's sex and/or 2) to protect the test port from physical wear. The error effect is represented as a reduction to directivity. Effective Directivity is a measurement error term consisting of the directional device's directivity plus the SWR response of the test port adapter/connector saver.

Effective-Directivity is illustrated in the following illustration. The Directivity Error, E_d , is caused by deviations from ideal within the directional device. The adapter's SWR is represented by E_a . Both E_d and E_a cause errors in the measurement of DUT's return loss, E_x . This error problem is compounded by production practices which use poor quality adapters and neglect calibration/verification cycles.

Accuracy improvement

The Convertible SWR Autotester improves the accuracy of SMA device tests. It is common practice to test SMA devices with either 3.5 mm or K test ports. The 3.5 mm and K Connector® standards offer rugged, instrument grade connections, but they are not designed for proper impedance match to a device that has SMA connectors. SMA, K, and 3.5 mm connectors are mechanically compatible, but lack electrical compatibility. The resulting connector mismatch causes a 10 to 15 dB degradation in measurement directivity.

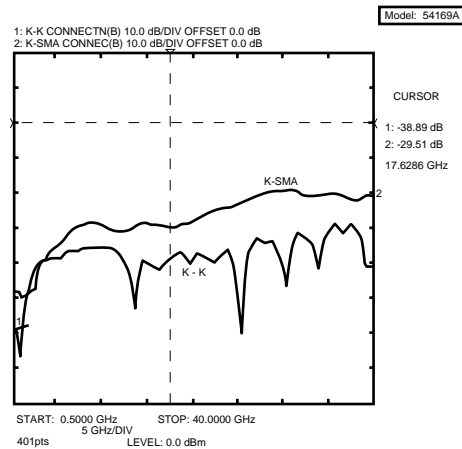

The Directivity of a K - K connector interface is far superior to a mismatched K - SMA connection

The above graph illustrates the degradation to directivity when a K Connector® test port is used to measure a precision SMA device. A 3.5 mm interface causes similar errors. The directivity was measured using the precision return loss mode on a 54100A Series Network Analyzer.

CONVERTIBLE SWR AUTOTESTER

560-98C50A and Test Port Heads 10 MHz to 40 GHz

K - SMA or 3.5 mm - SMA interfaces.

Electrically, the convertible SWR Autotester provides a nearly perfect 50 Ω interface when connected to SMA devices – resulting in a typical 10 dB improvement in effective directivity performance as compared to other SMA compatible connectors.

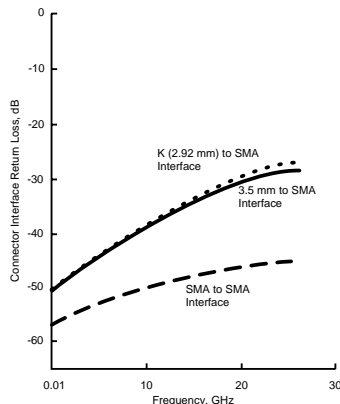

The Convertible SWR Autotester with SMA Test Port Head provides significantly better directivity performance than test components with either K (2.92 mm) or 3.5 mm test port connectors.

SMA connections to either K (2.92 mm) or 3.5 mm connectors are inherently capacitive. Both K and 3.5 mm connectors use air dielectric. The Teflon® or foam polyethylene dielectric common to SMA connectors have different dielectric constants than air. Thus, the coaxial dimensions of the center and outer conductors must also be different to maintain a 50 Ω transmission line impedance. Since the K and 3.5 mm connector standards specify flush pin depths, a non-50 Ω capacitance develops between their relatively thick outer conductors to the center pin of an SMA connected device.

Anritsu's 25S50 and 25SF50 SMA Test Port Heads include an inductive connection to SMA connectors by virtue of a slight air gap at the center pin interface. The air gap negates excess capacitance caused by the 50 Ω dimensional transition from the test port head's air dielectric to the SMA connector's Teflon® dielectric.

SMA connectors are not used as a precision instrumentation connector for three important reasons. First, the dielectric tends to expand and contract slightly with temperature and humidity conditions; thus, it is difficult to adhere to dimensional standards traceability (typically, precision air lines are used as primary or secondary reference standards) over a reasonable range of manufacturing floor conditions. Second, as an inexpensive connector type, many manufacturers have taken liberties in the specification of dimensions, tolerances, dielectric types and metallurgic content. A precision standard for SMA connector design is not recognized by the microwave industry. Finally, SMA designs suffer from reliability problems when subjected to multiple connections. Center pins can back out easily and the thin outer conductor wall is easily crushed when subjected to excessive torque.

The Convertible SWR Autotester solves these problems. Air dielectric is used to eliminate the temperature and humidity variations suffered by Teflon® and other dielectrics. Dimensional tolerances and metallic composition are clearly specified in the product design and center pin dimensions are phase matched. Air dielectric also allows use of thicker outer conductors, drastically decreasing potential deformation from excessive torque.

The Convertible SWR Autotester reduces maintenance costs without using error prone test port adapters or connector savers.

Accuracy for SMA device test is also improved because the test port head is properly compensated for operation with standard SMA connector dimensions.

Specifications

Frequency Range	0.01 to 40 GHz
Directivity	> 34 dB 0.01 to 20 GHz > 32 dB 20.0 to 26.5 GHz > 29 dB 26.5 to 40.0 GHz
Test Port Match	> 21 dB 0.01 to 20.0 GHz > 18 dB 20.0 to 40.0 GHz
Maximum Input Power	+ 27 dBm
Source Input to Test Port Isolation	7.0 dB to 9.0 dB nominal insertion loss, frequency dependent.
Impedance	50 Ω
Input Connector	K(f), 2.92 mm with ruggedized threads
Compatibility	The 560-98C50 is compatible with the 560, 560A, 561, 5400A, 56100A, 562, 54100A and 54000A analyzers.
Dimensions	Autotester: 7.3 cm x 5.3 cm x 2.3 cm Test Port Heads: 16 mm(L) x 9 mm (dia.)

Temperature range: +25°C ±5°C

Ordering information

Please specify model/order number, name, and quantity when ordering.

Model/Order No.	Name
560-98C50A*	Convertible SWR Autotester
	Open/Shorts
22K50	Male Open/Short, (Included with 560-98C50A purchase.)
22KF50	Female Open/Short, (Not included with 560-98C50A purchase.)
	Test Port Heads
25S50	Precision Matched WSMA male
25SF50	Precision Matched WSMA female
25L50	Precision Matched 3.5 mm male
25LF50	Precision Matched 3.5 mm female
25K50	Precision Matched K male
25KF50	Precision Matched K female
25SKF50	Precision Matched Set, WSMA male & female, K male & female
25SLF50	Precision Matched Set, WSMA male & female, 3.5 mm male & female, K Connector male & female

*The Convertible SWR Autotester must be used with a test head.

AIRLINES

18, 19 Series 2 to 40 GHz



The 18 and 19 Series Precision Airlines are the most accurate impedance standards available today, and they are the recognized traceability path for impedance at high frequencies. Anritsu airlines are a critical component when measuring accurate impedances, enabling measurements down to 1.006 SWR to 18 GHz, 1.01 SWR to 26.5 GHz, and 1.02 SWR to 40 GHz.

A beadless connector is used at the measurement end to provide a minimum reflection connection. The other end is beaded to keep the center conductor captive, thus fixing the reference plane at the beadless end.

Features

- *Plating is gold over nickel*
- *Provide impedance traceability to NIST*
- *Enable measurements down to 1.006 SWR to 18 GHz, 1.01 SWR to 26.5 GHz, and 1.02 SWR to 40 GHz*

Specifications

Model	Frequency range (GHz)	Test port connector	Beaded port connector	SWR (test port)	Dimensions L(cm) x dia(cm)
18A50	0.5 to 18	GPC-7	GPC-7	1.003	30 x 0.7
18N50 18NF50	0.5 to 18	N(m) N(f)	GPC-7	1.006	30 x 0.7
19S50 19SF50	0.8 to 26.5	WSMA(m) WSMA(f)	WSMA(m)	1.006 to 18 GHz 1.010 to 26.5 GHz	25 x 0.35
19K50 19KF50	0.8 to 40	K(m) K(f)	K(m)	1.020	15 x 0.29

Temperature range: +25°C ±5°C

Ordering information

Please specify model/order number, name, and quantity when ordering.

Model/Order No.	Name
	Precision Air Line
18A50	0.5 to 18 GHz, 50 Ω, GPC-7
18N50	0.5 to 18 GHz, 50 Ω, N (m)
18NF50	0.5 to 18 GHz, 50 Ω, N (f)
19K50	0.8 to 40 GHz, 50 Ω, K(m)
19KF50	0.8 to 40 GHz, 50 Ω, K(f)
19S50	0.8 to 26.5 GHz, 50 Ω
19SF50	0.8 to 26.5 GHz, 50 Ω

OPEN/SHORTS

22 Series DC to 50 GHz



22K50



22KF50

The 22 Series Open/Shorts are used on the test port of an SWR Autotester or SWR bridge to establish a full reflection reference for accurate SWR measurements. When used with scalar network analyzers, the open and short reflections over a swept frequency range can be automatically averaged to enhance measurement accuracy. All models consist of an open on one end and a short on the other.

Features

- Single Gold Plated Component providing full open and short reflections for accurate SWR measurements
- DC to 50 GHz frequency coverage
- GPC-7, Type N, WSMA, K Connectors® and V Connectors®
- 50 Ω or 75 Ω impedance

Specifications

Model	Frequency range (GHz)	Test port connector	Characteristic impedance (Ω)	Dimensions L(cm) x dia(cm)
22N75 22NF75	DC to 2	N(m) N(f)	75	6.3 x 1.8 4.9 x 1.6
22N50 22NF50	DC to 18	N(m) N(f)	50	6.3 x 1.8 4.9 x 1.6
22A50	DC to 18	GPC-7	50	3.8 x 1.6
22S50 22SF50	DC to 26.5	WSMA(m) WSMA(f)	50	4.2 x 0.8 3.5 x 0.8
22K50 22KF50	DC to 40	K(m) K(f)	50	4.2 x 0.8 3.5 x 0.8
22V50 22VF50	DC to 50	V(m) V(f)	50	3.6 x 0.8 2.8 x 0.8

Temperature range: +25°C ±5°C

Ordering information

Please specify model/order number, name, and quantity when ordering.

Model/Order No.	Name
	Open/Short
22N50	DC to 18 GHz, N(m), 50 Ω
22NF50	DC to 18 GHz, N(f), 50 Ω
22N75	DC to 3 GHz, N(m), 75 Ω
22NF75	DC to 3 GHz, N(f), 75 Ω
22A50	DC to 18 GHz, GPC-7 connector, 50 Ω
22K50	DC to 40 GHz, K(m), 50 Ω
22KF50	DC to 40 GHz, K(f), 50 Ω
22S50	DC to 26.5 GHz, WSMA(m), 50 Ω
22SF50	DC to 26.5 GHz, WSMA(f), 50 Ω
22V50	DC to 50 GHz, V(m), 50 Ω
22VF50	DC to 50 GHz, V(f), 50 Ω

OPEN/SHORTS/LOADS

OSL Series DC to 4 GHz



The OSL series open/short/load are used on the test port of the Site Master™ Series of handheld instruments to establish a reference for accurate measurement. When used with a Site Master, the open/short and load reflection over a swept frequency range can be automatically averaged to enhance measurement accuracy. OSL series Open/short/load comes in both N(Male) and N (Female) connector configuration and consist open on one end, short on other and Load on the tee section.

Features

- *Single Nickel Plated Component providing full open, short and load reflections for accurate measurements.*
- *DC to 4 GHz frequency coverage*
- *Type N(Male) and N(Female) connector configuration*
- *50 Ω Impedance*

Specifications

Model	Frequency range (GHz)	Test port connector	Characteristic impedance (Ω)
OSLN50LF	DC to 4	N(m)	50
OSLNF50LF	DC to 4	N(f)	50

Temperature range: +25°C ±5°C

Ordering information

Please specify model/order number, name, and quantity when ordering.

Model/Order No.	Name
	Open/Short/Load
OSLN50LF	DC to 4 GHz, N(m), 50 Ω
OSLNF50LF	DC to 4 GHz, N(f), 50 Ω

MICROWAVE DETECTORS

70, 75 Series 100 kHz to 50 GHz

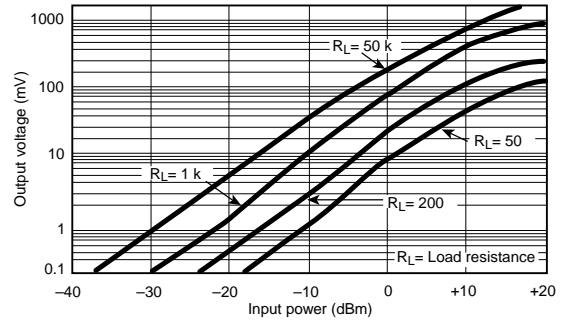

Typical sensitivity

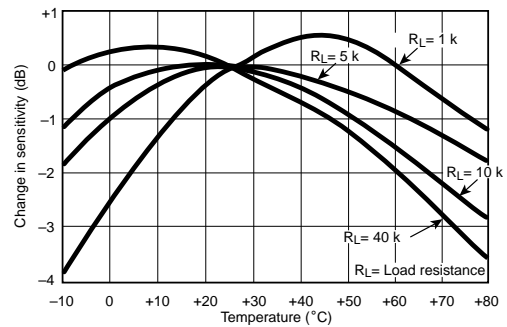

Typical sensitivity change

Within the 70 or 75 Series product lines, you will find a model that matches your needs for instrumentation, system, or OEM applications. By using the latest design and microelectronics production technologies, Anritsu low-barrier Schottky-diode detectors outperform others and offer significant cost savings. Input connector types include Type N, and K Connector® (compatible with SMA and 3.5 mm), and V Connector® (compatible with 2.4 mm). In addition to frequency coverage and price, these detectors are distinguished by their low SWR, flat frequency response, and close output-voltage tracking over a wide dynamic range.

Features

- Broadband coverage, 10 MHz to 50 GHz with a Single Detector
- K Connector® compatible with SMA and 3.5 mm
- V Connector® compatible with 2.4 mm
- Lowest SWR: 1.33 to 20 GHz, 1.5 to 40 GHz
- Flat Response: ± 0.5 dB to 20 GHz ± 1.5 dB to 40 GHz
- Best Value for Instrumentation, system, and OEM applications
- Low price and availability from stock

MICROWAVE DETECTORS

70, 75 Series 100 kHz to 50 GHz

Specifications

Model	Frequency range	Flatness (dB)	Connectors		Impedance (Ω)	SWR (Maximum)	Low level sensitivity at -30 dBm (mV/ μ W)	High level sensitivity at +13 dBm (Volts, Min.)	Input maximum (mW)	Output capacitance (pF)
			In	Out						
70KA50	0.01 to 20 GHz	± 0.6	K(m)	SMC(f)	50	1.33	0.6	1	100	30
70KC50	0.01 to 40 GHz	± 0.5 to 20 GHz ± 1.0 to 26.5 GHz ± 1.5 to 40 GHz	K(m)	SMC(f)	50	1.33 to 20 GHz 1.50 to 26.5 GHz 1.90 to 40 GHz	0.4	1	100	30
75N50B	0.01 to 18 GHz	± 0.3 to 12.4 GHz ± 0.6 to 18 GHz	N(m)	BNC(f)	50	1.15 to 4.5 GHz 1.30 to 15 GHz 1.39 to 18 GHz	0.35	1	100	30
75KC50	0.01 to 40 GHz	± 0.5 to 20 GHz ± 1.0 to 26.5 GHz ± 1.5 to 40 GHz	K(m)	BNC(f)	50	1.33 to 20 GHz 1.50 to 26.5 GHz 1.90 to 40 GHz	0.4	1	100	30
75VA50	0.01 to 50 GHz	± 0.5 to 20 GHz ± 1.0 to 26.5 GHz ± 1.5 to 40 GHz ± 3 to 50 GHz	V(m)	BNC(f)	50	1.33 to 20 GHz 1.50 to 26.5 GHz 1.90 to 40 GHz 2.1 to 50 GHz	0.4	1	100	30

Dimensions

Model	Dimensions L(cm) x dia(cm)
70KA50	4.6 x 1.0
70KC50	4.6 x 1.0
75N50B	6.4 x 1.8
75KC50	4.6 x 1.0
75VA50	4.6 x 1.0

Ordering information

Please specify model/order number, name, and quantity when ordering.

Model/Order No.	Name
	Microwave Detector
70KA50	10 MHz to 20 GHz, K(m) input, SMC(f) output, 50 Ω
70KC50	10 MHz to 40 GHz, K(m) input, SMC(f) output, 50 Ω
75KC50	10 MHz to 40 GHz, K(m) input, BNC(f) output, 50 Ω
75N50B	10 MHz to 18 GHz, N(m) input, BNC(f) output, 50 Ω
75VA50	10 MHz to 50 GHz, V(m) input, BNC(f) output, 50 Ω
	Options
Option 2 (75KC50)	Matching frequency response of two detectors
Option 3 (75KC50)	Matching frequency response of three detectors

* Upper frequency limit (GHz): $\leq 8, \leq 12.4, \leq 18, \leq 26.5, \leq 40$

** Frequency response tracking (dB): $\pm 0.2, \pm 0.3, \pm 0.6, \pm 0.8, \pm 1.2$

FIELD REPLACEMENT DIODE MODULE

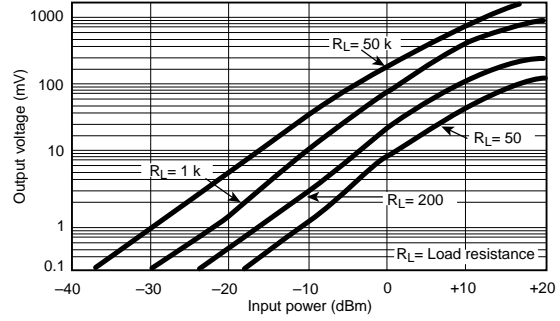

Typical sensitivity

Field replaceable diode modules provide field replacements for damaged diodes, virtually eliminating down time. To avoid all degradation in performance when a diode is replaced in the field, all replacement modules include the thin-film matching circuit. Performance after replacement cannot be distinguished from that of a new detector.

Ordering information

Please specify model/order number, name, and quantity when ordering.

Model/Order No.	Name
	Diode module
10-108	71 & 73 Series
10-75	75A50
A16176	70K Series (≥ 20 GHz) and 75K Series (≥ 20 GHz)
A16177	70K Series (≤ 20 GHz) and 75K Series (≤ 20 GHz)
A18735	74N50B
B16132	75N50B

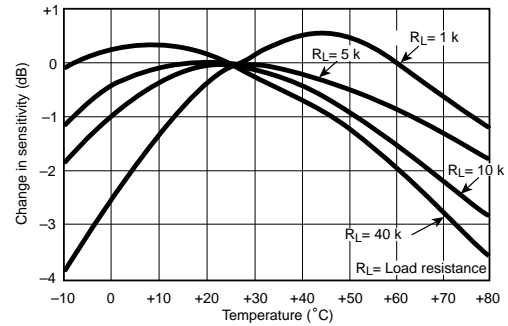

Typical sensitivity change

MICROWAVE DETECTORS

5400-71, 560-7 Series 1 MHz to 50 GHz



The Anritsu 560-7 and 5400-71 Series RF Detectors are used with the Model 56100A Scalar Network Analyzer and with Series 54100A Scalar Measurement System for making coaxial transmission loss or gain and power measurements. They are also used with the Site Master® and Cable Mate® Series Personal SWR/RL and Fault Location Testers for making power measurements.

Features

- Zero-biased Schottky diodes
- -55 dBm to +16 dBm range

Ordering information

Please specify model/order number, name, and quantity when ordering.

Model/Order No.	Name
	Microwave Detector
5400-71N50	1 to 3000 MHz, N(m), 50 Ω
5400-71N75	1 MHz to 3 GHz, N(m), 75 Ω
5400-71N75L	0.005 to 1.2 GHz, N(m), 75 Ω
560-7A50	10 MHz to 18 GHz, GPC-7, 50 Ω
560-7K50	10 MHz to 40 GHz, K(m), 50 Ω
560-7N50B	10 MHz to 20 GHz, N(m), 50 Ω
560-7S50-2	10 MHz to 26.5 GHz, WSMA(m), 50 Ω
560-7S50B	10 MHz to 20 GHz, WSMA(m), 50 Ω
560-7VA50	10 MHz to 50 GHz, V(m), 50 Ω

Temperature range: 0°C to +70°C

Specifications*

Model	Frequency range	Impedance	Return loss	Input connector	Frequency response
5400-71N50	0.001 to 3 GHz	50 Ω	26 dB	N(m)	±0.2 dB, <1 GHz ±0.3 dB, <3 GHz
5400-71N75	0.001 to 3 GHz	75 Ω	26 dB, <2 GHz 20 dB, <3 GHz	N(m)	±0.2 dB, <1 GHz ±0.5 dB, <3 GHz
5400-71N75L**	0.005 to 1.2 GHz	75 Ω	24 dB	N(m)	±0.2 dB, <1 GHz ±0.5 dB, <1.2 GHz
560-7A50	0.01 to 18 GHz	50 Ω	15 dB, <0.04 GHz 22 dB, <8 GHz 17 dB, <18 GHz	GPC-7	±0.5 dB, 18 GHz
560-7N50B	0.01 to 20 GHz	50 Ω	15 dB, <0.04 GHz 22 dB, <8 GHz 17 dB, <18 GHz 14 dB, <20 GHz	N(m)	±0.5 dB, <18 GHz ±1.25 dB, <20 GHz
560-7S50B	0.01 to 20 GHz	50 Ω	15 dB, <0.04 GHz 22 dB, <8 GHz 17 dB, <18 GHz 14 dB, <20 GHz	WSMA(m)	±0.5 dB, <18 GHz ±1.25 dB, <20 GHz
560-7S50-2	0.01 to 26.5 GHz	50 Ω	15 dB, <0.04 GHz 22 dB, <8 GHz 17 dB, <18 GHz 14 dB, <26.5 GHz	WSMA(m)	±0.5 dB, <18 GHz ±1.25 dB, <26.5 GHz
560-7K50	0.01 to 40 GHz	50 Ω	12 dB, <0.04 GHz 22 dB, <8 GHz 17 dB, <18 GHz 15 dB, <26.5 GHz 14 dB, <32 GHz 13 dB, <40 GHz	K(m)	±0.5 dB, <18 GHz ±1.25 dB, <26.5 GHz ±2.2 dB, <32 GHz ±2.5 dB, <40 GHz
560-7VA50	0.01 to 50 GHz	50 Ω	12 dB, <0.04 GHz 19 dB, <20 GHz 15 dB, <40 GHz 10 dB, <50 GHz	V(m)	±0.8 dB, <20 GHz ±2.5 dB, <40 GHz ±3.0 dB, <50 GHz

*The maximum input power is +20 dBm for all microwave detectors with the exception of 5400-71N75L.

**The input of the 5400-71N75L is designed to extend the damage level to 1W (+30 dBm).
Compression begins at 10 dBm <0.05 GHz, 15 dBm <1 GHz, or 20 dBm <1.2 GHz.

POWER SENSORS

MA2400A/D Series 10 MHz to 50 GHz



The MA24XXA/D Series Power Sensors consist of MA247XD Series Power Sensors, MA246XD Series Power Sensors, MA248XD Series Universal Power Sensors, MA242XD Series Thermal Power Sensors, MA244XD Series High Accuracy Power Sensors, MA249XA Series Wideband Power Sensors, and MA2411A Pulse Power Sensor. These units are broadband microwave measurement components. All models except the MA246XD Series, MA249XA Series, and MA2411A Power Sensors, are used with the ML2430A Series Power Meters. The MA246XD Series Power Sensors are used with the ML2400A Series Power Meters only. The MA249XA and MA2411A Power Sensors are used with the ML2480A Series Power Meters only.

Features

- 10 MHz to 50 GHz range
- N, K, and V type RF connectors
- 90 dB dynamic range provides stable power readings to -70 dBm
- MA244XD Series High Accuracy Power Sensors contain an additional matching circuit to improve return loss performance.
- MA242XD Series Thermal Power Sensors provide measuring speeds to 4 ms rise and fall times in addition to exceptional return loss performance
- MA246XD power sensors have fast 1 milli second rise and fall times needed for CDMA measurements
- MA248XD Universal sensors measure average power of modulated signals such as W-CDMA, multitone, etc.
- All MA2481D Series Power Sensors contain internal EEPROMs for storage of calibration data as a function of frequency, power, and temperature. This allows the power meter to interpolate and correct readings automatically
- MA2411A Pulse Power Sensor has a rise time of <18ns needed for pulse radar measurements
- MA249XA Series Wideband Power Sensors have a video bandwidth of 20 MHz for accurate Peak Measurement on Radar and WLAN. These are also ideal for Multi Pulse Radar or GPRS measurements.

Fast thermal sensors

Anritsu's thermal sensors provide excellent power measurement accuracy over 50 dB of dynamic range with more speed than any other thermal sensor available (see fig. 1). Thermal sensors use Seebeck elements where the combined effect of a thermal gradient and charge migration between dissimilar metals gives a true reading of average power on any incident waveform. Anritsu thermal sensors have class-leading SWR and built in EEPROM with calibration factor and linearity correction data. This results in assured accuracy when measuring any signal. Anritsu's fast thermal power sensors improve sensor rise time and fall time to less than 4.0ms— an order of magnitude faster than previous thermal sensors. Settled power measurements are now 10 times faster; that means reduced test time.

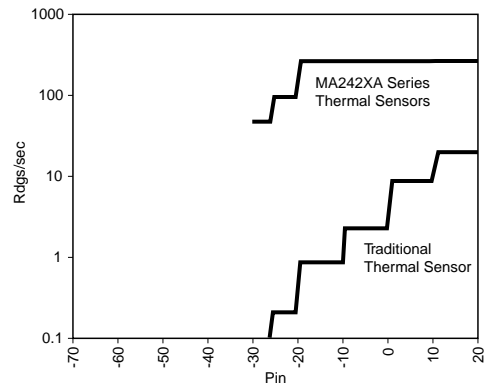

Fig. 1 Fast Thermal Sensors

Standard diode sensors

Diode sensors have greater speed, sensitivity and dynamic range than thermal sensors (see fig. 2). All Anritsu diode sensors use a dual diode architecture that gives improved sensitivity and dynamic range over single diode architectures. The MA2470D Series Power Sensors 90 dB dynamic range is both fast and accurate. Linearity is better than 1.8%, typically < 1.0% through 18 GHz.

MA2470D power sensors offer an ideal combination of speed and dynamic range for general purpose power measurements. A single sensor replaces the two sensors that were previously required with sensors limited to 50 dB dynamic range.

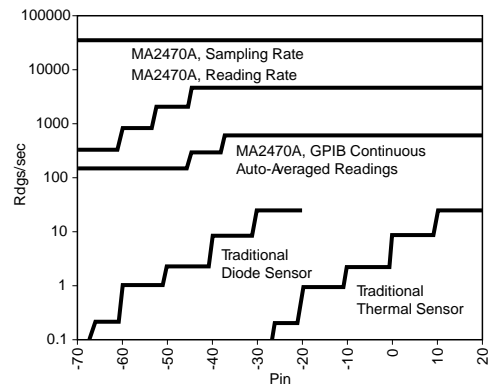

Fig. 2 Standard Diode Sensors

POWER SENSORS

MA2400A/D Series 10 MHz to 50 GHz

High accuracy diode sensors

The Anritsu MA2440D series high-accuracy diode sensors have a built in 3 dB attenuator to minimize input SWR. They are used where the best measurement accuracy is required over a large dynamic range, for example when measuring amplifiers. High accuracy diode sensors have a dynamic range of 87 dB compared to the 90 dB of standard diode sensors.

Fast diode sensors

The MA2460D fast diode sensors from Anritsu have a rise time of 0.6 μ s. This, together with a sensor video bandwidth of 1.25 MHz, makes them the ideal solution for power measurements on N-CDMA (IS-95) signals. The MA2460 sensors must be used with the ML2407/08A power meter. This combination of meter and sensor provides fast signal processing and sampling speeds. Average power, peak power and crest factor on N-CDMA signals can be measured and displayed. The MA2460 are dual diode sensors that deliver a greater-than 80 dB dynamic range, which makes them suitable for both open- and closed-loop power-control testing. The sensors internal AC detection circuitry gives a guaranteed noise floor of -60 dBm with typical performance to -70 dBm, even when measuring CDMA signals.

Pulses down to 1 μ s can also be captured and displayed, thanks to the sensor rise time of 0.6 μ s. In profile mode the ML2407A meter can be used to measure average power across narrow pulses, an increasingly common test method for amplifiers in digitally modulated systems.

Universal power sensors

The new MA2480D series Universal Power Sensors will measure any modulated or multi-tone signal, thanks to a patented sensor architecture with three diode pairs (see fig. 3). Universal power sensors deliver over 80 dB of dynamic range with speed and accuracy. Average power measurements on WCDMA signals

can now be made without the need for special power meters.

Universal sensors are also ideal for power measurements on other digitally modulated carriers such as HDTV, DAB or QAM modulated radio links.

Universal power sensors are also ideal for applications where multiple signals are present, such as intermodulation measurements and satellite multi carrier power loading measurements.

A unique additional capability of the Anritsu Universal power sensor is the ability to use it as a standard diode sensor for CW measurements. In this mode the fast response of diode sensors is maintained across the full dynamic range of the sensor, meaning that for the majority of users it is the only sensor that they will ever need – a truly Universal Power Sensor.

Wideband sensors

The new MA2490A and MA2491A sensors from Anritsu have rise time of 18 ns and are ideal for Radar, WLAN, Edge, and WCDMA applications. MA2490A and MA2491A are 8 GHz and 18 GHz sensors with 20 MHz video bandwidth. The sensor is equipped with a chopper circuit that allows it to measure CW/average power as low as -60 dBm. Both the sensors must be used with ML2487/88A Power Meters, specially designed to handle high-speed sampling rates up to 64MS/s.

Pulse sensor

The wideband sensor MA2411 is a 40 GHz diode sensor with 50 MHz video bandwidth. This sensor is not fitted with chopper circuit, and therefore mainly is a pulse-profiling sensor. A rise time of 7 ns along with 50 MHz video bandwidth, makes this sensor ideal for Radar applications. MA2411A Power Sensor can be used with ML2480 series Power Meters. However, the bandwidth of the sensor is limited only to 20 MHz, when using with ML2480 series power meter.

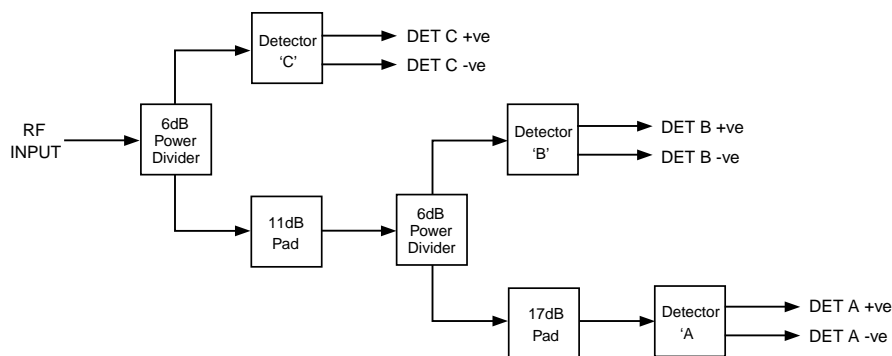

Fig. 3 Universal Power Sensor

POWER SENSORS

MA2400A/D Series 10 MHz to 50 GHz

Specifications

Model	Frequency range	Dynamic range (dBm)	SWR	Rise time ^①	Sensor linearity	RF connector ^②
Standard diode sensors						
MA2472D	10 MHz - 18 GHz	-70 to +20	<1.90; 10 - 50 MHz <1.17; 50 - 150 MHz <1.12; 0.15 - 2 GHz <1.22; 2 - 12.4 GHz <1.25; 12.4 - 18 GHz <1.35; 18 - 32 GHz <1.50; 32 - 40 GHz <1.63; 40 - 50 GHz	<0.004 ms	1.8%, <18 GHz 2.5%, <40 GHz 3.5%, <50 GHz	N (m)
MA2473D	10 MHz - 32 GHz					K (m)
MA2474D	10 MHz - 40 GHz					K (m)
MA2475D	10 MHz - 50 GHz					V (m)
Fast thermal sensors						
MA2421D	0.1 MHz - 18 GHz	-30 to +20	<1.10; 0.1 MHz - 2 GHz <1.15; 2 - 12.4 GHz <1.20; 12.4 - 18 GHz	<4.0 ms	1.3%, <18 GHz 1.5%, <40 GHz 1.8%, <50 GHz	N (m)
MA2422D	10 MHz - 18 GHz					N (m)
MA2423D	10 MHz - 32 GHz					K (m)
MA2424D	10 MHz - 40 GHz					K (m)
MA2425D	10 MHz - 50 GHz					V (m)
High accuracy diode sensors						
MA2442D	10 MHz - 18 GHz	-67 to +20	<1.90; 10 - 50 MHz <1.17; 50 - 150 MHz <1.08; 0.15 - 2 GHz <1.16; 2 - 12.4 GHz <1.21; 12.4 - 18 GHz <1.29; 18 - 32 GHz <1.44; 32 - 40 GHz <1.50; 40 - 50 GHz	<0.004 ms	1.8%, <18 GHz 2.5%, <40 GHz 3.5%, <50 GHz	N (m)
MA2444D	10 MHz - 40 GHz					K (m)
MA2445D	10 MHz - 50 GHz					V (m)
Fast diode sensors						
MA2468D ^③	10 MHz - 6 GHz	-60 to +20	<1.17; 10 - 150 MHz <1.12; 0.15 - 2 GHz <1.22; 2 - 12.4 GHz <1.25; 12.4 - 18 GHz	< 0.001 ms	1.8%	N (m)
MA2469D ^③	10 MHz - 18 GHz					
Universal power sensors						
MA2481D	10 MHz - 6 GHz	-60 to +20	< 1.17; 10 - 150 MHz < 1.12; 0.15 - 2 GHz < 1.22; 2 - 12.4 GHz < 1.25; 12.4 - 18 GHz	<0.0004 ms (with option 1 only)	10 MHz to 6 GHz 3% -60 to +20 dBm 6 to 18 GHz 3% to 18 GHz 3.5% 0 to +20 GHz 3% (1.8% CW with option 1)	N (m)
MA2482D	10 MHz - 18 GHz					
MA2480/01	Adds fast CW mode to Universal Power Sensors for high speed measurements of CW signal plus TDMA and pulse measurements.					
Wideband sensors						
MA2490A	50 MHz - 8 GHz	-60 to +20 CW Mode -20 to +20 Peak Pulse Mode	<1.17; 50 - 150 MHz <1.12; 0.15 - 2.5 GHz <1.22; 2.5 - 8 GHz	<18 ns	<7% 50 - 300 MHz <3.5% 0.3 - 8 GHz	N (m)
MA2491A	50 MHz - 18 GHz					
Pulse sensor						
MA2411A	300 MHz - 40 GHz	-20 to +20	<1.15; 0.3 - 2.5 GHz <1.35; 2.5 - 26 GHz <1.50; 26 - 40 GHz	<8 ns <18 ns when used with ML2487/8A	<4.5% 0.3 - 18 GHz <7% 18 - 40 GHz	K (m)

① 0.0 dBm, room temperature.

② Each MA24XXA/D series sensor incorporates precision RF connectors with hexagon coupling nut for attachment by industry standard torque wrench.

③ MA2460D Fast Diode Sensors must be used with ML2407/08A Power Meters for NCDMA and Fast Pulse measurements.

Temperature range: +25°C ±5°C

POWER SENSORS

MA2400A/D Series 10 MHz to 50 GHz

Ordering information

Please specify model/order number, name, and quantity when ordering.

Model/Order No.	Name
	Thermal Sensor
MA2421D	0.1 MHz to 18 GHz
MA2422D	10 MHz to 18 GHz
MA2423D	10 MHz to 32 GHz
MA2424D	10 MHz to 40 GHz
MA2425D	10 MHz to 50 GHz
	High Accuracy Sensor
MA2442D	10 MHz to 18 GHz
MA2444D	10 MHz to 40 GHz
MA2445D	10 MHz to 50 GHz
	Fast Diode Sensor
MA2468D	10 MHz to 6 GHz
MA2469D	10 MHz to 18 GHz

Model/Order No.	Name
	Power Sensor
MA2472D	10 MHz to 18 GHz
MA2473D	10 MHz to 32 GHz
MA2474D	10 MHz to 40 GHz
MA2475D	10 MHz to 50 GHz
MA2481D	Universal Power Sensor, 10 MHz to 6 GHz
MA2482D	Universal Power Sensor, 10 MHz to 18 GHz
MA2480/01	Option 1, Universal Power Sensor CW Option
MA2400/98	Z540/Guide 25 Calibration
MA2400/99	Premium Calibration
MA2497A	Agilent (HP) Sensor adapter
MA2499B	Anritsu Sensor 10 to 12 pin Adapter
	Wideband Sensor
MA2490A	50 MHz to 8 GHz
MA2491A	50 MHz to 18 GHz
	Pulse Sensor
MA2411A	300 MHz to 40 GHz

POWER DIVIDERS

11 Series DC to 3000 MHz

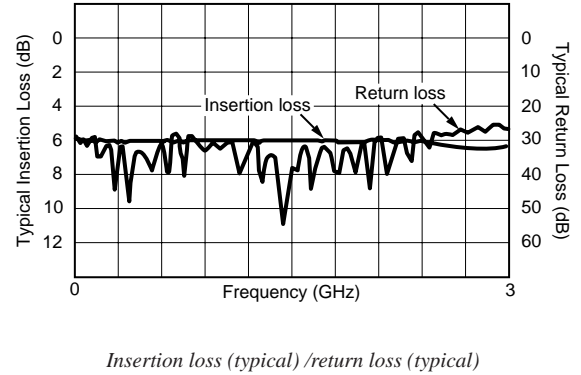

These RF power dividers are symmetrical, three-resistor tee designs that can be used in applications where signals from DC to 3000 MHz must be accurately divided. They are available in 50 Ω and provide excellent amplitude and phase tracking.

Features

- DC to 3000 MHz frequency range
- Excellent amplitude and phase tracking
- 50 Ω

Specifications

Model	Frequency range (MHz)	SWR	Insertion loss (dB, max.)	Impedance (Ω)	Connectors	
					Input	Output
11N50B	DC to 3000	<1.25	7	50	N(f)	N(f)

Maximum Input Power: 1 Watt
 Temperature range: 0°C to +70°C

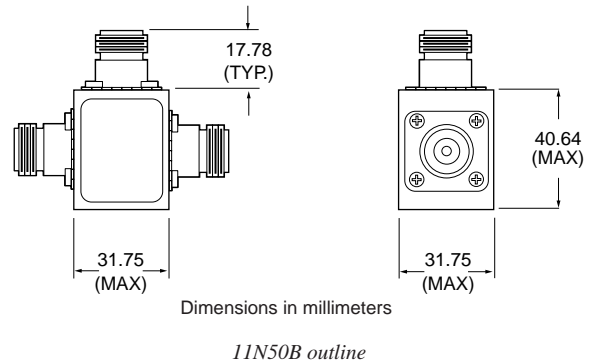

Ordering information

Please specify model/order number, name, and quantity when ordering.

Model/Order No.	Name
11N50B	Power Divider, 1 MHz to 3 GHz, 50 Ω

POWER DIVIDERS

K240, V240 Series DC to 65 GHz

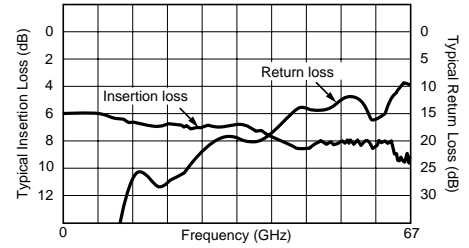

Insertion loss (typical) / return loss (typical) for V240C

These microwave power dividers are symmetrical, three-resistor tee designs that can be used in applications where signals from DC to 65 GHz must be accurately divided or combined. K Connector® is compatible with 3.5 mm and SMA; V Connector® is compatible with 2.4 mm. All models have exceptional amplitude and phase tracking characteristics.

Features

- DC to 65 GHz frequency range
- K Connector® compatibility with SMA/3.5 mm
- V Connector® compatibility with 2.4 mm
- Excellent amplitude and phase tracking

Specifications

Model	Frequency range (GHz)	Impedance (Ω)	Connectors
K240B	DC to 26.5	50	K(f)
K240C	DC to 40	50	K(f)
V240C	DC to 65	50	V(f)

Frequency range (GHz)	Tracking of outputs		Insertion loss (dB max.)	SWR
	Amplitude	Phase		
DC to 6	±0.3 dB	±2°	7	1.22
6 to 18	±0.3 dB	±3°	7.5	1.44
18 to 26.5	±0.6 dB	±4°	8	1.58
26.5 to 40	±0.6 dB	±6°	8.5	1.79
40 to 65	±1.8 dB	±18°	10	3.11

Maximum Input Power: 1W
 Temperature range: 0°C to +70°C
 Weight: 43g

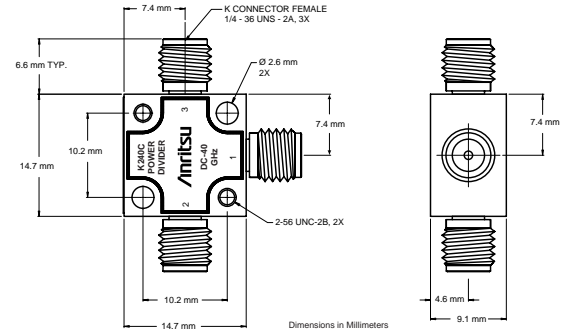

K240B, K240C outline

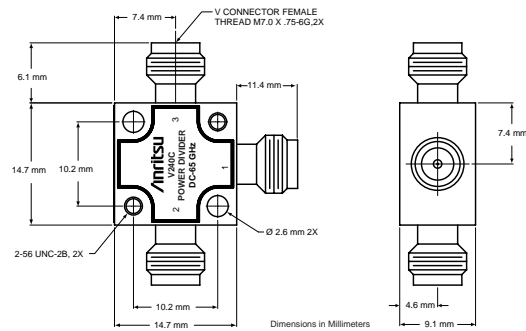

V240C outline

Ordering information

Please specify model/order number, name, and quantity when ordering.

Model/Order No.	Name
K240B	Precision Power Divider, DC to 26.5 GHz
K240C	Precision Power Divider, DC to 40 GHz
V240C	Precision Power Divider, DC to 65 GHz

POWER SPLITTERS

K241, V241 Series, DC to 65 GHz



K241C



V241C

These microwave power splitters are symmetrical, two-resistor designs that can be used in applications where signals from DC to 65 GHz must be accurately divided for ratio measurements. They provide excellent flatness and effective output SWR. K Connectors® are compatible with 3.5 mm and SMA; V Connectors® are compatible with 2.4 mm.

Features

- DC to 65 GHz frequency range
- K Connector® compatibility with SMA/3.5 mm
- V Connector® compatibility with 2.4 mm
- Excellent flatness and effective output SWR

Specifications

Model	Frequency range (GHz)	Impedance (Ω)	Connectors	
			Input	Output
K241B	DC to 26.5	50	K(m)	K(f)
K241C	DC to 40	50	K(m)	K(f)
V241C	DC to 65	50	V(m)	V(f)

Model	Frequency range (GHz)	Flatness (dB)	Input SWR	Effective output SWR	Insertion loss (dB)
K241B	DC to 26.5	2.0	1.45	1.45	7.5
K241C	DC to 26.5	2.0	1.45	1.45	7.5
	26.5 to 40	2.0	1.93	1.70	8.5
V241C	DC to 18	2.0	2.11	2.00	8.5
	18 to 40	2.0	2.33	2.30	9.5
	40 to 65	2.0	2.62	2.60	10.5

Maximum Input Power: 1W
 Temperature range: 0°C to +70°C
 Weight: 43g

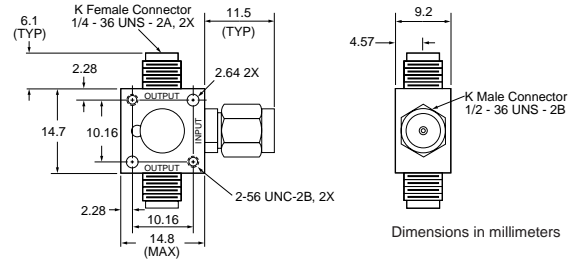

K241B, K241C outline

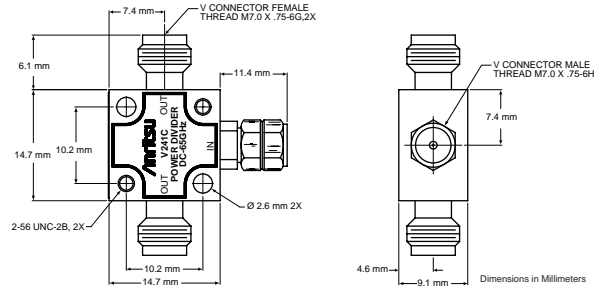

V241C outline

Ordering information

Please specify model/order number, name, and quantity when ordering.

Model/Order No.	Name
K241B	Precision Power Splitter, DC to 26.5 GHz
K241C	Precision Power Splitter, DC to 40 GHz
V241C	Precision Power Splitter, DC to 65 GHz

POWER SPLITTERS

N241 Series, DC to 3000 MHz

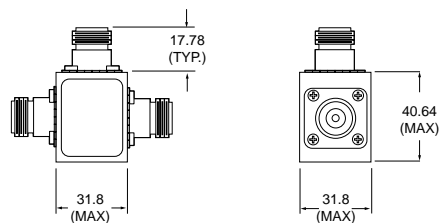

Dimensions in millimeters

N241A50 outline

These RF power splitters are symmetrical, two resistor designs that can be used in applications where signals from DC to 3000 MHz must be accurately divided for ratio measurements. They are available in 50 Ω and provide excellent flatness and effective output SWR.

Features

- DC to 3000 MHz frequency range
- Excellent flatness and effective output SWR
- 50 Ω Impedance

Specifications

Model	Frequency range	Input SWR	Effective output SWR	Insertion loss	Flatness	Impedance	Connectors
N241A50	DC to 3000 MHz	1.3	1.3	7.5 dB	±1.5 dB	50 Ω	Input: N(f) Output: N(f)

Maximum Input Power: 1 W
Temperature range: 0°C to +70°C

Ordering information

Please specify model/order number, name, and quantity when ordering.

Model/Order No.	Name
N241A50	Power Splitter, DC to 3000 MHz, 50 Ω

SPDT SWITCH

DC to 65 GHz

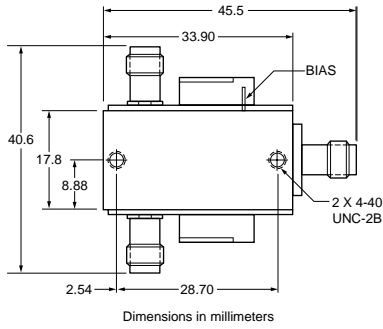

SC4734, SC6135 outline

Coaxial 65 GHz microwave SPDT switch
Short voltage pulse driven.

Features

- *Switching Speed: 20 msec max*
- *Operating Voltage: 20 to 30V*
- *Duty Cycle: 20 msec min*

Specifications*

Model	Frequency range	Connectors		Insertion loss (dB)	Return loss (dB)	Isolation (dB)
		in	out			
SC4734	DC to 60 GHz	V(f)	V(f), V(f)	1.5 ≤40 GHz 3.0 >40 GHz	10 ≤40 GHz 6 >40 GHz	29 ≤40 GHz 26 >40 GHz
SC6135	DC to 65 GHz	V(f)	V(f), V(f)	1.5 ≤40 GHz 3.0 >40 GHz	10 ≤40 GHz 6 >40 GHz	29 ≤40 GHz 26 >40 GHz

Temperature range: 0°C to +70°C

*Call 1-800-ANRITSU for detailed information

Ordering information

Please specify model/order number, name, and quantity when ordering.

Model/Order No.	Name
SC4734	SPDT Switch, DC to 60 GHz
SC6135	SPDT Switch, DC to 65 GHz

BIAS TERMINATION

DBT60, DBT60CPW 50 kHz to 65 GHz

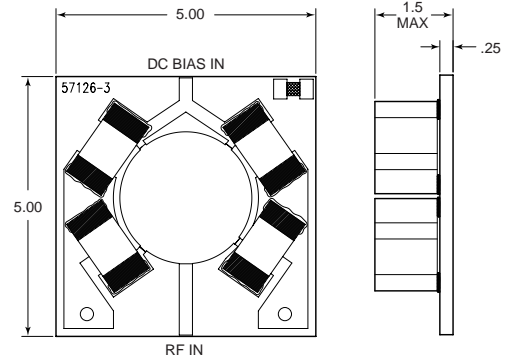
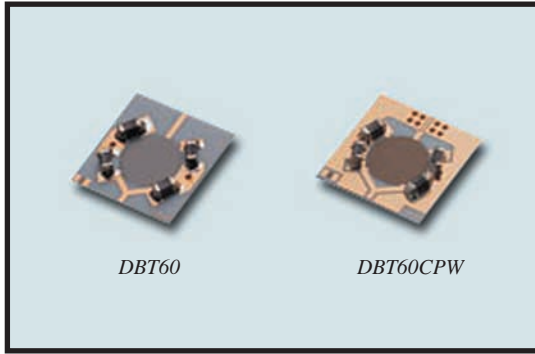

DBT60 outline

The Bias Termination is designed to meet the stringent electrical performance requirements and small size of passive components in optical communication networks. A broad bandwidth of 50 kHz to 65 GHz, with very good return loss, makes it ideal to provide DC Bias in 40 Gbps optical modulators. In addition, the small size of the Bias terminations makes integration of the Biasing network easier.

The two different models available are DBT60 and DBT60CPW. Depending on the type of substrate configuration used within an Optical Modulator, one can use the DBT60 for 0.25 mm thick Microstrip or DBT60CPW for 0.25 mm thick CPW substrate. Bias Terminations can be customized to meet customer requirements for different substrate types, substrate thickness, frequency ranges etc.

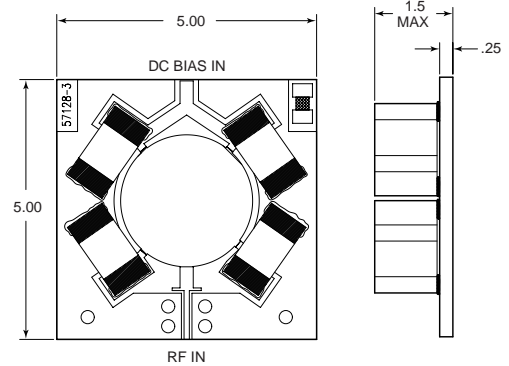

DBT60CPW outline

Features

- Low SWR
- Broad Frequency Performance
- High Voltage Capacity
- Small Form Size

Specifications

Model Number	Frequency Range	Return Loss	DC Voltage	DC Current	Operating Temperature
DBT60	50 kHz to 60 GHz	≥18 dB typical	16V	200 mA	0°C to 70°C
DBT60CPW	50 kHz to 50 GHz 50 GHz to 60 GHz	≥17 dB typical ≥14 dB typical	16V	200 mA	0°C to 70°C

Ordering information

Please specify model/order number, name, and quantity when ordering.

Model/Order No.	Name
DBT60	Bias Termination, 0.25 mm Microstrip
DBT60CPW	Bias Termination, 0.25 mm CPW Substrate

BIAS TEE

K250 100 MHz to 40 GHz, V250 100 MHz to 60 GHz



Specifications

Temperature	0 to 60°C
Mounting position	Any
Weight	57g

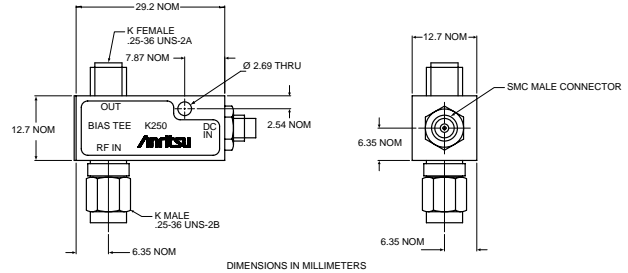

Outline (K and V models)

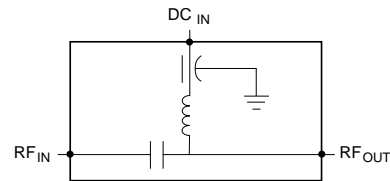

Schematic diagram (K and V models)

These bias tees are designed for applications where both DC and RF signals must be applied to a device under test. They are particularly suited for active device measurements. DC voltages of up to 30 volts at 0.5 amps may be applied to test devices with negligible effect on RF performance. Low RF throughline loss (<1 dB) and low return loss ensure negligible effect on measurements up to 60 GHz. An RF input DC block isolates the input port from the applied bias voltage.

Features

- Broadband, 0.1 to 60 GHz coverage
- Low SWR, low insertion loss
- K Connector® and V Connector® availability

Specifications

Model	Frequency range	Insertion loss	Return loss	RF power	DC voltage	DC current	DC port isolation	RF connectors	DC connectors
K250	0.1 to 40 GHz ^①	1.2 dB typ.	15 dB min. to 20 GHz 10 dB min. to 40 GHz	1W max.	30V max.	0.5A	20 dB at 0.1 GHz 40 dB above 0.5 GHz	Input: K(m) Output: K(f)	SMC(m)
V250	0.1 to 60 GHz ^①	2.2 dB typ.	13 dB min. to 20 GHz 9 dB min. to 40 GHz 8 dB min. to 60 GHz	1W max.	30V max.	0.5A	20 dB at 0.1 GHz 40 dB above 0.5 GHz	Input: V(m) Output: V(f)	SMC(m)

^① Usable between 0.04 and 0.1 GHz with degraded performance.

Temperature range: 0°C to +70°C

Ordering information

Please specify model/order number, name, and quantity when ordering.

Model/Order No.	Name
K250	Precision Bias Tee, 100 MHz to 40 GHz
V250	Precision Bias Tee, 100 MHz to 60 GHz

ULTRA-WIDEBAND BIAS TEES

K251 50 kHz to 40 GHz, V251 100 kHz to 65 GHz

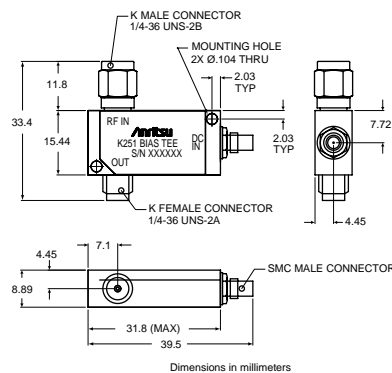

K251 outline

These ultra-wide bandwidth bias tees have been optimized for optical communications and other high-speed pulse, data or microwave applications. Designed to simultaneously apply both DC and RF drive signals to a device via a single input port, these bias tees feature fast rise times, excellent low frequency response, minimum insertion loss and flat group delay. Precision K Connector® and V Connector® interfaces assure excellent impedance match across the wide bandwidths available. A one year warranty is provided. Adapters are available to convert between K and V Connectors - See page 21 of this catalog for details.

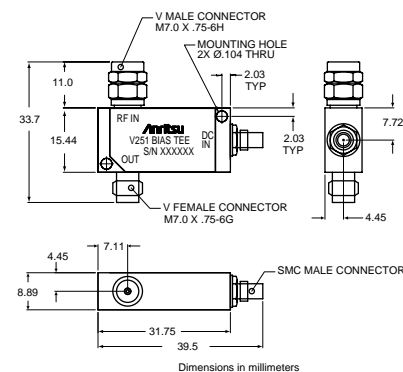

V251 outline

Features

- Ideal for Optical Communications Applications
- Low Insertion Loss
- Risetime: <5 ps typical (V251), <7 ps typical (K251)

Specifications

Model	Frequency range 3dB BW	Insertion loss	Return loss	Rise time	Group delay	Max DC current	Max DC voltage	Max RF power	Connectors
K251	50 kHz to 40 GHz	<2 dB typical	See Plot	< 7 ps typical	110 ± 2 ps typical	100 mA	16VDC	1 W	RF In: K(m) RF Out: K(f) Bias: SMC(m)
V251	100 kHz to 65 GHz	< 2.5 dB typical	See Plot	< 5 ps typical	113 ± 2 ps typical	100 mA	16VDC	1 W	RF In: V(m) RF Out: V(f) Bias: SMC(m)

Specifications apply over the full DC Bias current range and over the temperature range of 0°C to +70°C.

ULTRA-WIDEBAND BIAS TEES

K251 50 kHz to 40 GHz, V251 100 kHz to 65 GHz

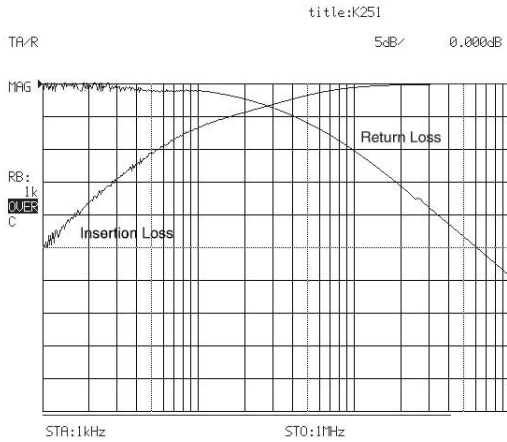

Typical Low Frequency Insertion Loss and Return Loss measured on K251 over the range of 1 kHz to 1 MHz.

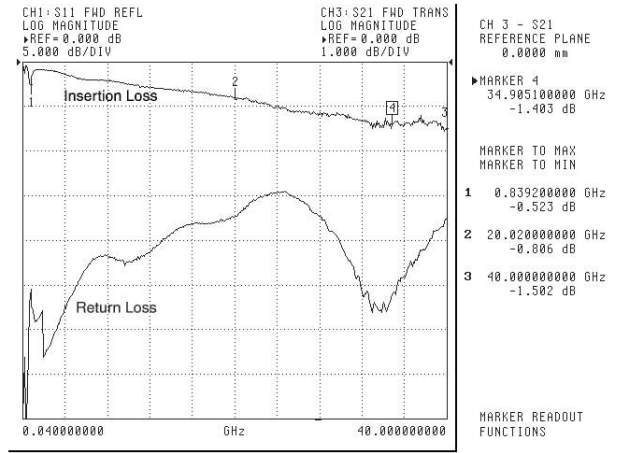

Typical Frequency Insertion Loss and Return Loss measured on K251 over the range of 40 MHz to 40 GHz.

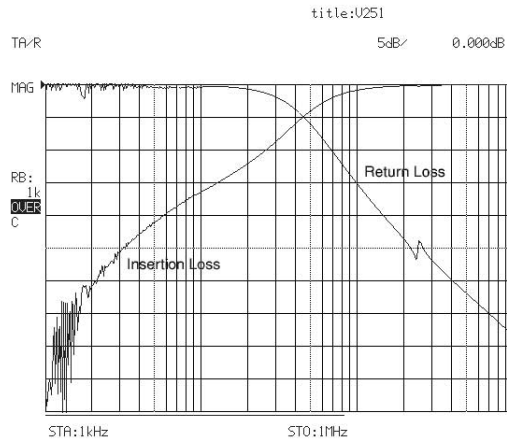

Typical Low Frequency Insertion Loss measured on V251 over the range of 1 kHz to 1 MHz.

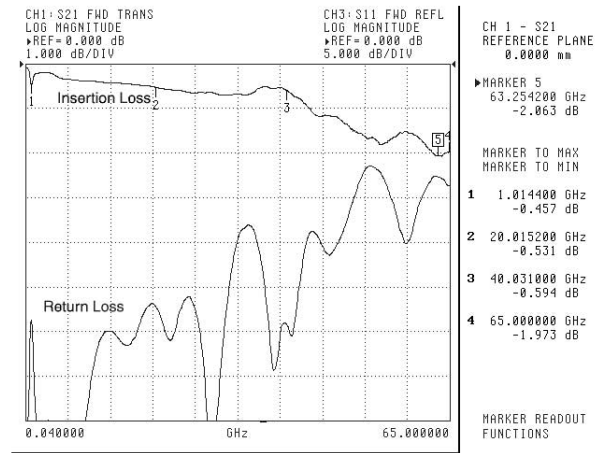

Insertion Loss and Return Loss measured on V251 over the range of 40 MHz to 65 GHz.

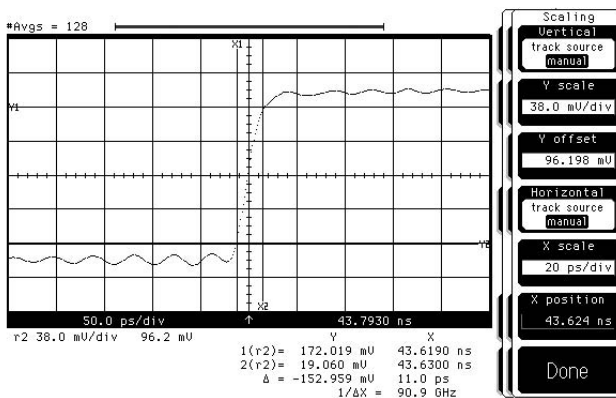

Typical Uncorrected Pulse Response for V251. Absolute risetime for the Bias Tee is derived from this measured data by applying the RSS method to compensate for the risetime of the input pulse.

$$\sqrt{T_{BT}^2 + T_{PG}^2} = T_{meas.}$$

$T_{meas.}$ = uncorrected risetime
 T_{BT} = absolute Bias Tee risetime
 T_{PG} = risetime of input pulse

Ordering information

Please specify model/order number, name, and quantity when ordering.

Model/Order No.	Name
K251	Precision Bias Tee, 50 kHz to 40 GHz
V251	Precision Bias Tee, 100 kHz to 65 GHz

KELVIN CONNECTION BIAS TEE

K252, V252 DC to 65 GHz



Kelvin Connection Bias Tee is designed for applications where both DC and RF signals are applied to the Device under Test (DUT) and precision DC measurements are required. A high resistance of the DC Coil results in a voltage drop that leads to a DC Biasing voltage error in the measurements. A Kelvin connection bias tee is used to eliminate DC Biasing errors as the sense coil allows accurate measurement of the DC Voltage applied across the DUT. Both 40 GHz and 65 GHz models are available with precision K connectors® and V Connectors® respectively. A male connector for the RF input and a female connector for the output is the standard interface for K252 and V252 Bias Tees. A SMC connector is standard for DC Bias and Sense connections. Other connector types with different connector configurations can be ordered through factory.

Features

- Broadband 0.1 to 65 GHz frequency coverage
- 50 V and 500 mA Current capability
- Low Insertion and SWR performance

Model	Frequency Range 3dB BW	Insertion Loss	Return Loss	Max DC Current	Max DC Voltage	Max RF Power	Connectors	Inductance
K252	100 MHz to 40 GHz	<2.5 dB typical	11 dB	500 mA	50 VDC	1 W	RF In: K(m) RF Out: K(f) Bias: SMC(m) Sense: SMC(m)	Bias: 6 mH Sense: 8 mH
V252	100 MHz to 65 GHz	<3.7 dB typical	10 dB to 60 GHz 8 dB to 65 GHz	500 mA	50 VDC	1 W	RF In: V(m) RF Out: V(f) Bias: SMC(m) Sense: SMC(m)	Bias: 6 mH Sense: 8 mH

Ordering information

Please specify model/order number, name, and quantity when ordering.

Model/Order No.	Name
K252	Kelvin Bias Tee, 0.1 to 40 GHz
V252	Kelvin Bias Tee, 0.1 to 65 GHz

ULTRA-WIDEBAND BIAS TEES

V255 50 kHz to 65 GHz

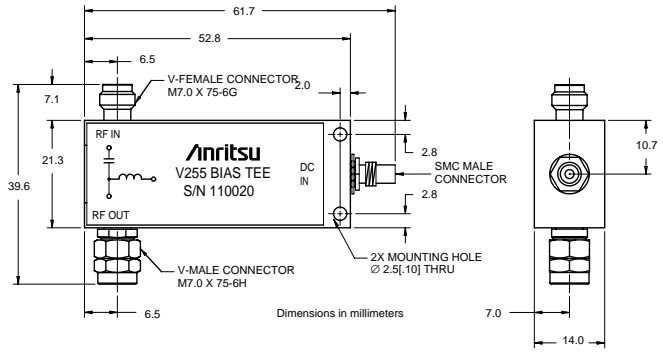
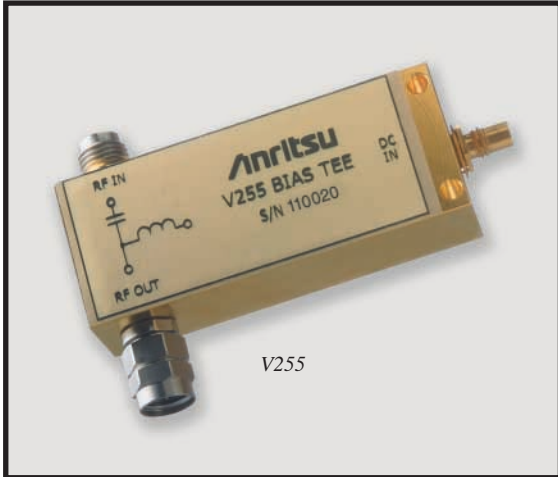

V255 outline

The V255 Gen II Ultra Wideband Bias Tee is designed to meet the high electrical performance requirement of passive components in optical communication networks. Given a broader bandwidth of 50 kHz to 65 GHz, with low insertion losses and very good return loss, makes it ideal to use in 40 Gbps systems to bias optical modulators and broad band data drivers. It's fast rise time and flat group delay performance allows extremely accurate measurements within a laboratory environment. The V255 Bias Tee comes with a standard V Connector® that assures excellent impedance match across the available wide bandwidth. The DC signal can be applied or extracted from the bias tee through an SMC connector at the third port. As with our other bias tees, the V255 also has a one-year warranty.

Features

- Ideal for Optical Communication applications.
- Very low Insertion Loss
- Rise Time 3 ps typical
- High Current Capacity
- High Isolation between Input Port and DC Port

Specifications

Model	Frequency range	Insertion loss	Return loss	Rise time	Group delay	Max DC current	Max DC voltage	Min. Isolation	Operating temperature
V255	50 kHz to 65 GHz (30 kHz to 65 GHz typical)	1.2 dB to 65 GHz typical	<-15 dB to 65 GHz typical	3 ps typical	125 ± 2 ps typical	400 mA	16 VDC	-50 dBm	0°C to 80°C

ULTRA-WIDEBAND BIAS TEES

V255 50 kHz to 65 GHz

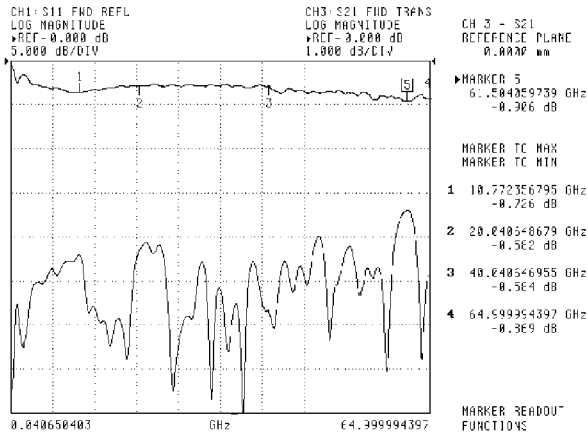

Typical High Frequency Insertion Loss and Return Loss measured on V255 over the range of 40 MHz to 65 GHz using Anritsu 37397C VNA

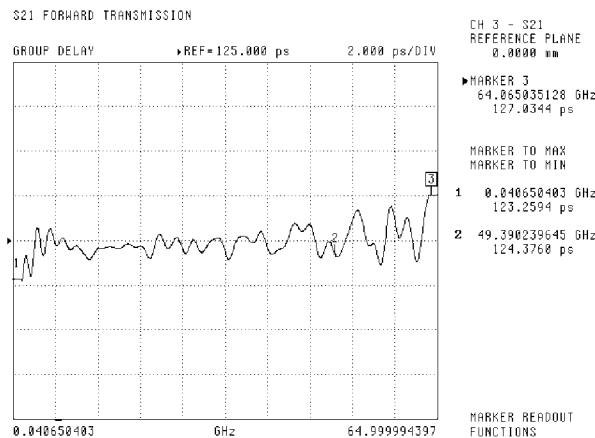

Typical Group Delay Performance measured on V255 using Anritsu 37397C VNA

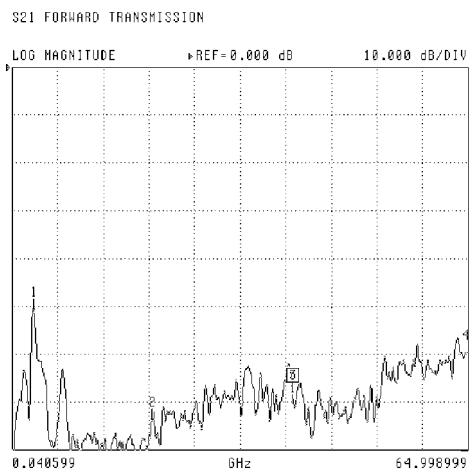

Typical Isolation between Data I/P and DC Port using Anritsu 37397C VNA

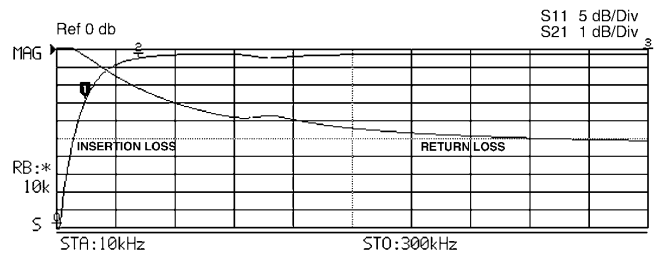

Typical Low Frequency Insertion Loss and Return Loss measured on V255 Bias Tee over the range of 10 kHz to 300 kHz

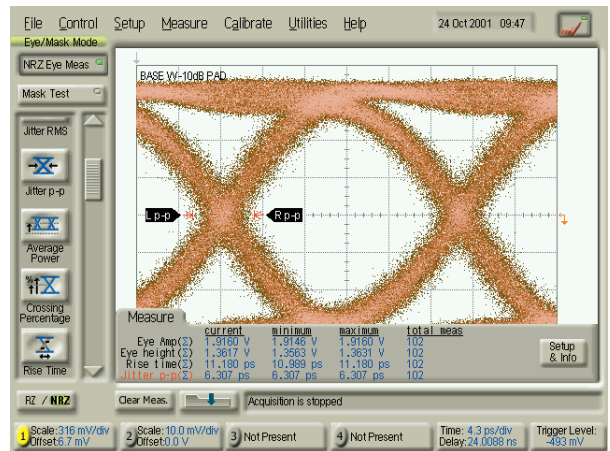

Input Test Signal to V255 2.0 V NRZ Input Signal using Anritsu 43G ME7750A BERT

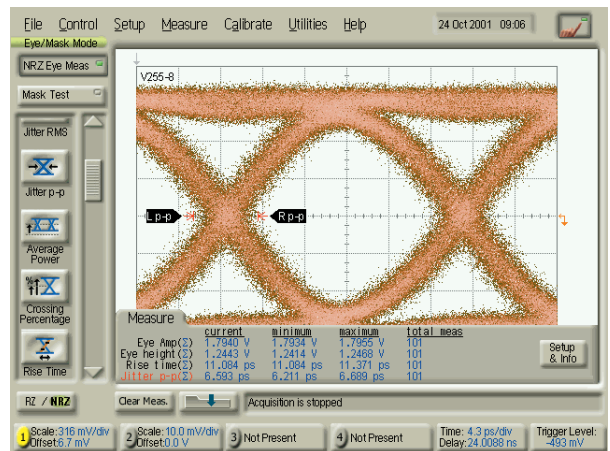

V255 Output Response to 2.0V NRZ Input Signal using Anritsu 43G ME7750A BERT

Ordering information

Please specify model/order number, name, and quantity when ordering.

Model/Order No.	Name
V255	Gen II Wideband Bias Tee, 50 kHz to 65 GHz

PRECISION DC BLOCKS

K261, 10 kHz to 40 GHz, V261 50 kHz to 65 GHz

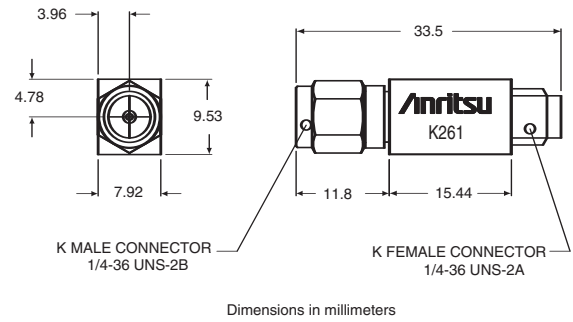
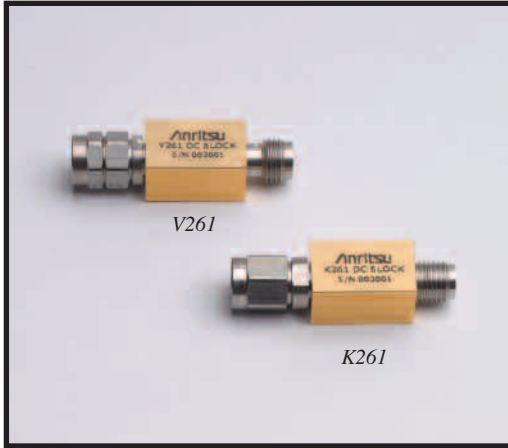

K261 outline

These ultra-wide bandwidth DC Blocks have been optimized for optical communications and other high-speed pulse, data or microwave applications. Designed to apply AC drive signals to a device while eliminating any DC components, these DC Blocks feature wide bandwidth, excellent low frequency response, minimum insertion loss and flat group delay. Precision K Connector® and V Connector® interfaces assure excellent impedance match across the wide bandwidths available. A one year warranty is provided.

Features

- Ideal for Optical Communications and high speed Pulse Applications
- <1.0 dB Insertion Loss (K261)
- Rise time: <5 ps (V261), <7 ps (K261)

Specifications

Model	Frequency range 3 dB BW	Insertion loss	Return loss	Rise time	Group delay	Max DC voltage	Max RF power	Connectors
K261	10 kHz to 40 GHz	<1.0 dB typical	See Plot	< 7 ps typical	110 ±1 ps typical	16VDC	1 W	RF In: K(m) RF Out: K(f)
V261	50 kHz to 65 GHz	< 2.0 dB typical	See Plot	< 5 ps typical	113 ±1 ps typical	16VDC	1 W	RF In: V(m) RF Out: V(f)

Specifications apply over the temperature range of 0°C to +70°C.

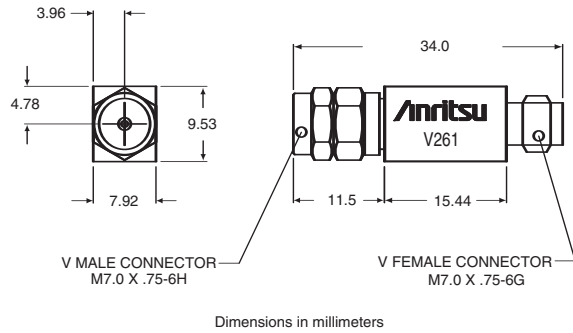

V261 outline

PRECISION DC BLOCKS

K261, 10 kHz to 40 GHz, V261 50 kHz to 65 GHz

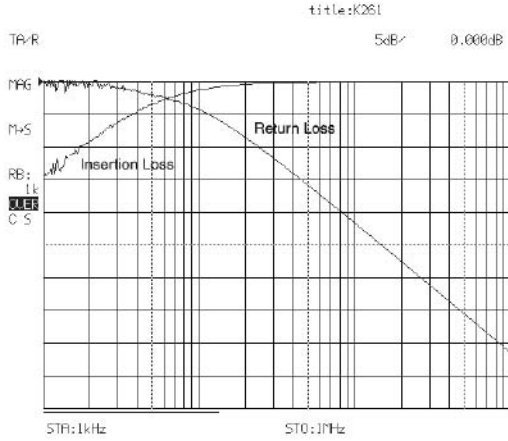

Typical Low Frequency Insertion Loss measured on K261 over the range of 1 kHz to 1 MHz.

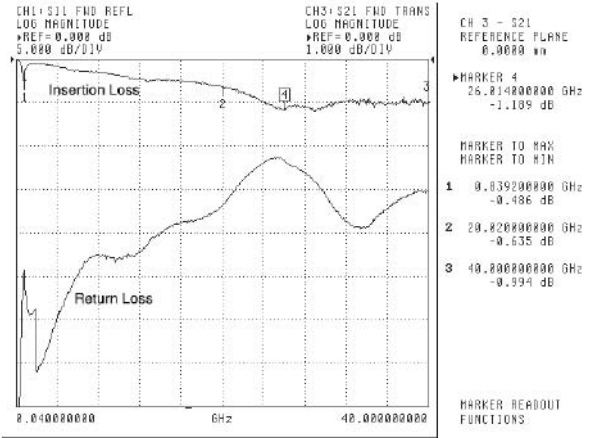

Insertion Loss and Return Loss measured on K261 over the range of 40 MHz to 40 GHz.

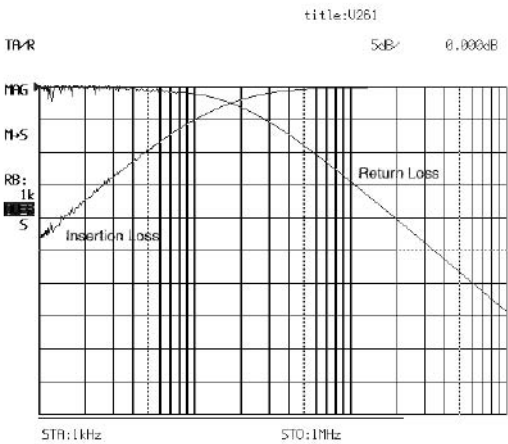

Typical Low Frequency Insertion Loss measured on V261 over the range of 1 kHz to 1 MHz.

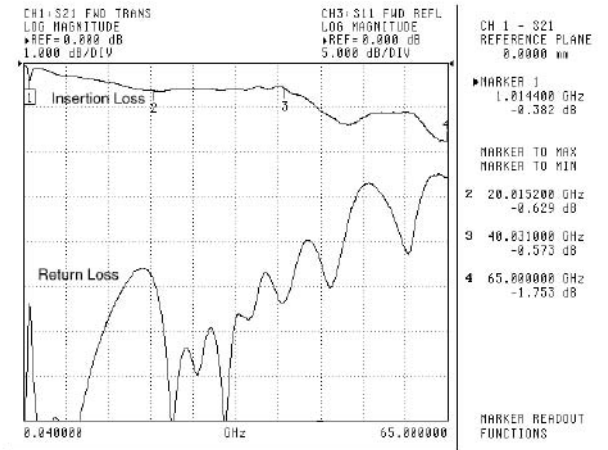

Insertion Loss and Return Loss measured on V261 over the range of 40 MHz to 65 GHz.

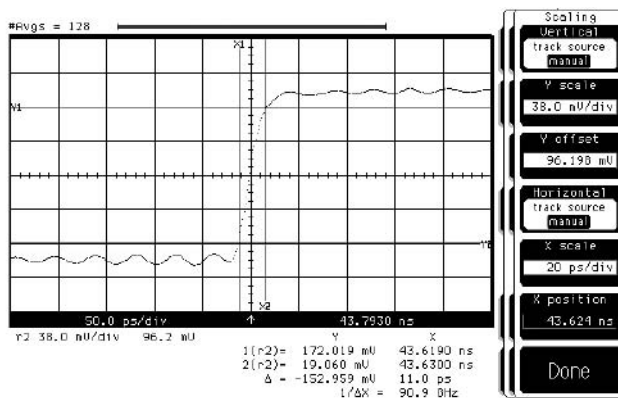

Typical Uncorrected Pulse Response for V261. Absolute risetime for the DC Blocks is derived from this measured data by applying the RSS method to compensate for the risetime of the input pulse.

$$\sqrt{T_{BT}^2 + T_{PG}^2} = T_{meas.}$$

$T_{meas.}$ = uncorrected risetime
 T_{BT} = absolute Bias Tee risetime
 T_{PG} = risetime of input pulse

Ordering information

Please specify model/order number, name, and quantity when ordering.

Model/Order No.	Name
K261	Precision DC Block, 50 kHz to 40 GHz
V261	Precision DC Block, 100 kHz to 65 GHz

DC BLOCKS

V265, 50 kHz to 65 GHz

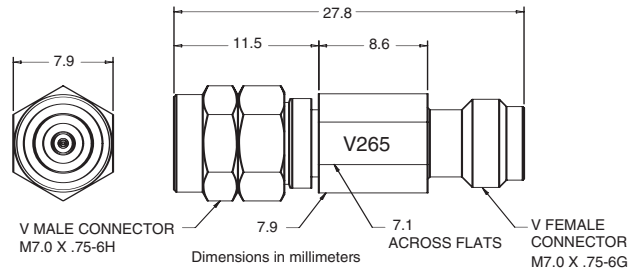

V265 outline

The V265 DC Block has been designed and optimized for optical communications and other high speed pulse, data or microwave applications. Based on the coaxial resilient connection – which is the same as on our V255 Gen II Bias Tee – it provides excellent low frequency response with very low losses and flat group delay over the temperature of operation. Designed to apply AC drive signals to a device while eliminating any DC voltage or current components, the V265 DC Block can be used in isolating DC leakage between two electrical components. The DC block comes with a standard V Connector® and assures excellent impedance match across the wide bandwidth available. A one-year warranty is provided.

Features

- *Ideal for Optical Communication applications.*
- *Low Insertion Loss*
- *Rise Time 3 ps typical*

Specifications

Model	Frequency range	Insertion loss	Return loss	Rise time	Group delay	Max DC voltage	Max RF power	Connectors	Operating temperature
V265	50 kHz to 65 GHz 30 kHz to 65 GHz typical	<0.7 dB to 65 GHz typical	-15 dB to 65 GHz typical	3 ps typical	84 ±2 ps typical	16 VDC	1 W	RF In: V(f) RF Out: V(m)	0°C to 80°C

PRECISION DC BLOCKS

V265, 50 kHz to 65 GHz

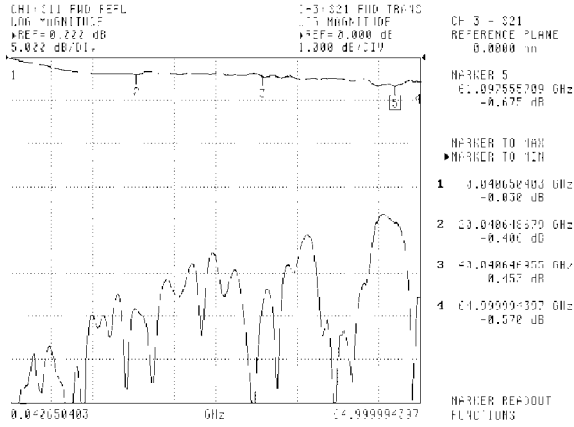

Typical High Frequency Insertion Loss and Return Loss measured on V265 over the range of 40 MHz to 65GHz using Anritsu 37397C VNA

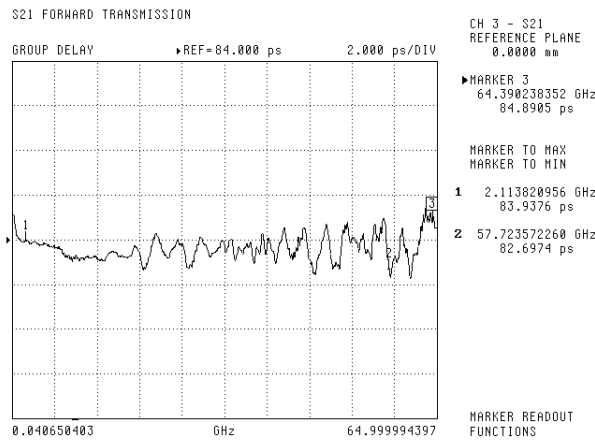

Typical Group Delay Performance measured on V265 using Anritsu 37397C VNA

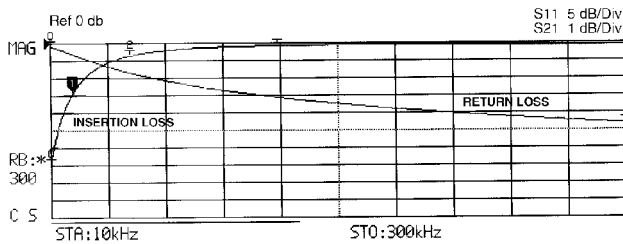

Typical Low Frequency Insertion Loss and Return Loss measured on V265 Bias Tee over the range of 10 kHz to 300 kHz using Anritsu MS4630B Network Analyzer

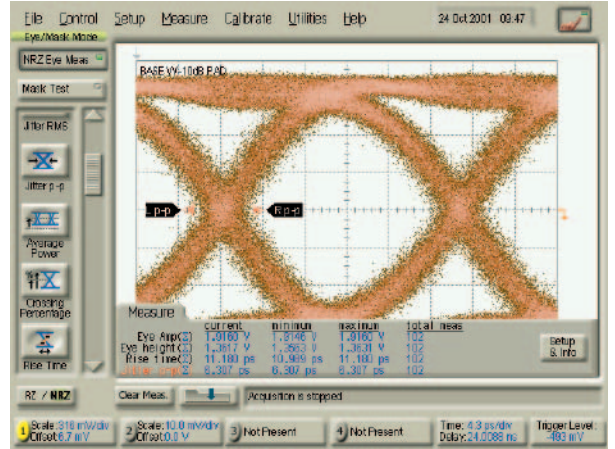

Input Test Signal to V265 2.0V NRZ Input Signal using Anritsu 43G ME7750A BERT

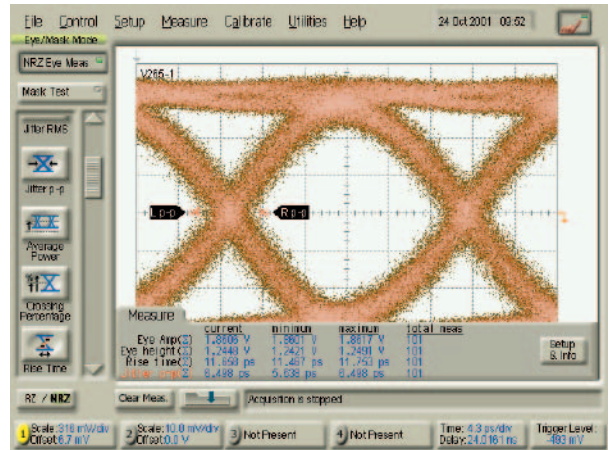

V265 Output Response to 2.0V NRZ Input Signal using Anritsu 43G ME7750A BERT

Ordering information

Please specify model/order number, name, and quantity when ordering.

Model/Order No.	Name
V265	DC Block, 50 kHz to 65 GHz

UNIVERSAL TEST FIXTURES

3680 Series DC to 60 GHz



The 3680 series provide an accurate, repeatable solution for measuring microstrip and Coplanar substrate devices. Input and output connections are made to the substrate device by two spring-loaded jaws that include coax-to-microstrip/Coplanar launchers. The jaws accommodate substrates from 0.13 to 1.9 mm in thickness. No center section is required. One jaw is movable in two dimensions to accommodate substrates up to 50 mm long (100 mm for 3680-20) and substrates with line offsets of up to 12.7 mm (25 mm for 3680-20). The 3680 series includes three models: the 3680-20 covers DC to 20 GHz with APC-3.5™ connectors, the 3680K covers DC to 40 GHz with Anritsu's K Connector®, and the 3680V covers DC to 60 GHz with Anritsu's V Connector®.

Features

- DC to 60 GHz coverage
- Microstrip and coplanar measurement capability
- Accommodates offset and right-angle test devices
- Calibration/verification kits (optional)
- Substrate measurement capability

Substrate Measurement Capability

Providing substrate measurement capability for your microstrip or coplanar waveguide designs, the 3680 Series Universal Test Fixtures allow accurate, repeatable transitions from coax to microstrip or coax to coplanar waveguide (CPW). Complete substrate measurement systems comprised of a Universal Test Fixture, a vector or scalar network analyzer, and a "substrate" Calibration Kit can fulfill your microstrip or CPW test needs. Anritsu provides the complete measurement solution, the test fixtures, the calibration kits, and the test equipment for measurements on substrate devices. Our total system responsibility ensures compatible system components, designed to work together properly. Guaranteed system specs provide assurance that your test results are accurate and verifiable.

Universal Test Fixtures

The most critical part of any substrate measurement system is the launching fixture. It must be simple yet flexible, easy to use, and most of all provide accurate, repeatable measurements. Our Universal Test Fixtures are designed to meet these requirements. Three versions of the Universal Test Fixture are available: the 3680-20, DC to 20 GHz; the 3680K, DC to 40 GHz; and the 3680V, DC to 60 GHz. The fixture consists of a fixed connector and a movable connector that can be positioned for substrates up to 2 inches long. No center section is required. The substrate is held in place between springloaded jaws. This allows the fixture to accommodate different devices without requiring a custom center section for each different length. The unique jaw action ensures solid, repeatable electrical contact. The jaw tension is defined by the force of a spring, independent of human judgment errors. This means the tension will always be the same, providing more repeatable measurements. Dielectric rods behind the jaws accurately position the substrate away from the launch to reduce fringing capacitance and contribute to the fixture's excellent repeatability. With a Universal Test Fixture you can be sure your measurements are both accurate and repeatable.

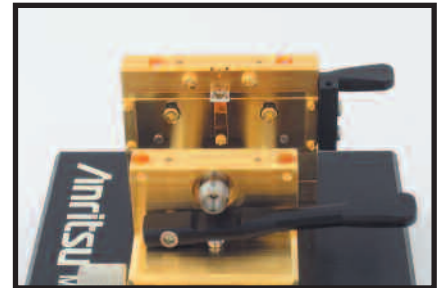

Microstrip or Coplanar Waveguide Measurements

The unique design of the 3680 provides measurement capability for either microstrip or coplanar waveguide (CPW) designs. All that is required is a simple jaw change. The 3680 does the job of two fixtures, saving you time and money. A substrate measurement system with the 37xxx series

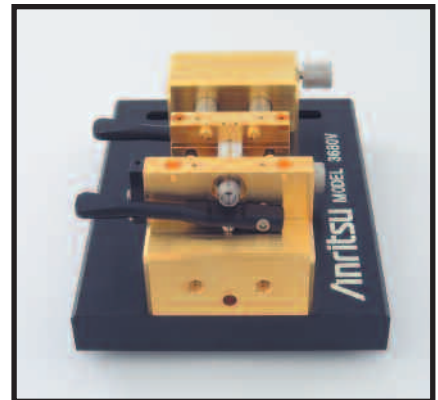

VNA is the only measurement system capable of directly providing microstrip dispersion compensation. Microstrip is a dispersive media - phase shift is not linear with respect to frequency. Our Vector Network Analyzer's ability to compensate for this dispersion can dramatically improve vector measurement accuracy and provide you with the most accurate vector measurements possible.

UNIVERSAL TEST FIXTURES

3680 Series DC to 60 GHz

Offset Measurements

With a 3680-based substrate measurement system, there is no need to force your designs into a straight line or leave your designs untested. The 3680 has the ability to offset lines by as much as \pm inch. Many designs, such as filters, require parallel traces that are offset. In

the past, designers were forced to add extra line lengths, create one-of-a-kind custom fixtures, or worse, not test offset designs. With the flexibility of the 3680, you can test offset or in-line designs with one setup. Formerly-untestable designs can now be tested with ease.

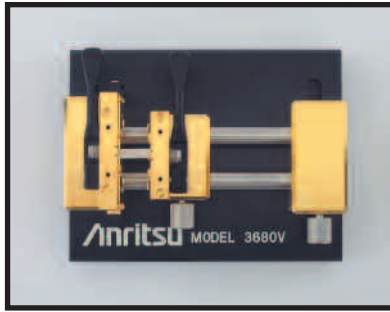

Right-Angle Measurements

Testing designs with right-angle connections is made easy. The optional rightangle launcher adds a connection at 90° to the fixture. This lets you test devices with right-angle connections with precision and repeatability corresponding to an in-line measurement. The fixture is designed to fit your device; you don't have to design your device to fit the fixture. The right-angle launcher also provides another benefit - the ability to test multipoint devices. With the addition of right-angle launchers, the 3680 can become a three port, or even four port launching fixture. A 37xxx series VNA-based microstrip measurement system with optional dual source control can interdependently control up to two sources and a receiver, for testing mixers or other frequency conversion devices. Now a microstrip or CPW mixer, converter, or other device can be tested, with the same convenience as a packaged device.

60 GHz Measurements

Anritsu was the first manufacturer to offer a coaxial VNA with continuous 0.04 GHz to 60 GHz measurement capability. With the 3680 Series Universal Test Fixtures, that measurement capability is extended onto the substrate. An Anritsu VNA-based substrate measurement system is capable of measurements from 0.04 GHz to 60 GHz in one setup. And the optional 60 GHz time domain capability provides time or distance measurements with unsurpassed resolution. Discontinuities as close as 1.2 mm on alumina can be resolved. You can measure devices whose performance could previously only be theorized. The 3680V, has excellent return loss and insertion loss from DC to 60 GHz. In a substrate measurement system, that translates to improved accuracy and repeatability, for more accurate characterization of your microstrip or CPW designs.

Bias Capability

For active device measurements, the 3680 has bias capability either through the RF connection or through a bias probe. With optional multiple bias probes, you can inject bias into any point on your device under test. The bias probe provides infinite placement resolution and eliminates the need for external bias hardware. Alternately, if your active device is biased through an RF connection, bias tees can be used to combine bias and RF at any launch point. The 3680's flexible bias injection eliminates the need for multiple fixtures, saving you time and money. Up to four bias probes can be accommodated.

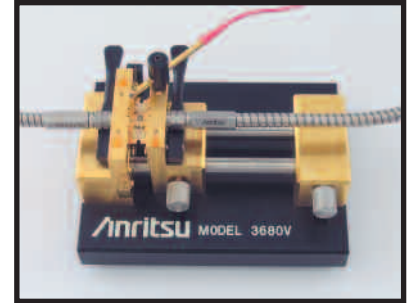

MMIC Measurements

With the optional MMIC attachment, you can test MMIC's and very small components as conveniently as other devices. A MMIC attachment consists of a center carrier, with microstrip lines for launching, and cam-operated pressure rods. The MMIC component is placed on the center carrier between microstrip lines. (Machinable center carrier blocks are available for your custom designs.) Contact with the component is made with spring tabs, for reliability and damage protection. The unique design of the MMIC attachment assures solid, repeatable measurements on any small device. An Anritsu substrate measurement system can fulfill all your substrate measurement needs including, with a MMIC attachment, very small substrates and MMICs.

Calibration/Verification Kits

A full complement of calibration kits for microstrip or coplanar waveguide are available. Standard Open Short Load (OSL) and Line Reflect Line (LRL) calibration components are included. The substrates for these cal kits are carefully selected for proper impedance and consistency, to provide the most accurate measurements possible. Included with every cal kit is a Beatty standard (standard mismatch) and a 20 dB offset termination. Now you can verify, in the fixture, the quality of your calibrations. This verification, available only from Anritsu, ensures the validity of your device measurements.

UNIVERSAL TEST FIXTURES

3680 Series DC to 60 GHz

Specifications

3680 series Universal Test Fixture	Substrate types supported	Microstrip or coplanar waveguide
	Overall size	10 x 12.7 x 6.4 cm
	Substrate length	0.5 cm min. 5 cm max. [10 cm with 3680-20]
	Maximum substrate width	No limit
	Substrate thickness	0.012 cm min. 0.19 cm max.
	Maximum line offset	±1.2 cm [±2.5 cm with 3680-20]
	Input and output connectors	3680-20: APC-3.5™ female 3680K: K Connector® female 3680V: V Connector® female
36802 MMIC Attachment	Substrate thickness	0.0 cm, 0.038 cm, 0.064 cm
	Minimum test substrate length	1.5 mm
	Maximum test substrate length	1.17 cm with standard block
	Maximum line offset	±1.2 cm
36801 Right Angle Launcher	Distance from in-line connector, axial	Minimum: 1 cm Maximum: 4 cm
	Distance from in-line connector, offset	Minimum: 0.0 cm Maximum: 2 cm

Electrical

Model	Universal Test Fixture			Right-Angle Launcher		MMIC Attachment
	3680-20	3680K	3680V	36801K	36801V	36802
Frequency range (GHz)	DC to 20	DC to 40	DC to 60	DC to 30	DC to 50	DC to 60
Return loss (dB) DC to 20 GHz 20 to 40 GHz 40 to 60 GHz	>17	>17 >14	>17 >14 >8	>16 >12	>16 >12 >7	>12 >8 >6
Repeatability (dB) DC to 20 GHz 20 to 40 GHz 40 to 60 GHz	<±0.10	<±0.10 <±0.20	<±0.10 <±0.20 <±0.30	<±0.15 <±0.25	<±0.15 <±0.25 <±0.40	<±0.20 <±0.40 <±0.60

Temperature range: -20° to 70°C

Ordering information

Please specify model/order number, name and quantity when ordering.

Model/Order No.	Name
Main frame	
3680-20	Universal Test Fixture (20 GHz)
3680K	Universal Test Fixture (40 GHz)
3680V	Universal Test Fixture (60 GHz)
Accessories	
36801K	Right-Angle Launcher (30 GHz)
36801V	Right-Angle Launcher (50 GHz)
36802	MMIC Attachment
36803	Bias Probe
36805-10M	10 mil launchers ^①
36805-15M	15 mil launchers ^①
36805-25M	25 mil launchers ^①
Calibration/verification kits	
36804B-10M	10 mil microstrip cal/verif. kit, DC to 50 GHz
36804B-15M	15 mil microstrip cal/verif. kit, DC to 30 GHz
36804B-25M	25 mil microstrip cal/verif. kit, DC to 15 GHz
36804B-25C	25 mil coplanar waveguide cal/verif. kit, DC to 20 GHz

① 36805 series includes (4) substrate launchers for the 36802 MMIC attachment

LIMITERS

1 Series 1 MHz to 26.5 GHz

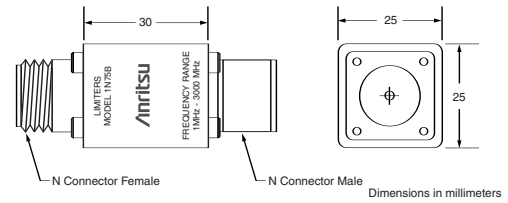

1N50B and 1N75B Limiters outline

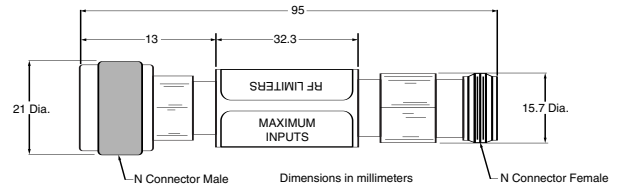

1N50C and 1N75C Limiters outline

Broadband microwave limiter features

- High power protection: Up to 5 Watts
- Very fast turn-on time: 10 ns max.
- Broad frequency range: 0.001 to 26.5 GHz
- Low insertion loss: 2.7 dB to 20 GHz
- Excellent return loss: 11 dB at 20 GHz
- Single side limiting

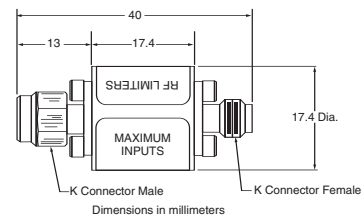

1K50A and 1K50B Limiters outline

Specifications

Model	Frequency range	Max. input power	Min. return loss (at 0 dBm input)	Max. insertion loss (at 0 dBm input)	Max. turn-on time	Input connector	Output connector	Input/output coupling
1K50B	0.01 to 26.5 GHz	3 Watts	10 dB	3.9 dB	10 ns	K(m)	K(f)	DC
1K50A	0.01 to 20 GHz	5 Watts	14 dB, ≤12 GHz 11 dB, >12 GHz	2.7 dB	10 ns	K(m)	K(f)	DC
1N50C	0.01 to 18 GHz	5 Watts	14 dB, ≤12 GHz 11 dB, >12 GHz	2.9 dB	10 ns	N(m)	N(f)	DC
1N75C	0.01 to 3 GHz	5 Watts	15 dB	1.1 dB	10 ns	75 Ω N(m)	75 Ω N(f)	DC
1N50B	0.001 to 3 GHz	1.5 Watts	19 dB	1.3 dB	10 ns	N(m)	N(f)	AC
1N75B	0.001 to 3 GHz	1.5 Watts	19 dB	1.3 dB	10 ns	75 Ω N(m)	75 Ω N(f)	AC

Limiting Level: Limiter begins compressing at approximately +10 dBm. In compression, output level increases by 0.25 to 0.5 dB for each 1 dB increase at the input. Output power at 5W input at 500 MHz is 21 dBm max.

Dimensions: 1N50B and 1N75B 3.8 cm x 2.5 cm x 2.5 cm

Temperature range: 0°C to +70°C

Ordering information

Please specify model/order number, name and quantity when ordering.

Model/Order No.	Name
	Limiter
1N50B	N(m) to N(f), 50 Ω, 1 MHz to 3 GHz
1N75B	N(m) to N(f), 75 Ω, 1 MHz to 3 GHz
1N50C	N(m) to N(f), 50 Ω, 10 MHz to 18 GHz
1N75C	N(m) to N(f), 75 Ω, 10 MHz to 3 GHz
1K50A	K(m) to K(f), 50 Ω, 10 MHz to 20 GHz
1K50B	K(m) to K(f), 50 Ω, 10 MHz to 26.5 GHz

MATCHING PADS

12 Series DC to 3000 MHz



RF matching pad and impedance adapter features

- DC to 3000 MHz frequency range
- Matching pad matches 50 Ω to 75 Ω or 75 Ω to 50 Ω circuits
- Impedance adapter converts 50 Ω to 75 Ω with <3 dB loss

The 12N50-75B matching pad is a two-resistor design that matches 50 Ω to 75 Ω or 75 Ω to 50 Ω circuits.

The 12N75B impedance adapter is a one-resistor design that converts 50 Ω to 75 Ω with less than 3 dB loss.

Specifications

Model	Frequency range (MHz)	SWR	Insertion loss (dB)	Connectors
12N50-75B	DC to 3000	1.25	7.5 max.	N(m) 50 Ω to N(f) 75 Ω
12N75B	DC to 3000	1.25	3.0 max.	N(m) 50 Ω to N(m) 75 Ω

Temperature range: 0°C to +70°C

Dimensions: 3.8 cm x 2.5 cm x 2.5 cm

Ordering information

Please specify model/order number, name and quantity when ordering.

Model/Order No.	Name
12N50-75B	Matching Pad, DC to 3000 MHz
12N75B	Impedance Adapter, DC to 3000 MHz

VNA AND VNMS CALIBRATION KITS



3753LF

The Anritsu Calibration Kits contain all the precision components and tools required to calibrate your VNA or VNMS for 12-term error-corrected measurements in the connector style of your choice. Components are included for calibrating male and female test ports as required. The kits support calibration with opens, shorts, and broadband loads. Option 1 adds sliding terminations and a pin depth gauge where required.

The following kits are for use with 37XXX Lightning VNAs. 3650 SMA/3.5 mm Calibration Kit consisting of:

- 34ASF50-2 Female Adapter (2)
- 33SFSF50 Female-Female Adapter (2)*
- 33SS50 Male-Male Adapter*
- 28S50-2 Broadband Male Termination (2)
- 28SF50-2 Broadband Female Termination (2)
- 33SSF50 Male-Female Adapter (2)*
- 24S50 Male Open
- 24SF50 Female Open
- 23S50 Male Short
- 23SF50 Female Short
- 34AS50-2 Male Adapter (2)
- Connector Thumb Wheel (4)
- 01-201 Torque Wrench
- 01-210 Reference Flat
- 01-222 Pin Depth Gauge
- 01-223 Pin Depth Gauge
- Calibration coefficients diskette

Option 1

Adds the following:

- 01-212 Female Flush Short
- 01-211 Male Flush Short
- 17SF50 Female Sliding Termination
- 17S50 Male Sliding Termination

3651 GPC-7 Calibration Kit consisting of:

- 28A50-2 Broadband Termination (2)
- 24A50 Open
- 23A50 Short
- 01-200 Torque Wrench
- 01-221 Collet Extractor Tool and 4 Collets
- Calibration coefficients diskette



3651, Option 1

Option 1

Adds the following:

- 17A50 Sliding Termination
- 01-210 Reference Flat
- 01-220 Pin Depth Gauge

3652 K Connector® Calibration Kit consisting of:

- 34AKF50 Female Adapter (2)
- 33KFKF50B Female-Female Adapter (2)*
- 33KK50B Male-Male Adapter*
- 28K50 Broadband Male Termination (2)
- 28KF50 Broadband Female termination (2)
- 33KKF50B Male-Female Adapter (2)*
- 24K50 Male Open
- 24KF50 Female Open
- 23K50 Male Short
- 23KF50 Female Short
- 34AK50 Male Adapter (2)
- 01-201 Torque Wrench
- 01-210 Reference Flat
- 01-222 Pin Depth Gauge
- 01-223 Pin Depth Gauge
- Calibration coefficients diskette
- Connector thumb wheel (4)

Option 1

Adds the following:

- 17KF50 Female Sliding Termination
- 17K50 Male Sliding Termination
- 01-212 Female Flush Short
- 01-211 Male Flush Short

3653 Type N Calibration Kit consisting of:

- 23NF50 Female Short
- 23N50 Male Short
- 24NF50 Female Open
- 24N50 Male Open
- 28N50-2 Broadband Male Termination (2)
- 28NF50-2 Broadband Female Termination (2)
- 34AN50-2 Male Adapter (2)
- 34ANF50-2 Female Adapter (2)
- 01-213 Reference Gauge
- 01-224 Pin Depth Gauge
- Calibration coefficients diskette

VNA AND VNMS CALIBRATION KITS

3654BV Connector® Calibration Kit consisting of:

- 23V50B-5.1 Male Short 5.1mm
- 23VF50B-5.1 Female Short 5.1mm
- 24V50B Male Open
- 24VF50B Female Open
- 28V50B Male Broadband Termination (2)
- 28VF50B Female Broadband Termination (2)
- 17VF50B Female Sliding Termination
- 17V50B Male Sliding Termination
- 33VV50B Male-Male Adapter*
- 33VVF50B Female-Female Adapter (2)*
- 33VVF50B Male-Female Adapter (2)*
- Calibration coefficients diskette
- Connector thumb wheel (4)
- 01-201 Torque Wrench
- 01-210 Reference Flat
- 01-322 Pin Depth Gauge
- 01-323 Female Adapter for pin gauge
- 01-204 Adapter Wrench
- 01-312 Male Flush Short
- 01-311 Female Flush Short

3655 Series Waveguide Calibration Kit

The 3655 Series Calibration Kit contains all of the precision components and tools required to calibrate your VNA for 12-term error-corrected measurements of test devices with the appropriate waveguide designation. Components are included for calibrating both module ports. The kit supports calibration with offset shorts and broadband loads. Option 1 adds a sliding termination.

Consisting of:

- Short, Flush (2)
- Offsets, 1/8 and 3/8 Wavelength
- Terminations, Fixed (2)
- Test Port Sections (2)

Option 1

Adds the following:

- Sliding Termination

3656 W1 Calibration Kit consisting of:

- 23W50-1 Male Offset Short (2.02 mm)
- 23W50-2 Male Offset Short (2.65 mm)
- 23W50-3 Male Offset Short (3.180 mm)
- 24W50 Male Open (1.510 mm)
- 28W50 Male Broadband Termination
- 23WF50-1 Female Offset Short 1 (2.02 mm)
- 23WF50-2 Female Offset Short 2 (2.65 mm)
- 23WF50-3 Female Offset Short 3 (3.180 mm)
- 28WF50 Female Broadband Termination
- 24WF50 Female Open (1.930 mm)
- 33WSC50 Fixed Male SC Connector
- 33WFSC50 Fixed Female SC Connector
- Interchangeable Sliders, SC Connectors
- Locking Keys, SC Connectors
- 01-402 Interchange Adapter Fixed Male
- 33WWF50 Male-Female Adapter
- 33WW50 Male-Male Adapter
- 33WFWF50 Female-Female Adapter
- 01-504 6 mm Torque Wrench
- 01-505 6-7 mm End Wrench
- 18WWF50-1B Stepped Impedance ThruLine (Verification Device)
- 18WWF50-1 50Ω Matched ThruLine (Verification Device)
- Calibration coefficients diskette

* Phase Equal Adapters

The following kits are for use with MS462XX Scorpion VNAs.

3750R SMA/3.5 mm 9 GHz Calibration Kit consisting of:

- 23LF50 Female Short
- 23L50 Male Short
- 24LF50 Female Open
- 24L50 Male Open
- 28L50R Male Termination (2)
- 28LF50R Female Termination (2)
- 01-204 Adapter wrench
- Calibration coefficients diskette

3751R GPC-7 9 GHz Calibration Kit consisting of:

- 23A50 Short
- 24A50 Open
- 28A50R Termination (2)
- Calibration coefficients diskette

3753R Type N 9 GHz Calibration Kit consisting of:

- 23NF50 Female Short
- 24NF50 Female Open
- 24N50 Male Open
- 28NF50R Female Termination (2)
- 28N50R Male Termination (2)
- 23N50 Male Short
- Calibration coefficients diskette

3753-75R 75 Ω Type N 3 GHz Calibration Kit consisting of:

- 23N75-3 Male Short
- 23NF75-3 Female Short
- 24N75-3 Male Open
- 24NF75-3 Female Open
- 28N75-3 Male Termination (2)
- 28NF75-3 Female Termination (2)
- 34NN75-3 Male-Male Adapter
- 34NNF75-3 Male-Female Adapter
- 34N75-3 Female-Female Adapter
- Calibration coefficients diskette

Ordering information

Please specify model/order number, name and quantity when ordering.

Model/Order No.	Name
	Calibration kits
3650	SMA/3.5 mm calibration kit
Option 1	Adds sliding terminations
3651	GPC-7 calibration kit
Option 1	Adds sliding terminations
3652	K Connector® calibration kit
Option 1	Adds sliding terminations
3653	Type N calibration kit
Option 1	Adds sliding terminations
3654B	V Connector® calibration kit with sliding terminations
3655E	WR12 Waveguide calibration kit
Option 1	Adds sliding terminations
3655F	WR08 Waveguide calibration kit
Option 1	Adds sliding terminations
3655V	WR15 Waveguide calibration kit
Option 1	Adds sliding terminations
3655W	WR10 Waveguide calibration kit
Option 1	Adds sliding terminations
3656	W1 calibration kit
3750R	SMA/3.5 mm 9 GHz calibration kit
3751R	GPC-7 9 GHz calibration kit
3753R	Type N 9 GHz calibration kit
3753-75R	75 Ω Type N 3 GHz calibration kit

VNA AND VNMS VERIFICATION KITS



The Anritsu Verification Kits contain precision components with characteristics that are traceable to NIST. Used primarily by the metrology laboratory, these components provide the most dependable means of determining the system accuracy of your VNA. A disk containing factory measured test data for all components is supplied for comparison with customer-measured data.

The following kits are for use with 37XXX Lightning VNAs.

3663 Type N Verification Kit consisting of:

- 42N-50, 50 dB Attenuator
- 18N50-10, 10 cm Airline
- 42N20, 20 dB Attenuator
- 18N50-10B, 10 cm Stepped Impedance Airline (Beatty standard)
- Verification kit disks

3665 Waveguide Verification Kit consisting of:

- Straight section
- Pin set
- Mismatch section
- Ball driver
- 50 dB Attenuator
- 20 dB Attenuator
- Verification kit disks

3666 SMA/3.5 mm Verification Kit consisting of:

- 19S50-7, 7.5 cm Airline
- 19SF50-7B, 7.5 cm Stepped Impedance Airline (Beatty standard)
- 42S-50, 50 dB Attenuator
- 42S-20, 20 dB Attenuator
- Verification kit disks

3667 GPC-7 Verification Kit consisting of:

- 42A-50, 50 dB Attenuator
- 18A50-10, 10 cm Airline
- 42A-20, 20 dB Attenuator
- 18A50-10B, 10 cm Stepped Impedance Airline (Beatty standard)
- Verification kit disks

3668 K Connector® Verification Kit consisting of:

- 19K50-7, 7.5 cm Airline
- 42K-50, 50 dB Attenuator
- 42K-20, 20 dB Attenuator
- 18K50-7B, 7.5 cm Stepped Impedance Airline (Beatty standard)
- Verification kit disks

3669B V Connector® Verification Kit consisting of:

- 42V-40, 40 dB Attenuator
- 42V-20, 20 dB Attenuator
- 19V50-5, 5 cm Airline
- 18V50-5B, 5 cm Stepped Impedance Airline (Beatty standard)
- Verification kit disks

The following kits are for use with MS462XX Scorpion VNAs.

3663R Type N 9 GHz Verification Kit consisting of:

- 42N-50, 50 dB Attenuator
- 42N20, 20 dB Attenuator
- 42NOP-20 N Mismatch attenuator
- Verification kit disks

3666R SMA/3.5 mm 9 GHz Verification Kit consisting of:

- 42L-50, 50 dB Attenuator
- 42L-20, 20 dB Attenuator
- 42LOP-20 SMA/3.5 mm Mismatch Attenuator
- Verification kit disks

3667R GPC-7 9 GHz Verification Kit consisting of:

- 42A-50, 50 dB Attenuator
- 42A-20, 20 dB Attenuator
- 42AOP-20 GPC-7 Mismatch Attenuator
- Verification kit disks

Ordering information

Please specify model/order number, name and quantity when ordering.

Model/Order No.	Name
	Verification kits
3663	Type N verification kit
3665	Waveguide verification kit
3666	SMA/3.5 mm verification kit
3667	GPC-7 verification kit
3668	K Connector® verification kit
3669B	V Connector® verification kit
3663R	Type N 9 GHz verification kit
3666R	SMA/3.5 mm 9 GHz verification kit
3667R	GPC-7 9 GHz verification kit

PART NUMBER INDEX

Item	Description	Page	Item	Description	Page
01-101A	K Connector Evaluation Kit	6	25K50	Precision Matched K(m), Test Port Head	50
01-103	Soldering Fixture for sparkplug launcher glass beads, package of 10	6	25KF50	Precision Matched K(f), Test Port Head	50
01-104	Drill and Tap Set for K Connectors	6	25L50	Precision Matched 3.5 mm(m), Test Port Head	50
01-105A	Male and Female Sparkplug Torquing Kit	6, 11	25LF50	Precision Matched 3.5 mm(f), Test Port Head	50
01-106	K Soldering Fixture for flange launcher glass bead, package of 5	6	25S50	Precision Matched WSMA(m), Test Port Head	50
01-107F	Cable Sleeve Soldering Fixture for K101F Female Cable Connectors, package of 10	6	25SF50	Precision Matched WSMA(f), Test Port Head	50
01-107M	Cable Sleeve Soldering Fixture for K101M Male Cable Connectors, package of 10	6	25SKF50	Precision Matched Set WSMA(m) and (f), K(m) and (f), AC coupled Test Port Head	50
01-108	Drill and Tap Set for K Connector with Sliding Contacts	6	25SLF50	Precision Matched Set WSMA(m) and (f), 3.5 mm(m) and (f), K(m) and (f), AC coupled Test Port Head	50
01-118	K Connector Cable Assembling Fixture Kit for K 118 semi-rigid coaxial cable	6	28A50-1	Termination, GPC-7	39
01-201	Torque wrench for SMA, 3.5 mm and K Connectors	6, 11	28K50	Termination, K(m)	39
01-204	Handy wrench for SMA, 3.5 mm, K, 2.4 mm and V Connectors	6, 11	28KF50	Termination, K(f)	39
01-301	V Connector Evaluation Kit	10	28N50-2	Termination, N(m)	39
01-303	Soldering Fixture for V sparkplug launcher glass beads, package of 10	10	28N50-3	Termination, N(m)	39
01-304	Drill and Tap Set for V connectors	10	28NF50-2	Termination, N(f)	39
01-306	Soldering fixture for flange launcher glass bead	11	28NF50-3	Termination, N(f)	39
01-307F	Cable sleeve soldering fixture, female connector	11	28S50-1	Termination, WSMA(f)	39
01-307M	Cable sleeve soldering fixture, male connector	11	28SF50-1	Termination, WSMA(f)	39
01-308	Drill and Tap set	11	28V50B	Termination, V(m)	39
01-309	V Connector Cable Assembling Fixture Kit	11	28VF50B	Termination, V(f)	39
01-501	Bullet Insertion and Removal Tool	15	28W50	Termination, W1(m)	39
01-502	Torque Screwdriver Adapter	15	28WF50	Termination, W1(f)	39
01-504	W1 6 mm Torque Wrench	18	29A50-20	Offset Termination, GPC-7	39
01-505	W1 6-7mm Open end Wrench	18	29K50-15	Offset Termination, K(m)	39
01-506	W1 7 mm Torque Wrench	18	29KF50-15	Offset Termination, K(f)	39
10-108	Diode Module, 71 & 73 Series	56	29S50-20	Offset Termination, WSMA(m)	39
10-75	Diode Module, 75A50	56	29SF50-20	Offset Termination, WSMA(f)	39
11N50B	RF Power Divider, 1 MHz to 3 GHz	62	33KFKF50B	Calibration Grade Adapter, DC to 40 GHz, K(f) to K(f)	26
12N50-75B	Matching Pad, N(m) 50 Ω to N(f) 75 Ω	82	33KK50B	Calibration Grade Adapter, DC to 40 GHz, K(m) to K(m)	26
12N75B	Impedance Adapter, N(m) 50 Ω to N(f) 75 Ω	83	33KKF50B	Calibration Grade Adapter, DC to 40 GHz, K(m) to K(f)	26
18A50	Air Line, GPC-7	51	33NFNF50B	Calibration Grade Adapter, DC to 18 GHz, N(f) to N(f)	26
18N50	Air Line, N(m)	51	33NN50B	Calibration Grade Adapter, DC to 18 GHz, N(m) to N(m)	26
18NF50	Air Line, N(f)	51	33NNF50B	Calibration Grade Adapter, DC to 18 GHz, N(m) to N(f)	26
19K50	Air Line, K(m)	51	33SFSF50	Calibration Grade Adapter, DC to 26.5 GHz, WSMA(f) to WSMA(f)	26
19KF50	Air Line, K(f)	51	33SS50	Calibration Grade Adapter, DC to 26.5 GHz, WSMA(m) to WSMA(m)	26
19S50	Air Line, WSMA(m)	51	33SSF50	Calibration Grade Adapter, DC to 26.5 GHz, WSMA(m) to WSMA(f)	26
19SF50	Air Line, WSMA(f)	51	33VFVF50B	Calibration Grade Adapter, DC to 40 GHz, V(f) to V(f)	26
1K50A	Limiter, K, 0.01 to 20 GHz	81	33VV50B	Calibration Grade Adapter, DC to 65 GHz, V(m) to V(m)	26
1K50B	Limiter, K, 0.01 to 26.5 GHz	81	33VVF50B	Calibration Grade Adapter, DC to 65 GHz, V(m) to V(f)	26
1N50B	Limiter, N, 0.01 to 3 GHz	81	33WFWF50	Calibration Grade Adapter, DC to 110 GHz, W1(f) to W1(f)	26
1N50C	Limiter, N, 0.01 to 18 GHz	81	33WW50	Calibration Grade Adapter, DC to 110 GHz, W1(m) to W1(m)	26
1N75B	Limiter, 75 Ω N, 0.01 to 3 GHz	81	33WWF50	Calibration Grade Adapter, DC to 110 GHz, W1(m) to W1(f)	26
1N75C	Limiter, 75 Ω N, 0.01 to 3 GHz	81	34AN50	Adapter, DC to 18 GHz, GPC-7 to N(m)	29
22K50	Open/Short, K(m)	50, 52	34ANF50	Adapter, DC to 18 GHz, GPC-7 to N(f)	29
22KF50	Open/Short, K(f)	50, 52			
22N50	Open/Short, N(m)	52			
22N75	Open/Short, 75 Ω N(m)	52			
22NF50	Open/Short, N(f)	52			
22NF75	Open/Short, 75 Ω N(f)	52			
22S50	Open/Short, WSMA(m)	52			
22SF50	Open/Short, WSMA(f)	52			
22V50	Open/Short, V(m)	52			
22VF50	Open/Short, V(f)	52			

PART NUMBER INDEX

Item	Description	Page	Item	Description	Page
34AS50	Adapter, DC to 18 GHz, GPC-7 to WSMA(m)	29	35WR15V	WG/Coax Adapter, WR15 to V(m)	31
34ASF50	Adapter, DC to 18 GHz, GPC-7 to WSMA(f)	29	35WR15VF	WG/Coax Adapter, WR15 to V(f)	31
34NFK50	Adapter, DC to 18 GHz, N(f) to K(m)	29	35WR19K	WG/Coax Adapter, WR19 to K(m)	31
34NFKF50	Adapter, DC to 3 GHz, N(f) to K(f)	29	35WR19KF	WG/Coax Adapter, WR19 to K(f)	31
34NFN50	Adapter, DC to 18 GHz, N(f) to N(f)	29	35WR19V	WG/Coax Adapter, WR19 to V(m)	31
34NFN50B	Adapter, DC to 18 GHz, 75 Ω N(f) to 75 Ω N(f)	29	35WR19VF	WG/Coax Adapter, WR19 to V(f)	31
34NK50	Adapter, DC to 18 GHz, N(m) to K(m)	29	35WR22K	WG/Coax Adapter, WR22 to K(m)	31
34NKF50	Adapter, DC to 18 GHz, N(m) to K(f)	29	35WR22KF	WG/Coax Adapter, WR22 to K(f)	31
34NN50A	Adapter, DC to 18 GHz, N(m) to N(m)	29	35WR22V	WG/Coax Adapter, WR22 to V(m)	31
34NN75B	Adapter, DC to 3 GHz, 75 Ω N(m) to 75 Ω N(m)	29	35WR22VF	WG/Coax Adapter, WR22 to V(f)	31
34RKNF50	Ruggedized Adapter, DC to 18 GHz, RK to N(f)	29	35WR28K	WG/Coax Adapter, WR28 to K(m)	31
34RKRK50	Ruggedized Adapter, DC to 40 GHz, RK to RK	29	35WR28KF	WG/Coax Adapter, WR28 to K(f)	31
34RSN50	Ruggedized Adapter, DC to 18 GHz, RS to N(m)	29	35WR42K	WG/Coax Adapter, WR42 to K(m)	31
34RVNF50	Ruggedized Adapter, DC to 18 GHz, RV to N(f)	29	35WR42KF	WG/Coax Adapter, WR42 to K(f)	31
34RVRK50	Ruggedized Adapter, DC to 40 GHz, RV to RK	29	35WRD180K	WG/Coax Adapter, WRD180 to K(m)	31
34RVRV50	Ruggedized Adapter, DC to 60 GHz, RV to RV	29	35WRD180KF	WG/Coax Adapter, WRD180 to K(f)	31
34SFSF50	Adapter, DC to 26.5 GHz, WSMA(f) to WSMA(f)	29	3650	Calibration Kit, SMA/3.5 mm	83
34VFK50	Adapter, DC to 40 GHz, V(f) to K(m)	24	3651	Calibration Kit, GPC-7	83
34VFKF50	Adapter, DC to 40 GHz, V(f) to K(f)	24	3652	Calibration Kit, K Connector	83
34VVF50	Adapter, DC to 40 GHz, V(f) to V(f)	24	3653	Calibration Kit, Type N	83
34VK50	Adapter, DC to 40 GHz, V(m) to K(m)	24	3654B	Calibration Kit, V Connector	83
34VKF50	Adapter, DC to 40 GHz, V(m) to K(f)	24	3655E	Calibration Kit, WR12 Waveguide	83
34VV50	Adapter, DC to 65 GHz, V(m) to V(m)	24	3655F	Calibration Kit, WR08 Waveguide	83
34VVF50	Adapter, DC to 65 GHz, V(m) to V(f)	24	3655V	Calibration Kit, WR15 Waveguide	83
34WV50	Adapter, W1(f) to V(m), DC to 65 GHz	30	3655W	Calibration Kit, WR10 Waveguide	83
34WV50	Adapter, W1(m) to V(m), DC to 65 GHz	30	3656	Calibration Kit, W1 Connector	83
34WVF50	Adapter, W1(m) to V(f), DC to 65 GHz	30	3663	Verification Kit, Type N	85
35CMR112N	Precision WG/Coax Adapter, WR112 to N(m)	35	3663R	Verification Kit, Type N, 9 GHz	85
35CMR137N	Precision WG/Coax Adapter, WR137 to N(m)	35	3665	Verification Kit, Waveguide	85
35CMR159N	Precision WG/Coax Adapter, WR159 to N(m)	35	3666	Verification Kit, SMA/3.5 mm	85
35CMR187N	Precision WG/Coax Adapter, WR187 to N(m)	35	3666R	Verification Kit, SMA/3.5 mm, 9 GHz	85
35CMR229N	Precision WG/Coax Adapter, WR229 to N(m)	35	3667	Verification Kit, GPC-7	85
35CMR90N	Precision WG/Coax Adapter, WR90 to N(m)	35	3667B	Verification Kit, GPC-7, 9 GHz	85
35UA112N	Precision WG/Coax Adapter, WR112 to N(m)	35	3668	Verification Kit, K Connector	85
35UA137N	Precision WG/Coax Adapter, WR137 to N(m)	35	3669B	Verification Kit, V Connector	85
35UA159N	Precision WG/Coax Adapter, WR159 to N(m)	35	3670A50-1	GPC-7, 1 Foot, Armored Semi-rigid Cable	23
35UA187N	Precision WG/Coax Adapter, WR187 to N(m)	35	3670A50-2	GPC-7, 2 Foot, Armored Semi-rigid Cable	23
35UA229N	Precision WG/Coax Adapter, WR229 to N(m)	35	3670K50-1	K(m) to K(f), 1 Foot, Armored Semi-rigid Cable	23
35UA42K	Precision WG/Coax Adapter, WR42 to K(m)	35	3670K50-2	K(m) to K(f), 2 Foot, Armored Semi-rigid Cable	23
35UA62N	Precision WG/Coax Adapter, WR62 to N(m)	35	3670KF50-1	K(f) to K(f), 1 Foot, Armored Semi-rigid Cable	23
35UA75N	Precision WG/Coax Adapter, WR75 to N(m)	35	3670KF50-2	K(f) to K(f), 2 Foot, Armored Semi-rigid Cable	23
35UA90N	Precision WG/Coax Adapter, WR90 to N(m)	35	3670N50-1	N(m) to N(f), 1 Foot, Armored Semi-rigid Cable	23
35UER100N	Precision WG/Coax Adapter, WR90 to N(m)	35	3670N50-2	N(m) to N(f), 2 Foot, Armored Semi-rigid Cable	23
35UER40N	Precision WG/Coax Adapter, WR229 to N(m)	35	3670NN50-1	N(m) to N(m), 1 Foot, Armored Semi-rigid Cable	23
35UER48N	Precision WG/Coax Adapter, WR187 to N(m)	35	3670NN50-2	N(m) to N(m), 2 Foot, Armored Semi-rigid Cable	23
35UER58N	Precision WG/Coax Adapter, WR159 to N(m)	35	3670V50-1	V(m) to V(f), 1 Foot, Armored Semi-rigid Cable	23
35UER70N	Precision WG/Coax Adapter, WR137 to N(m)	35	3670V50-2	V(m) to V(f), 2 Foot, Armored Semi-rigid Cable	23
35UER84N	Precision WG/Coax Adapter, WR112 to N(m)	35	36801K	Universal Test Fixture Accessories, Right-Angle Launcher (40 GHz)	78
35UM100N	Precision WG/Coax Adapter, WR90 to N(m)	35	36801V	Universal Test Fixture Accessories, Right-Angle Launcher (60 GHz)	78
35UM120N	Precision WG/Coax Adapter, WR75 to N(m)	35	36802	Universal Test Fixture Accessories, MMIC Attachment	78
35UM140N	Precision WG/Coax Adapter, WR62 to N(m)	35	3680-20	Universal Test Fixture Main frame (20 GHz)	78
35UM220K	Precision WG/Coax Adapter, WR42 to K(m)	35	36803	Universal Test Fixture Accessories, Bias Probe	78
35UM40N	Precision WG/Coax Adapter, WR229 to N(m)	35	36804B-10M	Universal Test Fixture Calibration/verification kits, 10 mil microstrip	78
35UM48N	Precision WG/Coax Adapter, WR187 to N(m)	35	36804B-15M	Universal Test Fixture Calibration/verification kits, 15 mil microstrip	78
35UM58N	Precision WG/Coax Adapter, WR159 to N(m)	35			
35UM70N	Precision WG/Coax Adapter, WR137 to N(m)	35			
35UM84N	Precision WG/Coax Adapter, WR112 to N(m)	35			
35WR10W	WG/Coax Adapter, WR 10 to W1(m)	31			
35WR10WF	WG/Coax Adapter, WR 10 to W1(f)	31			

PART NUMBER INDEX

Item	Description	Page	Item	Description	Page
36804B-25C	Universal Test Fixture Calibration/verification kits, 25 mil coplanar waveguide	78	560-7VA50	Microwave Detector, 10 MHz to 50 GHz, V(m), 50 Ω	57
36804B-25M	Universal Test Fixture Calibration/verification kits, 25 mil microstrip	78	560-97A50	Autotester, 10 MHz to 18 GHz, GPC-7, 36 dB directivity	46
36805-10M	Universal Test Fixture Accessories, 10 mil launchers	78	560-97A50-1	Autotester, 10 MHz to 18 GHz, GPC-7, 40 dB directivity	46
36805-15M	Universal Test Fixture Accessories, 15 mil launchers	78	560-97A50-20	Offset Autotester, 10 MHz to 18 GHz, GPC-7, 20 dB	46
36805-25M	Universal Test Fixture Accessories, 25 mil launchers	78	560-97N50	Autotester, 10 MHz to 18 GHz, N(m), 35 dB directivity	46
3680K	Universal Test Fixture Main frame (40 GHz)	78	560-97N50-1	Autotester, 10 MHz to 18 GHz, N(m), 38 dB directivity	46
3680V	Universal Test Fixture Main frame (60 GHz)	78	560-97NF50	Autotester, 10 MHz to 18 GHz, N(f), 35 dB directivity	46
3750R	Calibration Kit, SMA/3.5 mm, 9 GHz	83	560-97NF50-1	Autotester, 10 MHz to 18 GHz, N(f), 38 dB directivity	47
3751R	Calibration Kit, GPC-7, 9 GHz	83	560-98C50A	Convertible Autotester, 10 MHz to 40 GHz	49
3753-75R	Calibration Kit, 75 Ω, Type N, 3 GHz	83	560-98K50	Autotester, 10 MHz to 40 GHz, K(m), 35 dB directivity	47
3753R	Calibration Kit, Type N, 9 GHz	83	560-98KF50	Autotester, 10 MHz to 40 GHz, K(f), 35 dB directivity	47
41KB-10	Precision Fixed Attenuator, 10 dB, 26.5 GHz	41	560-98KF50-15	Offset Autotester, 10 MHz to 40 GHz, K(f), 15 dB	47
41KB-20	Precision Fixed Attenuator, 20 dB, 26.5 GHz	41	560-98S50	Autotester, 10 MHz to 26.5 GHz, WSMA(m), 37 dB directivity	47
41KB-3	Precision Fixed Attenuator, 3 dB, 26.5 GHz	41	560-98S50-1	Autotester, 10 MHz to 26.5 GHz, WSMA(m), 40 dB directivity	47
41KB-6	Precision Fixed Attenuator, 6 dB, 26.5 GHz	41	560-98SF50	Autotester, 10 MHz to 26.5 GHz, WSMA(f), 37 dB directivity	47
41KB-S	Precision Fixed Attenuator Set, 26.5 GHz	41	560-98SF50-1	Autotester, 10 MHz to 26.5 GHz, WSMA(f), 40 dB directivity	47
41KC-10	Precision Fixed Attenuator, 10 dB, 40 GHz	41	560-98VA50	Autotester, 10 MHz to 50 GHz, V(m), 36 dB directivity	47
41KC-20	Precision Fixed Attenuator, 20 dB, 40 GHz	41	560-98VFA50	Autotester, 10 MHz to 50 GHz, V(m), 36 dB directivity	47
41KC-3	Precision Fixed Attenuator, 3 dB, 40 GHz	41	70KA50	Detector, K(m), 0.01 to 20 GHz	54
41KC-6	Precision Fixed Attenuator, 6 dB, 40 GHz	41	70KC50	Detector, K(m), 0.01 to 40 GHz	54
41KC-S	Precision Fixed Attenuator Set, 40 GHz	41	75KC50	Detector, K(m), 0.01 to 40 GHz	54
41V-10	Precision Fixed Attenuator, 10 dB, 65 GHz	41	75N50B	Detector, N(m), 0.01 to 18 GHz	54
41V-20	Precision Fixed Attenuator, 20 dB, 65 GHz	41	75VA50	Detector, V(m), 0.01 to 50 GHz	54
41V-3	Precision Fixed Attenuator, 3 dB, 65 GHz	41	87A50	Broadband SWR Bridge, 2 to 18 GHz	45
41V-6	Precision Fixed Attenuator, 6 dB, 65 GHz	41	87A50-1	Broadband SWR Bridge, 2 to 18 GHz, High Directivity	45
41V-S	Precision Fixed Attenuator Set, 65 GHz	41	97A50	Autotester, GPC-7, 0.01 to 18 GHz	46
43KB-10	Fixed Attenuator, 10 dB, 26.5 GHz	41	A16176	Diode Module, (≥20 GHz)	56
43KB-20	Fixed Attenuator, 20 dB, 26.5 GHz	41	A16177	Diode Module, (≤20 GHz)	56
43KB-3	Fixed Attenuator, 3 dB, 26.5 GHz	41	A18735	Diode Module, 74N50B	56
43KB-6	Fixed Attenuator, 6 dB, 26.5 GHz	41	B16132	Diode Module, 75N50B	56
43KC-10	Fixed Attenuator, 10 dB, 40 GHz	41	DBT60	Bias Termination, 0.25 mm Microstrip	67
43KC-20	Fixed Attenuator, 20 dB, 40 GHz	41	DBT60CPW	Bias Termination, 0.25 mm CPW substrate	67
43KC-3	Fixed Attenuator, 3 dB, 40 GHz	41	K100	Glass Beads for K102, K103, and K104 connectors	8
43KC-6	Fixed Attenuator, 6 dB, 40 GHz	41	K100B	High Hermeticity Glass Beads for K102, K103, and K104 connectors	8
4412K	Step Attenuator, DC to 20 GHz, 70 dB	43	K101F	K Female In-Line Cable Connector, DC to 40 GHz for 3.00 mm K118 cable	7
4422K	Step Attenuator, DC to 20 GHz, 110 dB	43	K101M	K Male In-Line Cable Connector, DC to 40 GHz for 3.00 mm K118 cable	7
4512K	Step Attenuator, DC to 26.5 GHz, 70 dB	43	K101M-085	K Male In-Line Cable Connector, DC to 40 GHz for 2.18 mm V085 cable	7
4522K	Step Attenuator, DC to 26.5 GHz, 110 dB	43	K102F	K Female Sparkplug Launcher Connector, DC to 40 GHz	7
4612K	Step Attenuator, DC to 40 GHz, 70 dB	43			
4622K	Step Attenuator, DC to 40 GHz, 110 dB	43			
5400-6N50	Autotester, 1 to 3000 MHz, N(m), 50 Ω	48			
5400-6N75	Autotester, 1 to 3000 MHz, N(m), 75 Ω	48			
5400-6NF50	Autotester, 1 to 3000 MHz, N(f), 50 Ω	48			
5400-6NF75	Autotester, 1 to 3000 MHz, N(f), 75 Ω	48			
5400-71N50	Microwave Detector, 1 MHz to 3 GHz, N(m), 50 Ω	57			
5400-71N75	Microwave Detector, 1 MHz to 3 GHz, N(m), 75 Ω	57			
5400-71N75L	Microwave Detector, 5 MHz to 1.2 GHz, N(m), 75 Ω	57			
560-7A50	Microwave Detector, 10 MHz to 18 GHz, GPC-7, 50 Ω	57			
560-7K50	Microwave Detector, 10 MHz to 40 GHz, K(m), 50 Ω	57			
560-7N50B	Microwave Detector, 10 MHz to 20 GHz, N(m), 50 Ω	57			
560-7S50-2	Microwave Detector, 10 MHz to 26.5 GHz, WSMA(m), 50 Ω	57			
560-7S50B	Microwave Detector, 10 MHz to 20 GHz, WSMA(m), 50 Ω	57			

PART NUMBER INDEX

Item	Description	Page	Item	Description	Page
K102M	K Male Sparkplug Launcher Connector, DC to 40 GHz	7	N120-6	Semi-rigid Cable, N(m) to N(m), DC to 18 GHz, 15.2 cm	20
K103F	K Female Flange Launcher, two-hole, DC to 40 GHz	7	N241A50	Power Splitter, DC to 3000 MHz	65
K103M	K Male Flange Launcher, two-hole, DC to 40 GHz	7	NS120MF-6	Semi-rigid Cable, N(m) to SMA(f), DC to 18 GHz, 15.2 cm	20
K104F	K Female Flange Launcher, four-hole, DC to 40 GHz	7	OSLN50LF	Open/Short/Load, DC to 4 GHz, N(m), 50 Ω	53
K104M	K Male Flange Launcher, two-hole, DC to 40 GHz	7	OSLNF50LF	Open/Short/Load, DC to 4 GHz, N(f), 50 Ω	53
K110-1	Stress relief Contact, Microstrip and Coplanar Waveguide	8	S110-1	Microstrip and coplanar waveguide stress relief contact for 0.38 mm glass feedthru center conductor	8
K110-2	Stress relief Contact, Stripline	8	S110-3	Microstrip and coplanar waveguide stress relief contact for 0.38 mm glass feedthru center conductor	8
K110-3	Stress relief Contact, Microstrip	8	SC4734	SPDT Switch, 60 GHz	66
K118	1.5 m length of 3.00 mm semi-rigid cable for K101 series connector	6	SC6135	SPDT Switch, 65 GHz	66
K120FF	Semi-rigid Cable, K(f) to K(f), DC to 40 GHz	20	V085	1.52 m length of 2.18 mm semi-rigid cable for V101 series connector	11
K120MF	Semi-rigid Cable, K(m) to K(f), DC to 40 GHz	20	V100	Glass Beads for V102, and V103 connectors	13
K120MM	Semi-rigid Cable, K(m) to K(m), DC to 40 GHz	20	V100B	Glass Beads for V102, and V103 connectors, Hermetic	13
K210	Coaxial Termination, K(m)	40	V101F	V Female In-Line Cable Connector, DC to 65 GHz for V085 cable	12
K220B	Adapter, K(m) to K(m)	24	V101M	V Male In-Line Cable Connector, DC to 65 GHz for V085 cable	12
K222B	Adapter, K(f) to K(f)	24	V102F	V Female Sparkplug Launcher Connector, DC to 65 GHz	12
K224B	Adapter, K(f) to K(m)	24	V102M	V Male Sparkplug Launcher Connector, DC to 65 GHz	12
K230B	Panel Mount Adapter, K(m) to K(m)	25	V103F	V Female Flange Launcher, two-hole, DC to 65 GHz	12
K232B	Panel Mount Adapter, K(f) to K(f)	25	V103F-012	V(f) flange launcher, 2 mounting holes for 0.30 mm glass bead pin, DC to 65 GHz	12
K234B	Panel Mount Adapter, K(f) to K(m)	25	V103M	V Male Flange Launcher, two-hole, DC to 65 GHz	12
K240B	Precision Power Divider, DC to 26.5 GHz	63	V103M-012	V(m) flange launcher, 2 mounting holes for 0.30 mm glass bead pin, DC to 65 GHz	12
K240C	Precision Power Divider, DC to 40 GHz	63	V110-1	Stress Relief Contact for Microstrip and Coplanar Waveguide	11
K241B	Power Splitter, DC to 26.5 GHz	64	V115FCPW	Integrated V(f) Solder-in Connector for Coplanar Waveguide, DC to 65 GHz	14
K241C	Power Splitter, DC to 40 GHz	64	V115FMS10	Integrated V(f) Solder-in Connector for use with 0.25 mm substrates, DC to 65 GHz	14
K250	Bias Tee, 0.1 to 40 GHz	68	V115FMS75	Integrated V(f) Solder-in Connector for use with 0.19 mm substrates, DC to 65 GHz	14
K251	Bias Tee, 50 kHz to 40 GHz	69	V116F	Integrated V(f) Sparkplug Connector, DC to 65 GHz	14
K252	Kelvin Bias Tee, 0.1 to 40 GHz	71	V120FF	Semi-rigid Cable, V(f) to V(f), DC to 65 GHz	20
K261	Precision DC Block, 50 kHz to 40 GHz	74	V120MF	Semi-rigid Cable, V(m) to V(f), DC to 65 GHz	20
MA2400/98	Power Sensor, Z540/Guide 25 Calibration	58	V120MM	Semi-rigid Cable, V(m) to V(m), DC to 65 GHz	20
MA2400/99	Power Sensor, Premium Calibration	58	V210	Coaxial Termination, V(m)	40
MA2411A	Pulse Sensor, 300 MHz to 40 GHz	58	V230	Panel Mount Adapter, V(m) to V(m)	25
MA2421D	Thermal Sensor, 0.1 MHz to 18 GHz	58	V232	Panel Mount Adapter, V(f) to V(f)	25
MA2422D	Thermal Sensor, 10 MHz to 18 GHz	58	V234	Panel Mount Adapter, V(f) to V(m)	25
MA2423D	Thermal Sensor, 10 MHz to 32 GHz	58	V240C	Precision Power Divider, DC to 65 GHz	63
MA2424D	Thermal Sensor, 10 MHz to 40 GHz	58	V241C	Power Splitter, DC to 65 GHz	64
MA2425D	Thermal Sensor, 10 MHz to 50 GHz	58	V250	Bias Tee, 0.1 to 60 GHz	68
MA2442D	High Accuracy Sensor, 10 MHz to 18 GHz	58	V251	Bias Tee, 100 kHz to 65 GHz	69
MA2444D	High Accuracy Sensor, 10 MHz to 40 GHz	58	V252	Kelvin Bias Tee, 0.1 to 65 GHz	71
MA2445D	High Accuracy Sensor, 10 MHz to 50 GHz	58	V255	Ultra-Wideband Bias Tee, 50 kHz to 65 GHz	72
MA2468D	Fast Diode Sensor, 10 MHz to 6 GHz	58	V261	Precision DC Block, 100 kHz to 65 GHz	74
MA2469D	Fast Diode Sensor, 10 MHz to 18 GHz	58	V265	DC Block, 50 kHz to 65 GHz	76
MA2472D	Power Sensor, 10 MHz to 18 GHz	58			
MA2473D	Power Sensor, 10 MHz to 32 GHz	58			
MA2474D	Power Sensor, 10 MHz to 40 GHz	58			
MA2475D	Power Sensor, 10 MHz to 50 GHz	58			
MA2480/01	Power Sensor, Option 1, Universal Power Sensor	58			
MA2481D	Power Sensor, Universal Power Sensor, 10 MHz to 6 GHz	52			
MA2482D	Power Sensor, Universal Power Sensor, 10 MHz to 18 GHz	58			
MA2490A	Wideband Sensor, 50 MHz to 8 GHz	58			
MA2491A	Wideband Sensor, 50 MHz to 18 GHz	58			
MA2497A	Power Sensor, Agilent (HP) Sensor adapter	58			
MA2499B	Power Sensor, Anritsu Sensor 10 to 12 pin Adapter	58			

PART NUMBER INDEX

Item	Description	Page	Item	Description	Page
VP100B	Screw-in Hermetic Shroud, DC to 65 GHz	15	W1-101F	W1(f) In-line Cable Connector, DC to 110 GHz	18
VP100BCPW	Solder-in CPW Hermetic Shroud	15	W1-101M	W1(m) In-line Cable Connector, DC to 110 GHz	18
VP100BMS75	Solder-in 7.5 mil Microstrip Hermetic Shroud	16	W1-102F	W1(f) Sparkplug Connector, Hermetic, DC to 110 GHz	19
VP100BMS10	Solder-in 10 mil Microstrip Hermetic Shroud	16	W1-102M	W1(m) Sparkplug Connector, Hermetic, DC to 110 GHz	18
VP100BNL	No Lip Hermetic Shroud	16	W1-103F	W1(f) Flange Connector, DC to 110 GHz	19
VP101F	VP Cable Adapter	16	W1-105F	W1(f) Sparkplug Connector, DC to 110 GHz	19
VP102F	VP Bullet	16	W1-105M	W1(m) Sparkplug Connector, DC to 110 GHz	18
VP103F	VP-VF Adapter	16			
VP104F	VP-SMPM Bullet	16			
W047-2	Semi-rigid Coaxial Cable	19			

NOTES

NOTES

POWER CONVERSION TABLE

Power (dBm)	P (mW)	Volts ms into 50 Ω	Volts Peak	Volts Peak to Peak
-60	0.00000100	0.000224	0.000316	0.00063
-59	0.00000126	0.000251	0.000355	0.00071
-58	0.00000158	0.000282	0.000398	0.00080
-57	0.00000200	0.000316	0.000447	0.00089
-56	0.00000251	0.000354	0.000501	0.00100
-55	0.00000316	0.000398	0.000562	0.00112
-54	0.00000398	0.000446	0.000631	0.00126
-53	0.00000501	0.000501	0.000708	0.00142
-52	0.00000631	0.000562	0.000794	0.00159
-51	0.00000794	0.000630	0.000891	0.00178
-50	0.00000100	0.000707	0.001000	0.00200
-49	0.00000126	0.000793	0.001122	0.00224
-48	0.00000158	0.000890	0.001259	0.00252
-47	0.00000200	0.00100	0.001413	0.00283
-46	0.00000251	0.00112	0.001585	0.00317
-45	0.00000316	0.00126	0.001778	0.00356
-44	0.00000398	0.00141	0.001995	0.00399
-43	0.00000501	0.00158	0.002239	0.00448
-42	0.00000631	0.00178	0.002512	0.00502
-41	0.00000794	0.00199	0.002818	0.00564
-40	0.00000100	0.00224	0.003162	0.00632
-39	0.00000126	0.00251	0.003548	0.00710
-38	0.00000158	0.00282	0.003981	0.00796
-37	0.00000200	0.00316	0.004467	0.00893
-36	0.00000251	0.00354	0.005012	0.0100
-35	0.00000316	0.00398	0.005623	0.0112
-34	0.00000398	0.00446	0.006310	0.0126
-33	0.00000501	0.00501	0.007079	0.0142
-32	0.00000631	0.00562	0.007943	0.0159
-31	0.00000794	0.00630	0.008913	0.0178
-30	0.0010	0.00707	0.010000	0.0200
-29	0.0013	0.00793	0.011220	0.0224
-28	0.0016	0.00890	0.012589	0.0252
27	0.0020	0.00999	0.014125	0.0283
-26	0.0025	0.01121	0.015849	0.0317
-25	0.0032	0.01257	0.017783	0.0356
-24	0.0040	0.01411	0.019953	0.0399
-23	0.0050	0.01583	0.022387	0.0448
-22	0.0063	0.01776	0.025119	0.0502
-21	0.0079	0.01993	0.028184	0.0564
-20	0.0100	0.02236	0.031623	0.0632
-19	0.0126	0.02509	0.035481	0.0710
-18	0.0158	0.02815	0.039811	0.0796
-17	0.0200	0.03159	0.044668	0.0893
-16	0.0251	0.03544	0.050119	0.1002
-15	0.0316	0.03976	0.056234	0.1125
-14	0.0398	0.04462	0.063096	0.1262
-13	0.0501	0.05006	0.070795	0.1416
-12	0.0631	0.05617	0.079433	0.1589
-11	0.0794	0.06302	0.089125	0.1783
-10	0.1000	0.07071	0.100000	0.2000

Power (dBm)	P (mW)	Volts ms into 50 Ω	Volts Peak	Volts Peak to Peak
-9	0.1259	0.07934	0.112	0.2244
-8	0.1585	0.08902	0.126	0.2518
-7	0.1995	0.09988	0.141	0.2825
-6	0.2512	0.11207	0.158	0.3170
-5	0.3162	0.12574	0.178	0.3557
-4	0.3981	0.14109	0.200	0.3991
-3	0.5012	0.15830	0.224	0.4477
-2	0.6310	0.17762	0.251	0.5024
-1	0.7943	0.19929	0.282	0.5637
0	1.0000	0.22361	0.316	0.6325
1	1.259	0.25089	0.355	0.7096
2	1.585	0.28150	0.398	0.7962
3	1.995	0.31585	0.447	0.8934
4	2.512	0.35439	0.501	1.0024
5	3.162	0.39764	0.562	1.1247
6	3.981	0.44615	0.631	1.2619
7	5.012	0.50059	0.708	1.4159
8	6.310	0.56167	0.794	1.5887
9	7.943	0.63021	0.891	1.7825
10	10.000	0.70711	1.000	2.0000
11	12.589	0.79339	1.122	2.2440
12	15.849	0.89019	1.259	2.5179
13	19.953	0.99881	1.413	2.8251
14	25.119	1.12069	1.585	3.1698
15	31.623	1.25743	1.778	3.5566
16	39.811	1.41086	1.995	3.9905
17	50.119	1.58301	2.239	4.4774
18	63.096	1.77617	2.512	5.0238
19	79.433	1.99290	2.818	5.6368
20	100.000	2.23607	3.162	6.3246
21	125.893	2.50891	3.548	7.0963
22	158.489	2.81504	3.981	7.9621
23	199.526	3.15853	4.467	8.9337
24	251.189	3.54393	5.012	10.0237
25	316.228	3.97635	5.623	11.2468
26	398.107	4.46154	6.310	12.6191
27	501.187	5.00593	7.079	14.1589
28	630.957	5.61675	7.943	15.8866
29	794.328	6.30210	8.913	17.8250
30	1000.000	7.07107	10.000	20.0000
31	1258.925	7.93387	11.220	22.4404
32	1584.893	8.90195	12.589	25.1785
33	1995.262	9.98815	14.125	28.2508
34	2511.886	11.20689	15.849	31.6979
35	3162.278	12.57433	17.783	35.5656
36	3981.072	14.10864	19.953	39.9052
37	5011.872	15.83015	22.387	44.7744
38	6309.573	17.76172	25.119	50.2377
39	7943.282	19.92898	28.184	56.3677
40	10000.000	22.36068	31.623	63.2456
41	12589.254	25.08910	35.481	70.9627

Microwave Measurement Division
490 Jarvis Drive
Morgan Hill, CA 95037-2809
<http://www.us.anritsu.com>
FAX (408) 778-0239

SALES OFFICES

UNITED STATES and LATIN AMERICA

ANRITSU COMPANY

1155 East Collins Boulevard,
Richardson, TX 75081, USA
Telephone: +1-800-ANRITSU (+1-800-267-4878)
www.us.anritsu.com
E-mail: us-sales@anritsu.com

CANADA

ANRITSU ELECTRONICS LTD.

700 Silver Seven Road Suite #120,
Kanata, Ontario K2V 1C3, Canada
Telephone: +1-800-ANRITSU (+1-800-267-4878)

EUROPE - UK

ANRITSU LIMITED

200 Capability Green, Luton,
Bedfordshire LU1 3LU, U.K.
Telephone: +44-1582-433433
www.eu.anritsu.com
E-mail: info@eu.anritsu.com

SOUTH AMERICA

ANRITSU ELETRONICA, LTDA.

Rua Voluntarios da Patria,
45 13 Andar Botafogo CEP 22270-000,
Rio de Janeiro, RJ Brazil
Telephone: +55-21-2527-6922

JAPAN

ANRITSU CORPORATION

1800 Onna, Atsugi-shi, Kanagawa,
243-8555 Japan
Telephone: +81-46-223-1111

ASIA-PACIFIC

ANRITSU COMPANY LIMITED

Suite 923, 9/F, Chinachem Golden Plaza,
77 Mody Road, Tsimshatsui East,
Kowloon, Hong Kong
Telephone: +852-2301-4980



ANRITSU Corporation Head Office
Atsugi, Japan



ANRITSU Limited
Luton, United Kingdom



ANRITSU Company
Morgan Hill, California, U.S.A.

To locate your local sales office visit: www.us.anritsu.com



Sales Centers:

US	(800) ANRITSU
Canada	(800) ANRITSU
South America	55 (21) 2527-6922
Europe	44 (0) 1582-433433
Japan	81 (46) 223-1111
Asia-Pacific	(852) 2301-4980

©Anritsu, September 2005; Made in U.S.A.
11410-00235, Rev: E
Data subject to change without notice
Precision RF & Microwave Components Catalog