

Errata

Title & Document Type: 3561A Dynamic Signal Analyzer Operating Manual

Manual Part Number: 03561-90002

Revision Date: December 1985

HP References in this Manual

This manual may contain references to HP or Hewlett-Packard. Please note that Hewlett-Packard's former test and measurement, semiconductor products and chemical analysis businesses are now part of Agilent Technologies. We have made no changes to this manual copy. The HP XXXX referred to in this document is now the Agilent XXXX. For example, model number HP8648A is now model number Agilent 8648A.

About this Manual

We've added this manual to the Agilent website in an effort to help you support your product. This manual provides the best information we could find. It may be incomplete or contain dated information, and the scan quality may not be ideal. If we find a better copy in the future, we will add it to the Agilent website.

Support for Your Product

Agilent no longer sells or supports this product. You will find any other available product information on the Agilent Test & Measurement website:

www.tm.agilent.com

Search for the model number of this product, and the resulting product page will guide you to any available information. Our service centers may be able to perform calibration if no repair parts are needed, but no other support from Agilent is available.



HEWLETT
PACKARD

MODEL 3561A DYNAMIC SIGNAL ANALYZER OPERATING MANUAL

WARNING

To help minimize the possibility of electrical fire or shock hazards, do not expose this instrument to rain or excessive moisture.

Manual Part Number 03561-90002
Microfiche Part Number 03561-90052

© Copyright by Hewlett-Packard Company 1983,1985
8600 Soper Hill Road, Everett, Washington 98205-1298

Printed: December 1985

Printed in U.S.A.

SAFETY SYMBOLS

General Definitions of Safety Symbols Used On Equipment or In Manuals.



Instruction manual symbol: the product will be marked with this symbol when it is necessary for the user to refer to the instruction manual in order to protect against damage to the instrument.



Indicates dangerous voltage (terminals fed from the interior by voltage exceeding 1000 volts must be so marked).

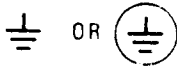

Protective conductor terminal. For protection against electrical shock in case of a fault. Used with field wiring terminals to indicate the terminal which must be connected to ground before operating equipment.



Low-noise or noiseless, clean ground (earth) terminal. Used for a signal common, as well as providing protection against electrical shock in case of a fault. A terminal marked with this symbol must be connected to ground in the manner described in the installation (operating) manual, and before operating the equipment.

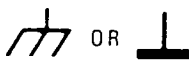

Frame or chassis terminal. A connection to the frame (chassis) of the equipment which normally includes all exposed metal structures.



Alternating current (power line).



Direct current (power line).



Alternating or direct current (power line).

WARNING

The WARNING sign denotes a hazard. It calls attention to a procedure, practice, condition or the like, which, if not correctly performed or adhered to, could result in injury or death to personnel.

CAUTION

The CAUTION sign denotes a hazard. It calls attention to an operating procedure, practice, condition or the like, which, if not correctly performed or adhered to, could result in damage to or destruction of part or all of the product.

NOTE :

The NOTE sign denotes important information. It calls attention to procedure, practice, condition or the like, which is essential to highlight.



SAFETY SUMMARY

The following general safety precautions must be observed during all phases of operation, service, and repair of this instrument. Failure to comply with these precautions or with specific warnings elsewhere in this manual violates safety standards of design, manufacture, and intended use of the instrument. Hewlett-Packard Company assumes no liability for the customer's failure to comply with these requirements. This is a Safety Class 1 instrument.

GROUND THE INSTRUMENT

To minimize shock hazard, the instrument chassis and cabinet must be connected to an electrical ground. The instrument is equipped with a three-conductor ac power cable. The power cable must either be plugged into an approved three-contact electrical outlet or used with a three-contact to two-contact adapter with the grounding wire (green) firmly connected to an electrical ground (safety ground) at the power outlet. The power jack and mating plug of the power cable meet International Electrotechnical Commission (IEC) safety standards.

DO NOT OPERATE IN AN EXPLOSIVE ATMOSPHERE

Do not operate the instrument in the presence of flammable gases or fumes. Operation of any electrical instrument in such an environment constitutes a definite safety hazard.

KEEP AWAY FROM LIVE CIRCUITS

Operating personnel must not remove instrument covers. Component replacement and internal adjustments must be made by qualified maintenance personnel. Do not replace components with power cable connected. Under certain conditions, dangerous voltages may exist even with the power cable removed. To avoid injuries, always disconnect power and discharge circuits before touching them.

DO NOT SERVICE OR ADJUST ALONE

Do not attempt internal service or adjustment unless another person, capable of rendering first aid and resuscitation, is present.

DO NOT SUBSTITUTE PARTS OR MODIFY INSTRUMENT

Because of the danger of introducing additional hazards, do not install substitute parts or perform any unauthorized modification to the instrument. Return the instrument to a Hewlett-Packard Sales and Service Office for service and repair to ensure that safety features are maintained.

DANGEROUS PROCEDURE WARNINGS

Warnings, such as the example below, precede potentially dangerous procedures throughout this manual. Instructions contained in the warnings must be followed.

WARNING

Dangerous voltages, capable of causing death, are present in this instrument. Use extreme caution when handling, testing, and adjusting.



CERTIFICATION

Hewlett-Packard Company certifies that this product met its published specifications at the time of shipment from the factory. Hewlett-Packard further certifies that its calibration measurements are traceable to the United States National Bureau of Standards, to the extent allowed by the Bureau's calibration facility, and to the calibration facilities of other International Standards Organization members.

WARRANTY

This Hewlett-Packard product is warranted against defects in material and workmanship for a period of one year from date of shipment [except that in the case of certain components listed in Section I of this manual, the warranty shall be for the specified period]. During the warranty period, Hewlett-Packard Company will, at its option, either repair or replace products which prove to be defective.

For warranty service or repair, this product must be returned to a service facility designated by -hp-. Buyer shall prepay shipping charges to -hp- and -hp- shall pay shipping charges to return the product to Buyer. However, Buyer shall pay all shipping charges, duties, and taxes for products returned to -hp- from another country.

HP software and firmware products which are designated by HP for use with a hardware product, when properly installed on that hardware product, are warranted not to fail to execute their programming instructions due to defects in materials and workmanship. If HP receives notice of such defects during the warranty period, HP shall repair or replace software media and firmware which do not execute their programming instructions due to such defects. HP does not warrant that the operation of the software, firmware or hardware shall be uninterrupted or error free.

LIMITATION OF WARRANTY

The foregoing warranty shall not apply to defects resulting from improper or inadequate maintenance by Buyer, Buyer-supplied software or interfacing, unauthorized modification or misuse, operation outside of the environmental specifications for the product, or improper site preparation or maintenance.

NO OTHER WARRANTY IS EXPRESSED OR IMPLIED. HEWLETT-PACKARD SPECIFICALLY DISCLAIMS THE IMPLIED WARRANTIES OF MERCHANTABILITY AND FITNESS FOR A PARTICULAR PURPOSE.

EXCLUSIVE REMEDIES

THE REMEDIES PROVIDED HEREIN ARE BUYER'S SOLE AND EXCLUSIVE REMEDIES. HEWLETT-PACKARD SHALL NOT BE LIABLE FOR ANY DIRECT, INDIRECT, SPECIAL, INCIDENTAL, OR CONSEQUENTIAL DAMAGES, WHETHER BASED ON CONTRACT, TORT, OR ANY OTHER LEGAL THEORY.

ASSISTANCE

Product maintenance agreements and other customer assistance agreements are available for Hewlett-Packard products.

For any assistance, contact your nearest Hewlett-Packard Sales and Service Office. Addresses are provided at the back of this manual.

TABLE OF CONTENTS
-hp-3561A DYNAMIC SIGNAL ANALYZER OPERATING MANUAL

	PREFACE	
CHAPTER I	OPERATOR'S INTRODUCTION	1
CHAPTER II	OPERATOR'S REFERENCE	59
CHAPTER III	HP-IB OPERATION	101
CHAPTER IV	HP-IB COMMANDS	111
CHAPTER V	INSTALLATION	173
APPENDIX A	QUICK REFERENCE	I
APPENDIX B	OVERVIEW OF DYNAMIC SIGNAL ANALYSIS	V
APPENDIX C	OPERATING DIAGNOSTIC MESSAGES	XIX
APPENDIX D	COMMON MEASUREMENTS AND MATH FUNCTIONS	XXXV
APPENDIX E	SPECIFICATIONS	XXXIX

-hp-3561A DYNAMIC SIGNAL ANALYZER OPERATING MANUAL PREFACE

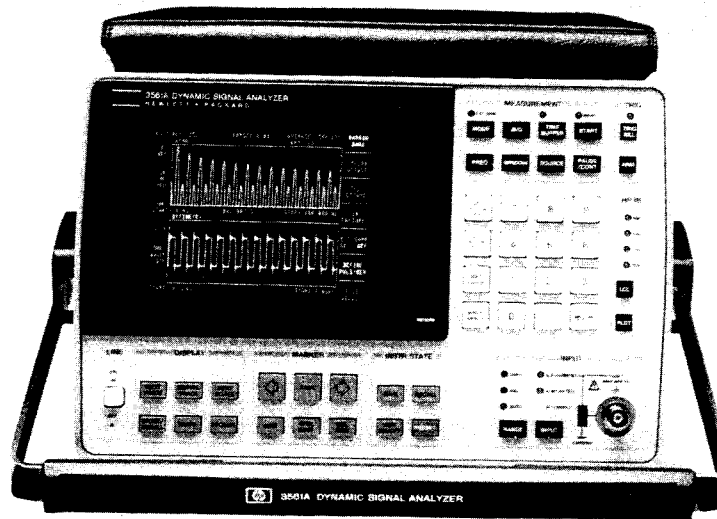

The -hp- Model 3561A is a single channel Fast Fourier Transform (FFT) signal analyzer covering the frequency range to 100 kHz. The -hp-3561A measurement capabilities include magnitude, phase, and time displays in a narrow band, 1/3 octave, or full octave format. Narrow band data can be captured and stored in the time buffer for processing with alternate setups without acquiring new data. Resolution in the narrow band mode is 250 Hz for a full 100 kHz display span and 25.6 μ Hz for the 0.01 Hz display span. The -hp-3561A measures input signals from +27 dBV (22.39 Vrms) down to -51 dBV (+2.82 mVrms). The 80 dB dynamic range of the -hp-3561A allows measurement of signals where the signal of interest exists in the presence of large unwanted signals.

The signal processing capabilities of the -hp-3561A include rms averaging, rms exponential weighting averaging, and time averaging. The peak hold mode captures the maximum amplitude of the signal while the overload reject mode allows exclusion of measurements from the averaging process that overload the input circuits.

The -hp-3561A math operations can be applied to measurement data for additional processing of the data. The math functions include the four basic math operations plus integration and differentiation.

Marker analysis modes include not only absolute and relative marker position values, but also tracking of the peak signal in a display, computation of power in a frequency band, and display of multiple markers for analysis of harmonic frequencies, and analysis of the modulation sidebands of a carrier frequency.

The display formats include the display of single traces, simultaneous display of two traces either in a top-bottom format or a front-back format, or the display of up to 60 traces in a map type format. Display units are user definable. Both linear or logarithmic scaling of the display is available.

Six instrument setups and two display traces can be saved to nonvolatile memory for recalling commonly used setups or analyzing a trace at a later time. The bubble memory option adds the capability of storing additional setups and traces as well as the storage of time capture data.

A variable source output provides a periodic noise, random noise, or an impulse source to drive a device under test for analysis. The A-weighting filter is available for acoustic or audio measurements. The Integrated Circuit Piezoelectric (ICP) current source is available for powering ICP accelerometers.

The -hp-3561A self tests provide maximum confidence in the operation of the instrument. These tests, in conjunction with the internal calibration signal, make it possible to quickly verify the calibration of the instrument before beginning a critical measurement sequence.

Virtually all of the measurement functions of the -hp-3561A are remotely programmable via the the Hewlett-Packard Interface Bus (HP-IB). Since measurement data can be remotely input or output, it is possible with a computing controller to extend the basic measurement capability. The display can be directly plotted to a Hewlett-Packard Graphics Language plotter or printer over the HP-IB.

SPECIFICATIONS

Instrument specifications are located in Appendix D. The specifications describe the operating characteristics of the -hp-3561A.

INSTALLATION, POWER REQUIREMENTS, AND ACCESSORIES

Chapter V, "Installation," contains instructions for installing and interfacing the -hp-3561A Dynamic Signal Analyzer. Included are initial inspection procedures, power and grounding requirements, environmental requirements, accessories supplied, accessories available, installation instructions, interfacing procedures, and instructions for repacking and shipment.

MANUALS AVAILABLE

This operating manual contains information required for installation and operation of the -hp-3561A. The service manual contains information to test, adjust, and service the -hp-3561A Dynamic Signal Analyzer.

OPERATING MANUAL OVERVIEW

This operating manual contains five chapters describing the operational details of the -hp-3561A and four appendices containing reference information and condensed operating procedures.

Operator's Introduction (Page 1) — Chapter I, "Operator's Introduction," describes the operation of the -hp-3561A.

Operator's Reference (Page 59) — Chapter II, "Operator's Reference," provides detailed information on the function of the -hp-3561A front panel keys, connectors, and indicators.

HP-IB Operation (Page 101) — Chapter III, "HP-IB Operation", is devoted to the operation of the -hp-3561A via the HP-IB.

HP-IB Commands (Page 111) — Chapter IV, "HP-IB Commands", lists the -hp-3561A HP-IB commands.

Installation (Page 173) — Chapter V, "Installation", contains initial inspection procedures, power and grounding requirements, environmental requirements, accessories supplied, accessories available, installation instructions, interfacing procedures, and instructions for repacking and shipment.

Quick Reference (Page I) — Appendix A, "Quick Reference," provides an operation summary of the -hp-3561A.

Overview of Dynamic Signal Analysis (Page V)— Appendix B, "Overview of Dynamic Signal Analysis," provides an overview of important FFT signal analyzer and measurement concepts.

Operating Diagnostic Messages (Page XIX) — Appendix C, "Operating Diagnostic Messages," lists the -hp-3561A diagnostic messages and interpretations of the messages.

Common Measurements and Math Functions (Page XXXV) — Appendix D, “Common Measurements and Math Functions,” summarizes some of the more frequently used measurements and math functions that are possible with the -hp-3561A.

Specifications (Page XXXIX) — Appendix E, “Specifications,” describes the operating characteristics of the -hp-3561A.

CHAPTER I

OPERATOR'S INTRODUCTION	1
INSTRUMENT TURN ON	1
Turn On and Power Up Self Tests	1
The Preset State and the Preset Key	2
OBTAINING A DISPLAY	3
Selecting a Display Format	4
Reading the Display	6
SELECTING A MEASUREMENT MODE	7
Narrow Band Mode	8
Octave Band/Third Octave Band Analysis	10
The Time Capture Mode	12
External Sample	13
Viewing the Setup Parameters	14
INVESTIGATING THE SIGNAL WITH THE MARKER	15
Absolute Marker Measurements	15
Relative Marker Measurements	18
Special Marker Functions	19
ADJUSTING THE DISPLAY AREA	22
Adjusting the Display Span (Zoom)	22
Adjusting the Display Vertical Scale	25
PROCESSING DATA	26
Window Selection	26
Averaging	27
Special Averaging Features	28
Using the Trigger	29
Capturing Data — The Time Buffer	30
Map Display Operations	32
TRACE MATH	34
Performing Math Operations	34
Trace Math Applications	37
Phase Transfer Function (PHASE - M2)	38
CUSTOMIZING THE DISPLAY	39
Changing the Display Units	39
Entering Engineering (User) Units	42
Annotating the Display	44
PLOTTING THE DISPLAY	45
Using a Plotter	45
Plotting with a Printer	47
MEMORY OPERATIONS	48
Saving/Recalling a Front Panel Setup Without Bubble Memory	48
Saving/Recalling a Front Panel Setup With Bubble Memory	49
Saving/Recalling a Trace in Nonvolatile Memory M1 and M2	50
Saving/Recalling a Trace in Bubble Memory	50
Saving/Recalling Maps with Bubble Memory	51
Saving/Recalling the Time Buffer with Bubble Memory	52
Bubble Memory Operation	53
SPECIAL FUNCTIONS	56
The Noise Source	56
ICP Current Source	57
△ Manual Control of Input Circuits	57
Auto-Calibration	58
-hp-3561A Operational Test	58

CHAPTER I

OPERATOR'S INTRODUCTION

INSTRUMENT TURN ON
OBTAINING A DISPLAY
SELECTING A MEASUREMENT MODE
INVESTIGATING THE SIGNAL WITH THE MARKER
ADJUSTING THE DISPLAY AREA
PROCESSING DATA
TRACE MATH
CUSTOMIZING THE DISPLAY
PLOTTING THE DISPLAY
MEMORY OPERATIONS
SPECIAL FUNCTIONS

CHAPTER I OPERATOR'S INTRODUCTION

This chapter contains an introduction to the manual operation of the -hp-3561A Dynamic Signal Analyzer. This chapter is subdivided into sections describing each major function of the -hp-3561A. The sections are listed in the table of contents printed on the chapter divider. Additional information concerning specific labeled keys, menu-defined keys (softkeys), indicators, and connectors is in Chapter II, "Operator's Reference."



Prior to operating the -hp-3561A, check the line voltage setting and the fuse for the proper value. POWER REQUIREMENTS in Chapter V, "Installation", contains information on setting the line voltage and selecting the fuse of the -hp-3561A for the local ac power source.

Note

A fold out page included in Appendix A, "Quick Reference," illustrates the front and rear panel controls, connectors, and indicators on the -hp-3561A. This illustration is located at the back of this manual for easy reference.

Manual operation of the -hp-3561A is through the labeled front panel keys, and the unlabeled softkeys to the right of the display. Menus defining the softkeys appear along the right edge of the display after a labeled key is pressed. The use of softkeys simplifies the front panel and increases the capabilities of the -hp-3561A.

INSTRUMENT TURN ON

TURN ON AND POWER UP SELF TESTS

Connect the -hp-3561A to a suitable power source and depress the LINE key to apply power to the -hp-3561A. When power is applied, the -hp-3561A initiates a series of self tests and calibrates internal circuits. During the self tests, all the front panel indicators illuminate and the POWER ON TEST IN PROGRESS message is displayed. As the -hp-3561A checks the display memory, two patterns are drawn on the display. Upon completion of calibration and self tests, the -hp-3561A assumes a preset state.

THE PRESET STATE AND THE PRESET KEY

The preset state selects the most commonly used instrument settings. The -hp-3561A is restored to the preset state at any time by pressing the green PRESET key located in the INSTR STATE key group. The preset state is especially convenient for establishing a known starting point for a measurement whether it is an initial measurement or an alternate configuration for a measurement. The preset conditions are listed in Table 1-1. The preset state does not destroy instrument states or traces stored in the -hp-3561A nonvolatile memory.

Note

Although the PRESET key provides a convenient setup, it may not be the most desirable setup or starting state for a particular application. Unique starting states are saved in nonvolatile memory through the INSTR STATE SAVE key and recalled through the INSTR STATE RECALL key (see Saving/Recalling Front Panel Setups in this chapter).

MODE Key Narrow Band External Sample Off Define Puls/Rev Selected	TRIGGER SEL Key Free Run Auto Arm Input Trigger Positive Trigger Slope Trigger Level = 0% Delay Off Delay = 0	Volts/dBV Selected HZ/SEC Selected
AVG Key Off Number of Averages = 10 Overlap = 0% Overload Reject Off Normal Display	HPIB GROUP	FORMAT Key Upper Lower Format Vertical Map Full Map Number of Traces in Map = 60
TIME BUFFER Key Number of Records = 40 Start Time = 0 Percent Increment = 100% Zoom Factor = 1 Zoom Frequency = 0	PLOT Key Annotation On Grid Off Default Setup	MARKER GROUP
FREQ Key Menu Displayed 0-100kHz Span Define Span Selected Linear Frequency Axis	DISPLAY GROUP	MARKER Key Marker On Peak Track Off Step Off
WINDOW Key Flattop Time Constant = 256	DEFINE TRACE Key Trace A Active Trace Magnitude Format Time Selection Defined as Input Time Trace B Real Time Compress Real Selected for Time Capture	SPCL MKR Key Special Markers Off
SOURCE Key Off 40.5 dB Attenuation	VERT SCALE Key Track Input Range (Phase Auto Scale) 10 dB/Division Logarithmic Scale	REL MKR Key Relative Marker Off
	STORE/RECALL Key Trace Label Off	INSTRUMENT STATE GROUP
		VIEW ON-OFF Off
		INPUT GROUP
		RANGE Auto-Range On
		INPUT Key Auto Cal On DC Coupled A-Weight Filter Off ICP Current Off Calibration Signal Off

OBTAINING A DISPLAY

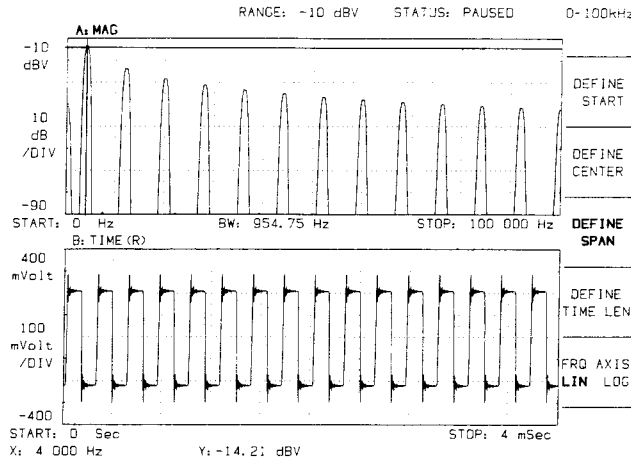

One of the primary considerations in measuring an unknown signal is obtaining a broad band trace to obtain a visual idea of the signal content. The following example illustrates how to quickly obtain a trace display on the -hp-3561A. For convenience, the example uses the internal calibrator of the -hp-3561A to provide a 4 kilohertz square wave with a fundamental frequency amplitude of -14.21 dBV (195 millivolts rms). The calibrator is used as a substitute for an external signal input. (The calibrator provides a quick way to check the operation of the -hp-3561A). The normal input signal is derived from a variety of sources including, but not limited to, accelerometers, strain gauges, microphones, amplifiers, oscillators, and other electronic circuits.

To connect the -hp-3561A calibrator to the input, first press the green PRESET key in the INSTR STATE key group to establish a known starting state. The preset state also enables the -hp-3561A to automatically select the input range and scale the display for the input signal. Press the INPUT key to display the input menu. Press the CAL SIG ON OFF softkey to intensify the ON portion of the softkey label. When the calibrator is first enabled, the message CAL SIGNAL ENABLED, PRESET OR DISABLE TO CLEAR is momentarily displayed above the trace graticule. The -hp-3561A is now configured to measure the calibrator signal. The preset state displays the magnitude spectrum trace and time trace of the calibrator signal as the measurement data.

Note

An external source such as a function generator, may be substituted for the internal calibrator. The function generator will provide a variety of signal types (sine wave, square wave, or triangle wave), variable amplitudes, and variable frequencies for examination. Prior to connecting the output of a function generator to the -hp-3561A, press the green PRESET key. This establishes a known starting state and enables the hp-3561A to automatically select the input range and scale the display for the input signal. To duplicate the -hp-3561A calibrator signal, set the function generator of 218.5 millivolts rms. Connect the function generator to the -hp-3561A front panel input connector.

SELECTING A DISPLAY FORMAT

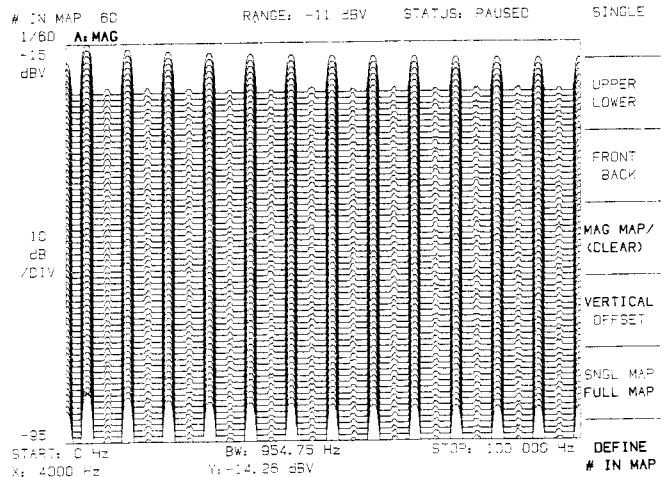
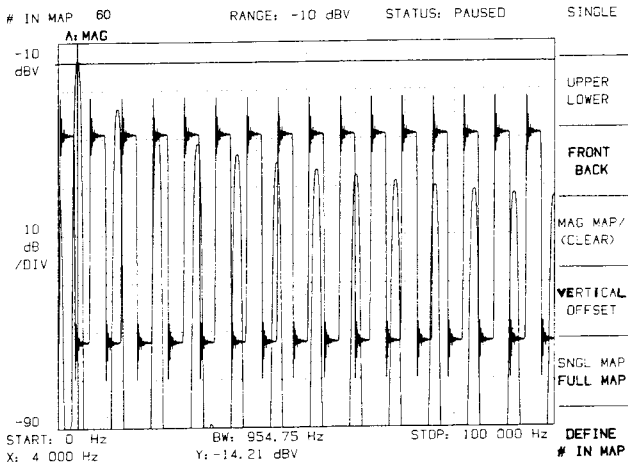
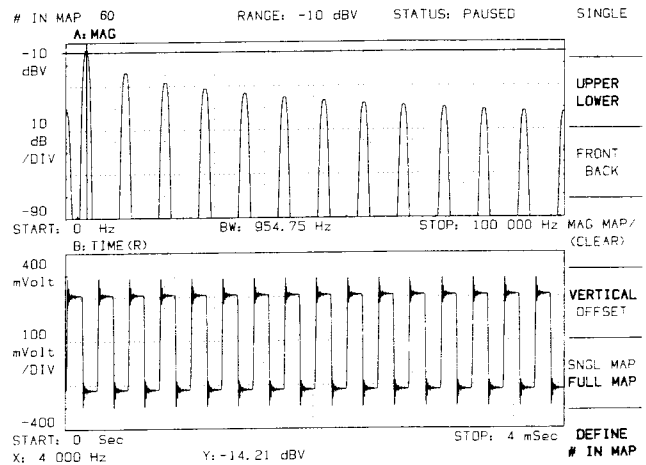
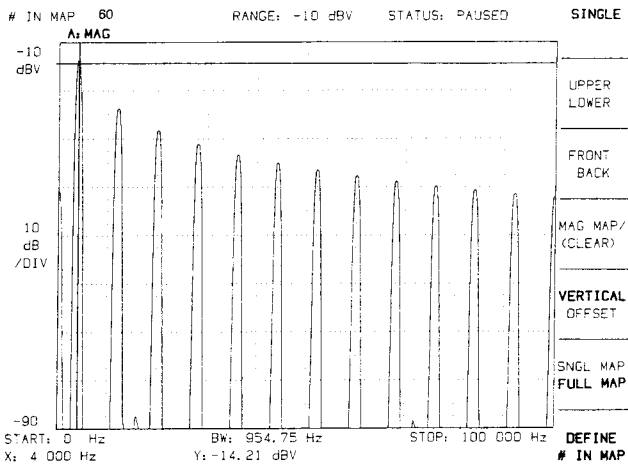

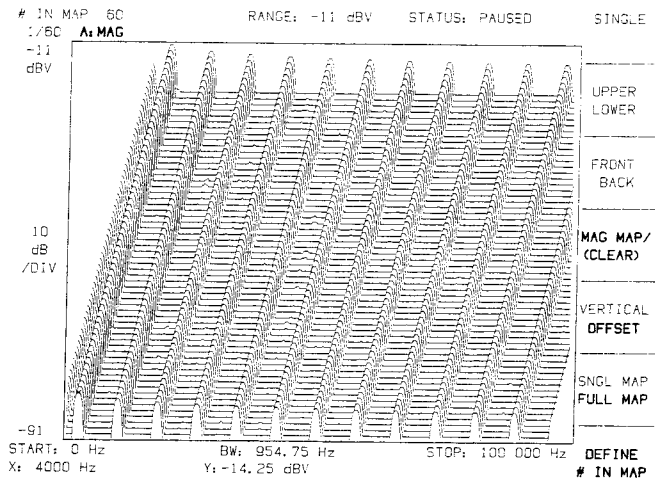

Various display formats other than the preset display format are selected through the FORMAT key in the DISPLAY key group. Displays available are a single trace display, an upper lower trace display, a front back trace display, and the map displays. The PRESET key selects the upper lower trace format display. To select an alternate display, press the FORMAT key to obtain the format menu, and then select the softkey of the desired display type. For example, to select a single trace format, press the FORMAT key to obtain the format menu, then press the SINGLE softkey for the single trace display format.

Only one trace in each display format is affected by operations with the DEFINE TRACE, VERT SCALE, and STORE/RECALL keys in the DISPLAY key group, and the MARKER position keys. The affected trace is the active trace. For an upper lower trace format, the active trace is identified by the intensified label at the top left corner of the graticule. For a single trace format, the trace displayed is the active trace. An inactive second trace format is available and is displayed by pressing the NEXT TRACE key. For a front back display format the active trace is the intensified trace. The units of the active trace are assigned to the graticule in the front back display. For a map format, the active trace is the intensified trace. The active trace is the trace drawn for a single map. In each format the active trace is selected with the NEXT TRACE key.

READING THE DISPLAY

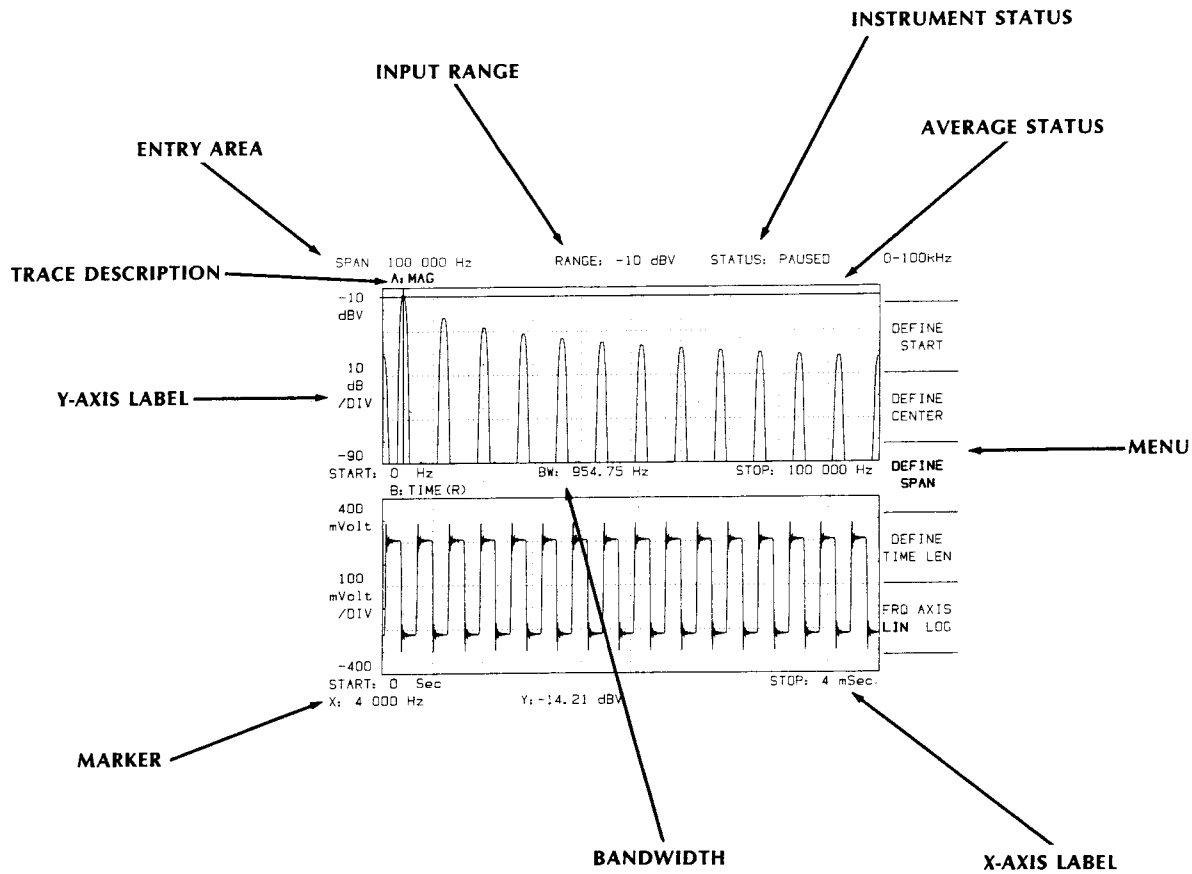

The display illustration indicates the function of the display annotation areas. The measurement data is displayed in graphics form on the display. The horizontal axis represents either frequency or time depending upon the trace type displayed. The vertical axis represents the signal magnitude, phase, or instantaneous amplitude depending upon the trace type displayed.

SELECTING A MEASUREMENT MODE

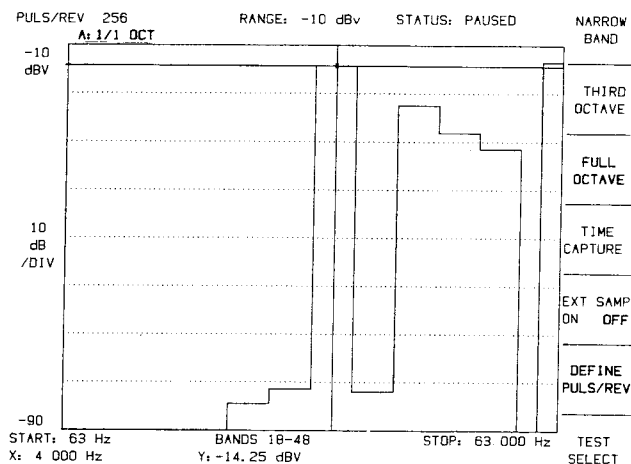
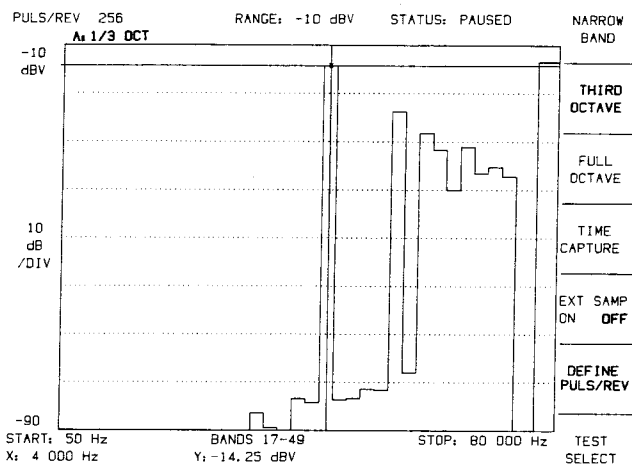
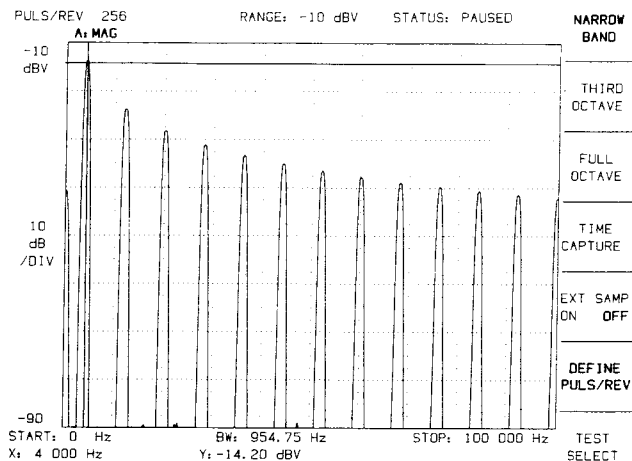

The menu for selecting the measurement modes and enabling self tests is available by pressing the MODE key. The measurement modes of the -hp-3561A are narrow band, third octave, full octave, time capture, and external sample. The TEST mode enables instrument self tests to check measurement circuit operation. The measurement modes are explained in the following sections.

NARROW BAND MODE

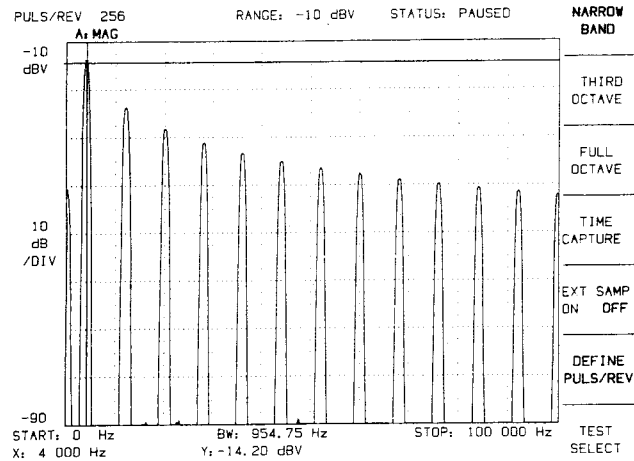

The NARROW BAND softkey selects a measurement mode with the finest display resolution. The narrow band display is divided into 401 plotting positions along the horizontal axis. The resolution of each plotting position is 1/400 of the total display span. For a display span of 100 kilohertz, each plotting position is 250 Hertz apart, or equivalently, the display has a resolution of 250 Hertz.

The type of narrow band mode measurement represented by the active trace is selected through the DEFINE TRACE key. The available DEFINE TRACE softkeys for the narrow band mode are: MAG, PHASE, TIME, INPUT MAG, MATH FUNCTION, MATH FCN SELECT, and TIME SELECT.

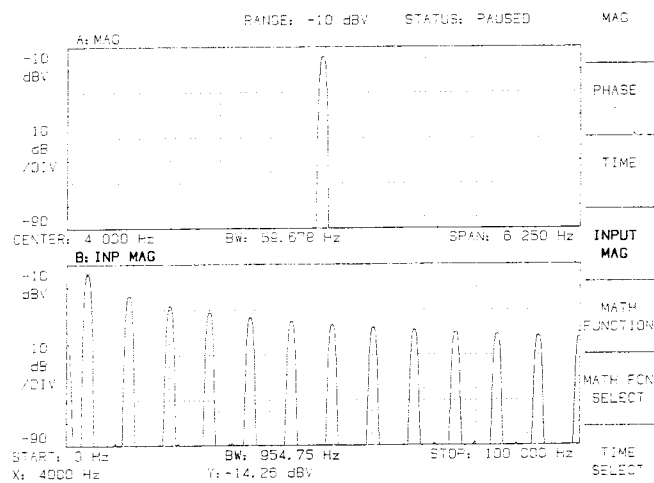

The MAG softkey selects a magnitude versus frequency display. The frequency span of the measurement is adjusted through the FREQ key menu (see Adjusting the Display Span in this chapter). In contrast to the MAG softkey, the INPUT MAG softkey always displays the full span magnitude spectrum of the input signal.

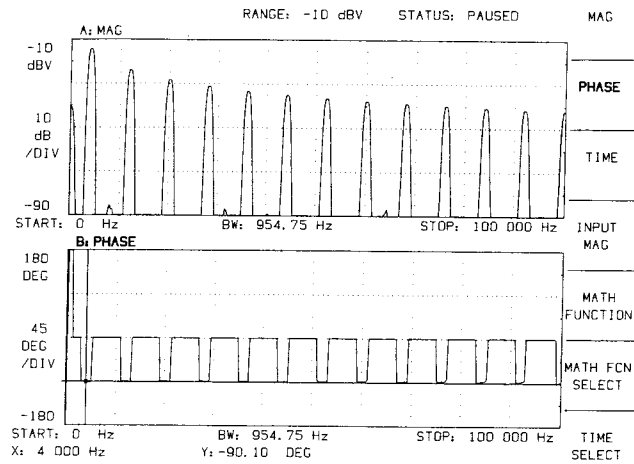

The PHASE softkey selects a phase angle versus frequency display. The phase angle units are degrees. From the preset state, the center of the vertical axis represents zero degrees.

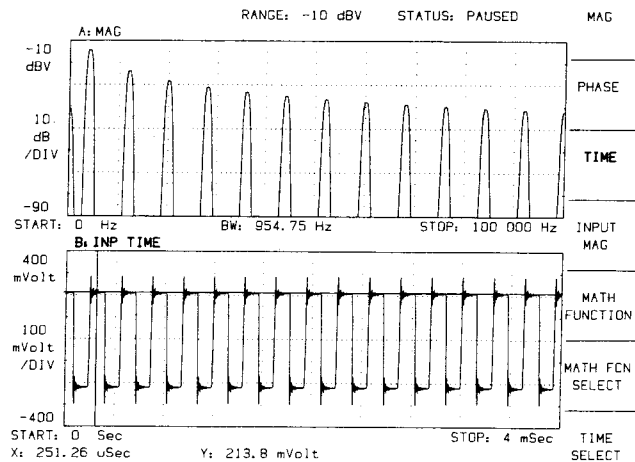

The TIME softkey selects a time domain display (amplitude versus time) of the input signal. The 1024 data points collected in the time record are compressed to 399 data points for the display trace. The TIME SELECT softkey displays a menu for the selection of the time display data source. The TIME SELECT menu provides entries for displaying the real and imaginary portions of complex time data points as well as the input time record. The complex value time data points, displayed by selecting the TIME REAL and TIME IMAG softkeys, represent the data used by the signal processing algorithms. The input time record, displayed by selecting the INPUT TIME softkey, is useful for setting input range and trigger level.

The MATH FUNCTION softkey displays the resultant trace of the math operation defined through the MATH FCN SELECT softkey. The sequence and definition of math operations performed on traces is entered through the MATH FCN SELECT softkey. An example of the math function is located in the Trace Math section of this chapter.

OCTAVE BAND/THIRD OCTAVE BAND ANALYSIS

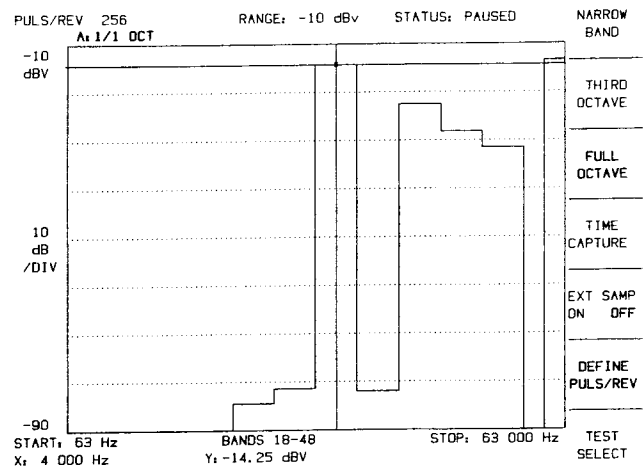
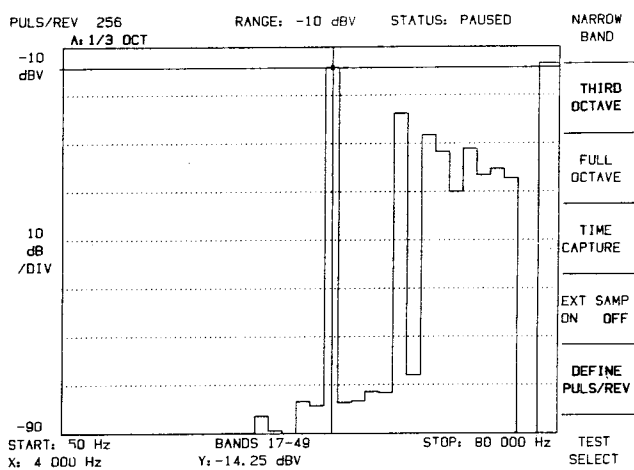

The FULL OCTAVE or THIRD OCTAVE softkeys select measurement modes commonly used in audio and acoustic applications. The -hp-3561A full octave and third octave mode display is computed from narrow band measurement data.

The type of third octave or full octave band measurement represented by the active trace is selected through the DEFINE TRACE key. The available DEFINE TRACE softkeys are: MAG, TIME, INPUT MAG, MATH FUNCTION, MATH FCN SELECT, and TIME SELECT.

The MAG softkey selects a magnitude versus frequency display. In the third octave mode, 33 frequency bands plus a total rms power band are displayed. In the full octave mode, 11 bands plus a total rms power band are displayed. The display span is specified by entering the greatest band number or frequency value to be displayed through the FREQ key menu. Pressing the up or down arrow key will quickly cycle through the available values for the DEFINE STOP BND or DEFINE STOP FRQ softkeys in the FREQ key menu. The FREQ key MAX STOP softkey is a convenience softkey for displaying the highest frequency bands.

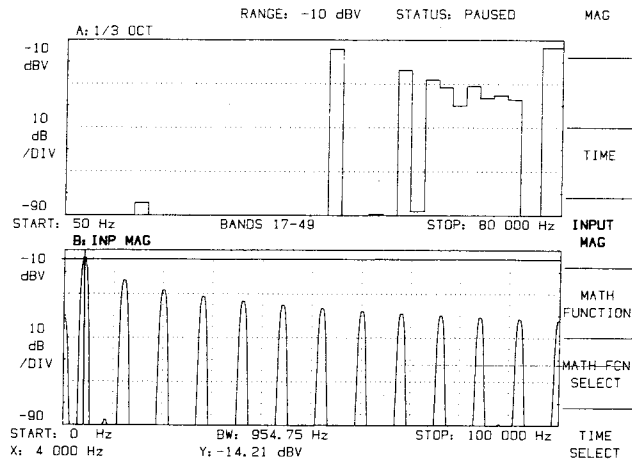

The INPUT MAG softkey displays the full span narrow band magnitude spectrum of the input signal.

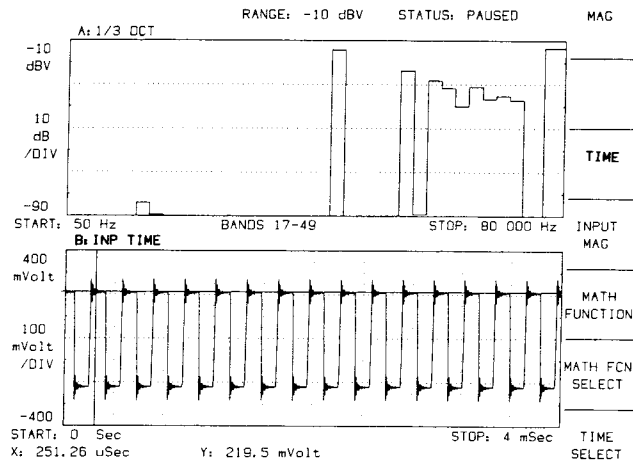

The TIME softkey selects a time domain display (amplitude versus time) of the input signal. The 1024 data points collected in the time record are compressed to 399 data points for the display trace. The TIME SELECT softkey displays a menu to specify the data source of the time display enabled with the TIME softkey. The TIME SELECT options include TIME LO SPAN, TIME MID SPAN, TIME HI SPAN, and INPUT TIME. The TIME LO SPAN, TIME MID SPAN, and TIME HI SPAN softkeys select one of the three time spans used to compute the third octave display. The INPUT TIME softkey selects the input time record as the source of the time display. The INPUT TIME display is useful for setting input range.

The MATH FUNCTION softkey displays the resultant trace of the math operation defined through the MATH FCN SELECT softkey. The sequence and definition of math operations performed on traces is entered through the MATH FCN SELECT softkey. An example of the math function is located in the Trace Math section of this chapter.

The -hp-3561A A-weighting filter is available for use in audio or acoustic measurements. The menu for the control of the A-weighting filter is displayed by pressing the INPUT key. The A-weighting filter is enabled by selecting the A WT FLT ON OFF softkey to intensify the ON portion of the label. The A WT FILTER indicator on the front panel illuminates to indicate that the internal A-weighting filter is enabled.

THE TIME CAPTURE MODE

The TIME CAPTURE mode configures the -hp-3561A to acquire contiguous time records and store the digitized data in internal memory. A time record is the minimum number of data samples required to compute the FFT transform. Time capture operations are controlled through the TIME BUFFER key. Operation of time capture is described in Capturing Data — Time Buffer. The type of time capture mode measurement represented by the active trace is selected through the DEFINE TRACE key. The available DEFINE TRACE softkeys for the time capture mode are: MAG, PHASE, TIME, AVERAGE MAG, MATH FUNCTION, MATH FCN SELECT, and TIME SELECT.

The MAG softkey selects a magnitude versus frequency display. The AVERAGE MAG softkey displays the rms average of all the time records in the time buffer.

The PHASE softkey selects a phase angle versus frequency display. The phase angle units are degrees. From the preset state, the center of the vertical axis represents zero degrees.

The TIME softkey selects a time domain display representation of the input signal. The collected time data points are compressed to 399 data points for the display trace.

The TIME SELECT softkey displays a menu to select the data source of the time display. The time display is enabled with the TIME softkey. The TIME SELECT menu provides entries for displaying the real and imaginary portions of complex value time data points as well the input time record.

The input time record, displayed by selecting the INPUT TIME softkey, is useful for setting input range and trigger level. The TIME REAL and TIME IMAG softkeys display the real and imaginary portion of complex value time data points starting at the start time entered through the TIME BUFFER key menu. The complex value time data points represent the data used by the signal processing algorithms. The COMPRESS REAL and COMPRESS IMAG display the real or imaginary portion of the data stored in the time buffer. The COMPRESS REAL and COMPRESS IMAG softkeys compress the entire time buffer real or imaginary data to 399 display points. A pair of dashed vertical markers appear in the compressed time display to indicate the portion of the time buffer data selected for display through the TIME BUFFER menu.

The MATH FUNCTION softkey displays the resultant trace of the math operation defined through the MATH FCN SELECT softkey. The sequence and definition of math operations performed on traces is entered through the MATH FCN SELECT softkey. An example of the math function is located in the Trace Math section of this chapter.

EXTERNAL SAMPLE

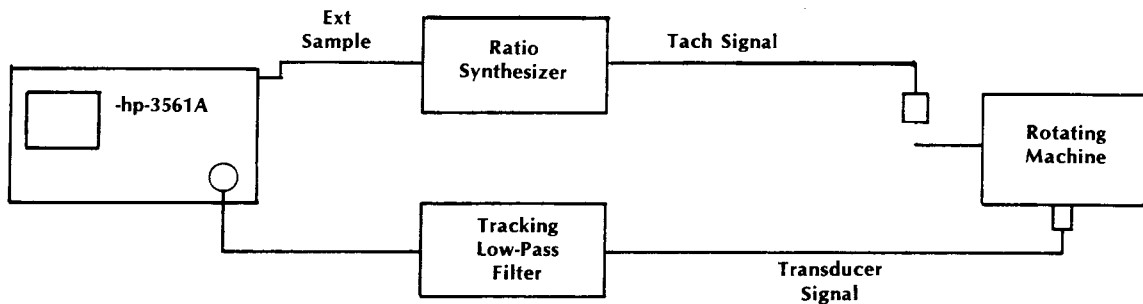

The external sample measurement mode enables control over the -hp-3561A sample rate through the rear panel EXT SAMPLE BNC connector. External sample is commonly used to synchronize the -hp-3561A with rotating machinery to perform order analysis. The external sample frequency is generally derived from the rotational speed of the machine by a ratio synthesizer. Tracking of rotation speed causes rotationally related components to stay in fixed line positions of the spectrum even though speed variations occur.

The external sampling mode is enabled by selecting the EXT SAMP ON OFF softkey to intensify the ON portion of the label. The units of the horizontal axis are restricted to orders and revolutions in the external sampling mode. The number of pulses per revolution is entered with the DEFINE PULS/REV softkey. The pulses per revolution entry is used to calibrate the horizontal axis of the display. The EXT SAMPLE indicator illuminates to indicate external sampling is enabled. The external sample rate input is TTL compatible.

Note

Measurements using external sampling may require require an external anti-aliasing filter. The -hp-3561A anti-aliasing filter is fixed for a 256 kilohertz sample rate and 100 kilohertz maximum display frequency.

Two operator prompts occur while in the external sample mode. The prompt EXTERNAL SAMPLE RATE TOO FAST or incompatible occurs when the sampling frequency exceeds the 256 kHz sampling limit. The prompt EXTERNAL SAMPLE CLOCK < 5HZ appears on the display if the external sample rate is below 5 Hertz.

VIEWING THE SETUP PARAMETERS

```

SPAN 100 000 Hz      RANGE: -10 dBV   STATUS: PAUSED   0-100kHz
                                NARROW BAND MODE   EXT SAMPLE OFF
FREQUENCY:
  BASEBAND          START: 0 Hz           DEFINE
                   STOP: 100 000 Hz      START
                   TIME: 4 mSec
TRIGGER:
  FREE RUN          DEFINE
                   CENTER
AVERAGE:
  OFF              DEFINE
                   SPAN
WINDOW:
  FLAT TOP         BW: 954.85 Hz
SOURCE:
  OFF              DEFINE
                   TIME LEN
INPUT:
  DC COUPLING      JCP CURRENT OFF    A WEIGHT FLTR OFF
  AUTO RANGE OFF   AUTO CAL ON        CAL SIGNAL ON
UNITS:
  X: HZ
  Y: dBV
  
```

The VIEW ON/OFF key toggles the display between the graphics display and a text table listing the -hp-3561A setup. While the text table is displayed, the front panel keys and menu defined keys are still operational.

INVESTIGATING THE SIGNAL WITH THE MARKER

ABSOLUTE MARKER MEASUREMENTS

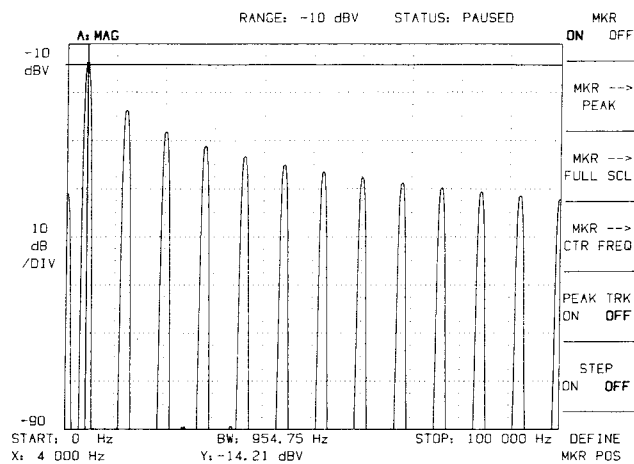

From the preset state, the display marker is ready to use on the active trace. The marker is moved along the active trace by pressing the right and left arrow keys. The X and Y coordinate values of the marker position appear at the bottom of the display. Pressing the FAST key simultaneously with a right or left arrow key moves the marker at an accelerated rate. The alternate trace is analyzed with the marker by selecting it as the active trace by pressing the NEXT TRACE key.

Pressing the MKR key displays a menu for controlling the marker. The MKR ON OFF softkey controls the display of the marker. Selecting the MKR — > PEAK softkey positions the marker at the nonzero frequency with the largest peak amplitude. Selecting the PEAK TRK ON OFF softkey allows the marker to track the peak signal in the trace. The marker is moved to an arbitrary position by pressing the DEFINE MRK POS softkey and entering the desired position value with the numeric keypad (see Figure 1-1). Notice that pressing the DEFINE MRK POS displays the units menu for ending the marker position entry.

Two softkeys assign the marker coordinate values to the display scale. The MKR — > FULL SCL softkey, which is displayed only when the active trace is a magnitude trace, assigns the marker Y coordinate value to the display full scale value. If the marker value is not a valid value for full scale, a valid value larger than the marker value is used. Selecting the MKR — > CTR FREQ softkey sets the display center frequency to the marker frequency.

Selecting the STEP ON OFF softkey couples the marker frequency step to the special marker values. With STEP ON OFF enabled, pressing either the right or left arrow key steps the marker to each special marker. The STEP ON OFF softkey is not active unless a special marker is selected and defined with the SPCL MKR key menu.

Values for softkeys with DEFINE in the label (such as DEFINE MKR POS) are normally entered with the numeric keypad. The DEFINE softkey accepts values when the softkey is intensified. A menu for ending the values entered is displayed when an intensified DEFINE softkey is selected, or a number key is pressed. Table 1-2 lists the DEFINE keys that accept marker values as entries when the MKR VALUE key is pressed. Figure 1-1 illustrates entering a value directly with the numeric keypad, entering a value with the MKR VALUE key, and correcting an erroneous entry.

Figure 1-1. Entering values with define keys

DIRECT ENTRY

- Select the DEFINE softkey.

Note

*This step is optional if the entry is already selected (intensified).
Selecting an intensified softkey displays the units menu to end
numeric entry.*

- Enter Numbers.
- Select units softkey to end numeric entry.
- Example to position marker at 10kHz:
Press MKR to display marker menu.
Select DEFINE MKR POS.
Enter 1 0 with the numeric keypad.
PRESS KHZ

ENTRY WITH MKR VALUE KEY

- Position marker.
- Select DEFINE softkey.
- PRESS MKR VALUE key.
- Example to define relative marker reference frequency of 20 kHz:
Position marker at 20 kHz with right and left arrow keys or DEFINE MRK POS softkey.
Press REL MKR key to display relative marker menu.
Select DEFINE FREQ REF softkey.
Press MKR VALUE key.

ENTRY CORRECTION

- To correct after units selected - Repeat direct entry procedures.
- Select CANCEL softkey and re-enter numbers.
OR
- To Edit entry:
Press BACK SPACE key to backspace and delete previous entries.
Enter correct values.
Select UNITS softkey to end number entry.
- Example for entering marker position of 15250 kHz:
Press MKR key to display marker menu.
Select DEFINE MRK POS softkey.
Enter 1 7 2 5 0 with numeric keypad.
Press BACK SPACE key to delete characters following 1.
Enter 5 2 5 0 with numeric keypad.
Select HZ softkey to end value entry.

Table 1-2 Define Keys that Accept MKR Value Entries

DEFINE START	DEFINE START t
DEFINE CENTER	DEFINE TIME REF
DEFINE SPAN	DEFINE FULL SCL
DEFINE RANGE	DEFINE CARR FRQ
DEFINE Hz/ORD	DEFINE SB FRQ
DEFINE MAG REF	DEFINE STOP FRQ
DEFINE PHASE REF	DEFINE RGHT FRQ
DEFINE FUND FRQ	DEFINE LEFT FRQ
DEFINE + - DELAY	DEFINE FREQ REF
DEFINE TIME LEN	DEFINE ZOOM FRQ

RELATIVE MARKER MEASUREMENTS

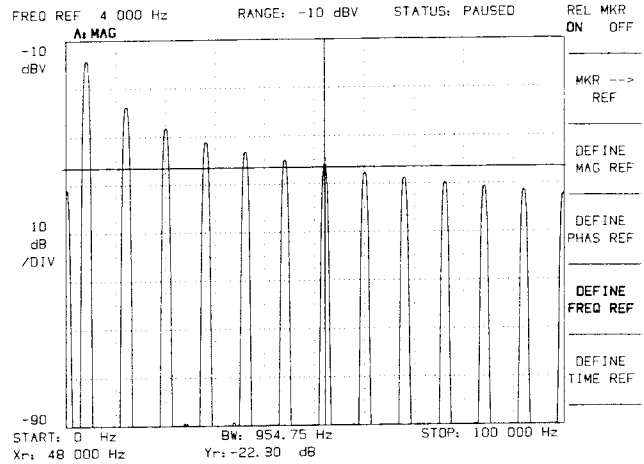
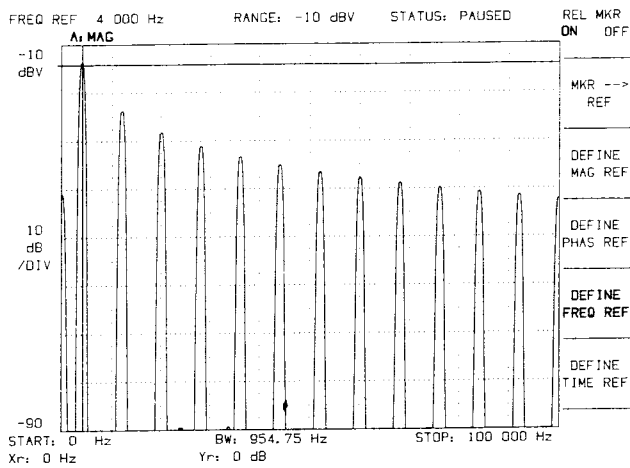

Marker values are displayed in relative units (offset from an arbitrary point) rather than absolute units through the REL MKR key. To select the relative marker feature, first press the REL MKR key to display the relative marker menu. Press the REL MKR ON OFF softkey to intensify the ON portion of the label and activate the relative marker. The marker values are now in relative units. The marker reference is defined with the remaining softkeys.

The MKR -> REF softkey defines the current marker position values as the reference values. All marker measurements are with respect to these values. This is demonstrated by activating the relative marker and positioning the marker on a harmonic frequency. Press the MKR -> REF softkey to define the marker reference as the current marker values. When the marker is moved to an adjacent frequency, the frequency and amplitude offset from the reference value is displayed in the marker annotation area of the display.

Arbitrary values for the magnitude, phase, frequency, and time reference are entered through the DEFINE MAG REF, DEFINE PHAS REF, DEFINE FREQ REF, and DEFINE TIME REF softkeys. For example, to enter a reference frequency of 8 kilohertz, press the DEFINE FREQ REF key, enter 8 with the numeric keypad, and terminate the entry with the kHz key. Notice that the frequency offset is now referenced to 8 kilohertz.

SPECIAL MARKER FUNCTIONS

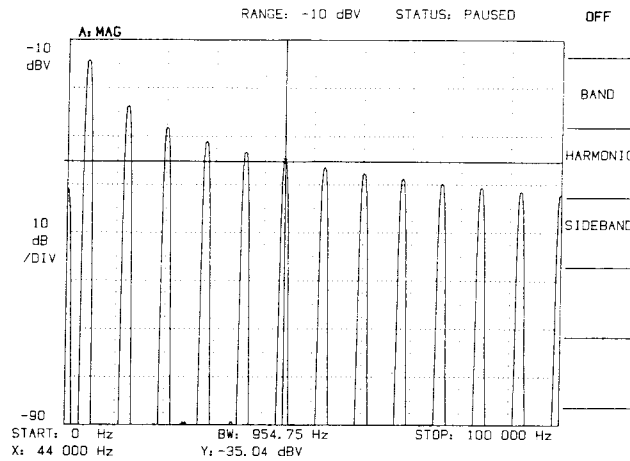

A menu for analyzing the signal with special markers is available by pressing the SPCL MKR key. Special marker functions involve computing signal power between two frequencies or displaying multiple markers on the active trace. When a special marker function is selected, additional softkeys are enabled for measurement parameters.

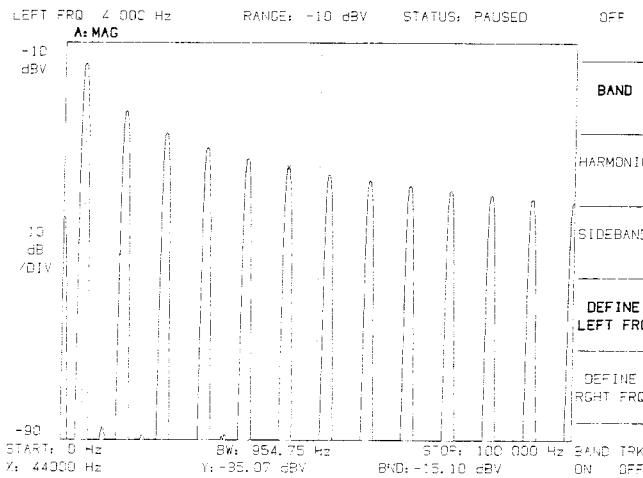

The power or rms voltage contained between two frequencies in a trace is computed through the BAND softkey. After selecting the BAND softkey, the start and

stop frequencies are entered through the DEFINE RGHT FRQ and DEFINE LEFT FRQ softkeys displayed by selecting the BAND softkey. The BAND TRK ON OFF softkey displayed with the DEFINE RGHT FRQ and DEFINE LEFT FRQ softkeys couples the special markers. With band tracking enabled, altering either boundary frequency shifts the frequency band.

With the BAND special markers enabled, the MKR VALUE key uses the special marker values to the DEFINE START, DEFINE CENTER, and DEFINE SPAN softkey entries. For the DEFINE START softkey, MKR VALUE transfers the frequency of the left band marker to the display start frequency. For the DEFINE CENTER softkey, MKR VALUE transfers the center frequency of band marked by the special markers to the display center frequency. For the DEFINE SPAN softkey, MKR VALUE transfers the span of the band marked by the special markers to the display span.

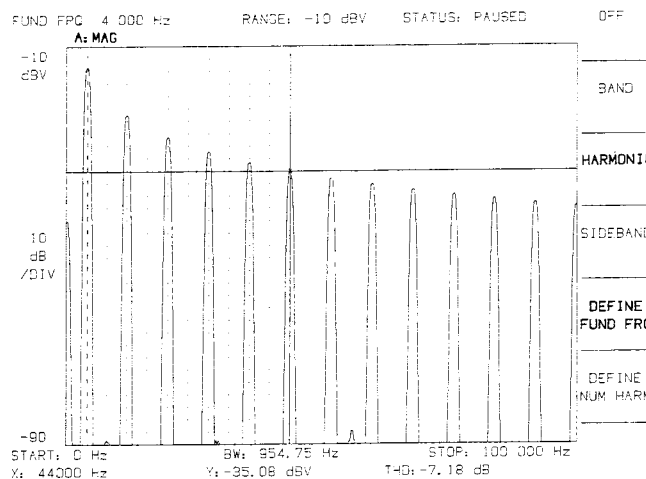

To obtain the band power for the frequency range from 4 to 50 kilohertz, press the UNITS key and select mW (dBm) units. Press the SPCL MKR key to display the special marker menu. Select the BAND softkey to enable the band power measurement and display the softkeys for entering the measurement parameters. For the lower frequency of 4 kilohertz, select the DEFINE LEFT FRQ softkey, enter 4 with the numeric keypad, and end the entry with the kHz softkey. For the higher frequency of 50 kilohertz, select the DEFINE RGHT FRQ softkey, enter 50 with the numeric keypad and end the entry with the kHz softkey. The signal power between the specified frequencies is now annotated on the display. To adjust the frequency band analyzed, select the DEFINE LEFT FRQ or DEFINE RGHT FRQ softkey, and press the up or down arrow key to move the band definition marker to another frequency position. To couple the special markers together, select the BAND TRK ON OFF softkey to intensify the on portion of the softkey. The defined frequency band is now shifted along the frequency axis by changing either the right or left special marker frequency.

The HARMONIC special marker function marks harmonic frequencies with multiple markers and computes the ratio of the harmonic power to the fundamental frequency power. After selecting the HARMONIC marker softkey, the number of harmonic frequencies marked, and the fundamental frequency are entered through the DEFINE NUM HARM and DEFINE FUND FRQ softkeys. To measure the -hp-3561A 4 kilohertz calibrator signal, press the SPCL MKR key to display the special marker menu. Select the HARMONIC softkey to enable the measurement and display the menu for entering the marker values. Select the DEFINE FUND FRQ softkey, enter 4 with the numeric keypad and end the entry with the kHz softkey. Select the DEFINE NUM HARM softkey and specify the number of harmonics marked with the numeric keypad. End the entry with ENTER softkey.

The MKR VALUE key provides an alternate method of specifying the fundamental frequency for HARMONIC marker measurements. Rather than entering the 4 kHz for the DEFINE FUND FRQ softkey, position the marker on the fundamental frequency. Then press the MKR VALUE key to transfers the marker frequency to the DEFINE FUND FRQ softkey value. Fine adjustment of the fundamental frequency value is made with the up and down arrow keys.

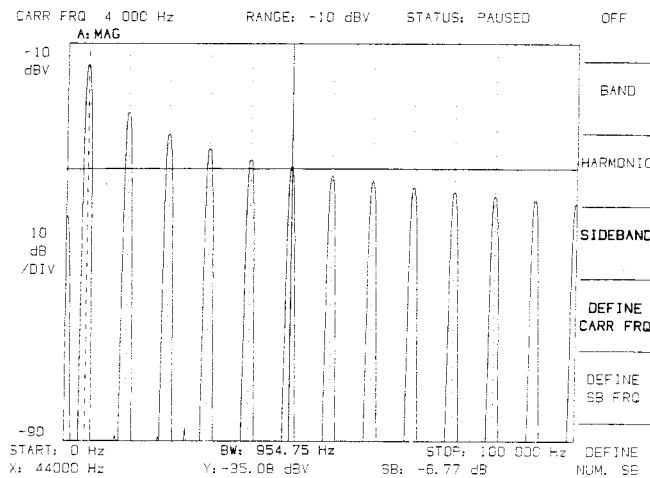

Sideband analysis on modulated signals is similarly simplified with the SIDEBAND special marker function. The SIDEBAND softkey available in the special marker menu selects the sideband markers. Values for the sideband carrier frequency, sideband frequency, and the number of frequencies marked are entered through the DEFINE CARR FRQ, DEFINE SB FRQ, and DEFINE NUM. SB softkeys available when the SIDEBAND softkey is selected. The resulting computation indicates the ratio of the sideband power to the carrier power.

ADJUSTING THE DISPLAY AREA

ADJUSTING THE DISPLAY SPAN (ZOOM)

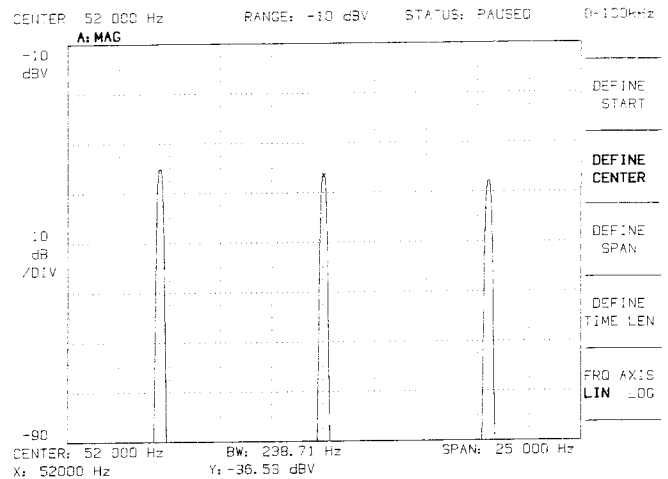
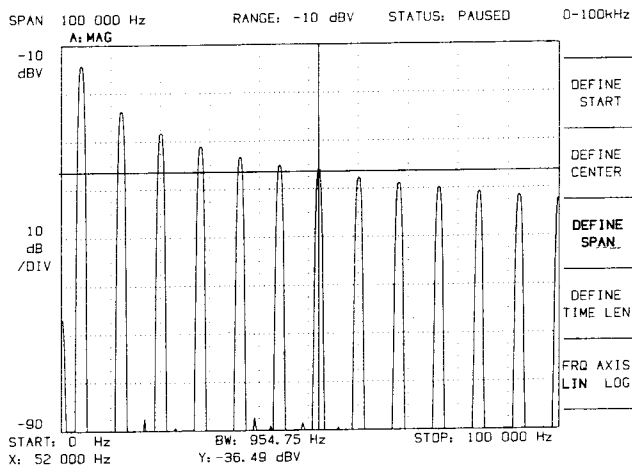

A portion of the full trace is expanded to fill the entire display by reducing the measurement frequency span with the FREQ key menu. Two parameters are of concern in obtaining an expanded display. The first is the total measurement span (the difference between the start and end frequency). The second is a reference point (either the start frequency or center frequency of the display).

The following example outlines the procedure to display a 25 kilohertz frequency range (the measurement span) centered around 52 kilohertz (the reference point). First press the FREQ key to display the frequency menu and then select the DEFINE SPAN softkey. Enter 25 with the numeric keypad, and select the kHz softkey to define the measurement span. Select the DEFINE CENTER softkey, enter 52 with the numeric keypad, and select the kHz softkey to define the center frequency of the display. The same display is obtained by defining a start frequency 39.5 kilohertz rather than a center frequency of 52 kilohertz.

Note

The -hp-3561A has discrete measurement frequency spans. The frequency spans are listed in Table 1-3. The available frequency spans are substituted for frequency spans not listed.

The up and down arrow keys provide an alternate method of defining the start frequency, center frequency, and measurement span. When the DEFINE START,

DEFINE CENTER, or DEFINE SPAN softkey is intensified, pressing the up arrow key increases the value for the intensified softkey. Conversely, the down arrow key decreases the value for the respective softkey.

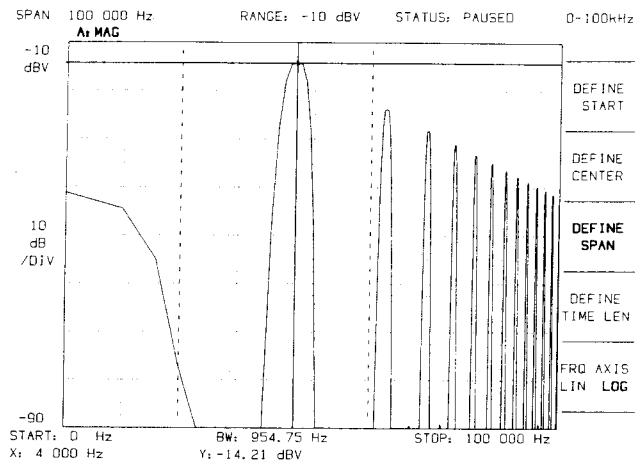

Three other softkeys appear in the FREQ key menu. The 0-100kHz softkey selects the full measurement span. The FRQ AXIS LIN LOG entry selects either linear or logarithmic scaling of the horizontal axis. The remaining softkey, DEFINE TIME LEN, is used to enter the time required to acquire the measurement data (the time record).

The time entered for the DEFINE TIME LEN softkey is directly related to the measurement frequency span. The frequency span in Hertz is equal to 400 divided by the time record length in seconds. For example, if 40 milliseconds is required to acquire the time record, the measurement frequency span is 10 kilohertz ($400 \div 0.040$ seconds). Table 1-3 lists the time required to acquire the time record for the available measurement spans.

A different FREQ menu is displayed for the full octave and third octave modes. The full octave and third octave frequency menu is described under the full octave and third octave measurement modes.

Table 1-3. Frequency Spans, Resolution Time Record Lengths, and Display Resolution

Frequency Span (Hertz)	Time Record Length (Seconds)	Display Resolution (Hertz)
100K	0.004	250
50K	0.008	125
25K	0.016	62.5
20K	0.020	50
12.5K	0.032	31.25
10K	0.040	25
6.25K	0.064	15.625
5K	0.080	12.5
4K	0.100	10
3.125K	0.128	7.8125
2.5K	0.160	6.25
2K	0.200	5
1.25K	0.320	3.125
1K	0.400	2.5
800	0.500	2
625	0.640	1.5625
500	0.8	1.25
400	1.0	1
250	1.6	0.625
200	2.0	0.5
160	2.5	0.4
125	3.2	0.3125
100	4.0	0.25
80	5.0	0.2
50	8.0	0.125
40	10.0	0.1
32	12.5	0.08
25	16.0	0.0625
20	20.0	0.05
16	25.0	0.04
10	40.0	0.025
8	50.0	0.02
6.4	62.5	0.016
5	80.0	0.0125
4	100.0	0.01
3.2	125.0	0.008
*2.5	160.0	0.00625
2	200.0	0.005
1.6	250	0.004
1.28	312.5	0.0032
*1	400	0.0025
0.8	500	0.0020
0.64	625	0.0016
*0.4	1000	0.001
0.32	1250	0.0008
0.256	1562.5	0.00064
0.16	2500	0.0004
*0.128	3125	0.00032
*0.064	6250	0.00016
*0.0512	7812.5	0.000128
*0.0256	15625	0.000064
*0.01024	39062.5	0.0000256

* zero start only

ADJUSTING THE DISPLAY VERTICAL SCALE

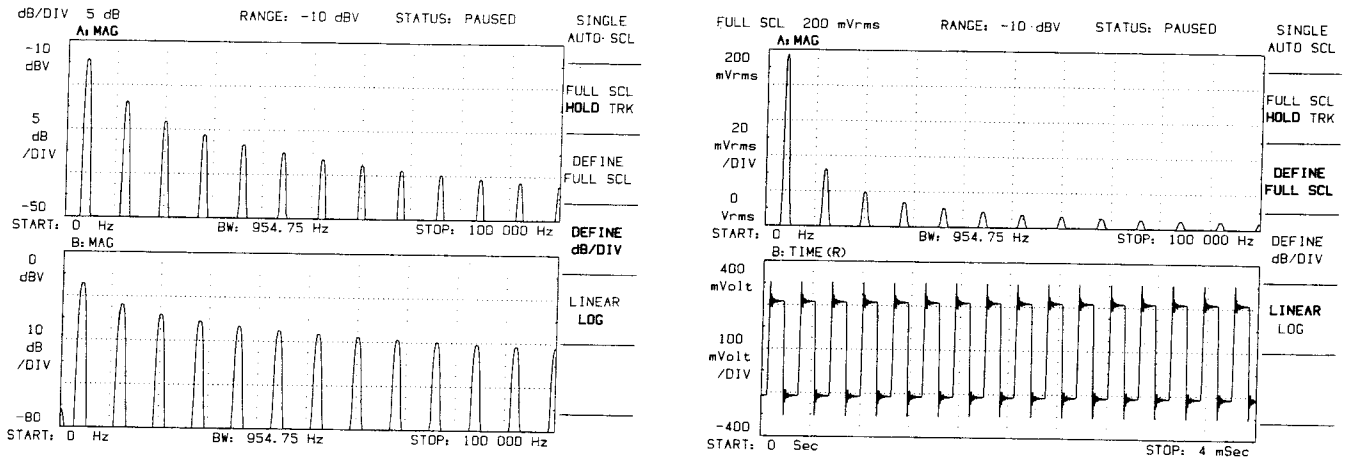

The display vertical axis is scaled through the VERT SCALE key menu. The vertical scale softkeys control only the display scaling and do not affect the input range. Changing the vertical scale does not affect acquired data.

When the TRK portion of the FULL SCL HOLD TRK softkey is intensified, vertical full scale is coupled to the input range. Changes in the input circuit range are reflected in the full scale value of the vertical scale. When the HOLD portion of the FULL SCL HOLD TRK softkey is intensified, coupling of the vertical full scale to the input range is disabled. Scaling of the full scale vertical axis by the input range is also disabled by selecting the SINGLE AUTO SCL or the DEFINE FULL SCL softkey.

The vertical full scale value is defined by selecting the DEFINE FULL SCL softkey and entering a value with the numeric keypad. The SINGLE AUTO SCL softkey scales both the units per division and full scale values of the vertical axis. The full scale value is based upon the largest signal in the trace. The units per division is selected based on both the maximum and minimum value of the trace.

The LINEAR LOG softkey selects either linear or logarithmic vertical scaling. The linear scale has a range from the indicated full scale voltage to zero volts. The logarithmic scale range is defined by the full scale value and the vertical axis scaling. For example, if the full scale value is 20 dBV, and the vertical axis scaling is 10 dB/DIV, the total range is 80 dB (10 dB/DIV \times 8 divisions) and the baseline is -60 dBV (20 dBV - 80 dB).

Variations on the current menu appear when different trace formats are selected. The alternate menus have similar entries but are tailored to the trace format selected. Operation through the other menus is similar to this magnitude trace format menu. Appendix A, "Quick Reference," illustrates the alternate menus for the instrument modes.

PROCESSING DATA

WINDOW SELECTION

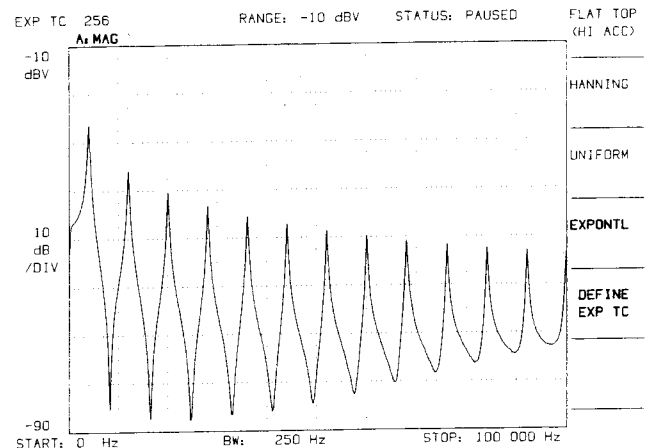
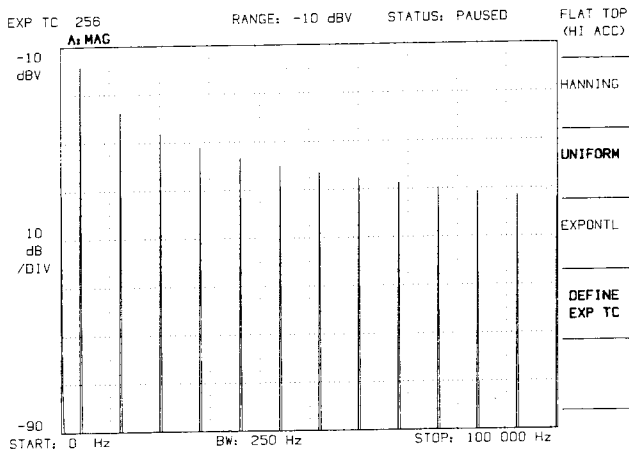
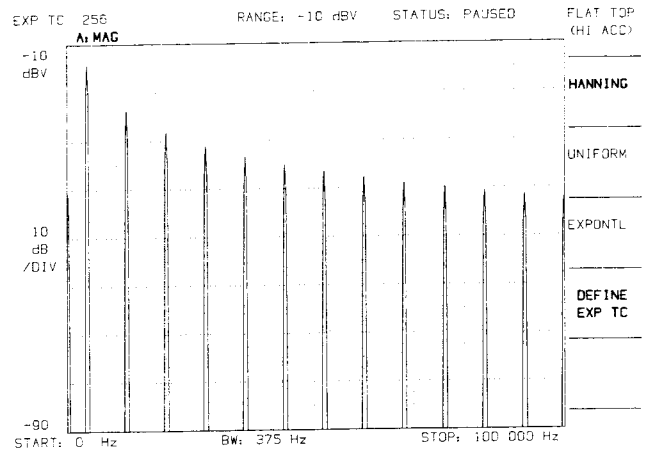
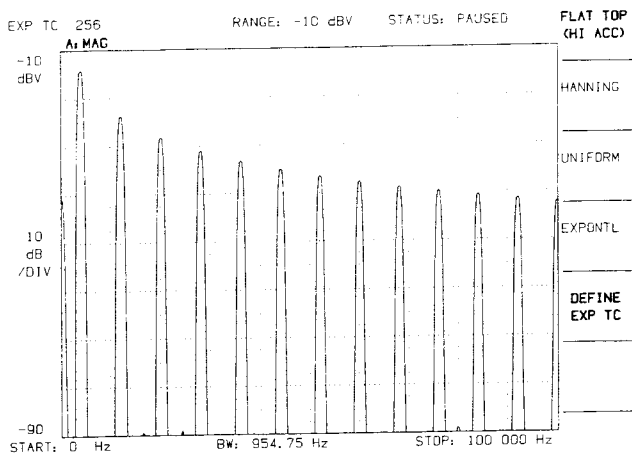

As the photographs illustrate, selection of the proper window applied to the input signal is important. Each window has different characteristics for adapting the -hp-3561A to a variety of signal conditions. The photographs are a result of applying different windows to the same input signal. The WINDOW key displays the menu for selection of the window shape used in processing the data. The WINDOW key displays the following softkeys: FLAT TOP (HI ACC), HANNING, UNIFORM, EXPNTL, and DEFINE EXP TC.

The FLAT TOP (HI ACC) softkey selects a window shape optimized for maximum amplitude accuracy. This window is most useful for the measurement of discrete frequencies and low level signals close to high level signals.

The HANNING softkey selects a window shape that offers better frequency resolution than the flat top window but reduces amplitude accuracy. This window is useful for random noise measurements.

The UNIFORM softkey selects a window shape that offers equal weighting of the time record. The uniform window is useful for measuring transients occurring entirely within a time record, or making response measurements with the internal periodic noise source or impulse source.

The EXPONTL softkey selects an exponential window. The exponential window is useful in analyzing transients that have not reached zero amplitude by the end of the time record. The exponential window can be used with the impulse noise source. The time constant for the exponential window is entered through the DEFINE EXP TC softkey. The value for the time constant is entered in terms of data samples. The time constant range limits are from 3 to 1024 data samples. If 1024 data samples (a complete time record) is entered for the time constant, the exponential window attenuates the signal by 1/e at the end of the time record.

AVRAGING

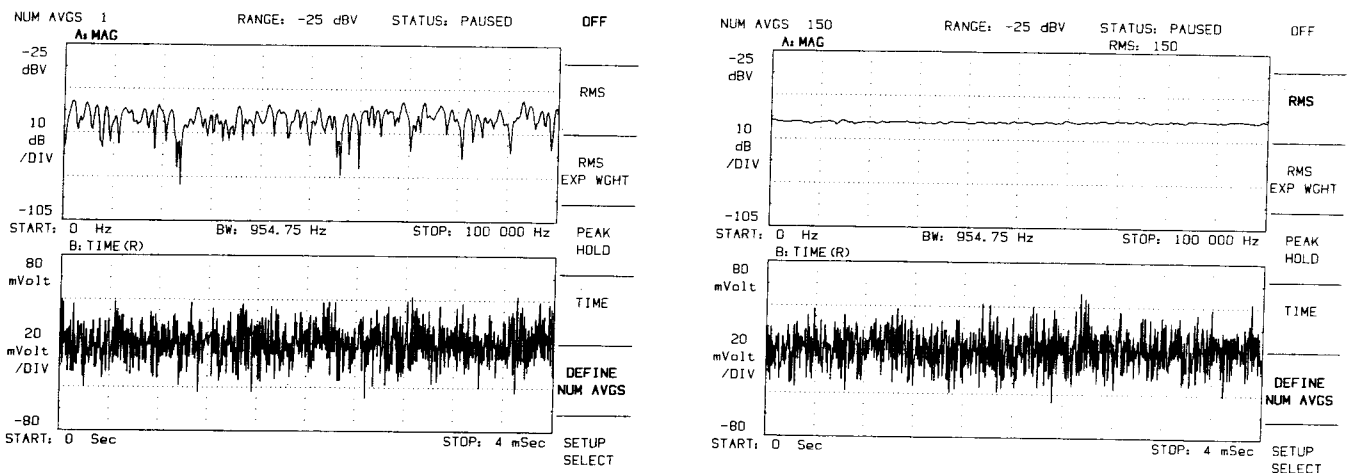

An additional aspect of processing a signal is the selection of the averaging method applied to the signal as illustrated by the photographs. The first photograph illustrates the instantaneous output of the -hp-3561A periodic noise source. (The noise source is enabled through the SOURCE key and the SOURCE OUTPUT connector is connected to the INPUT connector.) The second photograph illustrates the effects of averaging the noise signal with rms averaging. The AVG key displays the menu for selection of the averaging process applied. The primary menu for the AVG key includes: OFF, RMS, RMS EXP WGHT, PEAK HOLD, TIME, DEFINE NUM AVGS, and SETUP SELECT.

An intensified OFF softkey indicates that averaging functions are disabled. The front panel AVG indicator also provides an indication of the averaging functions. When averaging is enabled, the front panel AVG indicator is illuminated.

The RMS average mode combines a new spectrum with a partial result on a point-by-point basis using a root mean square calculation. RMS averaging results in smoothing of the noise variations but does not reduce the level of the noise. The number of averages used in the calculation is entered with the DEFINE NUM AVGS softkey.

The RMS EXP WGHT average mode is a continuous process that assigns more significance to recent data while older data dies out in importance at a decaying exponential rate. The number of averages entered with the DEFINE NUM AVGS softkey determines the weighting value. RMS EXP WGHT is most useful when the process under consideration exhibits relatively slow time variations and yet some averaging is still desired.

The PEAK HOLD mode is not a true averaging mode, but rather is the result of retaining the maximum amplitude value at each frequency point. The number of data samples evaluated is dependent upon the selection of the FINITE or CONT softkey available through the AVG key SETUP SELECT softkey. The CONT menu selection enables a continuous update of the data samples. The FINITE softkey limits the number of data samples to the value entered through the DEFINE NUM AVGS softkey.

The TIME average mode involves time domain averaging. The time average mode averages successive time records on a point-by-point basis. A synchronizing trigger is required for time averaging. Signal variations synchronous with the trigger average to a mean value while noise that is not synchronous averages to zero. Time averaging is unique in that it results in an enhancement of the signal-to-noise ratio. The -hp-3561A displays the USE TRIGGER FOR TIME AVERAGING message when time averaging is selected without selecting a trigger mode.

Values for the number of averages used in the averaging modes are entered with the DEFINE NUM AVGS softkey. Values for the number of averages are entered with the numeric keypad and range from 1 to 16,383.

Average measurements is restarted with the START key. Pressing the START key clears the accumulated average total and initiates a measurement. An average measurement is suspended with the PAUSE/CONT key. Pressing PAUSE/CONT during a measurement suspends the measurement. Pressing PAUSE/CONT with the measurement suspended continues the measurement.

SPECIAL AVERAGING FEATURES

Additional averaging options are available by selecting the SETUP SELECT softkey in the AVG key menu. The additional options control the display updates and allow exclusion of measurements containing data that overload the -hp-3561A circuits.

Measurements containing data that overload the -hp-3561A circuits are excluded from the accumulated average when the OVLD REJ ON OFF softkey is selected (ON). When data is rejected, the OVERLOAD — DATA BLOCK REJECTED message is displayed.

The NORMAL DISPLAY, FAST DISPLAY, and REPEAT DISPLAY softkeys are available when either the RMS, TIME, FINITE PK HOLD, or OCTAVE PK HOLD averaging mode is selected. The FAST DISPLAY function displays only the final computed average thus avoiding time delays due to display updates. The NORMAL DISPLAY function enables a display of the intermediate average results and the final computed average. The REPEAT DISPLAY function inhibits the display of intermediate average results and only the final computed average is displayed. REPEAT DISPLAY initiates additional measurements automatically without the interaction of the START key.

The FINITE and CONT softkeys are available in the PEAK HOLD mode. The FINITE softkey limits the number of PEAK HOLD data samples to the value entered through the DEFINE NUM AVGS softkey. The CONT softkey enables a continuous update of the PEAK HOLD data samples.

The DEFINE AVG OVLP softkey selects an averaging mode that performs processing on partial updates of the time record. This is useful when the data acquisition time length exceeds the FFT computation time. After the first time record is complete, subsequent computations are based on data acquired while the FFT algorithm is implemented plus as much old data as required to complete a time record for another FFT cycle. The DEFINE AVG OVLP softkey defines the maximum percent of time record overlap allowed during averaging. The -hp-3561A uses less than the defined overlap whenever the signal processing time exceeds the data acquisition length.

USING THE TRIGGER

The trigger function of the -hp-3561A defines the conditions for acquiring a new time record. The TRIG SEL key displays the menu for entering trigger mode parameters. The trigger functions of the -hp-3561A operate only in the narrow band and time capture modes.

The FREE RUN TRIGGER softkey selects either the FREE RUN or TRIGGER mode of operation. The FREE RUN mode collects a new block of data immediately after a measurement is completed. Conversely, the TRIGGER mode collects a new block of data only when conditions defined by other TRIG SEL softkeys are satisfied. Free run is convenient in establishing a trace display or verifying the presence of a signal. Trigger is useful in synchronizing a measurement to a signal, capturing transients, and capturing signals in the time buffer.

A valid trigger signal is indicated by illumination of the TRIG indicator. After a measurement is initiated with a trigger signal, the indicator remains illuminated during the measurement.

The MAN ARM AUTO ARM softkey selects either the MAN ARM or AUTO ARM trigger mode. The MAN ARM mode collects a single block of data when the trigger conditions are satisfied. Additional data is not acquired until the trigger is reset with the ARM key. The AUTO ARM mode automatically resets the trigger after each block of data is collected. The ARM indicator illuminates when the instrument trigger circuits are reset, or will be reset after completion of the current measurement.

The source of the trigger signal is selected with the INPUT TRIGGER, EXTERNAL TRIGGER, SOURCE TRIGGER, or INTERNAL TRIGGER softkeys. The INPUT TRIGGER softkey configures the -hp-3561A to derive the trigger signal from the signal applied to the front panel input. The EXTERNAL TRIGGER softkey configures the -hp-3561A to derive the trigger from the signal applied to the rear panel external trigger input. The SOURCE TRIGGER softkey configures the -hp-3561A to derive the trigger input from the internal noise source or impulse source. The INTERNAL TRIGGER softkey configures the -hp-3561A to trigger immediately after it is armed.

The SETUP SELECT softkey displays a menu for entering trigger signal parameters. The SLOPE POS NEG entry selects triggering on the positive or negative slope of the trigger source. The trigger slope does not apply when the noise source or impulse source is used as a trigger. The trigger point of the input signal amplitude is defined in terms of percent of range. The percent of range is entered through the DEFINE % OF RNG softkey. Allowable values for the percent of range are from -140 to 140. Trigger levels are entered with the numeric keypad and terminated with a % or CANCEL softkey.

Data collection is initiated prior to or after a valid trigger through the DELAY ON OFF and DEFINE + - DELAY softkeys. Analysis of data occurring prior to a trigger is possible by acquiring data in memory. Time delay values entered through this softkey are terminated with a units or CANCEL softkey. Positive delay values indicate that data collection starts after the trigger. Selecting an incompatible frequency span after entry of a time delay changes the time delay value to a value consistent with the frequency span and prints an advisory message on the display.

CAPTURING DATA - THE TIME BUFFER

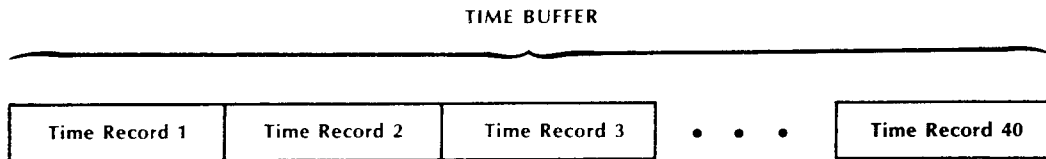

In the time capture mode, the -hp-3561A continuously digitizes and acquires time data and stores the results in memory. The memory containing the stored time data is the time buffer. The time buffer contains up to 40 contiguous time records. The

time capture mode is selected with the MODE key TIME CAPTURE softkey. Parameters for the time capture mode are entered with the TIME BUFFER key softkeys.

The size of the time buffer is defined by the number of time records to be acquired. The number of time records (from 1 to 40) retained in the time buffer is entered with the DEFINE # OF REC softkey. The START CAPTURE softkey clears the time buffer and enables the time capture measurement sequence. If the time capture mode is not selected, pressing the START CAPTURE softkey will also select the time capture mode. If triggering is used with time capture, the -hp-3561A will not trigger until after the START CAPTURE softkey is selected. Data is acquired with the measurement span and start or center frequency selected when the START CAPTURE softkey is pressed. Changing the measurement span, start frequency, or center frequency of the measurement after data is acquired does not alter the acquired data.

Processing of data collected in the time buffer starts with the time specified through the DEFINE START t softkey. For example, if a 10 kilohertz measurement span is selected for data capture, each time record has a length of 0.04 seconds ($400 \div 10$ kilohertz or from Table 1-3). Specifying a time of 0.02 seconds starts analysis with the center of the first time record if delayed trigger is not used. Specifying a time of 0.06 seconds starts analysis with the center of the second time record.

The contents of the time buffer is viewed by pressing the up or down arrow keys to scroll through the data. The percent of new data added to each time record processed for viewing is specified with the DEFINE % INCR (define percent increment) softkey. The lower limit of the increment is 0.0977% of a time record. A 100% increment indicates that all new data is contained in a time record. During the generation of a map display, the start time of each trace is increased by the increment value.

The frequency span of data displayed is reduced with the DEFINE ZOOM X softkey. ZOOM X is the zoom factor used in the reduction of the frequency span. Values used for the zoom factor are 1, 2, 4, 5, 8, 10, 16, 20, 25, 32, and 40. A zoom factor of 1 indicates that the full span display is enabled. Data must be acquired with a start frequency of zero Hertz to select a remaining zoom factor greater than 1.

The center frequency used in displaying the time buffer data is entered with the DEFINE ZOOM FRQ softkey. Changing the zoom factor, zoom frequency, percent increment, or start time does not alter data acquired in the time buffer.

The BUFFERFLE SELECT softkey, displayed in the TIME BUFFER key menu, displays a menu for recalling or storing the time buffer in bubble memory. The time buffer is stored in bubble memory by defining the file name, and selecting the STORE BUFFER softkey. A stored time buffer is recalled by defining the file name and selecting the RECALL BUFFER softkey. Operation of the bubble memory is described in Bubble Memory Operation.

MAP DISPLAY OPERATIONS

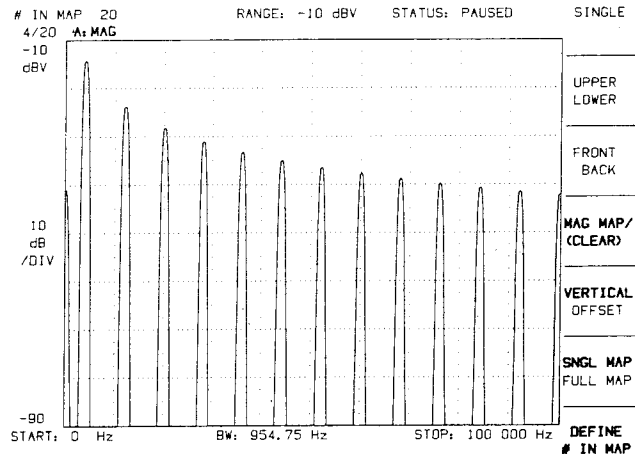
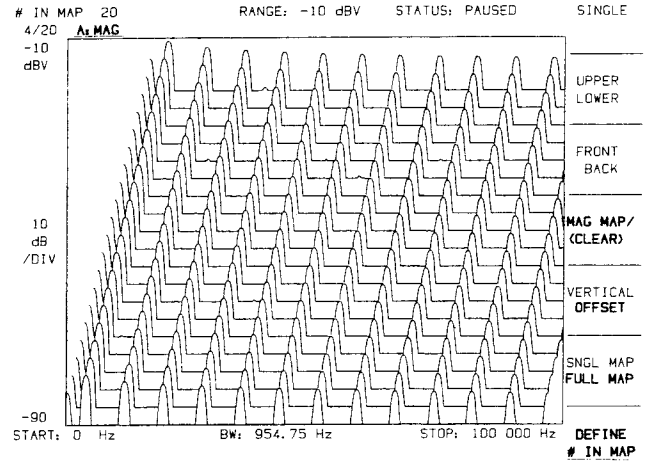
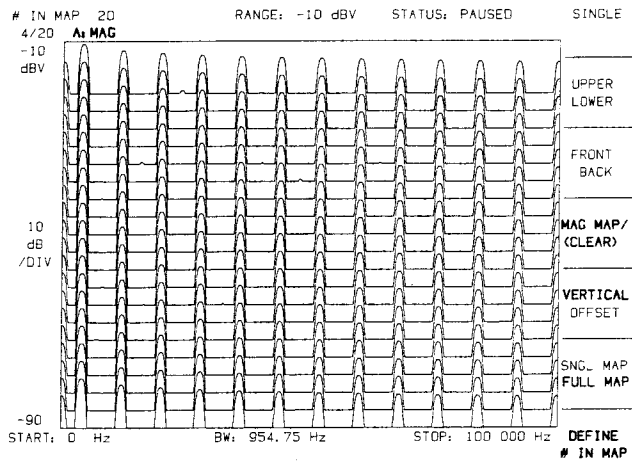

The MAG MAP/(CLEAR) softkey available in the FORMAT key menu displays multiple magnitude traces on a single graticule. The magnitude map display is available with either the narrow band or time capture mode selected. The full capability of the magnitude map is not realized until other -hp-3561A functions are applied. The magnitude map display is operational with the measurement frequency span reduced, averaging modes enabled, and a trigger. A magnitude map, acquired in the narrow band mode, may also be saved or recalled from bubble memory.

In the narrow band mode, the MAG MAP/(CLEAR) softkey clears the display and initiates data acquisition for the map display. In the time capture mode, the MAG MAP/(CLEAR) softkey clears the display and regenerates the map. The number of traces appearing on the display is entered through the DEFINE # IN MAP softkey. The maximum number of traces in a map is 60. Less than the requested number of traces is generated if there is insufficient data to generate the requested number of traces. Requesting a negative number of traces generates the map in reverse order. The number of traces in a map can be changed without acquiring new data.

Note

Requesting a negative number of traces before data is acquired for the map causes the map to be generated twice. The initial map display is generated as data is acquired. The second map display is generated as the -hp-3561A plots the map in reverse order.

The SNGL MAP FULL MAP menu selects either the normal (full) map display or a single trace map display. For the single trace map, the trace displayed is the active (intensified) trace in the full map. Pressing the NEXT TRACE key displays the next trace in the map. The selected trace and the number of traces in a map is indicated in the upper left corner of the display. Alternating the display between a single map display and a full map display does not require acquiring new data.

The VERTICAL OFFSET softkey selects either a vertical magnitude map or an offset magnitude map display. For a vertical map display, each trace displayed is offset in the vertical axis from the previous trace. For an offset map display, each trace displayed is offset in both the horizontal axis and the vertical axis. The alternate map format can be selected after a map is displayed without acquiring new data.

The map display is dependent upon other -hp-3561A parameters. For example, specifying a normal display with rms averaging generates only one trace in the map. Additional traces are not added to the map until another measurement is initiated with the START key. However, if a repeat display is enabled, the number of traces requested is generated because additional measurements are automatically initiated.

TRACE MATH

PERFORMING MATH OPERATIONS

The display of math operations is enabled with the DEFINE TRACE key MATH FUNCTION softkey. The operands used in the math function may be a magnitude or phase trace, nonvolatile trace memory M1 or M2, or a constant entered with the keypad. Math operations are defined through the DEFINE TRACE key MATH FCN SELECT softkey.

Figure 1-2 illustrates the menus displayed when a math function is defined through the MATH FCN SELECT softkey. The first and third menus define the operands for the math function. The second menu defines the math operation. Figure 1-2 describes the function of each softkey. The following conventions are used for the math operations:

- Trace data must be similar ($\frac{1}{3}$ octave, full octave, or narrow band).
- Trace type must be similar (phase or magnitude).
- Operations are on a point-by-point basis (i.e. frequency span is not checked).
- Math operations operate on linear data (volts, watts, EU's).
- The SPECTRAL DENSITY softkey defines the math function MAG/BW.
- For display units of VOLT (dBV) or EU (dBEU), SPECTRAL DENSITY displays magnitude divided by the square root of the measurement bandwidth ($MAG \div \sqrt{BW}$). For display units of VOLTS² (dBV), mW (dBm), or EU² (dBEU), SPECTRAL DENSITY displays magnitude squared divided by the measurement bandwidth ($MAG^2 \div BW$).
- Only the +, -, /, and * operations are used on $\frac{1}{3}$ and full octave data.
- The SINGLE INTEG, DOUBLE INTEG, or DIFF functions do not use a second operand.
- Memory locations M1 and M2 and constants K1 and K2 are common to both trace A and trace B math functions.
- Math function entry is terminated with the ENTER or CANCEL softkey.
- Display of the math function is enabled with the MATH FUNCTION softkey or when entry of the math function is completed with the ENTER softkey.
- Units of a math display are enclosed in parenthesis to indicate that the units displayed may not reflect the defined math operation.

Figure 1-2. Math Function Softkeys

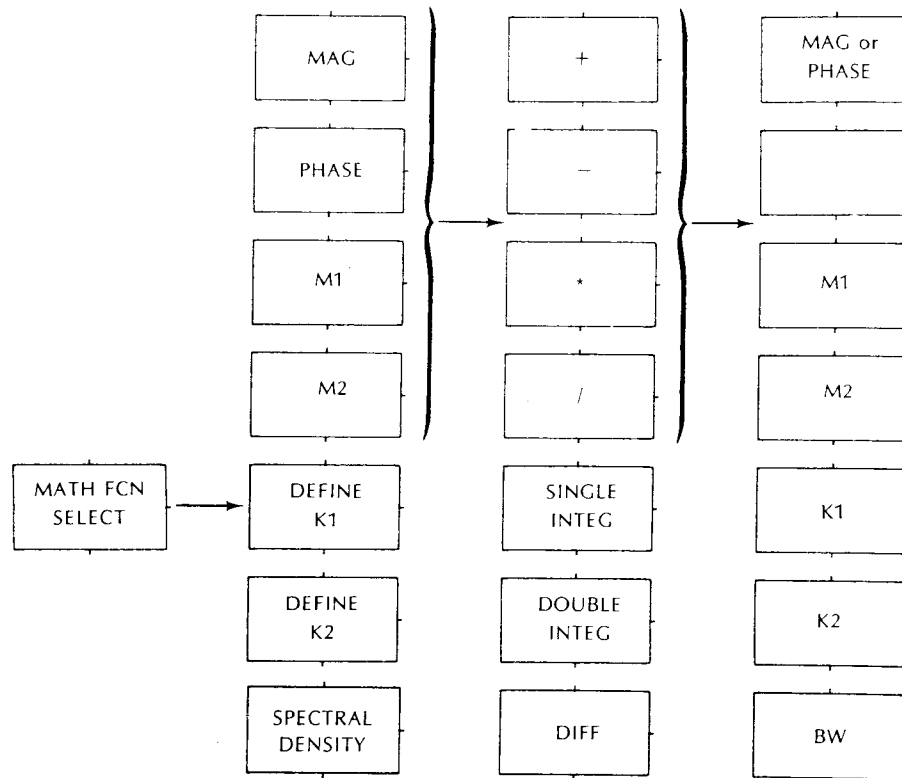

-
- MAG** Selects the magnitude trace as the first operand in a math function. The MAG operand uses the magnitude data (MAG, INPUT MAG, AVG MAG) defined for the active trace. If a time or phase trace is selected for the active trace, MAG display data is used for this operand.
 - PHASE** Selects the phase trace as the first operand in a math function. The results of phase math functions are in the range of $\pm 180^\circ$. Phase math operations are not applicable for 1/3 or full octave modes.
 - M1** Selects memory location M1 as the first or second operand in a math function.
 - M2** Selects memory location M2 for the first or second operand in a math function.
 - DEFINE K1** Enables entry of constant K1. Values for K1 are entered as linear values. Exponents are added to values entered with the numeric keypad with the ent exp (enter exponent) softkey. The ent exp softkey appears as constant K1 is defined with the numeric keypad. The absolute value of K1 is used when the math operation involves a magnitude trace.

- DEFINE** Enables entry of constant K2. Values for K2 are entered as linear values.
- K2** Exponents are added to values entered with the numeric keypad with the ent exp (enter exponent) softkey. The ent exp softkey appears as constant K2 is defined with the numeric keypad. The absolute value of K2 is used when the math operation involves a magnitude trace.
- SPECTRAL DENSITY** Selects the math function MAG/BW. For display units of VOLT (dBV) or EU (dBEU), SPECTRAL DENSITY displays magnitude divided by the square root of the measurement bandwidth ($MAG \div \sqrt{BW}$). For display units of VOLTS² (dBV), mW (dBm), or EU² (dBEU), SPECTRAL DENSITY displays magnitude square divided by the measurement bandwidth ($MAG^2 \div BW$).
- +** Selects addition as the math operation.
- Selects subtraction as the math operation.
- *** Selects multiplication as the math operation.
- /** Selects division as the math operation.
- SINGLE INTEG** Selects a single integration of the first operand as the math function. For a phase math operation, 90° is subtracted from each display position. For a magnitude math operation, each display position is divided by $2\pi f$ where f is the frequency of the display position.
- DOUBLE INTEG** Selects a double integration of the first operand as the math function. For a phase math operation, 180° is subtracted from each display position. For a magnitude math operation, each display position is divided by $(2\pi f)^2$ where f is the frequency of the display position.
- DIFF** Selects a single differentiation of the first operand as the math function. For a phase math operation, 90° is added to each display position. For a magnitude math operation, each display position is multiplied by $2\pi f$ where f is the frequency of the display position.
- MAG or PHASE** Selects the magnitude or phase display as the second math operand. The trace type of second operand is selected to be consistent with the first operand.
- K1** Selects constant K1 as the second operand in the math function.
- K2** Selects constant K2 as the second operand in the math function.
- BW** Selects the measurement bandwidth as the second operand. For narrowband data, the measurement bandwidth is the measurement span times a window factor divided by 400. For the 1/3 or full octave data, the measurement bandwidth is the bandwidth of the band times a window factor. The window factors are:

Flat Top 3.8194
Hanning 1.5
Uniform 1.0
Expontl 1.0.

TRACE MATH APPLICATIONS

The following series of illustrations show several applications of trace math. Each application has a short description of the results of the trace math and a summary of the algorithm entered through the MATH FCN SELECT softkey.

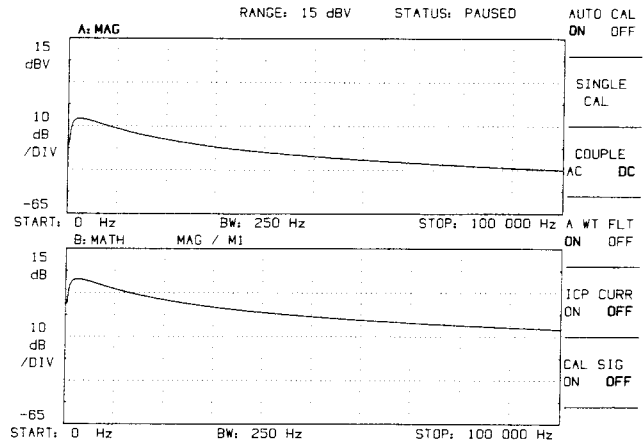
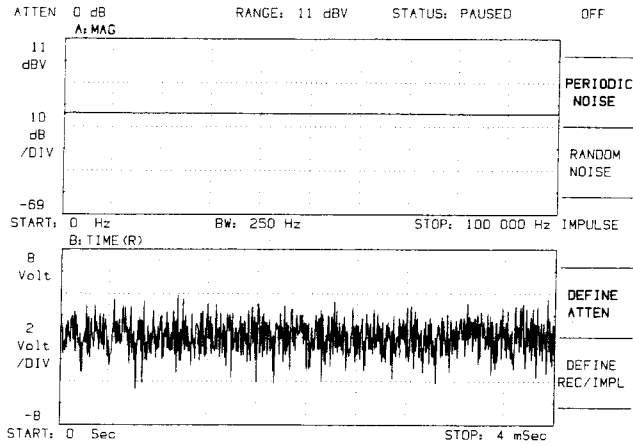

Magnitude Transfer Function (MAG/M1). The photographs show the traces used in obtaining the magnitude transfer function of the internal A-weighting filter. Initially, the periodic source is measured and the results are stored in memory M1. The -hp-3561A A-weighting filter is then enabled with the periodic noise source used as the input signal. The final step is to define the math function and display the results. The A-weighting filter magnitude transfer function may be obtained using the following key sequence.

Measure the source:

PRESET
 WINDOW - UNIFORM
 SOURCE - PERIODIC
 0 dB Attenuation
 TRIG SEL - TRIGGER
 SOURCE TRIGGER
 DEFINE TRACE - MAG
 STORE/RECALL - STORE IN M1

Measure the A-weighting filter:

INPUT - A-WT FLT ON

Calculate the magnitude transfer function:

NEXT TRACE (Select B)
 DEFINE TRACE - MATH FCN SELECT
 MAG
 /
 M1.
 ENTER.

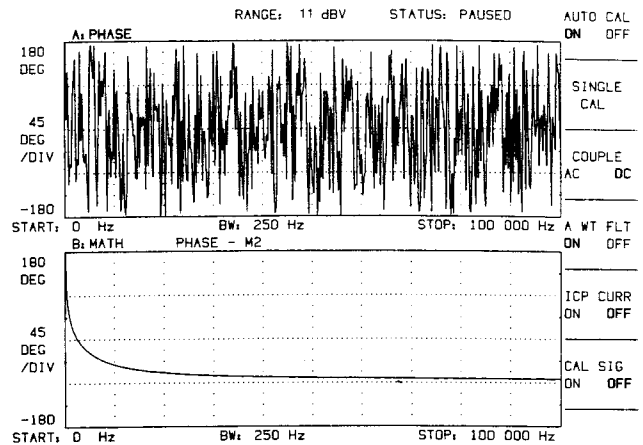
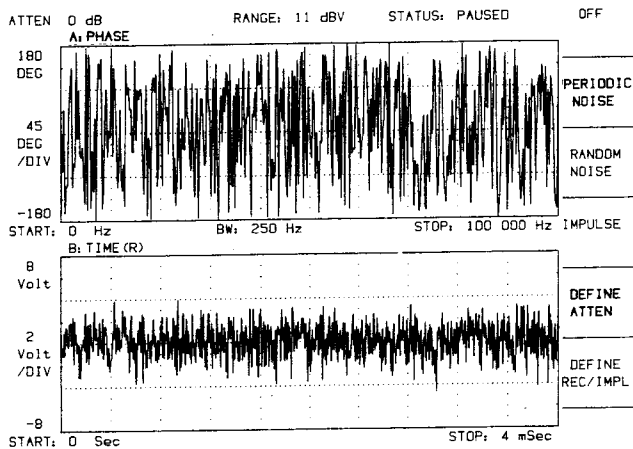

Phase Transfer Function (PHASE - M2). The photographs show the traces used in obtaining the phase transfer function of the internal A-weighting filter. Initially, the phase of the periodic source is measured and the results are stored in memory M2. The -hp-3561A A-weighting filter is then enabled with the periodic noise source used as the input signal. The final step is to define the math function and display the results. The A-weighting filter phase transfer function may be obtained using the following key sequence.

Measure the source:

PRESET
 WINDOW - UNIFORM
 SOURCE - PERIODIC
 0 dB Attenuation
 TRIG SEL - TRIGGER
 SOURCE TRIGGER
 DEFINE TRACE - PHASE
 STORE/RECALL - STORE IN M2

Measure the A-weighting filter:

INPUT - A-WT FLT ON

Calculate the phase transfer function:

NEXT TRACE (Select B)
 DEFINE TRACE - MATH FCN SELECT
 PHASE
 —
 M2
 ENTER.

CUSTOMIZING THE DISPLAY

CHANGING THE DISPLAY UNITS

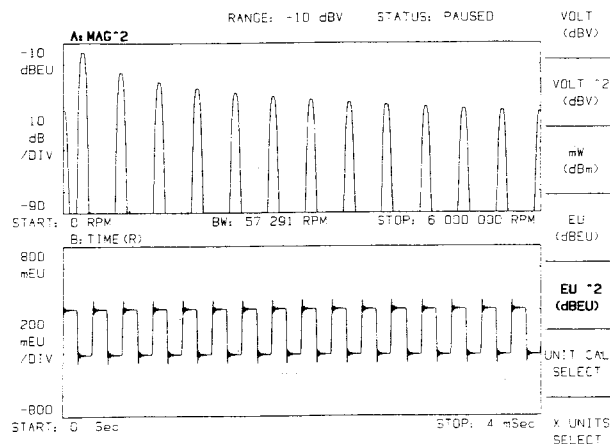
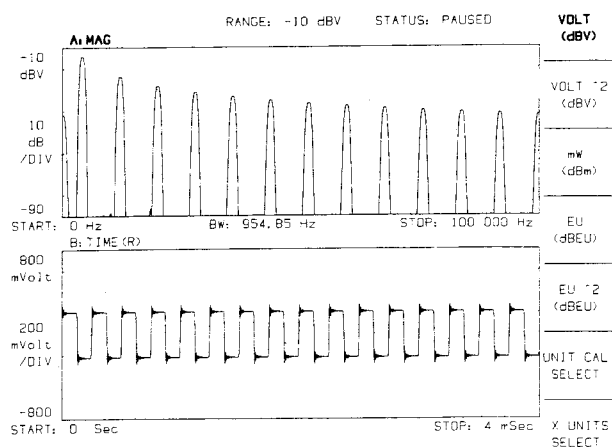

The display units are changed from those selected by the preset state with the softkeys available by pressing the UNITS Key. The VOLT (dBV), VOLT² (dBV), VOLT², mW (dBm), and EU (dBm), and EU² (dBm) softkeys select the units of the vertical scale. Engineering units (EU) are defined with the UNIT CAL SELECT softkey. The units of the horizontal scale are selected by pressing the X UNITS SELECT softkey.

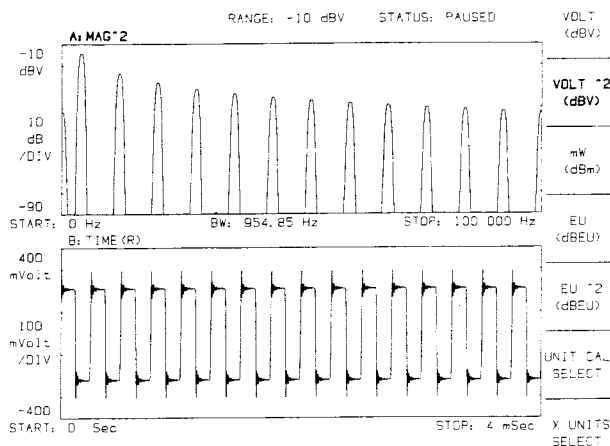
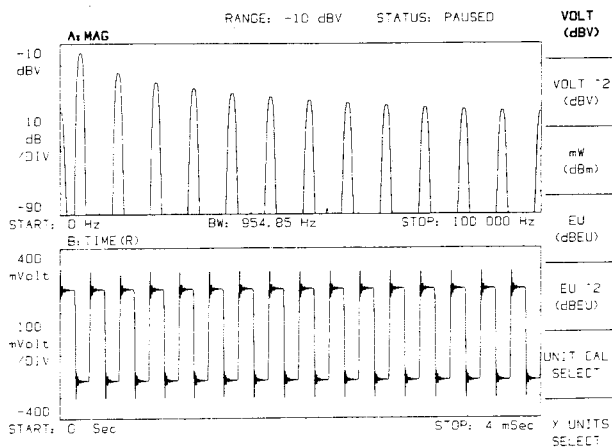

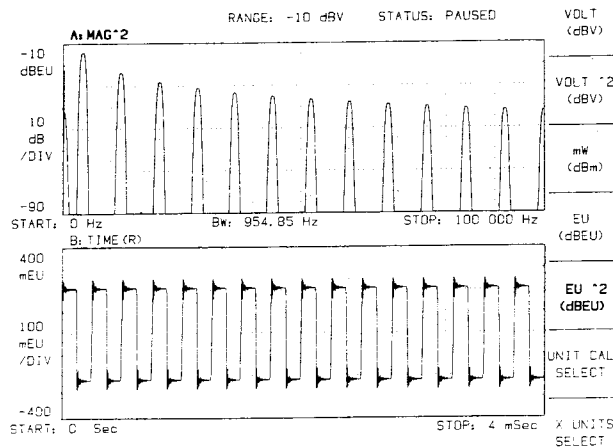
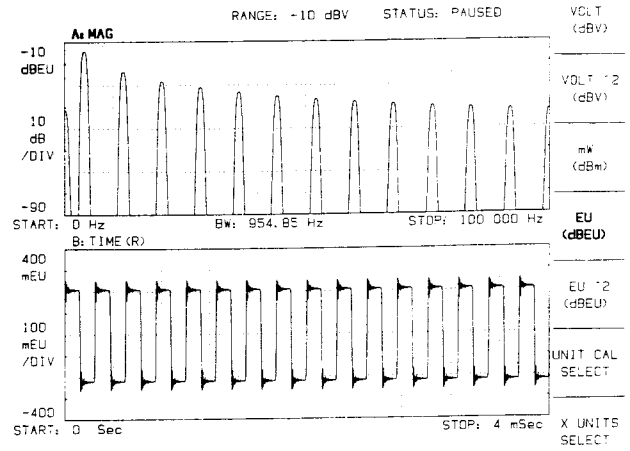
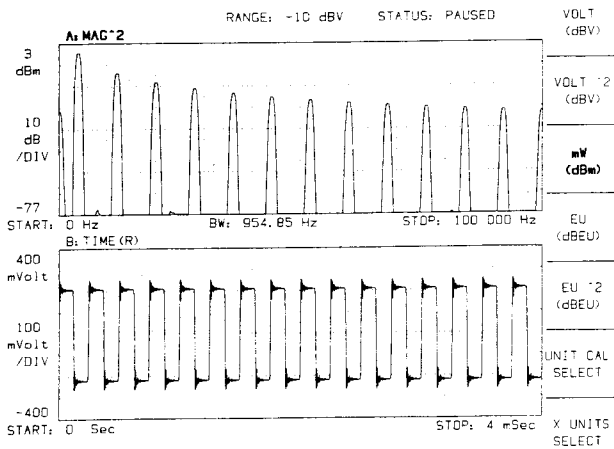

The volts (VOLT (dBV)) and voltage squared (VOLT ^2 (dBV)) softkeys assign the units of mV, mV^2 (mV^2), V, V^2 (V^2), or dBV to the vertical scale. Values are in rms units for magnitude displays. Peak units are used for time displays. The mW (dBm) softkey assigns the units of mW, and dBm to the vertical scale for magnitude. The peak units mV and V are assigned to vertical scale for time displays. The engineering units (EU (dBEU)) and engineering units squared (EU^2 (dBEU)) assigns the units of EU, EU^2 (EU^2), and dBEU to the vertical scale. Engineering units are defined through the UNIT CAL SELECT softkey.

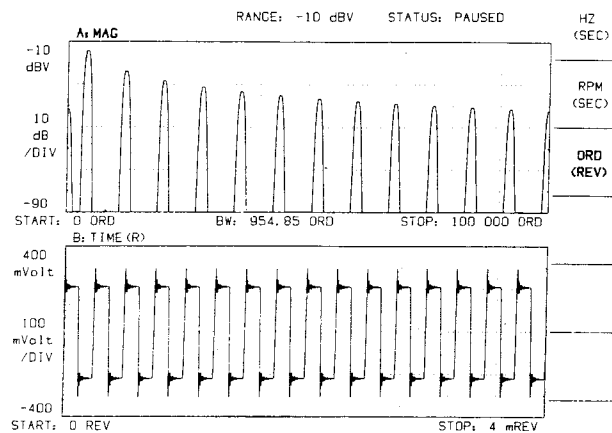
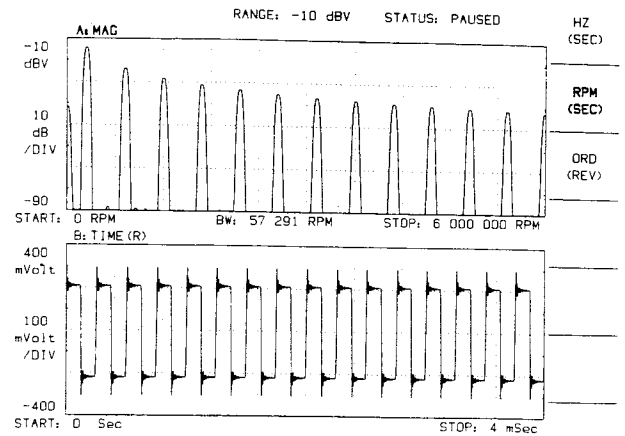
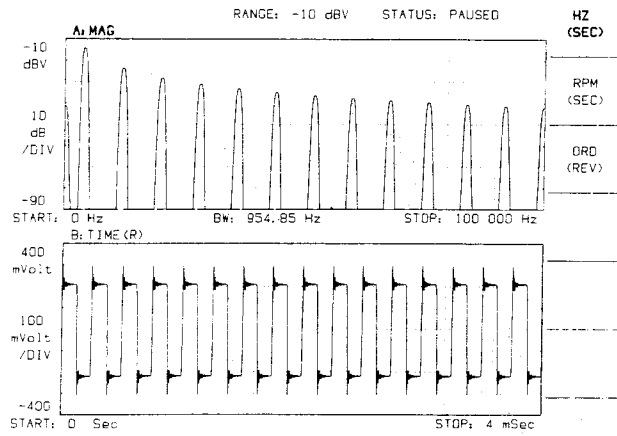

Softkeys for selecting the horizontal axis units are enabled by pressing the X UNITS SELECT softkey. The HZ (SEC) softkey assigns the units of Hertz or seconds to the horizontal axis. The RPM (SEC) softkey assigns the units of RPM (revolutions per minute) or seconds to the horizontal axis. The ORD (REV) softkey assigns the units of orders or revolutions to the horizontal axis.

ENTERING ENGINEERING (USER) UNITS

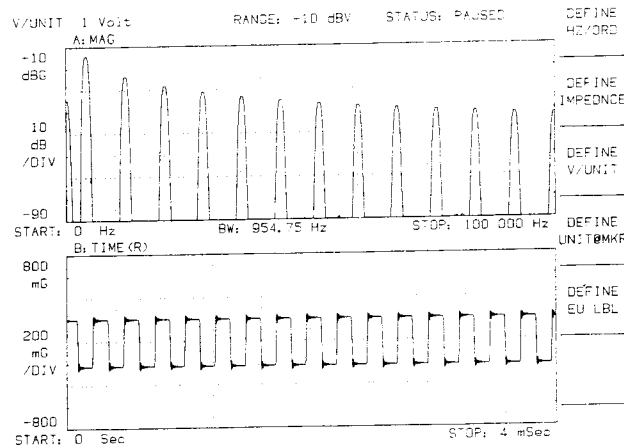

The -hp-3561A display is calibrated for engineering units through the UNITS key. The display of the engineering units is enabled with the EU (dBEU) or EU² (dBEU) softkey. The menu for defining the engineering units is displayed by selecting the UNIT CAL SELECT softkey.

The vertical scale is calibrated for engineering units with the DEFINE V/UNIT and DEFINE UNIT@MKR softkeys. The conversion factor converting the input voltage to engineering units is entered through the DEFINE V/UNIT softkey. The engineering units value corresponding to the current marker position is entered through DEFINE UNIT@MKR softkey. Values entered with the numeric keypad are terminated with a units or CANCEL softkey. Exponents are added to values entered for the DEFINE UNIT@MKR softkey through the ent exp (enter exponent) softkey. The ent exp softkey appears as the engineering units are defined with the numeric keypad.

The vertical scale engineering units annotation is entered through the DEFINE EU LBL softkey. Selection of this softkey places the -hp-3561A into an alphanumeric entry mode (see Table 1-4). Label entry is ended with the CANCEL or ENTER softkey.

The impedance value used for power computations is entered through the DEFINE IMPEDNCE softkey. The default value for impedance is 50 ohms with an entry range of 1 ohm to 25 kilohms. The DEFINE IMPEDNCE softkey value is used only when the mW (dBm) softkey is selected. Values entered with the numeric keypad are terminated with a units or CANCEL softkey.

The horizontal axis is scaled with the DEFINE HZ/ORD or DEFINE PULS/REV softkey. The number of Hertz per order is entered through the DEFINE HZ/ORD softkey. The DEFINE PULS/REV softkey is displayed in the MODE key menu. The number of pulses per revolution used in the external sample mode is entered through the DEFINE PULS/REV softkey.

Table 1-4. The Alphanumeric Entry Menu

Selecting a DEFINE TRACE LBL, DEFINE EU LBL, or DEFINE FILENAME softkey places the -hp-3561A into an alphanumeric entry mode. In the alphanumeric entry mode, the blue characters near the front panel keys are assigned to the keys. Character entry is terminated with the CANCEL or ENTER softkey and the labeled keys revert to their normal functions.

While in the alphanumeric mode the -hp-3561A displays a menu for editing the label or file name.

ENTER	The ENTER softkey accepts the label or name entry and assigns the entry to the engineering units label, trace label, or file name.
CLEAR ENTRY	The CLEAR ENTRY softkey clears the entry area of the display.
EDIT - >	The EDIT - > softkey moves the entry cursor right.
EDIT < -	The EDIT < - softkey moves the entry cursor left.
INSERT SPACE	The INSERT SPACE softkey inserts a space at the cursor position.
DELETE CHAR	The DELETE CHAR (delete character) softkey deletes the character at the cursor position.
CANCEL	The CANCEL softkey terminates the alphanumeric entry mode without accepting the label or name entry.

Note

In the alphanumeric entry mode, only the ENTER and CANCEL softkeys will restore the -hp-3561A to normal operation because alphanumeric characters are assigned to the labeled keys.

ANNOTATING THE DISPLAY

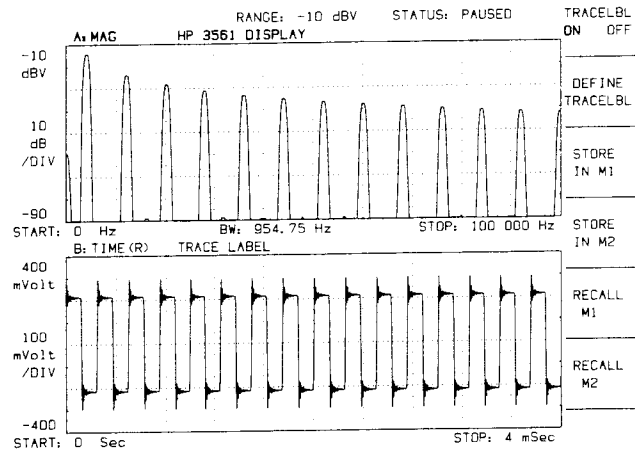

Each trace may be annotated with a unique trace label for identification. Trace label display is enabled through the STORE/RECALL key with the TRACELBL ON OFF softkey. An eighteen character alphanumeric trace label is defined with the DEFINE TRACELBL softkey. Selection of the DEFINE TRACELBL softkey places the -hp-3561A into an alphanumeric entry mode (see Table 1-4). Label entry is ended with the CANCEL or ENTRY softkey.

PLOTTING THE DISPLAY

USING A PLOTTER

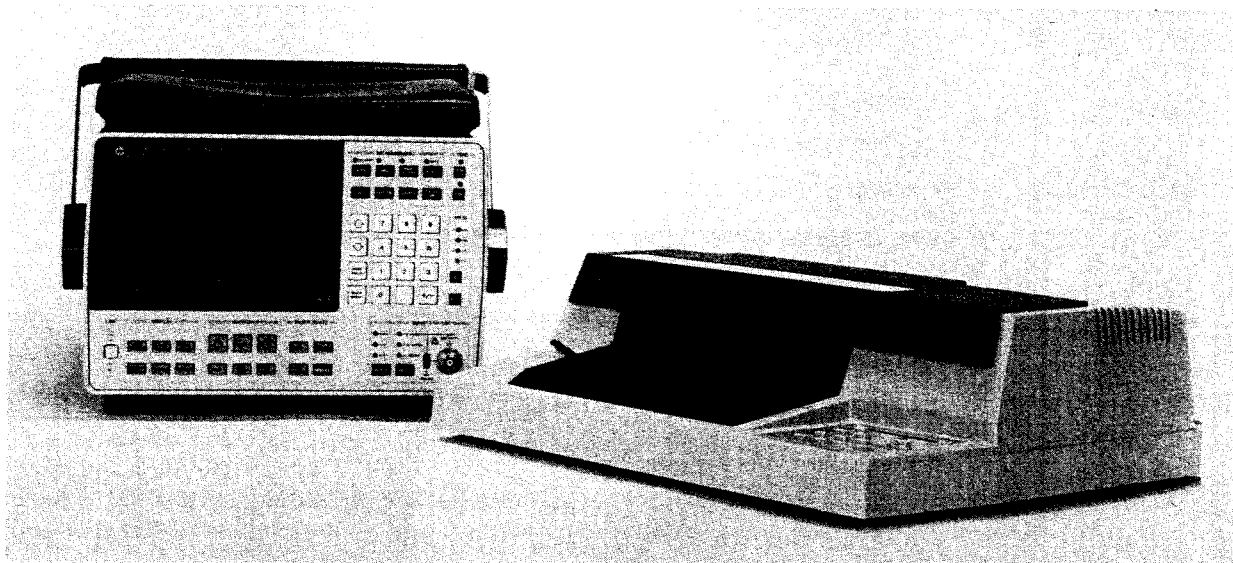

The -hp-3561A can plot directly to a Hewlett-Packard Graphics Language (HP-GL) plotter connected to the HP-IB connector. Plots can be any of the available displays (text, single trace, dual trace, or map). The option of plotting with or without the display grid, display annotation, and marker is available. Pen color and the type of line plotted (see Figure 1-3) can also be specified through softkeys. The following example uses procedures for the -hp-7470A plotter.

Plotter Set Up.

- Set the plotter HP-IB address to listen only (address switches 1 through 5 set to the "1" position).
- Select the plotter paper size (A4 for 210 by 297 millimeter paper, US for 8 ½ by 11 inch paper).
- Select and load the pens into the plotter.
- Connect the HP-IB cable between the plotter and the -hp-3561A.
- Apply power to the plotter.
- Load and position paper in the plotter.

-hp-3561A Set Up.

- Press the LCL key to display the menu.
- Select the TLK ONLY ON OFF softkey to intensify the ON portion of the label.
- Press the PLOT key to display the plot menu.
- Select the PLOT options desired. Plotting of the display annotation is enabled or disabled with the ANNOTATE ON OFF softkey. Plotting of the display grid is enabled or disabled with the GRID ON OFF softkey.
- Select the SETUP SELECT softkey to display the plot set up menu options.
- Enter the desired set up. See Figure 1-3 for line types.

Softkey	Range	Default Value
DEFINE A LINE	1-7	1
DEFINE B LINE	1-7	1
DEFINE A PEN	0-127	2
DEFINE B PEN	0-127	2
GRID PEN	0-127	1

Plotting the Display.

- Obtain the trace to be plotted on the display.
- If necessary, press the PLOT key to display the plot menu.
- Select the PLOT softkey to plot the trace.
- If desired, plot the marker values with the PLOT MARKER softkey.
- A plot may be terminated by selecting the ABORT PLOT softkey.

Figure 1-3. Plotter Line Types

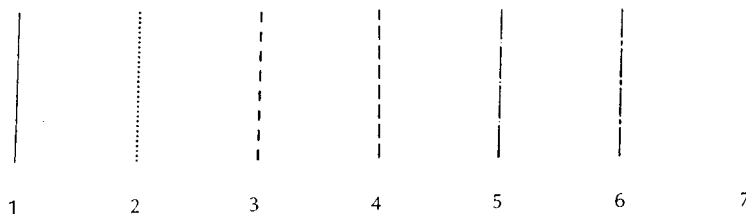

PLOTTING WITH A PRINTER

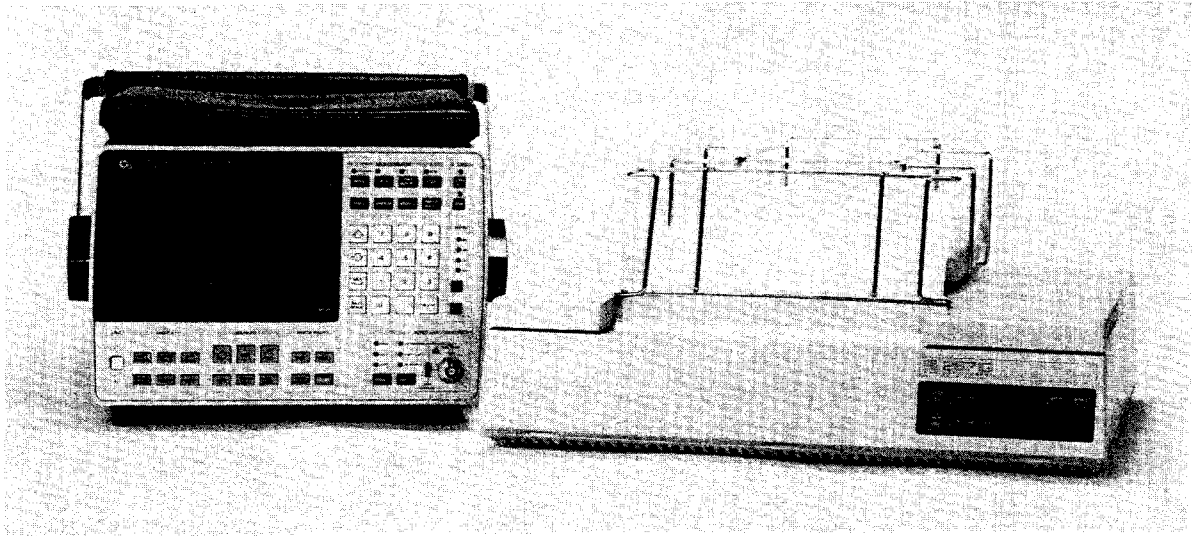

The -hp-3561A can plot directly to a Hewlett-Packard raster graphics printer connected to the HP-IB connector. Plots can be any of the available displays (text, single or dual trace mode). The following example is using procedures for the -hp-2671G printer.

Printer Set Up

- Set the printer HP-IB address to listen always (address switch 6 set to the "1" position).
- Load and position paper in the printer.
- Connect the HP-IB cable between the printer and the -hp-3561A. Apply power to the printer

-hp-3561A Set Up

- Press the LCL key to display the menu.
- Select the TLK ONLY ON OFF softkey to intensify the ON portion of the softkey.

Plotting the Display

- Obtain the trace to be plotted on the display.
- Press the PLOT key to display the plot menu.
- Select the COPY TO PRINTER softkey to plot the display.

Note

The plot options ANNOTATE ON OFF, GRID ON OFF, and PLOT MARKER are not applicable for a printer.

- A plot may be terminated by pressing the ABORT PLOT key.

MEMORY OPERATIONS

SAVING/RECALLING A FRONT PANEL SETUP WITHOUT BUBBLE MEMORY

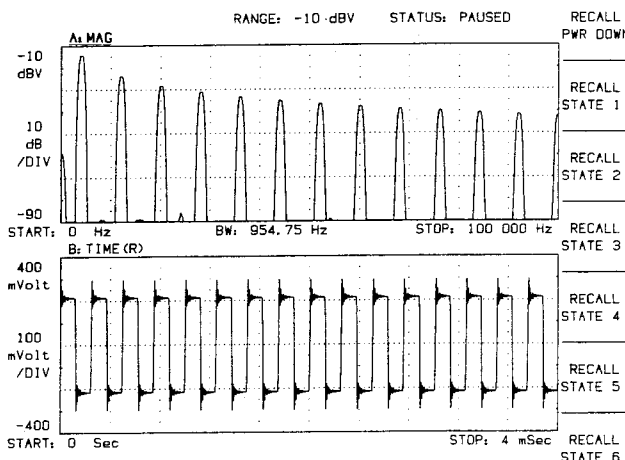
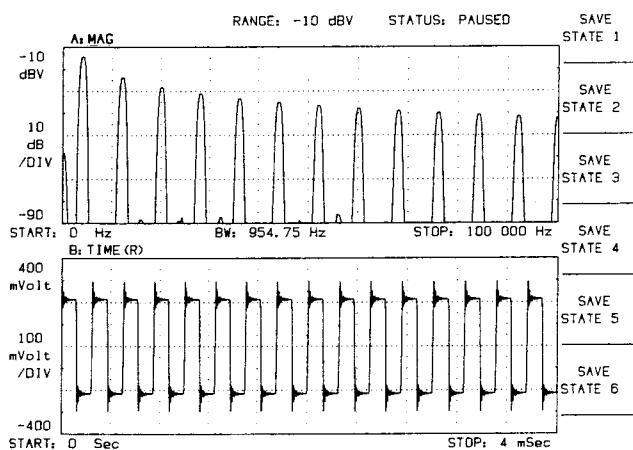

Saving an instrument setup (state) in nonvolatile memory is a simple two key operation. The operation consists of pressing the SAVE key to display the menu for saving the instrument state, and then storing the state in memory by selecting the storage location. Storage locations are available to save six instrument states. The storage locations are convenient to store a baseline instrument state to recall as a preset state, or to store a series of instrument states used in a measurement sequence.

Recalling an instrument state is also a two key operation consisting of pressing the RECALL key to display the menu, and then selecting the instrument state to recall. Seven instrument states are available for recall. Six of the available states are the instrument states saved through the SAVE key. The seventh state is the last operating state of the -hp-3561A selected prior to removing power. The last operating state is recalled with the RECALL PWR DOWN softkey.

SAVING/RECALLING A FRONT PANEL SETUP WITH BUBBLE MEMORY

RANGE: -10 dBV STATUS: PAUSED

FILENAME INDEX	TYPE	SIZE	DEFINE FILENAME
TIMECAP	BUFFERED	81	USE CAT FILENAME
STATE1	SETUP	1	
STATE2	SETUP	1	SAVE STATE
HP. 0	TRACE	1	
HP. 2	TRACE	1	
HP. 4	TRACE	1	DELETE
HP. 6	TRACE	1	
HP. 8	TRACE	1	
HP. 10	TRACE	1	
HP. 12	TRACE	1	ABORT
HP. 14	TRACE	1	
HP. 16	TRACE	1	
HP. 18	TRACE	1	
HP. 20	TRACE	1	CATALOG
HP. 22	TRACE	1	ON OFF
HP. 24	TRACE	1	

BUBBLE RECORDS AVAILABLE FOR NEW STORES: 24

The bubble memory option adds the capability of saving more than six instrument setups (states) and assigning descriptive names to instrument state files. Saving an instrument state involves pressing the SAVE key to display the SAVE menu, defining the file name, and selecting the SAVE STATE softkey.

Recalling an instrument state is accomplished by first pressing the RECALL key to display the menu. Then, as in saving the instrument state, the file name is defined, and the instrument state is recalled with the RECALL STATE softkey. Bubble memory management is described in Bubble Memory Operation.

SAVING/RECALLING A TRACE IN NONVOLATILE MEMORY M1 AND M2

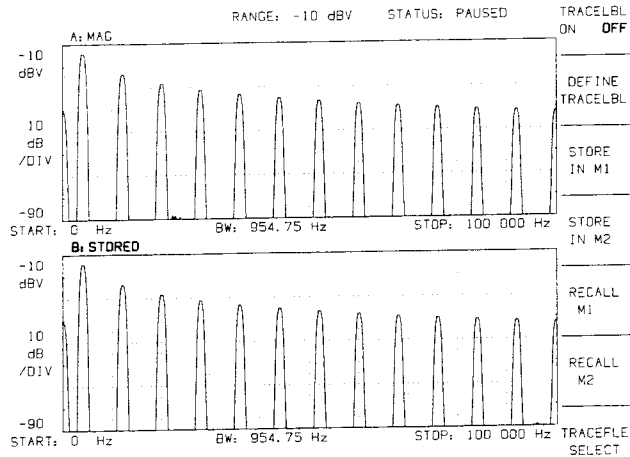

Two display traces can be saved to nonvolatile memory for use with math functions or viewing at a later time. The store or recall operation consists of pressing the STORE/RECALL key to display the menu. The active trace is stored by selecting the STORE IN M1 or STORE IN M2 softkey. The active trace is replaced by a trace in memory by selecting the RECALL M1 or RECALL M2 softkey.

SAVING/RECALLING A TRACE IN BUBBLE MEMORY

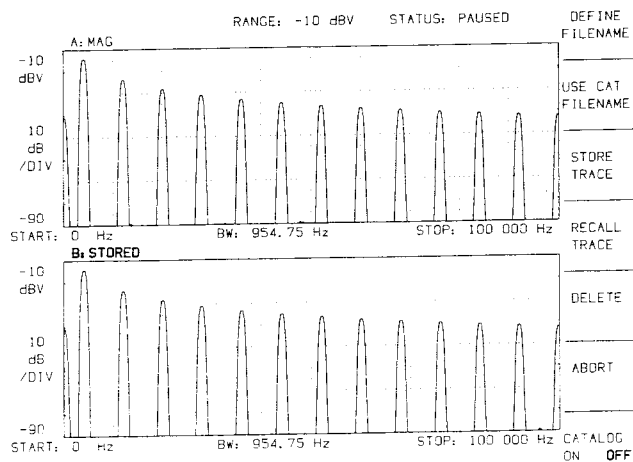

The optional bubble memory provides storage of display traces in nonvolatile memory in addition to the trace memory locations M1 and M2. The TRACEFLE SELECT softkey, displayed by pressing the STORE/RECALL key, displays the menu for recalling or storing traces in bubble memory. The active trace is saved to bubble memory by defining the file name, and selecting the STORE TRACE softkey. A stored trace is recalled as the active trace by defining the file name and selecting the RECALL TRACE softkey. Bubble memory management is described in Bubble Memory Operation.

SAVING/RECALLING MAPS WITH BUBBLE MEMORY

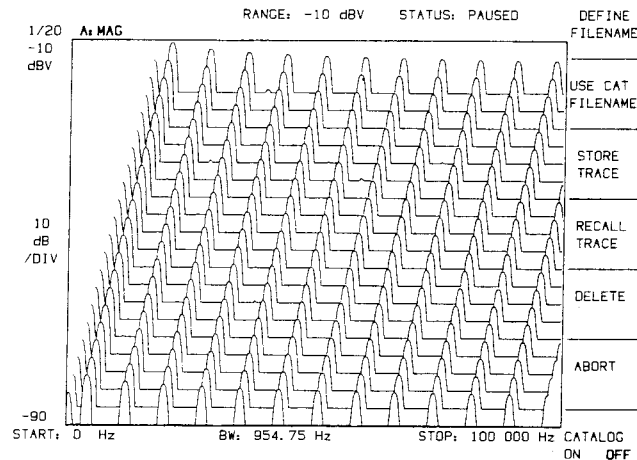

The method of storing or recalling a map display is dependent upon the selection of the full map or single map display. The method of storing or recalling a single map display in bubble memory is the same as storing or recalling a trace. The TRACEFLE SELECT softkey, displayed by pressing the STORE/RECALL key, displays the menu for recalling or storing traces in bubble memory. The trace is saved to bubble memory by defining the file name and selecting the STORE TRACE softkey. Recalling a trace for the single map incorporates the trace into the full map.

The method of storing a full map display utilizes indexing of the bubble memory file name. When a full map is stored, each trace is stored separately in an indexed file. An indexed file appears in the catalog as a file name followed by a period and number (such as HP.3). The index defaults to zero if a nonindexed file name (such as HP) is used for a store operation. Entering a file name with an index (such as HP.5) stores the first map trace with that index number. Each following trace is stored with an index number incremented by 2. Only the traces appearing in a map are stored. Map traces are stored in the order that data is acquired.

Note

Using duplicate file names when storing a full map can delete all indexed files with the same file name. A nonindexed file name deletes the indexed files with the same name. An indexed file name deletes the index files of the same file name starting at the index number used. For example, storing HP.15 deletes the index files in the range of HP.15 through HP.255 before the current map is stored.

Traces are recalled to a full map with either indexed or nonindexed file names. Recalling a file with a full map display clears the current map for displaying the recalled traces. Recalling a trace with a nonindexed file name recalls only one trace to the map. Recalling a trace with an indexed file name recalls multiple traces. Indexed files are recalled from memory starting with the index file specified. Additional indexed files are recalled and added to the map until the map has the number of traces requested (# in map) or the upper index is reached. For example, if a map is limited to 10 traces, and a recall is initiated with the file name HP.5, the memory is searched for files HP.5 through HP.255. Files are recalled until the 255 index limit is reached, or the map contains 10 traces.

Traces are added to a map display by recalling traces to a single map. Recalling either an indexed or nonindexed file replaces only the active trace in the full map.

Maps generated from time buffer data can not be stored. However, the time buffer data can be stored in the bubble memory for generation of the map at a later time. Information on auto-indexing and bubble memory management is described in Bubble Memory Operation.

SAVING/RECALLING THE TIME BUFFER WITH BUBBLE MEMORY

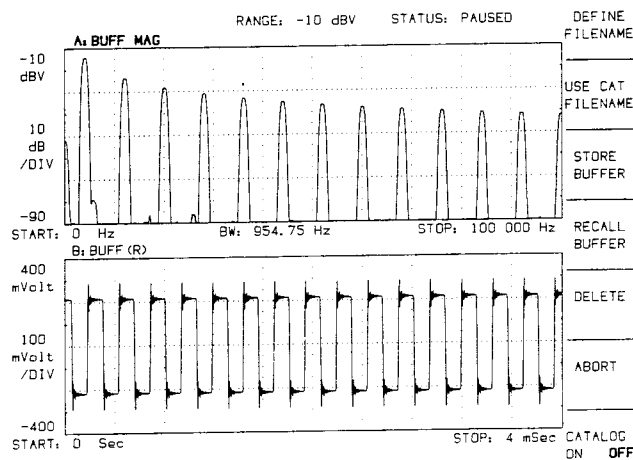

The contents of the time buffer are stored in bubble memory or recalled from bubble memory through the BUFFERFLE SELECT softkey available in the TIME BUFFER key menu. Selecting the BUFFERFLE SELECT softkey displays the menu for bubble memory operation. The BUFFERFLE SELECT softkey is not available if the bubble memory is not installed. The time buffer is stored by defining the file name

and selecting the STORE BUFFER softkey. Time buffer data is recalled by defining the file name and selecting the RECALL BUFFER softkey. Bubble memory management is described in Bubble Memory Operation.

Note

The STORE/RECALL key menu options operate on display traces. Storing time buffer data through the STORE/RECALL key stores only the displayed trace and not the time buffer contents.

BUBBLE MEMORY OPERATION

	RANGE: -10 dBV	STATUS: PAUSED	DEFINE FILENAME
FILENAME, INDEX	TYPE	SIZE	-----
-----	-----	-----	USE CAT FILENAME
TIMECAP	BUFFERED	01	-----
STATE1	SETUP	1	-----
STATE2	SETUP	1	SAVE STATE
HP. 0	TRACE	1	-----
HP. 2	TRACE	1	-----
HP. 4	TRACE	1	DELETE
HP. 6	TRACE	1	-----
HP. 8	TRACE	1	-----
HP. 10	TRACE	1	-----
HP. 12	TRACE	1	ABORT
HP. 14	TRACE	1	-----
HP. 16	TRACE	1	-----
HP. 18	TRACE	1	-----
HP. 20	TRACE	1	CATALOG
HP. 22	TRACE	1	ON OFF
HP. 24	TRACE	1	-----

BUBBLE RECORDS AVAILABLE FOR NEW STORES: 24

The optional bubble memory is accessed through the TIME BUFFER, STORE/RECALL, SAVE, and RECALL keys. Each of these front panel keys has unique store and recall softkeys. The STORE BUFFER and RECALL BUFFER softkeys, available in the TIME BUFFER key menu, store and recall time buffer data. The STORE TRACE and RECALL TRACE softkeys, available in the STORE/RECALL key menu, store and recall the display trace data. The SAVE STATE softkey, available in the SAVE key menu, and the RECALL STATE softkey, available in the RECALL key menu, save and recall instrument state data.

The names of the files stored in bubble memory are listed in the bubble memory catalog. Display of the catalog is enabled or disabled by selecting the CATALOG ON OFF softkey. The catalog files are grouped by file type, and listed in alphabetical order. The catalog can contain up to 127 entries. The catalog is scrolled with the up and down arrow keys. Each catalog entry lists the name of the file, the type of data in the file, and the size of the file.

Catalog file names have the form of FILENAME or FILENAME.###. FILENAME is the name assigned to the file. The FILENAME is limited to nine characters and cannot contain spaces or the characters “:”, “.”, or “*”. The optional designator ### is an integer number for auto-indexing of magnitude trace files.

It is necessary to define a file name to store, recall, or delete bubble memory files. File names are defined with the DEFINE FILENAME and USE CAT FILENAME softkeys. The USE CAT FILENAME softkey uses the catalog file name at the top of the display for the bubble memory operation.

A file name is entered directly by selecting the DEFINE FILENAME softkey to setup the -hp-3561A for accepting the file name. When DEFINE FILENAME is selected, the blue characters adjacent to the front panel keys are assigned to the keys. When the keys are pressed, the characters are added to the file name. An editing menu is displayed during character entry. Table 1-4 describes the editing operations. Filename entry is ended by selecting the ENTER or CANCEL softkey.

The optional auto-index designator in a file name is an integer number for auto-indexing of magnitude trace files. After a trace file is stored using a number assigned as the designator, the designator is automatically incremented by 2. As an example, storing a trace file with the name HP.1 initiates auto-indexing. After auto-indexing is initiated, subsequent stores create HP.3, HP.5. . .to HP.255. The index designator can range from 0 to 255.

When a store operation is attempted and the bubble memory does not have enough storage space remaining, the CANNOT PERFORM STORE: ____ MORE BUBBLE RECORDS REQD prompt is displayed. To continue the store operation, files must be deleted from the bubble memory. Any type of file maybe deleted from the bubble memory for additional storage space.

The DELETE softkey deletes the file named through the DEFINE FILENAME or USE CAT FILENAME softkey. All DELETE softkeys can delete a trace, setup, or time buffer file providing the type of file is specified with the file name. The type of file is specified by adding :S for a Setup file, :T for a Trace file, and :B for a time Buffer file. The capability of deleting any type of file is convenient for deleting files to gain additional bubble memory storage space.

Note

A store or recall operation using :S, :T, or :B, (or the colon and file type) is permitted providing the file type is consistent with the type of operation attempted. For example, storing a setup file with :S is valid. However, attempting to store a setup file with the designator :B or :T is invalid.

An * used with the DELETE softkey performs a mass delete operation. Deleting the file name *:T deletes all trace files from the catalog. Deleting FILENAME *:T deletes all indexed files named by FILENAME. Deleting the file **: * deletes all files from the catalog. Use of **: * as the filename to clear the catalog is only possible through front panel operation.

Although deleted files do not appear in the catalog, deleted files can be restored to memory if the file space has not been used. Deleted files are restored by entering the file name with the DEFINE FILENAME softkey and recalling the file with the appropriate recall softkey. For non-magnitude map displays, recalling a deleted file generates the prompt "FILE DELETED, OK TO RESTORE?". Selection of the YES softkey restores the file. For magnitude map displays, the file is restored when the recall softkey is pressed.

The ABORT softkey aborts the current bubble memory store, recall, or delete operation.

Table 1-5. Bubble Memory Summary

- FILE TYPES: SETUP
TRACE
TIME BUFFER
- TRACE OPERATION - ACTIVE TRACE SAVED/RECALLED
- FILE NAME SYNTAX
FILENAME LESS THAN 10 CHARACTERS
USE OF DUPLICATE FILE NAMES FOR STORE REPLACES EXISTING FILE
RESERVED CHARACTERS
 - . USED FOR AUTO-INDEXING OF MAGNITUDE TRACE FILES
SPACES WITHIN NAMES INVALID
 - * USED AS DELETE OPERATOR
 - : USED WITH S, T, B IN DELETE OPERATIONS
S = SETUP FILE
T = TRACE FILE
B = TIME BUFFER FILE
- AUTO-INDEXING OF MAGNITUDE TRACE FILES
FORM - FILENAME.###
= 0 TO 255
INCREMENTED BY 2 AFTER INITIAL STORE
- CATALOG
DISPLAYED WITH CAT ON OFF SOFTKEY
ALPHABETIC LISTING BY FILE TYPE
 - ▼ SCROLLS CATALOG DOWN
 - ▲ SCROLLS CATALOG UP
 CAPACITY - UP TO 127 FILES

SPECIAL FUNCTIONS

THE NOISE SOURCE

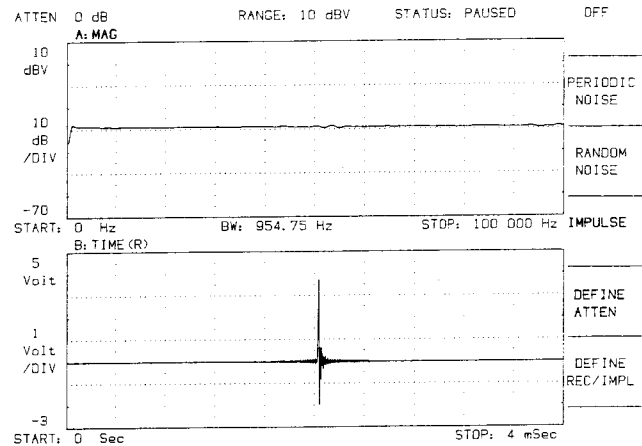
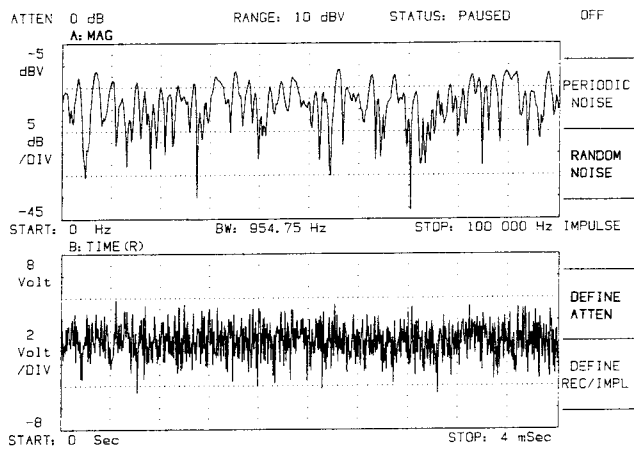

The noise source output is controlled through the front panel SOURCE key. The SOURCE key displays the menu used to select the noise source and set the signal output level of the rear panel SOURCE BNC connector.

An intensified OFF softkey indicates the SOURCE output is disabled.

Selecting the PERIODIC NOISE softkey enables a noise output with a period synchronized to the measurement time span. The periodic noise source places a spectral line at each of the measurement points. Extensive averaging with periodic noise is not necessary because the variance of the periodic signal when it is analyzed is theoretically zero. Time averaging can be used with the periodic noise source.

Selecting the RANDOM NOISE softkey enables a noise output with a period exceeding the measurement time span. The random noise source appears as band limited white noise to the -hp-3561A.

Selecting the IMPULSE softkey generates an impulse output during a time record. The number of time records that elapse per each impulse is entered through the DEFINE REC/IMPL softkey. If manual arming of the trigger circuits is enabled, an impulse is generated when the ARM key is pressed.

The source output attenuation is defined through the DEFINE ATTEN softkey. Attenuation values are entered in 1.5 dB steps. The source can supply a maximum of 0.5 volts rms into a load of 50 ohms. Maximum attenuation is 40.5 dB (30 dB for impulse).

ICP CURRENT SOURCE

The ICP CURR ON OFF softkey enables the Integrated Circuit Piezoelectric (ICP) current source for supplying power to ICP transducers. Selecting ICP CURR ON connects the -hp-3561A internal 4 milliamp current source to the input connector. The nominal voltage output is 24 volts. AC coupling is used with the ICP current source to prevent overloading the -hp-3561A input circuits. The ICP CURRENT indicator illuminates when the ICP current source is enabled.

MANUAL CONTROL OF INPUT CIRCUITS

The -hp-3561A adjusts the input range automatically with the internal auto-ranging circuits. Auto-range is convenient for measuring steady state signals with either small amplitude variations or a slowly changing amplitude. Auto-ranging may be disabled for measurement of transients or signals with unstable amplitudes through the RANGE key menu. The AUTO RNG ON OFF softkey enables or disables auto-ranging. The maximum amplitude value expected is entered through the DEFINE RANGE softkey. Selecting DEFINE RANGE disables auto-ranging. A single auto-range cycle is initiated with the SINGLE AUTO RNG softkey. The AUTO indicator illuminates to indicate that auto-ranging is enabled.

- ⚠ The input connector provides a high impedance input (1 M Ω). Up to 42 volts peak may be applied to the input connector. The chassis ground switch connects the input circuit ground reference to chassis ground or isolates (floats) it from chassis ground.

WARNING

Do not isolate the -hp-3561A from earth ground by interrupting the protective earth conductor inside or outside the -hp-3561A. Interruption of the protective earth conductor can subject the operator to lethal voltages.

The OVER indicator illuminates to indicate that the input signal amplitude exceeds the maximum range value of the input circuits. Overloading the input circuits introduces distortion into the measurement. The HALF indicator illuminates to indicate that the input signal level is greater than one-half the maximum allowable input range value. The optimum input level illuminates the HALF indicator without illuminating the OVER indicator.

The COUPLE AC DC softkey selects AC or DC input coupling. AC coupling inserts a series capacitor into the -hp-3561A input circuits which removes DC signals and drifts from the input signal. The AC COUPLE indicator illuminates to indicate ac coupling is selected.

AUTO-CALIBRATION

The -hp-3561A auto-calibration circuits enable periodic self calibration to maintain performance specifications. The calibration interval is dependent on the length of time power is applied to the -hp-3561A. Immediately after power is applied, calibration occurs at approximately five minute intervals. After 35 minutes of operation, calibration occurs at approximately 30 minute intervals. The AUTO CAL ON OFF softkey enables or disables the automatic calibration of the -hp-3561A circuits. If calibration is disabled, the operator message CALIBRATION DISABLED is displayed when a calibration is necessary. The SINGLE CAL softkey initiates a single calibration cycle on the -hp-3561A.

-hp-3561A OPERATIONAL TEST

The -hp-3561A operational test is performed whenever power is applied to the -hp-3561A. The operational test is initiated manually through the TEST SELECT softkey available in the MODE key menu. Pressing the TEST SELECT softkey displays the softkeys for selecting the -hp-3561A self tests. Specific instrument self tests are specified with the DEFINE TEST NUM softkey. The -hp-3561A operational tests are run by entering 1 for the test number and pressing the START SNGL TST softkey. The START SNGL TST softkey initiates a single self test. The EXIT TST MODE softkey performs an instrument preset and returns the -hp-3561A to the narrow band measurement mode.

Other self tests are available and are designed to assist service technicians in servicing the -hp-3561A. The START CONT TST, STOP TEST, and ERR STOP ON OFF softkeys are used in the performance of the additional self tests. The START CONT TST softkey initiates a continuous test mode. The STOP TEST softkey terminates a test in progress. The ERR STOP ON OFF softkey enables or disables automatic termination of a self test if an error is sensed during the test.

CHAPTER II

OPERATOR'S REFERENCE	59
Chapter Organization	59
Softkeys	59
Measurement Group Keys and Indicators	60
Trig Group Keys and Indicators	72
Numeric Entry Group Keys	74
HP-IB Keys and Indicators	75
Line Key Group	77
Display Group Keys	78
Marker Group Keys	88
Instr State Keys	91
▲ Input Group Keys and Indicators	95
▲ Rear Panel Connectors	97

CHAPTER II

OPERATOR'S REFERENCE

CHAPTER ORGANIZATION

SOFTKEYS

MEASUREMENT GROUP KEYS AND INDICATORS

TRIG GROUP KEYS AND INDICATORS

NUMERIC ENTRY GROUP KEYS

HP-IB KEYS AND INDICATORS

LINE KEY GROUP

DISPLAY GROUP KEYS

MARKER GROUP KEYS

INSTR STATE KEYS

INPUT GROUP KEYS AND INDICATORS

REAR PANEL CONNECTORS

CHAPTER II OPERATOR'S REFERENCE

This chapter contains the description of the keys, connectors, and indicators on the -hp-3561A. Manual operation of the -hp-3561A is through the use of the front panel keys defined by labels on or near the keys, and unmarked menu-defined keys (softkeys) to the right of the display. Menus defining the function of the softkeys are selected by pressing the labeled keys. Menus appear along the right edge of the display. The use of softkeys simplifies the front panel while expanding the functions of the -hp-3561A.

CHAPTER ORGANIZATION

This chapter is subdivided into sections describing each major group of keys, connectors, and indicators. The major groups are softkeys, MEASUREMENT, TRIG, numeric entry, GPIB, DISPLAY, MARKER, INSTR STATE, INPUT, and rear panel. Descriptions of the softkeys follow the description of the labeled key that defines the softkey menu. Softkey descriptions printed in *italics* represent secondary menus. Appendix A, "Quick Reference", contains photographs for the front and rear panels, a description of the display annotation areas, and a key map illustrating the available softkey menus.

SOFTKEYS

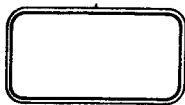
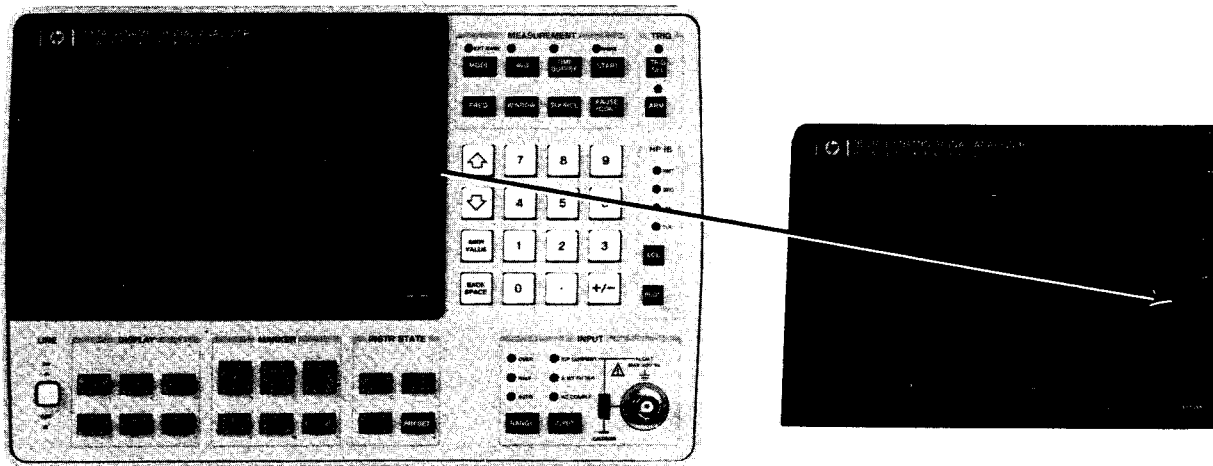

The softkey menus are defined and displayed when the labeled keys are pressed. Descriptions of specific softkeys follow the description of the labeled key that defines the softkey menu. Softkey

descriptions printed in *italics* represent secondary menus displayed by pressing a softkey with SELECT in its label. An illustration of the complete set of menus is available in Appendix A, "Quick Reference."

RETURN

The RETURN key displays the nonunits menu selected prior to the currently displayed menu.

This key acts as a cancel softkey for a suffix menu and can also return to a primary menu from a secondary menu.

MEASUREMENT GROUP KEYS AND INDICATORS

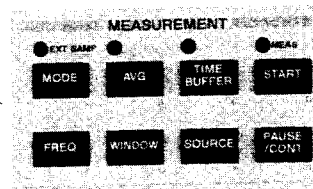
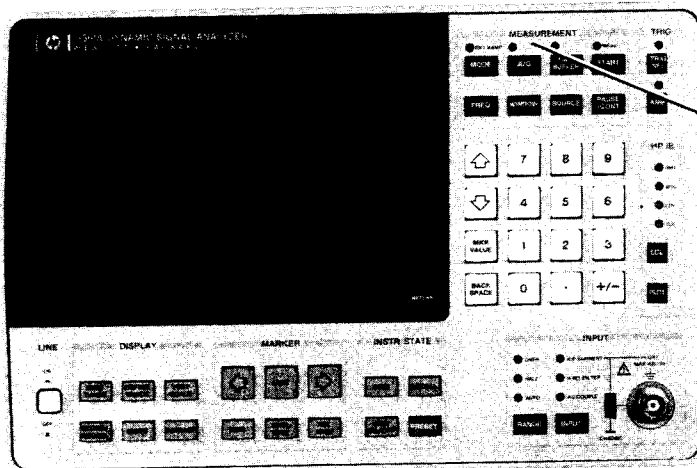

EXT SAMP

The EXT SAMP (external sample) indicator illuminates to indicate that the external sample mode is selected. The external sample mode is selected with the MODE key EXT SAMP ON OFF softkey.

MEAS

The MEAS (measurement) indicator illuminates to indicate that a measurement is in progress.

MODE

The MODE key defines and displays the menu for selecting the -hp-3561A measurement modes. Changing measurement modes erases the displayed trace. A new trace is not presented until data is acquired for the new measurement mode.

NARROW BAND

The NARROW BAND softkey selects the narrow band analysis measurement mode. The frequency resolution of the narrow band mode is the frequency span divided by 400. For the full 100 kilohertz frequency span the resolution is 250 Hertz. Table 2-1 lists the frequency spans and display resolution of the -hp-3561A.

THIRD OCTAVE

The THIRD OCTAVE softkey selects the third octave band measurement mode. Third octave analysis is the measurement of a frequency spectrum by the use of constant percentage bandwidth filters $\frac{1}{3}$ octave wide and spaced at $\frac{1}{3}$ octave intervals. The center frequency of each $\frac{1}{3}$ octave fre-

Table 2-1. Frequency Spans, Resolution Time Record Lengths, and Display

Frequency Span (Hertz)	Time Record Length (Seconds)	Display Resolution (Hertz)
100K	0.004	250
50K	0.008	125
25K	0.016	62.5
20K	0.020	50
12.5K	0.032	31.25
10K	0.040	25
6.25K	0.064	15.625
5K	0.080	12.5
4K	0.100	10
3.125K	0.128	7.8125
2.5K	0.160	6.25
2K	0.200	5
1.25K	0.320	3.125
1K	0.400	2.5
800	0.500	2
625	0.640	1.5625
500	0.8	1.25
400	1.0	1
250	1.6	0.625
200	2.0	0.5
160	2.5	0.4
125	3.2	0.3125
100	4.0	0.25
80	5.0	0.2
50	8.0	0.125
40	10.0	0.1
32	12.5	0.08
25	16.0	0.0625
20	20.0	0.05
16	25.0	0.04
10	40.0	0.025
8	50.0	0.02
6.4	62.5	0.016
5	80.0	0.0125
4	100.0	0.01
3.2	125.0	0.008
*2.5	160.0	0.00625
2	200.0	0.005
1.6	250	0.004
1.28	312.5	0.0032
*1	400	0.0025
0.8	500	0.0020
0.64	625	0.0016
*0.4	1000	0.001
0.32	1250	0.0008
0.256	1562.5	0.00064
*0.128	3125	0.00032
*0.064	6250	0.00016
*0.0512	7812.5	0.000128
*0.0256	15625	0.000064
*0.01024	39062.5	0.0000256

* zero start only

quency band is located at a frequency of $2^{1/3}$ times the preceding $1/3$ octave band. Thirty-three frequency bands and a total rms power band are displayed in the one-third octave band mode. The display stop band or frequency is entered through the FREQ key menu. Table 2-2 lists the frequency spans and bands displayed on the -hp-3561A. The third octave measurement data is computed from narrow band measurement data. The third octave mode applies the Hanning window to measurement data. Selection of other window shapes affects only INPUT MAG data.

FULL OCTAVE The FULL OCTAVE softkey selects the full octave band measurement mode. Full octave analysis is similar to third octave analysis except that the measurement is on an octave band basis. Eleven frequency bands and a total rms power band are displayed in the full octave band mode. The display stop band or fre-

quency is entered through the FREQ key menu. Table 2-3 lists the frequency spans and bands displayed on the -hp-3561A. The full octave measurement data is computed from narrow band measurement data. The full octave mode applies the Hanning window to measurement data. Selection of other window shapes affects only INPUT MAG data.

TIME CAPTURE The TIME CAPTURE softkey configures the -hp-3561A to accumulate up to 40 consecutive time records in the time buffer. Parameters for the time capture mode are specified through the TIME BUFFER key menu. Data acquired in the time capture mode is processed for display without altering the data acquired in the time buffer. With the bubble memory option, time records are stored in nonvolatile memory with the TIME BUFFER key BUFFER-FLE SELECT softkey.

Table 2-2 Third Octave Mode Display Spans and Data Collection Times

Display Span	Data Collection Time (Seconds)	Band Numbers
50 Hz to 80 kHz	0.4	17 to 49
25 Hz to 40 kHz	0.8	14 to 46
12.5 Hz to 20 kHz	1.6	11 to 43
6.3 Hz to 10 kHz	3.2	8 to 40
3.15 Hz to 5 kHz	6.4	5 to 37
1.6 Hz to 2.5 kHz	12.8	2 to 34
0.8 Hz to 1.25 kHz	25.6	-1 to 31

Display Span	Data Collection Time (Seconds)	Band Numbers
63 Hz to 63 kHz	0.4	18 to 48
31.5 Hz to 31.5 kHz	0.8	15 to 45
16 Hz to 16 kHz	1.6	12 to 42
8 Hz to 8 kHz	3.2	9 to 39
4 Hz to 4 kHz	6.4	6 to 36
2 Hz to 2 kHz	12.8	3 to 33
1 Hz to 1 kHz	25.6	0 to 30

EXT SAMP ON OFF The EXT SAMP ON OFF (external sample on off) softkey enables and disables control of the sampling frequency through the rear panel EXT SAMPLE connector. The horizontal units of the display graticule are restricted to orders in the EXT SAMPLE mode to indicate that external sample is selected. External sampling is not available in the third octave or full octave modes.

DEFINE PULS/REV The number of pulses per revolution is entered with the DEFINE PULS/REV (define pulses per revolution) softkey.

TEST SELECT The TEST SELECT softkey defines and displays a menu for selecting the -hp-3561A self tests.

DEFINE TEST NUM *Specific instrument self tests are specified with the DEFINE TEST NUM (define test number) softkey. The -hp-3561A operational tests are run by entering 1 for the test number and pressing the START SNGL TST softkey. The remaining self tests are designed to assist service technicians in servicing the -hp-3561A.*

START SNGL TST *The START SNGL TST (start single test) softkey initiates a single self test. The test performed is specified with the DEFINE TEST NUM softkey.*

START CONT TST *The START CONT TST (start continuous test) softkey initiates a continuous test mode. The test performed is specified with the DEFINE TEST NUM softkey.*

STOP TEST *The STOP TEST softkey terminates a test in progress.*

ERR STOP ON OFF *The ERR STOP ON OFF (error stop on off) softkey enables or disables automatic termination of a self test if an error is sensed during the test.*

EXIT TST MODE *The EXIT TST MODE (exit test mode) softkey performs a preset and returns the -hp-3561A to the narrow band measurement mode.*

CONTINUE *The CONTINUE softkey instructs the -hp-3561A to continue a test after it has paused. If a test is not to be continued, the STOP TEST softkey discontinues the test.*

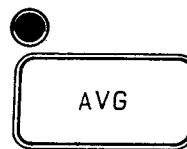

The AVG (average) key defines and displays the menu for selecting the averaging process applied to the measurement data. Two menus are available for the AVG key. The menu displayed is dependent upon the mode selected. The AVG indicator illuminates to indicate averaging is enabled.

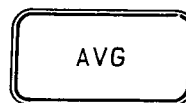

(Narrow Band Mode Selected)

OFF The OFF softkey disables the averaging functions. An intensified OFF indicates that averaging functions are disabled.

RMS The RMS (root mean square) softkey enables the rms averaging mode. RMS averaging combines a new spectrum with a partial result on a point-by-point basis using a root mean square calculation. At any frequency in the cycle, the amplitude A(f) is defined as

$$A(f) = \frac{1}{n} \sqrt{A_1^2(f) + A_2^2(f) + \dots + A_n^2(f)}$$

where n is the number of averages used. RMS averaging results in smoothing of noise variations but does not reduce the level of the noise. The number of averages used in the calculation is entered with the DEFINE NUM AVGS softkey. The phase trace displayed during the averaging process is the phase of the current measurement. The phase trace displayed when the averaging process is complete is the phase of the last measurement used in computing the average.

RMS EXP WGHT The RMS EXP WGHT (root mean square exponential weighting) enables the rms exponential weighting averaging

mode. This averaging mode is a continuous averaging process that assigns more significance to recent data while older data dies out in importance at a decaying exponential rate. The number of averages entered with the DEFINE NUM AVGS softkey determines the weighting value. RMS EXP WGHT is most useful when the process being measured exhibits relatively slow time variations and yet some averaging is still desired.

$$A_n(f) = \sqrt{A_{n-1}^2(f) \left(1 - \frac{1}{k}\right) + A_{\text{new}}^2(f) \left(\frac{1}{k}\right)}$$

where $A_{n-1}(f)$ is the previous average value, and $A_{\text{new}}(f)$ is the new value. The value of k is 1 for the initial average. For subsequent averages, k is equal to the rounded value of the base 2 logarithm of the number of averages. For example, if the number of averages is 16, then k is 4.

PEAK HOLD The PEAK HOLD mode is not a true averaging mode, but rather is the result of keeping the maximum amplitude value at each frequency point. The number of data samples is dependent upon the selection of the FINITE or CONT softkey available through the AVG key SETUP SELECT softkey. The CONT softkey enables a continuous update of the data samples. The FINITE softkey limits the number of data samples to the value entered with the DEFINE NUM AVGS softkey. The phase trace displayed during the

averaging process is the phase of the current measurement. The phase trace displayed when the averaging process is complete is the phase of the last measurement used in computing the average.

TIME The TIME average mode involves time domain averaging. When a synchronizing trigger is available, successive

time records are averaged point-by-point. Nonsynchronous noise averages toward zero with time averaging. At any frequency in the cycle, the amplitude A(f) is defined as

$$A(f) = \frac{1}{n} \sqrt{\left[\sum_{i=1}^n R_i(f) \right]^2 + \left[\sum_{i=1}^n I_i(f) \right]^2}$$

where n is the number of averages used, $R_i(f)$ is the real part of the complex value frequency data, and $I_i(f)$ is the imaginary part of the complex value frequency data. Time averaging is unique in that it results in an enhancement of the signal-to-noise ratio. The phase trace displayed in TIME averaging is the average phase value. The -hp-3561A displays the message USE TRIGGER FOR TIME AVERAGING if TIME averaging is selected without selecting a TRIGGER mode.

DEFINE NUM AVGS Values for the number of averages used in the averaging modes are entered with the DEFINE NUM AVGS softkey. Values entered with the numeric keypad are terminated with the ENTER or CANCEL softkeys. Values entered are integers in the range of 1 to 16,383.

SETUP SELECT The SETUP SELECT softkey defines and displays an additional menu for the AVG mode key.

DEFINE AVG OVL *The DEFINE AVG OVL (define average overlap) softkey defines the percent of time record overlap used during averaging. The overlap value is the maximum overlap allowed in averaging. Values entered with the numeric keypad are terminated with a % or CANCEL softkey. Values range from 0 to 99.9 in .1% increments.*

OVLD REJ ON OFF *Measurements with data that overload the -hp-3561A processing circuits are excluded from the accumulated average when the OVLD REJ ON OFF (overload reject on off) softkey is ON.*

NORMAL DISPLAY *The NORMAL DISPLAY softkey is available in the rms, time, and finite peak hold averaging modes. The NORMAL DISPLAY function updates the display for each time record collected, and when the computed average is complete. After the computed average is displayed, a new measurement is initiated with the START key.*

FAST DISPLAY *The FAST DISPLAY softkey is available in the rms, time, and finite peak hold averaging modes. The FAST DISPLAY function inhibits the display of intermediate average results and only the final computed average is displayed. Averaging is initiated with the START key.*

REPEAT DISPLAY *The REPEAT DISPLAY softkey is available in the rms, time, and finite peak hold averaging modes. The REPEAT DISPLAY function inhibits the display of intermediate average results and only the final computed average is displayed. REPEAT DISPLAY initiates averaging automatically without the interaction of the START key.*

FINITE *The FINITE softkey is available in the PEAK HOLD mode. Selecting FINITE limits the number of PEAK HOLD data samples to the value entered with the DEFINE NUM AVGS softkey.*

CONT *The CONT (continuous) softkey is available in the PEAK HOLD mode. Selecting CONT enables a continuous update of the PEAK HOLD data.*

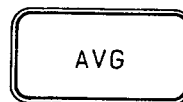

(Third or Full Octave Mode Selected)

OFF The OFF softkey disables the averaging functions. An intensified OFF indicates averaging functions are disabled.

OCTAVE RMS The OCTAVE RMS average mode combines a new spectrum with a partial result on a full octave or one third octave band basis using a root mean square calculation. The number of averages used in the calculation is entered with the DEFINE NUM AVGS softkey.

OCTAVE EXP WGHT The OCTAVE EXP WGHT (octave exponential weighting) averaging mode is a continuous averaging process that assigns more significance to recent data while older data dies out in importance at a decaying exponential rate. The number of averages entered with the DEFINE NUM AVGS softkey determines the weighting value. OCTAVE EXP WGHT is most useful when the process under consideration exhibits relatively slow time variations and yet some averaging is still desired.

OCTAVE PK HOLD The OCTAVE PK HOLD (octave peak hold) mode is not a true averaging mode, but rather is the result of keeping the maximum value at each band. Selection of OCTAVE PK HOLD limits the number of data samples to the value entered with the DEFINE NUM AVGS softkey.

OCTAVE PK CONT The OCTAVE PK CONT (octave peak continuous) mode is not a true averaging mode, but rather is the result of keeping the maximum value at each band. Selection of OCTAVE PK CONT enables a continuous update of the data samples.

DEFINE NUM AVGS Values for the number of averages used in the averaging modes are entered with the **DEFINE NUM AVGS** (define number of averages) softkey. Values entered with the numeric keypad are terminated with an **ENTER** or **CANCEL** softkey. Values entered are integers in the range of 1 to 16,384.

SETUP SELECT The **SETUP SELECT** softkey defines and displays an additional menu for the **AVG** mode key.

DEFINE AVG OVLP *The **DEFINE AVG OVLP** (define average overlap) softkey defines the percent of time record overlap used during averaging. The overlap value is the maximum overlap allowed in averaging. Values entered with the numeric keypad are terminated with a % or **CANCEL** softkey. Values range from 0 to 99.9 in .1% increments.*

OVL D REJ ON OFF *Measurements with overloads are excluded from the accumulated average when the **OVL D REJ ON OFF** (overload reject on off) softkey is **ON**.*

NORMAL DISPLAY *The **NORMAL DISPLAY** softkey is available in the **OCTAVE RMS** and **OCTAVE PK HOLD** averaging modes. The **NORMAL DISPLAY** function updates the display for each time record collected, and when the computed average is complete. After the computed average is complete, a new measurement is initiated with the **START** key.*

FAST DISPLAY *The **FAST DISPLAY** softkey is available in the **OCTAVE RMS** and **OCTAVE PK HOLD** averaging modes. The **FAST DISPLAY** function inhibits intermediate average results from being displayed, and only the final computed average is displayed. Averaging is initiated with the **START** key.*

REPEAT DISPLAY *The **REPEAT DISPLAY** softkey is available in the **OCTAVE RMS** and **OCTAVE PK HOLD** averaging modes. The **REPEAT DISPLAY** function inhibits the display of intermediate average results, and only the final computed average is displayed. **REPEAT DISPLAY** initiates averaging automatically without the interaction of the **START** key.*

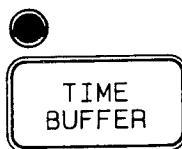

The **TIME BUFFER** key defines and displays the menu for entering time capture mode parameters. The **TIME BUFFER** indicator illuminates to indicate that the time capture mode is selected. The time capture mode is selected with the **MODE** key **TIME CAPTURE** softkey or the **TIME BUFFER** key **START CAPTURE** softkey.

START CAPTURE The **START CAPTURE** softkey enables the time capture measurement sequence. Time capture data acquisition starts after **START CAPTURE** is selected and the trigger conditions are satisfied. Pressing the **START CAPTURE** softkey will also enable the time capture mode.

DEFINE # OF REC The number of time records accumulated in the time buffer is entered with the **DEFINE # OF REC** (define number of records) softkey. Values entered with the numeric keypad are terminated with a **RECORDS** or **CANCEL** softkey. Values entered are integers in the range of 1 to 40.

DEFINE START t Processing of acquired time records starts with the time record specified in terms of time units with the **DEFINE START t** (define start time) softkey. The start of the time buffer is at 0 seconds if a trigger delay is not used. If a trigger delay is used, 0 seconds represents the trigger point. Values entered with the numeric keypad are terminated with a **units** or **CANCEL** softkey. The **MKR VALUE** key can be used to define entry values.

DEFINE % INCR The percent of new data added to a time record used in processing acquired time buffer data is specified with the **DEFINE % INCR** (define percent increment) softkey. Values entered with the numeric keypad are terminated with a % or **CANCEL** softkey. The percent increment range values are 0.1 to 100 in 0.1 % steps. Changing the percent increment does not alter data acquired in the time buffer.

DEFINE ZOOM X The **DEFINE ZOOM X** (define zoom factor) softkey is used for processing data acquired in the time buffer. The number entered with the **DEFINE ZOOM X** reduces the measurement frequency span. Valid zoom values are 1, 2, 4, 5, 8, 10, 16, 20, 25, 32, and 40. If data is acquired with a nonzero start frequency, only a zoom value of 1 can be entered. Changing the zoom factor does not alter data acquired in the time buffer.

DEFINE ZOOM FRQ The center frequency used in displaying the time buffer data is entered with the **DEFINE ZOOM FRQ** (define zoom frequency) softkey. A trace is not displayed if the frequency value entered for the center frequency is not within the frequency range of the data captured in the time buffer. Changing the zoom frequency does not alter data acquired in the time buffer.

BUFFERFLE SELECT The **BUFFERFLE SELECT** (buffer file select) softkey is available when the bubble memory option is installed. The **BUFFERFLE SELECT** softkey displays an additional **TIME BUFFER** key menu for storing or recalling time buffer contents to or from bubble memory.

DEFINE FILENAME The name of the buffer data file saved to bubble memory or recalled from bubble memory is entered with the **DEFINE FILENAME** softkey (see Table 2-4). File name entry is terminated with the **CANCEL** or **ENTER** softkey.

USE CAT FILENAME The **USE CAT FILENAME** (use catalog file name) softkey uses the catalog name at the top of the catalog for the file name used in store, recall, or delete operations. The catalog is displayed with the **CATALOG ON OFF** softkey. The up and down arrow keys scroll the catalog after it is displayed.

STORE BUFFER The **STORE BUFFER** softkey stores time buffer data in a bubble memory data file under the name entered with the **DEFINE FILENAME** or **USE CAT FILENAME** softkey.

RECALL BUFFER The **RECALL BUFFER** softkey recalls time buffer data from bubble memory to the time buffer. When the bubble memory file catalog is displayed, time buffer data is indicated by **BUFFERED** in the catalog name. The name of the data file recalled is entered with the **DEFINE FILENAME** or **USE CAT FILENAME** softkey.

DELETE The **DELETE** softkey deletes the bubble memory data file under the name entered with the **DEFINE FILENAME** or **USE CAT FILENAME** softkey.

ABORT The **ABORT** softkey aborts an in-progress bubble memory store, recall, or delete operation.

CATALOG ON OFF The **CATALOG ON OFF** softkey enables or disables display of the bubble memory catalog.

Table 2-4. The Alphanumeric Entry

Selecting a DEFINE TRACELBL, DEFINE EU LBL, or DEFINE FILENAME softkey places the -hp-3561A into an alphanumeric entry mode. In the alphanumeric entry mode, the blue characters near the front panel keys are assigned to the keys. Character entry is terminated with the CANCEL or ENTER softkey and the labeled keys revert to their normal functions.

While in the alphanumeric mode the -hp-3561A displays the following menu for editing the label or file name:

ENTER	The ENTER softkey accepts the label or name entry and assigns the entry to the trace label or file name.
CLEAR ENTRY	The CLEAR ENTRY softkey clears the entry area of the display.
EDIT - >	The EDIT - > softkey moves the entry cursor right.
EDIT < -	The EDIT < - softkey moves the entry cursor left.
INSERT SPACE	The INSERT SPACE softkey inserts a space at the cursor position.
DELETE CHAR	The DELETE CHAR (delete character) softkey deletes the character at the cursor position.
CANCEL	The CANCEL softkey terminates the alphanumeric entry mode without accepting the label or name entry.

Note

In the alphanumeric entry mode, only the ENTER and CANCEL softkeys will restore the -hp-3561A to normal operation because alphanumeric characters are assigned to the labeled keys.



The START key clears the time record and accumulated average total and initiates a measurement. The START key does not define a menu. The START key does not destroy data acquired in the time capture mode or data acquired in a map.



The FREQ (frequency) key defines and displays the menus for selecting the measurement frequency span. Two menus are available for the FREQ key. The menu displayed is dependent upon the MODE selected.



(Narrow Band or Time Capture Mode Selected)

0-100kHz

The 0-100kHz softkey sets the measurement frequency span and display span to the maximum span starting at 0 Hertz.

**DEFINE
START**

The display start frequency is entered with the DEFINE START softkey. The start frequency is represented by the left edge of the graticule. If a start frequency is defined, the start frequency is indicated at the left bottom of the graticule. Start frequencies are entered either with the numeric keypad or with the MKR VALUE, and up and down arrow keys. Values entered with the keypad are terminated with a units or CANCEL softkey. If the BAND special markers are enabled, the MKR VALUE key will transfer the frequency of the left band marker to the display start frequency rather than the marker frequency value.

Note

When the display start frequency is defined with the DEFINE START softkey, the display center frequency is set to correspond to the start frequency and span selected.

**DEFINE
CENTER**

The display center frequency is entered with the DEFINE CENTER softkey. The center frequency is represented by the center vertical line of the display graticule. If the center frequency is defined, the center frequency is indicated at the left bottom of the graticule. Center frequencies are entered either with the numeric keypad or with the MKR VALUE keys. The up and down arrow keys increment or decrement the center frequency value in discrete steps when the DEFINE CENTER softkey is intensified. Values entered with the keypad are terminated with a units or cancel softkey. If the BAND special markers are enabled, the MKR VALUE key will transfer the center frequency of band marked by the special markers to the display center frequency rather than the marker frequency value.

Note

When the display center frequency is defined with the DEFINE CENTER softkey, the display start frequency is set to correspond to the center frequency and span selected.

**DEFINE
SPAN**

The display frequency span is entered with the DEFINE SPAN softkey. The frequency span, represented by the horizontal axis of the display graticule, is the frequency range of the display. Frequency spans are entered either with the numeric keypad or with the MKR VALUE keys. The up and down arrow keys step increment or decrement the frequency span value in discrete steps when the DEFINE SPAN softkey is intensified. Values entered with the keypad are terminated with a units softkey. If the BAND special markers are enabled, the MKR VALUE key will transfer the span of the band marked by the special markers to the display span rather than the span marked by the marker. Table 2-1 lists the available frequency spans.

DEFINE TIME LEN The display frequency span is entered with the **DEFINE TIME LEN** (define time length) softkey in terms of time units. Values entered with the keypad are terminated with a units softkey. Table 2-1 lists the available frequency spans and corresponding time record lengths.

FRQ AXIS LIN LOG The **FRQ AXIS LIN LOG** (frequency axis linear logarithmic) softkey selects linear or logarithmic scaling of the horizontal frequency axis of the display graticule.

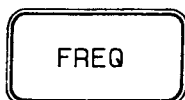

(One Third Octave or Full Octave Mode Selected)

MAX STOP The **MAX STOP** (maximum stop) softkey displays the 33 1/3 octave bands ending with band 49 (the maximum stop band) in the 1/3 octave mode. The **MAX STOP** softkey displays the 11 full octave bands ending with band 48 in the full octave mode.

DEFINE STOP FRQ The display stop band frequency is entered with the **DEFINE STOP FRQ** (define stop frequency) softkey. Stop band frequencies are entered either with the numeric keypad or with the **MKR VALUE** keys. When the **DEFINE STOP FRQ** softkey is intensified, the up and down arrow keys step the stop band frequency to the next stop band frequency. Values entered with the keypad are terminated with a units softkey. The display stop frequencies are 1.25, 2.5, 5, 10, 20, 40, and 80 kilohertz in the 1/3 octave mode. The display stop frequencies are 1, 2, 4, 8, 16, 31.5, and 63 kilohertz in the full octave mode. Values other than these are rounded up to the next stop frequency.

DEFINE STOP BND The display stop band is entered with the **DEFINE STOP BND** (define stop band) softkey. Stop bands are entered either with the numeric keypad or with the **MKR VALUE** keys. When the **DEFINE STOP BND** softkey is intensified, the

up and down arrow keys step the stop band to the next stop band. Values entered with the keypad are terminated with a **BAND** or **CANCEL** softkey. The 1/3 octave stop bands are 31, 34, 37, 40, 43, 46, and 49. The full octave stop bands are 30, 33, 36, 39, 42, 45 and 48. Bands other than these are rounded up to the next stop band.



The **WINDOW** key defines and displays the menu for selecting the filter shape (window) used in processing the data. The third octave mode applies the Hanning window to measurement data.

FLAT TOP (HI ACC) The **FLAT TOP (HI ACC)** (flat top high accuracy) softkey selects a filter shape optimized for maximum amplitude accuracy. The high shape factor and broad response of the filter make this filter most useful for measurement of discrete frequencies and low level signals close to high level signals. The 3 dB bandwidth of the flat top window is about 0.9% of the measurement span.

HANNING The **HANNING** softkey selects a filter shape used by most most real time spectrum analyzers. The Hanning filter offers better frequency resolution than the flat top window but reduces amplitude accuracy. The worst case amplitude uncertainty is about 1.5 dB below the flat top window. The 3 dB bandwidth of the flat top window is about 0.37% of the measurement span.

UNIFORM The **UNIFORM** softkey selects a filter with a very narrow bandwidth. The uniform filter offers equal weighting of the time record for measuring transients occurring entirely within the time record or response measurements with the internal periodic noise source. The worst case amplitude uncertainty is about 4.0 dB below the flat top window. The 3 dB bandwidth of the uniform window is about 0.22% of the measurement span.

EXPONTL The EXPONTL (exponential) window is useful in analyzing transients that have not reached zero amplitude by the end of the time record. The time constant for the exponential bandshape is entered with the DEFINE EXP TC softkey.

DEFINE EXP TC The time constant used for the exponential window is entered with the DEFINE EXP TC (define exponential time constant) softkey. The value for the time constant is entered in terms of number of data samples. The time constant range limits are from 3 data samples to 1024 data samples. The default value for the time constant is 256 data samples.

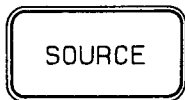

The SOURCE key defines and displays the menus for setting the signal output of the rear panel SOURCE OUT BNC connector.

OFF The OFF softkey disables the source output. An intensified OFF indicates the SOURCE output is disabled.

PERIODIC NOISE The PERIODIC NOISE softkey enables a noise output with a period synchronized to the measurement time span. The noise source places a spectral line at each of the measurement points. Extensive averaging with periodic noise is not necessary because the variance of the periodic signal when it is analyzed is theoretically zero. Time averaging can be performed to reduce the noise level.

Note

The -hp-3561A may display spectra near 0 Hertz unrelated to the input signal if a display center frequency is set to less than 1/2 of the measurement span (i.e. the 0 Hertz display position is located within the graticule). The spectra is a result of local oscillator noise being translated to above 0 Hertz and adding to the desired spectral data. To avoid this problem, use a start frequency of 0 Hertz.

RANDOM NOISE The RANDOM NOISE softkey enables a random noise output.

IMPULSE The IMPULSE softkey generates an impulse output during a time record. The number of time records that elapse per each impulse is entered with the DEFINE REC/IMPLS softkey. If auto-arming of the trigger circuits is enabled, the impulses are generated continuously. If manual arming of the trigger circuits is enabled, an impulse is generated when the ARM key is pressed.

DEFINE ATTEN The attenuation level of the source output is defined with the DEFINE ATTEN (define attenuation) softkey. Values are entered in 1.5 dB steps. The source can supply a maximum of 0.5 volts rms into a load of 50 ohms. Maximum attenuation is 40.5 dB (30 dB for impulse).

DEFINE REC/IMPL The number of time records that elapse per each impulse is entered with the DEFINE REC/IMPL (define records per impulse) softkey. Up to 32,767 time records can be skipped between impulses. A source sync signal is available through the rear panel SOURCE SYNC connector to mark the beginning of each time record.

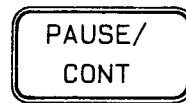

The PAUSE/CONT (pause/continue) key suspends the measurement in progress. The measurement is continued when this key is pressed again. The PAUSE/CONT key does not display a menu. When averaging is enabled, additional averages can be included in the measurement by increasing the number of averages requested and pressing the PAUSE/CONT key.

TRIG GROUP KEYS AND INDICATORS

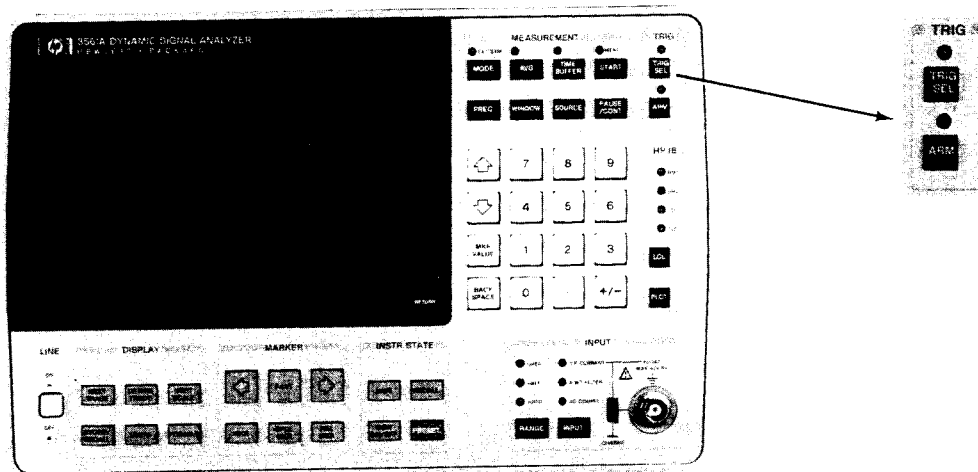

The TRIG SEL (trigger select) key defines and displays the menu for selecting the trigger modes. The TRIG SEL indicator illuminates when a trigger signal is sensed.

During a measurement initiated by a trigger, the indicator remains illuminated. The trigger functions of the -hp-3561A operate only in the narrow band and time capture modes.

FREE RUN TRIGGER

The FREE RUN TRIGGER softkey selects either the free run or trigger mode of operation. In the free run mode, a new block of data is collected after the previous measurement is completed. In the trigger mode, a new block of data is collected only when the conditions defined by other TRIG SEL softkeys are satisfied.

MAN ARM AUTO ARM

The MAN ARM AUTO ARM (manual arm automatic arm) softkey selects either manual arming or automatic arming of the trigger circuits. With manual arm selected, a single block of data is collected when trigger conditions are satisfied. Additional data is not acquired until the ARM key is pressed to reset the trigger. With automatic arm selected, the trigger is automatically reset after each block of data is collected.

INPUT TRIGGER

The INPUT TRIGGER softkey configures the -hp-3561A to use the signal applied to the front panel input for the trigger signal.

EXTERNAL TRIGGER

The EXTERNAL TRIGGER softkey configures the -hp-3561A to trigger from the signal applied to the rear panel EXT TRIG input. The trigger level is preset to TTL levels when EXTERNAL TRIGGER is selected.

SOURCE TRIGGER

The SOURCE TRIGGER softkey configures the -hp-3561A to trigger from the internal noise source or impulse generator. Trigger slope and level do not apply when SOURCE TRIGGER is selected. For an impulse trigger, a trigger delay of zero positions the impulse in the center of the time record. Entering a nonzero trigger delay moves the position of the impulse within the time record.

INTERNAL TRIGGER The INTERNAL TRIGGER softkey configures the -hp-3561A to trigger immediately after arming. In the auto arm mode, selecting internal trigger is the same as selecting the free run mode.

SETUP SELECT The SETUP SELECT softkey defines and displays menu entries for entering trigger signal parameters.

SLOPE POS NEG The SLOPE POS NEG (slope positive negative) softkey selects triggering either on a positive or negative transition of the trigger source.

DEFINE % OF RNG The amplitude trigger point of the input signal is defined with the DEFINE % OF RNG (define percent of range) softkey. The amplitude of the input signal is specified in terms of percent of input range. Allowable values for percent of range are in the range of ± 140 in steps of 5. Trigger levels are entered with the numeric keypad and terminated with the % or CANCEL softkey. DEFINE % OF RNG applies only to an input trigger source.

DELAY ON OFF Delayed triggering is enabled or disabled with the DELAY ON OFF softkey.

DEFINE + - DELAY Data collection is initiated prior to, or after a valid trigger with the DEFINE + - DELAY softkey. Time delay values entered with the numeric keypad are terminated with a units or CANCEL softkey. Positive delay values indicate that data collection starts after the trigger. The minimum time delay available corresponds to the time required to obtain 1/1024 of a time record with a zero Hertz start frequency or 1/512 with a nonzero start frequency. The maximum time delay corresponds to 8 time records prior to the trigger or $2^{20} - 1$ time records after the trigger in the narrowband mode. In the time capture mode the maximum time delay corresponds to 40 time records prior to the trigger or $2^{20} - 40$ time records after the trigger. Selecting an incompatible frequency span after entry of a time delay changes the time delay value to a value consistent with the frequency span and prints an operator prompt on the display.

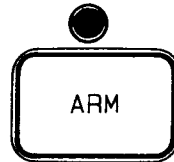

The ARM key resets the internal trigger circuits when the manual arm trigger mode is selected. If the impulse source is selected, and in manual arm, pressing the ARM key will generate an impulse output. The ARM key does not display a menu. The ARM indicator illuminates for two reasons. The indicator illuminates when the instrument trigger circuits are reset and waiting for a trigger to initiate a measurement. The indicator also illuminates when the trigger circuits will automatically reset at the end of a measurement.

NUMERIC ENTRY GROUP KEYS

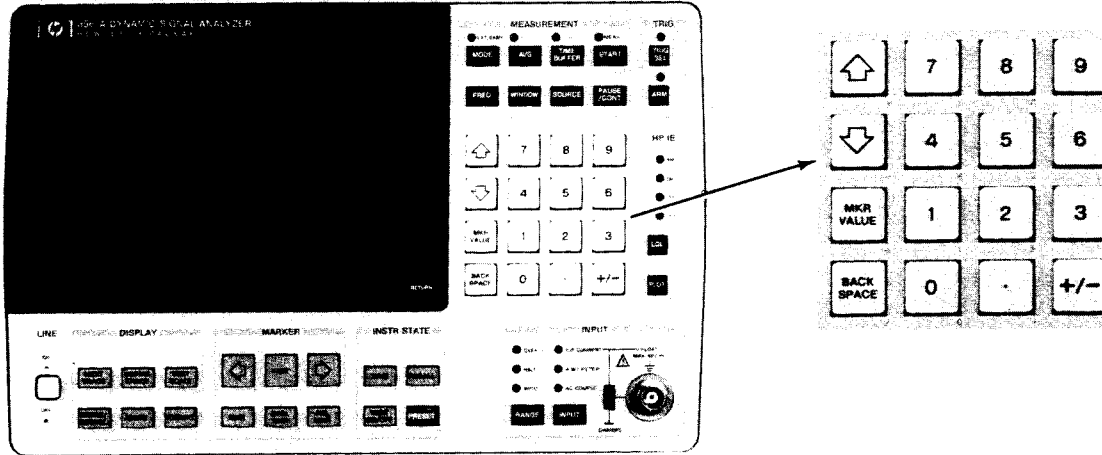

The up arrow key increments the numeric values displayed in response to selecting a softkey starting with the word DEFINE.

When the bubble memory catalog is displayed, the up arrow key scrolls the catalog.



The Down arrow key decrements the numeric values displayed in response to selecting a softkey starting with the word DEFINE.

When the bubble memory catalog is displayed, the down arrow key scrolls the catalog.



The MKR VALUE (marker value) key transfers the marker position value to the entry value expected by DEFINE softkeys. An operator

prompt is displayed if this key is pressed for a softkey that does not accept entries through the MKR VALUE Key. The softkeys that accept MKR VALUE entries are:

DEFINE START
 DEFINE CENTER
 DEFINE SPAN
 DEFINE RANGE
 DEFINE Hz/ORD

DEFINE ZOOM FRQ
 DEFINE MAG REF
 DEFINE PHAS REF
 DEFINE FUND FRQ
 DEFINE + - DELAY
 DEFINE TIME LEN
 DEFINE START t
 DEFINE TIME REF
 DEFINE FULL SCL
 DEFINE CARR FRQ
 DEFINE SB FRQ
 DEFINE STOP FRQ
 DEFINE RGHT FRQ
 DEFINE LEFT FRQ
 DEFINE FREQ REF



The BACK SPACE key back spaces and deletes the last character or units key entered.

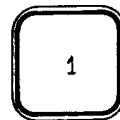

The numeric keypad enters the numeric values for the softkeys requiring a numeric definition. Softkeys that require numeric definition have the word DEFINE in the softkey label.

HP-IB KEYS AND INDICATORS

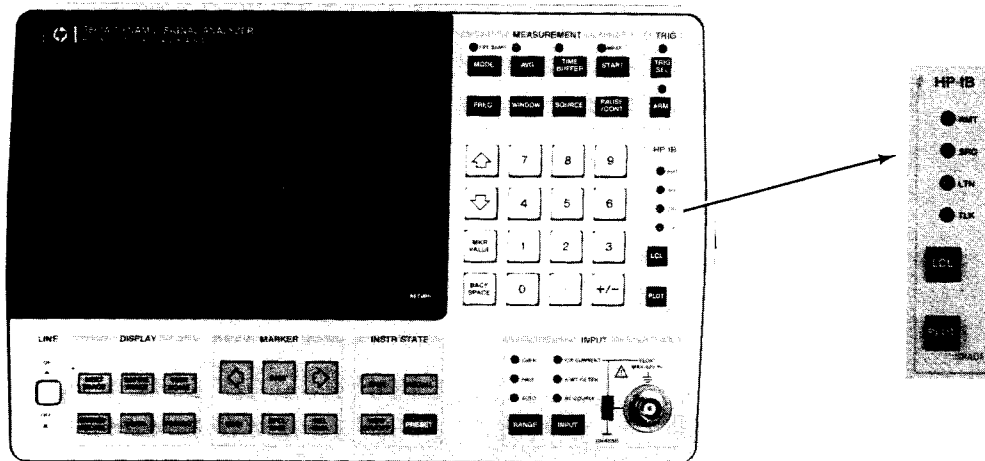

RMT

The RMT (remote) indicator illuminates to indicate that the -hp-3561A is operating under HP-IB control. In the remote mode, and if the LCL key is not locked out by the controller, only the LCL key is recognized by the -hp-3561A.

SRQ

The SRQ (service request) indicator illuminates to indicate that the -hp-3561A is generating an HP-IB service request.

LTN

The LTN (listen) indicator illuminates to indicate that the -hp-3561A is addressed to listen over the HP-IB.

TLK

The TLK (talk) indicator illuminates to indicate that the -hp-3561A is addressed to talk over the HP-IB.

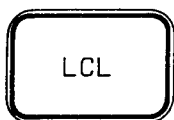

The LCL (local) key removes the -hp-3561A from the remote mode if local lockout is not in effect. The LCL key also defines and displays the menu for HP-IB address entry and HP-IB configuration.

DEFINE ADDRESS

The -hp-3561A HP-IB address is entered with the DEFINE ADDRESS softkey. Valid address entries are integers in the range from 0 to 30.

TLK ONLY ON OFF

The TLK ONLY ON OFF (talk only on off) softkey enables or disables the HP-IB talk only mode for directly controlling a printer or plotter without an HP-IB controller. When the talk only mode is used to directly control a printer or plotter, the printer or plotter must be in the listen only mode. Consult the printer or plotter operating manual for directions on selecting the listen only mode.

PwronSRQ ON OFF

The PwronSRQ ON OFF (power on service request on off) softkey enables or disables setting the -hp-3561A HP-IB SRQ each time power is applied to the -hp-3561A.



The PLOT key defines and displays the menu for entering the parameters for plotting the display trace on an external HP-IB plotter or printer.

- PLOT** The PLOT softkey plots a representation of the current display on an external HP-IB plotter.
- COPY TO PRINTER** The COPY TO PRINTER softkey prints a representation of the current display on an external HP-IB raster graphics printer.
- PLOT MARKER** The PLOT MARKER softkey draws the current marker values on the plot at the current marker position.
- ANNOTATE ON OFF** The ANNOTATE ON OFF softkey enables or disables plotting of the display annotations.
- GRID ON OFF** The GRID ON OFF softkey enables or disables plotting of the display grid.
- SELECT SETUP** The SELECT SETUP entry defines and displays an additional PLOT menu for entering plotter parameters.

DEFAULT SETUP The *DEFAULT SETUP* softkey assigns default values to the plot parameters. This softkey does not affect the display annotation or grid display status. The following values are defined as default values:

- PLOT SPD - FAST*
- A LINE - 1*
- B LINE - 1*
- A PEN - 2*
- B PEN - 2*
- GRID PEN - 1*

PLOT SPD SLOW FST The *PLOT SPD SLOW FST* (plot speed slow fast) softkey controls the velocity of the plot pen of the external plotter. A fast pen speed is the default value. The fast pen speed is set for the default value of the plotter (usually 36 cm/sec) and the slow speed is set for 5 cm/sec.

DEFINE A LINE The type of line used for trace A is entered with the *DEFINE A LINE* softkey. Allowable values for the line type are 1 to 7. The line types are illustrated in Figure 2-1.

DEFINE B LINE The type of line used for trace B is entered with the *DEFINE B LINE* softkey. Allowable values for the line type are 1 to 7. The line types are illustrated in Figure 2-1.

Figure 2-1. Plotter Line Type

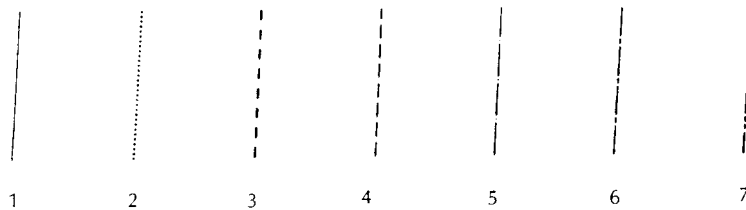

DEFINE A PEN *The pen number used to draw trace A is entered with the DEFINE A PEN softkey. Allowable values for pen numbers are 0 to 127. An entry of 0 indicates that no pen is selected.*



DEFINE B PEN *The pen number used to draw trace B is entered with the DEFINE B PEN softkey. Allowable values for pen numbers are 0 to 127. An entry of 0 indicates that no pen is selected.*

DEFINE GRID PEN *The pen number used to draw the plot grids, axes, and text is entered with the DEFINE GRID PEN softkey. Allowable values for pen numbers are 0 to 127. An entry of 0 indicates that no pen is selected.*

ABORT PLOT The ABORT PLOT softkey aborts an in progress plot operation.

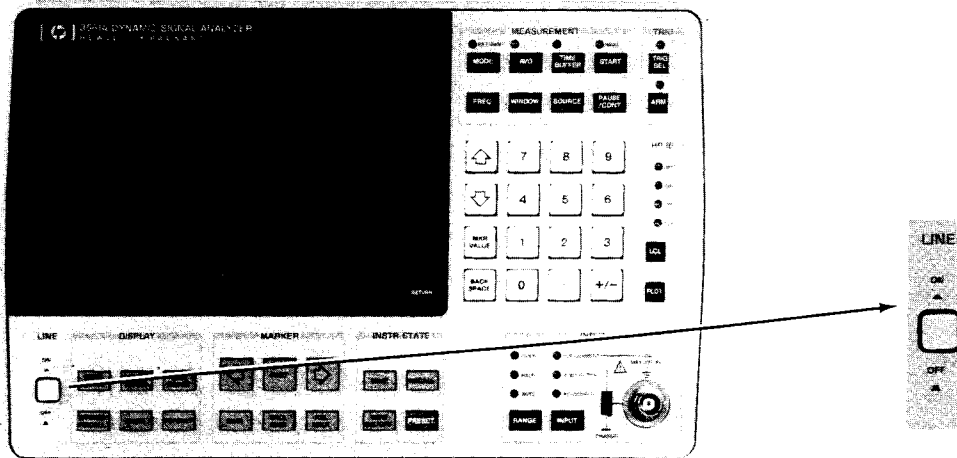
LINE KEY GROUP



ON

OFF

The LINE key applies power to the -hp-3561A circuits.

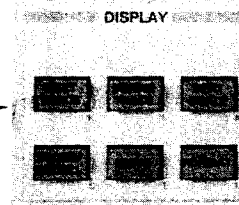
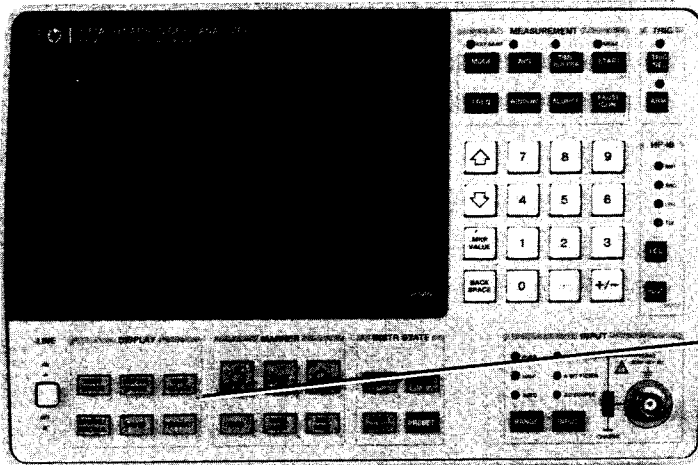
DISPLAY GROUP KEYS AND INDICATORS



The NEXT TRACE key selects the active trace on the display. For a single trace format display, the NEXT TRACE key toggles the display between the two

available traces. The active trace is the trace displayed. In the UPPER LOWER trace display format, the active trace is indicated by the intensified trace label. In the FRONT BACK trace display format, the active trace is intensified. For map trace display formats, NEXT TRACE sequentially selects the map traces. In the MAP trace display format, the selected trace is intensified and, if trace label display is enabled, the trace label is displayed.



The DEFINE TRACE key defines and displays the menu for specifying the measurement function of the active trace. The menu displayed is dependent upon the measurement mode selected through the MEASURE-

MENT MODE key.



(Narrow Band Mode Selected)

MAG

The MAG (magnitude) softkey selects a magnitude versus frequency display. The units of the display are entered

through the UNITS key and the scale of the graticule is entered through the VERT SCALE key.

PHASE

The PHASE softkey selects a phase display. The units of the display vertical axis are degrees. From the preset

state, the center of the vertical axis represents zero degrees. Alternate values for the center of the vertical axis are entered through the VERT SCALE key.

TIME

The TIME softkey enables the display of time domain data used for the FFT. Three time representations are available:

TIME REAL, TIME IMAG, and INPUT TIME. The time representation displayed is selected through the TIME SELECT softkey. The 1024 time domain data points are compressed to 399 data points for the display trace.

INPUT MAG The INPUT MAG (input magnitude) softkey displays the full span magnitude spectrum of the input signal. Selecting INPUT MAG does not alter the frequency span of other displays.

MATH FUNCTION FCN SELECT The MATH FUNCTION softkey displays the resultant trace of the math operation defined through the MATH FCN SELECT softkey.

MATH FCN SELECT The sequence and definition of math operations performed on traces is entered through the MATH FCN SELECT (math function select) softkey. Figure 2-2 illustrates the additional menus available with this softkey.

TIME SELECT The TIME SELECT softkey defines and displays the menu to specify the data source of the time display enabled with the TIME softkey.

TIME REAL *The TIME REAL softkey displays the real portion of complex value time data points used in computing the FFT.*

TIME IMAG *The TIME IMAG softkey displays the imaginary portion of complex value time data points used in computing the FFT. For measurements with a start frequency of zero Hertz, data is not available for TIME IMAG display because imaginary time points are not created.*

INPUT TIME *The INPUT TIME softkey selects a time domain display of the input signal. The INPUT TIME display is useful for setting input range and trigger level.*

MAG The MAG (magnitude) softkey selects a magnitude versus frequency display. The units of the display are entered through the UNITS key and the scale of the graticule is entered through the VERT SCALE key.

PHASE The PHASE softkey selects a phase display. The units of the display vertical axis are degrees. From the preset state, the center of the vertical axis represents zero degrees. Alternate values for the center of the vertical axis are entered through the VERT SCALE key.

TIME The TIME softkey enables the display of time domain data used in processing the input signal. Five time representations are available: TIME REAL, TIME IMAG, COMPRESS REAL, COMPRESS IMAG, and INPUT TIME. The time representation displayed is selected through the TIME SELECT softkey. The time domain data points are compressed to 399 data points for the display trace.

AVERAGE MAG The AVERAGE MAG (average magnitude) softkey displays the average rms magnitude spectrum of all the time records captured in the time buffer. The maximum number of averages depends on the number of records captured. For example, if 40 records are available, then 40 averages are available.

MATH FUNCTION FCN SELECT The MATH FUNCTION softkey displays the resultant trace of the math operation defined through the MATH FCN SELECT softkey.

MATH FCN SELECT The sequence and definition of math operations performed on traces is entered through the MATH FCN SELECT (math function select) softkey. Figure 2-2 illustrates the additional menus available with this softkey.



(Time Capture Mode Selected)

Figure 2-2. Math Function Softkeys

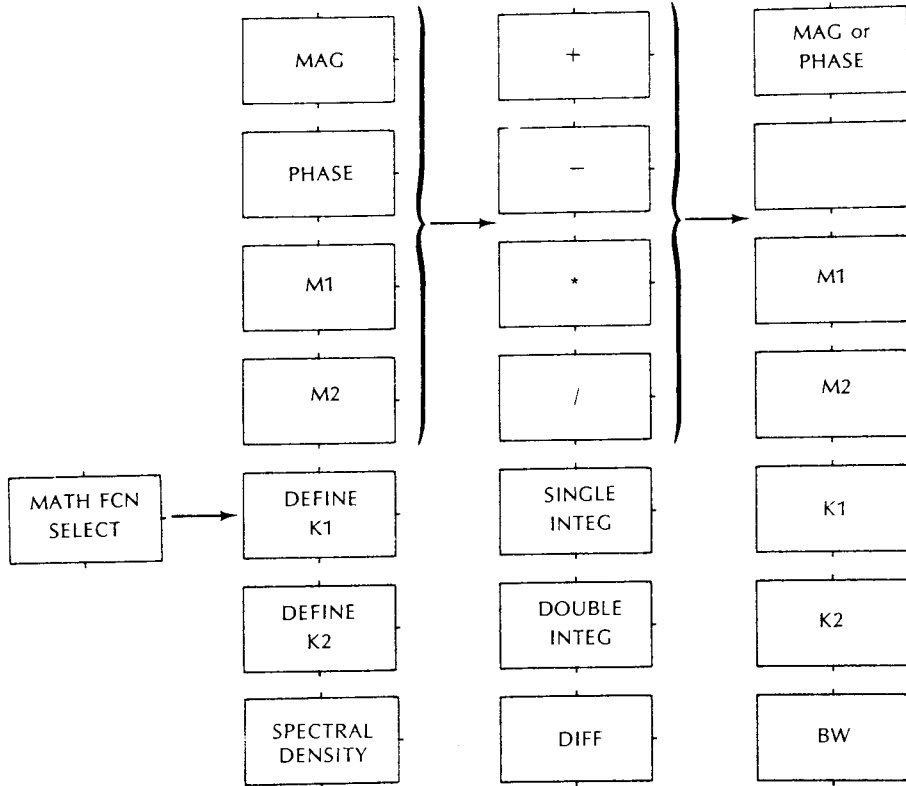

-
- MAG** Selects the magnitude trace as the first operand in a math function. The MAG operand uses the magnitude data (MAG, INPUT MAG, AVG MAG) defined for the active trace. If a time or phase trace is selected for the active trace, MAG display data is used for this operand.
- PHASE** Selects the phase trace as the first operand in a math function. The results of phase math functions are in the range of $\pm 180^\circ$. Phase math operations are not applicable for 1/3 or full octave modes.
- M1** Selects memory location M1 as the first or second operand in a math function.
- M2** Selects memory location M2 for the first or second operand in a math function.
- DEFINE K1** Enables entry of constant K1. Values for K1 are entered as linear values. Exponents are added to values entered with the numeric keypad with the ent exp (enter exponent) softkey. The ent exp softkey appears as constant K1 is defined with the numeric keypad. The absolute value of K1 is used when the math operation involves a magnitude trace.

DEFINE	Enables entry of constant K2. Values for K2 are entered as linear values.
K2	Exponents are added to values entered with the numeric keypad with the ent exp (enter exponent) softkey. The ent exp softkey appears as constant K2 is is defined with the numeric keypad. The absolute value of K2 is used when the math operation involves a magnitude trace.
SPECTRAL DENSITY	Selects the math function MAG/BW. For display units of VOLT (dBV) or EU (dBEU), SPECTRAL DENSITY displays magnitude divided by the square root of the measurement bandwidth ($MAG \div \sqrt{BW}$). For display units of VOLTS ² (dBV), mW (dBm), or EU ² (dBEU), SPECTRAL DENSITY displays magnitude squared divided by the measurement bandwidth ($MAG^2 \div BW$).
+	Selects addition as the math operation.
-	Selects subtraction as the math operation.
*	Selects multiplication as the math operation.
/	Selects division as the math operation.
SINGLE INTEG	Selects a single integration of the first operand as the math function. For a phase math operation, 90° is subtracted from each display position. For a magnitude operation, each display position is divided by $2 \pi f$ where f is the frequency of the display position.
DOUBLE INTEG	Selects a double integration of the first operand as the math function. For a phase math operation, 180° is subtracted from each display position. For a magnitude math operation, each display position is divided by $(2 \pi f)^2$ where f is the frequency of the display position.
DIFF	Selects a single differentiation of the first operand as the math function. For a phase math operation, 90° is added to each display position. For a magnitude math operation, each display position is multiplied by $2 \pi f$ where f is the frequency of the display position.
MAG or PHASE	Selects the magnitude or phase display as the second math operand. The trace type of second operand is selected to be consistent with the first operand.
K1	Selects constant K1 as the second operand in the math function.
K2	Selects constant K2 as the second operand in the math function.
BW	Selects the measurement bandwidth as the second operand. For narrowband data, the measurement bandwidth is the measurement span times a window factor divided by 400. For the 1/3 or full octave data, the measurement bandwidth is the bandwidth of the band times a window factor. The window factors are: Flat Top 3.8194 Hanning 1.5 Uniform 1.0 Expontl 1.0.

TIME SELECT The TIME SELECT softkey defines and displays the menu to specify the data source of the time display enabled with the TIME softkey.

TIME REAL The TIME REAL softkey displays the real portion of complex value time data points used in the FFT. The TIME BUFFER key DEFINE START t softkey defines the start time of the analysis.

TIME IMAG The TIME IMAG (time imaginary) softkey displays the imaginary portion of complex value time data points used in the FFT. For measurements with a start frequency of zero Hertz, data is not available for TIME IMAG display because imaginary time points are not created. The TIME BUFFER key DEFINE START t softkey defines the start time of the analysis.

COMPRESS REAL The COMPRESS REAL softkey displays the real portion of the complex value time data points stored in the time buffer.

COMPRESS IMAG The COMPRESS IMAG (compress imaginary) softkey displays the imaginary portion of the complex value time data points stored in the time buffer. For measurements with a start frequency of zero Hertz, data is not available for COMPRESS IMAG display because imaginary time points are not created.

INPUT TIME The INPUT TIME softkey selects a time domain display of the input signal. The INPUT TIME display is useful for setting input range and trigger level.



(Third Octave or Full Octave Mode Selected)

MAG The MAG (magnitude) softkey selects a magnitude versus frequency display. The display is limited to 11 bands plus total rms power band in the full octave mode and 33 bands plus total rms power in the third octave mode. Because of the fixed number of bands, the span of the display is specified by entering the greatest band number or frequency value to be displayed through the FREQ key menu. The units of the display are entered through the UNITS key and the scale of the graticule is entered through the VERT SCALE key.

TIME The TIME softkey enables the display of time domain data used to calculate the third octave and full octave displays. Four time representations are available: TIME LO SPAN, TIME MID SPAN, TIME HI SPAN, and INPUT TIME. The time representation displayed is selected through the TIME SELECT softkey. The time domain data points are compressed to 399 data points for the display trace.

INPUT MAG The INPUT MAG (input magnitude) softkey displays the narrow band full span magnitude spectrum of the input signal. The INPUT MAG display is independent of the frequency span selected. Selecting INPUT MAG does not alter the frequency span of other displays.

MATH FUNCTION The MATH FUNCTION softkey displays the resultant trace of the math operation defined through the MATH FCN SELECT softkey.

MATH FCN SELECT The sequence and definition of math operations performed on traces is entered through the MATH FCN SELECT (math function select) softkey. Figure 2-2 illustrates the additional menus available with this softkey.

TIME SELECT The TIME SELECT softkey defines and displays the menu to specify the data source of the time display enabled with the TIME softkey.

TIME LO SPAN *The TIME LO SPAN (time low span) softkey displays the lower linear time span of the three spans used to calculate the display bands.*

TIME MID SPAN *The TIME MID SPAN (time middle span) softkey displays the center linear time span of the three spans used to calculate the display bands.*

TIME HI SPAN *The TIME HI SPAN (time high span) softkey displays the higher linear time span of the three spans used to calculate the display bands.*

INPUT TIME *The INPUT TIME softkey selects a time domain display of the input signal. The INPUT TIME display is useful for setting input range and trigger level.*



The VERT SCALE (vertical scale) key defines and displays the menu for selecting the vertical scale format of the display. The menu displayed is dependent upon the trace type selected through the DEFINE TRACE key. Selections from the VERT SCALE menu operate on the active trace.



(Magnitude Trace Display)

SINGLE AUTO SCL The SINGLE AUTO SCL (single auto-scale) softkey scales both the units per division and full scale values of the vertical axis. The full scale value is based upon the largest signal in the trace. The units per division is selected based on the maximum and minimum value of the signal.

FULL SCL HOLD TRK When the HOLD portion of the FULL SCL HOLD TRK (full scale hold track) softkey is intensified, the current vertical axis scale is maintained. When the TRK portion of the FULL SCL HOLD TRK softkey is intensified, the full scale of the vertical axis scale is coupled to the input range. When either the DEFINE FULL SCL or SINGLE AUTO SCL softkey is selected, the full scale hold function is enabled.

DEFINE dB/DIV Values for the logarithmic vertical axis scale divisions are entered with the DEFINE dB/DIV (define dB/division) softkey. Values entered with the numeric keypad are terminated with a units or CANCEL softkey. The predefined vertical axis increments are .5, 1, 2, 5, 10, and 20 dB per division. The minimum value for the vertical scale is .5 dB per division. The maximum value for the vertical scale is 20 dB per division.

DEFINE FULL SCL Values for the full scale vertical axis are entered with the DEFINE FULL SCL (define full scale softkey). Values entered with the numeric keypad are terminated with a units or CANCEL softkey.

LINEAR LOG The LINEAR LOG (linear logarithmic) softkey selects a linear or logarithmic scale for the vertical axis. The linear axis scale sets the baseline of the graticule at 0 volts. The full scale value of the graticule corresponds to the value entered with the DEFINE FULL SCL softkey. The logarithmic axis scale sets full scale of the graticule to the value entered with the DEFINE FULL SCL softkey. The divisions of the vertical axis correspond to the value entered with the DEFINE dB/DIV softkey.



(Phase Trace Display)

SINGLE AUTO SCL The SINGLE AUTO SCL (single auto scale) softkey scales the vertical axis of the graticule as a function of the level of display trace.

DEFINE CENTER Values for the center vertical axis division of the phase display are entered with the DEFINE CENTER softkey. Values entered with the numeric keypad are terminated with a DEG or CANCEL softkey. Values for the center axis are in the range of $\pm 320^\circ$ in 1° steps.

DEFINE DEG/DIV Values for the scale of the vertical axis divisions of the phase display are entered with the DEFINE DEG/DIV (define degrees/division) softkey. Values entered with the numeric keypad are terminated with a DEG or CANCEL softkey. Allowable values are 10, 15, 30, 45, and 60 degrees per division.



(Time Trace Display)

SINGLE AUTO SCL The SINGLE AUTO SCL (single auto-scale) softkey scales the vertical axis of the graticule as a function of the level of display trace.

FULL SCL HOLD TRK When the HOLD portion of the FULL SCL HOLD TRK (full scale hold track) softkey is intensified, the current vertical axis scale is maintained. When the TRK portion of the FULL SCL HOLD TRK softkey is intensified, the full scale of the vertical axis scale is coupled to the input range. When either the DEFINE FULL SCL or SINGLE AUTO SCL softkey is selected, the full scale hold function is enabled.

DEFINE CENTER Values for the center vertical axis division of the time display are entered with the DEFINE CENTER softkey. Values entered with the numeric keypad are terminated with a UNITS or CANCEL softkey. Values for the center axis are in the range of $\pm 42V$ in 10 mV steps.

DEFINE UNIT/DIV Values for the vertical axis scale divisions are entered with the DEFINE UNIT/DIV (define unit/division) softkey. Values entered with the numeric keypad are terminated with a units or CANCEL softkey. Values for units/div range from 1 microvolt to 10 volts.



The STORE/RECALL key defines and displays the menus for storing or recalling traces from memory and entering trace labels.

TRACELBL ON OFF The TRACELBL ON OFF (trace label on off) softkey enables or disables displaying the trace label above the trace graticule. Trace labels are entered with the DEFINE TRACELBL softkey.

DEFINE TRACELBL Alphanumeric trace labels are entered with the DEFINE TRACELBL (define trace label) softkey. Pressing this softkey places the -hp-3561A into an alphanumeric entry mode (see Table 2-4). Label entry is terminated with the ENTER or CANCEL softkey. The trace label is assigned to the active trace.

STORE IN M1 The STORE IN M1 softkey stores the active trace in non-volatile memory location M1.

STORE IN M2 The STORE IN M2 softkey stores the active trace in non-volatile memory location M2.

RECALL M1 The RECALL M1 softkey replaces the active trace display with the trace stored in memory M1.

**RECALL
M2**

The **RECALL M2** softkey replaces the active trace display with the trace stored in memory M2.

**TRACEFLE
SELECT**

The **TRACEFLE SELECT** (trace file select) softkey defines and displays the menu for bubble memory file management. This softkey is available only if the bubble memory option is installed.

**DEFINE
FILENAME**

Trace file names are entered with the **DEFINE FILENAME** softkey. Pressing this softkey places the -hp-3561A into an alphanumeric entry mode (see Table 2-4). File name entry is terminated with the **CANCEL** or **ENTER** softkey. The trace file name is used for saving, deleting, or recalling traces from bubble memory.

**USE CAT
FILENAME**

The **USE CAT FILENAME** (use catalog file name) softkey uses the catalog name at the top of the catalog for the file name used in store, recall, or delete operations. The catalog is displayed with the **CATALOG ON OFF** softkey. The up and down arrow keys scroll the catalog after it is displayed.

**STORE
TRACE**

The **STORE TRACE** (store trace file) softkey stores the active trace in bubble memory under the file name entered with the **DEFINE FILENAME** or **USE CAT FILENAME** softkeys. When a full map display is selected, a complete map is stored in a set of indexed files.

**RECALL
TRACE**

The **RECALL TRACE** (recall trace) softkey recalls the trace file selected with the **DEFINE FILENAME** or **USE CAT FILENAME** softkey from bubble memory. The file recalled is displayed as the active trace. When a full map display is selected, complete maps are recalled using indexed file names.

DELETE

The **DELETE** softkey deletes the bubble memory data file specified with the **DEFINE FILENAME** or **USE CAT FILENAME** softkey.

ABORT

The **ABORT** softkey aborts the current bubble memory recall, store, or delete operation.

**CATALOG
ON OFF**

The **CATALOG ON OFF** softkey enables or disables display of the bubble memory catalog.

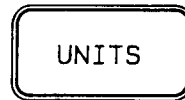

The **UNITS** key defines and displays the menu for entering the units of the vertical scale.

**VOLT
(dBV)**

The **VOLT (dBV)** softkey assigns the units of mV, V, and dBV to the graticule vertical scale. Voltage values are in rms units for magnitude, level, and range quantities; and in peak units for time quantities.

**VOLT ^2
(dBV)**

The **VOLT ^2 (dBV)** (**VOLT^2 (dBV)**) softkey assigns the units of mV^2 (mV²), and dBV to the graticule vertical scale. Linear voltage values are in V²_{rms} units for magnitude, level, and range quantities. Logarithmic voltage values are in dBV for magnitude, level, and range quantities. Time quantities are displayed in peak volts. The symbols ^2 are added to magnitude trace descriptions to indicate **VOLT ^2 (dBV)** units are selected.

**mW
(dBm)**

The **mW (dBm)** softkey assigns the units of mW, and dBm to the graticule vertical scale for magnitude, level, and range displays. The peak units mV and V are assigned to vertical scale for time quantities.

EU (dBEU) The EU (dBEU) softkey assigns engineering units (EU) to the vertical scale. Engineering units are defined with the UNIT CAL SELECT softkey.

EU ^2 (dBEU) The EU ^2 (dBEU) engineering units squared) softkey assigns engineering units to the graticule vertical scale. Linear values are in EU²_{rms} units for magnitude, level and range quantities. Logarithmic voltage values are in dBEU for magnitude, level, and range quantities. Time quantities are displayed in peak units. The symbols ^2 are added to magnitude trace descriptions to indicate EU ^2 (dBEU) units are selected.

UNIT CAL SELECT The UNIT CAL SELECT (unit calibration select) softkey defines and displays an additional menu for defining the impedance levels of power measurements, and defining engineering units calibration factors.

DEFINE HZ/ORD *The number of Hertz per order is entered with the (define Hertz/order) softkey. This calibration is used when external sample is off and ORD (REV) is selected for units.*

DEFINE IMPDNCE *The impedance value used for power computations is entered with the DEFINE IMPDNCE (define impedance) softkey. The default value for impedance is 50 ohms. Values entered with the numeric keypad are terminated with a units or CANCEL softkey. Values for impedance range from 1 ohm to 25 kilohms.*

DEFINE V/UNIT *The conversion factor converting the input voltage to engineering units is entered with the DEFINE V/UNIT (define volts/unit) softkey. Values entered with the numeric keypad are terminated with a units or CANCEL softkey.*

DEFINE UNIT @ MKR *The engineering units reference value corresponding to the current marker position is entered with DEFINE UNIT @ MKR (define unit at marker) softkey. Values entered with the numeric keypad are terminated with a units or CANCEL softkey. Exponents are added to values entered with the numeric keypad with the ent exp (enter exponent) softkey. The ent exp softkey appears as the engineering units are defined with the numeric keypad.*

DEFINE EU LBL *The engineering units label assigned to the vertical scale is entered through the DEFINE EU LBL (define engineering unit label) softkey. Pressing this softkey places the -hp-3561A into an alphanumeric entry mode (see Table 2-4). Label entry is terminated with the CANCEL or ENTER softkey. The conversion factor converting the input voltage to label units is entered with the DEFINE V/UNIT softkey.*

X UNITS SELECT The X UNITS SELECT softkey defines and displays an additional menu for selecting the units of the horizontal axis.

HZ (SEC) *The HZ (SEC) (Hertz second) softkey assigns the units of Hertz or seconds to the horizontal axis of the graticule.*

**RPM
(SEC)**

The RPM (SEC) (revolutions per minute second) softkey assigns the units of RPM or seconds to the horizontal axis of the graticule.

**ORD
(REV)**

The ORD (REV) (order revolution) softkey assigns the units of orders or revolutions to the horizontal axis of the graticule.

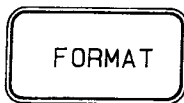

The FORMAT key defines and displays the menu for selecting the display format.

SINGLE

The SINGLE softkey displays only one trace and graticule on the display. A second trace format is available (the inactive trace) but is not displayed. The NEXT TRACE key alternates the display of the two traces. Key operations in the DISPLAY and MARKER key group operate on the displayed trace without affecting the inactive trace.

**UPPER
LOWER**

The UPPER LOWER softkey displays dual sets of graticules and traces on the display. The active trace is selected with the NEXT TRACE key. The active trace is identified by the intensified label to the top left of the graticule. Key operations in the DISPLAY and MARKER key group operate on the active trace without affecting the inactive trace.

**FRONT
BACK**

The FRONT BACK softkey overlays the two available traces on the graticule of the active trace. The intensified trace on the display is the active trace selected with the NEXT TRACE key. Key operations in the DISPLAY and MARKER key group operate on the active trace without affecting the inactive trace.

**MAG MAP/
(CLEAR)**

The MAG MAP/(CLEAR) (magnitude map) softkey displays multiple magnitude traces on a single display graticule. A new map display is generated each time the MAG MAP/(CLEAR) softkey is selected. The number of traces appearing on the display is entered with the DEFINE # IN MAP softkey. MAG MAP/(CLEAR) is available only in the narrow band and time capture modes.

**VERTICAL
OFFSET**

The VERTICAL OFFSET softkey selects either a vertical magnitude map or an offset magnitude map display. For a vertical map display, each trace added to the display is offset in the vertical axis from the previous trace. For an offset map display, each trace added to the display is offset in both the horizontal axis and the vertical axis. The alternate map format can be selected after a map is displayed without acquiring new data. The VERTICAL OFFSET softkey is available only in the narrow band and time capture modes.

**SNGL MAP
FULL MAP**

The SNGL MAP FULL MAP (single map full map) menu selects either the normal (full) map display or a single trace map display. For the single trace map, the trace displayed is the active (intensified) trace in the full map. Pressing the NEXT TRACE key displays the next trace in the map. Alternating the display between a single map display and a full map display does not require acquiring new data. The SNGL MAP FULL MAP softkey is available only in the narrow band and time capture modes.

**DEFINE #
IN MAP**

The number of traces displayed in a map display is entered with the DEFINE # IN MAP softkey. Values entered are terminated with the ENTER or CANCEL softkey. The number of traces in a map can be changed without acquiring new data. The maximum number of traces in a map is 60, or the number of traces specified when data

for the map is acquired. Requesting a negative number of traces generates the map in reverse order. The DEFINE # IN MAP softkey is available only in the narrow band and time capture modes.

MARKER GROUP KEYS

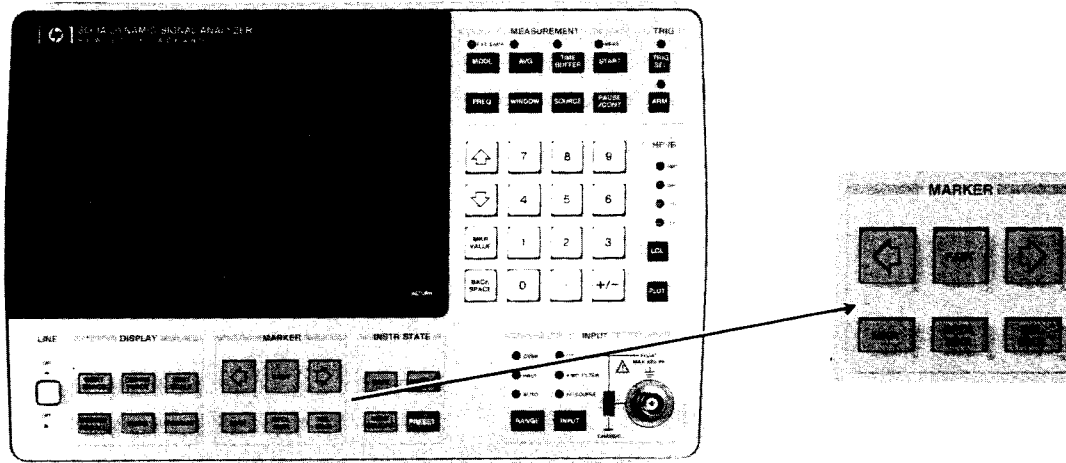

The marker left arrow moves the marker towards the left edge of the graticule.

MKR ON OFF

The MKR ON OFF (marker on off) softkey enables or disables display of the marker.



The marker FAST key, pressed simultaneously with either the marker right arrow or left arrow key, increases the marker movement speed.

MKR -> PEAK

The MKR -> PEAK (marker to peak) softkey positions the marker on the signal with the largest magnitude and non-zero frequency. If two signals have the same magnitude, the left signal is selected.



The marker right arrow moves the marker towards the right edge of the graticule.

MKR -> FULL SCL

The MKR -> FULL SCL (marker to full scale) softkey assigns a full scale display value that corresponds to the marker vertical scale value. If the marker value is invalid as a full scale value, the next valid value larger than the marker value is assigned to full scale.



The MKR (marker) key defines and displays the menu for selecting the marker functions that measure a discrete point on the display.

**MKR ->
CTR FREQ** The MKR -> CTR FREQ (marker to center frequency) softkey assigns the marker horizontal axis value to the display center frequency.

**PEAK TRK
ON OFF** The PEAK TRK ON OFF (peak track on off) softkey enables or disables tracking of the peak signal by the marker.

**STEP
ON OFF** The STEP ON OFF softkey enables or disables coupling of the marker frequency step to the special marker position. STEP ON OFF has no effect if either BAND POWER, HARMONIC, or SIDEBAND special markers are not selected.

**DEFINE
MKR POS** The marker is positioned at a specific point on the horizontal axis with the DEFINE MKR POS (define marker position) softkey. Values entered with the numeric keypad for the marker position are terminated with a units or CANCEL softkey.



The SPCL MKR (special marker) key defines and displays the menu for selecting the special marker functions.

OFF The OFF softkey disables the special markers.

BAND The BAND softkey computes the power or rms voltage in the band defined by the two markers displayed. The two markers are defined with the DEFINE LEFT FRQ and DEFINE RGHT FRQ softkeys available when this softkey is selected. For voltage or engineering unit (EU) displays, the resultant measurement yields rms voltage or EUrms. For volts² or EU² displays, the resultant measurement yields power referenced to 1 ohm. For power (mW, dBm) displays, the resultant measurement yields power referenced to measurement impedance. For math functions involving volts, milliwatts, or EU,

the resultant measurement yields the square root of the sum of the square of the display values ($\sqrt{\Sigma \text{Value}^2}$). For math functions involving volt² or EU², the resultant measurement yields the sum of the square of the display values (ΣValue^2). For the spectral density math function, the resultant measurement yields the true band level divided by the measurement bandwidth or the square root of the measurement bandwidth. If a time, phase, 1/1 octave, or 1/3 octave trace is selected, the BAND softkey displays a prompt indicating the special markers disabled.

Note

Only the mW and dBm band measurements should be considered power measurements because the calculations involved account for the measurement impedance. Because the EU and voltage calculations do not use the impedance value, the results should be considered an indication of the overall signal level.

The HARMONIC softkey displays special markers on the harmonics specified with DEFINE FUND FRQ and DEFINE NUM HARM softkeys. The DEFINE FUND FRQ and DEFINE NUM HARM softkeys are available only when the HARMONIC softkey is selected. The resulting computation indicates the total harmonic distortion. If a time, phase, 1/1 octave, or 1/3 octave trace is selected, the HARMONIC softkey displays a prompt indicating that special markers are disabled.

The SIDEBAND softkey displays special markers on the carrier frequency and the number of sidebands specified with the DEFINE CARR FRQ, DEFINE SB FREQ, and DEFINE NUM. SB softkeys. The resulting computation indicates the ratio of sideband power to carrier power. The DEFINE CARR FRQ, DEFINE SB FREQ, and DEFINE NUM. SB softkeys are available only when the SIDEBAND softkey is selected. If a time, phase, 1/1 octave, or 1/3 octave trace is selected, the SIDEBAND softkey displays a prompt indicating that special markers are disabled.

DEFINE LEFT FRQ The value for the left BAND special marker is entered with the DEFINE LEFT FRQ (define left frequency) softkey. This softkey is available only when the BAND softkey is selected.

DEFINE RGHT FRQ The value for the right BAND special marker is entered with the DEFINE RGHT FRQ (define right frequency) softkey. This softkey is available only when the BAND softkey is selected.

BAND TRK ON OFF The BAND TRK ON OFF (band track on off) softkey enables or disables coupling of the right and left markers by the BAND special markers. This softkey is available only when the BAND softkey is selected. The frequency band is shifted by changing either the right or left marker position.

DEFINE FUND FRQ The value for the fundamental frequency of the HARMONIC analysis special marker is entered with the DEFINE FUND FRQ (define fundamental frequency) softkey. This softkey is available only when the HARMONIC special marker is selected. Values entered with the numeric keypad for the special marker position are terminated with a units or CANCEL softkey. Fine adjustment of the marker is possible by using the up and down arrow keys.

DEFINE NUM HARM The number of harmonic frequencies marked with HARMONIC special markers is entered with the DEFINE NUM HARM (define number of harmonics) softkey. This softkey is available only when the HARMONIC special marker is selected. Values entered with the numeric keypad for the number of harmonics are terminated with an ENTER or CANCEL softkey.

DEFINE CARR FRQ The value of the carrier frequency for the SIDEBAND analysis special marker is entered with the DEFINE CARR FRQ (define carrier frequency) softkey. This softkey is available only when the SIDEBAND special marker is selected. Values entered with the numeric keypad for the carrier frequency are terminated with a units or CANCEL softkey. Fine adjustment of the marker is possible by using the up and down arrow keys.

DEFINE SB FRQ The value for the sideband frequency for the SIDEBAND analysis special marker is entered with the DEFINE SB FRQ (define sideband frequency) softkey. This softkey is available only when the SIDEBAND special marker is selected. Values entered with the numeric keypad for the sideband frequency are terminated with a units or CANCEL softkey.

DEFINE NUM. SB The number of sideband frequencies marked for the SIDEBAND special markers is entered with the DEFINE NUM. SB (define number of sidebands) softkey. This softkey is available only when the SIDEBAND special marker is selected. Values entered with the numeric keypad for the number of sidebands are terminated with an ENTER or CANCEL softkey.



The REL MKR (relative marker) key defines and displays the menu for selecting and defining the relative marker functions.

REL MKR ON OFF The REL MKR ON OFF (relative marker on off) softkey enables and disables the relative marker functions. Values displayed for the marker are in absolute units when the relative marker is disabled and relative units when enabled.

MKR --> REF The MKR --> REF (marker to reference) softkey assigns the current marker coordinate values to the relative measurement reference values.

**DEFINE
MAG REF** Values for the reference magnitude used in relative measurements are entered with the DEFINE MAG REF (define magnitude reference) softkey. Values entered are terminated with a units or CANCEL softkey.

**DEFINE
FREQ REF** Values for the reference frequency used in relative measurements are entered with the DEFINE FREQ REF (define frequency reference) softkey. Values entered are terminated with a units or CANCEL softkey.

**DEFINE
PHAS REF** Values for the phase reference used in relative measurements are entered with the DEFINE PHAS REF (define phase reference) softkey. Values entered are terminated with a units or CANCEL softkey. Values for the phase reference are in the range of $\pm 180^\circ$.

**DEFINE
TIME REF** Values for the reference time used in relative measurements are entered with the DEFINE TIME REF (define time reference) softkey. Values entered are terminated with a units or CANCEL softkey.

INSTR STATE KEYS

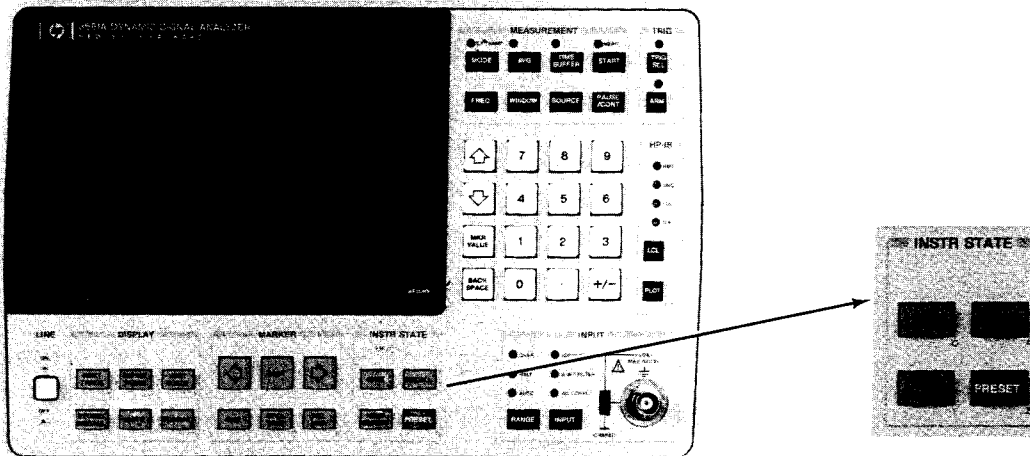

The SAVE key defines and displays the menu for saving instrument setups in nonvolatile memory. Two menus are available for the SAVE key. The menu displayed is dependent upon installation of the bubble memory option.

The SAVE STATE ___ softkeys save the instrument setup (state) in one of six non-volatile memory locations. The instrument state is recalled through the RECALL key.



(Without Bubble Memory Option)



(With Bubble Memory Option)

**DEFINE
FILENAME**

The name of the instrument state data file saved to bubble memory is entered with the DEFINE FILENAME softkey. Pressing softkey places the -hp-3561A into an alphanumeric entry mode (see Table 2-4). File name entry is terminated with the CANCEL or ENTER softkey.

**USE CAT
FILENAME**

The USE CAT FILENAME (use catalog file name) softkey uses the catalog name at the top of the catalog for the file name used in store, recall, or delete operations. The catalog is displayed with the CATALOG ON OFF softkey. The up and down arrow keys scroll the catalog after it is displayed.

**SAVE
STATE**

The SAVE STATE softkey stores the current instrument state data in a bubble memory data file specified with the DEFINE FILENAME or USE CAT FILENAME softkey.

DELETE

The DELETE softkey deletes the bubble memory data file specified with the DEFINE FILENAME or USE CAT FILENAME softkey.

ABORT

The ABORT softkey aborts the current bubble memory save or delete operation.

**CATALOG
ON OFF**

The CATALOG ON OFF softkey enables or disables display of the bubble memory catalog.

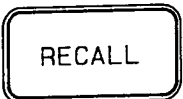

The RECALL key defines and displays the menu for retrieving instrument setups from memory. Two menus are available for the RECALL key. The menu displayed is dependent upon installation of the bubble memory option.

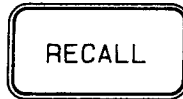

(Without Bubble Memory Option)

**RECALL
PWR DOWN**

The RECALL PWR DOWN (recall power down) softkey recalls the instrument state set prior to removing instrument power. The instrument state is recalled from nonvolatile memory.

**RECALL
STATE _**

The RECALL STATE _ softkey restores the instrument setup (state) to the configuration stored in one of six nonvolatile memory locations. An instrument state is saved through the SAVE key.

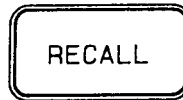

(With Bubble Memory Option)

**RECALL
PWR DOWN**

The RECALL PWR DOWN (recall power down) softkey recalls the instrument state set prior to removing instrument power. The instrument state is recalled from nonvolatile memory.

**DEFINE
FILENAME**

The name of the instrument state data file recalled from bubble memory is entered with the DEFINE FILENAME softkey. Pressing softkey places the -hp-3561A into an alphanumeric entry mode (see Table 2-4). File name entry is terminated with the CANCEL or ENTER softkey.

**USE CAT
FILENAME**

The USE CAT FILENAME (use catalog file name) softkey uses the catalog name at the top of the catalog for the file name used in store, recall, or delete operations. The catalog is displayed with the CATALOG ON OFF softkey. The up and down arrow keys scroll the catalog after it is displayed.

RECALL STATE The RECALL STATE softkey restores the instrument state to the configuration stored in a bubble memory state data file. The data file name recalled is entered with the DEFINE FILENAME or USE CAT FILENAME softkey.

CATALOG ON OFF The CATALOG ON OFF softkey enables or disables display of the bubble memory catalog.

ABORT The ABORT softkey aborts the current recall operation.



The VIEW ON/OFF key toggles the display between a graphics trace display or bubble memory catalog display and a text instrument state display.

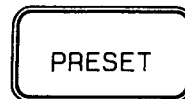

The PRESET key configures the instrument state to a predefined state. Table 2-5 lists the -hp-3561A PRESET state.

Table 2-5. -hp-3561A PRESET State

The PRESET instrument state is:

MEASUREMENT GROUP

MODE Key

Narrow Band
 External Sample Off
 Define Puls/Rev Selected

AVG Key

Off
 Number of Averages = 10
 Overlap = 0%
 Overload Reject Off
 Normal Display

TIME BUFFER Key

Number of Records = 40
 Start Time = 0
 Percent Increment = 100%
 Zoom Factor = 1
 Zoom Frequency = 0

FREQ Key

Menu Displayed
 0-100kHz Span
 Define Span Selected
 Linear Frequency Axis

WINDOW Key

Flattop
 Time Constant = 256

SOURCE Key

Off
 40.5 dB Attenuation

TRIGGER GROUP

TRIGGER SEL Key

Free Run
 Auto Arm
 Input Trigger
 Positive Trigger Slope
 Trigger Level = 0%
 Delay Off
 Delay = 0

HPIB GROUP

PLOT Key

Annotation On
 Grid Off
 Default Setup

DISPLAY GROUP

DEFINE TRACE Key

Trace A
 Active Trace
 Magnitude Format
 Time Selection Defined as Input
 Time
 Trace B
 Real Time
 Compress Real Selected for
 Time Capture

VERT SCALE Key

Track Input Range (Phase Auto Scale)
 10 dB/Division
 Logarithmic Scale

STORE/RECALL Key

Trace Label Off

UNITS Key

Volts/dBV Selected
 HZ/SEC Selected

FORMAT Key

Upper Lower Format
 Vertical Map
 Full Map
 Number of Traces in Map = 60

MARKER GROUP

MARKER Key

Marker On
 Peak Track Off
 Step Off

SPCL MKR Key

Special Markers Off

REL MKR Key

Relative Marker Off

INSTRUMENT STATE GROUP

VIEW ON-OFF

Off

INPUT GROUP

RANGE KEY

Auto-Range On

INPUT Key

Auto Cal On
 DC Coupled
 A-Weight Filter Off
 ICP Current Off
 Calibration Signal Off

INPUT GROUP KEYS AND INDICATORS

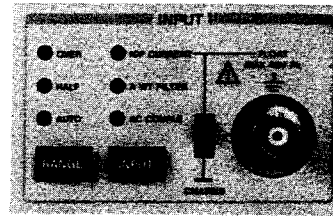
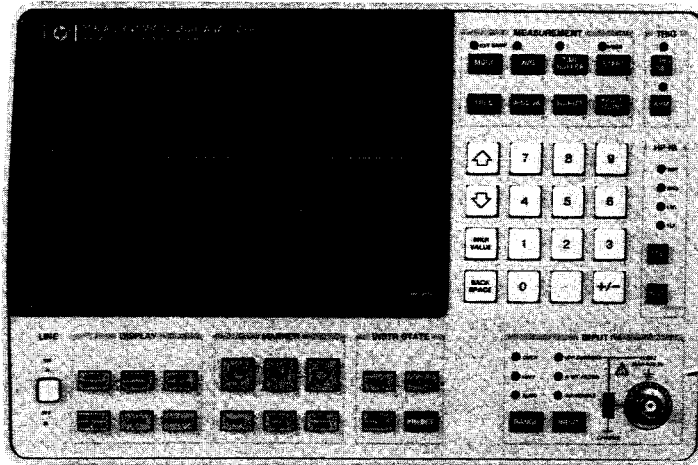

● OVER

The OVER indicator illuminates to indicate that the input signal amplitude exceeds the maximum range value of the input circuits. Overloading the input circuits introduces distortion into the measurement.

● HALF

The HALF indicator illuminates to indicate that the input signal level is greater than one-half the maximum allowable input range value. The optimum input level illuminates the HALF indicator without illuminating the OVER indicator.

● AUTO

The AUTO indicator illuminates to indicate that -hp-3561A auto-ranging circuits are enabled. Auto-ranging is enabled or disabled with the RANGE key AUTO RNG ON OFF softkey.

● ICP CURRENT

The ICP CURRENT indicator illuminates when the -hp-3561A ICP current source is enabled with the INPUT key ICP CURR ON OFF softkey.

● A WT FILTER

The A WT FILTER (A-weighting filter) indicator illuminates to indicate that the internal A-weighting filter is in the input signal path. Selection of the A-weighting filter is with the INPUT key A WT FLT ON OFF softkey.

● AC COUPLE

The AC COUPLE indicator illuminates to indicate ac coupling is selected with the INPUT key COUPLE AC DC softkey.

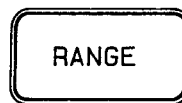

The RANGE key defines and displays the menu for setting the -hp-3561A input range.

AUTO RNG ON OFF

The AUTO RNG ON OFF (auto-range on off) softkey enables or disables automatic selection of the instrument input range as a function of the input signal level. The AUTO indicator illuminates to indicate that auto-ranging is enabled.

DEFINE RANGE The expected maximum amplitude value of the input signal is manually entered with the DEFINE RANGE softkey. Selecting DEFINE RANGE disables auto-ranging of the -hp-3561A. Valid range values are from -51 dBV (2.818 mVrms) to 27 dBV (22.39 Vrms) in 1 dB steps.

Note

Selecting a range value considerably larger than the value of the signal input will affect the resolution of the -hp-3561A time traces, and decrease the dynamic range of the magnitude traces. For maximum accuracy, set the input range as close as practical to expected input value.

SINGLE AUTO RNG The SINGLE AUTO RNG (single auto-range) softkey initiates a single auto-range cycle on the -hp-3561A. The auto-range cycle selects the appropriate input circuit range for the steady state signal applied to the INPUT connector.

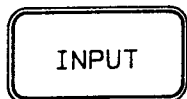

The INPUT key defines and displays the menu for selecting the -hp-3561A input circuit configuration and calibration modes.

AUTO CAL ON OFF The AUTO CAL ON OFF (automatic calibration on off) softkey enables or disables the automatic calibration of the -hp-3561A circuits. The calibration interval is dependent on the length of time power is applied to the -hp-3561A. Immediately after power is applied, calibration occurs at approximately five minute intervals. After 30 minutes of operation, calibration occurs at approximately 30 minute intervals. If calibration is disabled, the operator prompt CALIBRATION DISABLED is displayed when calibration is necessary.

SINGLE CAL The SINGLE CAL (single calibration) softkey initiates a single calibration cycle on the -hp-3561A.

COUPLE AC DC The COUPLE AC DC softkey selects AC or DC input coupling. AC coupling inserts a series capacitor into the -hp-3561A input circuits. The capacitor removes dc signals and drifts associated with dc from the input signal. The AC COUPLE indicator illuminates to indicate ac coupling is selected.

A WT FLT ON OFF The A WT FLT ON OFF (A-weighting filter on off) softkey enables or disables filtering of the input signal with the -hp-3561A A-weighting filter. The A-weight filter conforms to ANSI Standard S1.4-1971. The A WT FILTER indicator illuminates to indicate that the A-weighting filter is selected.

ICP CURR ON OFF The ICP CURR ON OFF (ICP current on off) softkey enables or disables the ICP (Integrated Circuit Piezo-electric) current source. Selecting ICP CURR ON connects the -hp-3561A internal 4 milliamp current source to the input connector. The nominal voltage output is 24 volts dc (open circuit voltage). The ICP CURRENT indicator illuminates to indicate that the ICP current source is enabled.

CAL SIG ON OFF The CAL SIG ON OFF (calibrator signal on off) softkey enables or disables display of the internal calibration signal. The INPUT connector is disconnected from the input circuits when display of the calibrator signal is enabled.

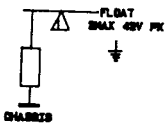

The chassis ground switch connects the input circuit ground reference to chassis ground or isolates (floats) it from chassis ground.



The input connector provides a high impedance input (1 MΩ) to the -hp-3561A. Up to 42 volts peak may be applied to the input connector.

WARNING

Do not isolate the -hp-3561A from earth ground by interrupting the protective earth conductor inside or outside the -hp-3561A. Interruption of the protective earth conductor can subject the operator to lethal voltages.

REAR PANEL CONNECTORS

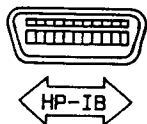
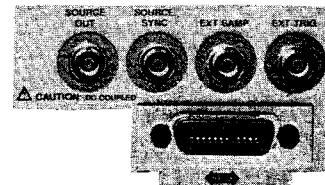
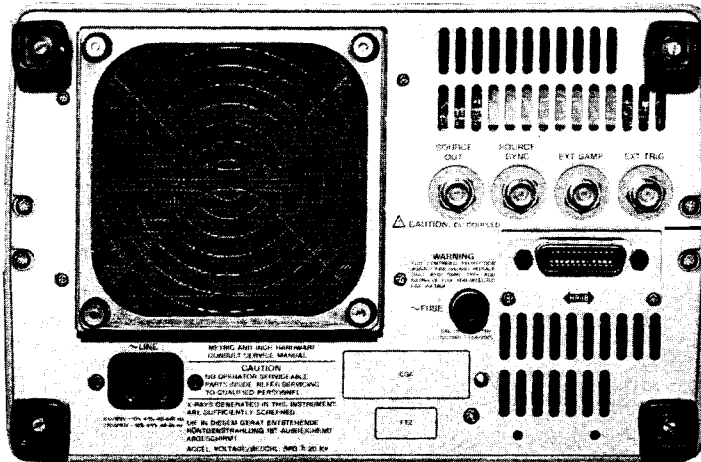

External HP-IB devices are connected to the -hp-3561A with the rear panel HP-IB connector. The -hp-3561A, in addition to being controlled by an external controller, can directly plot an image of the display trace to an external Hewlett-Packard graphics language printer or plotter through this connector. The HP-IB address is entered with the front panel

LCL key DEFINE ADDRESS softkey and is retained in nonvolatile memory.

EXT SAMPLE



The EXT SAMPLE input is TTL compatible.

The -hp-3561A sampling frequency is controlled through the EXT SAMPLE connector when the external sampling mode is enabled through the MODE key. The EXT

EXT TRIG

External trigger sources are connected to the -hp- 3561A through the EXTERNAL TRIGGER input connector. The -hp-3561A senses this connector when EXTERNAL TRIGGER is selected in the TRIG SEL key menu. The trigger input is TTL compatible.

**SOURCE
OUT**

The SOURCE OUTPUT connector is the output port for the - hp-3561A noise source or impulse generator. This 50 Ω output is enabled with the SOURCE key menu.

**SOURCE
SYNC**

A positive SOURCE SYNC output marks the start of each time record coinciding with an impulse or pseudo-random noise output. If the trigger is derived from the internal noise source or impulse generator, this output is synchronized to the source trigger signal. The SOURCE SYNC output is a TTL level pulse.

CHAPTER III

HP-IB OPERATION	101
Description of the HP-IB	101
-hp-3561A HP-IB Capability	102
Talk/Listen Addresses	102
Viewing the -hp-3561A HP-IB Address	103
Changing the -hp-3561A HP-IB Address	104
Selecting the Talk Only Mode	104
Bus Messages	104
Service Request	107
The Status Word	107
Masking the Status Word	109
Trigger	109

CHAPTER III

HP-IB OPERATION

DESCRIPTION OF THE HP-IB
-hp-3561A HP-IB CAPABILITY
TALK/LISTEN ADDRESSES
VIEWING THE -hp-3561A HP-IB ADDRESS
CHANGING THE -hp-3561A HP-IB ADDRESS
SELECTING THE TALK ONLY MODE
BUS MESSAGES
SERVICE REQUEST
THE STATUS WORD
MASKING THE STATUS WORD
TRIGGER

CHAPTER III

HP-IB OPERATION

The Hewlett Packard Interface Bus (HP-IB) is a bus structure that links the -hp-3561A to desktop computers, minicomputers, and other HP-IB controlled instruments to form automated measurement systems. The HP-IB is Hewlett-Packard's implementation of the IEEE Standard 488-1978, ANSI Standard MC 1.1 and IEC Recommendation 625-1. The HP-IB commands specifically intended for the -hp-3561A HP-IB operation are listed and described in Chapter IV.

DESCRIPTION OF THE HP-IB

All of the active HP-IB interface circuits are contained within the various HP-IB controlled devices. The interconnecting cable is entirely passive and its role is limited to connecting the devices in parallel so that data can be transferred from one device to another.

Every participating device must be able to perform at least one of the following roles: talker, listener, or controller. A talker transmits data to other devices called listeners. Most devices can perform both roles, but not at the same time. A controller manages the operation of the bus system by designating which device is to talk and which devices are to listen at any given time. The -hp-3561A can be either a talker or a listener.

The minimum HP-IB system consists of one talker and one listener without a controller. In this configuration, data transfer is limited to one direction because one device must be manually set to TALK ONLY and the other device must be manually set to LISTEN ONLY. The -hp-3561A can be set to talk only for plotting the display on a plotter or graphics printer.

The full flexibility and power of the HP-IB is realized when a controller is added to the system. An HP-IB controller participates in the measurement by being programmed to automate, monitor, and coordinate instrument operation as well as process the measurement results.

Table 3-1. HP-IB Specification Summary

Number of Interconnected Devices:	Up to 15 maximum on one contiguous bus.
Interconnection Path/Maximum Cable Length:	Star or linear bus network. Total transmission path length = 2 meters times number of devices, or 20 meters, whichever is less, with a maximum of 3 meters separating any two devices.
Message Transfer Scheme:	Byte-serial, 8 bit-parallel asynchronous data transfer using a 3 wire handshake.
Data Rate:	One megabyte per second (maximum) over limited distances, actual data rate depends upon the capability of the slowest device involved in the transmission.
Address Capability:	Primary addresses: 31 talk, 31 listen. 1 Talker and 14 listeners, maximum at one time. (The -hp-3561A does not have secondary, extended address capability.)
Multiple Controller Capability:	In systems with more than one controller, only one can be active at a time. The active controller can pass control to another controller, but only the system controller can assume unconditional control. Only one system controller is allowed.
Interface Circuits:	Driver and receiver circuits are TTL compatible.

-hp-3561A HP-IB CAPABILITY

The -hp-3561A interfaces to the HP-IB as defined by IEEE Standard 488-1978. The interface functional subset which the -hp-3561A implements is specified in Table 3-2.

Table 3-2. -hp-3561A HP-IB Capability

Code	Function
SH1	Complete Source Handshake capability
AH1	Complete Acceptor Handshake capability
T5	Basic Talker; unaddress if My Listen Address (MLA); Talk Only
TE0	No Extended Talker capability
L4	Basic Listener; unaddress if My Talk Address (MTA)
LE0	No Extended Listener capability
SR1	Complete Service Request capability
RL1	Complete Remote/Local capability
PP0	No Parallel Poll capability
DC1	Complete Device Clear capability
DT1	Complete Device Trigger capability
C0	No Controller capability

TALK/LISTEN ADDRESSES

Each HP-IB device has at least one talk and listen address (unless totally transparent, or a talk only or listen only device). Device addresses are used by the active controller in the COMMAND MODE (ATN true) to specify the talker (via a talk address) and the listener (via listen addresses). There may be only one talker addressed by the controller to talk at any time.

The address of a device is usually preset at the factory and is reset during system configuration. In the binary representation of the address, the device address is the

decimal equivalent of the five least significant bits of the address. (On HP-IB devices with selector switches, these are the five address switches.) The address can be from 0 to 30 inclusive. The sixth and seventh bits determine if the address is a talk or listen address. High level HP-IB drivers typically configure these two bits automatically. Table 3-3 lists the HP-IB addresses if a controller requires the talk and listen addresses.

Table 3-3. HP-IB Addresses

DEVICE	TALK	LISTEN
0	@	SP
1	A	!
2	B	"
3	C	#
4	D	\$
5	E	%
6	F	&
7	G	'
8	H	(
9	I)
10	J	*
11	K	+
12	L	,
13	M	-
14	N	.
15	O	/
16	P	0
17	Q	1
18	R	2
19	S	3
20	T	4
21	U	5 ← (usually the controller)
22	V	6
23	W	7
24	X	8
25	Y	9
26	Z	:
27	[;
28	\	<
29]	=
30	~	>

The talk and listen addresses fall within the printable ASCII character set. When a device receives one of these characters while ATN is true, it becomes addressed. The ASCII character "?" unaddresses all devices. The device address (set from the -hp-3561A front panel) is used by HP-IB controllers most of which automatically send the talk and listen address characters.

VIEWING THE -hp-3561A HP-IB ADDRESS

The HP-IB address of the -hp-3561A is stored in a nonvolatile memory (there are no address switches). The -hp-3561A address appears in the upper left corner of the display when the the LCL key in the HP-IB key group is pressed.

CHANGING THE -hp-3561A HP-IB ADDRESS

Every device on the HP-IB must have a unique address. The -hp-3561A address can be set at any address between 0 and 30, inclusive. The -hp-3561A HP-IB address is stored in the -hp-3561A nonvolatile memory. When selecting an address, remember that the controller also has an address (usually 21). To change the HP-IB address:

- Press the LCL key in the HP-IB key group to display the LCL key menu. The current HP-IB address appears in the upper left corner of the display.
- Press the up or down arrow key to select address or enter the new address directly with the numeric keypad. Notice the address in the display is updated to reflect the address being entered.
- For values entered with the numeric keypad, terminate the entry with the ENTER softkey that appears after the first key is pressed.

SELECTING THE TALK ONLY MODE

Press the LCL key in the HP-IB key group to display the LCL key menu. Press the key corresponding to the TLK ONLY ON OFF softkey to intensify the ON portion of the label annotation.

BUS MESSAGES

The HP-IB interface system operates in either of two modes: command mode (ATN bus management line true) or data mode (ATN bus management line false). If an -hp- controller is used, the bus management lines are configured automatically and all necessary command strings are issued.

In the command mode, devices on the HP-IB can be addressed or unaddressed as listeners or talkers. Bus commands are also issued in the command mode. These commands may instruct the HP-IB interface to control the instrument (like CLEAR or TRIGGER) but are more often used for bus management (REMOTE, LOCAL, POLLs, SERVICE REQUEST, ABORT interface activity, or PASS CONTROL). Bus commands are issued through one of the bus management lines or through the eight bit data bus. Table 3-4 lists the commands used in the command mode.

In the data mode, data or instructions are transferred between instruments on the HP-IB. Instructions transferred to the instrument are called device dependent commands. All the commands specifically for the -hp-3561A fall into this category. The -hp-3561A device dependent commands configure the -hp-3561A, initiate measurements, initiate data transfers, or define error reporting conditions. These device dependent commands are meaningless for other instruments. The -hp-3561A device dependent commands are listed in Chapter IV. The device dependent commands may be sent to the -hp-3561A through the use of the BASIC command OUTPUT as shown in the following examples for the -hp- Series 200 computers:

OUTPUT 711;"MAXS;"	(MAXimum Stop frequency)
OUTPUT 711;"NABM;"	(NARrow Band Mode)
OUTPUT 711;"SF2KHZ;"	(Start Freq set to 2 kHz)
OUTPUT 711;"SP10KHZ;"	(SPan set to 10kHz)
OUTPUT 711;"NABM;FLAT;AVRS;MAXS;PHS;"	(NABM = NARrow band Mode, FLAT = FLAT top window, AVRS = RmS AVeraging, MAXS = MAX Span, PHS = PHaSe trace).

In these examples, 711 is the device selector. The 11 represents the -hp-3561A address that is set through the LCL key. The 7 represents the HP-IB interface select code of the controller.

Table 3-4. HP-IB Control Commands

ABORT I/O	This statement halts all HP-IB activity. The system controller assumes unconditional control of the bus. The -hp-3561A becomes unaddressed.
	Example for Series 200 Computers:
	ABORT 7
CLEAR	CLEAR causes all devices addressed to listen to reconfigure to a predefined device-dependent condition. The -hp-3561A responds to the CLEAR message by clearing the interface command buffer and any pending commands, clearing the SRQ register and error register, and aborting plots.
	Examples for Series 200 Computers:
	CLEAR 7 (clears all devices on I/O port 7)
	CLEAR 711 (clears device addressed 11 on I/O port 7)
CLEAR LOCKOUT/SET LOCAL	This message removes all devices from the local lockout mode and returns the -hp-3561A to local (front panel) control. The only difference in form between this bus message and the LOCAL message is addressing.
	Example for Series 200 Computers:
	LOCAL 7 (Clears LOCAL LOCKOUT)
LOCAL	LOCAL clears the REMOTE message from the listening device and returns the device to local (front panel) control. The RMT LED on the front panel extinguishes if the instrument is in REMOTE prior to the LOCAL command.
	Example for Series 200 Computers:
	LOCAL 711 (Local lockout still active if returned to REMOTE)

LOCAL LOCKOUT	<p>LOCAL LOCKOUT disables the LCL front panel key of all devices on the port to avoid operator interference.</p> <p>Example for Series 200 Computers:</p> <p style="padding-left: 40px;">LOCAL LOCKOUT 7</p>
PARALLEL POLL	<p>Parallel POLL is a controller operation used to obtain information from the devices under its control. The -hp-3561A does not respond.</p>
PASS CONTROL	<p>This message shifts system control from one controller to another. The -hp-3561A does not respond.</p>
REMOTE	<p>REMOTE directs an instrument to take instructions from the bus. When the -hp-3561A accepts the remote command, the RMT front panel LED illuminates and the front panel is disabled except for the LCL key. If LOCAL LOCKOUT is issued, REMOTE cannot be changed to LOCAL from the front panel.</p> <p>Examples for Series 200 Computers:</p> <p style="padding-left: 40px;">REMOTE 711 (switches device addressed 11 from local to remote)</p>
SERIAL POLL	<p>The command SPOLL requests that the -hp-3561A send its status word. Encoded in the eight bits are the states of several -hp-3561A operating parameters (see the Status Word). The byte returned is put into the variable specified by the command as below:</p> <p>Example for Series 200 Computers:</p> <p style="padding-left: 40px;">Var=SPOLL(711)</p> <p style="padding-left: 40px;">IF Var THEN. . .</p>
SERVICE REQUEST	<p>The SRQ (service request) bus management line is used by a device to indicate the need for attention from the controller. When the -hp-3561A issues an SRQ it also sets bit six of the status word (see the Status Word) and illuminates the front panel SRQ LED.</p>
TRIGGER	<p>When the -hp-3561A is in the HP-IB trigger mode, the -hp-3561A responds to the command TRIGGER as it would to any other external trigger. The HP-IB trigger mode is enabled with the HPT HP-IB command.</p> <p>Examples for Series 200 Computers:</p> <p style="padding-left: 40px;">TRIGGER 7</p> <p style="padding-left: 40px;">TRIGGER 707</p>

SERVICE REQUEST

One of the five bus management lines connected to every device on the bus (along with eight data lines and three handshake lines) is the SRQ line. It is used by a device to indicate the need for attention from the controller. When the -hp-3561A issues an SRQ it also sets bit six of the status word. Bit six is the require service bit and is sometimes referred to as the status bit in connection with a poll.

When the controller senses an SRQ, it can poll each device to find the device requiring service. A serial poll is used to obtain the status word of each device one device at a time. After the -hp-3561A replies to a poll, the -hp-3561A clears bit six along with the SRQ line. Any bit in the status word may initiate an SRQ. The status word may be masked to select which bits cause the -hp-3561A to set the SRQ line.

THE STATUS WORD

The status word is an eight bit word that the -hp-3561A outputs when requested by a serial poll. The state of each bit indicates the status of an internal -hp-3561A function (see Table 3-5). Each bit in the status word follows the condition that it is representing. The status word bits are also latched in the RSRQ register and are read with the RSRQ command. A service request is generated when any bit in the status word becomes set.

Example for Series 200 computers: Var=SPOLL(711)

Any status bit that is enabled will cause an SRQ (and set bit six) when the condition it represents changes from false to true. An SRQ is also generated when the bit is first enabled to set the SRQ bit and it is true. As long as the condition is true, the bit will stay set. Any status bit that is disabled will follow the condition it represents, resetting whenever the condition clears.

Table 3-5. -hp-3561A Status Word

BIT POSITION	VALUE	DESCRIPTION
7	128	POWER ON. Set when power is applied to the -hp-3561A. Reset by reading the SRQ word. This bit is enabled or disabled from setting the SRQ line and bit 6 only with the PwrOnSRQ ON OFF softkey or the PSRQ ON/OFF HP-IB command.
6	64	REQUIRE SERVICE. Set when the -hp-3561A requires service (sent an SRQ). Cleared along with the SRQ line when a serial poll is performed or the service request register is read with the RSRQ command.
5	32	ERROR. This bit reflects an error condition in the -hp-3561A. Reset when the error register is read with the ERR? HP-IB command.
4	16	READY. Set when the -hp-3561A has processed the last HP-IB command and is ready for the next command. Cleared after the first byte of a command is received. This bit is cleared by the RST command and is not set until after the -hp-3561A is reset.
3	8	FRONT PANEL STATUS. Set when a key is pressed and key echo is enabled (HP-IB command KEYE). This bit is cleared when the key buffer is read with key echo. Reset the SRQ with RSRQ or a serial poll after reading the key buffer.
2	4	OVERLOAD. Set when an overload is sensed. Cleared when the overload condition is no longer present.
1	2	TRIGGER. Set when a trigger is detected. Reset when the -hp-3561A is armed to receive a trigger.
0	1	MEASUREMENT DONE. Set when a measurement is complete. Cleared when a measurement is started.

Status Word Bit Numbers B7 B6 B5 B4 B3 B2 B1 B0

MASKING THE STATUS WORD

Masking the status word enables or disables setting the SRQ by the individual bits in the status word. The SRQ mask is loaded by sending SRQM followed by the mask. The mask is a number that represents the weighted sum of the binary bits that are enabled. The mask bit definition corresponds to the status word. Setting the mask equal to 32 enables setting of the require service bit by the error bit (See Table 3-5). Setting the mask to 48 (16 plus 32) enables the error and ready bits to set the require service bit. Disabling a bit from setting the SRQ also clears the SRQ set by that bit. The power on bit is maskable only with the PwronSRQ ON OFF softkey or PSRQ ON/OFF HP-IB command. The mask status of the power on bit is retained in nonvolatile memory.

TRIGGER

When the -hp-3561A is in the HP-IB trigger mode, the -hp-3561A responds to the command TRIGGER as it would to any other external trigger. The HP-IB trigger mode is enabled with the HPT HP-IB command. This statement is sent to either a selected device or all devices addressed to listen on the HP-IB. A device must be in the LISTEN mode before the trigger message is sent.

Examples for Series 200 Computers:

TRIGGER 7 Trigger all on 7

TRIGGER 711 -hp-3561A only

CHAPTER IV

HP-IB COMMANDS	111
Remote Front Panel Operation	112
Command Syntax	112
Viewing the -hp-3561A HP-IB Address	113
Setting the -hp-3561A HP-IB Address	113
Front Panel Key Detection/Control	113
Displaying Setup Parameters on the -hp-3561A CRT	115
Reading and Setting the Marker	115
Display Control	116
Plot Control	117
Displaying Menus and HP-IB Commands	117
Reading and Masking the Status Word/Error Codes	118
Saving or Restoring an Instrument Setup	119
Reading and Interpreting the Setup State	120
-hp-3561A Identification	124
Accessing Data from the -hp-3561A	124
ASCII Data Transfers	125
Binary Data Transfers	126
Reading Trace Data	127
Reading Data Headers	129
Reading from and Writing to the Time Buffer	134

CHAPTER IV

HP-IB COMMANDS

REMOTE FRONT PANEL OPERATION

COMMAND SYNTAX

VIEWING THE -hp-3561A HP-IB ADDRESS

SETTING THE -hp-3561A HP-IB ADDRESS

FRONT PANEL KEY DETECTION/CONTROL

DISPLAYING SETUP PARAMETERS ON THE -hp-3561A CRT

READING AND SETTING THE MARKER

DISPLAY CONTROL

PLOT CONTROL

DISPLAYING MENUS AND HP-IB COMMANDS

READING AND MASKING THE STATUS WORK/ERROR CODES

SAVING OR RESTORING AN INSTRUMENT SETUP

READING AND INTERPRETING THE SETUP STATE

-hp-3561A IDENTIFICATION

ACCESSING DATA FROM THE -hp-3561A

ASCII DATA TRANSFERS

BINARY DATA TRANSFERS

READING TRACE DATA

READING DATA HEADERS

READING FROM AND WRITING TO THE TIME BUFFER

CHAPTER IV HP-IB COMMANDS

This chapter has been extensively revised from the HP-IB Commands chapter in the first edition of the 3561A Dynamic Signal Analyzer Operating Manual (-hp- Part Number 03561-90001). This revised chapter includes more example programs and information on reading and interpreting the instrument setup information in trace and buffer headers.

Sections added to this chapter are:

- Reading and Interpreting the Setup State
- Accessing Data from the -hp-3561A
- Binary Data Transfers
- Reading Trace Data
- Reading Data Headers
- Reading from and Writing to the Time Buffer

The following tables were also added to this chapter:

- An alphabetical listing of HP-IB commands
- Definitions of setup state data
- Definitions of trace header data
- Definitions of buffer header data

The commands for operating the -hp-3561A through the HP-IB are listed in this chapter. Two complete listings of the -hp-3561A commands are located at the end of the chapter. Table 4-6 lists the commands by group of operations; Table 4-7 lists the commands alphabetically. This chapter describes commands used exclusively for HP-IB operation. Chapter II describes commands that can also be executed from the front panel.

All example programs in this chapter use the -hp-9000 series 200 computer and the enhanced BASIC 2.1 programming language.

REMOTE FRONT PANEL OPERATION

The Command List in Table 4-7 specifies all of the commands available for -hp-3561A remote programming via the HP-IB. Note that many of the functions are the remote equivalent of manually pressing a front panel key and are executed in similar sequences.

The HP-IB RMT (remote) status light, located in the HP-IB key group on the right side of the front panel, indicates whether the instrument is currently operating under local (front panel control) or remote control. Remote operation is accomplished only via commands transmitted through the HP-IB.

When the instrument is in local, the operation is determined solely by front panel key closures. When the -hp-3561A is programmed to remote, operation remains exactly the same as it was in local. Additional commands sent over the HP-IB can change the mode of operation. Returning to local, either by pressing the LCL key (if local lockout is not in effect) or by an HP-IB command, causes the instrument to return to front panel control.

COMMAND SYNTAX

The commands in Table 4-6 are divided into groups of operations. Each HP-IB command is listed with a corresponding front panel key and menu entry. Commands that require values and a suffix show the applicable range limits and suffix.

The ON, OFF, AC, DC, FAST, SLOW, POS and NEG suffixes do not require a numeric entry.

The following conventions apply to -hp-3561A HP-IB commands transmitted over the HP-IB:

- Spaces within and between commands are ignored but spaces in numbers and alphanumeric strings are not ignored.
- Lower case letters are changed to upper case.
- Separators are required between commands. The primary separator is the semicolon, but the line feed character is also accepted.

- The last character transmitted in an HP-IB command string needs to be followed by a separator. Many controllers, such as the -hp- 9000 series 200 computers, automatically add the line feed when the BASIC language OUTPUT command is used. Use of the OUTPUT statement is illustrated in the following example, which sets the -hp-3561A span to 10 kHz:

```
OUTPUT 711;"SP10KHZ;"
```

VIEWING THE -hp-3561A HP-IB ADDRESS

The HP-IB address of the -hp-3561A is set to 11 at the factory and stored in a non-volatile memory (there are no address switches). To display the -hp-3561A address, press the LCL key in the HP-IB key group. The current address will appear in the upper left of the display. The example programs in this chapter use 11 as the default -hp-3561A address.

SETTING THE -hp-3561A HP-IB ADDRESS

Every device on the HP-IB must have a unique address. The -hp-3561A address can be set at any address between 0 and 30, inclusive. When choosing an address, remember that the controller also has an address (usually 21). To change the HP-IB address:

- Press the LCL key in the HP-IB key group to display the LCL key menu. The current HP-IB address appears in the upper left corner of the display.
- Press the up or down arrow key to select an address, or enter a new address directly with the numeric keypad. Notice the address in the display is updated to reflect the address being entered.
- For values entered with the numeric keypad, terminate the entry with the ENTER softkey that appears after the first key is pressed.

The -hp-3561A HP-IB address is stored in a nonvolatile memory. If the contents of this memory location are destroyed, the HP-IB address defaults to 11.

FRONT PANEL KEY DETECTION/CONTROL

The -hp-3561A can be monitored via the HP-IB, and any front panel key closures can be sensed by the controller. When a key is pressed, it is entered into a key register which may be polled. If the key register is full, the key closure is ignored. Keys entered in the key register are not executed by the -hp-3561A when the analyzer is in remote (HP-IB) operation. The following commands handle key sensing:

KEYD. The Key disable command disables sensing of the front panel keys with exception of the LCL key. (The LCL key can be disabled by executing a local lockout command to the analyzers address.) This command clears the front panel status bit of the status word and the key register. KEYD is the default PRE-SET and power up condition.

KEYE. The Key enable command enables sensing of front panel keys. When a key is pressed, its code is loaded into the key register and bit 3 of the status word is set.

KEY? The -hp-3561A key register is read with the KEY? command. Tables 4-1 and 4-2 lists the codes for all of the keys.

RFGS. This command reads the float/ground switch setting. A grounded position returns a zero while a floating position returns a one.

Program segment 4-1 illustrates the use of the KEYE and KEY? commands; the key codes are listed numerically in Table 4-1 and alphabetically in Table 4-2.

Program 4-1. Senses front panel key closures using key polling commands KEYE and KEY?.

```

OUTPUT 711;"KEYE;"      ! Enable -hp-3561A key echo
OUTPUT 711;"KEY?;"     ! -hp-3561A to list key
ENTER 711;Key          ! Input key code
IF Key=0 THEN         ! Simple key decoder
  PRINT "Buffer empty"
ELSE
  PRINT "Key = ";Key
END IF

```

Table 4-1. Numeric Listing of Front Panel Key Codes.

Key Name	Key Code	Key Name	Key Code
BUFFER EMPTY	00	FAST RIGHT	32
SOFTKEY 7	01	FAST LEFT	33
SOFTKEY 6	02	0	34
SOFTKEY 5	03	1	35
SOFTKEY 4	04	4	36
SOFTKEY 3	05	7	37
SOFTKEY 2	06	WINDOW	38
SOFTKEY 1	07	AVG	39
RECALL	08	NOT USED	40
SAVE	09	NOT USED	41
RIGHT ARROW	10	(SPACE)	42
FAST	11	2	43
LEFT ARROW	12	5	44
SCALE	13	8	45
DEFINE TRACE	14	SOURCE	46
NEXT TRACE	15	TIME BUFFER	47
PRESET	16	NOT USED	48
VIEW ON/OFF	17	NOT USED	49
REL MKR	18	NOT USED	50
SPCL MKR	19	3	51
MKR	20	6	52
FORMAT	21	9	53
UNITS	22	START	54
STORE/LABEL	23	PAUSE/CONT	55
RETURN	24	INPUT	56
NOT USED	25	RANGE	57
BACK SPACE	26	NOT USED	58
MKR VAL	27	NOT USED	59
DOWN ARROW	28	PLOT	60
UP ARROW	29	LCL	61
FREQ	30	ARM	62
MODE	31	TRIG	63

Table 4-2: Alphabetic Listing of Front Panel Key Codes.

Key Name	Key Code	Key Name	Key Code
ARM	62	SOFTKEY 1	07
AVG	39	SOFTKEY 2	06
BUFFER EMPTY	00	SOFTKEY 3	05
BACK SPACE	26	SOFTKEY 4	04
DEFINE TRACE	14	SOFTKEY 5	03
DOWN ARROW	28	SOFTKEY 6	02
FAST	11	SOFTKEY 7	01
FAST LEFT	33	SOURCE	46
FAST RIGHT	32	(SPACE)	42
FORMAT	21	SPCL MKR	19
FREQ	30	START	54
INPUT	56	STORE/RECALL	23
LCL	61	TIME BUFFER	47
LEFT ARROW	12	TRIG SEL	63
MKR	20	UNITS	22
MKR VAL	27	UP ARROW	29
MODE	31	VERT SCALE	13
NEXT TRACE	15	VIEW ON/OFF	17
NOT USED	25, 40, 41, 48 49, 58, 59	WINDOW	38
PAUSE/CONT	55	0	34
PLOT	60	1	35
PRESET	16	2	43
RANGE	57	3	51
RECALL	08	4	36
REL MKR	18	5	44
RETURN	24	6	52
RIGHT ARROW	10	7	37
SAVE	90	8	45
SCALE	13	9	53

DISPLAYING SETUP PARAMETERS ON THE -hp-3561A CRT

The current value of a softkey is displayed in the entry area of the display if the softkey HP-IB mnemonic is sent followed by the corresponding menu mnemonic. For example, sending the mnemonics CF and FREQ displays the center frequency value in the upper left corner of the display. Sending the CF mnemonic does not change the present center frequency value. For the -hp- series 200 computer, the following program line displays the center frequency value:

```
OUTPUT 711;"CF; FREQ;"
```

READING AND SETTING THE MARKER

RDMK. The marker position is read with the read marker command. Four variables are required in a program to accept the marker values. The marker values are transferred in the form of

```
NE±NN, NE±NN, NE±NN, I CRLF
```

where NE±NN is a floating point number and I is an integer. The three floating point values correspond to the horizontal axis coordinate, the vertical axis coordinate, and the special marker computation respectively. Each value contains up to 20 characters. If a marker is not active, 1.E+37 is transmitted for marker value. The integer corresponds to a measurement overload on the active trace. A 0 indicates no overload while 1 indicates an overload.

NOTE

Normally the exponent transmitted for the marker values is a one or two digit number. However, three digit exponents can be generated through the use of math functions. These three digit exponents will cause an exponent overflow error on some controllers or calculators.

MVMK. The marker position command MVMK is combined with a marker position number (1 through 401 for narrowband, 0 through 11 for full octave, and 0 through 33 for third octave) to move the marker to a distinct horizontal position on the display.

MMKP. The marker position command MMKP is combined with a frequency or time value and unit to move the marker to a horizontal position on the display.

MMLF. The marker position command MMLF moves the marker one screen position to the left.

MMRT. The marker position command MMRT moves the marker one screen position to the right.

Program segment 4-2 illustrates use of the MMKP and RDMK commands.

Program 4-2. Moves and reads marker using commands MMKP and RDMK.

```
OUTPUT 711;"MMKP 25KHZ;"&! Move marker to 25 kHz
OUTPUT 711;"RDMK"&! -hp-3561A to dump marker
ENTER 711;X,Y,S,O&! Read marker values
PRINT "X POSITION ",X&! Print marker values
PRINT "Y POSITION ",
PRINT "SPECIAL MARKER ",S
PRINT "OVERLOAD STATUS ",O
```

DISPLAY CONTROL

HP-IB commands for the display enable control of the display functions, annotation of the display, and graphics control of the display. These functions are not available with the front panel keys.

CRTP. The CRTP (CRT print) command writes alphanumeric characters on the display. The command has the form CRTP ROW, COLUMN "MESSAGE" where ROW is the starting display row with a range of 1 to 26 and COLUMN is the starting column with a range of 1 to 72. The INDD command can prevent messages written on the display from being destroyed by trace and annotation updates.

SFBP. The SHBP (select full bright plane) command enables a full intensity display mode for the CRTP command.

SHBP. The SHBP (select half bright plane) command enables a low intensity display mode for the CRTP command.

INDD. The INDD (instrument display disable) command inhibits the -hp-3561A from updating the display. The display is returned to normal with the INDE command.

INDE. The INDE (instrument display enable) command clears the display then restores the display to normal operation. Normal display is enabled automatically when the -hp-3561A is returned to the local mode.

CRTC. The CRTC (CRT clear) command clears the display.

CRCN. The CRCN (CRT control) command enables or disables power to the display. CRCN ON enables the display, and CRCN OFF disables the display.

Program segment 4-3 disables display updates and prints "HP 3561A DYNAMIC SIGNAL ANALYZER" on the full bright display plane.

Program 4-3. Prints to the -hp-3561A display using commands INDD, SFBP, and CRTP.

```
OUTPUT 711;"INDD;"      !Disable display updates
OUTPUT 711;"SFBP;"      !Select full bright plane
                        !
OUTPUT 711;"CRTP 6,18,""HP 3561A DYNAMIC SIGNAL ANALYZER""
```

PLOT CONTROL

Plotting or printing of the display is accomplished with the PLT and PLCP HP-IB commands. These two commands correspond to the PLOT and COPY TO PRINTER softkeys. The -hp-3561A activities are dedicated to transferring the data necessary to generate the plot after either of these commands is issued. The -hp-3561A sets the HP-IB EOI bus management when the plot is complete. A plot is aborted by issuing a command to the -hp-3561A.

Program 4-4 plots the -hp-3561A display to a plotter at HP-IB address 5.

Program 4-4 Plots the current -hp-3561A display to a plotter using the PLT command.

```
OUTPUT 711;"PLT;"      ! -hp-3561A to plot
SEND 7;UNL UNT         ! Unlisten Untalk
SEND 7;TALK 11         ! -hp-3561A to talk
SEND 7;LISTEN 5 DATA ! Plotter to receive data
PAUSE                  ! Wait for HP-IB bus to clear
```

DISPLAYING MENUS AND HP-IB COMMANDS

DIAG. The diagnostics ON/OFF command enables or disables the display of the menus and HP-IB commands. The last 49 characters received via the HP-IB are displayed when the diagnostics mode is enabled. When the diagnostics mode is enabled, the HP-IB handshake speed is reduced to provide time to read the HP-IB commands as they are displayed. Normal operation of the -hp-3561A is with diagnostics disabled.

NOTE

The RMT indicator on the -hp-3561A can be used for a quick operational check of the HP-IB. Refer to the Controller Operating Manual and find the section describing the HP-IB REMOTE Message. When this message is sent to the -hp-3561A, the RMT indicator should illuminate. If this does not occur, check the cabling, the -hp-3561A address, and the syntax of the controller statement. An example of the REMOTE Message as implemented by -hp-Series 200 computers is REMOTE 711.

READING AND MASKING THE STATUS WORD/ERROR CODES

The status word is an eight bit word that the -hp-3561A outputs when requested by a serial poll or the RSRQ command (see Table 4-3). The state of each bit indicates the status of an internal -hp-3561A function. A service request is generated when any unmasked bit in the status word becomes set.

Table 4-3. -hp-3561A Status Word Definition

BIT POSITION	VALUE	DESCRIPTION
7	128	POWER ON. Set when power is applied to the -hp-3561A. Reset by reading the SRQ word. This bit is enabled or disabled from setting the SRQ line and bit 6 only with the PwronSRQ ON/OFF softkey or the PSRQ ON/OFF HP-IB command.
6	64	REQUIRE SERVICE. Set when the -hp-3561A requires service (sent an SRQ). Cleared along with the SRQ line when a serial poll is performed or the service request register is read with the RSRQ command.
5	32	ERROR. This bit reflects an error condition in the -hp-3561A. Reset when the error register is read with the ERR? HP-IB command.
4	16	READY. Set when the -hp-3561A has processed the last HP-IB command and is ready for the next command. Cleared after the first byte of a command is received. This bit is cleared by the RST command and is not set until after the -hp-3561A is reset.
3	8	FRONT PANEL STATUS. Set when a key is pressed and key echo is enabled (HP-IB command KEYE). This bit is cleared when the key buffer is read with the KEY? HP-IB command or the KEYD command disables the key echo. Reset SRQ with RSRQ or a serial poll after reading the key buffer.
2	4	OVERLOAD. Set when an overload is sensed. Cleared when the overload condition is no longer present.
1	2	TRIGGER. Set when a trigger is detected. Reset when the -hp-3561A is armed to receive a trigger.
0	1	MEASUREMENT DONE. Set when a measurement is complete. Cleared when a measurement is started.

Status Word Bit Numbers B7 B6 B5 B4 B3 B2 B1 B0

RSRQ. The read SRQ command transmits the contents of the status word request register and resets the request register. The status word request register provides a latched representation of the status word when an SRQ occurs (see Table 4-3). When the status word request register is read, the SRQ bit of the status word is reset. The integer number transmitted is the sum of the weighted bits of the status word.

ERR?. The ERR? command transmits the code for the last error that occurred and resets the error register and error bit in the status word. Appendix B lists the error code definitions.

SRQM. The set request mask enables or disables setting the SRQ by individual bits of the status word (see Table 4-3). The SRQ mask is loaded by sending SRQM followed by the mask. The mask is a number that represents the weighted sum of the binary bits that are enabled. The mask byte definition corresponds to the status byte. Setting the mask equal to 32 enables setting of the require service bit by the error bit. Setting the mask to 48 (16 plus 32) enables the error and ready bits to set the require service bit. The power on bit is maskable only with the PwronSRQ ON/OFF softkey or PSRQ ON/OFF HP-IB command.

PSRQ. The power on SRQ command enables or disables sending a power on SRQ by the -hp-3561A. ON or OFF is used to enable or disable the power on SRQ.

Program 4-5 illustrates how the SRQ mask can be set and the -hp-3561A instructed to interrupt after every measurement is complete.

Program 4-5. Sets the SRQ mask using SRQM and RSRQ commands.

```

ASSIGN @Anz TO 711           ! Create a path to 3561A, address 11
ASSIGN @Fast TO BUFFER [1028];FORMAT OFF
ON INTR 7,2 GOSUB Readit
ENABLE INTR 7;2             ! Enable HP-IB interface to generate
                             ! SRQ interrupt
OUTPUT 711;"SRQM1"          ! Set SRQ mask to allow only
                             ! measurement done bit to set SRQ
OUTPUT 711;"RSRQ"          ! Clear any current SRQ
!-----
Waitt:GOTO Waitt
!-----
Readit:                      !
!-----
Poll=SPOLL(@Anz)           ! Serial poll of 3561A
OUTPUT @Anz;"SRQM0"        ! Clear SRQ mask
OUTPUT @Anz;"DSTB"         ! Dump active trace and header
TRANSFER @Anz TO @Fast;COUNT 1028
ENABLE INTR 7
OUTPUT @Anz;"SRQM1"        ! Set SRQ mask to allow only
                             ! measurement done bit to set SRQ

RETURN

```

SAVING OR RESTORING AN INSTRUMENT SETUP

SET. The SET command causes binary setup state data to be loaded into the -hp-3561A. The new state is set after the last data word is received. Data loaded into the -hp-3561A must be data output by the SET? command. The received HP-IB data is checked internally to insure data integrity.

Figure 4-1. Format of Data Returned by "SET?" Command.

Data:	# ... A	2 length bytes	624 data bytes	2 verification bytes
Byte:	1 ... 2	3 ... 4	5 ... 628	629 ... 630

SET? The SET? command transfers the instrument state over the HP-IB in a binary format. The SET? command transmits 630 bytes in the format shown in Figure 4-1. The # A (bytes 1 and 2) represent the binary ASCII codes for # and A. The two length bytes (bytes 3 and 4) indicate the total number of data bytes and verification bytes transmitted. Bytes 5 through 628 represent the binary ASCII data. Bytes 629 and 630 are used by the -hp-3561A to verify data integrity.

Use of the SET? and SET commands is illustrated in the example program segments for the -hp- series 200 computer in Programs 4-6 and 4-7. Program segment 4-6 obtains -hp-3561A setup data and stores the data on the -hp- series 200 disc. Program segment 4-7 obtains the -hp-3561A setup data from the -hp-series 200 disc and loads the data into the -hp-3561A.

Program 4-6. Reads an -hp-3561A setup state and stores it on disc using SET? command.

```

INTEGER Array(1:630)           ! Set up array
OUTPUT 711;"SET?"             ! -hp-3561A to dump setup
ENTER 711 USING "#,630(B)";Array(*) ! Place setup state in the array;
                                ! # = enter data until array is full;
                                ! 630(B) = 630 bytes; 626 bytes for
                                !   setup plus 4 bytes for #A and length
CREATE BDAT "SETUP",1,1260     ! Create binary data file
ASSIGN @Path TO "SETUP"       ! Create output path name
OUTPUT @Path;Array(*)         ! Output binary data to disc

```

Program 4-7. Reads a setup state from disc and loads it into the -hp-3561A using SET command.

```

INTEGER Array(1:630)           ! Set up array
ASSIGN @Path TO "SETUP"       ! Create disc input path name
ENTER @Path;Array(*)          ! Input binary data from disc
OUTPUT 711 USING "#,K";"SET " ! -hp-3561A to receive trace
OUTPUT 711 USING "#,630(B)";Array(*) ! Output trace data to analyzer

```

READING AND INTREPRETING THE SETUP STATE

Another use of the SET? command is to read and interpret portions of the setup state, such as reading the center frequency. This is done by reading the setup and converting the binary setup data into useful information. The binary data transmitted by the SET? command has the format shown in Figure 4-1. The first two bytes are the ASCII code for # and A; the third and fourth bytes indicate the total number of data bytes and verification bytes transmitted.

Table 4-8 defines the variables in the 624 data bytes of the setup state. Each variable is identified by an offset byte. Each variable has an associated data type (real, integer, enumerated, string or Boolean); these data types are defined in Table 4-4. Programs written to access the setup state data must read the binary

data into the appropriate variable type. The -hp-3561A uses the same real and integer formats as the -hp- series 200 computers (see Figure 4-2), and programs such as Program 4-8 can make the conversions easily.

Figure 4-2. Storage Formats for REAL and INTEGER Data

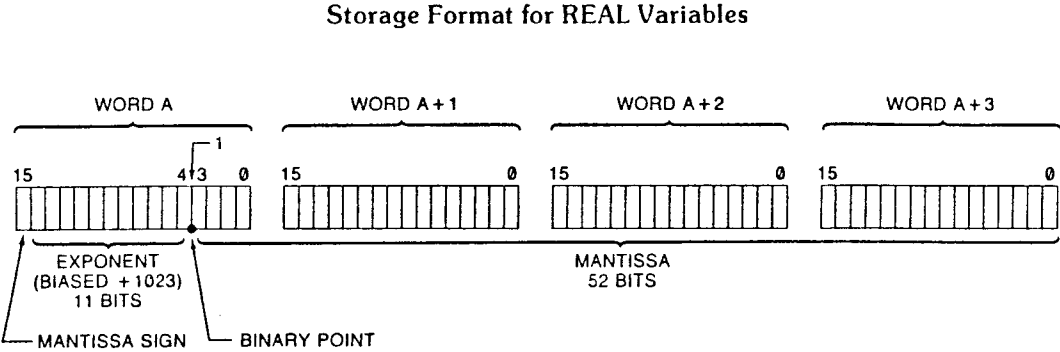

Storage Format for INTEGER Variables

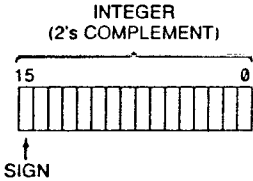

Table 4-4. Data Types

Data Type	Description
Real	Eight bytes using real data format shown in Figure 4-2.
Integer	Two bytes of two's complement binary data format shown in Figure 4-2.
Enumerated	Two bytes of integer format data where each value represents a state. Each variable has a range of values. For example, the variable "trace type" at offset byte 129 has a valid range 0:2, where 0 represents magnitude, 1 represents phase, and 2 represents time.
String	String variables have variable size, with each byte the ASCII version of an alphanumeric character. The length of each string variable is listed in Tables 4-8, 4-9, and 4-10.
Boolean	Boolean variables have only one byte associated with them. The byte will contain a 1 (false) or a 0 (true) right justified in the byte.

NOTE

Data must be read into the correct variable type to be valid. For example, the data at byte 105 is integer; if read into a variable declared real, the resulting value is invalid.

Not all of the bytes in the state are documented. Some bytes are used internally to load default values into variables or to set up the display; some are not used.

Program 4-8 transfers setup data from the -hp-3561A and reads data at the location selected with an offset byte (OFFSET?) from Table 4-8. Once located, the binary data is converted to string, real, integer, or Boolean data. It is convenient to use the ENTER statement to handle the conversion. The program asks what type of variable (real, integer or enumerated, string, or Boolean) the data is read into (DATA TYPE?). Table 4-8 lists both the offset byte and the data type.

The -hp-3561A setup state cannot be modified by directly changing the SET? data. To modify the state of the -hp-3561A, the HP-IB command for each new parameter to be changed must be written to the analyzer.

Example

To determine the current center frequency, span and window type, first determine the appropriate offset bytes and data types from Table 4-8:

	OFFSET BYTE	DATA TYPE
center frequency	585	Real
span	593	Real
window type	581	Enumerated

Preset the -hp-3561A. Run Program 4-8, supplying the offset bytes and data types as requested. The program will indicate the following values for the PRE-SET state:

OFFSET	585	REAL	50000	(center frequency of 50,000 Hz)
OFFSET	593	REAL	100000	(span of 100,000 Hz)
OFFSET	581	INTEGER	51	(flattop window)

Program 4-8. Reads and interprets setup state data.

```
10  ! This program reads and interprets the -hp-3561A setup state data. The
20  !   offset bytes and data types are listed in Table 4- 8.
30  !
40  OPTION BASE 1                                ! Select a default lower array
50                                          !   bound of 1
60  ASSIGN @Anz TO 711                          ! Create an I/O path to 3561A
70  ASSIGN @Fast TO BUFFER [630];FORMAT OFF ! Create an I/O path to a 630
80                                          !   byte buffer; transfer data in
90                                          !   binary format
100 !
110 DIM Sval$(18)
120 INTEGER Intval,Intval1                      ! Allocate variable space
130 REAL Rval
140 !
```

```

150 LOCAL 711
160 INPUT "OFFSET ?",Offset
170 INPUT "DATA TYPE (R for real, I for integer OR enumerated, S for string, B for
Boolean)",Type$
180 OUTPUT @Anz;"SET?" ! Send the setup state
190 CONTROL @Fast,3;1 ! Position buffer write pointer
200 ! to beginning of setup state
210 ! data
220 TRANSFER @Anz TO @Fast;COUNT 630,WAIT ! Transfer setup data to buffer
230 CONTROL @Fast,5;Offset+4 ! Position the buffer read pointer
240 ! to the offset location. This
250 ! offset by 4 more bytes to skip
260 ! over the four control bytes.
270 !
280 SELECT Type$ ! Execute the subroutine for the
290 ! data type entered
300 CASE "R","r"
310 GOSUB Reall
320 GOTO 150
330 CASE "I","i"
340 GOSUB Integerr
350 GOTO 150
360 CASE "S","s"
370 GOSUB Stringg
380 GOTO 150
390 CASE "B","b"
400 GOSUB Booleann
410 GOTO 150
420 CASE ELSE
430 GOSUB Unknown
440 GOTO 150
450 STOP
460 END SELECT
470 !-----
480 Reall: ! Read data as real
490 !-----
500 ENTER @Fast;Rval
510 PRINT "OFFSET",Offset,"REAL",Rval
520 RETURN
530 !-----
540 Integerr: ! Read data as integer
550 !-----
560 ENTER @Fast;Intval
570 PRINT "OFFSET",Offset,"INTEGER",Intval
580 RETURN
590 !-----
600 Stringg: ! Read data as string
610 !-----
620 ENTER @Fast USING "#,K";Sval$
630 PRINT "OFFSET",Offset,"STRING",Sval$
640 RETURN
650 !-----
660 Booleann: ! Read data as Boolean
670 !-----
680 ENTER @Fast;Intval
690 PRINT "OFFSET",Offset,"BOOLEAN",Intval
700 RETURN
710 !-----
720 Unknown: ! Read data as two bytes
730 !-----
740 ENTER @Fast USING "#,B,B";Intval,Intval1
750 PRINT "OFFSET",Offset,"UNKNOWN",Intval,Intval1
760 RETURN
770 END

```

-hp-3561A IDENTIFICATION

ID? The ID command transmits -hp-3561A identification code (HP3561A) to the remote interface.

OPT? The OPT? command transmits the installation status of the bubble memory. A zero is returned if the bubble memory is not installed and a one is returned if the bubble memory is installed.

REV? The REV? command transmits a pair of revision dates (the revision and capability date) for the program stored in the -hp-3561A read only memory. The date code is transmitted as two four digit integer numbers. The years since 1960 are represented by the first two digits, and the week is represented by the second two digits in each number.

ACCESSING DATA FROM THE -hp-3561A

The -hp-3561A uses binary data transfers to speed transfer time. (The bubble memory catalog and the display alphanumeric can be transferred in ASCII format.) When transferred in binary format, data is attached to a header containing information about the -hp-3561A configuration used to take the data. It is necessary to preserve the header when writing data to the analyzer; without a valid header the -hp-3561A will issue an error message and consider the data invalid. If more detail is required than that given in the header, the SET? command should be used as described in the previous section.

Trace Data and Buffer File Data. The -hp-3561A has two internal data types: traces and buffer files. Traces are 401 words in length for magnitude or phase data or 399 words in length for time domain data. Buffer files contain time domain data obtained in time capture mode, and are 1024 words long for each record captured (up to 40 records). Because traces and buffer files have different header formats, it is necessary to know the data type when transferring data and/or analyzing data headers. Usually the data is trace data; the data is buffer file data if the title in the upper left hand corner of the active (brightest) trace is "BUFFC(R)," "BUFFC(I)," "BUFF(R)," or "BUFF(I)."

Data Compression. Because the raster display has 401 points, time domain data (which is normally 1024 points in length) is "compressed" to fit the display. A compressed time domain trace consists of 399 pairs of bytes, where the first byte is the minimum value and the second byte the maximum value of the data over a two or three time point region (see Figure 4-3 for the exact format). The range for these two bytes is from -128 to +127. Because each byte is only 8 bits long, the time domain trace data can have only 8 bits of display and marker resolution.

NOTE

Time domain data displayed on the -hp-3561A display consists of 399 pairs of 8 bit data. Each marker position has two values, a minimum and a maximum value. To access the full 14 bit time samples before display compression requires the use of a program to access the raw time buffer. This topic is covered in the section titled "READING FROM AND WRITING TO THE TIME BUFFER."

Figure 4-3. Data Formats for Traces and Buffers.

Traces (Frequency domain, magnitude or phase)

Data:	# ... A	2 length bytes	802 data bytes	222 header bytes
Byte:	1 ... 2	3 ... 4	5 ... 806	807 ... 1028

Traces (Time domain)

Data:	# ... A	2 length bytes	798 data bytes	2 unused	222 header bytes
		2 unused bytes	(399 min/max pairs)	bytes	
Byte:	1 ... 2	3 ... 6	7 ... 804	805 ... 806	807 ... 1028

Buffers

Data:	# ... I	348 header bytes	2048 data bytes per record
Byte	1 ... 2	3 ... 350	351 ... 2398 (one record)
			351 ... 82270 (40 records)

ASCII DATA TRANSFERS

DFCA. The DFCA (dump file catalog in ASCII) command displays the bubble memory catalog and transmits the corresponding entries over the HP-IB. The first word transmitted is the integer number of catalog lines to follow. A maximum of 129 catalog lines are transmitted. The first 2 lines are the column headings, and the remaining lines represent the catalog entries. Each catalog line contains 38 characters. The file name uses the first 9 characters of the catalog line. The file type description starts at character position 21. The file size description starts at character position 35. Program 4-9 illustrates use of the DFCA command.

Program 4-9. Transfers the bubble memory catalog in ASCII format using DFCA command.

```

DIM Name$(129)[38] ! Dimension array for 129 lines of 38 characters
OUTPUT 711;"DFCA;" ! -hp-3561A to list catalog
ENTER 711;Number ! Input number of lines
PRINT Number;" LINES"! Print number of lines on computer screen
FOR I=1 TO Number ! Start loop to input and print lines
  ENTER 711;Name$(I) ! Input line
  PRINT Name$(I) ! Print line on computer screen
NEXT I

```

DDSA. The DDSA (dump display alphanumeric display) command transmits the display alphanumeric data entries over the HP-IB. The display data is transmitted as 1872 characters (72 characters times 26 rows). A total of 1876 bytes are transmitted for the DDSA command.

The alphanumeric display data is transmitted by the DDSA command in the form of #A LB1 LB2 BYTE1 BYTE2 ... BYTEN [EOI] (see Figure 4-4). The #A represents the binary ASCII code for # and A. LB1 and LB2 indicate the number of data bytes (BYTE1 through BYTEN) transmitted. LB1 and LB2 represent the most significant and least significant bytes of the number of bytes transmitted. BYTE1 BYTE2 ... BYTEN represent the binary ASCII data. The binary transmission is ended with the HP-IB EOI bus management line being asserted (many controllers sense or configure the bus management lines automatically).

Figure 4-4. Binary Data Format

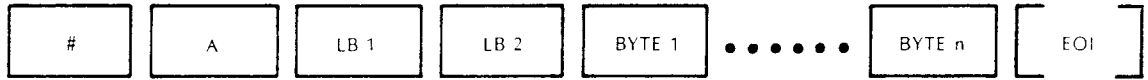

BINARY DATA TRANSFERS

Six commands are available that move binary time or frequency domain data into and out of the -hp-3561A. Again, there is a difference between trace and buffer data, which is discussed below in the different commands available.

DSTB. The DSTB (dump selected trace binary) command transmits trace data in binary format over the HP-IB. The -hp-3561A transmits 1028 bytes for all traces. See Figure 4-3 for the trace data format.

LSTB. The LSTB (load selected trace binary) command loads trace data into the -hp-3561A over the HP-IB. Each trace requires 1028 bytes in the same format as the DSTB command (see Figure 4-3). Trace data loaded into the -hp-3561A must be data output by the DSTB command. For non-map displays, LSTB loads trace data into the selected trace. For full map displays, each LSTB command replaces a successive trace in the map, starting with Trace 1. The map is reset with the MAGM (MAG MAP) command. Selected traces in a map can be replaced by selecting a trace with the SLMT (Select Magnitude Trace) command and enabling a single map display with the SINM (Single Map) command.

DTBB. Dump time buffer binary transmits a specified number of record of time buffer data over the HP-IB in binary form. Figure 4-3 shows the format for the buffer data. The number of bytes transferred is equal to 350 plus 2048 times the number of bytes selected (e.g., if 3 records are transferred, the number of bytes is 6,494, or $350+2048*3$). The maximum number of bytes of 82,270, or $350+2048*40$.

LTBB. The LTBB (load time buffer binary) command loads the time buffer with data transmitted over the HP-IB in binary form. Time buffer data loaded into the -hp-3561A must be output by the DTBB command. The number of bytes transmitted varies with the number of time records in the time buffer (see explanation in previous paragraph). The data has the format described in Figure 4-3.

LMTB. For non-map displays, the LMTB (load magnitude trace in binary) command loads data into the selected trace without a header. For full map displays, each LMTB command replaces a successive trace in the map starting with trace 1. The map is reset with the MAGM (MAG MAP) command. Selected traces in a map can be replaced by selecting a trace with the SLMT (select magnitude trace) command and enabling a single map display with the SINM (single map) command. The LMTB command can also load values for math operations on magnitude traces. Trace data loaded with the LMTB command requires the characters #A, the length bytes, and 802 bytes for the trace data. Magnitude trace data may be generated by using the 802 bytes of trace data from a DSTB magnitude display data transfer. For information on interpreting the binary trace data, see the section on "Magnitude Traces" under "READING TRACE DATA."

LPTB. The LPTB (load phase trace in binary) command loads data into the selected trace without a header. This command can load values for math operations on phase traces. Trace data loaded with the LPTB command requires the characters #A, the length bytes, and 802 bytes for the trace data. Phase trace data may be generated by using the 802 bytes of phase data from a DSTB phase display data transfer. For information on interpreting the binary trace data, see the section on "Phase Traces" under "READING TRACE DATA."

One application of this type of command is to store a trace on disc, as in Program 4-10. This program will work for both time or frequency domain traces.

Program 4-10. Transfers a binary trace from -hp-3561A to disc and back using DSTB command.

```

INTEGER Array(1:1028)           ! Set up array to receive data
OUTPUT 711;"DSTB"               ! Instruct analyzer to dump data
ENTER 711 USING "#,1028(B)";Array(*) ! Load data into Array(*)
CREATE BDAT "TRACE",1,2056      ! Create space on the disc
ASSIGN @Path TO "TRACE"        ! Assign this space an IO path
OUTPUT @Path;Array(*)          ! Write Array(*) into disc
CONTROL @Path,5;1              ! Reset pointer to beginning
                                ! of record
ENTER @Path;Array(*)           ! Read disc data into Array(*)
OUTPUT 711 USING "#,K";"LSTB"   ! Prepare analyzer to receive data
OUTPUT 711 USING "#,1028(B)";Array(*) ! Write stored trace to analyzer

```

The commands DSTB, LSTB, DTBB, and LTBB load or transfer binary data along with a header from the -hp-3561A. Data accessed with these commands has the formats shown in Figure 4-3. The header bytes are documented in the next few sections.

READING TRACE DATA

Time Traces. Each time data word contains the minimum and maximum value of each display position resulting from data compression of the 1024 point time record onto a 401 line display. The first byte represents the minimum value and the second byte represents the maximum value, with a range from -128 to +127. Data can be scaled to volts by reading the full scale volts value out of the data header as in Program 4-11. Writing time traces for display purposes is best done by first reading a time trace, saving the header, attaching the time data (399 pairs of min/max points), and rewriting the entire block. Program 4-15 illustrates this for time buffers.

Magnitude Traces. Each magnitude trace data word contains a value for each display position. The conversion factor for converting a magnitude trace data word to an actual value is 0.005 dB. For example, if the binary word represents the value 220, the actual value in dB is 1.100 dB (220 times 0.005 dB).

When trace math is used, an offset byte is sometimes generated that must be added to the product of 0.005 dB and the integer display word value. The offset word is located immediately after the trace data, at offset byte 1 of the trace data header. The setup state data header also contains an offset value at byte 1; this byte does not reflect math operations on stored data. For reliable trace calibration, use the trace data header rather than the setup state data header.

Program 4-11. Reads and calibrates a time trace.

```

10 ! This program reads data from the time trace and associated header to
20 ! obtain calibrated time data. Time trace data is passed through a
30 ! min/max algorithm (which returns the minimum and maximum values in
40 ! a given number of data points) to compress the 1024 point time record
50 ! into a 401 point line representation.
60 ! Data is placed in Time_data(400) array, and is scaled and formatted.
70 !
80 OPTION BASE 1 ! Select a default lower array bound of 1
90 ASSIGN @Anz TO 711 ! Create an I/O path to -hp-3561A
100 ASSIGN @Tag TO BUFFER [1028];FORMAT OFF
110 ! Create an I/O path to a 1028 byte buffer;
120 ! transfer data in binary format
130 !
140 INTEGER Trace_type,Raw_data(400)
150 REAL Start_t,Stop_t,Center_t,Time_per_div,Volts_full_scale
160 ! Allocate variable space
170 REAL X,Time_data(400)
180 !
190 OUTPUT @Anz;"DSTB" ! Dump active trace and header data
200 TRANSFER @Anz TO @Tag;END,WAIT ! Initiate the transfer to the buffer file;
210 ! pause program until all data has been
220 ! transferred
230 LOCAL @Anz
240 !
250 GOSUB Read_data ! Read the data and the header
260 GOSUB Scale_data ! Scale the data if needed
270 GOSUB Print_data ! Print a summary and plot the data
280 STOP
290 !
300 !-----
310 Read_data: ! Read the data and the header (header
320 ! is offset by 806 data bytes)
330 !-----
340 CONTROL @Tag,5;4 ! Position the buffer point reader to
350 ENTER @Tag;Raw_data(*) ! byte 4 and read the data
360 !
370 CONTROL @Tag,5;806+145 ! Position the buffer point reader to
380 ENTER @Tag;Trace_type ! offset byte 145 and read trace type
390 IF Trace_type<2 THEN ! Check for time data
400 BEEP
410 PRINT "NOT TIME DATA"
420 GOTO 940
430 END IF
440 !
450 CONTROL @Tag,5;806+147 ! Position the buffer point reader to
460 ENTER @Tag;Start_t ! offset byte 147 and read start time
470 !
480 CONTROL @Tag,5;806+155 ! Position the buffer point reader to
490 ENTER @Tag;Stop_t ! offset byte 155 and read stop time
500 !
510 CONTROL @Tag,5;806+163 ! Position the buffer point reader to
520 ENTER @Tag;Center_t ! offset byte 163 and read center time
530 !
540 CONTROL @Tag,5;806+171 ! Position the buffer point reader to
550 ENTER @Tag;Time_per_div ! offset byte 171 and read time/div
560 !
570 CONTROL @Tag,5;806+179 ! Position the buffer point reader to
580 ENTER @Tag;Volts_full ! byte 179 and read volts full scale
590 RETURN
600 !-----
610 Scale_data: ! Scale data to the -128:+127 range
620 !-----

```

```

630 Factor=Volts_full/32768
640 FOR I=1 TO 399
650 CONTROL @Tag,5;2*I+5
660 ENTER @Tag;Raw_data(I)
670 IF Raw_data(I)>128 THEN Raw_data(I)=Raw_data(I)-256
680 NEXT I
690 !
700 MAT Time_data= Raw_data*(Factor) ! Copy the scaled raw data array into
710                                     ! the time data array
720 Maxi=MAX(Time_data(*))           ! Find the array maximum
730 Mini=MIN(Time_data(*))           ! Find the array minimum
740 IF Mini=Maxi THEN STOP
750 RETURN
760 !-----
770 Print_data:                       ! Print summary of the data and plot data
780 !-----
790 GCLEAR                             ! Clear the graphics display
800 GINIT                               ! Setup up the graphics display
810 GRAPHICS ON
820 VIEWPORT 60,120,40,80             ! Define area of screen for graphics
830                                     ! display
840 WINDOW 0,400,Mini,Maxi           ! Define values for ends of the axes
850 FRAME                             ! Draw a frame around the graphics
860 PRINT "MAX + VALUE",Maxi         ! Print a summary of the data
870 PRINT "MAX - VALUE",Mini
880 PRINT "START T",Start_t
890 PRINT "STOP T ",Stop_t
900 MOVE 1,Time_data(1)              ! Move the pen to the first point
910 FOR I=1 TO 400
920   DRAW I,Time_data(I)            ! Draw the plot
930 NEXT I
940 END

```

Phase Traces. Each phase trace data word contains a value for each display position. The conversion factor for converting a phase trace data word (two bytes) to a phase value is 0.1 degrees. For example, if the binary word represented 220, the actual phase value would be 22.0 degrees (220 times 0.1).

READING DATA HEADERS

When trace or time buffer data is transferred from the -hp-3561A, the analyzer passes a header containing information on the setup state. This information reflects the conditions present when data was collected, not necessarily the -hp-3561A's current setup state. For example, if data has been taken and the analyzer paused, subsequent changes to the setup state will not be noted in the trace or buffer data header until data collection resumes by pressing START or CONTINUE.

Data headers are useful for keeping track of how the -hp-3561A was set when data was gathered. The data header is also needed to obtain absolute calibration of the magnitude, frequency, or time axis. The -hp-3561A uses different header formats for traces and buffers. Furthermore, time traces are slightly different from frequency domain traces. Figure 4-3 shows the data format for traces and buffers accessed using the DSTB, LSTB, DTBB, or LTBB commands.

The two sample programs in this section access the headers transferred when the DSTB or DTBB commands are used to read time or frequency domain data from the -hp-3561A. Like the sample program used to read the SET? data (Program 4-8), these programs use an offset byte to locate data within the header

and a variable type for converting the binary data. Tables 4-9 and 4-10 contain this information for trace and buffer headers. Program 4-12 illustrates how data is read from a trace data header. The same program could be used for a time buffer by changing the start and offset bytes appropriately and using the DTBB command.

Program 4-12. Reads data headers from a frequency domain trace.

```
100 ASSIGN @Anz TO 711
110 ASSIGN @Header TO BUFFER [1028];FORMAT OFF
120 REAL Db_per_div
130 OUTPUT @Anz;"DSTB"
140 CONTROL @Header,3;1
150 TRANSFER @Anz TO @Header;END,WAIT
160 Start=806
170 CONTROL @Header,5;Start+175
180 ENTER @Header;Db_per_div
```

LINES 100 and 110 assign IO paths to the -hp-3561A and to the buffer that will receive the trace data.

LINE 120 declares "Db_per_div" as real. This will cause the computer to read the data into "Db_per_div" as real data. Depending on the data type, this variable may need to be declared differently.

LINE 130 instructs the -hp-3561A to prepare to transfer the active trace in binary format.

LINE 140 positions the write pointer for the buffer assigned in line 110 to the beginning of the buffer.

LINE 150 causes the trace data and header to be loaded into the buffer. At this point the data transfer is complete, but the data is not usable; it must be read into a variable.

LINE 170 reads the buffer at the location "Start+175", where "Start" indicates the beginning of the header, and "175" the offset byte.

LINE 180 reads the data beginning at byte 981 (Start+175), and will read until the variable "Db_per_div" has been satisfied. Because "Db_per_div" was declared a real variable, 8 bytes are read at line 180.

Trace Header Data. Program 4-13 reads and interprets trace header data. The program is nearly identical to that used to read the setup state data (Program 4-8). It asks for an offset byte and data type from Table 4-9.

Program 4-13. Reads and interprets the header contained in trace data.

```

10   ! This program reads and interprets trace header data. The offset bytes
20   !   and data types are listed in Table 4-9.
30   !
40   OPTION BASE 1                               ! Select a default lower array bound
50                                           !   of 1
60   ASSIGN @Anz TO 711                          ! Create an I/O path to 3561A
70   ASSIGN @Header TO BUFFER [1028];FORMAT OFF
80                                           ! Create an I/O path to a 1028 byte
90                                           !   buffer; transfer data in binary
100                                          !   format rather than ASCII
110  !
120  DIM Sval$(20)
130  INTEGER Intval,Intval1,Offset              ! Allocate variable space
140  REAL Rval
150  !
160  INPUT "OFFSET ? ",Offset
170  INPUT "DATA TYPE (R for real, I for integer or enumerated, S for string, B for
Boolean)",Type$
180  OUTPUT @Anz;"DSTB"                          ! Send the setup state
190  CONTROL @Header,3;1                        ! Position the buffer write pointer to
200                                          !   beginning of trace header data
210  TRANSFER @Anz TO @Header;END,WAIT          ! Transfer data to buffer
220  CONTROL @Header,5;Offset+806              ! Position the buffer read pointer to
230                                          !   the offset location. This is offset
240                                          !   by 806 bytes to skip over the trace
250                                          !   data.
260  !
270  SELECT Type$                                ! Execute the subroutine for the
280                                          !   data type entered
290  CASE "R","r"
300  GOSUB Reall
310  GOTO 160
320  CASE "I","i"
330  GOSUB Integerr
340  GOTO 160
350  CASE "S","s"
360  GOSUB Stringg
370  GOTO 160
380  CASE "B","b"
390  GOSUB Booleann
400  GOTO 160
410  CASE ELSE
420  GOSUB Unknown
430  GOTO 160
440  END SELECT
450  !-----
460  Reall:                                       ! Read data as real
470  !-----
480  ENTER @Header;Rval
490  PRINT "OFFSET",Offset,"REAL",Rval
500  RETURN
510  !-----
520  Integerr:                                   ! Read data as integer
530  !-----
540  ENTER @Header;Intval
550  PRINT "OFFSET",Offset,"INTEGER",Intval
560  RETURN
570  !-----
580  Stringg:                                   ! Read data as string
590  !-----
600  ENTER @Header USING "#,K";Sval$
610  PRINT "OFFSET",Offset,"STRING",Sval$

```

```

620 RETURN
630 !-----
640 Boolean:                                ! Read data as Boolean
650 !-----
660 ENTER @Fast;Intval
670 PRINT "OFFSET",Offset,"BOOLEAN",Intval
680 RETURN
690 !-----
700 Unknown:                                ! Read data as two bytes
710 !-----
720 ENTER @Header USING "#,B,B";Intval,Intval1
730 IF Type$="B" OR Type$="b" THEN
740 PRINT "OFFSET",Offset,"BOOLEAN",Intval
750 RETURN
760 END IF
770 PRINT "OFFSET",Offset,"UNKNOWN",Intval,Intval1
780 RETURN
790 END

```

Time Buffer Header Data. Program 4-14 reads and interprets the data in the header transferred with time buffer data. This program is nearly identical to those used to read the setup state (Program 4-8) and the trace header (Program 4-13). The offset byte and data type should be taken from Table 4-10.

Like the setup state data, the buffer header contains two verification bytes. Because modification of the header data will change these bytes, buffer headers cannot be read, modified, and written back into the -hp- 3561A. The verification program does not look at the actual time domain data, so it is possible to create data and load it into the analyzer's time buffer. This topic is covered in the section entitled "READING FROM AND WRITING TO THE TIME BUFFER."

Calibration Factors. Unlike trace headers, the buffer header contains calibration data for magnitude and phase. In the -hp-3561A, calibration is done in the frequency domain. Because buffer data is by definition time domain, it is never calibrated for minor magnitude and phase shifts caused by the analog input circuitry. (Calibration would require FFT processing the data into the frequency domain, adjusting for the calibration factors, and then inverse FFT processing the data back to the time domain.)

If time capture data must be analyzed in the frequency domain, it is best to let the -hp-3561A perform the analysis. The analyzer will automatically apply the calibration factors contained in the current header to correct the magnitude and phase trace displays. To create data and load it in the time buffer for frequency domain analysis, a valid header must be attached to the data. Setup the -hp-3561A to the appropriate span and range, but avoid math operations, zoom, use of the the A-weight filter, and trigger modes other than free-run. This prevents compensation for effects not actually present in the data. This applies only to the setup used to obtain the valid header. Once the header exists and is attached and the data is in the -hp-3561A, trace math or post-capture zoom can be performed.

Using time domain data without applying the appropriate calibration factors is not likely to cause errors. With a frequency span of 100 kHz, most of the magnitude and phase ripple in the anti-alias filters is concentrated above 30 kHz. However, in most applications frequencies higher than 10 kHz cannot be visually resolved, even with the -hp-3561A sampling as fast as it can.

Program 4-14. Reads and interprets the header contained in buffer data.

```

10      ! This program reads and interprets buffer header data. The offset bytes
20      ! and data types are listed in Table 4-10.
30
40      OPTION BASE 1
50
60      ASSIGN @Anz TO 711
70      ASSIGN @Header TO BUFFER [350];FORMAT OFF
80
90
120     INTEGER Intval,Intval1,Offset
130     REAL Rval
140
150     LOCAL @Anz
160     INPUT "OFFSET ?",Offset
170     INPUT "DATA TYPE (R for real, I for integer or enumerated, B for Boolean)",Type$
180     OUTPUT @Anz;"DTBB"
190     TRANSFER @Anz TO @Header;COUNT 350,WAIT
200     CONTROL @Header,5;Offset+2
210
220
230
240
250     SELECT Type$
260
270     CASE "R","r"
280         GOSUB Reall
290         GOTO 150
300     CASE "I","i"
310         GOSUB Integerr
320         GOTO 150
330     CASE "B","b"
340         GOSUB Booleann
350         GOTO 150
360     CASE ELSE
370         GOSUB Unknown
380         GOTO 150
390     END SELECT
400     !-----
410     Reall:
420     !-----
430     ENTER @Header;Rval
440     PRINT "OFFSET",Offset,"REAL",Rval
450     RETURN
460     !-----
470     Integerr:
480     !-----
490     ENTER @Header;Intval
500     PRINT "OFFSET",Offset,"INTEGER",Intval
510     RETURN
520     !-----
530     Boolean:
540     !-----
550     ENTER @Header;Intval
560     PRINT "OFFSET",Offset,"BOOLEAN",Intval
570     RETURN
580     !-----
590     Unknown:
600     !-----
610     ENTER @Header USING "#,B,B";Intval,Intval1
620     PRINT "OFFSET",Offset,"UNKNOWN",Intval,Intval1
630     RETURN
640     END

```

Calibration data has the same format as the actual frequency domain data--two's complement binary. Magnitude calibration factors can be converted to dB by multiplying by 0.005 dB. Phase calibration factors can be converted to degrees by multiplying by 0.1 degrees.

Both magnitude and phase calibration traces consist of 64 points each. To produce a calibration trace that is compatible with the 400 line data displayed by the -hp-3561A involves interpolating the calibration traces. Point 0 of the calibration trace corresponds to DC, and point 64 corresponds to 128 kHz, regardless of the span or zoom parameters.

READING FROM AND WRITING TO THE TIME BUFFER

Accessing the time buffer data directly opens up a new realm of capabilities. Programs can be written to read the time buffer data, modify it, and write it back into the -hp-3561A. The -hp-3561A can be used as an FFT processor. The storage capacity of the -hp-3561A can be expanded by reading data out and placing it on disc. This section contains two example programs. Program 4-15 shows how to read data from the time buffer.

Program 4-16 gives an example of how to write data to the time buffer. To use this program, data must first be captured in the time buffer with a setup state that reflects the time and amplitude scaling of the data to be written. The -hp-3561A needs this header to process the data. Once a dummy capture had been made, modify the subroutine called "Create_data" to load new data into the array "Raw_data(J,1024)" (where J is the number of records, each expected to be 1024 words long).

The time buffer data is formatted as two's complement binary. In addition, it is scaled so that no value will overflow the digital filters in the -hp- 3561A. When writing to the time buffer, a full scale signal is represented as:

$$\text{Full scale magnitude} = \pm (3/4) * 32768$$

The physical value represented by full scale depends on the input voltage range of the -hp-3561A. For a range given in dB, the actual voltage may be found by performing the following conversion:

$$\text{Amplitude Volts peak} = \text{Raw_data} * (4/3) * 10^{((\text{range}+4.812)/20)} * (1/32768)$$

In both of these programs the data header is carefully removed from the time domain data. If data is to be written to the time buffer, the header is always re-attached to the data before it is sent. Without a valid header the -hp-3561A will consider the data invalid. Because the buffer header contains two verification bytes, the header cannot be modified if the data is to be put back into the -hp-3561A. Changing the header will cause the -hp-3561A to ignore data and issue an error message.

Program 4-15. Reads from the time buffer using LTBB.

```

10      ! THIS PROGRAM READS DATA FROM THE -hp-3561A
20      ! The -hp-3561A must be in the time capture mode. Up to 40 records, or
30      ! 82910 bytes (2048 bytes per record plus the 350 byte data header), can
40      ! be read. (Lines 350, 360, and 370 may need to be modified to avoid
50      ! overflowing your computer's memory during run- time.)
60      ! All -hp-3561A data contains a data header. In time capture mode, the
70      ! header is sent in the first 350 bytes of the transfer. This program
80      ! removes the header and returns the calibrated time data.
90      !
100     OPTION BASE 1           ! Select a default lower array bound of 1
110     DEG                     ! Select degrees as unit of measure for angles
120     ASSIGN @Anz TO 711      ! Create an I/O path to 3561A
130     ASSIGN @Fast TO BUFFER [82270];FORMAT OFF
140                                     ! Create an I/O path to a 82,270 byte buffer (350
150                                     ! data header bytes plus 2048 bytes for each of
160                                     ! 40 records; transfer data in binary format
180     INTEGER Range,Max_rec_size,Raw_data(40,1024),Tag_field(350)
190     REAL Time_data(40,1024),Span,Start_t,Stop_t,X,Rec_size
200                                     ! Allocate variable space
220     GOSUB How_many          ! Determine how many records are to be transferred
230     GOSUB Read_data         ! Read data from -hp-3561A to buffer
240     GOSUB Read_tag          ! Get range, span, start and stop times, baseband
250                                     ! data, and buffer size from data header
260     GOSUB Convert_data      ! Read integers from buffer, convert to real
270                                     ! voltages
280     GOSUB Print_data        ! Print a summary of the data and plot data
290     STOP
310 !-----
320 How_many:                      ! Determine how many records are to be transferred
330 !-----
340     PRINT CHR$(12)
350     INPUT "HOW MANY RECORDS TO TRANSFER?",Rec_size
360     IF Rec_size>40 OR Rec_size<1 THEN GOTO 350
370     REDIM Raw_data(Rec_size,1024),Time_data(Rec_size,1024)
380     RETURN                    ! Redimensions memory arrays to number of records
390 !-----
400 Read_data:                     ! Read data from 3561 to buffer. Takes
410                                     ! 0.15 seconds per record plus 0.13 seconds
420 !-----
430     OUTPUT @Anz;"DTBB"        ! Send DUMP-TIME-BUFFER-BINARY command
440     TRANSFER @Anz TO @Fast;COUNT 350
450     FOR I=1 TO Rec_size
460         DISP "READING RECORD NUMBER:",I
470         TRANSFER @Anz TO @Fast;COUNT 2048,WAIT
480     NEXT I
490     RETURN
500 !-----
510 Read_tag:                       ! Get range, span, start and stop times, baseband
520                                     ! data, and buffer size from data header
530 !-----
540     DISP "READING HEADER"
550     !
560     CONTROL @Fast,5;1          ! Move buffer point reader to
570     ENTER @Fast;Tag_field(*)   ! of data header
580     !
590     CONTROL @Fast,5;15        ! Move buffer point reader to byte 15
600     ENTER @Fast;Span          ! and read span
610     !
620     CONTROL @Fast,5;311       ! Move buffer point reader to byte 311
630     ENTER @Fast;Start_t       ! and read start time
640     !
650     CONTROL @Fast,5;319       ! Move buffer point reader to byte 319

```



```

660 ENTER @Fast;Stop_t ! and read stop time
670 !
680 CONTROL @Fast,5;31 ! Move buffer point reader to byte 31
690 ENTER @Fast USING "#,B";Base_band ! and read baseband/zoom status
700 !
710 CONTROL @Fast,5;9 ! Move buffer point reader to byte 9
720 ENTER @Fast;Max_rec_size ! and read buffer size
730 !
740 CONTROL @Fast,5;35 ! Move buffer point reader to byte 35
750 ENTER @Fast;Range ! and read range
760 RETURN
770 !-----
780 Convert_data: ! Read integers from buffer, convert to real volts
800 !-----
810 DISP "CONVERTING DATA"
820 Factor=(4/3)*10.0((Range+1.802+3.01)/20.0)/32768.0
830 Reg_5=351
840 CONTROL @Fast,5;Reg_5
850 ENTER @Fast;Raw_data(*)
860 MAT Time_data= Raw_data*(Factor)
870 RETURN
880 !-----
890 Print_data: ! Print a summary of the data and plot data
900 !-----
910 DISP " "
920 PRINT TABXY(1,1),"YOU HAVE SELECTED",TABXY(19,1),Rec_size,TABXY(23,1),
930 PRINT "OF",TABXY(25,1),Max_rec_size,TABXY(29,1),"AVAILABLE RECORDS"
940 IF Base_band THEN PRINT "Data: BASEBAND"
950 IF Base_band=0 THEN PRINT "Data: ZOOM"
960 PRINT "SPAN: ",Span," Hz"
970 PRINT "START TIME: ",Start_t," sec."
980 PRINT "STOP TIME: ",Stop_t," sec."
990 PRINT "INPUT RANGE: ",Range," dBV"
1000 Maxi=MAX(Time_data(*) ! Return the maximum amplitude value
1010 Mini=MIN(Time_data(*) ! Return the minimum amplitude value
1020 PRINT "MAXIMUM VALUE:",Maxi
1030 PRINT "MINIMUM VALUE:",Mini
1040 !
1050 ! This section of the program plots voltage vs. time, without labels.
1060 !
1070 GCLEAR ! Clear the graphics display
1080 GRAPHICS ON ! Turn the graphics display on
1090 VIEWPORT 40,120,15,65 ! Define area of screen for graphics
1100 ! to be displayed
1110 WINDOW Start_t,Stop_t,Mini,Maxi ! Define the values for the ends of
1120 ! the axes
1130 AXES (Stop_t-Start_t)/10.0,Factor*3277,Start_t
1140 ! Draw the axes, mark X axis with 10
1150 ! tick marks
1160 PEN 1
1170 Dx=((Stop_t-Start_t)/(Rec_size))/1024.0
1180 ! Define the step size for X
1190 X=Start_t ! Initialize X to the start time
1200 MOVE Start_t,Time_data(1,1) ! Move the pen to the starting point
1210 FOR I=1 TO Rec_size ! For each record
1220 FOR J=1 TO 1024 ! For each data point
1230 DRAW X,Time_data(I,J) ! Plot the data point
1240 X=X+Dx ! Increment the X value by one step
1250 NEXT J
1260 NEXT I
1270 LOCAL @Anz
1280 ASSIGN @Fast TO *
1290 END

```

Program 4-16. Writes to the time buffer using DTBB.

```

10      ! THIS PROGRAM WRITES DATA TO THE -hp-3561A TIME BUFFER.
20      ! The -hp-3561A must be in the time capture mode. Up to 40 records,
30      !   or 81920 bytes plus the 350 byte data header, can be written to the
40      !   -hp-3561A. (Lines 200 and 260 may need to be modified to avoid
50      !   overflowing your computer's memory.)
60      ! All -hp-3561A data contains a data header. In time capture mode, the
70      !   header is sent in the first 350 bytes of the transfer. This program
80      !   first reads a header and re-uses it with created data. Notice that
90      !   the header is ALWAYS re-attached to the data before it is sent to the
100     !   -hp-3561A. Without a valid header the -hp-3561A will consider the
110     !   data invalid and display an error message.
120     ! The data sent to the analyzer is 2's complement binary, and is contained
130     !   in the array Raw_data. The array's dimensions depend on the number
140     !   of records to be transferred (2048 bytes per record plus 350 header
150     !   bytes).
160
170     OPTION BASE 1           ! Select a default lower array bound of 1
180     DEG                     ! Select degrees as unit of measure for angles
190     ASSIGN @Anz TO 711     ! Create an I/O path to 3561A
200     ASSIGN @Fast TO BUFFER [82270];FORMAT OFF
210                           ! Create an I/O path to a 82,270 byte buffer
220                           !   (2048 data bytes times 40 records plus 350
230                           !   header bytes); transfer data in binary
240                           !   format
250                           !
260     INTEGER Rec_size,Range,Raw_data(40,1024),Tag_field(350)
270     REAL Temp               ! Allocate variable space
280
290     GOSUB How_many         ! Determine how many records are to be
300                           !   transferred
310     GOSUB Create_data     ! Create the records to be written to 3561A
320     GOSUB Read_tag        ! Read the header from the 3561A
330     GOSUB Wrt_data        ! Write data to the 3561A
340
350     LOCAL @Anz
360     ASSIGN @Fast TO *
370     STOP
380 !-----
390 How_many:                 ! Determine how many records are to be
400                           !   transferred
410 !-----
420     PRINT CHR$(12)
430     INPUT "HOW MANY RECORDS TO TRANSFER?",Rec_size
440     IF Rec_size>40 OR Rec_size<1 THEN
450         PRINT "NUMBER OF RECORDS MUST BE BETWEEN 1 AND 40"
460         GOTO 430
470     END IF
480     REDIM Raw_data(Rec_size,1024)
490     RETURN
500 !-----
510 Create_data:             ! Create the records to be written to 3561A
520 !-----
530     FOR J=1 TO Rec_size
540         DISP "CREATE_DATA",J
550         FOR I=1 TO 1024
560             Temp=48000*(RND-.5)
570             Raw_data(J,I)=Temp
580         NEXT I
590     NEXT J
600     RETURN

```

```

610 !-----
620 Read_tag:                                ! Read header from -hp- 3561A
630 !-----
640   DISP "READ_TAG"
650   OUTPUT @Anz;"DTBB"                    ! Send DUMP-TIME-BUFFER-BINARY command
660   OUTPUT @Anz;"TBNR1REC"
670   TRANSFER @Anz TO @Fast;COUNT 350+2048,WAIT
680                                           ! Initiate the transfer; transfer 350+2048
690                                           ! bytes (header + data), pause program
700                                           ! until transfer is complete
710   CONTROL @Fast,5;1                      ! Position buffer point reader to beginning of
720   ENTER @Fast;Tag_field(*)              ! header and read the header
730   RETURN
740 !-----
750 Wrt_data:                                ! Writes the data to the analyzer
760 !-----
770   DISP "WRITE_DATA"
780   Maxi=MAX(Raw_data(*))                  ! Find the maximum and minimum of the array
790   Mini=ABS(MIN(Raw_data(*)))
800   Maxall=MAX(Maxi,Mini)
810   IF Maxall>24576 THEN                    ! Scale data if necessary
820     PRINT "DATA WAS TOO LARGE, DIVIDED DATA BY",Maxall
830     MAT Raw_data= Raw_data/(Maxall)
835                                           ! Read the scaled raw data array
840                                           ! into the raw data array
850     MAT Raw_data= Raw_data*(24576)
860   END IF
870   CONTROL @Fast,3;1                      ! Position buffer point reader at byte 1 and
880   OUTPUT @Fast;Tag_field(*)              ! read header
890                                           !
900   CONTROL @Fast,3;351                    ! Position buffer point reader at byte 350
910   OUTPUT @Fast;Raw_data(*)               ! and read data
920                                           !
930   CONTROL @Fast,5;1                      ! Position buffer point reader to header
940   OUTPUT @Anz USING "#,K";"LTBB"
950                                           ! Send the "Load Time Buffer Binary" command
960   TRANSFER @Fast TO @Anz;COUNT 350,WAIT
970                                           ! Transfer 350 bytes to -hp-3561A, pause program
980                                           ! until transfer complete
990   FOR I=1 TO Rec_size
1000    TRANSFER @Fast TO @Anz;COUNT 2048,WAIT
1010                                           ! Transfer 2048 bytes for each record to 3561A,
1020                                           ! pause program until transfer complete
1030   NEXT I
1040   OUTPUT @Anz;"TBST 0 SEC"              ! Transfer start time record of 0 sec to 3561A
1050   DISP " "
1060   RETURN
1070   END

```

Table 4-5. HP-IB Error Codes

-100	HP-IB SYNTAX ERROR
-205	ENTRY MUST BE $< =$ or ENTRY MUST BE $> =$
-210	PHASE NOT ALLOWED IN MAP MODE
-211	TIME NOT ALLOWED IN MAP MODE
-212	START POINT GREATER THAN SIZE OF BUFFER
-213	ILLEGAL FILE REFERENCE
-214	FILE DOES NOT EXIST
-215	CANNOT PERFORM RECALL: FILE DATA INVALID
-216	CANNOT PERFORM STORE: TRACE DATA INVALID
-217	CANNOT PERFORM STORE: NO BUFFERED DATA
-218	CANNOT PERFORM STORE: _____ MORE BUBBLE RECORDS REQD
-219	ILLEGAL COMMAND: BUBBLE NOT INSTALLED
-222	NO CATALOG PRESENT
-223	NO HP-IB LISTENER; HP-IB ABORTED
-224	ILLEGAL COMMAND WHEN TRACE IS A MATH FUNCTION
-225	ONLY SELF TEST COMMANDS ALLOWED
-226	SYSTEM BUSY, ONLY ABORT COMMANDS ALLOWED
-227	TALK ONLY MUST BE ON TO PRINT OR PLOT
-229	WARNING, PRESENT ADDRESS IS STILL IN USE
-230	HP-IB ACTIVITY DETECTED WITH TALK ONLY ON
-233	MEMORY BUSY
-234	CONTROLLER PRESENT, TALK ONLY NOT ALLOWED
-235	ENTRY OF ZERO INVALID
-236	HP-IB LOCAL LOCKOUT SET
-237	HP-IB REMOTE SET
238	CANNOT DO OUTPUT, NO BUFFERED DATA
-239	ILLEGAL MATH FUNCTION
-241	CANNOT PERFORM STORE: MAP INCOMPLETE
-242	CANNOT PERFORM RECALL: MAP IN PROGRESS
-243	MAX ALLOWABLE INDEX FOR THIS MAP STORE IS _____
-244	UNRECOVERABLE TRACE IN RECALLED MAP
-245	CENTER FREQ MUST BE $< \text{_____}$ HERTZ
-246	ONLY ZOOM FACTOR=1 ALLOWED
-249	DIVIDE BY CONSTANT ZERO
-250	MEASUREMENT DATA DOES NOT MATCH FUNCTION
-251	STORED DATA IS NOT PROPER TYPE
-252	M1 DOES NOT CONTAIN VALID DATA
-253	M2 DOES NOT CONTAIN VALID DATA
-255	CANNOT DO MATH ON STORED TIME DATA
-256	ONLY +, -, *, / ALLOWED ON 1/1 OR 1/3 OCTAVE DATA
-257	NARROW BAND AND OCTAVE DATA MAY NOT BE COMBINED
-258	PHASE DATA NOT AVAILABLE IN OCTAVE MODES
-259	CANNOT COMBINE 1/1 AND 1/3 OCTAVE DATA
-261	MARKER UNDEFINED
-262	INCORRECT INPUT LENGTH
-263	MARKER VALUE NOT A VALID ENTRY

Table 4-5 Continued

-264	COMMAND INVALID FOR TIME TRACE
-265	COMMAND INVALID WHEN MEASUREMENT IS PAUSED
-266	PRE-TRIG LIMIT _____ RECORDS (_____ SECS)
-267	POST-TRIG LIMIT _____ RECORDS (_____ SECS)
-268	INSUFFICIENT DATA FOR PROCESSING
-269	EXTERNAL SAMPLING NOT ALLOWED IN OCTAVE MODES
-270	COMMAND INVALID IN TIME CAPTURE WITH MAP DISPLAY
-271	MAPS NOT AVAILABLE IN OCTAVE MODES
-272	AVERAGE MAG ONLY AVAILABLE IN TIME CAPTURE MODE
-273	INPUT MAG NOT AVAILABLE IN TIME CAPTURE MODE
-274	ILLEGAL COMMAND FOR A NON-MAGNITUDE TRACE
-276	COMMAND ONLY VALID IN TIME CAPTURE MODE
-277	SPECIAL MARKERS NOT ALLOWED IN OCTAVE MODES
-280	COMMAND INVALID: UNITS ARE ORDERS WITH EXT SAMPLE
-281	COMMAND INVALID: MAP IS OFF
-282	COMMAND NOT VALID IN OCTAVE MODE
-283	COMMAND ONLY VALID IN OCTAVE MODE
-284	MATH CONSTANT MUST BE ≤ 3276 FOR PHASE or MATH CONSTANT MUST BE ≥ -3276 FOR PHASE
-285	DELETED FILE HAS BEEN RESTORED
-286	FILE DOES NOT EXIST OR HAS BEEN DELETED
-287	COMMAND INVALID IN MAP MODE
-288	COMMAND INVALID FOR STORED TRACE
-289	CHECKSUM ERROR DETECTED
-291	STORED MATH NOT ALLOWED IN MAP MODE
-292	ILLEGAL SUFFIX FOR THIS ENTRY
-293	CANNOT CONTINUE AVERAGE, AUTO RANGE OR CAL OCCURED
-294	REAL VALUE OUT OF RANGE
-295	INVALID TRACE DATA
-296	OCTAVE TRACES NOT ALLOWED IN MAP
-297	COMMAND INVALID FOR PHASE TRACE
-298	WARNING: REQUESTED MARKER POSITION OUTSIDE DATA LIMITS
-299	UNABLE TO DEFINE UNIT@MARKER WHEN MARKER = 0 VOLTS
-320	CAL FAILURE: FFT TIMEOUT
-321	DMA ERROR DETECTED or CAL FAILURE: DMA TIMEOUT
-322	NO INTERNAL CLOCK
-323	FRONTEND PROGRAMMING ERROR DETECTED
-324	BUBBLE MEMORY ERROR: RECALL FAILED
-325	BUBBLE MEMORY ERROR: STORE FAILED
-326	NONVOLATILE MEMORY ERROR: FORMAT REQUIRED
-327	BUBBLE MEMORY ERROR: CANNOT INITIALIZE
-328	CMOS MEMORY ERROR: RECALL FAILED
-329	NONVOLATILE MEMORY DIRECTORY READ ERROR
-330	CAL FAILURE: PRN PHASE BAD AT 2KHZ
-331	CAL FAILURE: NO TRIGGER
-332	CAL FAILURE: A/D COUNTER MISMATCH
-333	CAL FAILURE: CORRECTION TOO LARGE
-334	CAL FAILURE: 64KHZ PHASE UNDEFINED
-510	ESR PHASE COUNTER OVERFLOW
-511	EXTERNAL SAMPLE TOO FAST OR INCOMPATIBLE

Table 4-6. HP-IB Programming Summary

FRONT PANEL KEY	MENU ENTRY	HP-IB MNEMONIC	RANGE	SUFFIX	DESCRIPTION
ARM	NONE	MARM			Arm trigger circuits via HP-IB
AVERAGE					Note <i>Changing type of averaging during a measurement restarts the measurement.</i>
	NONE	AVG	EXCLUSIVE SELECTION		Display average menu
	OFF	AVOF			Average off
	RMS	AVRS			Select RMS averaging
	RMS EXP WGHT	AVRX			Select RMS exponential weighting averaging
	PEAK HOLD	AVPH	1-16383	ENT	Select peak hold averaging
	TIME	AVTI			Select time averaging
	DEFINE NUM AVGS	NAVG			Define number of averages
	OFF	ATOF	EXCLUSIVE SELECTION		Third octave average off
	OCTAVE RMS	ATRM			Select third octave RMS averaging
	OCTAVE EXP WGHT	ATRE			Select third octave RMS exponential weighting averaging
	OCTAVE PK HOLD	ATPH			Select third octave peak hold averaging
	OCTAVE PK CONT	ATPC	1-16383	ENT	Select third octave peak hold continuous averaging
	DEFINE NUM AVGS	NAVT			Define number averages for third octave mode
	SETUP SELECT	ASMS	0-100	PCT ON/OFF	Display average setup select menu
	DEFINE AVG OVLP	AVOP			Define average overlap
	OVLD REJ ON OFF	OV RJ			Enable/disable overload rejection
	NORMAL DISPLAY	NAVD			Select normal display (not available peak hold and RMS exponential averaging)
	FAST DISPLAY	FAVD	EXCLUSIVE SELECTION		Fast average display (not available peak hold and RMS exponential averaging)
	REPEAT DISPLAY	RAVD			Select repeat display (not available peak hold and RMS exponential averaging)
	CONT	AVPC	EXCLUSIVE SELECTION		Enable peak hold continuous averaging (peak hold mode selected — AVPH)
	FINITE	AVPF			Enable peak hold finite averaging (peak hold mode selected — AVPH)
DEFINE TRACE	NONE	DFTR			Display define trace menu
	MAG	MAG			Select magnitude display
	PHASE	PHS	TIME		Select phase display (narrow band and time capture modes)
	TIME	TIME			Select time display
	INPUT MAG	INMG	AVERAGE MAG		Select input magnitude display (narrow band and third octave modes)
	AVERAGE MAG	AVMG			Select average magnitude display (time capture)
	MATH FUNCTION	MFCN			Select math function display

Table 4-6 Continued

FRONT PANEL KEY	MENU ENTRY	HP-IB MNEMONIC	RANGE	SUFFIX	DESCRIPTION					
DEFINE TRACE (Cont)	DEFINE MATH FCN	DMFN	"F1F2F3"		Define math function (Use MG/BW for spectral density)					
			MG			} SELECT ONE FOR F1	Magnitude trace math function			
			M1				Math file 1			
			M2				Math file 2			
			PH			} SELECT ONE FOR F2	Phase trace			
			+				Add			
			-				Subtract			
			*				Multiply			
			/				Divide			
			SINT			} SELECT ONE FOR F3 IF F2 IS +, -, *, OR /	Single integration			
			DINT				Double integration			
			DIFF				Differentiate			
			MORP			} ENT	Magnitude or phase trace			
			M1				Math file 1			
			M2				Math file 2			
			K1				Constant 1			
			K2			} ENT	Constant 2			
			BW				Bandwidth			
						DEFINE K1	DEFK		ENT	Define K1
						DEFINE K2	DESK		ENT	Define K2
	TIME SELECT	TMMS			Display time select menu					
	TIME REAL	TIRE			Select real time display (Narrow band and time capture modes)					
	TIME IMAG	TIAG			Select imaginary time display (Narrow band and time capture modes)					
	INPUT TIME	INTI			Select input time					
	COMPRESS REAL	BBCR			Select compressed baseband real time (time capture mode)					
	COMPRESS IMAG	BBCI			Select compressed baseband imaginary time (time capture mode)					
	TIME HI SPAN	OTHS			Select third octave high span					
	TIME MID SPAN	OTMS			Select third octave mid span					
	TIME LO SPAN	OTLS			Select third octave low span					
DOWN ARROW	NONE	DOWN			Down arrow					
FORMAT	NONE	FRMT			Display format menu					
	SINGLE	SNGL			Single trace display					
	UPPER LOWER	UPLO			Dual trace upper lower display					
	FRONT BACK	FRBK			Dual trace front back display					
	MAG MAP (CLEAR)	MAGM			Magnitude map display					
	VERTICAL OFFSET	MAPV			Vertical map display					
	VERTICAL OFFSET	MAPF			Offset map display					
	SNGL MAP FULL MAP	SINM			Single map display					
	SNGL MAP FULL MAP	FULM			Full map display					
	DEFINE # IN MAP	MPSZ	1-60	ENT	Define number of traces in map (map size)					

Table 4-6 Continued

FRONT PANEL KEY	MENU ENTRY	HP-IB MNEMONIC	RANGE	SUFFIX	DESCRIPTION
FREQ	NONE	FREQ			Display frequency menu
	0-100 kHz	MAXS			Select maximum span
	DEFINE START	SF	0-100kHz	MHZ, HZ, KHZ MRPM, RPM, KRPM, MORD, ORD, KORD	Define start frequency
	DEFINE CENTER	CF	0-100kHz	MHZ, HZ, KHZ MRPM, RPM, KRPM MORD, ORD, KORD	Define center frequency
	DEFINE SPAN	SP	.01024Hz- 100kHz	MHZ, HZ, KHZ, MRPM, RPM, KRPM MORD, ORD KORD	Define display span
	DEFINE TIME LEN	TL	4mS- 651 Min.	USEC, MSEC, SEC, MIN	Define time length
	FRQ AXIS LIN LOG FRQ AXIS LIN LOG	LIN } LOG }	EXCLUSIVE SELECTION		Select linear frequency axis Select logarithmic frequency axis
	MAX STOP	TOMB			Select third octave maximum band
	DEFINE STOP FRQ	OCST	1.25, 2.5, 5, 10, 20, 40, 80 kHz	MHZ, HZ, KHZ	Define octave stop frequency
	DEFINE STOP BND	OCSB	31, 34, 37, 40, 43, 46, 49	BAND	Define octave stop band
INPUT	NONE	INPT		ON/OFF	Display input menu
	AUTO CAL ON OFF	ACAL		ON/OFF	Enable/disable auto calibration
	SINGLE CAL	SCAL			Enable single auto calibration
	COUPLE AC DC	ICPL		AC/DC	Select ac/dc input coupling
	A WT FLT ON OFF	AWTF		ON/OFF	Enable/disable A-weighting filter
	ICP CURRENT ON OFF	ICPC	ON/OFF		Enable/disable ICP current source
	CAL SIG ON OFF	CSIG		ON/OFF	Enable/disable calibration signal source
KEYPAD	NONE		0-9		Numeric characters
	NONE		.		Decimal point
	NONE		-		Negative
	NONE		+		Positive

Table 4-6 Continued

FRONT PANEL KEY	MENU ENTRY	HP-IB MNEMONIC	RANGE	SUFFIX	DESCRIPTION
MKR	NONE	MKR			Display marker menu
	MKR ON OFF	MMK		ON/OFF	Enable/disable marker
	MKR->PK	MKPK			Move marker to peak signal
	MKR->FULL SCL	MKFS			Assign full scale to marker value
	MKR->CTR FRQ	MKCT			Move marker to center frequency
	PEAK TRK ON OFF	MSPT		ON/OFF	Enable/disable peak track
	STEP ON OFF	MSTP		ON/OFF	Enable/disable marker step
	DEFINE MKR POS	MMKP	0-100 kHz	MHZ, HZ, KHZ MRPM, RPM, KRPM MORD, ORD, KORD USEC, MSEC SEC, MIN MREV, REV, KREV	Move marker to specified position (MREV, REV, KREV apply only to time traces)
MKR VALUE	NONE	MKVL			Enter marker value
MODE	NONE	MSMD	} EXCLUSIVE SELECTION		Display mode menu
	NARROW BAND	NABM		Select narrow band mode	
	THIRD OCTAVE	TOCM		Select third octave mode	
	FULL OCTAVE	FOCM		Select full octave mode	
	TIME CAPTURE	TACM		Select time capture mode	
	EXT SAMP ON OFF	EXTS		ON/OFF	Enable/disable external sample
	DEFINE PULS/REV	UDPR		ENT	Define units pulses/revolution
	TEST SELECT	TEMS			Display test select menu
	DEFINE TEST NUM	TNUM		ENT	Define test number
	START SNGL TST	SSTS			Start single test
	START CONT TST	SCTS			Start continuous test
	STOP TEST	SPTS			Stop test
	ERR STOP ON OFF	ERST		ON/OFF	Enable/disable error stop
EXIT TEST MODE	EXTM			Exit test mode	
CONTINUE	CTTS			Continue test	
NEXT TRACE	NONE	SLTA			Select trace A
	NONE	SLTB			Select trace B
	NONE	SLMT	1-60	ENT	Select map trace number
PAUSE/CONT	NONE	PAUS			Pause measurement (using PAUS im- mediately after an autorange can leave the -hp-3561A input range in- correctly set. If autorange is used, allow time for the -hp-3561A to select the correct range.)
	NONE	CONT			Continue measurement

Table 4-6 Continued

FRONT PANEL KEY	MENU ENTRY	HP-IB MNEMONIC	RANGE	SUFFIX	DESCRIPTION
PLOT	NONE	PLOT			Display plot menu
	PLOT	PLT			Plot display
	PLOT MARKER	PLMK			Plot Marker
	COPY TO PRINTER	PLCP			Plot display copy on printer
	ANNOTATE ON OFF	PLAN		ON/OFF	Enable/disable plot annotation
	MKR LIST ON OFF	PLML		ON/OFF	Enable/disable marker listing
	GRID ON/OFF	GRID		ON/OFF	Enable/disable plotting grid
	SETUP SELECT	PLMS			Display plot setup menu
	DEFAULT SETUP	PLDS			Select default setup
	PLOT SPD SLOW FST	PLS		FAST/SLOW	Select fast/slow speed plot
	DEFINE A LINE	PDAL	1-7	ENT	Define A line
	DEFINE B LINE	PDBL	1-7	ENT	Define B line
	DEFINE A PEN	PDAP	0-127	ENT	Define A pen
	DEFINE B PEN	PDBP	0-127	ENT	Define B pen
	DEFINE GRID PEN	PDGP	0-127	ENT	Define grid pen
	PRESET	NONE	RST		
RANGE	NONE	RANG			Display range menu
	AUTO RNG ON OFF	ARNG		ON/OFF	Enable/disable auto-ranging
	DEFINE RANGE	DRNG	+ 22.39	MVRM, VRMS, DBV MW, W, DBM DBEU, EU, ERMS	Define input sensitivity range
RECALL	SINGLE AUTO RNG	SARG			Enable single auto range
	NONE	RECL			Display recall menu
	RECALL PWR DOWN	RPWD			Recall power down state
	DEFINE FILENAME	DSFN	"FILENAME"		Define state file name (restricted to 1 through 6 without bubble memory)
RECALL	USE CAT FILENAME	UCFN			Use catalog file name
	RECALL STATE	RSTA			Recall state from memory file defined by DSFN or UCFN
REL MKR	CATALOG ON OFF	CATD		ON/OFF	Enable/disable catalog display
	NONE	RMKR			Display relative marker menu
	REL MKR ON OFF	MREL		ON/OFF	Enable/disable relative markers
	MKR ->REF	MRRF			Marker values into reference registers
REL MKR	DEFINE MAG REF	MRMR		MVRMS, VRMS, DBV MW, W, DBM ENT, DBEU, EU, ERMS	Define magnitude reference
	DEFINE PHAS REF	MRPR	±180	DEC, ENT	Define phase reference
	DEFINE FREQ REF	MRFR	0-100 kHz	MHZ, HZ, KHZ MRPM, RPM, KRPM, MORD, ORD, KORD	Define frequency reference
	DEFINE TIME REF	MRTR		USEC, MSEC, SEC, MIN MREV, REV, KREV	Define time reference

Table 4-6 Continued

FRONT PANEL KEY	MENU ENTRY	HP-IB MNEMONIC	RANGE	SUFFIX	DESCRIPTION
SAVE	NONE	SAVE			Display save menu
	DEFINE FILENAME	DSFN	"FILENAME"		Define file name (restricted to 1 through 6 without bubble memory)
	USE CAT FILENAME	UCFN			Use catalog file name
	SAVE STATE	SSTA			Save state in memory file defined by DSFN or UCFN
SOURCE	DELETE	DSUP			Delete state file named by DSFN or UCFN
	CATALOG ON OFF	CATD		ON/OFF	Enable/disable catalog display
	NONE	SRCE			Display source menu
	OFF	SOOF			Source off
SPCL MKR	PERIODIC NOISE	PERN	EXCLUSIVE SELECTION		Enable periodic noise
	RANDOM NOISE	RAND			Enable random noise
	IMPULSE	IMFR			Enable impulse output
	DEFINE ATTEN	SATN		0-40.5	DBR
SPCL MKR	DEFINE REC/IMPL	SDRI	1-32767	REC	Define records per impulse
	NONE	SMKR			Display special marker menu
	OFF	MSOF			Special markers off
	BAND POWER	MSBP			Select band power special marker
	HARMONIC	MSHR			Select harmonic special marker
	SIDEBAND	MSSB			Select sideband power special marker
	SETUP SELECT	SMMS			Display setup select menu
	DEFINE CARR FRQ	MSCF	0-100 kHz	MHZ, HZ, KHZ MRPM, RPM, KRPM MORD, ORD, KORD	Define carrier frequency
	DEFINE SB FRQ	MSSF	0-100 kHz	MHZ, HZ KHZ MRPM, RPM, KRPM, MORD, ORD, KORD	Define sideband frequency
	DEFINE NUM SB	MSNS	0-10	ENT	Define number of sidebands
DEFINE FUND FRQ	MSFF	0-100 kHz	MHZ, HZ, KHZ MRPM, RPM, KRPM MORD, ORD, KORD	Define fundamental frequency	
DEFINE NUM HARM	MSNH	0-20	ENT	Define number of harmonics	
DEFINE LEFT FRQ	MSLF	0-100 kHz	MHZ, HZ, KHZ MRPM, RPM, KRPM MORD, ORD, KORD	Define left frequency	
DEFINE RIGHT FRQ	MSRF	0-100 kHz	MHZ, HZ, KHZ MRPM, RPM, KRPM MORD, ORD, KORD	Define right frequency	

Table 4-6 Continued

FRONT PANEL KEY	MENU ENTRY	HP-IB MNEMONIC	RANGE	SUFFIX	DESCRIPTION
START	NONE	STRT			Start measurement
STORE/RECALL	NONE	STRC			Display store/recall menu
	TRACELBL ON OFF	TRLB		ON/OFF	Enable/disable trace label
	DEFINE TRACELBL	DTLB	"LABEL"		Define trace label
	STORE IN M1	STFM			Store in first math file (M1)
	STORE IN M2	STSM			Store in second math file (M2)
	RECALL M1	RTFM			Recall trace from first math file (M1)
	RECALL M2	RTSM			Recall trace from second math file (M2)
	TRACEFILE SELECT	RTRS			Display bubble memory file menu
	DEFINE FILENAME	DTFN	"FILENAME"		Define trace bubble memory file name
	USE CAT FILENAME	UCFN			Use catalog filename
	STORE TRACE	STTR			Store trace named by DTFN or UCFN in bubble memory
	RECALL TRACE	RETR			Recall trace named by DTFN or UCFN from bubble memory
	DELETE	DTRC			Delete trace named by DTFN or UCFN from bubble memory
	CATALOG ON OFF	CATD			ON/OFF Enable/disable catalog display
TIME BUFFER	NONE	TBUF			Display time buffer menu
	START CAPTURE	SCAP			Start time capture
	DEFINE # OF REC	TBNR	1-40	REC	Define number of time records
	DEFINE START t	TBST	0-28646 Min	USEC,MSEC, SEC, MIN MREV,REV, KREV	Define start time record
	DEFINE % INCR	TBPI	.1-100	PCT	Define percent increment
	DEFINE ZOOM X	TBZX	1, 2, 4, 5, 8, 10, 16, 20, 25, 32, 40	ENT	Define zoom factor
	DEFINE ZOOM FRQ	TBZF		MHZ, HZ, KHZ MRPM, RPM KRPM MORD, ORD, KORD	
	BUFFERFILE SELECT	TBMS			Display time buffer file menu
	DEFINE FILENAME	DBFN	"FILENAME"		Define time buffer file name
	USE CAT FILENAME	UCFN			Use catalog file name
	RECALL BUFFER	RBUF			Recall time buffer file defined by DBFN or UCFN
	STORE BUFFER	SBUF			Store time buffer file defined by DBFN or UCFN
	DELETE	DBUF			Delete time buffer file defined by DBFN or UCFN
	CATALOG ON OFF	CATD			ON/OFF Enable/disable catalog display

Table 4-6 Continued

FRONT PANEL KEY	MENU ENTRY	HP-IB MNEMONIC	RANGE	SUFFIX	DESCRIPTION
TRIG SEL	NONE	TRIG			Trig display trigger menu
	FREE RUN TRIGGER	TRFR	EXCLUSIVE SELECTION		Enable free running trigger
	FREE RUN TRIGGER	TRGR			
	MAN ARM AUTO ARM	TRMA	EXCLUSIVE SELECTION		Enable trigger mode
	MAN ARM AUTO ARM	TRAA			
	INPUT TRIGGER	IPTG	EXCLUSIVE SELECTION		Enable manual arm
	EXTERNAL TRIGGER	EXT			
	SOURCE TRIGGER	SCT			
	INTERNAL TRIGGER	INTT			
	NONE	HPT			Enable auto arm
	SETUP SELECT	TSMS			Select external trigger
	SLOPE POS NEG	SLOP		POS/NEG	Select input trigger
	DEFINE % OF RNGE	TLPR	±140	PCT	Select source trigger
	DELAY ON OFF	DELY		ON/OFF	Select internal trigger
	DEFINE + - DELAY	DLY		USEC, MSEC, SEC, MIN MREV, REV, KREV	Select HPIB trigger
					Display trigger setup menu
					Select positive/negative trigger slope
					Define trigger level as percent of input range (5% steps)
					Enable/disable trigger delay
					Define delay time
UNITS	NONE	UNIT			Display units menu
	VOLT(dBV)	UVVT			Select vertical axis units — volts/dBV
	VOLT 2 (dBV)	UVVS			Select vertical axis units V ² /dBV
	mW(dBm)	UVDB			Select vertical axis units — watt/dBm
	EU(dBEU)	UVUL			Select vertical units — engineering units
	EU 2(dBEU)	UVES			Select vertical units EU ² /dBEU
	UNIT CAL SELECT	UNMS			Display unit calibration select menu
	X UNITS SELECT	UXMS			Display X units select menu
	HZ(SEC)	UHHZ			Select horizontal units — Hertz/ seconds
	RPM(SEC)	UHRP			Select horizontal units — rpm/seconds
	ORD(REV)	UHOR			Select horizontal units — orders/ revolutions
	DEFINE HZ/ORD	UDHC		MHZ, HZ, KHZ	Define hertz/order calibration
	DEFINE IMPEDNCE	UDDM	1Ω - 25 kΩ	MOHM, OHM, KOHM	Define impedance
	DEFINE V/UNIT	UDVU		MVPK, VPK	Define units in volts/unit
	DEFINE UNIT @ MKR	UDUM		DBEU, EU EURMS	Define units at marker
	DEFINE EU LBL	UDUL	"LABEL"		Define label for engineering units
	DEFINE EU=0dB	UDBR		DBEU, EU EURMS	Define engineering units equal to 0dB

Table 4-6 Continued

FRONT PANEL KEY	MENU ENTRY	HP-IB MNEMONIC	RANGE	SUFFIX	DESCRIPTION
UP ARROW	NONE	UP			Up arrow
VERT SCALE	NONE	VSCL			Display vertical scale menu
	SINGLE AUTO SCL	SASC			Enable single auto scale
	FULL SCL HOLD TRK	VSHS	} EXCLUSIVE SELECTION		Hold vertical scale
	FULL SCL HOLD TRK	VSRT			Track input range with vertical scale
	DEFINE FULL SCL	VSFS		MVRM, VRMS, DBV MW, W DBM, DB ENT, DBEU, EU, ERMS DBR	Define full scale
	DEFINE dB/DIV	VSDB	.5-50		Define vertical scale division in dB
	LINEAR LOG	VSLI	} EXCLUSIVE SELECTION		Select linear vertical scale
	LINEAR LOG	VSLG			Select logarithmic vertical scale
	DEFINE CENTER	PSCT	± 320	DEG	Define phase center
	DEFINE DEG/DIV	PHDG	10, 15, 30, 45, 60	DEG	Define degrees per division
	AUTO SCL	SASC			Enable single auto scale
	FULL SCL HOLD TRK	VSHS			Hold vertical scale
	FULL SCL HOLD TRK	VSRT			Track input range with vertical scale
	DEFINE CENTER	TSCT	± 42V	MVPK, VPK, EU	Define time scale center
	DEFINE UNIT/DIV	TSUD	0-10V	MVPK, VPK, EU	Define time scale units per division
VIEW ON/OFF	NONE	VWST		ON/OFF	Enable/disable view state display
WINDOW	NONE	WNDO			Display window menu
	FLAT TOP (HI ACC)	FLAT	} EXCLUSIVE SELECTION		Select flat top window
	HANNING	HANN			Select hanning window
	UNIFORM	UNIF			Select uniform window
	EXPONL	XPN			Select exponential window
	DEFINE EXP TC	XPTC	2-1024	REC	Define exponential time constant

Table 4-6 Continued

HP-IB ONLY COMMAND SUMMARY

HP-IB MNEMONIC	RANGE	SUFFIX	DESCRIPTION
ASCII DUMPS			
DDSA			Dump display alphanumerics
DFCA			Dump file catalog in ASCII
BEEPER CONTROL			
BEEP		ON/OFF	Enable/disable beeper
DISPLAY CONTROL			
CRCN		ON/OFF	CRT control
CRTC		ON/OFF	CRT clear
C RTP Row, Column "message"			CRT print (Row from 1 to 26, Column from 1 to 72)
INDD			Instrument display disable
INDE			Instrument display enable
SFBP			Select full bright plane
SHBP			Select half bright plane
DISPLAY OF MENUS AND HP-IB COMMANDS			
DIAG		ON/OFF	Enable/disable diagnostics and menu display
FRONT PANEL DETECTION			
KEYD			Disable key echo
KEYE			Enable key echo
KEY?			Read key register
RFGS			Read float ground switch
IDENTIFICATION			
ID?			Send ID (HP3561A)
OPT?			Send option code (1 = bubble memory)
REV?			Send revision dates (pair of four digit integers)
SAVING OR RESTORING INSTRUMENT SETUPS			
SET			Load setup data (total bytes = 630)
SET?			Read setup data (total bytes = 630)
INTERNAL BUFFERS			
DSTB			Dump selected and trace in binary (total bytes = 1028)
DTBB			Dump time buffer in binary (variable length)
LMTB			Load magnitude trace in binary (total bytes = 806)
LPTB			Load phase trace in binary (total bytes = 806)
LSTB			Load selected trace in binary (total bytes = 1028)
LTBB			Load time buffer in binary (variable length)

Table 4-7 Continued

HP-IB MNEMONIC	FRONT PANEL KEY OR AREA	DESCRIPTION [Brackets contain range information]	TYPE
CF	FREQ	[<0—100 kHz>] Define center frequency	Key
CONT	PAUSE/CONT	Continue measurement	Key
CRCN	HPIB	Display power control	Display
CRTC	HPIB	Display clear	Display
CRTP	HPIB	[ROW],[COLUMN]"[STRING]" Display print	Display
CSIG	INPUT	Enable/disable calibration signal source	Key
CTTS	MODE	Continue test	Key
DBEU	UNITS	dBEU	Suffix
DBFN	TIME BUFFER	<"FILENAME"> Define time buffer filename	Key
DBM	UNITS	dBm	Suffix
DBR	UNITS	dB	Suffix
DBUF	TIME BUFFER	Delete time buffer file defined by DBFN or UCFN	Key
DBV	UNITS	dBV	Suffix
DDSA	HPIB	Dump display alphanumerics	(I/O)
DEFK	DEFINE TRACE	Define K1	Key
DEG	UNITS	Degree	Suffix
DELY	TRIG SEL	Enable/disable trigger delay	Key
DESK	DEFINE TRACE	Define K2	Key
DFCA	HPIB	Dump file catalog in ASCII	(I/O)
DFTR	DEFINE TRACE	Display define trace menu	Key
DIAG	HPIB	Enable/disable diagnostics and menu display	Key
DLY	TRIG SEL	Define delay time	Key
DMFN	DEFINE TRACE	<"F1F2F3"> Define math function (Use MG/BW for spectral density)	Key
DOWN	Keypad	Down arrow	Key
DRNG	RANGE	[<+22.39>] Define input sensitivity range	Key
DSFN	RECALL, SAVE	<"FILENAME"> Define state file name (restricted)	Key
DSTB	HPIB	Dump selected trace in binary	(I/O)
DSUP	SAVE	Delete state file named by DSFN or UCFN	Key
DTBB	HPIB	Dump time buffer in binary	(I/O)
DTFN	STORE/RECALL	<"FILENAME"> Define trace bubble memory file name	Key
DTLB	STORE/RECALL	<"LABEL"> Define trace label	Key
DTRC	STORE/RECALL	Delete from bubble memory the trace named by DTFN or UCFN	Key
ENT	Units	Enter	Suffix
ERMS	UNITS	EU RMS	Suffix
ERR?	HPIB	Read error code	(I/O)
ERST	MODE	Enable/disable error stop	Key
EU	UNITS	EU	Suffix
EXT	TRIG SEL	Select external trigger	Key

Table 4-7 Continued

HP-IB MNEMONIC	FRONT PANEL KEY OR AREA	DESCRIPTION [Brackets contain range information]	TYPE
EXTM	MODE	Exit test mode	Key
EXTS	MODE	Enable/disable external sample	Key
FAVD	AVERAGE	Fast average display (not available with peak hold and RMS exponential averaging)	Key
FLAT	WINDOW	Select flat top window	Key
FOCM	MODE	Select full octave mode	Key
FRBK	FORMAT	Dual trace front/back display	Key
FREQ	FREQ	Display frequency menu	Key
FRMT	FORMAT	Display format menu	Key
FULM	FORMAT	Full map display	Key
GRID	PLOT	Enable/disable plotting grid	Key
HALT	Primitive	Halt	Primitive
HANN	WINDOW	Select hanning window	Key
HPT	TRIG SEL	Select HPIB trigger	Key
HZ	UNITS	Hertz	Suffix
ICPC	INPUT	Enable/disable ICP current source	Key
IOPL	INPUT	Select AC/DC input coupling	Key
ID?	HPIB	Send ID (HP3561A)	(I/O)
IMFR	SOURCE	Enable impulse output	Key
INDD	HPIB	Disable instrument display	Display
INDE	HPIB	Enable instrument display	Display
INMG	DEFINE TRACE	Select input magnitude display (narrow band and third octave modes)	Key
INPT	INPUT	Display input menu	Key
INTI	DEFINE TRACE	Select input time	Key
INTT	TRIG SEL	Select internal trigger	Key
IPTG	TRIG SEL	Select input trigger	Key
KEY?	HPIB	Read key register	(I/O)
KEYD	HPIB	Disable key echo	(key echo)
KEYE	HPIB	Enable key echo	(key echo)
KHZ	UNITS	kHz	Suffix
KOHM	UNITS	k Ω	Suffix
KORD	UNITS	Kilorders	Suffix
KREV	UNITS	Kilorev	Suffix
KRPM	UNITS	KiloRPM	Suffix
LIN	FREQ	Select linear frequency axis	Key
LMTB	HPIB	Load magnitude trace in binary	(I/O)
LOG	FREQ	Select log frequency axis	Key
LPTB	HPIB	Load phase trace in binary	Key
LSTB	HPIB	Load selected trace in binary	(I/O)
LTBB	HPIB	Load time buffer in binary	(I/O)

Table 4-7 Continued

HP-IB MNEMONIC	FRONT PANEL KEY OR AREA	DESCRIPTION [Brackets contain range information]	TYPE
MAG	DEFINE TRACE	Select magnitude display	Key
MAGM	FORMAT	Magnitude map display	Key
MAPF	FORMAT	Offset map display	Key
MAPV	FORMAT	Vertical map display	Key
MARM	ARM	Arm	Key
MAXS	FREQ	Select maximum span	Key
MBTK	MKR	Enable/disable marker band track	Key
MFCN	DEFINE TRACE	Select math function display	Key
MHZ	UNITS	mHz	Suffix
MIN	UNITS	Minute	Suffix
MKCT	MKR	Move marker to center frequency	Key
MKFS	MKR	Assign full scale to marker value	Key
MKPK	MKR	Move marker to peak signal	Key
MKR	MKR	Display marker menu	Key
MKVL	MKR VALUE	Enter marker value	Key
MMK	MKR	Enable/disable marker	Key
MMKP	MKR	[<0–100 kHz>] Move marker to specified position	Key
MMLF	HPIB	Move marker left one display position	Marker
MMRT	HPIB	Move marker right one display position	Marker
MOHM	UNITS	Milliohm	Suffix
MORD	UNITS	Milliorders	Suffix
MPSZ	FORMAT	[<1–60>] Define number of traces in map	Key
MREL	REL MKR	Enable/disable relative marker	Key
MREV	UNITS	Millirevolutions	Suffix
MRFR	REL MKR	[<0–100 kHz>] Define frequency reference	Key
MRMR	REL MKR	Define magnitude reference	Key
MRPM	UNITS	MilliRPM	Suffix
MRPR	REL MKR	[<±180>] Define phase reference	Key
MRRF	REL MKR	Marker values into reference registers	Key
MRTR	REL MKR	Define time reference	Key
MSBP	SPCL MKR	Select band power special marker	Key
MSCF	SPCL MKR	[<0–100 kHz>] Define carrier frequency	Key
MSEC	UNITS	Millisecond	Suffix
MSFF	SPCL MKR	[<0–100 kHz>] Define fundamental frequency	Key
MSHR	SPCL MKR	Select harmonic special marker	Key
MSLF	SPCL MKR	[<0–100 kHz>] Define left frequency	Key
MSMD	MODE	Display mode menu	Key
MSNH	SPCL MKR	[<0–20>] Define number of harmonics	Key
MSNS	SPCL MKR	[<0–10>] Define number of sidebands	Key

Table 4-7 Continued

HP-IB MNEMONIC	FRONT PANEL KEY OR AREA	DESCRIPTION [Brackets contain range information]	TYPE
MSOF	SPCL MKR	Special markers off	Key
MSPT	MKR	Enable/disable peak track	Key
MSRF	SPCL MKR	[<0–100 kHz>] Define right frequency	Key
MSSB	SPCL MKR	Select sideband power special marker	Key
MSSF	SPCL MKR	[<0–100 kHz>] Define sideband frequency	Key
MSTP	MKR	Enable/disable marker step	Key
MVMK	HPIB	<1–401> Move marker to selected binary	Marker
MVPK	UNITS	mV peak	Suffix
MVRM	UNITS	mV RMS	Suffix
MW	UNITS	mW	Suffix
NABM	MODE	Select narrow band mode	Key
NAVD	AVERAGE	Select normal display (not available in peak hold and RMS exponential averaging)	Key
NAVG	AVERAGE	[<1–16383>] Define number of averages	Key
NAVT	AVERAGE	[<1–16383>] Define number of averages for third octave mode	Key
OCSB	FREQ	[<31, 34, 37, 40, 43, 46, 49>] Define octave stop band	Key
OCST	FREQ	[<1.25, 2.5, 5, 10, 20, 40, 80 kHz>] Define octave stop frequency	Key
OHM	UNITS	Ω	Suffix
OPT?	HPIB	Send option code (1=bubble memory)	(I/O)
ORD	UNITS	Orders	Suffix
OTHS	DEFINE TRACE	Select third octave hi span	Key
OTLS	DEFINE TRACE	Select third octave low span	Key
OTMS	DEFINE TRACE	Select third octave mid span	Key
OVRJ	AVERAGE	Enable/disable overload rejection	Key
PAUS	PAUSE/CONT	Pause measurement	Key
PCT	UNITS	Percent	Suffix
PDAL	PLOT	[<1–7>] Define A line	Key
PDAP	PLOT	[<0–127>] Define A pen	Key
PDBL	PLOT	[<1–7>] Define B line	Key
PDBP	PLOT	[<0–127>] Define B pen	Key
PDGP	PLOT	[<0–127>] Define grid pen	Key
PERN	SOURCE	Enable periodic noise	Key
PHDG	VERT SCALE	[<10, 15, 30, 45, 60>] Define degrees per division	Key
PHS	DEFINE TRACE	Select phase display (narrow band and time capture modes)	Key
PLAN	PLOT	Enable/disable plot annotation	Key
PLCP	PLOT	Plot display copy on printer	Key
PLDS	PLOT	Select default setup	Key
PLMK	PLOT	Plot marker	Key
PLML	PLOT	Enable/disable marker listing	Key
PLMS	PLOT	Display plot setup menu	Key

Table 4-7 Continued

HP-IB MNEMONIC	FRONT PANEL KEY OR AREA	DESCRIPTION [Brackets contain range information]	TYPE
PLOT	PLOT	Display plot menu	Key
PLS	PLOT	Select fast/slow plot speed	Key
PLT	PLOT	Plot display	Key
PRGO	Primitive	<ADDRESS>	Primitive
PSCT	VERT SCALE	[<±320>] Define phase center	Key
PSRQ	HPIB	Enable/disable power on SRQ	(SRQ)
RAND	SOURCE	Enable random noise	Key
RANG	RANGE	Display range menu	Key
RAVD	AVERAGE	Select repeat display (not available with peak hold and RMS exponential averaging)	Key
RBUF	TIME BUFFER	Recall time buffer filled defined by DBFN or UCFN	Key
RDMK	HPIB	Read marker	Marker
REC	UNITS	Record	Suffix
RECL	RECALL	Display recall menu	Key
RETR	STORE/RECALL	Recall from bubble memory the trace named by DTFN or UCFN	Key
REV	UNITS	Rev	Suffix
REV?	HPIB	Send revision dates (pair of four digit integers)	(I/O)
RFGS	HPIB	Read float/ground switch	(I/O)
RMKR	REL MKR	Display relative marker menu	Key
RPM	UNITS	RPM	Suffix
RPWD	RECALL	Recall power down state	Key
RSRQ	HPIB	Read SRQ status register	(SRQ)
RST	PRESET	Preset instrument	Key
RSTA	RECALL	Recall state from memory file	Key
RTFM	STORE/RECALL	Recall trace from first math file (M1)	Key
RTRS	STORE/RECALL	Display bubble memory file menu	Key
RTSM	STORE/RECALL	Recall trace from second math file (M2)	Key
SARG	RANGE	Enable single auto range	Key
SASC	VERT SCALE	Enable single auto scale	Key
SATN	SOURCE	[<0—40.5>] Define source attenuation (2.5 dB steps)	Key
SAVE	SAVE	Display save menu	Key
SBUF	TIME BUFFER	Store time buffer file defined by DBFN or UCFN	Key
SCAL	INPUT	Enable single auto calibration	Key
SCAP	TIME BUFFER	Start time capture	Key
SCT	TRIG SEL	Select source trigger	Key
SCTS	MODE	Start continuous test	Key
SDRI	SOURCE	[<0—32767>] Define records per impulse	Key
SEC	UNITS	Second	Suffix
SET	HPIB	Load setup data	(I/O)
SET?	HPIB	Read setup data	(I/O)

Table 4-7 Continued

HP-IB MNEMONIC	FRONT PANEL KEY OR AREA	DESCRIPTION [Brackets contain range information]	TYPE
SF	FREQ	[<0–100 kHz>] Define start frequency	Key
SFBP	HPIB	Select full bright plane	Display
SHBP	HPIB	Select half bright plane	Display
SINM	FORMAT	Single map display	Key
SLMT	NEXT TRACE	[<1–60>] Select map trace number	Key
SLOP	TRIG SEL	Select positive/negative trigger slope	Key
SLTA	NEXT TRACE	Select trace A	Key
SLTB	NEXT TRACE	Select trace B	Key
SMKR	SPCL MKR	Display special marker menu	Key
SMMS	SPCL MKR	Display setup select menu	Key
SNGL	FORMAT	Single trace display	Key
SOOF	SOURCE	Source off	Key
SP	FREQ	[<.01024 Hz–100 kHz>] Define display span	Key
SPTS	MODE	Stop test	Key
SRCE	SOURCE	Display source menu	Key
SRQM	HPIB	[<0–63>] Set request mask	(SRQ)
SSTA	SAVE	Save state in memory the file defined by DSFN or UCFN	Key
SSTS	MODE	Start single test	Key
STFM	STORE/RECALL	Store in first math file (M1)	Key
STRC	STORE/RECALL	Display store/recall menu	Key
STRT	START	Start measurement	Key
STSM	STORE/RECALL	Store in second math file (M2)	Key
STTR	STORE/RECALL	Store in bubble memory the trace named by DTFN or UCFN	Key
TACM	MODE	Select time capture mode	Key
TBMS	TIME BUFFER	Display time buffer file menu	Key
TBNR	TIME BUFFER	[<1–40>] Define number of time records	Key
TBPI	TIME BUFFER	[<.1–100>] Define percent increment	Key
TBST	TIME BUFFER	[<0–28646 min>] Define start time record	Key
TBUF	TIME BUFFER	Display time buffer menu	Key
TBZF	TIME BUFFER	Define zoom frequency	Key
TBZX	TIME BUFFER	[<1, 2, 4, 5, 8, 10, 16, 20, 25, 32, 40>] Define zoom factor	Key
TEMS	MODE	Display test select menu	Key
TIAG	DEFINE TRACE	Select imaginary time display (narrow band and time capture modes)	Key
TIME	DEFINE TRACE	Select time display	Key
TIRE	DEFINE TRACE	Select real time display (narrow band and time capture modes)	Key
TL	FREQ	[<4 ms–651 min>] Define time length	Key
TLPR	TRIG SEL	[<±140>] Define trigger level as percent of input range (5% steps)	Key
TMMS	DEFINE TRACE	Display time select menu	Key
TNUM	MODE	Define test number	Key

Table 4-7 Continued

HP-IB MNEMONIC	FRONT PANEL KEY OR AREA	DESCRIPTION [Brackets contain range information]	TYPE
TOCM	MODE	Select third octave mode	Key
TOMB	FREQ	Select third octave maximum band	Key
TRAA	TRIG SEL	Enable auto arm	Key
TRFR	TRIG SEL	Enable free running trigger	Key
TRGR	TRIG SEL	Enable trigger mode	Key
TRIG	TRIG SEL	Display trigger menu	Key
TRLB	STORE/RECALL	Enable/disable trace label	Key
TRMA	TRIG SEL	Enable manual arm	Key
TSCT	VERT SCALE	[< ± 42 V>] Define time scale center	Key
TSMS	TRIG SEL	Display trigger setup menu	Key
TSUD	VERT SCALE	[<0–10 V>] Define time scale units/div	Key
UCFN	RECALL,SAVE, STORE/RECALL, TIME BUFFER	Use catalog file name	Key
UDBR	UNITS	Define engineering units equal to 0 dB	Key
UDDM	UNITS	[<1 Ω –25 k Ω >] Define impedance	Key
UDHC	UNITS	Define Hz/order calibration	Key
UDPR	MODE	Define pulses/revolution	Key
UDUL	UNITS	<"LABEL"> Define label for engineering units	Key
UDUM	UNITS	Define units at marker	Key
UDVU	UNITS	Define units in volts/unit	Key
UHHZ	UNITS	Select horizontal units of Hz/second	Key
UHOR	UNITS	Select horizontal units of orders/rev	Key
UHRP	UNITS	Select horizontal units of rpm/second	Key
UNIF	WINDOW	Select uniform window	Key
UNIT	UNITS	Display units menu	Key
UNMS	UNITS	Display unit calibration select menu	Key
UP	Keypad	Up arrow	Key
UPLO	FORMAT	Dual trace upper/lower display	Key
USEC	Units	μs	Suffix
UVDB	UNITS	Select vertical units of mW/dBm	Key
UVES	UNITS	Select vertical units of EU ² /dBEU	Key
UVUL	UNITS	Select vertical units of engineering units	Key
UVVS	UNITS	Select vertical units of V ² /dBV	Key
UVVT	UNITS	Select vertical units of V/dBV	Key
UXMS	UNITS	Display X units select menu	Key
VPK	Units	Volts peak	Suffix
VRMS	Units	Volts RMS	Suffix
VSCL	VERT SCALE	Display vertical scale menu	Key
VSDB	VERT SCALE	[<.5–5 V>] Define vertical division in dB	Key

Table 4-7 Continued

HP-IB MNEMONIC	FRONT PANEL KEY OR AREA	DESCRIPTION [Brackets contain range information]	TYPE
VSFS	VERT SCALE	Define full scale	Key
VSHS	VERT SCALE	Hold vertical scale	Key
VSLG	VERT SCALE	Select log vertical scale	Key
VSLI	VERT SCALE	Select linear vertical scale	Key
VSRT	VERT SCALE	Track input range with vertical scale	Key
VWST	VIEW ON/OFF	Enable/disable view state display	Key
W	Units	Watt	Suffix
WND0	WINDOW	Display window menu	Key
XPNI	WINDOW	Select exponential window	Key
XPTC	WINDOW	[<2-1024>] Define exponential time constant	Key

Table 4-8. Setup State Offset Bytes and Data Types

OFFSET BYTE	DATA MEANING OF DATA	TYPE	RANGE/UNITS
1	Offset	Integer	dB
3	Last X val(magnitude)	Real	Hz
11	Last X val(phase)	Real	Hz
19	Last X val(time)	Real	Seconds
27	Span number	Enumerated	0:51 0=lowest 51=highest
29	Trace A type	Enumerated	(See offset byte 31)
31	Trace B type	Enumerated	0:21 0=stored data 1=normal magnitude 2=buffer magnitude 3=octave 4=normal phase 5=buffer phase 6=Input magnitude 7=average magnitude 8=octave input maginitude 9=real time 10=imaginary time 11=input time 12=real buffer time 13=Imaginary buffer time 14=compressed real 15=compressed imaginary 16=buffered input time 17=octave time low 18=octave time mid 19=octave time high 20=octave input time 21=null time
33–64	Internal	Internal	
65	Beeper off/on	Enumerated	0:1 0=on 1=off
67–68	Unused	Unused	
69	Test number selected	Enumerated	0:1 0=on 1=off
71–72	Unused	Unused	
73	Error stop off/on	Enumerated	0:1 0=on 1=off
75	Catalog display off/on	Enumerated	0:1 0=on 1=off
77	State display off/on	Enumerated	0:1 0=on 1=off
79	Buffer filename	String[9]	
89	Buffer file type	Enumerated	0:4 0=setup 1=trace 2=buffered 3=universal 4=empty
91	Buffer indexed	Enumerated	0:2 0=indexed 1=not indexed 2=all indexed
93	Buf default index number	Integer	0:255
95	Trace default filename	String[9]	

Table 4-8 Continued

OFFSET BYTE	DATA MEANING OF DATA	TYPE	RANGE/UNITS
105	Trace default type	Enumerated	0:4 0=setup 1=trace 2=buffered 3=universal 4=reference empty
107	Trace default file index	Enumerated	0:2 0=indexed 1=not indexed 2=all indexed
109	Trace default index number	Integer	0:255
111	Setup default filename	String[9]	
121	Setup default file type	Enumerated	0:4 0=setup 1=trace 2=buffered 3=universal 4=reference empty
123	Setup file indexed	Enumerated	0:2 0=indexed 1=not indexed 2=all indexed
125	Setup default index number	Integer	0:255
127	Active trace A or B	Enumerated	0:1 0=trace A 1=trace B
129—211	Trace A information (add 84 to each offset byte for corresponding Trace B information)		
129	Trace type	Enumerated	0:2 0=magnitude 1=phase 2=time
131	Trace type	Enumerated	95:101 95=magnitude 96=trace phase 97=trace time 98=input magnitude 99=baseband magnitude 100=math function 101=recalled data
133	Time kind	Enumerated	102:109 102=input time 103=real time 104=imaginary time 105=buffer compress real 106=buffer compress imaginary 107=time low 108=time mid 109=time high
135	Full scale	Enumerated	0:1 0=tracking 1=hold
137	Magnitude full scale	Real	dB
145	DB per division	Real	dB
153	Unused	Unused	

Table 4-8 Continued

OFFSET BYTE	DATA MEANING OF DATA	TYPE	RANGE/UNITS
155	Phase center	Integer	-320:+320 degrees
157	Unused	Unused	null
159	Degrees per division	Integer	10:60 degrees
161	Time center	Real	Seconds
169	Time per division	Real	Seconds
179	Math function(1)	Enumerated	284:299 284=magnitude 285=phase 286=M1 287=M2 288=plus 289=minus 290=multiply 291=divide 292=integrate 293=double integrate 294=differentiate 295=magnitude or phase 296=k1 297=k2 298=bandwidth 299=no op
181	Math function (2)	Enumerated	(See byte 179)
183	Math function (3)	Enumerated	(See byte 179)
185	Trace label	String[18]	
213-295	Trace B information (add 84 to corresponding Trace A offset byte)		
297	Autorange off/on	Enumerated	0:1 0=on 1=off
299	Range setting in dB	Integer	-100:+100
301	Autocal off/on	Enumerated	0:1 0=on 1=off
303	AC couple off/on	Enumerated	0:1 0=on 1=off
305	A-weight off/on	Enumerated	0:1 0=on 1=off
307	ICP off/on	Enumerated	0:1 0=on 1=off
309	Cal signal off/on	Enumerated	0:1 0=on 1=off
311	Plot annotate off/on	Enumerated	0:1 0=on 1=off
313	Plot grid off/on	Enumerated	0:1 0=on 1=off
315	Plot speed fast/slow	Enumerated	0:1 0=fast 1=slow
317	Plot A line type	Integer	1:7
319	Plot B line type	Integer	1:7
325	Plot A data pen	Integer	1:127
329	Plot B data pen	Integer	1:127
333	Plot grid pen	Integer	1:127
337	Value of K1	Real	Unitless
345	Value of K2	Real	Unitless
353	Power on SRQ off/on	Enumerated	0:1 0=on 1=off

Table 4-8 Continued

OFFSET BYTE	DATA MEANING OF DATA	TYPE	RANGE/UNITS
355	Talk only off/on	Enumerated	0:1 0=on 1=off
357	Trigger free run	Enumerated	0:1 0=on 1=off
359	Trigger delay	Real	Seconds
367	Trigger delay off/on	Enumerated	0:1 0=on 1=off
369	Trigger percent	Integer	-28:+28 (Multiply by 5 for value in percent)
371	Trigger slope	Enumerated	0:1 0=positive 1=negative
373	Trigger arm	Enumerated	116:117 116=manual 117=auto
375	Trigger source	Enumerated	86:90 86=input 87=external 88=source 89=internal 90=HPIB
377	Marker off/on	Enumerated	0:1 0=on 1=off
379	Peak track off/on	Enumerated	0:1 0=on 1=off
381	Marker step off/on	Enumerated	0:1 0=on 1=off
383	Mode	Enumerated	91:94 91=mkr 92=band power 93=harmonic 94=sideband
385	Carrier frequency	Real	Hertz
393	Sideband frequency	Real	Hertz
401	Number of sidebands	Integer	1:10
403	Number of harmonics	Integer	1:10
405	Left cursor position	Real	Hertz
413	Right cursor position	Real	Hertz
421	Band track off/on	Enumerated	0:1 0=on 1=off
423	Relative off/on	Enumerated	0:1 0=on 1=off
425	Relative magnitude reference	Real	dB
433	Relative phase reference	Real	Degrees
441	Relative frequency reference	Real	Hertz
449	Relative time reference	Real	Seconds
457	Time trace relative amplitude	Real	Volts
465	Y axis linear/log	Enumerated	0:1 0=linear 1=log
467	Y scale linear/log	Enumerated	118:119 118=linear 119=log
469	X units	Enumerated	55:57 55=hertz or seconds 56=RPM or minutes 57=orders or dBEU

Table 4-8 Continued

OFFSET BYTE	DATA MEANING OF DATA	TYPE	RANGE/UNITS
471	Y units	Enumerated	58:60 58=volts or dBv 59=mWatts or dBm 60=EU or dBEU
473	Y display units	Enumerated	58:62 58=volts or dBv 59=mWatts or dBm 60=EU or dBEU 61=volt ² or dBv 62=EU ² or dBv
475	Power units off/on	Enumerated	0:1 0=off 1=on
477	Pulses per rev	Real	Pulses/rev
485	Hz per order	Real	Hertz/order
493	DBm reference	Real	Ohms
501	Volts per unit	Real	Volts
509	Units at marker	Real	Volts or volts EU
517	Unit label	String[4]	
521—522	Unused	Unused	
523	Display format	Enumerated	63:66 63=single 64=upper/lower 65=front/back 66=spectral map
525	Map type	Enumerated	101:102 101=vertical map 102=offset map
527	Map display	Enumerated	112:113 112=single map 113=full map
529	Number in map	Integer	1:60
531	Source type	Enumerated	82:85 82=source off 83=periodic 84=random 85=impulse
533	Source attenuation	Integer	0:27 (Multiply by 1.5 for attenuation in dB)
535	Source: records/impulse	Integer	0:32767
537	number of averages	Integer	0:16384
539	number of octave averages	Integer	0:16384
541	Average type	Enumerated	67:71 67=off 68=rms 69=rms exponential 70=peak hold 71=time
543	Octave average type	Enumerated	72:76 72=off 73=octave rms 74=octave exponential 75=octave peak 76=octave cont

Table 4-8 Continued

OFFSET BYTE	DATA MEANING OF DATA	TYPE	RANGE/UNITS
545	Average display type	Enumerated	77:79 77=normal 78=fast 79=repeat
547	Peak average type	Enumerated	80:81 80=finite 81=continuous
549	Average overload reject	Enumerated	0:1 0=off 1=on
551	Average overlap percent	Integer	0:1023 (Multiply by 50 and divide by 512 for percent overlap)
553	Buffer size	Integer	0:40 (in records)
555	Buffer pointer	Real	Seconds
563	Buffer percent increment	Real	Percent
571	Buffer zoom factor	Integer	0:10 (Multiply by 40 for zoom factor)
573	Buffer zoom frequency	Real	Hertz
581	Window type	Enumerated	51:54 51=flattop 52=hanning 53=uniform 54=exponential
583	Window exponential decay	Integer	This number is the decay amount expressed as the point in the time record where the window value is decayed to 1/e.
585	Center frequency	Real	Hertz
593	Frequency span	Real	Hertz
601	Frequency step	Real	Hertz
609	Octave stop freq	Enumerated	0:6 0=80kHz 1=40kHz 2=20kHz 3=10kHz 4=5kHz 5=2.5kHz 6=1.25kHz
611	Zero start or zoom	Boolean	0=zero start 1=zoom
612	Define start display mode	Boolean	0=define start inactive 1=define start active
613	X scale linear or log	Enumerated	0:1 0=log 1=linear
615	Measurement mode	Enumerated	47:50 47=narrow band 48=time capture 49=third octave 50=full octave
617	External sample off/on	Enumerated 0:1	0=external sample 1=internal sample
619-624	Unused	Unused	

Table 4-9. Trace Header Data Offset Bytes and Data Types

OFFSET BYTE	DATA MEANING OF DATA	TYPE	RANGE/UNITS
1	Display offset	Integer	dB
3	Overloaded	Enumerated	0:1 0=overload 1=no overload
5	Trace label	String[18]	
25	Average type	Enumerated	67:71 67=off 68=rms 69=rms exponential 70=peak hold 71=time
27	Peak average type	Enumerated	80:81 80=finite 81=continuous
29	Average number	Integer	0:16384
31	Data type	Enumerated	0:21 0=stored data 1=normal magnitude 2=buffer magnitude 3=octave 4=normal phase 5=buffer phase 6=input magnitude 7=average magnitude 8=octave input magnitude 9=real time 10=imaginary time 11=input time 12=real buffer time 13=imaginary buffer time 14=compressed real 15=compressed imaginary 16=buffered input time 17=octave time low 18=octave time mid 19=octave time high 20=octave input time 21=null time
33	Data state	Enumerated	0:5 0=bad data 1=raw data 2=in process 3=ready for transfer 4=processed 5=displayed
35	Mode	Enumerated	47:50 47=narrow band 48=time capture 49=third octave 50=full octave
37	Math state	Enumerated	0:5 0=start 1=pass 1 2=pass 2 3=pass 3 4=pass 4 5=math done

Table 4-9 Continued

OFFSET BYTE	DATA MEANING OF DATA	TYPE	RANGE/UNITS
39	Label state off/on	Enumerated	0:1 0=on 1=off
41	Math off/on	Enumerated	0:1 0=math on 1=math off
43	Math function(1)	Enumerated	284:299 284=magnitude 285=phase 286=M1 287=M2 288=plus 289=minus 290=multiply 291=divide 292=integrate 293=double integrate 294=differentiate 295=magnitude or phase 296=k1 297=k2 298=bandwidth 299=no op
45	Math function (2)	Enumerated	(See offset byte 43)
47	Math function (3)	Enumerated	(See offset byte 43)
49	Y log/linear units	Enumerated	0:1 0=log 1=linear
51	Y scaling log/linear	Enumerated	118:119 118=log 119=linear
53	X units	Enumerated	55:57 55=hertz or seconds 56=RPM or minutes 57=orders or dBEU
55	Y units	Enumerated	58:60 58=volts or dBv 59=mWatts or dBm 60=EU or dBEU
57	Y display units	Enumerated	58:62 58=volts or dBv 59=mWatts or dBm 60=EU or dBEU 61=volt ² or dBv 62=EU ² or dBv
59	Power units off/on	Integer	0:1 0=on 1=off
61	Pulses per rev	Real	Pulses/rev
69	Hz per order	Real	Hertz/order
77	DBM reference ohms	Real	Ohms
85	Volts per unit	Real	Volts/unit
93	Units at marker	Real	Volts or EU
101	Units label	String[4]	
106	Calibration needed	Boolean	0:1 0=not needed 1=cal needed
107	A-weight off/on	Enumerated	0:1 0=on 1=off

Table 4-9 Continued

OFFSET BYTE	DATA MEANING OF DATA	TYPE	RANGE/UNITS
109	AC/DC coupling	Enumerated	0:1 0=AC 1=DC
111	ICP current off/on	Enumerated	0:1 0=on 1=off
113	External sample off/on	Enumerated	0:1 0=on 1=off
115	Input range	Integer	-51:+27 dBv
117-144	Unused	Unused	
147-222	The definition for these bytes depends on the trace type selected.		
Time Traces:			
147	Start time	Real	Seconds
155	Stop time	Real	Seconds
163	Center time	Real	Seconds
171	Volts per division	Real	Volts/division
179	Volts full scale	Real	Volts
Frequency Domain Traces			
147	Center frequency	Real	Hertz
155	Frequency span	Real	Hertz
163	Octave stop frequency	Enumerated	0:6 0=80kHz 1=40kHz 2=20kHz 3=10kHz 4=5kHz 5=2.5kHz 6=1.25kHz
165	Zero start or zoom	Boolean	0=zero start 1=zoom
166	Define start display mode	Boolean	0=define start inactive 1=define start active
167	Window definition	Enumerated	51:54 51=flattop 52=hanning 53=unifor 54=exponential
169	Window exponential decay	Integer	This number is the decay amount expressed as the point in the time record where the window value is decayed to 1/e.
171	X scale log/linear	Enumerated	0:1 0=log 1=linear
Magnitude Traces			
173	X scale log/linear	Enumerated	0:1 0=linear 1=log
175	DB per division	Real	dB
183	Full scale dB	Real	dB
Phase Traces			
175	Phase center	Integer	Degrees
179	Degrees per division	Integer	Degrees

Table 4-10. Buffer Header Offset Bytes and Data Types. (Items with asterisks are beyond the scope of this manual. Use at your own risk.)

OFFSET BYTE	DATA MEANING OF DATA	TYPE	RANGE/UNITS
1	Offset	Integer	dB
3-6	Internal	Internal	
7	Buffer size	Integer	1:40 records
9-12	Internal	Internal	
13	Span	Real	Hertz
21	Center frequency	Real	Hertz
29	Baseband data	Boolean	0:1 0=zoom 1=baseband
30	Data overloaded	Boolean	0:1 0=no 1=yes
31	Internal	Internal	
33	Range	Integer	dB
35	A-weight off/on	Enumerated	0:1 0=on 1=off
37	AC couple off/on	Enumerated	0:1 0=AC 1=DC
39	ICP off/on	Enumerated	0:1 0=on 1=off
41	External sample off/on	Enumerated	0:1 0=on 1=off
43-170	Magnitude calibration data*	Integer	0:63 words
171-298	Phase calibration data*	Integer	0:63 words
299-302	Slope*	Integer	
303-306	Intercept*	Integer	
307	A-weight offset*	Integer	
309	Starting time	Real	Seconds
317	Stop time	Real	Seconds
325	Capture phase offset*	Integer	
329	Capture phase delta*	Integer	
333-348	Unused	Unused	

CHAPTER V

INSTALLATION	173
Initial Inspection	173
Power Requirements	173
Power Cable and Grounding Requirements	175
Operating Environment	176
Accessories Supplied	176
Accessories Available	177
Options	177
Installation	177
HP-IB System Interface Connections	178
Storage and Shipment	180

CHAPTER V

INSTALLATION

INITIAL INSPECTION

POWER REQUIREMENTS

POWER CABLE AND GROUNDING REQUIREMENTS

OPERATING ENVIRONMENT

ACCESSORIES SUPPLIED

ACCESSORIES AVAILABLE

OPTIONS

INSTALLATION

HP-IB SYSTEM INTERFACE CONNECTIONS

STORAGE AND SHIPMENT

CHAPTER V INSTALLATION

This chapter contains instructions for installing and interfacing the -hp-3561A Dynamic Signal Analyzer. Included are initial inspection procedures, power and grounding requirements, operating environment, available accessories and options, installation instructions, HP-IB interfacing procedures, and instructions for repacking and shipment.

INITIAL INSPECTION

This instrument was carefully inspected both mechanically and electrically before shipment. It should be free of marks or scratches and in perfect electrical order upon receipt. To confirm this, inspect the instrument for physical damage incurred in transit. If the instrument was damaged in transit, file a claim with the carrier. Check for supplied accessories (listed in this chapter) and test the electrical performance using the Operational Verification tests in Chapter 2 of the service manual. If there is damage or deficiency, see the warranty in the front of this manual.

WARNING

The integrity of the protective earth ground may be interrupted if the -hp-3561A is mechanically damaged. Under no circumstances should the -hp-3561A be connected to power if it is damaged.

POWER REQUIREMENTS

CAUTION

Before applying ac line power to the -hp-3561A, ensure that the voltage selection switches on the bottom of the instrument are set for the proper line voltage and that the correct line fuse is installed in the rear panel fuse holder.

The -hp-3561A can be operated from any single phase ac power source supplying 100 V, 120 V, 220 V or 240 V (−10% to +5%) (see Figure 5-1). For 100/120 V power, the -hp-3561A can be operated in the frequency range of 48-440 Hz. For 220/240 V power, the -hp-3561A can be operated in the frequency range of 48-66 Hz. Power consumption is less than 150 VA.

Figure 5-1. Line Voltage Ranges

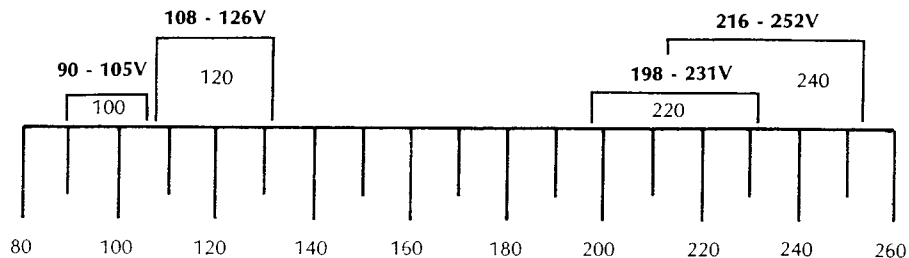
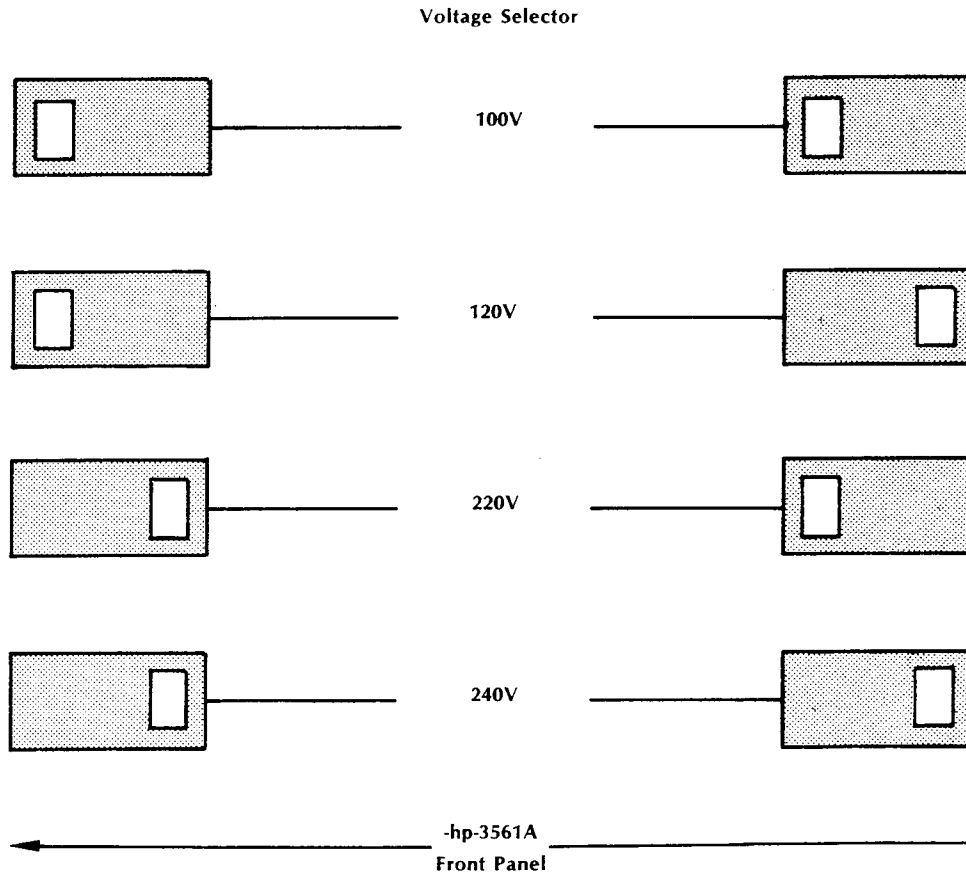

Figure 5-2 gives information for line voltage and fuse selection.

Figure 5-2. Switch Positions For Line Voltage Ranges and Fuse Selection.

Line Setting	Fuse Type	-hp- Part No.
110 V/120 V	3 A 250 V Normal Blow	2110-0003
220 V/240 V	1.5 A TD 250 V Time Delay	2110-0304



POWER CABLE AND GROUNDING REQUIREMENTS

The -hp-3561A is equipped with a three-conductor power cord which, when plugged into an appropriate receptacle, grounds the instrument cabinet. The type of power cable plug shipped with each instrument depends on the country of destination. Refer to Figure 5-3 for the part numbers of the power cable and plug configurations available.

Figure 5-3. Power Cables

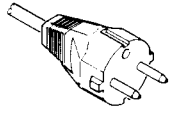
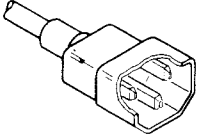
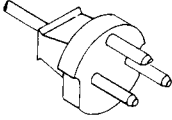
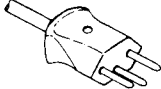
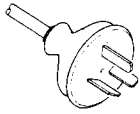
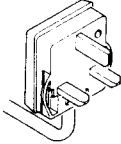
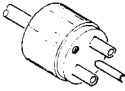
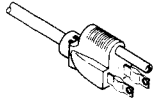
<p>250 V OPERATION</p>  <p>PLUG*: CEE7-V11 CABLE*: HP 8120-1692</p>	<p>250 V OPERATION</p>  <p>PLUG*: CEE22-V1 CABLE*: HP 8120-1860</p>	<p>250 V OPERATION</p>  <p>PLUG*: DHCR 107 CABLE*: HP 8120-2956</p>	<p>250 V OPERATION</p>  <p>PLUG*: SEV 1011.1959-24507 TYPE 12 CABLE*: HP 8120-2104</p>
<p>250 V OPERATION</p>  <p>PLUG*: NZSS 198/AS C112 CABLE*: HP 8120-0696</p>	<p>250 V OPERATION</p>  <p>PLUG*: BS 1363A CABLE*: HP 8120-1703</p>	<p>250 V - 6A**</p>  <p>PLUG*: NEMA G-15P CABLE*: HP 8120-0696</p>	<p>125 V - 6A**</p>  <p>PLUG*: NEMA 5-15P CABLE*: HP 8120-1521</p>
<p>STD-B-186 (Rev.)</p> <p>*The number shown for the plug is the industry identifier for the plug only. The number shown for the cable is an HP part number for a complete cable including the plug. **UL listed for use in the United States of America</p>			

WARNING

The power cable plug must be inserted into a socket outlet provided with a protective earth ground terminal. Defeating the protection of the grounded instrument cabinet can subject the operator to lethal voltages.

OPERATING ENVIRONMENT

WARNING

The -hp-3561A is not designed for outdoor use. To prevent potential fire or shock hazard, do not expose the -hp-3561A to rain or other excessive moisture.

Temperature — The -hp-3561A may be operated in temperatures from 0° C to +55° C. The -hp-3561A specifications apply within this temperature range.

Humidity — The instrument may be operated in environments with humidity up to 95%. However, the -hp-3561A should be protected from temperature extremes which cause condensation within the -hp-3561A.

Altitude — The instrument may be operated at altitudes up to 4600 meters (15,000 feet).

Cooling Fan — The -hp-3561A is equipped with a cooling fan mounted on the rear panel. The instrument should be mounted so that air can freely circulate through it. The filter for the cooling fan can be removed for cleaning by flushing with soapy water.

Thermal Cutout — The -hp-3561A is equipped with a thermal cutout switch which automatically removes power whenever the internal temperature is excessive. The temperature at which this occurs is dependent upon line voltage and airflow. With proper airflow and operating line voltage, thermal cutout will not occur below 55° C ambient temperature. The switch resets automatically when the instrument cools. If a thermal cutout occurs, check for fan stoppage, clogged fan ports, and other conditions that can obstruct airflow or otherwise cause excessive heating.

Note

The thermal cutout will operate at any external temperature down to +15° C if the airflow is blocked.

ACCESSORIES SUPPLIED

Table 5-1 lists the accessories supplied with the -hp-3561A.

Table 5-1. Accessories Supplied

Description	Quantity	-hp- Part Number
Pouch	1 ea.	1540-0292
Front Cover	1 ea.	5040-0516
Operating Manual	1 ea.	03561-90000
Service Manual	1 ea.	03561-90010

ACCESSORIES AVAILABLE

Table 5-2 lists the accessories available for the -hp-3561A. These accessories may be obtained through your -hp- Sales and Service Office.

Table 5-2. Accessories Available

Accessory	-hp- Model
Transit Case	9211-2459

OPTIONS

Table 5-3 lists the options available for the -hp-3561A. These options are available either when the instrument is ordered or for later installation.

Table 5-3. Options

-hp- 3561A Option	-hp- Part Number	Description
001	03561-68765	Bubble Memory
908	10491B	Rack Adapter Kit
910	03561-90000	Extra Operating Manual
910	03561-90010	Extra Service Manual

INSTALLATION

The -hp-3561A is shipped with plastic feet and handle in place, ready for use as a portable bench instrument. Plastic feet mounted on the rear panel enable the -hp-3561A to be placed in a vertical position. When operating the instrument, choose a location that provides at least three inches of clearance at the rear and at least one inch for each side. Failure to provide adequate air clearance will result in excessive internal temperature reducing instrument reliability. The clearances provided by the plastic feet in bench stacking and the rack adapter used in rack mounting allow air passage across the top and bottom cabinet surfaces.

Option 908 (Rack Mount Kit) enables the -hp-3561A to be mounted in an equipment cabinet. The rack mount for the -hp-3561A is EIA standard width of 19 inches. Installation instructions are included with the Rack Mount Kit. Option 908 may be ordered from your nearest -hp- Sales and Service Office with the -hp- part number listed in Table 3-5.

The handle is removed from the -hp-3561A by removing both trim caps from the carrying handle hubs and removing the retaining screws from the center of each carrying handle hub. Remove handle assembly and retain parts for re-installation. Replace the handle by reversing the removal procedures.

HP-IB SYSTEM INTERFACE CONNECTIONS

The -hp-3561A is compatible with the Hewlett-Packard Interface Bus (HP-IB). The -hp-3561A is connected to the HP-IB by connecting an HP-IB interface cable to the connector located on the rear panel. Figure 5-4 illustrates a typical HP-IB System interconnection.

Note

The HP-IB is Hewlett-Packard's implementation of IEEE std. 488-1978, "Standard Digital Interface for Programmable Instrumentation."

Figure 5-4. Typical HP-IB System Interconnection

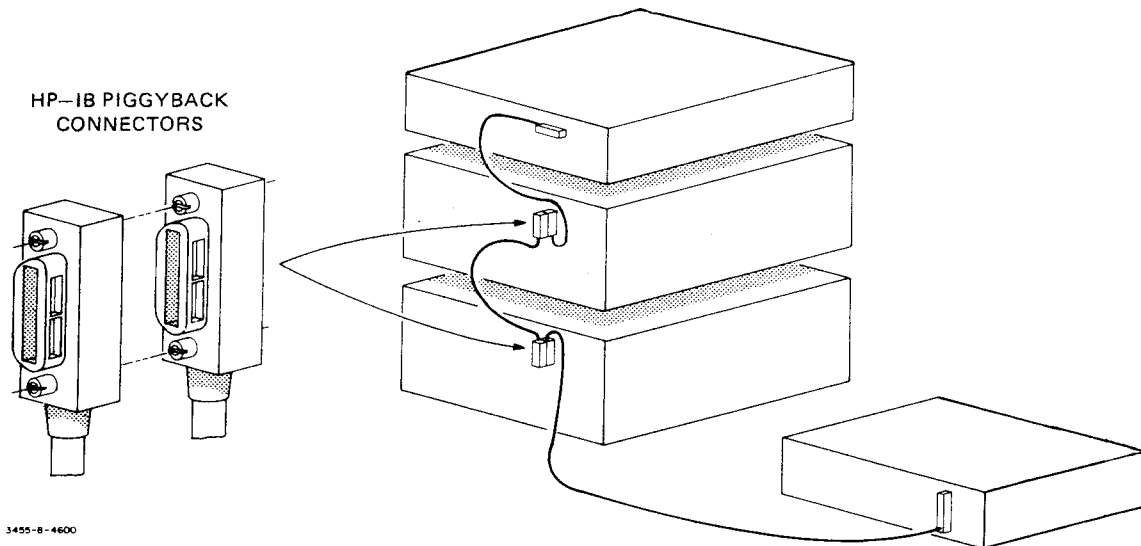

With the HP-IB system, up to 15 HP-IB compatible instruments can be interconnected. The -hp-10833 HP-IB cables have identical piggy-back connectors on each end so that several cables can be connected to a single source without special adapters or switch boxes. System components and devices can be connected in virtually any configuration. There must, of course, be a path from the computer (or other controller) to every device operating on the bus. As a practical matter, avoid stacking more than three or four cables on any one connector. If the stack gets too long, any force on the stack can damage the connector mounting. Be sure that each connector is firmly screwed in place to keep it from working loose during use. The -hp-3561A uses all the available HP-IB lines; therefore, any damaged connector pins may adversely affect HP-IB operation (see Figure 5-5).

Figure 5-5. Interfacing the HP-IB

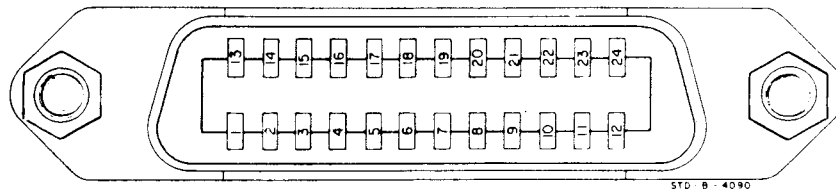

CAUTION

The -hp-3561A contains metric threaded HP-IB cable mounting studs as opposed to English threads. Metric threaded -hp-10833A, B, C or D HP-IB cable lockscrows must be used to secure the cable to the instrument. Identification of the two types of mounting studs and lockscrows is made by their color. English threaded fasteners are colored silver and metric threaded fasteners are colored black. DO NOT Mate silver and black fasteners to each other or the threads of either or both will be destroyed. Metric threaded HP-IB cable hardware illustrations and part numbers follow.

Pin	Line
1	D101
2	D102
3	D103
4	D104
13	D105
14	D106
15	D107
16	D108
5	EOI
17	REN
6	DAV
7	NRFD
8	NDAC
9	IFC
10	SRQ
11	ATN
12	SHIELD - CHASSIS GROUND
18	P/O TWISTED PAIR WITH PIN 6
19	P/O TWISTED PAIR WITH PIN 7
20	P/O TWISTED PAIR WITH PIN 8
21	P/O TWISTED PAIR WITH PIN 9
22	P/O TWISTED PAIR WITH PIN 10
23	P/O TWISTED PAIR WITH PIN 11
24	ISOLATED DIGITAL GROUND

Note

The HP-IB is Hewlett-Packard implementation of IEEE std 488-1978, "Standard Digital Interface for Programmable Instrumentation."

THESE PINS ARE INTERNALLY GROUNDED

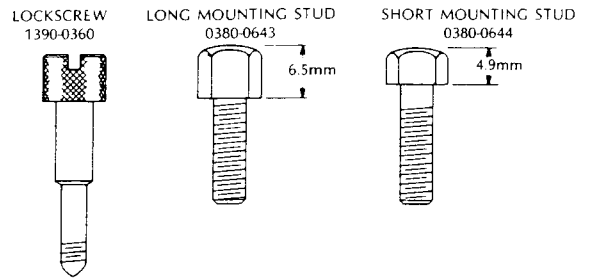

HP-IB Interconnect Cables

Part Number	Length
10833A	1 m (3.3 ft)
10833B	2 m (6.6 ft)
10833C	4 m (13.2 ft)
10833D	0.5 m (1.6 ft)

To achieve design performance with the HP-IB, proper voltage levels and timing relationships must be maintained. If the system cable is too long, the lines cannot be driven properly and the system will fail to perform (see Figure 5-5 for HP-IB cable lengths). Therefore, when interconnecting an HP-IB system, it is important to observe the following rule:

Total cable length for the system must be less than or equal to 20 meters (65 feet), or 2 meters (6 feet) times total number of devices connected to the bus, whichever is less.

STORAGE AND SHIPMENT

Environment — The -hp-3561A should be stored in a clean, dry environment. The following are environmental limitations that apply to both storage and shipment:

Temperature	–40° C to +75 °C
Humidity	Up to 95%
Altitude	Up to 15,300 meters (50,000 feet)

The instrument should also be protected from temperature extremes which cause condensation within the instrument.

Original Packaging — Containers and materials equivalent to those used in factory packaging are available through Hewlett-Packard offices. If the instrument is being returned to Hewlett-Packard for service, attach a tag indicating the type of service required, return address, model number, and full serial number. Also, mark the container FRAGILE to ensure careful handling. In any correspondence, refer to the instrument by model number and full serial number.

Other Packaging — The following general instructions should be used for repackaging with commercially available materials:

- Wrap the instrument in heavy paper or anti-static plastic. (If shipping to a Hewlett-Packard office or service center, attach a tag to the instrument indicating type of service required, return address, model number, and full serial number.)
- Use a strong shipping container. A double-wall carton made of 350-pound test material is adequate.
- Use a layer of shock absorbing material 70 to 100 mm (3 to 4 inch) thick around all sides of the instrument to provide firm cushioning and prevent movement inside of the container. Protect the control panel with cardboard.

CAUTION

Styrene pellets in any shape should never be used as packing material. The pellets do not adequately cushion the instrument and do not prevent the instrument from shifting in the carton. The pellets also create static electricity which can damage electronic components.

- Seal shipping container securely.
- Mark shipping container FRAGILE to ensure careful handling.
- In any correspondence, refer to the instrument by model number and full serial number.

APPENDIX A QUICK REFERENCE

This quick reference contains abbreviated operating information for the -hp-3561A. Included in this section is a brief description of the -hp-3561A front and rear panels, and a map illustrating the -hp-3561A menus.

MENU DEFINED KEYS

The menu defined keys are defined by the display menu entries. Menus are selected and displayed by pressing a labeled front panel key.

MEASUREMENT KEY GROUP

The measurement group indicators illuminate when a measurement is in progress, or measurement options are selected or enabled. The measurement group keys control the measurement and select menus for altering measurement parameters and options.

EXT SAMP indicator illuminates when the external sampling mode is enabled.

AVG key indicator illuminates when an averaging process is selected.

TIME BUFFER key indicator illuminates when the time capture mode is selected.

MEAS indicator illuminates when a measurement is in progress.

MODE key displays a menu for selecting the instrument measurement mode (narrow band, third octave, full octave, time capture, external sample, or test modes).

AVG key displays a menu for selecting the type of averaging process applied to the measurement.

TIME BUFFER key displays a menu for initiating a time capture operation and defining the time capture mode parameters.

START key clears the time record and accumulated average results, and initiates a measurement.

FREQ key displays a menu for defining the measurement frequency parameters.

WINDOW key displays a menu for selecting the window applied to the input signal.

SOURCE key displays a menu for enabling the -hp-3561A noise source and selecting the noise type.

PAUSE/CONT key suspends an in progress measurement or continues a suspended measurement.

TRIGGER KEY GROUP

The trigger group keys control the trigger function. The trigger indicators illuminate to indicate the trigger status.

TRIG SEL key indicator illuminates when the -hp-3561A is triggered.

TRIG SEL key displays a menu for selecting and defining the trigger used for starting a measurement.

ARM key indicator illuminates when the -hp-3561A is armed and waiting for a valid trigger.

ARM key resets the trigger circuits when the manual arm trigger mode is selected.

HP-IB KEY GROUP

HP-IB group keys control the HP-IB and plotting functions. HP-IB indicators illuminate to indicate the HP-IB status.

RMT indicator illuminates when the -hp-3561A is operating under HP-IB control. In the remote mode, (and the **LCL** key is not locked out by the controller), only the **LCL** key is recognized by the -hp-3561A.

SRQ indicator illuminates when the -hp-3561A generates an HP-IB service request.

LTN indicator illuminates when the -hp-3561A is addressed to listen over the HP-IB.

TLK indicator illuminates when the -hp-3561A is addressed to talk over the HP-IB.

LCL key displays a menu for setting the HP-IB address, enabling the talk only mode, and enabling the HP-IB power on service request.

PLOT key displays a menu for selecting and defining plotter options.

LINE KEY

LINE key applies power to the -hp-3561A circuits.

DISPLAY KEY GROUP

The display group keys affect the display format.

NEXT TRACE key selects the active trace on the display. For a single trace format **NEXT TRACE** toggles the display between the two available traces. The active trace is the trace displayed. For an upper/lower trace format, the active trace is identified by an intensified label over the trace graticule. For a front/back trace format or map format, the active trace is intensified.

DEFINE TRACE key displays a menu for selecting the magnitude, phase, time, or math trace functions.

VERT SCALE key displays a menu for scaling the vertical display axis.

STORE/RECALL key displays a menu for storing traces in memory, recalling traces from memory, and entering trace labels.

UNITS key displays a menu for selecting and defining the vertical and horizontal axis units of the display.

FORMAT key displays a menu for selecting a single trace, upper/lower trace, front/back trace, or map display format.

MARKER GROUP KEYS

The marker group keys affect the operation of the marker. The **◆**, **FAST**, and **◆** keys position the marker on the active trace. **FAST**, when used with the arrow keys, moves the marker at a faster rate.

MKR key displays a menu for selecting absolute marker functions.

SPCL MKR key displays a menu for selecting band marking, harmonic marker, and sideband marker measurements.

REL MKR key displays a menu for enabling the relative marker function and defining the reference values for the relative measurements.

INSTRUMENT STATE KEY GROUP

The instrument state group keys affect the instrument setup configuration.

SAVE key displays a menu for storing the current instrument state in nonvolatile memory.

RECALL key displays a menu for recalling an instrument state from nonvolatile memory.

VIEW ON/OFF key toggles the display between a graphic trace display and a tabular text display of the instrument state.

PRESET key initializes the -hp-3561A to the most commonly required setup.

INPUT KEY GROUP

The input group keys control the -hp-3561A input circuits. The input group indicators provide an indication of the input circuit status.

OVER indicator illuminates when the input signal amplitude exceeds the maximum range of the signal processing circuits.

HALF indicator illuminates when the input signal level is greater than one-half the maximum input range value. An optimum input level illuminates the **HALF** indicator without illuminating the **OVER** indicator.

AUTO indicator illuminates when the -hp-3561A auto-ranging circuits are enabled.

ICP CURRENT indicator illuminates when the -hp-3561A ICP current source is enabled.

A WT FILTER indicator illuminates when an internal A-weighting filter is in the -hp-3561A input signal path.

AC COUPLE indicator illuminates when ac coupling is selected.

RANGE key displays a menu for setting the input range or selecting auto-range.

INPUT key displays a menu for selecting the -hp-3561A input circuits (ac/dc coupling, A-weighting filter, or ICP current source) or calibration circuits.

FLOAT-CHASSIS switch connects the input circuit ground reference to chassis ground or isolates (floats) it from chassis ground.

WARNING

Do not isolate the -hp-3561A from earth ground by interrupting the protective earth conductor inside or outside the -hp-3561A. Interruption of the protective earth conductor can subject the operator to lethal voltages.

INPUT connector provides a high impedance input (1 M Ω).

REAR PANEL CONNECTORS

SOURCE OUTPUT connector is the output for the -hp-3561A pseudo-random noise source or impulse generator. This output is enabled through the **SOURCE** key menu.

A positive **SOURCE SYNC** output marks a time record that coincides with an impulse or pseudo-random noise output. The output occurs at the start of the time record. If the trigger is derived from the internal noise source or impulse generator, the output is synchronized to the source trigger signal. The **SOURCE SYNC** output is a TTL level pulse.

The -hp-3561A sampling frequency is controlled through the **EXT SAMPLE** connector when the external sampling mode is enabled through the **MODE** key. The **EXT SAMPLE** input is TTL compatible.

External trigger sources connect to the -hp-3561A through the **EXT TRIGGER** input connector. The -hp-3561A trigger circuits sense this connector when **EXTERNAL TRIGGER** is selected through the **TRIG SEL** key menu. The trigger input is TTL compatible.

External HP-IB devices communicate with the -hp-3561A through the rear panel HP-IB connector. The -hp-3561A controls a printer or plotter through this connector.

CROSS REFERENCE TO CHAPTER II OPERATOR'S REFERENCE

KEY/KEY GROUP	PAGE
AC COUPLE INDICATOR	95
ARM KEY/INDICATOR	73
AUTO INDICATOR	95
AVG KEY/INDICATOR	63
A WT FILTER INDICATOR	95
BACK SPACE KEY	74
DEFINE TRACE KEY	78
DISPLAY KEY GROUP	78
DOWN ARROW KEY	74
EXT SAMPLE CONNECTOR	97
EXT SAMPLE INDICATOR	60
EXT TRIG CONNECTOR	98
FAST KEY	88
FLOAT - GROUND SWITCH	97
FREQ KEY	69
FORMAT KEY	86
HALF INDICATOR	95
HP-IB CONNECTOR	97
HP-IB KEY GROUP	75
ICP CURRENT INDICATOR	95
INPUT CONNECTOR	97
INPUT KEY	96
INPUT KEY GROUP	95
INSTR STATE KEY GROUP	91
LCL KEY	75
LEFT ARROW KEY	88
LINE KEY	77
LTN INDICATOR	75
MARKER KEY GROUP	88
MEAS INDICATOR	60
MEASUREMENT KEY GROUP	60
MKR KEY	88
MKR VALUE KEY	74
NEXT TRACE KEY	78
NUMERIC ENTRY KEYS	74
OVER INDICATOR	95
PAUSE/CONT KEY	71
PLOT KEY	76
PRESET KEY	93
RANGE KEY	95
REAR PANEL CONNECTORS	97
RECALL KEY	92
REL MKR KEY	90
RETURN KEY	60
RIGHT ARROW KEY	88
RMT INDICATOR	75
SAVE KEY	91
SOFTKEYS	59
SOURCE KEY	71
SOURCE OUT CONNECTOR	98
SOURCE SYNC CONNECTOR	98
SPCL MKR KEY	89
SRQ INDICATOR	75
START KEY	69
STORE/RECALL KEY	84
TALK INDICATOR	75
TIME BUFFER KEY/INDICATOR	66
TRIG KEY GROUP	72
TRIG SEL KEY/INDICATOR	72
UNITS KEY	85
UP ARROW KEY	74
VERT SCALE KEY	83
VIEW ON/OFF KEY	93
WINDOW KEY	70

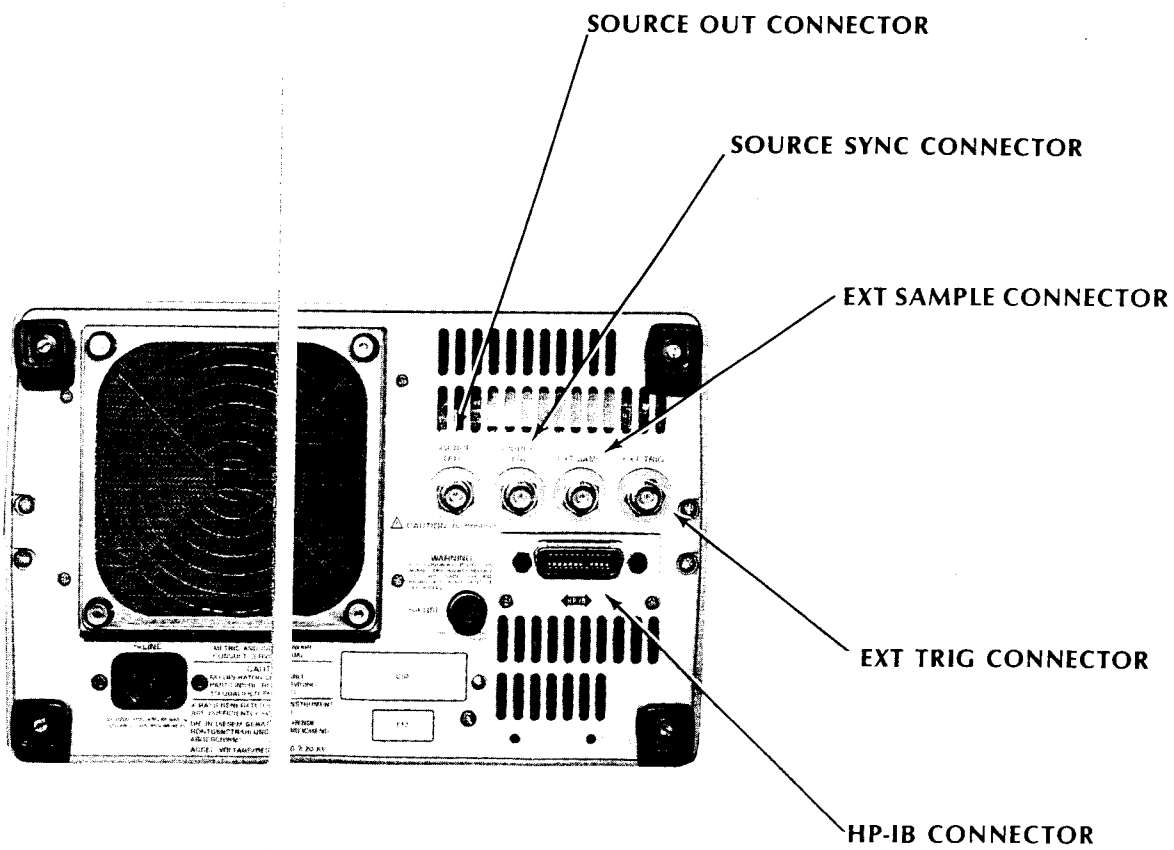

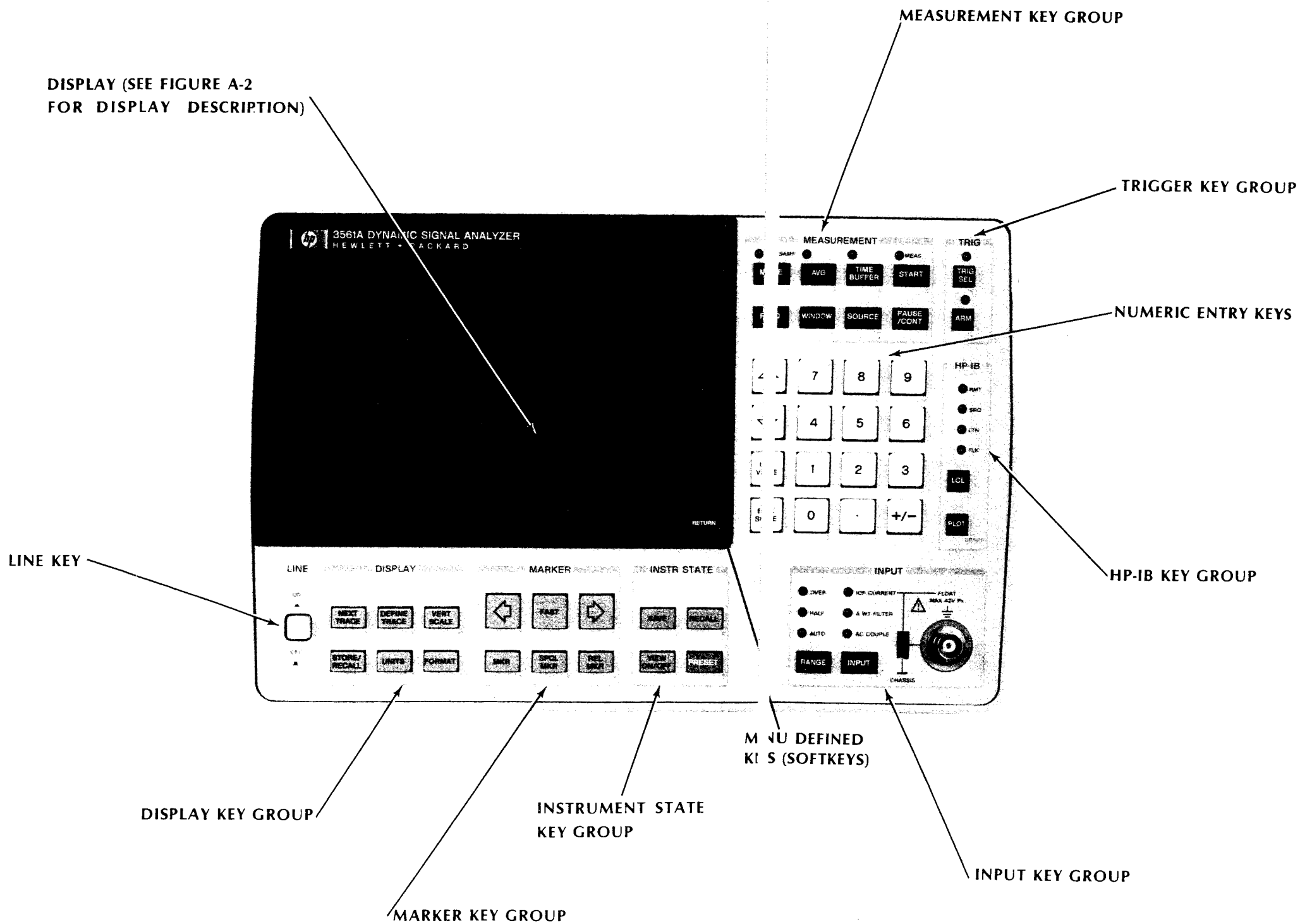

Figure A-1. -hp-3561A Front and Rear Panels.

DISPLAY DESCRIPTION

ENTRY AREA displays the alphanumeric characters used in defining a parameter. The current entry for a key requiring a numeric or character input is displayed here when the key is selected.

INPUT RANGE area displays the full scale input range.

STATUS AREA displays the current status of the -hp-3561A.

TRACE DESCRIPTION indicates the trace function. An intensified trace description indicates the active trace.

TRACE LABEL displays the trace annotation entered through the **DEFINE TRACELBL** menu entry when the trace label display is enabled. If the trace label display is disabled, a detailed description of the trace function is displayed in this area.

AVERAGE STATUS area provides information regarding the averaging process applied to the measurement.

OVERLOAD STATUS area indicates overloads occurring during a measurement.

Y-AXIS LABEL displays the annotation for the graticule vertical axis.

X-AXIS LABEL displays the annotation for the graticule horizontal axis.

BANDWIDTH display area displays the measurement bandwidth.

X MARKER area displays the horizontal axis coordinate value of the marker.

Y MARKER area displays the vertical axis coordinate value of the marker.

MENU area displays the menu defining the unlabeled keys to the right of the menu.

SINGLE TRACE AND MAP MODE DISPLAY FORMAT

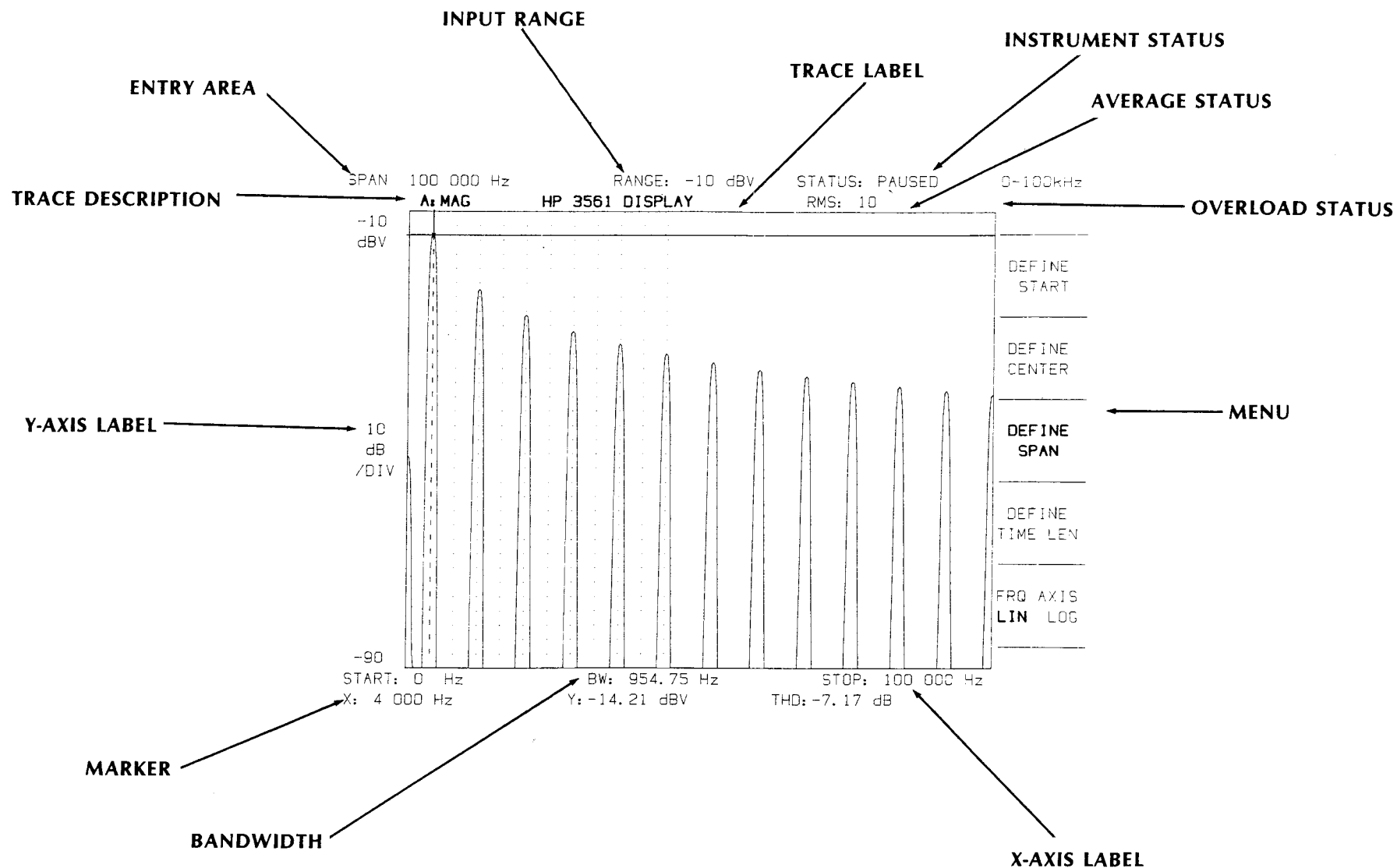

DUAL TRACE DISPLAY FORMAT

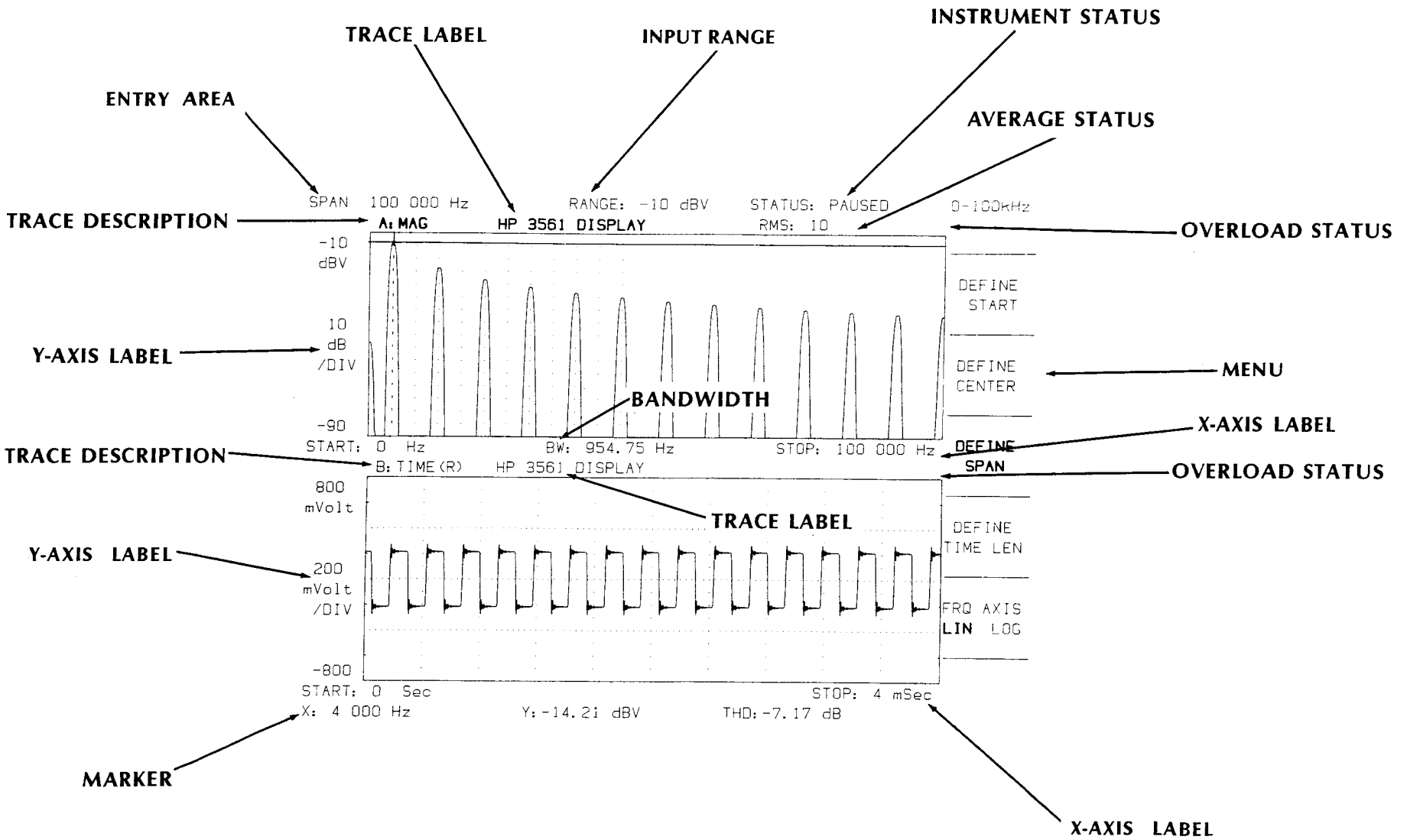

HOW TO INTERPRET THE KEY MAP

KEY GROUP

LABELLED FRONT PANEL KEY
DEFINING MENU

AVG

NARROW BAND
TIME CAPTURE
MODE

OCTAVE
MODE

RMS
OCTAVE RMS
TIME
OCTAVE PK HOLD

RMS/OCTAVE EXP
OCTAVE PK CONT

PEAK HOLD

MENU DEPENDENT CONDI-
TIONS (BUBBLE MEMORY,
MODE SELECTED, TRACE TYPE,
MARKER TYPE)

MENU ENTRIES DISPLAYED
WHEN LABELLED KEY IS PRESSED

- OFF
- RMS
- RMS EXP WGHT
- PEAK HOLD
- TIME
- DEFINE NUM AVGS
- SETUP SELECT

- OFF
- OCTAVE RMS
- OCTAVE EXP WGHT
- OCTAVE PK HOLD
- OCTAVE PK CONT
- DEFINE NUM AVGS
- SETUP SELECT

- DEFINE AVG OVLP
- OVLD REJ ON OFF
- NORMAL DISPLAY
- FAST DISPLAY
- REPEAT DISPLAY

- DEFINE AVG OVLP
- OVLD REJ ON OFF

- DEFINE AVG OVLP
- OVLD REJ ON OFF
- FINITE
- CONT
- FINITE PEAK HOLD
- NORMAL DISPLAY
- FAST DISPLAY
- REPEAT DISPLAY

SECONDARY MENU DEFINED
BY PRIMARY MENU ENTRY

MENU ENTRIES WITH ADDI-
TIONAL SELECTIONS

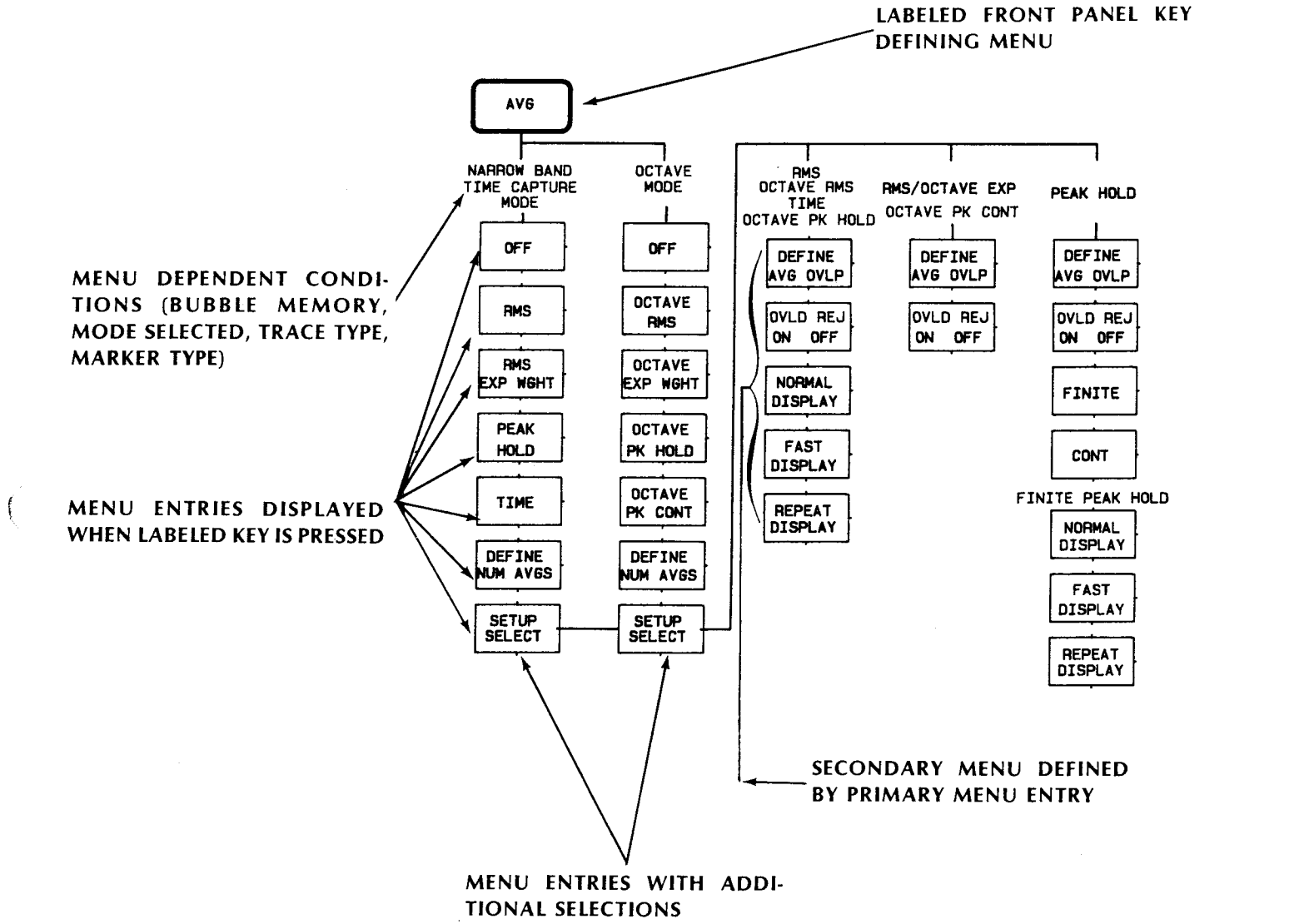

DISPLAY

NEXT TRACE

DEFINE TRACE

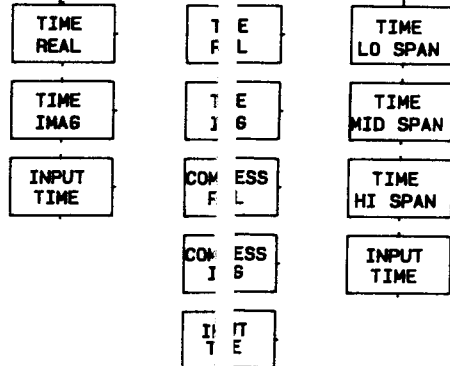
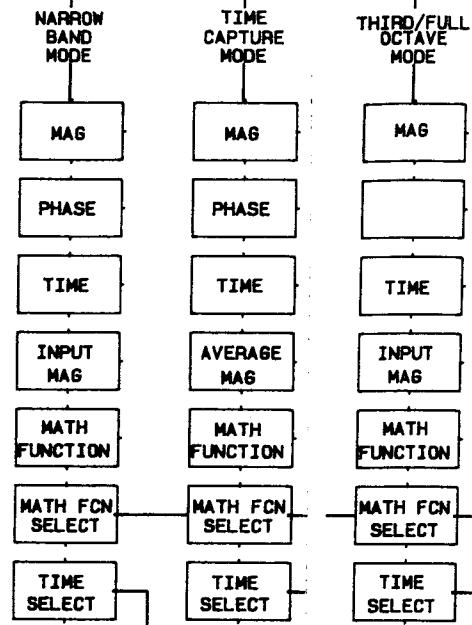

VERT SCALE

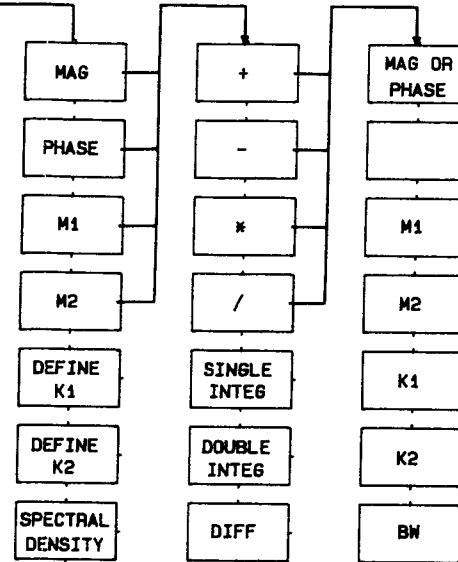
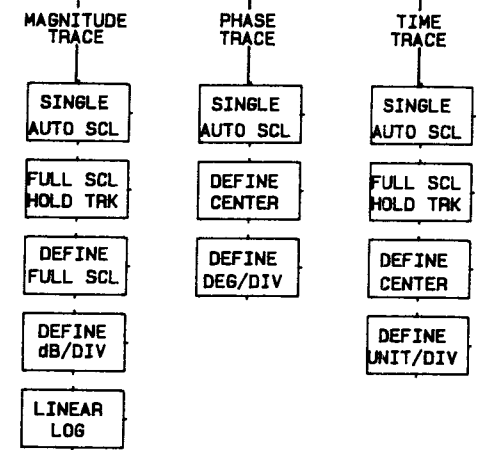

STORE/RECALL

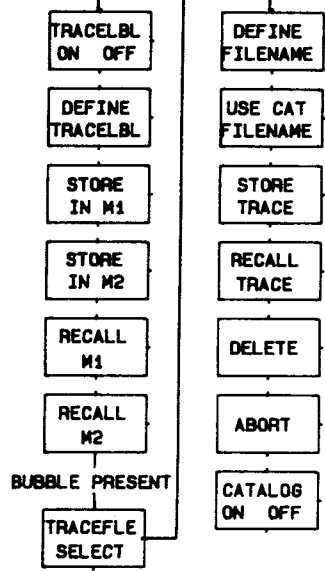

UNITS

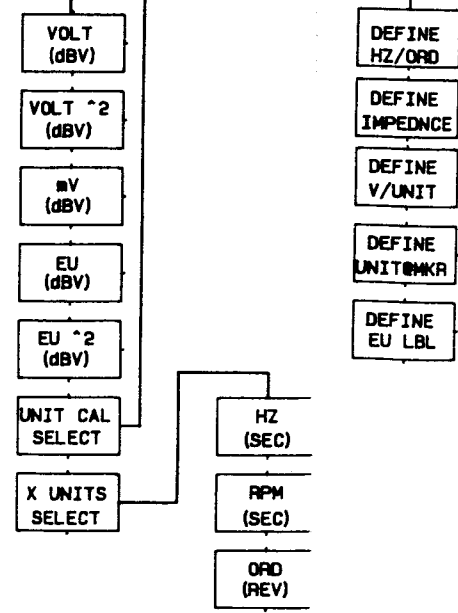

FORMAT

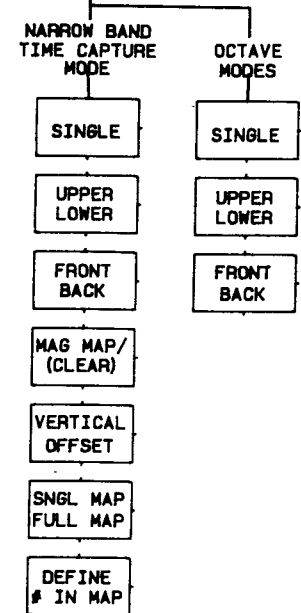

MARKER

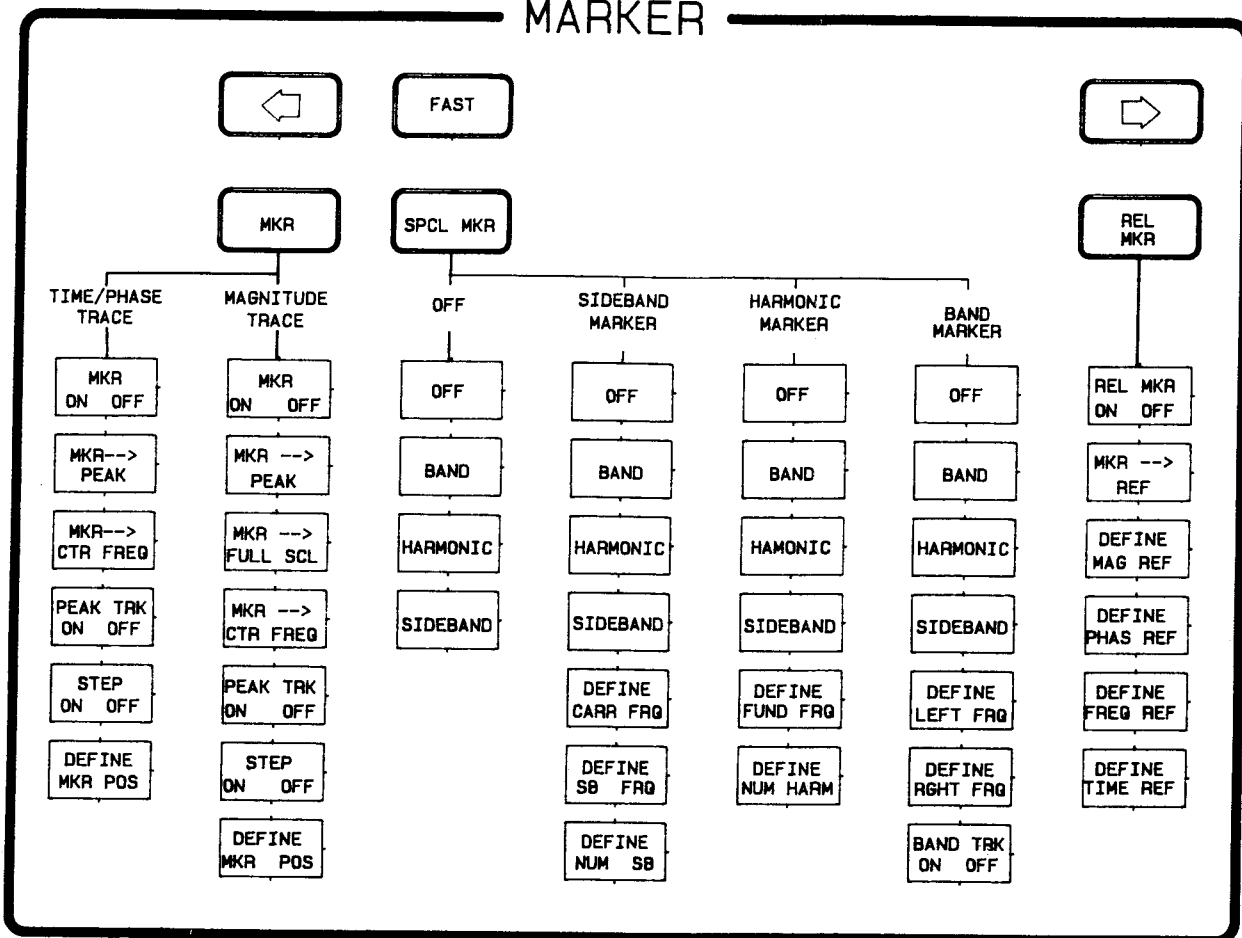
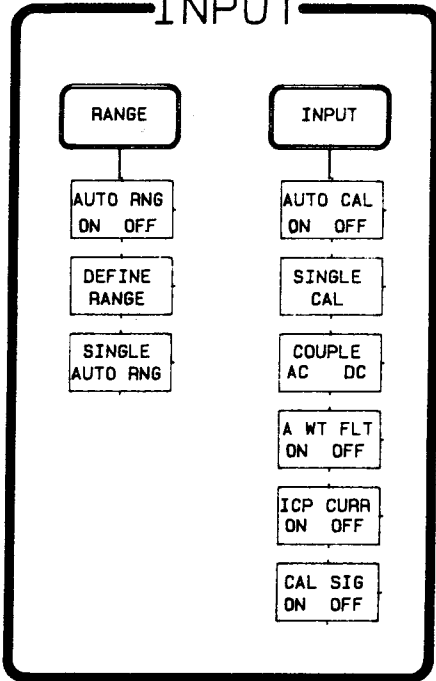
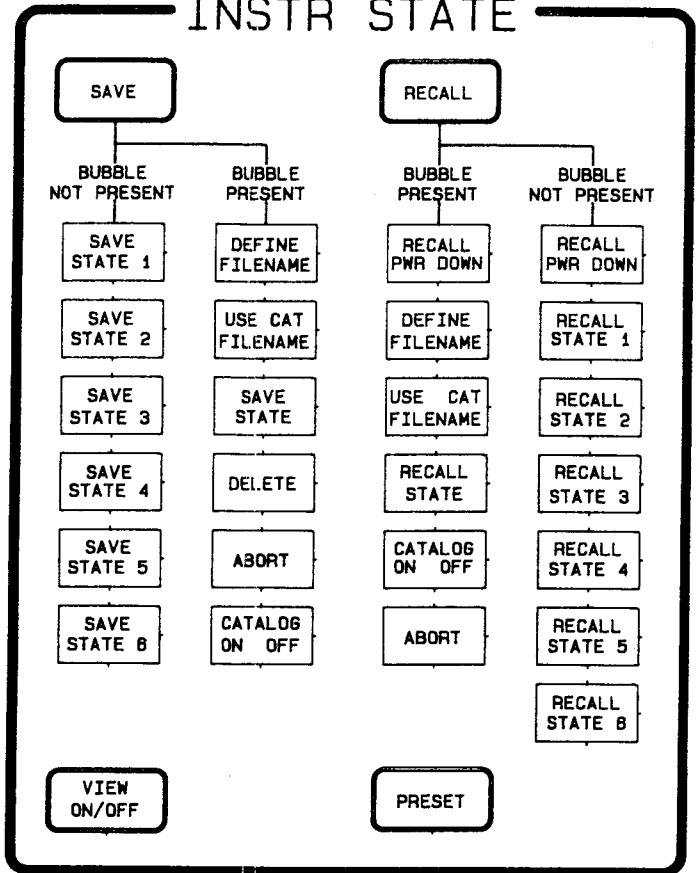

Figure A-3. -hp-3561A Menus
Sheet 1

INPUT



INSTR STATE



MEASUREMENT

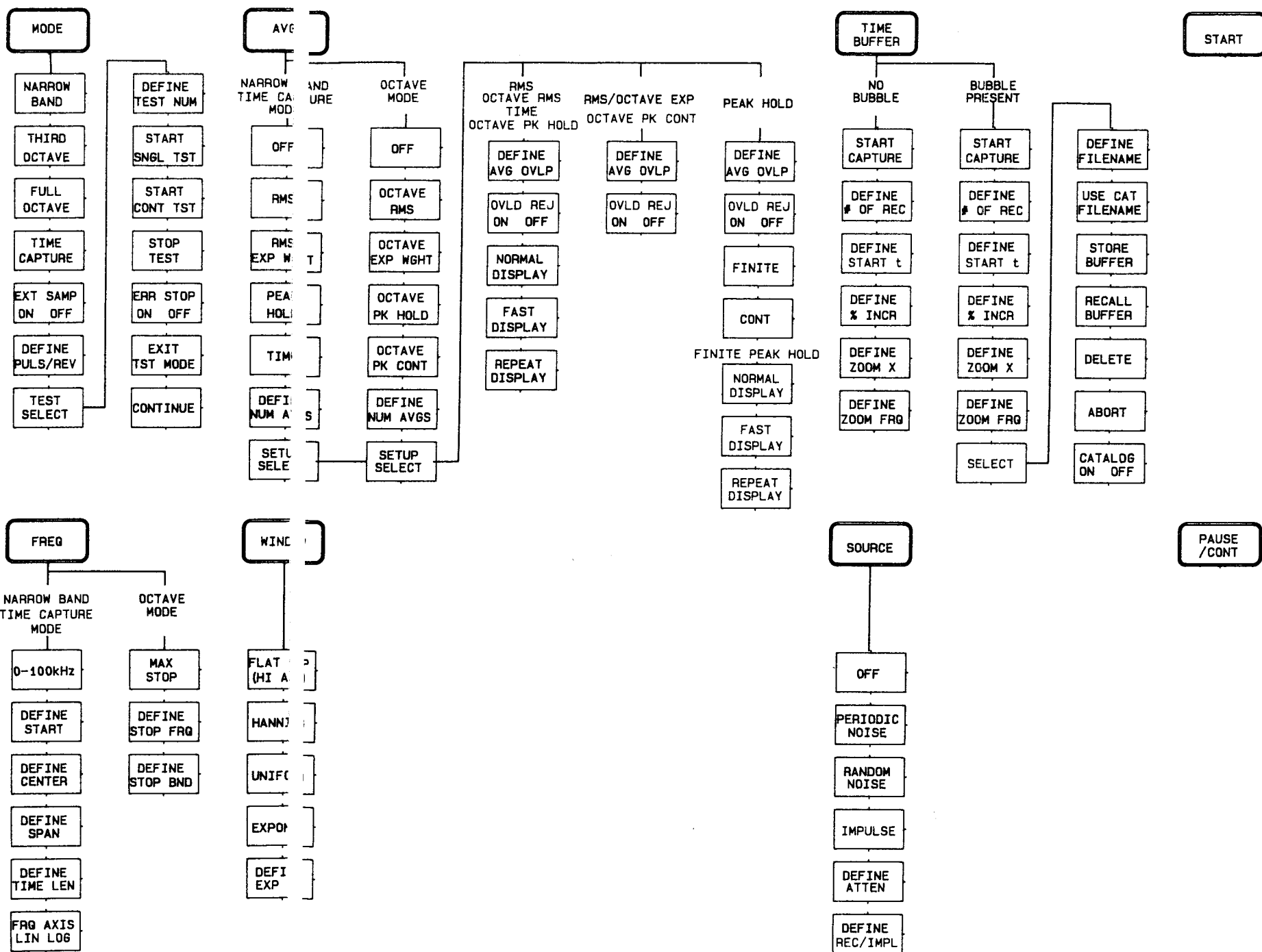

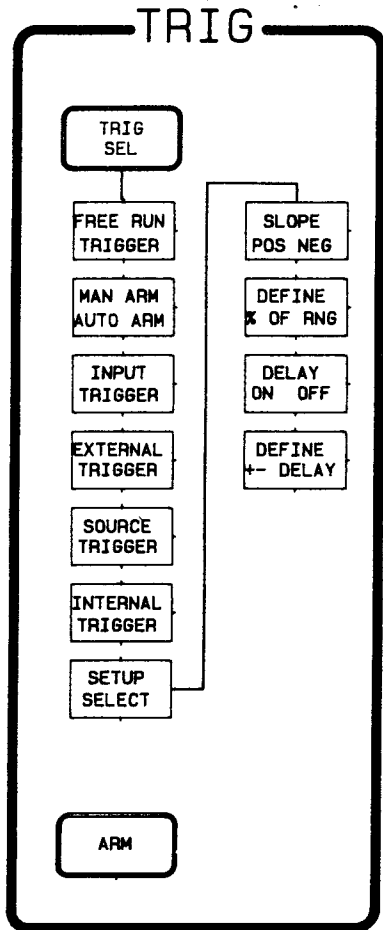
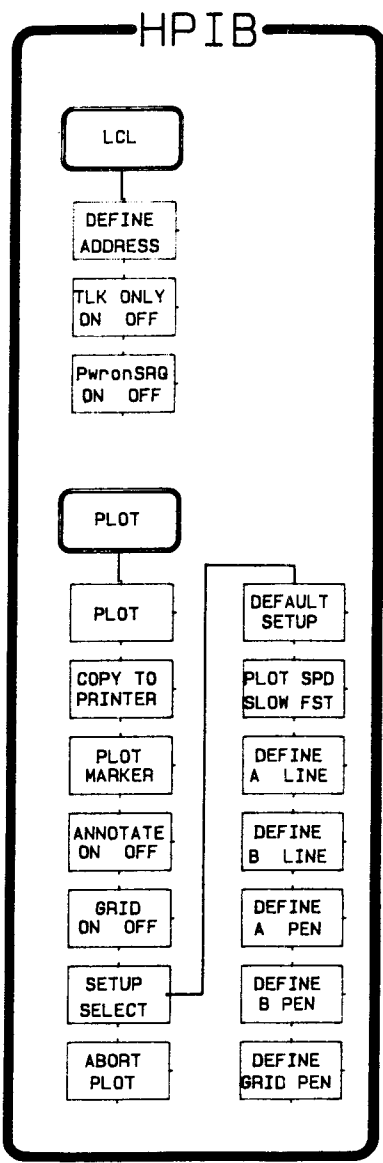

Figure A-3. -hp-3561A Menus
Sheet 2

APPENDIX A

QUICK REFERENCE I

APPENDIX B

OVERVIEW OF DYNAMIC SIGNAL ANALYSIS V
 FFT Properties V
 Aliasing VIII
 Relationship of Lines to the -hp-3561A
 Specifications IX
 Time Buffer X
 Pre and Post Trigger X
 Overlap Processing XI
 Windowing XII
 Bibliography XVII

APPENDIX C

OPERATING DIAGNOSTIC MESSAGES XIX

APPENDIX D

**COMMON MEASUREMENTS
AND MATH FUNCTIONS** XXXV

APPENDIX E

SPECIFICATIONS XXXIX

APPENDIX
QUICK REFERENCE
OVERVIEW OF DYNAMIC SIGNAL ANALYSIS
OPERATING DIAGNOSTIC MESSAGES
SPECIFICATIONS

