

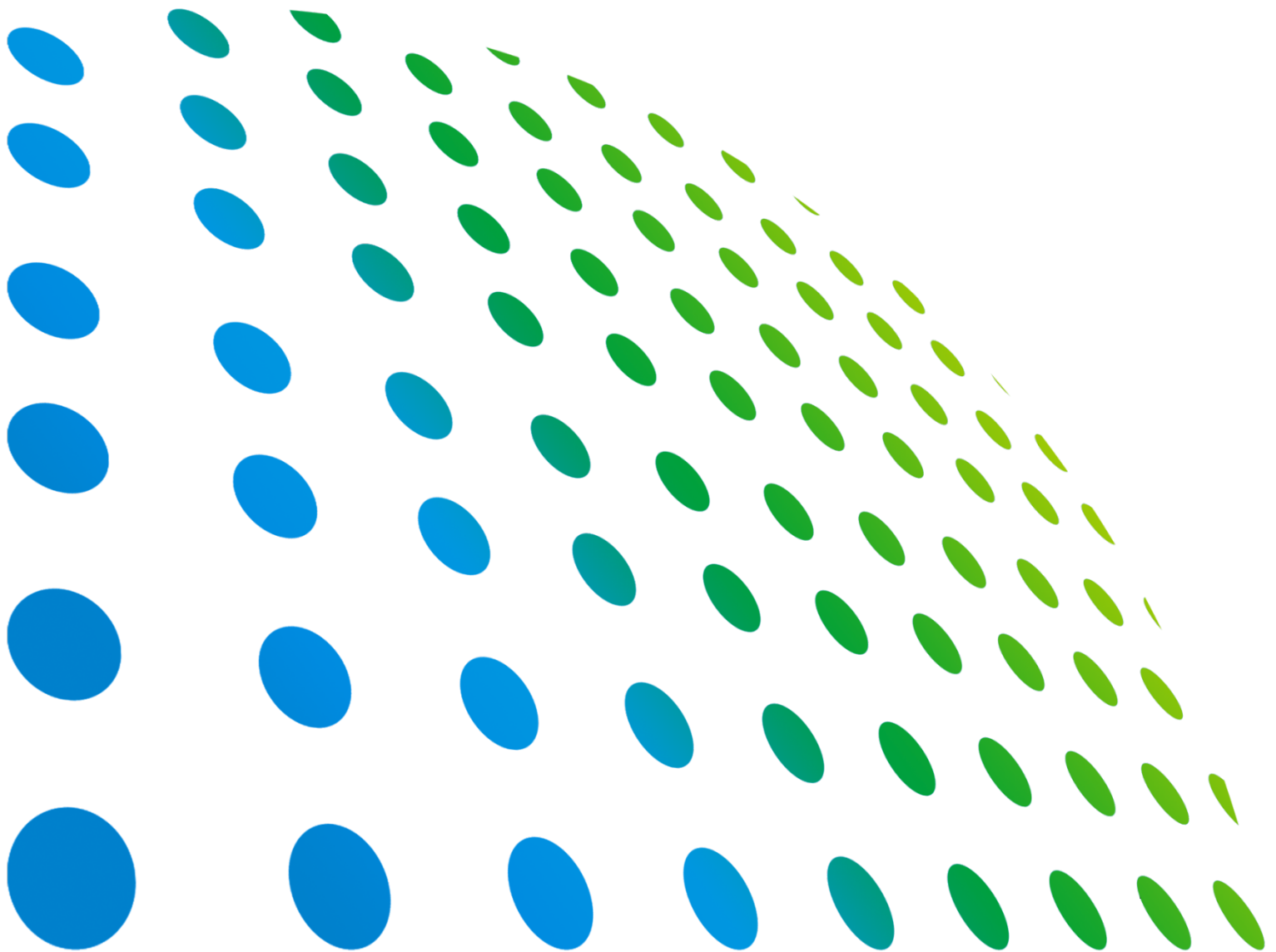

Programmable AC Source
6430/6420/6415
User's Manual



Programmable AC Source 6430/6420/6415 User's Manual



Version 1.6
July 2016

Legal Notices

The information in this document is subject to change without notice.

Chroma ATE INC. makes no warranty of any kind with regard to this manual, including, but not limited to, the implied warranties of merchantability and fitness for a particular purpose. Chroma ATE INC. shall not be held liable for errors contained herein or direct, indirect, special, incidental or consequential damages in connection with the furnishing, performance, or use of this material.

CHROMA ATE INC.

66 Huaya 1st Road, Guishan, Taoyuan 33383, Taiwan

Copyright Notices. Copyright 2002 - 2016 Chroma ATE INC., all rights reserved.

Reproduction, adaptation, or translation of this document without prior written permission is prohibited, except as allowed under the copyright laws.

Warranty

All of Chroma's instruments are warranted against defects in material and workmanship for a period of one year from date of shipment. Chroma agrees to repair or replace any assembly or component found to be defective, under normal use during this period. Chroma's obligation under this warranty is limited solely to repairing any such instrument, which in Chroma's sole opinion proves to be defective within the scope of the warranty when returned to the factory or to an authorized service center. Purchaser is responsible for the shipping and cost of the service item to Chroma factory or service center. Shipment should not be made without prior authorization by Chroma.

This warranty does not apply to any products repaired or altered by persons not authorized by Chroma, or not in accordance with instructions furnished by Chroma. If the instrument is defective as a result of misuse, improper repair, or abnormal conditions or operations, repairs will be billed at cost.

Chroma assumes no responsibility for its product being used in a hazardous or dangerous manner either alone or in conjunction with other equipment. High voltage used in some instruments may be dangerous if misused. Special disclaimers apply to these instruments. Chroma assumes no liability for secondary charges or consequential damages and in any event, Chroma's liability for breach of warranty under any contract or otherwise, shall not exceed the purchase price of the specific instrument shipped and against which a claim is made.

Any recommendations made by Chroma regarding the use of its products are based upon tests believed to be reliable; Chroma makes no warranty of the results to be obtained. This warranty is in lieu of all other warranties, expressed or implied, and no representative or person is authorized to represent or assume for Chroma any liability in connection with the sale of our products other than set forth herein.

CHROMA ATE INC.

66 Huaya 1st Road, Guishan,
Taoyuan 33383, Taiwan
Tel: 886-3-327-9999
Fax: 886-3-327-2886
e-mail: info@chromaate.com
<http://www.chromaate.com>

Material Contents Declaration

The recycling label shown on the product indicates the Hazardous Substances contained in the product as the table listed below.

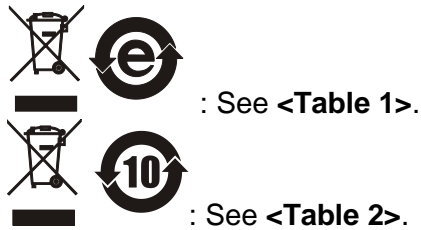

<Table 1>

Part Name	Hazardous Substances					
	Lead	Mercury	Cadmium	Hexavalent Chromium	Polybrominated Biphenyls	Polybromodiphenyl Ethers
	Pb	Hg	Cd	Cr ⁶⁺	PBB	PBDE
PCBA	○	○	○	○	○	○
CHASSIS	○	○	○	○	○	○
ACCESSORY	○	○	○	○	○	○
PACKAGE	○	○	○	○	○	○

“O” indicates that the level of the specified chemical substance is less than the threshold level specified in the standards of SJ/T-11363-2006 and EU 2005/618/EC.

“x” indicates that the level of the specified chemical substance exceeds the threshold level specified in the standards of SJ/T-11363-2006 and EU 2005/618/EC.

Disposal

Do not dispose of electrical appliances as unsorted municipal waste; use separate collection facilities. Contact your local government for information regarding the collection systems available. If electrical appliances are disposed of in landfills or dumps, hazardous substances can leak into the groundwater and get into the food chain, damaging your health and well-being. When replacing old appliances with a new one, the retailer is legally obligated to take back your old appliances for disposal free of charge.



<Table 2>

Part Name	Hazardous Substances					
	Lead	Mercury	Cadmium	Hexavalent Chromium	Polybrominated Biphenyls	Polybromodiphenyl Ethers
	Pb	Hg	Cd	Cr ⁶⁺	PBB	PBDE
PCBA	×	○	○	○	○	○
CHASSIS	×	○	○	○	○	○
ACCESSORY	×	○	○	○	○	○
PACKAGE	○	○	○	○	○	○

“○” indicates that the level of the specified chemical substance is less than the threshold level specified in the standards of SJ/T-11363-2006 and EU 2005/618/EC.

“×” indicates that the level of the specified chemical substance exceeds the threshold level specified in the standards of SJ/T-11363-2006 and EU 2005/618/EC.

1. Chroma is not fully transitioned to lead-free solder assembly at this moment; however, most of the components used are RoHS compliant.
2. The environment-friendly usage period of the product is assumed under the operating environment specified in each product’s specification.

Disposal

Do not dispose of electrical appliances as unsorted municipal waste; use separate collection facilities. Contact your local government for information regarding the collection systems available. If electrical appliances are disposed of in landfills or dumps, hazardous substances can leak into the groundwater and get into the food chain, damaging your health and well-being. When replacing old appliances with a new one, the retailer is legally obligated to take back your old appliances for disposal free of charge.





Declaration of Conformity

For the following equipment :

Programmable AC Source

(Product Name/ Trade Name)

6415, 6420, 6430, 6460, 6463, 6490, 6512, 6520, 6530, 6560, 6590

(Model Designation)

CHROMA ATE INC.

(Manufacturer Name)

66 Huaya 1st Road, Guishan, Taoyuan 33383, Taiwan

(Manufacturer Address)

Is herewith confirmed to comply with the requirements set out in the Council Directive on the Approximation of the Laws of the Member States relating to Electromagnetic Compatibility (2014/30/EU) and Low Voltage Directive (2014/35/EU). For the evaluation regarding the Directives, the following standards were applied :

EN 61326-1:2013 Class A, EN 61326-2-1:2013, EN 55011:2009+A2:2010 Group 1 Class A

EN 61000-3-11:2000, EN 61000-3-12:2011

EN 61326-1:2013(industrial locations)

EN 61000-4-2:2009, EN 61000-4-3:2006+A1:2008+A2:2010, EN 61000-4-4:2012,

EN 61000-4-5:2014, EN 61000-4-6:2009, EN 61000-4-8:2010, EN 61000-4-34:2007+A1:2009

EN 61010-1:2010

The following importer/manufacturer or authorized representative established within the EUT is responsible for this declaration :

CHROMA ATE INC.

(Company Name)

66 Huaya 1st Road, Guishan, Taoyuan 33383, Taiwan

(Company Address)

Person responsible for this declaration:

Mr. Vincent Wu

(Name, Surname)

T&M BU Vice President

(Position/Title)

Taiwan

2016.05.10

Vincent Wu

(Place)

(Date)

(Legal Signature)

Safety Summary

The following general safety precautions must be observed during all phases of operation, service, and repair of this instrument. Failure to comply with these precautions or specific WARNINGS given elsewhere in this manual will violate safety standards of design, manufacture, and intended use of the instrument. *Chroma* assumes no liability for the customer's failure to comply with these requirements.



BEFORE APPLYING POWER

Verify that the power is set to match the rated input of this power supply.



PROTECTIVE GROUNDING

Make sure to connect the protective grounding to prevent an electric shock before turning on the power.



NECESSITY OF PROTECTIVE GROUNDING

Never cut off the internal or external protective grounding wire, or disconnect the wiring of protective grounding terminal. Doing so will cause a potential shock hazard that may bring injury to a person.



FUSES

Only fuses with the required rated current, voltage, and specified type (normal blow, time delay, etc.) should be used. Do not use repaired fuses or short-circuited fuse holders. To do so could cause a shock or fire hazard.



DO NOT OPERATE IN AN EXPLOSIVE ATMOSPHERE

Do not operate the instrument in the presence of flammable gases or fumes. The instrument should be used in an environment of good ventilation.















DO NOT REMOVE THE COVER OF THE INSTRUMENT

Operating personnel must not remove the cover of the instrument. Component replacement and internal adjustment can be done only by qualified service personnel.

WARNING

1. Lethal voltage. AC source can supply 426 V peak at their output.
2. DEATH on contact may result if the output terminals or circuits connected to the output are touched when power is applied.

Safety Symbols

	DANGER – High voltage.
	Explanation: To avoid injury, death of personnel, or damage to the instrument, the operator must refer to the explanation in the instruction manual.
	High temperature: This symbol indicates the temperature is hazardous to human beings. Do not touch it to avoid any personal injury.
	Protective grounding terminal: This symbol indicates that the terminal must be connected to ground before operation of the equipment to protect against electrical shock in case of a fault.
	Functional grounding: To identify an earth (ground) terminal in cases where the protective ground is not explicitly stated. This symbol indicates the power connector does not provide grounding.
	Frame or chassis: To identify a frame or chassis terminal.
	Alternating Current (AC)
	Direct Current (DC) / Alternating Current (AC)
	Direct Current (DC)
	Push-on/Push-off power switch
	The WARNING sign highlights an essential operating or maintenance procedure, practice, condition, statement, etc., which if not strictly observed, could result in injury to, or death of, personnel or long term health hazards.
	The CAUTION sign highlights an essential operating or maintenance procedure, practice, condition, statement, etc., which if not strictly observed, could result in damage to, or destruction of, equipment.
	The Notice sign highlights an essential operating or maintenance procedure, condition, or statement.

Revision History

The following lists the additions, deletions and modifications in this manual at each revision.

Date	Version	Revised Sections
Aug. 2002	1.0	Complete this manual
May 2005	1.1	Change the address and phone number of Chroma
Dec. 2007	1.2	Add <i>“Material Contents Declaration”</i> Modify the Accuracy of Voltage and Frequency in the section of <i>“Specifications”</i> .
Mar. 2008	1.3	Add the description of <i>“NOTICE”</i> in the section of <i>“Range”</i> .
Oct. 2008	1.4	Add the section of <i>“Appendix A TTL I/O Pin Assignment”</i> . Modify the following sections: <ul style="list-style-type: none">– the description of <i>“B. Input/Output”</i> in the section of <i>“The Features”</i>.– the description of <i>“Frequency Accuracy”</i> in the section of <i>“Specifications”</i>.– <i>“Figure1-2 & Table 1-2”</i> in the section of <i>“Rear Panel”</i>.– the description of <i>“Max. Current”</i> in the section of <i>“Ratings”</i>.– the descriptions of <i>“CURRent:, VOLTage:EPProgram and VOLT:RANGE”</i> commands in the section of <i>“Command Dictionary”</i>.
Jul. 2014	1.5	Modify the following sections: <ul style="list-style-type: none">– <i>“CE Declaration”</i>– the description of <i>“Input Ratings”</i> in the section of <i>“Specifications”</i>.– <i>“Figure 1-1, 1-2 and Table 1-2”</i> in the section of <i>“Operational Panels”</i>.– <i>“Input Voltage Range description and Figure 2-1”</i> in the section of <i>“Requirements of Input Power”</i>.– <i>“Figure 2-2”</i> in the section <i>“Output Connection”</i>.– <i>“Figure 2-3, 2-4, 2-5, 2-6”</i> in the section of <i>“I/O Connectors (Optional)”</i>.
Jul. 2016	1.6	Modify <i>“CE Declaration of Conformity”</i> .

Table of Contents

1.	An Overview of the Products.....	1-1
1.1	Introduction.....	1-1
1.2	The Features.....	1-1
1.3	Specifications.....	1-1
1.4	Operational Panels.....	1-3
1.4.1	Front Panel.....	1-3
1.4.2	Rear Panel.....	1-5
2.	Installation.....	2-1
2.1	Inspection.....	2-1
2.2	Preparation for Use.....	2-1
2.3	Requirements of Input Power.....	2-1
2.3.1	Ratings.....	2-1
2.3.2	Input Connection.....	2-1
2.4	Output Connection.....	2-2
2.5	Remote Sense Connection.....	2-3
2.6	Power-on Procedures.....	2-3
2.7	I/O Connectors (Optional).....	2-4
3.	Local Operation.....	3-1
3.1	Introduction.....	3-1
3.2	Setup.....	3-1
3.2.1	GPIB Address.....	3-1
3.2.2	RS-232C.....	3-2
3.2.3	Over Voltage Protection.....	3-2
3.2.4	Sound (ON/OFF).....	3-3
3.2.5	System Test.....	3-3
3.2.6	Power on Status.....	3-3
3.2.7	Remote Sense (ON/OFF).....	3-4
3.3	Output Setting and Execution.....	3-4
3.3.1	I Limit.....	3-4
3.3.2	Range.....	3-5
3.3.3	Output V and F.....	3-5
3.4	Save and Recall.....	3-6
3.5	Data Lock.....	3-6
3.6	Ext Prog.....	3-6
3.7	Measurement.....	3-7
3.7.1	Select the Items of Measurement.....	3-7
3.7.2	Functions of Measurement.....	3-8
3.8	Local Operation.....	3-8
3.9	Protection.....	3-8
4.	Theories of Operation.....	4-1
4.1	General Information.....	4-1
4.2	Description of Overall System.....	4-1
4.3	AC/DC Power Stage Converter.....	4-2
4.4	DC/DC Power Stage Converter.....	4-3
4.5	DC/AC Inverter.....	4-3
4.6	CPU.....	4-3
4.7	Measurement.....	4-3
4.8	Sine Wave Generator.....	4-3
4.9	Keyboard and Display.....	4-4
4.10	GPIB/RS-232C/External Reference.....	4-4

5.	Self-Test and Troubleshooting	5-1
5.1	General Information	5-1
5.2	Self-Test Routine	5-1
5.3	Troubleshooting	5-1
6.	Remote Operation	6-1
6.1	General Information	6-1
6.2	The GPIB Capability of the AC Source.....	6-1
6.3	Introduction to Programming	6-2
6.3.1	Conventions	6-2
6.3.2	Numerical Data Formats.....	6-2
6.3.3	Boolean Data Format	6-3
6.3.4	Character Data Format.....	6-3
6.3.5	Basic Definition	6-3
6.4	Traversal of the Command Tree	6-4
6.5	Execution Order	6-4
6.6	The Commands of the AC Source	6-5
6.6.1	Command Tree Table	6-5
6.6.2	Command Dictionary.....	6-7
6.7	Status Reporting	6-15
6.7.1	Questionable Status	6-15
6.7.2	Standard Event Status	6-15
6.7.3	Status Byte Register.....	6-16
6.8	Error Messages.....	6-17
Appendix A	TTL I/O Pin Assignment	A-1

1. An Overview of the Products

1.1 Introduction

The products of Chroma 6400 series, including 6404, 6408, 6415, 6420 and 6430, are highly efficient AC power sources providing sine wave output of low distortion. The microprocessor-controlled sine wave oscillator generates accurate and stable output voltage and frequency. The PWM (Pulse Width Modulation) approach of the power stage provides full volt-ampere and current rating to loads. The 6430 supplies power up to 3000 VA, the 6420 to 2000 VA, and the 6415 to 1500 VA.

The AC power sources of Chroma 6400 series are considerably smaller, lighter and more efficient than traditional power supplies with similar capability of outputting power.

This manual includes the specifications, installation procedures, operation instructions and maintenance procedures of Chroma 6430/6420/6415 programmable AC sources.

1.2 The Features

A. Configuration

- Local operation through the keypad on front panel.
- Remote operation through GPIB or RS-232C interface.
- Protection against over power, over current, over temperature, under voltage, fan failure, and open circuit.
- Temperature-controlled fan speed.
- Built-in output isolation relays.

B. Input/Output

- Selective full scale output: 150V/300V Auto.
- Remote control by analog voltage reference.
- Measurement of V, F, PF, CF, I, P.
- Programmable limit of output Irms.
- AC ON/OFF output signal

1.3 Specifications

The operational specifications of Chroma 6430/6420/6415 are listed in the subsection. All specifications are tested according to the standard Chroma test procedures.

All specifications are based on the resistor load of $25 \pm 1^\circ\text{C}$ unless specified otherwise.

Model	6404	6408	6415	6420	6430
OUTPUT RATINGS					
Max. Power	375VA	800VA	1500VA	2000VA	3000VA
Voltage					
Range	150V/300V/Auto	150V/300V/Auto	150V/300V/Auto	150V/300V/Auto	150V/300V/Auto
Accuracy	0.2%F.S.for freq.≤ 200Hz	0.2%F.S.for freq. ≤ 200Hz	0.2% reading + 0.2% of	0.2% reading + 0.2% of	0.2% reading + 0.2% of F.S.(45-1KHz)

	0.4%F.S.for freq.>200Hz	0.4%F.S.for freq.>200Hz	F.S.(45-1KHz)	F.S.(45-1KHz)	
Resolution	0.1V	0.1V	0.1V	0.1V	0.1V
Distortion	typ 0.3%for freq. ≤ 200Hz typ 0.8%for freq.>200Hz	typ 0.3%for freq. ≤ 200Hz typ 0.8%for freq.>200Hz	0.5%for (45-500Hz) 1%for (>500-1KHz)	0.5%for (45-500Hz) 1%for (>500-1KHz)	0.5%for (45-500Hz) 1%for (>500-1KHz)
Line Regulation	0.1%	0.1%	0.1%	0.1%	0.1%
Load Regulation	0.1%	0.1%	0.1%	0.1%	0.1%
Temp. coefficient	0.02%per°C	0.02%per°C	0.02%per°C	0.02%per°C	0.02%per°C
Max. current					
rms	2.5A/1.25A	5.33A/2.67A	15A/7.5A	20A/10A	30A/15A
Crest Factor	typ.2.8for freq. ≤ 100Hz typ.2.2for freq.>100Hz	typ.2.8for freq. ≤ 100Hz typ.2.2for freq.>100Hz	3 (45-100Hz) 2.5 (>100-1KHz)	3 (45-100Hz) 2.5 (>100-1KHz)	3 (45-100Hz) 2.5 (>100-1KHz)
Frequency					
Range	45-500Hz	45-500Hz	45-1KHz	45-1KHz	45-1KHz
Accuracy	0.1%	0.1%	0.1%	0.1%	0.1%
Resolution	0.1Hz	0.1Hz	0.1Hz	0.1Hz	0.1Hz
INPUT RATINGS					
Voltage Range	100-120V±10% /200-240V±10%	100-120V±10% (6408-1) 200-240V±10% (6408-2)	200-240V±10%	200-240V±10%	200-240V±10%
Frequency Range	47-63Hz	47-63Hz	47-63Hz	47-63Hz	47-63Hz
Current	7.5A Max.	12A Max.(6408-1) 6A Max.(6408-2)	12A Max.	15A Max.	23A Max.
Power Factor	0.8 typ.	0.98 Min.	0.95 Min.	0.97 Min.	0.98 Min.
MEASUREMENT					
Voltage					
Range	0-150V/0-300V	0-150V/0-300V	0-150V/0-300V	0-150V/0-300V	0-150V/0-300V
Accuracy	0.1%F.S.+0.1%	0.1%F.S.+0.1%	0.1%F.S.+0.25%	0.1%F.S.+0.25%	0.1%F.S.+0.25%
Resolution	0.1V	0.1V	0.1V	0.1V	0.1V
Current					
Range	0-2A/2-10A	0-4A/4-20A	0-70A	0-100A	0-140A
Accuracy	0.2%F.S.+0.5%	0.2%F.S.+0.5%	0.2%F.S.+0.4%	0.15%F.S.+0.4%	0.1%F.S.+0.4%
Resolution	0.01A	0.01A	0.01A	0.01A	0.01A
Power					
Range	0-375W	0-800W	0-1500W	0-2000W	0-3000W
Accuracy	0.5%F.S.	0.5%F.S.	1%F.S.(CF<6)	1%F.S.(CF<6)	1%F.S.(CF<6)
Resolution	0.1W	0.1W	0.1W For P<1000W 1W For P>1000W	0.1W For P<1000W 1W For P>1000W	0.1W For P<1000W 1W For P>1000W
OTHERS					
Efficiency	75% typ.	80% typ.	80% typ.	80% typ.	80% typ.
Protection	UVP,OVP,OPP, OCP,OTP,Short	UVP,OVP,OPP, OCP,OTP,Short	UVP,OVP,OPP, OCP,OTP,Short	UVP,OVP,OPP, OCP,OTP,Short	UVP,OVP,OPP, OCP,OTP,Short
SAFETY & EMC	CE (INCLUDES LVD and EMC REQUIREMENT)				

- Note**
1. Maximum distortion for voltage ranges from half to full range with linear load.
 2. These items are treated with full power linear load.

1.4 Operational Panels

1.4.1 Front Panel

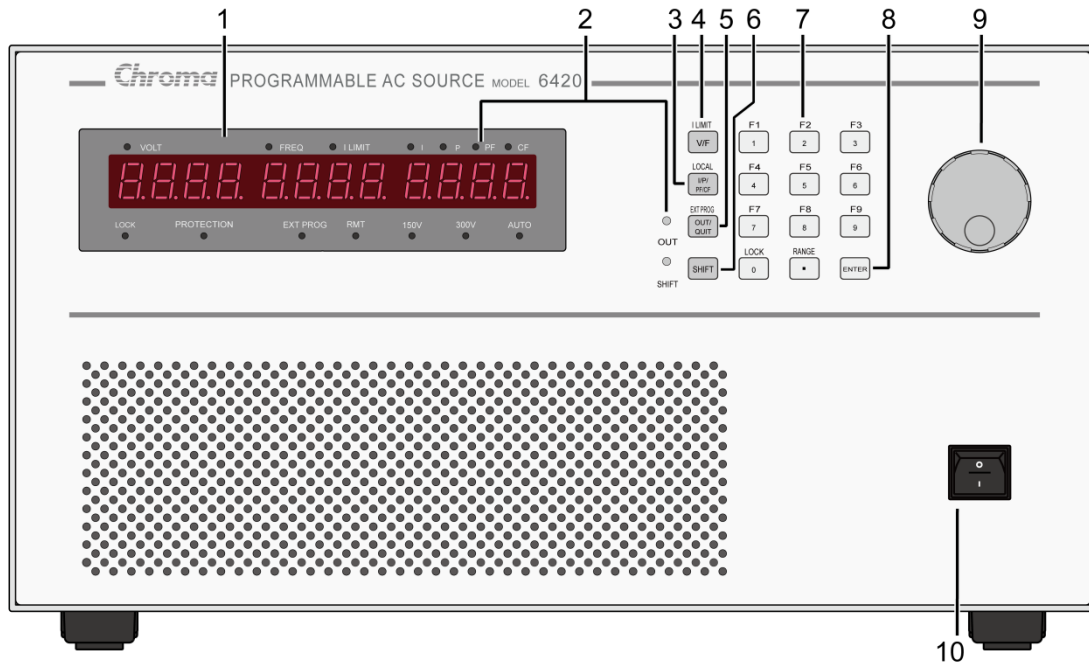



Figure 1-1 Front Panel

Table 1-1 The Description of the Front Panel

Item	Symbol	Description
1		Alphanumeric LED: A row of red seven-segment LEDs are equipped for displaying setup messages and numeric value of settings, or measurement results. The display area is divided into three sections: value of V shown on the left, frequency or I limit in the middle, and any of I/P/PF/CF measurement value on the right.
2		Indicator LED: LEDs located on the upper and lower part of the display panel are the indicators showing the activated status. These indicators include “VOLT”, “FREQ”, “I LIMIT”, “I”, “P”, “PF”, “CF”, “LOCK”, “PROTECTION”, “EXT PROG”, “RMT”, “150V”, “300V”, “AUTO”. Besides, two LEDs, “OUT” and “SHIFT” for showing activation of output and shift mode, are located on the keypad area next to the corresponding keys.
3	<div style="border: 1px solid black; padding: 2px; display: inline-block;">V/F</div> ----- or ----- <div style="border: 1px solid black; padding: 2px; display: inline-block;">I limit</div>	V/F or I limit selection key: In normal mode, the <div style="border: 1px solid black; padding: 2px; display: inline-block;">V/F</div> key offers the user the option of programming voltage or frequency. In shift mode, this key enables the user to program software rms (root mean square) limit on the output current.
4	<div style="border: 1px solid black; padding: 2px; display: inline-block;">I/P/PF/CF</div> ----- or -----	I/P/PF/CF selection key: In normal mode, the user can repeatedly press this key to select one of the measurement values to display. In shift mode, this key provides the user with returning controls from remote PC to front panel keypad.

	LOCAL	
5	OUT/QUIT ----- or ----- EXT PROG	OUT/QUIT command key : In normal operation, pressing of the key may enable the 6430/6420/6415 output power to the loading devices. If the user has entered into setup procedures, this key will be used to quit from present setting routine. In shift mode, this key enables external programming.
6	SHIFT	Shift mode selection key : Pressing of the key makes the 6430/6420/6415 switch from normal operational mode to shift mode, or from shift mode to normal mode.
7	1 to 9 , 0 and . ----- or ----- F1 to F9 , LOCK , and RANGE	Numeric and decimal keys : In normal mode, the user can program numeric data with the digital keys and the decimal key. In shift mode, the keys from 1 to 9 save data into or recall them from memory channels F1 to F9 respectively. Additionally, In shift mode, 0 enables data lock and configuration setup , and . offers programming of the full range of output voltage.
8	ENTER	The ENTER key is to confirm the setting of parameters.
9		Rotary knob : The user may input programming data or options by turning the rotary knob to the desired ones.
10		Main Power switch : Power on/off the 6430/6420/6415 by this switch.

1.4.2 Rear Panel

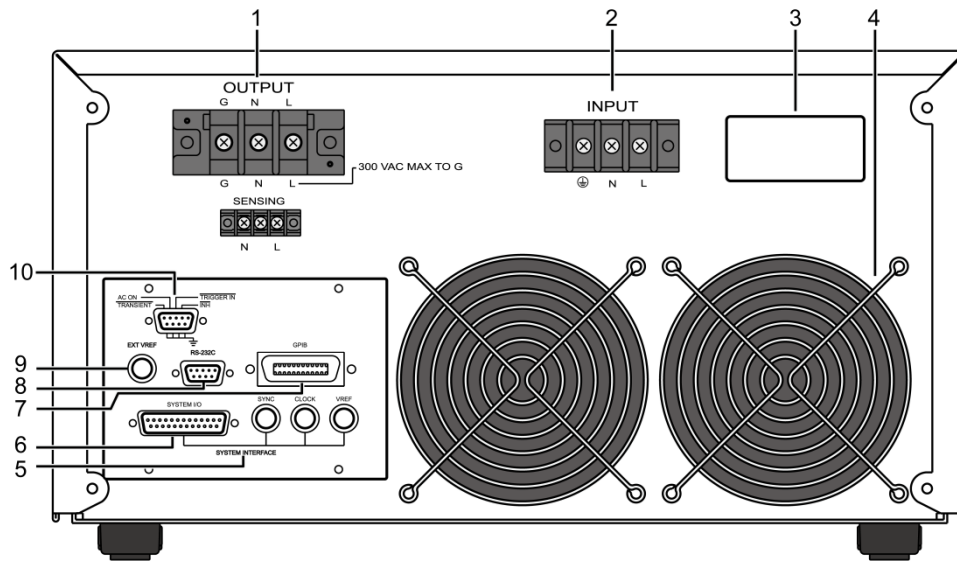

Figure 1-2 Rear Panel

Table 1-2 The Description of the Rear Panel

Item	Name	Description
1	Output Connector	This connector outputs power to the device with load.
2	Power Input Connector	Input power via the connector to connect to AC Source.
3	Label	The label marks model, serial no. of AC Source and input rating.
4	Cooling Fan	Cooling fan speed automatically increases or decreases as temperature rising or falling.
5	System Interface	Only for 6460, 6490, 6560 and 6590
6	System I/O	Only for 6460, 6490, 6560 and 6590
7	GPIB Connector	A kind of remote controller by using GPIB bus to connect to AC Source in order to control remotely.
8	RS-232C	9 pin connector; D type female connector for used in computer to transmit control command from/to remote PC in order to control remotely.
9	Ext. Ref.	The BNC connector inputs amplitude of control waveform from external device.
10	TTL I/O	9 pin connector; D type male connector for transmitting control signals consist of remote inhibit, transient and AC ON.

2. Installation

2.1 Inspection

When unpacking the instrument, inspect any damage that might have occurred during shipping. Save all packing materials in case the unit has to be returned.

If any damage is found, please file a claim with the carrier immediately. Do not return the instrument to the factory without prior RMA acceptance from Chroma.

2.2 Preparation for Use

In the beginning, the instrument must be connected with an appropriate AC line input. Then, since it is intelligently fan-cooled, it must be installed in sufficient space for the circulation of air. It should be used in an area where the ambient temperature is under +40°C.

2.3 Requirements of Input Power

2.3.1 Ratings

Input Voltage Range	200 ~ 240±10% Vac, single phase.
Input Frequency	47 ~ 63 Hz
Max. Current	6430 : 23A 6420 : 15A 6415 : 12A
Max. power	6430 : 4000 W 6420 : 2700 W 6415 : 2000 W

2.3.2 Input Connection

The input power terminal block is located on the rear panel of the instrument. Please refer to *Figure 2-1*. Input of the 6430/6420/6415 must be connected from a three-wired single phase AC power outlet. The current rating of the power line input must be larger than or equal to that of the fuse of the instrument.

⚠ WARNING To protect operating personnel, the wire connected to the GND terminal must be connected to an earth ground. In no event shall this instrument be operated without adequate ground connection.

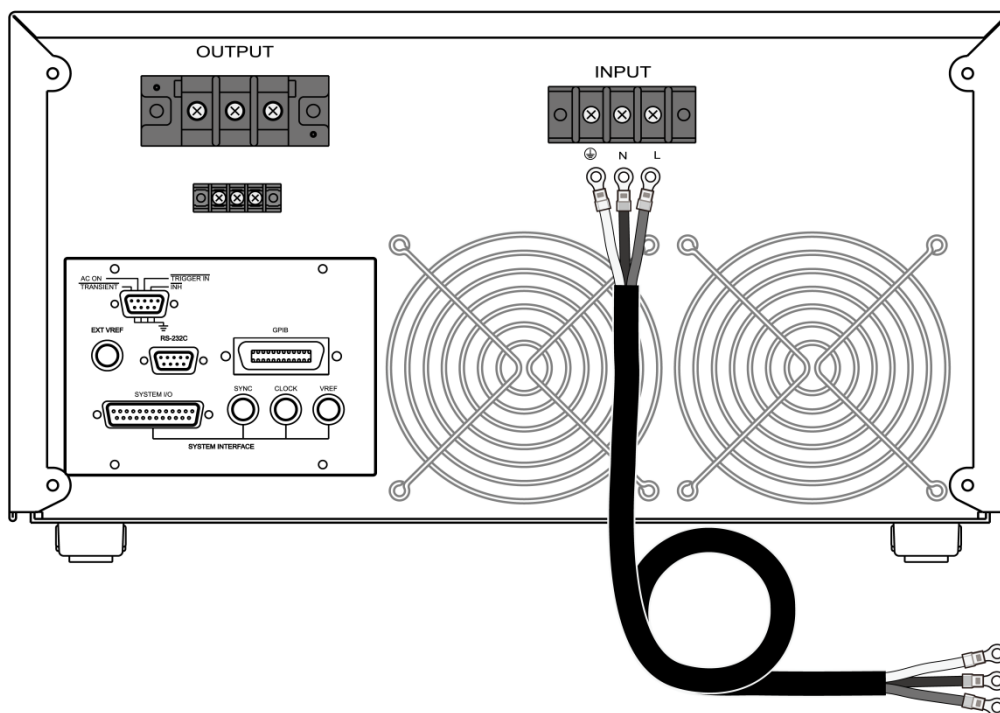

Figure 2-1 Input Connection

2.4 Output Connection

Output power can be connected from the terminal block located on the rear panel of the instrument through terminals L and N to the load as shown in *Figure 2-2*. For safety, the wires to the load should be of a sufficiently large gauge to insure that they do not overheat while carrying the output current.

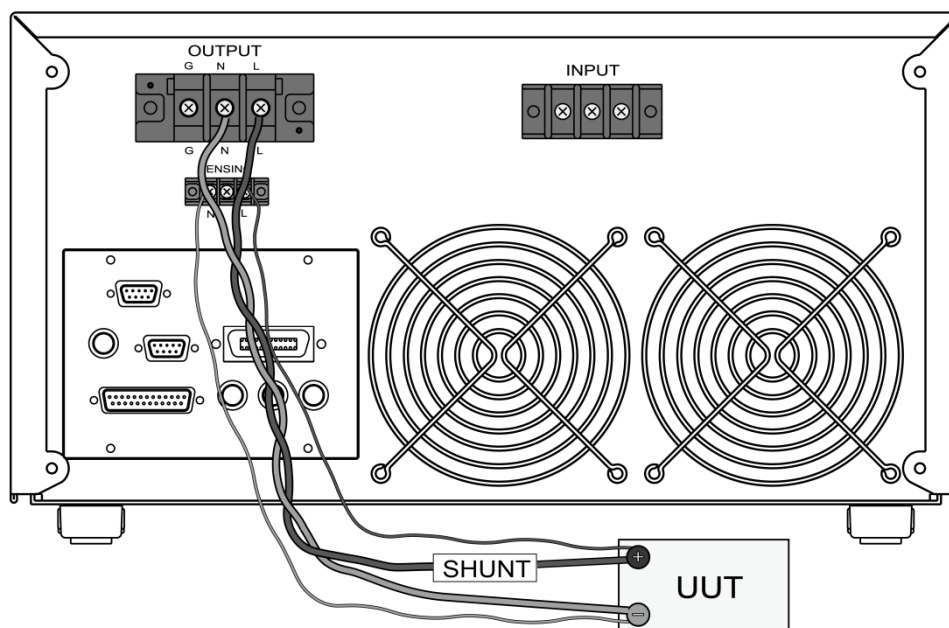

Figure 2-2 Output Connection

2.5 Remote Sense Connection

The remote sensing connection improves the voltage regulation by monitoring the voltage at the load, not at the AC source output terminal. Remote sensing allows the power supply to increase the output voltage automatically, and compensate for the voltage drops in the load leads. Note that with remote sensing, voltage read-back is at the load.

The instrument can be managed for remote voltage sensing by connecting the load leads from the output terminals to the load, and the sensing leads from the terminals L and N to the load as shown in *Figure 2-2*.

2.6 Power-on Procedures

Apply the line power to the input terminals, and turn on the power switch on the front panel. No load shall be connected to the output terminal block. The instrument will do a series of self-tests whenever the user turns on the power switch. All LEDs on the front panel, including alphanumeric and indicator LEDs, are lighted for three seconds or so. Then, the seven-segment LEDs and alphanumeric LEDs will display "SELF TEST". It means that the 6430, 6420 or 6415 is running a self-test.

Shortly afterwards, the seven-segment LEDs will display the model number like 6430, 6420 or 6415, and the firmware version number like ver 1.2 as below:

```
6430 ver 1.2
```

If any error is detected during the self-test, an error message will be displayed on the LED like the following one:

```
ROM TEST ERR.
```

The following table indicates all error messages and the recommended action:

Item	Error Message	Description	Action
1	ROM TEST ERR.	System ROM test failure.	Consult your dealer for assistance in case of self-test failure.
2	RAM1 ERROR	System RAM1 test failure.	
3	RAM2 ERROR	System RAM2 test failure.	
4	WAVEFORM ERR.	Waveform module test failure	
5	FRE. TEST ERR.	Frequency module test failure	

After the self-test is completed, the LEDs will show the current set values of V, F and the measured value of I, and indicate that the 6430, 6420 or 6415 is ready for use as below:

```
0.0 60.0 0.00
```

⚠ WARNING

Before the instrument is turned on, all protective earth terminals, extension cords, and devices connected to the instrument must be connected to a protective earth ground. Any interruption of the protective earth grounding will cause a potential shock hazard.

2.7 I/O Connectors (Optional)

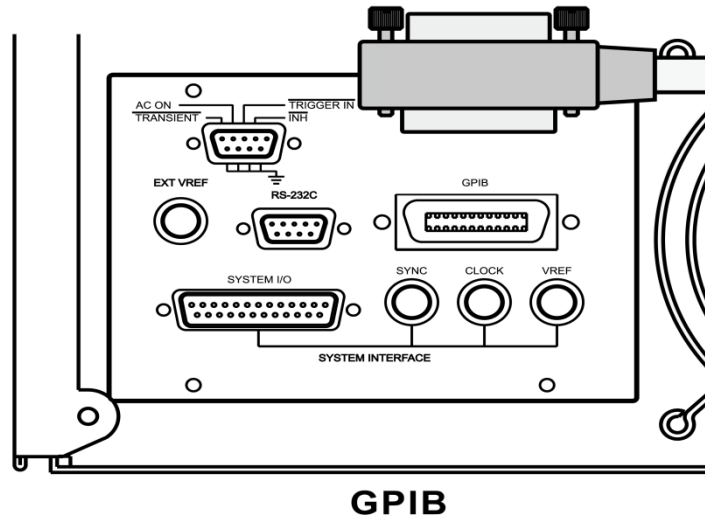

Figure 2-3 GPIB

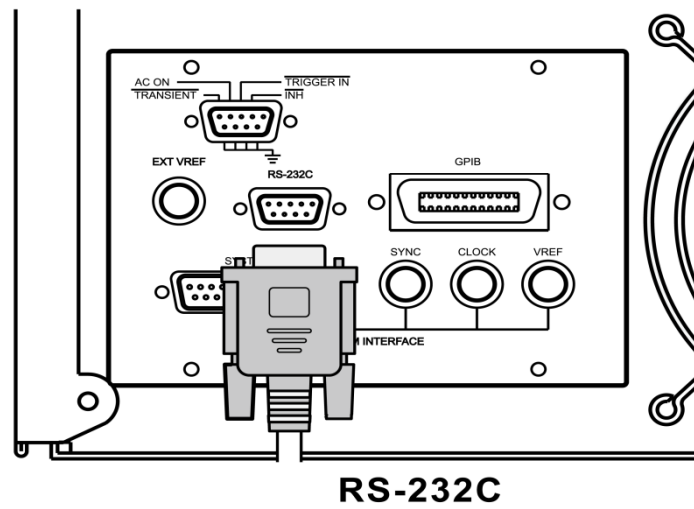

Figure 2-4 RS-232C

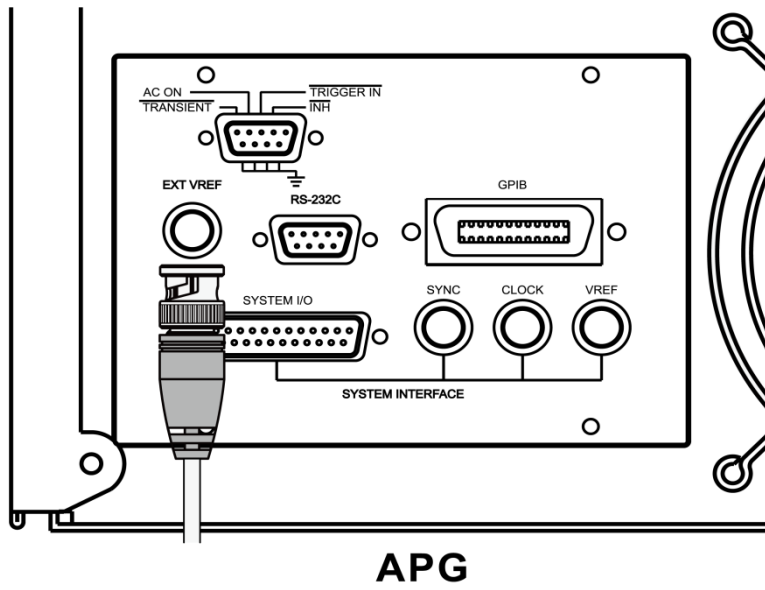
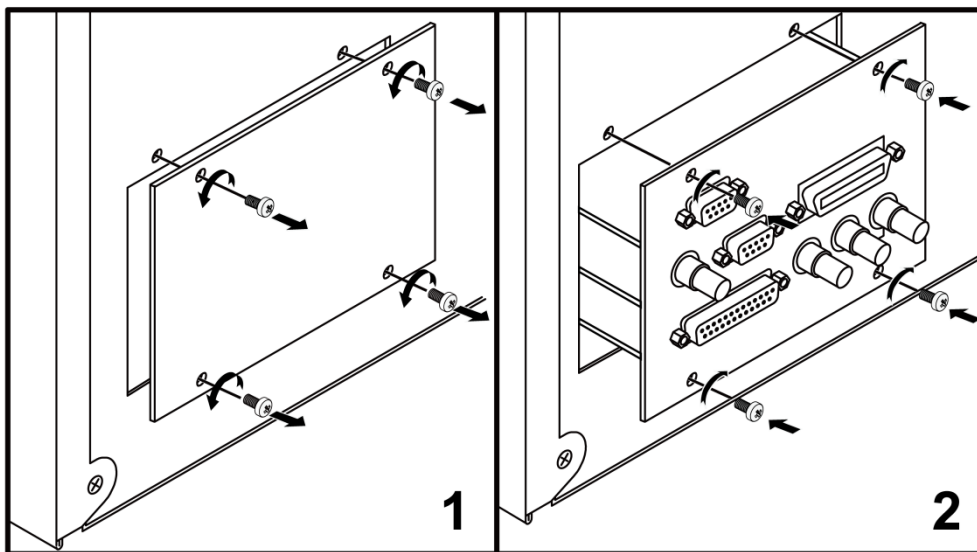

Figure 2-5 APG



Instatl Optional Borad

Figure 2-6 Optional Board

3. Local Operation

3.1 Introduction

The Chroma 6430/6420/6415 AC sources can be configured to operate in local or remote operational mode. The operation of the 6430/6420/6415 through a keypad on the front panel for data entry as well as test execution in local mode will be described here while that through a remote GPIB controller in remote mode in Chapter Six.

3.2 Setup

The configurational setup of the 6430/6420/6415 includes GPIB address, RS-232C baud rate, parity, OVP setting, enabled key stroke sound, and system test. The user has to start the configurational setup when he operates the instrument for the first time. Then, he may modify the setup when the application is changed.

Press the **SHIFT** key to enter into the setup, and the green LED will be lighted. Then press the **0** key, and hold it for three seconds until the red seven-segment LEDs display as below:

SET UP	1
--------	---

- ⚡ CAUTION**
1. If the user seen the red indicator LED of “LOCK” lit before or duration pressing **0**, “LOCK” will be released and press **0** again to turn it off. The user needs to press **0** continuous to wait setup screen.
 2. Setup consists of five functions that can be selected separately by **1**, ... or **5** and **ENTER**. The detail is described in the subsections below.

3.2.1 GPIB Address

The 6430/6420/6415 provide the user with remote operational mode. For details can refer to *Chapter 6*. However, prior to operating remotely, he has to set GPIB address as follows:

For example: set GPIB address as 25.

Action	Display
1. Enter configurational setup as stated in 3.2 if required. SET	Up 1
2. Press 1 , ENTER .	Gpib Addr1
3. Press 2 , 5 , ENTER .	GpibAddr 25
4. Press OUT/QUIT .	SEt Up 1
5. Select other setups by numeric keys, or press OUT/QUIT again to exit from setup.	



- ⚡ CAUTION**
1. Addressing space ranges from 0 to 30.

2. After the last numeric key is pressed, the **ENTER** key must be pressed in two seconds to confirm the data entry, otherwise the 6430/6420/6415 will disregard the programming value, and the previous data will remain. This note can be applied to all circumstances when the user enters numeric values.

3.2.2 RS-232C

The 6430/6420/6415 can be operated remotely by the use of RS-232C bus. Communication protocol is set as follows:

Example: set baud rate = "19200", parity "ODD".

Action	Display
1. Enter configurational setup as stated in 3.2 if required. SEt	Up 1
2. Press 2 , ENTER .	232C bAUd 96
3. Use  to select "19200".	232C bAUd 192
4. Press ENTER .	232C Prty none
5. Use  to select "ODD".	232C Prty odd
6. Press ENTER .	232C bAUd 192
7. Press OUT/QUIT .	SEt Up 2
8. Select other setups by numeric keys, or press OUT/QUIT again to exit from setup.	

Notice

1. Baud rate options are 2400, 4800, 9600, and 19200. They are displayed as 24, 48, 96, and 192 respectively.
2. Parity options are "NONE", "EVEN", and "ODD". They are displayed as "nonE", "EVEN", and "odd" respectively.

3.2.3 Over Voltage Protection

The user can set the limit of output voltage, so when the 6430/6420/6415 output power, the voltage will never exceed the user-defined upper limit in order to protect the loading devices.

Example: set the upper limit of output voltage as 120V.

Action	Display
1. Enter configurational setup as stated in 3.2 if required. SEt	Up 1
2. Press 3 , ENTER .	OVP SEt 300.0
3. Press 1 , 2 , 0 , ENTER .	OVP SEt 120.0
4. Press OUT/QUIT .	SEt Up 3
5. Select other setups by numeric keys, or press OUT/QUIT again to exit from setup.	

Notice

1. Default limit is 300V.

3.2.4 Sound (ON/OFF)

The 6430/6420/6415 provide the user with the selection of beep sound while programmed by keypad or rotary knob. Default setting is “ON”. The user can change it as below:

Action	Display
1. Enter configurational setup as stated in 3.2 if required. SEt	Up 1
2. Press 4 , ENTER .	bEEP on
3. Use  to select “OFF” and press ENTER .	bEEP OFF
4. Press OUT/QUIT .	SEt Up 4
5. Select other setups by numeric keys, or press OUT/QUIT again to exit from setup.	

3.2.5 System Test

The user can check if the set value of output power is within specification. To do the test the user has to take the following procedures:

Action	Display
1. Enter configurational setup as stated in 3.2 if required. SEt	Up 1
2. Press 5 , ENTER .	SYS tEst no
3. Use  to select “YES” and press ENTER .	SYS tEst YES
4. Press OUT/QUIT .	SEt Up 5
5. Select other setups by numeric keys, or press OUT/QUIT again to exit from setup.	



CAUTION

1. Disconnect any output load when doing the system test.
2. In step 3 after pressing **ENTER**, the 6430/6420/6415 will perform the system test. Upon completion of the test, the 6430/6420/6415 will display the test result as “PASS” or “FAIL”. In case of failure please contact your dealer for help.

3.2.6 Power on Status

The user can set the initial value on output voltage, frequency, and range when the power switch is on. For example, the initial output data can be set as 230V, 50Hz, and range 300 as follows:

Action	Display
1. Enter configurational setup as stated in 3.2 if required. SEt	Up 1
2. Press 6 , ENTER .	turn on r 150
3. Use  to select output voltage range “300”.	turn on r 300
4. Press ENTER .	turn on V 110
5. Press 2 , 3 , 0 , ENTER .	turn on V 230
6. Press 5 , 0 , ENTER .	turn on F 50

7. Press **OUT/QUIT**. SEt Up 6
8. Select other setups by numeric keys, or press **OUT/QUIT** again to exit from setup.

3.2.7 Remote Sense (ON/OFF)

The 6430/6420/6415 provide the user with the selection of remote sensing output voltage while programmed by keypad or rotary knob. Default setting is "OFF". The user can change it as below:

Action	Display
1. Enter configurational setup as stated in 3.2 if required. SEt	Up 1
2. Press 7 , ENTER .	SEnSE V OFF
3. Use  to select "ON" and press ENTER .	SEnSE V ON
4. Press OUT/QUIT .	SEt Up 7
5. Select other setups by numeric keys, or press OUT/QUIT again to exit from setup.	

3.3 Output Setting and Execution

After the 6430/6420/6415 AC sources pass the power-on self-test, or when the user completes the configurational setup, the 6430/6420/6415 will show the following values on the seven-segment LEDs:

0.0 60.0 0.00

This means that the present output settings for V_{rms} is 0 Volt, the output frequency 60 Hz, and any of the output measured values (I/P/PF/CF) 0. Before programming outputs V and F, the user has to set current limit and output full range. These will be explained in the following three subsections.

3.3.1 I Limit

The function of output current limit is to guarantee that the output current does not exceed the preset value in order to protect the loading devices. The programmable range of rms current limit is from 0 to 30 amperes for 6430, 0 to 20 amperes for 6420, and 0 to 15 amperes for 6415. Operational example of setting I limit as 8A is given below:

Action	7-segment LED Display
1. Enter into shift mode by pressing SHIFT key, and the "SHIFT" LED will be on.	40.5 60.0 0.00
2. Press I limit to turn on the "I LIMIT" LED.	40.5 30.0 0.00
3. Press 8 , ENTER .	40.5 8.0 0.00
4. Press I limit to turn off the "I LIMIT" LED.	40.5 60.0 0.00

- ⚡ CAUTION**
- In step 2 **I limit** occupies the same place as **V/F** does. Its function will be augmented when shift mode is activated. Characters in blue print above the key indicate the new function as “I LIMIT”.
 - In step 3 the user can set the value of “I LIMIT” by pressing the keypad or turning .
 - When I limit is activated, the output will be disabled.

3.3.2 Range



The full range of output voltage can be selected as 150V, 300V, or AUTO. For example, set the range as 300V.

Action	Indicator LED Display
1. Enter into shift mode by pressing SHIFT key, and the “SHIFT” LED will be on.	Green “SHIFT” LED is on.
2. Press RANGE several times until the “300V” LED is on.	Green “300V” LED is on.
3. Press SHIFT to exit from the “SHIFT” mode.	Green “SHIFT” LED is off.

- ⚡ CAUTION** The instrument has AUTO RANGE function under FIX. MODE. Other modes are without AUTO RANGE function.

3.3.3 Output V and F

For example: set V as 135.5 volt and F as 82Hz.

Action	7-segment LED Display
1. If the “EXT PROG” LED is “ON”, please turn it off by pressing SHIFT key, and the “SHIFT” LED will be on. Then, press EXT PROG .	40.5 60.0 0.00
2. If the “SHIFT” LED is “ON”, exit from shift mode by pressing SHIFT , and the LED will be off.	40.5 60.0 0.00
3. Press V/F to switch on “VOLT” LED, but switch off “FREQ” LED.	40.5 60.0 0.00
4. Press 1 3 5 . 5 ENTER or turn  to the desired voltage value.	135.5 60.0 0.00
5. Press V/F to switch off “VOLT” LED, but switch on “FREQ” LED.	135.5 60.0 0.00
6. Press 8 2 ENTER or turn  to the desired frequency value.	135.5 82.0 0.00
7. After completion, press OUT/QUIT to activate the output power to the loading devices.	

3.4 Save and Recall

The 6430/6420/6415 AC sources provide nine memory channels for the user to save a set of frequently used V, F as well as V full range, and recall them for later use.

To save settings into the memory channel 5:

Action	7-segment LED Display
1. Enter into shift mode by pressing [SHIFT] key, and "SHIFT" LED will be on.	135.5 82.0 0.00
2. Press [F5] for three seconds until you hear a beep sound signal completion. The LED will display the memory channel number, F5.	135.5 82.0 F5

To recall from memory channel 4:

Action	7-segment LED Display
1. Enter into shift mode by pressing [SHIFT] key, and "SHIFT" LED will be on.	250.0 70.0 0.00
2. Press [F4] , and release it immediately. The contents of previously stored set values will be shown on the LED.	40.5 60.0 0.00
3. If these are not the desired set values, repeat step 2 to step 3 for other memory channels until the right ones are gained.	55.0 60.0 0.00
4. Press [ENTER] to confirm.	135.5 82.0 0.00

3.5 Data Lock

After the completion of setting values for outputs, the user can lock the keypad on the front panel so as to avoid incidental change. To lock the setting of output data, the user needs to press **[SHIFT]**, and the "SHIFT" LED will be on. Then, he can press **[LOCK]**, the same one as the **[0]** key, to turn on the "LOCK" LED. To unlock, he needs to press **[LOCK]**, the same one as the **[0]** key, to turn off the "LOCK" LED.

3.6 Ext Prog

The 6430/6420/6415 AC sources allow the user to use an external DC voltage level as a linear control reference for output Vrms. The relationship of Vout and Vref is listed as follows:

$$V_{out} = V_{ref} \div 10V \times V_{fs}$$

Vout : The Vrms output of the 6430/6420/6415.

Vref : DC level of the external control voltage.

Vfs : The current setting of full scale (full range) of output Vrms.

⚡ CAUTION The external DC voltage must not exceed 10.5 Volts. Because the cap of APG terminal is connected to earth ground, so floating or hazardous voltage on the cap may cause damage.

When the “EXT PROG” is active, the user cannot program the value of Vout, but he can do that of output F. To use this function, he must connect the external device of controlled DC to the “APG” port on the rear panel of any of the 6430/6420/6415 as illustrated in 2.6.

The user has to press **SHIFT** to make the “SHIFT” LED on. Then, he has to press **EXT PROG**, the same one as the **OUT/QUIT** key, to turn on the green “EXT PROG” LED. When he wants to quit from the “SHIFT” mode, he can press **SHIFT** to turn off the “SHIFT” LED.

The user can press the numeric keypad and **ENTER**, or turn  to change output frequency to the desired one. When he wants to end, he can press **EXT PROG**, the same one as the **OUT/QUIT** key, to turn off the green “EXT PROG” LED.

3.7 Measurement

The 6430/6420/6415 can measure the actual performances of V, F, I, P, PF, and CF of a connected load alone when they output power to the load. During operation, the data of the measurement of V and F are always shown on the LEDs at the left and middle zones. The right zone will display any of the measurement of I, P, PF, and CF according to the user’s choice.

The sample LED shows the measurement of V = 132.2V, and that of F = 75 Hz as below:

132.2	75.0	0.03
-------	------	------

The next subsection will describe how to select one of the measurement of I, P, PF, and CF for automatic read-back.

3.7.1 Select the Items of Measurement

1. If output is not activated, press **OUT/QUIT** to turn on the “OUT” LED.
2. When operating in “SHIFT” mode, exit from it by pressing **SHIFT** to turn off the green “SHIFT” LED.
3. Press **I/P/PF/CF** to turn on any of the four LEDs: I, P, PF, and CF.

The above key will keep changing one by one among the four options if the user presses it again and again. Hence, the correctly displayed value will react to the corresponding parameters of measurement as the following sequence when the key is pressed every time.

I ⇨ P ⇨ PF ⇨ CF ⇨ (goes back to I)

3.7.2 Functions of Measurement

The 6430/6420/6415 has the following six functions of measurement.

Function	Description
V	the readings of the measured Voltage in volts. (True R.M.S. measurement)
F	the readings of the measured Frequency in Hertz.
I	the readings of the measured Current in Amperes. (True R.M.S. measurement)
P	the measurement of True Power in Watts.
CF	Crest factor, calculation formula = I_{peak}/I_{rms} .
PF	Power factor, calculation formula = $\text{true power}/(V_{rms} \times I_{rms})$

3.8 Local Operation

During remote operation, the 6430, 6420, or 6415 is controlled by a remote GPIB or RS-232C controller, and the green indicator LED of "RMT" remains lighted. When the user wants to return from remote operation to local operation, he has to press **Local** in "SHIFT" mode.

If he is not in "SHIFT" mode, he needs to press **SHIFT** to return to normal mode before pressing **Local**.

3.9 Protection

During operation, if the 6430, 6420, or 6415 senses under voltage (UVP), over current (OCP), shortage (SHT), over power (OPP), over temperature (OTP), fan failure (FAN), or open circuit (OPEN), the red indicator LED of "PROTECTION" will be on, and the protection circuit enabled to shut down the output. Before restarting the output, the user must eliminate the condition that causes the 6430, 6420, or 6415 to react to "PROTECTION". For detailed description and suggestion on recovery please refer to "Troubleshooting" in 5.3.

4. Theories of Operation

4.1 General Information

The 6430, 6420 or 6415 AC power source consists of 14 main boards and other discrete components. Each of them has its own specific function that will be described in the subsections below.

4.2 Description of Overall System

Figure 4-1 (on the next page) shows the block diagram of overall system. Main power flows through the A/D, D/D, and D/A power stage through the converter. The A/D power stage is designated as **I** board, and generates DC from the line input. The DC voltage of the A/D output is applied to the input of the next power stage.

With an isolation transformer, **G** board converts the DC voltage to unregulated DC voltage which is accepted by a switch-mode inverter. Then, the inverter produces desired AC voltage output on **H** board which consists of the full bridge.

A board is identified as CPU. The 80C188 CPU is used to communicate with **BM** and **BS** boards for programming variable output voltage and frequency, to monitor or control the signals and interrupts, and to perform remote control through the GPIB or RS-232C interface on the optional board.

The seven-segment LEDs and keyboard are identified as **D** board and **K** board respectively. They become the interfaces between the user and the instrument. The fan is used to remove extra heat from the interior of the 6430, 6420 or 6415 AC source.

6430/6420/6415 Hardware Structure

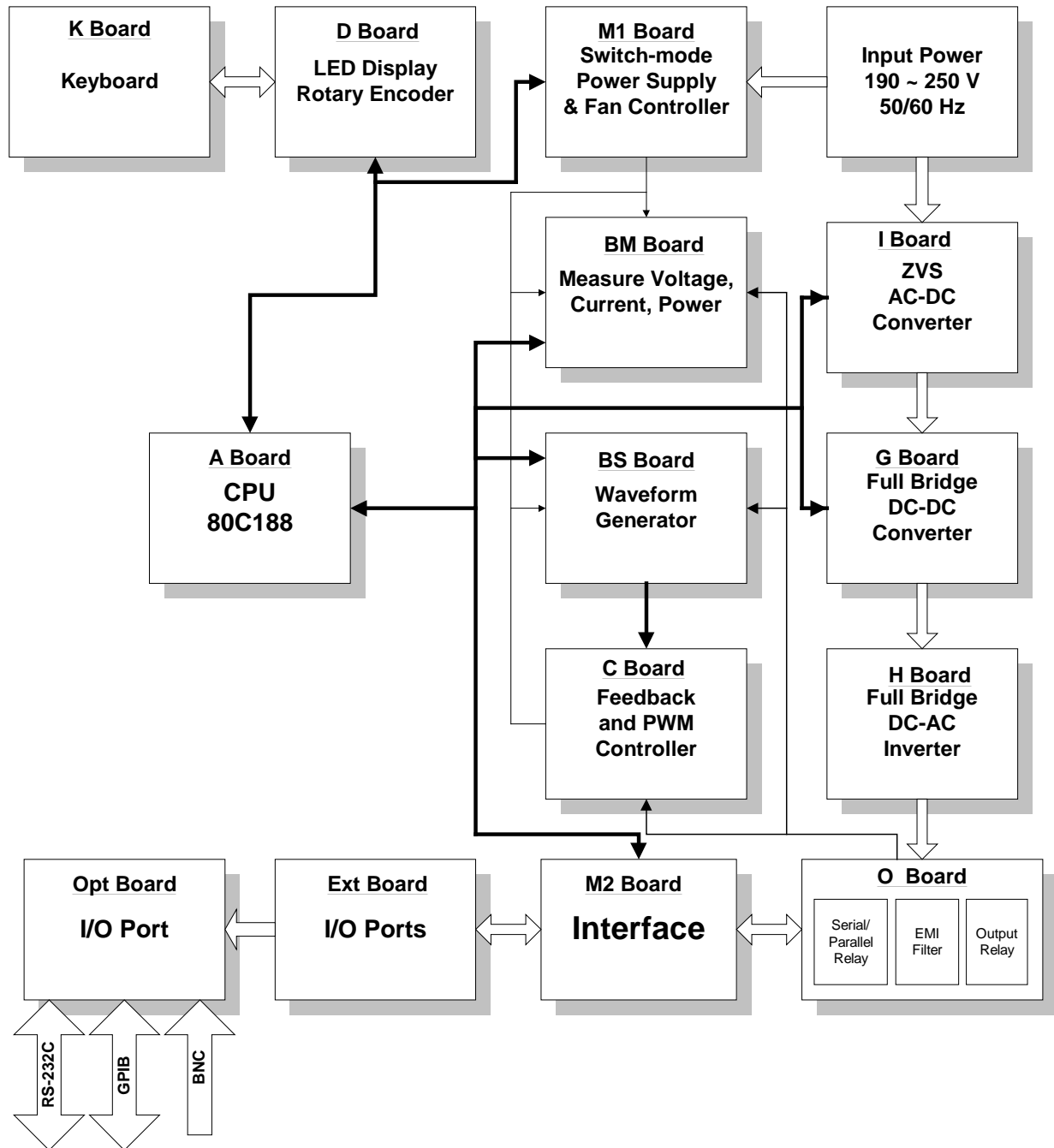

Figure 4-1 The Block Diagram of System

4.3 AC/DC Power Stage Converter

The switch -mode PWM converter is composed of a power factor controller and a boost circuit on *I* board. To avoid the switching losses, the user has to turn on the converter at zero

voltage. The auxiliary DC voltages identified as 15V, -15V, 12V, 5V, and -24V are generated on the **M1** board.

4.4 DC/DC Power Stage Converter

This assembly is identified as **G** board. It generates two isolated power outputs for the DC input voltage on **H** board. These two outputs of DC voltage and the input DC voltage are isolated from each other by the high frequency transformers.

4.5 DC/AC Inverter

This inverter includes **C** board, **H** board and **O** board. The advanced PWM technology is applied to this system in order to obtain more stability.

C board is the PWM controller. The maximum peak current is clamped to protect power MOSFET.

H board is made up of the full bridge of MOSFET power components. The PWM control signal from **C** board is applied to the full bridge to amplify the sine wave at the end of output. The low pass filter can reject the switching frequency component.

O board consists of the range relays and output relays. The range relays connect two sets of the secondary of output transformers together in parallel or series.

4.6 CPU

The CPU, **A** board, controls the circuit through 80C188 CPU. A microprocessor circuit receives commands from the GPIB, the RS-232C controller, or the keyboard on the front panel. It sends the digital signal to set the output parameters of the power source, and establishes the output sinusoidal waveform table. Data from the measurement circuits are received and reported to the seven-segment display and GPIB. The data of set parameters and one-key operation are stored in EEPROM.

4.7 Measurement

The measurement circuits on **BM** board monitor voltage, current, power, etc. Voltage and current from the output are scaled down first, and then convert the RMS value to DC voltage. The measurement of power is achieved by multiplying the scaled voltage and current with an integrated multiplier of output DC voltage. All outputs of DC voltage are converted to digital data, and sent to **A** board.

4.8 Sine Wave Generator

BS board is identified as the sine wave controller that generates sine waves, and acts as the

reference input of D/A stage. Over load protection, which limits the instantaneous output current, is implemented here too.

4.9 Keyboard and Display

The keyboard is designated as **K** board, which is connected to **D** board through a short flat ribbon cable. It contains 16 key switches and two LED indicators. The display is also connected to **D** board through a short flat ribbon cable. It is comprised of three 4-digit, 7-segment LEDs. The programming of V, F can be done by turning the rotary knob on the front panel too.

4.10 GPIB/RS-232C/External Reference

The remote control is done through the GPIB or RS-232C interface on the optional board, which is connected to **A** board through the DIN connector. External reference is used to control the amplitude of output AC voltage through DC reference.

5. Self-Test and Troubleshooting

5.1 General Information

This chapter will inform the user of the suggested self-test and troubleshooting procedures when his AC source does not function well. If a problem cannot be solved by the information given here, please consult the distributor who sold you the instrument.

5.2 Self-Test Routine

The 6430, 6420 or 6415 AC power source has a built-in test/adjustment program for the user to test or adjust the instrument. Do not adjust any component without prior approval. Please consult the distributor for the information of adjustment.

⚠ WARNING Disconnect any load from the output when you use the test/adjustment program. Any load from the instrument may cause test failure.

5.3 Troubleshooting

The following table (on the next page) lists the problems of operation and suggests the ways of solution.

Problem	Reason	Solution
Poor Voltage Accuracy	HIGH or LOW line of output voltage may be shorted to the case ground.	Isolate the output line from the case.
Poor measurement of V, I, P	Aging of components results in deviation of characteristics. Regular calibration or adjustment is required.	Refer to service manual for internal reference of voltage adjustment.
Over Temperature Protection (OTP)	Ambient temperature is too high.	Operate the unit between 0 and 40°C.
Over Load Protection (OLP)	The output is overloaded.	Remove the over load.
Short Circuit (SHT)	The output is shorted.	Remove the short.
Over Power protection (OPP)	The output power is over the specification.	Remove the over power or lower down the output voltage.
AC Source System cannot be controlled by GPIB	1. The address of the AC source is incorrect. 2. The GPIB cable is loose at the rear panel of the AC source.	1. Update address. 2. Check connection, and tighten the screws.
Distorted Output	1. The output voltage from the AC source is too low. 2. The rectified load is too large at high frequency.	1. Program higher output voltage. 2. Reduce the load or lower the output frequency.
Fan Inhibited Protection (FAN)	The fan or the holes of ventilation is blocked.	Remove the obstruction.
Under Voltage	The line input voltage of the AC	Measure input voltage, and

Protection (UVP)	source is too low.	raise it if it is under the specification.
Open Circuit Protection (OPEN)	The output voltage is not consistent with the set value.	Consult the distributor for assistance.

6. Remote Operation

6.1 General Information

The AC source can be remotely controlled through the GPIB or the RS-232C interface. It is recommended that the timeout should not be less than one second. For RS-232C interface, only the signals of TXD, RXD, RTS, and CTS can be used for data transfer through it. The signals of CD, DTR, and DSR are shorted in the AC source. Interconnection between the IBM PC/AT and the AC source is illustrated below.

IBM PC/AT	AC SOURCE	Pin Definition
PIN 1	1	CD*
2	2	RXD
3	3	TXD
4	4	DTR*
5	5	SG
6	6	DSR*
7	7	RTS
8	8	CTS
9	9	RI*

* These signals can be disconnected if not required.

6.2 The GPIB Capability of the AC Source

GPIB Capability	Description	Interface Functions
Talker/Listener	Commands and response messages can be sent and received over the GPIB. Status information can be read through a serial polling.	AH1, SH1, T6, L4
Service Request	The AC source will set the SRQ line true if there is a condition of enabled service request.	SR1
Remote/Local	The AC source powers up in local state. In local state, the front panel is operative, and the AC source may respond to the commands from GPIB. In remote state, all keys on the front panel except the local key are disabled. The pressing of local key returns the AC source to local state. Local key can be disabled through local lockout so that only the controller or the power switch can return the AC source to local mode.	RL1
Device Clear	The AC source responds to the Device Clear (DCL) and Selected Device Clear (SDC) interface commands. These cause the AC source to clear any activity that will prevent it from receiving and executing a new command. DCL and SDC do not change any programmed setting.	DCL,SDC

6.3 Introduction to Programming

All commands and response messages are transferred in the form of ASCII codes. The entire response messages should be read before a new command is sent, otherwise the remaining response messages will be lost, and a query-interrupted error will occur.

6.3.1 Conventions

- < > Items within the angle brackets are parameter abbreviations.
- | Items at both sides of | are separate, alternative parameters. For example, ON | OFF indicates that either "ON" or "OFF" can be used as a parameter.
- [] Items within the square brackets are optional. For example, OUTP[:STATe] means that :STATe may be omitted.

6.3.2 Numerical Data Formats

Formats :

The 6430/6420/6415 AC Sources accept numeric data of the following formats (see next page):

Symbol	Description	Example
NR1	Digits with no decimal point. The decimal point is assumed to be to the right of the least significant digit.	123, 0123
NR2	Digits with a decimal point.	12.3, .123
NR3	Digits with a decimal point and an exponent.	1.23E+2, 12.3E-1
NRf	Flexible decimal form that includes NR1, NR2, NR3	12, 12.3, 1.23E2
NRf+	Expanded decimal form that includes NRf, MINimum and MAXimum. MINimum and MAXimum are the minimum and maximum limit values for the parameters.	12, 12.3, 1.23E2 MIN, MAXimum

Suffixes :

Numeric data may be followed by an optional suffix such as a multiplier and/or a unit. If the suffix is omitted, default units are used.

The default units of Frequency, Voltage, and Current are Hz, Volt, and Ampere respectively. The valid suffixes (units and multipliers) are as follows:

Class	Preferred Suffix	Referenced Unit
Frequency	Hz	Hertz
Voltage	V	Volt
Current	A	Ampere

6.3.3 Boolean Data Format

The boolean parameter <Boolean> takes the form ON|OFF|<NRf>. Boolean parameter has a value of “0” or “1”, and it is unitless. Any input value of <NRf> is rounded to an integer, and the non-zero result is interpreted as “1”. The values of “ON” and “OFF” are also acceptable upon the input commands for increase of readability. “ON” represents “1” and “OFF” “0”. Queries will return “1” or “0”, not “ON” or “OFF”.

6.3.4 Character Data Format

The character strings returned by query command may take either of the following forms:

<CRD> Character Response Data: character string with maximum length of 12.
 <SRD> String Response Data: character string enclosed in double quotes.

6.3.5 Basic Definition

Command Tree Table:

The commands of AC source are based on a hierarchical structure, also known as a tree system. To obtain a particular command, the full path to it must be specified. This path is represented in the table by placing the highest node in the hierarchy in the far left position. The lower nodes in the hierarchy are indented in position to the right, below the parent node.

Program Headers:

The program headers are keywords that identify the command. They follow the syntax described in subsection 7.6 of IEEE 488.2. The AC source accepts both upper-case and lower-case characters without distinguishing the cases. The program headers consist of two distinct types, common command headers and instrument-controlled headers.

Common Command and Query Headers:

The syntax of common command and query program header is specified in IEEE 488.2. It is used together with the IEEE 488.2-defined common commands and queries. The commands with the leading "*" are common commands.

Instrument-Controlled Headers:

Instrument-controlled headers are used for all other instrument commands. Each instrument-controlled header has both a long and a short forms. The AC source accepts only the exact short and the exact long forms. Note that elsewhere in this chapter a special notation is employed to differentiate the short form header from the long form header of the same header. The long form of the header is shown in upper-case characters with the portion of short form whereas the rest of the header in lower-case characters.

Program Header Separator:

Data must be separated from program header by at least one space.

Program Message:

It represents a sequence of zero or more program message unit elements separated by program message unit separator elements.

Program Message Unit:

It represents a single command, programming data, or query.

Examples: VOLT?, OUTPut ON.

Program Message Unit Separator (':'):

It separates the program message unit elements from one another in a program message.
Example: VOLT 110 ; FREQ 120 <PMT>

Program Message Terminator (<PMT>):

A program message terminator terminates a program message. Three permitted terminators are:

- (1) <END>: end or identify(EOI).
- (2) <NL>: new line, which is a single ASCII-encoded byte 0A (10 decimal).
- (3) <NL><END>: new line with EOI.

 **CAUTION** : The response message is terminated by <NL> <END> for GPIB, <NL> for RS-232C.

6.4 Traversal of the Command Tree

Multiple program message unit elements may be sent in a program message. The first command is always referenced to the root node. Subsequent commands are referenced to the same tree level as the previous command in a program message.

Note that the common command and query headers do not affect the header path.

A column preceding a program message unit alters the header path to the root level.
For example:

- (1) VOLT:RANG 150;LIM 140 <PMT> will set the output voltage to 150V range and the maximum rms output voltage to 140V.
- (2) CURR:PEAK 8;VOLT 110 <PMT> will set the output peak current to 8A and generate a command error, because VOLTage is not a node at the current level.
- (3) CURR:PEAK 8;:VOLT 110 <PMT> will set the output peak current to 8A and the voltage to 110V.
- (4) VOLT:RANG 300;*ESE 32;LIM 250 <PMT> will set the output voltage to 300V range, the Standard Event Status Enable Register to 32, and the maximum rms output voltage to 250 Volt.

Optional nodes in the tree will not alter the header path.

For example:

- (1) FREQ 120;VOLT 110 <PMT> will set the frequency to 120Hz and voltage to 110 Volt. Note that FREQ 120 does not change the header path to FREQ:CW.
- (2) VOLT:LEV 110;RANG 150 <PMT> will set the rms output voltage to 110 Volt and the output voltage range to 150V range.

6.5 Execution Order

The AC source executes program messages according to the order received. Program message units are executed in the order of reception except coupled commands. The execution of coupled commands are deferred until program message terminator is received. A coupled command sets the parameters which are affected by the setting of other commands. Problems will arise, because the prior state of the AC source may affect the

response to the programming of a coupled parameter.

For example, assuming the current output voltage range is 150V, and a new state is desired with output voltage range of 300V as well as amplitude of 220V. If the commands

```
VOLTage 220<PMT>
VOLTage:RANGe 300<PMT>
```

are sent, a data out of range error will occur. Such an error can be avoided by reversing the order, or sending the commands in one program message. For the above case, the program message

```
VOLTage 220;VOLTage:RANGe 300<PMT>
```

can be sent without making a mistake.

The following commands are coupled: VOLTage, VOLTage:RANGe, VOLTage:RANGe:AUTO, VOLTage: LIMit, VOLT:EPRogram.

6.6 The Commands of the AC Source

6.6.1 Command Tree Table

MEASure|FETCh

[:SCALar]

:CURRent

:AC?

It returns the output AC rms current.

:CREStfactor?

It returns the output current crest factor.

:FREQuency?

It returns the output frequency.

:POWer

:AC

[:REAL?]

It returns the output real power.

:PFACtor?

It returns the output power factor.

:VOLTage

:AC?

It returns the output AC rms voltage.

OUTPut

[:STATe] <Boolean>

It enables/disables the output.

:PROTection

:CLEar

It causes the latched protection to be cleared.

[SOURce:]

CURRent

:LIMit

[:IMMediate] <NRf+>

It sets the output rms current limit.

FREQuency

[:CW|:FIXed] <NRf+>

It sets the output frequency.

VOLTage	
[:LEVel]	
[:IMMediate]	
[:AMPLitude] <NRf+>	It sets the AC rms output voltage amplitude.
:EPRogram	
[:STATe] <Boolean>	It enables/disables the external program mode.
:LIMit	
[:AMPLitude] <NRf+>	It sets the limit on output AC rms voltage amplitude.
:RANGe 150 300	It sets the output voltage range.
:AUTO <Boolean>	It enables/Disables AUTO output voltage range mode.
STATus	
PRESet	It presets the PTR, NTR and Enable Registers of Questionable and Operation status.
:OPERation	
[:EVENT]?	It returns the content of the Event Register.
:CONDition?	It returns the content of the Condition Register.
:ENABle <NRf>	It sets the Enable Register.
:QUEStionable	
[:EVENT]?	It returns the content of the Event Register.
:CONDition?	It returns the content of the Condition Register.
:ENABle <NRf>	It sets the Enable Register.
:NTRansition <NRf>	It sets the negative transition filter.
:PTRansition <NRf>	It sets the positive transition filter.
SYSTem	
:ERRor?	It returns the error message.
:LOCal	It goes to local mode (RS-232C only).
:REMote	It goes to remote mode (RS-232C only).
:RWLock	It goes to remote with lockout mode (RS-232C only).
*CLS	It clears status.
*ESE <NRf>	It sets the Standard Event Status Enable Register.
*ESR?	It returns the Standard Event Status Register.
*IDN?	It returns the device identification.
*OPC	It generates operation complete message when operation completed.
*OPC?	It returns "1" when operation completed.
*RST	It is reset.

*SRE <NRf>	It sets Service Request Enable Register.
*STB?	It returns Status Byte Register.
*TST?	It performs self-test then returns result.
*WAI	Wait-to-continue

6.6.2 Command Dictionary

MEASure:CURRent:AC?

FETCh:CURRent:AC?

Description: These queries return the output AC rms current. It is noted that there are two kinds of commands to get measurement data. MEASure commands make a new measurement and return measurement data. FETCh commands return measured data taken by previous MEASure command. Note that once a new measurement is made, all new measurement data (V, F, I, P, PF, CF) may be returned by FETCh commands.

Query Syntax: MEASure[:SCALar]:CURRent:AC?
FETCh[:SCALar]:CURRent:AC?

Parameters: None

Return Parameters: <NR2>

Query Example: MEAS:CURR:AC? It returns the output AC rms current.

MEASure:CURRent:CREStfactor?

FETCh:CURRent:CREStfactor?

Description: These queries return the output current crest factor.

Query Syntax: MEASure[:SCALar]:CURRent:CREStfactor?
FETCh[:SCALar]:CURRent:CREStfactor?

Parameters: None

Return Parameters: <NR2>

Query Example: MEAS:CURR:CRES? It returns the output current crest factor.

MEASure:FREQuency?

FETCh:FREQuency?

Description: These queries return the output frequency.

Query Syntax: MEASure[:SCALar]:FREQuency?
FETCh[:SCALar]:FREQuency?

Parameters: None

Return Parameters: <NR2>

Query Example: MEAS:FREQ? It returns the output frequency.

MEASure:POWer:AC?

FETCh:POWer:AC?

Description: These queries return the output real power.

Query Syntax: MEASure[:SCALar]:POWer:AC[:REAL]?
FETCh[:SCALar]:POWer:AC[:REAL]?

Parameters: None

Return Parameters: <NR2>

Query Example: MEAS:POW:AC? It returns the output real power.

MEASure:POWer:AC:PFACtor?

FETCh:POWer:AC:PFACtor?

Description: These queries return the output power factor.

Query Syntax: MEASure[:SCALar]:POWer:AC:PFACtor?
FETCh[:SCALar]:POWer:AC:PFACtor?

Parameters: None

Return Parameters: <NR2>

Query Example: MEAS:POW:AC:PFAC? It returns the output power factor.

MEASure:VOLTAge:AC?

FETCh:VOLTAge:AC?

Description: These queries return the output AC rms voltage.

Query Syntax: MEASure[:SCALar]:VOLTAge:AC?
FETCh[:SCALar]:VOLTAge:AC?

Parameters: None

Return Parameters: <NR2>

Query Example: MEAS:VOLT:AC? It returns the output AC rms voltage.

OUTPut

Description: This command enables or disables the AC source output.

Syntax: OUTPut[:STATe] <Boolean>

Parameters: 0 | 1 | OFF | ON

*RST Value: OFF

Example: OUTP ON enables output.

OUTP 0 disables output.

Query Syntax: OUTPut[:STATe]?

Return Parameters: 0 | 1

Query Example: OUTP? It returns the output enable condition.

OUTPut:PROTection:CLEAr

Description: This command clears the latch that disables the output when a short, over current, over power, over temperature, fan fail, or under voltage condition is detected. All conditions that cause the protection should be removed before the latch is cleared. Then, the output remains disabled until another OUTP ON command is received.

Syntax: OUTPut:PROTection:CLEAr

Parameters: None

Example: OUTP:PROT:CLE It clears the latched protection.

CURRent:

Description: This command sets the output limit current.

Syntax: [SOURce:]CURRent: LIMit[:IMMediate] <NRf+>

Parameters: 0 to 30

*RST Value: 30

Example: CURR:LIMit 15 It sets the output limit current to 15A.

CURR:LIMit MAX It sets the output limit current to maximum value.

Query Syntax: [SOURce:]CURRent: LIMit[:IMMediate]?

Return Parameters: <NR2>

Query Example: CURR:LIMit? It returns the set value of output limit current.

FREQuency

Description: This command sets the output frequency.

Syntax: [SOURce:]FREQuency[:CW|:FIXed] <NRf+>

Parameters: 45 to 500

*RST Value: 60 Hz

Example: `FREQ 120` It sets the output frequency to 120Hz.

`FREQ MAX` It sets the output frequency to 500Hz.

Query Syntax: [SOURce:]FREQuency[:CW|:FIXed]?

Return Parameters: <NR2>

Query Example: `FREQ?` It returns the set value of output frequency.

VOLTage

Description: This command sets the AC rms output voltage amplitude. The maximum value is dependent on voltage range and the setting of voltage limit.

Syntax: [SOURce:]VOLTage[:LEVel][:IMMediate][:AMPLitude] <NRf+>

Parameters: 0 to 300

*RST Value: 0

Example: `VOLT 110` It sets the AC rms output voltage to 110V.

Query Syntax: [SOURce:]VOLTage[:LEVel][:IMMediate][:AMPLitude]?

Return Parameters: <NR2>

Query Example: `VOLT?` It returns the set value of output voltage.

VOLTage:EPRogram

Description: This command enables or disables the external program mode. During external program mode, the AC rms output voltage is controlled by an external reference DC voltage.

Syntax: [SOURce:]VOLTage:EPRogram[:STATe] <Boolean>

Parameters: OFF | ON

*RST Value: OFF

Example: `VOLT:EPR ON` It enables external program mode.

Query Syntax: [SOURce:]VOLTage:EPRogram[:STATe]?

Return Parameters: OFF | ON

Query Example: `VOLT:EPR?` It returns the state of external program mode.

VOLTage:LIMit

Description: This command sets the maximum bounds on the AC rms output voltage value. Setting a larger output voltage value will cause the output to be clamped to the LIMit value.

Syntax: [SOURce:]VOLTage:LIMit[:AMPLitude] <NRf+>

Parameters: 0 to 300

*RST Value: 300

Example: `VOLT:LIM 130` It sets the AC rms output voltage limit to 130V.

Query Syntax: [SOURce:]VOLTage:LIMit[:AMPLitude]?

Return Parameters: <NR2>

Query Example: `VOLT:LIM?` It returns the set value of output voltage limit.

VOLTage:RANGe

Description: This command sets the output voltage range of the AC source. Two ranges are available: 150V and 300V range. When setting output voltage to 150V range, if the setting of output voltage is greater than 150V, it will be clamped to 150V. Setting an output voltage range will disable the AUTO range mode.

Syntax: [SOURce:]VOLTage:RANGe <NRf+>

Parameters: 150 | 300

*RST Value: 150

Example: VOLT:RANG 300 It sets the output voltage to 300V range.

Query Syntax: [SOURce:]VOLTage:RANGe?

Return Parameters: <NR1>

Query Example: VOLT:RANG? It returns the voltage output range.

VOLTage:RANGe:AUTO

Description: This command enables or disables the AUTO output voltage range mode. In AUTO mode, the output voltage must be set as greater than 150 volt, and it will be switched to 300V range, otherwise the 150V range is selected.

Syntax: [SOURce:]VOLTage:RANGe:AUTO <Boolean>

Parameters: 0 | 1 | OFF | ON

*RST Value: OFF

Example: VOLT:RANG:AUTO ON It enables the AUTO output voltage range mode.

Query Syntax: [SOURce:]VOLTage:RANGe:AUTO?

Return Parameters: 0 | 1

Query Example: VOLT:RANG:AUTO? It returns the condition of AUTO range mode.

STATus:PRESet

Description: This command sets the PTR, NTR and Enable Registers of Questionable and Operation status as follows: all defined bits of PTR Registers to 1, all bits of NTR and Enable Registers to 0.

Syntax: STATus:PRESet

Parameters: None

Example: STAT:PRES It presets the PTR, NTR and Enable Registers of Questionable status.

STATus:OPERation?

Description: This query returns the content of the Operation Event Register. The Operation Event Register is cleared when read or by the *CLS common command.

Query Syntax: STATus:OPERation[:EVENT]?

Parameters: None

Return Parameters: <NR1>

STATus:OPERation:CONDition?

Description: This query returns the content of Operation Condition Register. The Condition Register reflects the TRUE or FALSE state of Operation status.

Query Syntax: STATus:OPERation:CONDition?

Parameters: None

Return Parameters: <NR1>

STATus:OPERation:ENABLE

Description: This command sets the enable mask which allows true conditions in the Operation Event Register to be reported in the Operation Status (OPER) Summary-Message of the Status Byte Register.

Syntax: STATus:OPERation:ENABLE <NRf>

Parameters: 0 to 32767

Query Syntax: STATus:OPERation:ENABLE?

Return Parameters: <NR1>

Bit configuration of Questionable Status Register

Bit Position	8-15	7	6	5	4	3	2	1	0
Condition	---	FAN	OPP	OCP	SHT	OTP	UVP	OPEN	PFO
Bit Weight		128	64	32	16	8	4	2	1

Remarks: FAN : Fan failure
 OTP : Over temperature protection
 UVP : Under voltage protection
 OPP : Over power protection
 OCP : Over current protection
 SHT : Short circuit protection
 PFO : Power failure protection
 OPEN : Open circuit protection

STATus:QUEStionable?

Description: This query returns the content of the Questionable Event Register. The Questionable Event Register latches events that are passed by Questionable PTR and/or NTR filter. It is cleared when read or by the *CLS common command.

Query Syntax: STATus:QUEStionable[:EVENT]?

Parameters: None

Return Parameters: <NR1>

Query Example: STAT:QUES? It returns and clears the Questionable Event Register.

STATus:QUEStionable:CONDition?

Description: This query returns the content of the Questionable Condition Register. The Questionable Condition Register reflects the TRUE or FALSE state of Questionable status.

Query Syntax: STATus:QUEStionable:CONDition?

Parameters: None

Return Parameters: <NR1>

Query Example: STAT:QUES:COND? It returns the Questionable Condition Register.

STATus:QUEStionable:ENABle

Description: This command sets the enable mask which allows true conditions in the Questionable Event Register to be reported in the Questionable Status (QUES) Summary-Message of the Status Byte Register.

Syntax: STATus:QUEStionable:ENABle <NRf>

Parameters: 0 to 32767

Example: STAT:QUES:ENAB 8 It enables OTP event to be reported in the Status Byte Register.

Query Syntax: STATus:QUEStionable:ENABle?

Return Parameters: <NR1>

Query Example: STAT:QUES:ENAB? It returns the content of Questionable Enable Register.

STATus:QUEStionable:NTRansition**STATus:QUEStionable:PTRansition**

Description: These commands set the content of the Questionable NTR (negative transition 1-to-0) and PTR (positive transition 0-to-1) Registers. These Registers determine which type of transition in the Condition Register may set the corresponding bit in the Questionable Event Register.

Syntax: STATus:QUEStionable:NTRansition <NRf>

STATus:QUEStionable:PTRansition <NRf>

Parameters: 0 to 32767

Example: STAT:QUES:NTR 8 It enables OTP event bit to be set as 1-to-0.
STAT:QUES:PTR 2 It enables SHT event bit to be set as 0-to-1.

Query Syntax: STATus:QUEStionable:NTRansition?
STATus:QUEStionable:PTRansition?

Return Parameters: <NR1>

Query Example: STAT:QUES:PTR? It returns the content of Questionable PTR Register.

SYSTEM:ERRor?

Description: This query returns the next error number followed by its corresponding error description string from the error queue. As errors are detected, they are placed in the queue. The queue is first in, first out. If the queue overflows, the last error in the queue is replaced with the error **-350, "Queue overflow"**. Reading an error from the head of the queue removes that error from the queue. When all errors have been read, further error queries will return **0, "No error"**.

Query Syntax: SYSTem:ERRor?

Parameters: None

Return Parameters: <NR1>, <SRD>

Query Example: SYSR:ERR? It returns the next error number and description.

SYSTEM:LOCal

Description: This command sets the AC source to local state, which enables the control of front panel. It can only be used with the RS-232C interface.

Syntax: SYSTem:LOCal

Parameters: None

Example: SYST:LOC It sets the AC source to local state.

SYSTEM:REMote

Description: This command sets the ac source to remote state, which disables the control of front panel except the local key. Pressing the local key while in the remote state returns the AC source to the local state. It can only be used with the RS-232C interface.

Syntax: SYSTem:REMote

Parameters: None

Example: SYST:REM It sets the AC source to remote state.

SYSTEM:RWLock

Description: This command sets the AC source to remote-lockout state, which disables the control of front panel, including the local key. It can only be used with the RS-232C interface.

Syntax: SYSTem:RWLock

Parameters: None

Example: SYST:RWL It sets the AC source to remote-lockout state.

***CLS, Clear Status Command**

Description: This command clears all Event Registers summarized in the Status Byte Register (Standard Event Status Register, Questionable Event Register), and clears the error queue. If the *CLS command immediately follows a program message terminator, the output queue and the MAV Summary-Message are also cleared.

Syntax: *CLS

Parameters: None

***OPC?, Operation Complete Query**

Description: This query returns an ASCII "1" when all pending operations are completed.

Query Syntax: *OPC?

Parameters: None

Return Parameters: 1

***RST, Reset Command**

Description: This command resets the AC source to the following states:

OUTP OFF
 CURR:LIMit MAX
 FREQ 60
 VOLT 0
 VOLT:EPR OFF
 VOLT:LIM 300
 VOLT:RANG 150
 VOLT:RANG:AUTO OFF

Syntax: *RST

Parameters: None

Bit configuration of Status Byte Register

Bit position	7	6	5	4	3	2	1	0
Condition	OPER	MSS	ESB	MAV	QUES	---	---	---
		RQS						
Bit Weight	128	64	32	16	8			

Remarks: RQS : Request service MSS : Master Summary Status
 ESB : Event Status Bit MAV : Message Available
 QUES : Questionable status OPER : Operation status

***SRE, Service Request Enable Command**

Description: This command sets the content of the Service Request Enable Register, which determines which events of the Status Byte Register are allowed to set the Master Summary Status (MSS) and the Request Service (RQS) message true. If a bit is 1 in Service Request Enable Register and its associated event bit in Status Byte Register transitions true, bit 6 of Status Byte Register is then set true.

Syntax: *SRE <NRf>

Parameters: 0 to 255

Example: *SRE 16 It enables the MAV bit event to set MSS and RQS bit.

Query Syntax: *SRE?

Return Parameters: <NR1>

Query Example: *SRE? It returns the content of Service Request Enable Register.

***STB?, Read Status Byte Query**

Description: This query returns the Status Byte Register. The Status Byte Register can be read with either a serial poll or the *STB? Common query. If it is read with a serial poll, the RQS bit is sent for the position of bit 6 and then cleared. If it is read with *STB?, MSS bit is sent but not cleared.

Query Syntax: *STB?

Parameters: None

Return Parameters: <NR1>

Query Example: *STB? It returns the content of Status Byte Register.

***TST?, Self-Test Query**

Description: This query causes an internal self-test and reports the result. If the AC source completes the self-test without any detected errors, it returns a 0, otherwise it returns a 1. Note that during the self-test caused by *TST, the output voltage will reach 300V. Please disconnect any output load.

Query Syntax: *TST?

Parameters: None

Return Parameters: 0 | 1

Query Example: *TST? It causes a self-test and reports the result.

***WAI, Wait-to-continue**

Description: This command prevents the AC source from executing any further command until all pending operations are completed.

Syntax: *WAI

Parameters: None

6.7 Status Reporting

The AC source follows the status data structure and mechanism described in the IEEE 488.2 Standard Digital Interface for Programmable Instrumentation. Note that undefined bits of all status registers are zero when they are read.

6.7.1 Questionable Status

The Questionable Status Register records signals and shows abnormal operation of AC source.

- (1) Condition Register: It reflects the present state of TRUE (1) or FALSE (0) in its condition bits. It is a register for reading only.
- (2) Negative Transition (NTR) Filter: It allows the event bit to be set TRUE when the associated condition changes from TRUE to FALSE. It is cleared at power-on or by the STATus:PRESet command.
- (3) Positive Transition (PTR) Filter: It allows the event bit to be set TRUE when the associated condition changes from FALSE to TURE. All defined bits are set at power-on or by the STATus:PRESet command.
- (4) Event Register: It catches conditions that are passed by PTR and/or NTR filters. It is cleared at power-on, or when it is read, or when the *CLS common command is received.
- (5) Enable Register: It selects which event bits in the Event Register will cause the QUEStionable Status summary-message of the Status Byte Register to be TRUE when it is set. It is cleared at power-on or by the STATus:PRESet command.

6.7.2 Standard Event Status

The Standard Event Status Register latches the following conditions:

- (1) Bit 7: Power On (PON). This event bit indicates that an off-to-on transition has occurred in the device's power supply.
- (2) Bit 5: Command Error (CME). A syntax or semantic error has been detected.

- (3) Bit 4: Execution Error (EXE). The data of a program are outside the legal range, or inconsistent with the capabilities of the AC source, or the command cannot be executed due to some condition of operation.
- (4) Bit 3: Device-Specific Error (DDE). This event bit indicates that an error has occurred, which is neither a Command Error, nor a Query Error, nor an Execution Error.
- (5) Bit 2: Query Error (QYE). An attempt is made to read data from the output queue when no output is present or pending, or the data in the output queue have been lost.
- (6) Bit 0: Operation Complete (OPC). This event bit is generated in response to the *OPC command. It indicates that the AC source has completed all pending operations.

The Standard Event Status Register is cleared at power-on, or when it is read, or by the *CLS common command. The Standard Event Status Enable Register selects which event bits in the Standard Event Status Register may cause the ESB summary-message of the Status Byte Register to be TRUE when it is set. It is cleared at power-on.

6.7.3 Status Byte Register

The Status Byte Register summarizes summary-messages from other status. The definitions of its bits are as follows:

- (1) Bit 3: Questionable Status (QUES) Summary-Message. Its state indicates if one or more of the enabled events defined in Questionable Status have occurred since the last reading or clearing of the Questionable Event Register.
- (2) Bit 4: Message Available (MAV) Queue Summary-Message. Its state indicates whether or no the Output Queue is empty. Whenever the AC source is ready to accept a request through the controller to output data bytes, the MVA summary-message is TRUE.
- (3) Bit 5: Event Status Bit (ESB) Summary-Message. Its state indicates if one or more of the enabled events defined in Standard Event Status have occurred since the last reading or clearing of the Standard Event Status Register.
- (4) Bit 6: Master Summary Status (MSS) Message or Request Service (RQS) Message. The MSS message indicates that at least one summary-message enabled by the Service Request Enable Register occurs. The RQS message functions the same way as MSS message except that it is cleared after serial poll.
- (5) Bit 7: Operation Status (OPER) Summary-Message. The Operation Status Registers are not used in the AC source.

The Status Byte Register can be read with either a serial poll or the *STB? common query. If it is read with a serial poll, the RQS message is sent for the position of bit 6 and then cleared. If it is read with the *STB? common query, the MSS message is sent but not changed. The *CLS common command will cause all Status Data Structures (that is, their Event Registers and Error Queue) to be cleared so that the corresponding summary messages are cleared. The Output Queue and its MAV summary message are an exception and unaffected by *CLS.

The Service Request Enable Register selects which summary-messages in the Status Byte Register may cause the MSS and RQS messages to be TRUE. The undefined bits and bit 6 of the Service Request Enable Register are always zero. When the RQS message is set TRUE, the AC source will send an SRQ message to request service asynchronously from the controller in charge of the GPIB interface. The Service Request Enable Register is cleared at power-on.

6.8 Error Messages

As errors are detected, they are placed in a queue of first in first out. The `SYSTEM:ERRor?` query can be used to read back the errors in the queue. If the queue overflows, the last error in the queue will be discarded and replaced with error **-350, "Queue overflow"**. When all errors have been read, further error queries will return **0, "No error"**.

Error No.	Description of the Error [description/explanation/examples]
0	No error
-100	Command error [generic]
-101	Invalid character
-103	Invalid separator
-104	Data type error
-108	Parameter not allowed [more parameters are received than expected]
-109	Missing parameter [less parameters are received than required]
-110	Command header error
-111	Header separator error
-112	Program mnemonic too long [more than 12 characters]
-113	Undefined header [the header is syntactically correct, but undefined]
-120	Numeric data error
-123	Exponent too large [the exponent magnitude is larger than 32000]
-124	Too many digits [more than 255 digits but excluding leading zeros]
-128	Numeric data not allowed [the received numeric data are not accepted for the header]
-130	Suffix error
-138	Suffix not allowed
-141	Invalid character data
-144	Character data too long [more than 12 characters]
-148	Character data not allowed
-221	Settings conflict [e.g., enable external program mode while the output voltage range is AUTO]
-222	Data out of range [e.g., set voltage to 200 Volts while the output voltage range is 150V]
-230	Data corrupt or stale
-350	Queue overflow [more than 16 errors]
-410	Query INTERRUPTED [a new program message was received before a response is completely sent]
-420	Query UNTERMINATED [addressed to talk but an incomplete program message was received]
-430	Query DEADLOCKED [output buffer overflows because of too many queries]
-440	Query UNTERMINATED after an indefinite response [a query was received in the same program message after an indefinite response]
11	Command used for RS-232C interface only.

Appendix A TTL I/O Pin Assignment

9 pins D type female connector:

Pin No.	Signal	Description	Pin No.	Signal	Description
1	$\overline{\text{TRANS}}$	Transient	6	GND	
2	AC ON	Output enabled	7	GND	
3	$\overline{\text{TRIG}}$	Trigger	8	GND	
4	$\overline{\text{INH}}$	Only for 6460, 6490, 6560 and 6590	9	GND	
5	-----				



CHROMA ATE INC.

致茂電子股份有限公司

66 Huaya 1st Road,

Guishan, Taoyuan 33383, Taiwan

台灣桃園市 33383 龜山區

華亞一路 66 號

T +886-3-327-9999

F +886-3-327-8898

Mail: info@chromaate.com

<http://www.chromaate.com>