

USER'S HANDBOOK

1271

selfcal digital multimeter



USER'S HANDBOOK

for

THE DATRON SELF CAL 1271 DIGITAL MULTIMETER

(for maintenance procedures
refer to the Calibration and Servicing Handbook)

850251

Issue 3 (April 1992)

For any assistance contact your nearest Datron Sales and Service center.
Addresses can be found at the back of this handbook.

Due to our policy of continuously updating our products, this handbook may contain minor differences in specification, components and circuit design to the actual instrument actually supplied. Amendment sheets precisely matched to your instrument serial number are available on request.

© 1992 Datron Instruments



**DANGER
HIGH VOLTAGE**



**THIS INSTRUMENT IS CAPABLE
OF DELIVERING
A LETHAL ELECTRIC SHOCK !
when connected to a high voltage source**

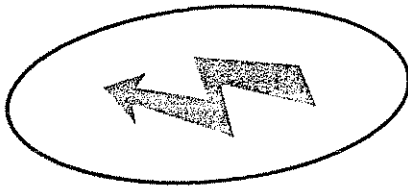

FRONT or REAR terminals
carry the Full Input Voltage
THIS CAN KILL !

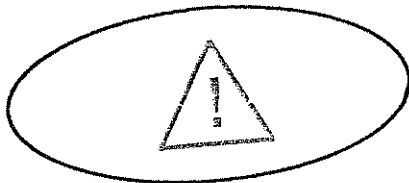

Guard terminal is sensitive
to over-voltage
It can damage
your instrument !

Unless you are sure that it is safe to do so,
DO NOT TOUCH
the I+ I- Hi or Lo leads and terminals

DANGER

PART 1

Introduction to the 1271

- Section 1 Introduction and General Description**
- Section 2 Installation and Operating Controls**
- Section 3 Basic Measurements**

SECTION 1 INTRODUCTION AND GENERAL DESCRIPTION

Standard and Optional Facilities

| | |
|--------------------------------|-----|
| Basic Configuration | 1-1 |
| Options | 1-1 |
| 'Hard' and 'Soft' Keys - Menus | 1-2 |
| Calibration | 1-3 |
| Message Readout | 1-4 |
| Processor | 1-4 |
| Computing | 1-4 |
| Self Test | 1-4 |
| System Use | 1-4 |
| Accessories | 1-5 |
| Additional Documentation | 1-5 |

Principles of Operation

| | |
|------------------------------|------|
| Precision DMM Design | 1-7 |
| Basics | 1-7 |
| Analog to Digital Converter | 1-8 |
| A-D Master Reference | 1-10 |
| DC Amplifier | 1-11 |
| AC Voltage - Options 10 & 12 | 1-12 |
| Resistance - Option 20 | 1-14 |
| Current - Option 30 | 1-14 |

SECTION 1

Introduction and General Description

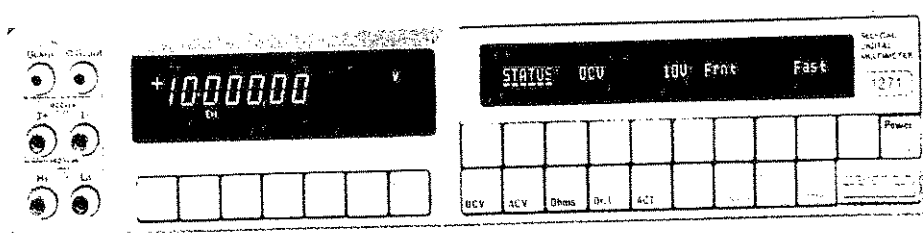

Designed with Standards and Calibration laboratories in mind, the 1271 provides extremely high performance in electrical measurement, combined with ease of use.

Standard and Optional Measurement Facilities

Basic Configuration

When purchased without options, the 1271 is an enhanced high quality DC Voltmeter. The basic configuration offers the following measurement capabilities:

- Selectable 5¹/₂ to full 8¹/₂ digits resolution at high read rates.
- DC Voltage in five ranges from 10nV to 1100V.
- External trigger.
- Flexible and easy to use Menu Control.
- Extensive Math, Limit testing, Specification and Max/Min computations.
- Selfcal internal calibration.
- Autocal external calibration.
- Fully IEEE-488.2 programmable.

Options

To extend its functional range beyond DC Voltage measurement, the instrument can be expanded by adding purchasable options, providing further measurement capability:

- 10 True RMS AC Voltage, from 100nV to 1100V, DC and 10Hz to 1MHz, optimized for high speed.
- 12 True RMS AC Voltage, from 100nV to 1100V, DC & 1Hz to 1MHz, optimized for high accuracy.
- 20 2-wire and 4-wire Resistance from 1 $\mu\Omega$ to 2G Ω . True Ω and Low Current Ω modes.
- 30 DC and AC Current option.
(DC Current requires Option 20).
(AC Current requires Options 10 or 12 and 20).
- 40 Comprehensive Ratio providing two identical rear input channels, A and B.
- 70 Analog output.
- 90 Rack mounting.

'Hard' and 'Soft' Keys - Menus

The use of hard keys (labels printed on the keys themselves) and soft keys (labels appear on the separate menu display) allows programming of the instrument into a wide range of configurations. Pressing the hard key of one of the main functions (DCV, ACV, Ohms, DCI or ACI) alters the instrument circuitry to the selected function, at the same time displaying its own menu. Each soft key, marked with an arrowhead (^), is labelled by the legend above it on the display. Whenever a main function key is pressed, the soft keys in its menu select only its ranges or autorange.

Once a main function is active, the Status hard key allows a check of configured parameters. Or alternatively, the Config hard key can be used to alter the configuration. The Monitor key permits access to such information as: the uncertainties associated with the active measurement; signal frequency of an AC input signal being measured; and whether set limits have been exceeded.

The menus are arranged in tree structures, the ultimate aim being to lead through their branches to an end node, at which the physical circuitry of the instrument can be changed to suit the required parameters.

When the instrument power is switched on, all functions are forced into a safety default state. Once a function is configured to a required state it remains in that state, regardless of subsequent configurations in other functions, until either the state is changed or the instrument power is switched off.

As an easy introduction to the main function keys and their associated menus, users can follow a guided tour through the tree structures, sequenced in Part 1, Section 3. The full range of facilities, together with access information, is detailed in Part 2, Section 4; and remote control information is given, for the IEEE 488 interface, in Section 5.

Calibration

Autocal

The 1271 is an 'Autocal' instrument, providing full external calibration of all ranges and functions from the front panel; thus making the removal of covers unnecessary.

Periodically, the DMM is electronically calibrated against traceable external standards, where any differences in the DMM's readings compared to the value of the external calibration sources can be used to derive calibration constants, which are stored by the instrument in non-volatile memory. These external calibration corrections later serve to correct all readings taken by the DMM.

Selfcal

The 1271 is also a 'Selfcal' instrument. Selfcal is a totally automatic internal calibration. Once accessed, a single keystroke initiates the process. The calibration uses the accuracy of a very stable 'Selfcal Module' which provides calibration sources, so that the errors in the measurement circuits can be determined. The microprocessor then automatically corrects for these errors.

The Selfcal Process

After the external calibration of the DMM, the performance of the internal calibrator can also be calibrated. This is done by comparing the readings taken by the DMM on any particular range against external standards, with those made using its internal Selfcal sources.

These Selfcal characterization factors are stored in the DMM's non-volatile memory alongside the normal external calibration corrections.

At a later date, when the DMM's user decides to self-calibrate the 1271, another set of internal measurements is made but using only the internal calibrator. This is performed using the identical configurations and sequences that derived the characterizations, to avoid any differences due to settling and thermal effects.

The new set of readings is then compared against the corresponding characterized values, and any differences between the two are defined as errors to be compensated by the microprocessor in all subsequent measurements.

In effect, a third set of calibration constants - the Selfcal corrections - are stored alongside the original external calibration constants and the Selfcal characterization factors. The performance of the instrument immediately after Selfcal then depends only on the stability of the internal calibrator and the noise which was present when making the internal measurements.

Calibration Security

A key-operated switch on the rear panel prevents accidental or unauthorized use of Autocal. Optionally, Selfcal can be protected by the switch and/or the passnumber.

Calibration Routines

The Selfcal and Routine Autocal procedures are described in Part 3, Section 8 of this handbook, and also in Part 1, Section 1 of the Calibration and Servicing Handbook.

Section 1 - Introduction and General Description

Message Readout

Generally, the selections offered in the menus reflect the availability of facilities, incompatible combinations being excluded. Nevertheless, the menu display doubles as a message screen, giving a clear readout of information to the user such as unsuitable attempts at configuration, test failures and some other conditions which would need to be reported to a Datron service center.

Processor

The instrument is internally controlled by a 68000 series microprocessor. It ultimately translates all information from the front panel keys, according to its program in firmware, into control signals which determine the instrument's operation.

Computing

Measurements can be compared with manually-input data (or the most-recent measurement). Some of the keys under the Menu display double as a keyboard for setting:

- measurement limits
 - the bus address
 - math constants
 - a passnumber
 - calibration uncertainties
- etc.

Full details of these facilities are given in Part 2, Section 4.

Self Test

The Test key displays a menu which provides access to a comprehensive series of self-tests. Among these are:

- A Full selftest, which includes a check of accuracy on all functions and ranges.
- A less exhaustive Fast selftest, with wider accuracy tolerances and reduced resolution so that the speed of testing can be increased.
- A test of the front panel keys.
- A test of the displays.

Details of these selftests can be found in Part 2, Section 4.

System Use

The 1271 is designed as standard to form part of a system, conforming to IEEE 488.2 Standard Digital Interface. The Device Documentation Requirements of this standard are fulfilled by the information given in Part 2, Section 5 (summarized in Section 5 Appendix A).

Accessories

The instrument is supplied with the following accessories:

| Description | Part Number |
|-----------------------------------|--------------------|
| Power Cable | 920012 |
| Set of 2 Calibration Keys | 700117 |
| Power Fuse (230V) 630mA | 920203 |
| Power Fuse (115V) 1.25A | 920204 |
| Current Fuse 1.6A | 920071 |
| Hex Key 1.5mm AF (Handle removal) | 630284 |
| 2 x 50-way 'Amp' socket shells | 605177 |
| 16 x socket bucket pins | 605178 |
| 2 x 50-way backshells | 606026 |
| 'Amp' insertion/extraction tool | 606030 |
| 15-way 'D' plug | 604062 |
| 15-way 'D' backshell | 606031 |
| User's Handbook | 850251 |

In addition, the following accessories are available for use with the 1271 instrument:

| Description | Part Number |
|---|--------------------|
| Rack Mounting Kit (Option 90) | 440153 |
| 1501 De Luxe Lead Kit | 440070 |
| Calibration and Servicing Handbook (2 Volumes): | |
| Volume 1 | 850252 |
| Volume 2 | 850253 |

Additional Documentation

The Calibration and Servicing Handbook contains information required to adjust and service the 1271, in two volumes:

Volume 1: full descriptions of the circuits, diagnostic data and calibration procedures.

Volume 2: parts lists and circuit diagrams.

Principles of Operation

Figure 1.1 shows how the instrument achieves its basic measurement functions.

Precision DMM Design

The 1271 Digital Multimeter is designed for calibration and standards laboratory applications, and so takes full advantage of the inherent qualities of critical accuracy-defining components to

achieve its high performance. It also employs a method of internal calibration which is designed to enhance performances across the entire range of its functions.

Basics

DC Voltage measurements are made by passing the input signal to a DC amplifier, which amplifies or attenuates the signal to a level compatible with the input requirements of the Analog to Digital converter (A-D). The reading from the A-D is then transferred to the instrument's microprocessor for calibration and display.

AC voltages are conditioned by the AC preamp, full wave precision-rectified and passed through an electronic RMS converter, producing a DC level which represents the RMS value of the applied signal. This DC level is then digitized by the A-D converter.

Resistance is measured by passing a constant current through the resistor under test and measuring the DC voltage that develops across it, using the DC Voltage circuits of the instrument.

DC or AC currents pass through precision internal shunts; the voltages that develop are measured using the DCV or ACV sections of the instrument.

Section 1 - Introduction and General Description

Analog to Digital Converter

Introduction

The instrument's A-D converter takes the form of a highly linear, low noise, fast and flexible multislope integrator.

Timing, counting and control are executed by a

custom 'Application-Specific Integrated Circuit' (ASIC), resulting in a design which offers both variable integration times and user-selectable resolutions.

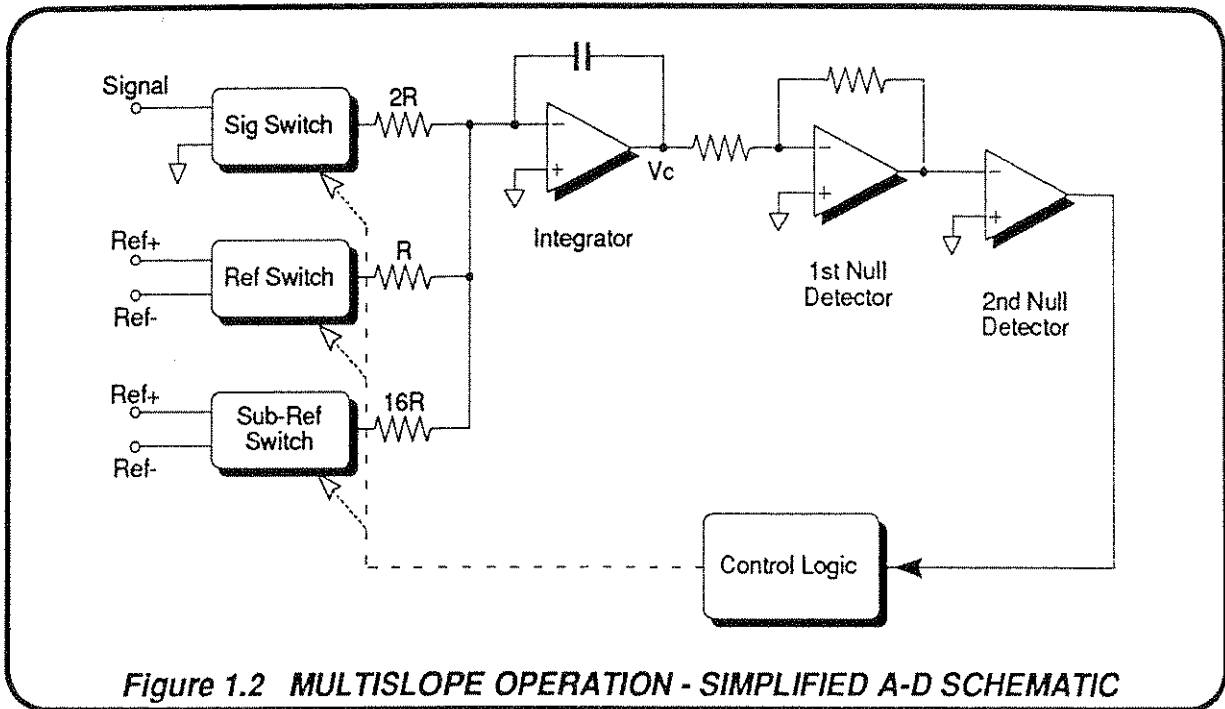

Figure 1.2 MULTISLOPE OPERATION - SIMPLIFIED A-D SCHEMATIC

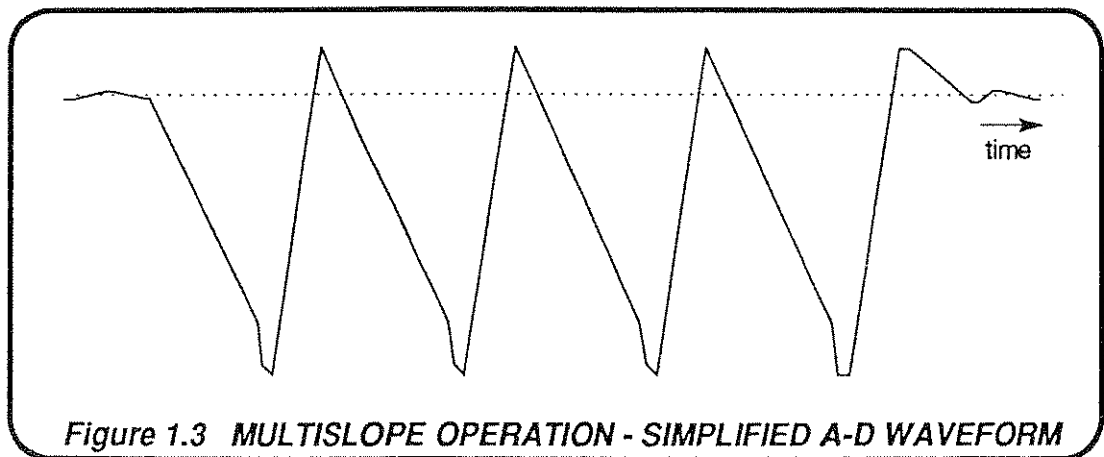

Figure 1.3 MULTISLOPE OPERATION - SIMPLIFIED A-D WAVEFORM

Multislope Operation (Fig. 1.2)

This employs multiple cycling of the voltage on the integrator capacitor, greatly reducing linearity errors caused by dielectric absorption. The design ensures that any reference switching errors are reduced to a single constant value, which is then subtracted from the reading by the instrument's microprocessor. As a further benefit this design obtains large reductions in conversion time, by enabling both the signal and the reference to be applied to the integrator simultaneously. A digital autozero system is employed.

The timing and counting considerations with this design of A-D are quite complex. Programmable delay timers, a ramp timer and a counter for the number of completed ramps exercise great control flexibility over its performance. These timers and counters are integrated into a custom ASIC which has a 32 bit control register, programmed by the instrument's microprocessor via a special serial interface. The same serial loop is used to transmit the reading from the ASIC to the processor for calibration and display.

A simplified A-D waveform is given in Figure 1.3.

Features

The result is a highly flexible and compact A-D which has the following features:

- Selectable resolutions and speeds; capabilities range from more than 1000 readings per second at 5.5 digits resolution, to one full-accuracy 8.5-digit reading every 10 seconds.
- Excellent linearity of 0.25ppm of full scale.
- 100% overrange - maximum discrimination of 1 part in 200 million.

A-D Master Reference

Reference Module

The reference for the A-D conversion is derived from a specially conditioned zener reference module. It contains the reference device and its associated buffer circuits to ensure constant temperature across the module. The module is stable to within ± 4 ppm per root-year, with a temperature coefficient of better than 0.15ppm/ $^{\circ}$ C. This is held over a very wide temperature span of 0° C to 50° C, and these references exhibit negligible temperature shock hysteresis.

Module History

Extensive evaluation of the reference modules has resulted in a burn-in process which equates to an ageing of 1 year, reducing both infant mortalities and hysteresis effects. Following this process, all reference modules are checked over a temperature span of 0° C to 70° C for temperature performance, and then monitored for long term drift over a period of three months minimum.

DC Amplifier

Basic Design

The required input characteristics are achieved by using a differential FET input to give low input current and high frequency response characteristics, coupled with a chopping amplifier to reduce offset and low-frequency noise.

Ranges

Extremely stable resistance units configure the DC amplifier gain to define the DC Voltage ranges. To ensure that no spurious leakage currents cause linearity, temperature-coefficient or drift problems in the attenuator chains; the pcb tracks connecting the resistor units to the circuit are carefully guarded.

Effects of Bootstrap

To give a high input impedance, the DC amplifier also drives a bootstrap buffer. This forces the potential of guarding tracks (that surround the Hi track) to follow the input voltage. Also, each in-guard supply used to power the DC amplifier is made to track the input signal level by reference to bootstrap. The DC amplifier thus sees no change in input signal relative to its supplies, so achieving a very high common mode rejection, eliminating any potential common mode non-linearities.

Protection

The instrument can measure up to 1000V and can withstand a continuous overload of 1000V on all DCV ranges. Back to back zener diodes and a series resistor provide protection for the DC amplifier. Further dynamic protection is provided in the form of larger series resistors, which switch in when the signal exceeds a certain threshold.

AC Voltage - Options 10 & 12

AC Preamp

The inverting preamp provides good flatness from DC to 1MHz, with minimum offset voltage at its output to ensure good DC-coupled performance. The design uses several gain elements operating in conjunction, some adding, some multiplying.

The closed loop gain at low frequencies is set by input and feedback resistors. These resistors are shunted by compensating capacitors which determine the closed loop gain at high frequencies, swamping the stray capacitance around the preamp. The feedback capacitance on each range is effectively trimmed at calibration using a ladder network digital-to-analog converter driven from the microprocessor, to control the channel

resistance of FETs in the gain defining network. Extensive bootstrapping of components in the preamp feedback area also greatly reduces the effects of stray capacitance on the measurements.

Electronic RMS

The principles behind the RMS conversion technique are shown in Figure 1.4.

With the instrument set to its 'normal' mode, the signal from the preamp is full-wave rectified by the Halfwave Rectifier and its bypass, appearing as unipolar current pulses at the input to the squaring log amp (V_{in}).

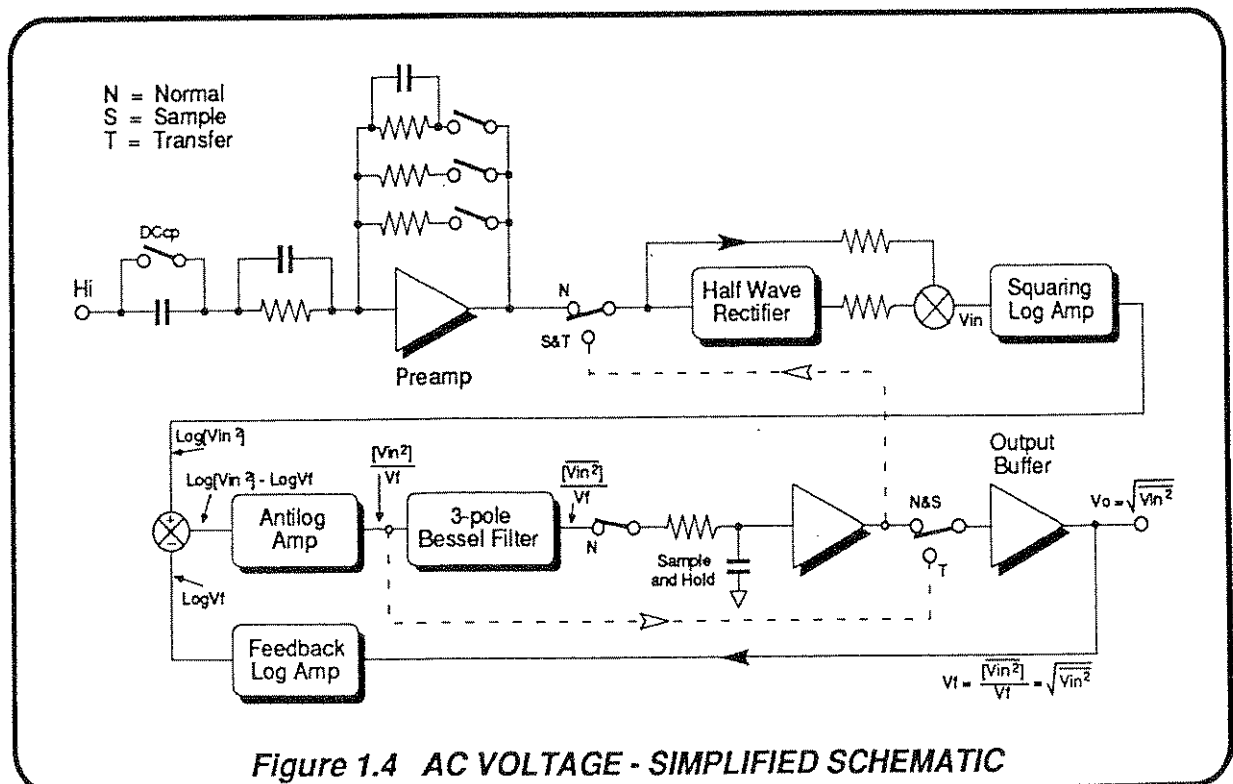

The Log Amp squares instantaneous values of its input by converting them into logarithmic values, then multiplying by two. Its instantaneous log output currents have a DC current proportional to $\log V_f$ subtracted from them. The result is a current (proportional to $\log[V_{in}^2] - \log V_f$) which is fed to an 'exponential' stage.

This current is thus 'antilogged', then converted to a voltage and smoothed by a 3-pole Bessel filter, producing a DC voltage - the mean of V_{in}^2 divided by V_f (V_f is already DC and equal to its mean).

Root-Mean-Square Value

The Bessel filter is chosen for its optimum settling time, and offers user-selectable configurations to permit operation down to 10 Hz (Option 10).

Because the DC output signal $V_f = [\overline{V_{in}^2}] / V_f$, and is fed back into the RMS converter, this means that the square of the output voltage $V_f^2 = [\overline{V_{in}^2}]$, i.e V_f is the normalized root-mean-square value of V_{in} .

The chosen RMS technique exhibits the following advantages over other designs based on thermal techniques:

- Faster response - high accuracy $6\frac{1}{2}$ digit ACV readings at a rate of 20 per second. (Option 10)
- Higher accuracy - it achieves better than ± 80 ppm 1 year uncertainties. (Option 12)

- Wider dynamic range - the span from 100nV to 1000V RMS can be covered in fewer ranges, saving cost and space.
Measurement accuracies are specified for all inputs between 2% and 200% of each nominal range.
- Good crest factor performance for non-sinusoidal signals.

Frequency Readout

A reciprocal counter function is designed into one of the instrument's custom ASIC's which can display the frequency of an ACV signal at the same time as its RMS value being shown on the main display. This function is available as Option 10.

Resistance - Option 20

The wide selection of floating current source ranges provided by the resistance function means that a variety of resistance measurement modes can be offered to suit many different application areas. For example, when operating in its normal mode, the instrument's current source is selected to optimize for low noise and highest accuracy. However, where low compliance or low open circuit voltages across the DMM's terminals are needed, a low current mode (LoI) can be selected.

Useful applications include in-circuit testing of components connected across diode junctions; and measurement of temperature using Platinum Resistance Thermometers, where the self-heating effects of the current passing through the resistive element are important.

In addition, for those applications where external thermal emfs present measurement problems, a mode is provided where a zero reference reading is automatically taken with the measurement current turned off (Tru Ω). This zero measurement is subtracted from that made with current flowing, to give a resultant value where the effect of any thermal emfs have been eliminated.

External errors produced by specific connections can be reduced using four-wire sensing and Ohms guarding techniques. Four-wire sensed measurement can be made with up to 100Ω in any lead with negligible degradation in accuracy. Furthermore, errors caused in external leakage paths can be eliminated using an Ohms Guard terminal which may also be used for in-circuit measurement of components in parallel with other resistive elements.

Current - Option 30

For Current measurement, switched precision shunts are fitted internally. The unknown current passes through one of these, and the resulting voltage is measured. The shunts and the source of the current are protected both electronically and by a 1.6A fuse, accessible on the rear panel.

Option 30 requires Option 20 to be fitted.

For AC Current measurement, Option 10 or 12 must also be present.

SECTION 2 INSTALLATION AND OPERATING CONTROLS

Unpacking and Inspection 2-1

Calibration Enable Switch 2-1

Introduction to the Front Panel 2-2

Introduction to the Rear Panel 2-3

Preparation for Operation

Power Cable 2-4

Fuses 2-4

Line Voltage 2-5

Line Frequency 2-5

Mounting 2-6

Connectors and Pin Designations

Front Terminals 2-8

PL11 and PL12 - Rear Inputs 2-8

SK9 - External Trigger Input 2-8

SK7 - IEEE 488 Input/Output 2-9

SK8 - I/O Port 2-10

SECTION 2

Installation and Operating Controls

This section contains information and instructions for unpacking and installing the Datron 1271 Selfcal Digital Multimeter. It also introduces the layout of controls on the instrument.

Unpacking and Inspection

Every care is taken in the choice of packing material to ensure that your equipment will reach you in perfect condition.

If the equipment has been subject to excessive handling in transit, the fact will probably be visible as external damage to the shipping carton.

In the event of damage, the shipping container and cushioning material should be kept for the carrier's inspection.

Unpack the equipment and check for external damage to the case, sockets, keys etc. If damage is found notify the carrier and your sales representative immediately.

Standard accessories supplied with the instrument should be as described in Section 1.

Calibration Enable Switch

CAUTION

This two-position, key operated switch protect the instrument calibration memory.

The instrument was initially calibrated at the factory, so under no circumstances should the key be inserted into the switch, until immediate recalibration is intended.

For Recalibration:

If the external calibration menu is selected while the key is not in the enabling position, the menu is replaced by the warning message:

CALIBRATION DISABLED

Section 2 - Installation and Operating Controls

Introduction to the Front Panel

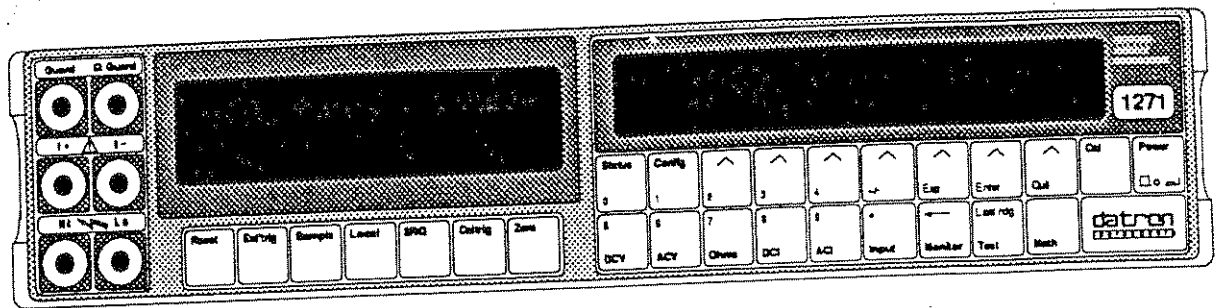

The two displays on the front panel deal with different aspects of operation. We set up the instrument's configuration using menus shown in the right-hand (dot-matrix) display, then readings appear in the left-hand (main) display.

Beneath the dot matrix display, all keys other than the Power key are associated with menus. The keys beneath the main display are direct action keys, associated with triggers, remote control, and instrument reset.

Menu Keys

There are two classes of front panel menu keys, those that lead to an immediate change of instrument state (i.e. the major function keys DCV, ACV, Ohms, DCI, ACI), and those that do not (Status, Config, Cal, Input, Monitor, Test, Math).

Numeric Keyboard

Seventeen of the menu and soft function keys also act as a keyboard for entry of parameters such as math constants, limits, bus address, etc. The data entered is purely numeric, and can consist of either a keyboard-entered value or the value of the most recent reading.

Major Function Keys:

DCV, ACV, Ohms, DCI, ACI

Each of these function keys defines a separate measurement state and activates its corresponding menu on the dot matrix display. Changing a selection alters the measurement state.

Instrument Options

Finally it is necessary to point out that although the keys for all the functions are present on the front panel, certain options (ACV, Ω or I) may not have been purchased.

Introduction to the Rear Panel

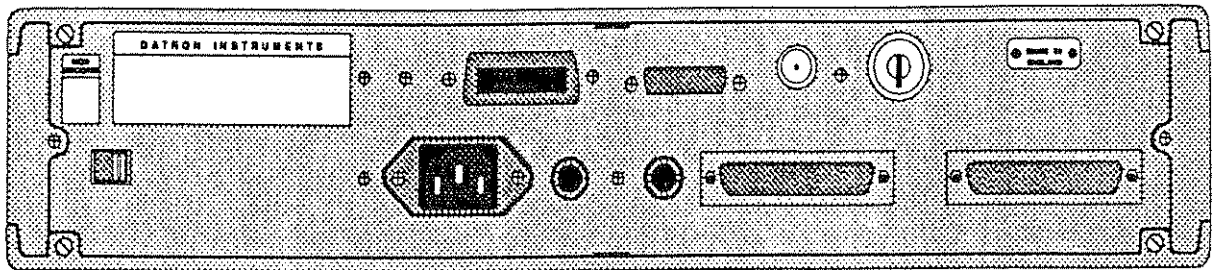

Mechanical Access

The top or bottom cover is released for removal by undoing two screws visible at the rear. A single screw retains the corner block which covers the handle mechanism on each side panel.

Labels

The rear panel displays the identification label for the instrument, and a modification strike label.

External Connections

Apart from the front input terminals, connections to the internal circuitry enter via the rear panel.

Two identical 50-way D-type plugs, PL11 and PL12 each reduced to six pins, are used for rear inputs channels A and B.

SK7 is the standard IEEE 488 connector. A list of interface function subsets is printed next to the connector.

An I/O Port, SK8, provides flag outputs for some defined internal conditions. SK8 also permits a hold to be placed on measurement triggers, and provides the connections for an analog output if Option 70 is incorporated.

SK9 provides a coaxial BNC trigger input.

Fuses

The fuse adjacent to the power input plug protects the power input line, the other protects the current measuring circuitry when Option 30 is fitted.

Voltage Selector

The recessed power line voltage selector adapts the instrument to either 115V or 230V line inputs. Note that adaptation to 50Hz or 60Hz supply frequency is switched from the front panel, via a calibration menu.

Calibration Keyswitch

To calibrate the instrument externally, special menus are available from the front panel. But to enter these menus it is necessary to set the calibration keyswitch on the rear panel to CALENABLE. The key is removed to prevent unauthorized or accidental access to the calibration procedures.

Preparation for Operation

DANGER

THIS INSTRUMENT IS CAPABLE OF DELIVERING A LETHAL ELECTRIC SHOCK IF IT IS CONNECTED TO A HIGH VOLTAGE SOURCE. THE I+, I-, Hi and Lo TERMINALS ARE MARKED WITH THE  SYMBOL TO WARN USERS OF THIS DANGER.

UNDER NO CIRCUMSTANCES SHOULD USERS TOUCH ANY OF THE FRONT TERMINALS UNLESS THEY ARE FIRST SATISFIED THAT NO DANGEROUS VOLTAGE IS PRESENT.

Power Cable

The detachable supply cable comprises two metres of 3-core PVC sheath cable permanently moulded to a fully-shrouded 3-pin cable socket. It fits into a plug (PL10 - incorporates a filter) at the rear of the instrument and should be pushed firmly home. The supply lead should be connected to a grounded outlet ensuring that the Ground lead is connected. Connect Brown lead to Live, Blue lead to Neutral, and Green/Yellow lead to Ground.

Fuses

Power Fuse:

Looking from the rear, the power fuse F1 is the left-hand fuse of the two on the rear panel. It should be of the anti-surge type. Its rating is dependent on the supply voltage:

for 200V to 260V - 630mA,
for 100V to 130V - 1.25A.

Option 30 - Current Fuse:

Looking from the rear, the current fuse is the right-hand fuse of the two on the rear panel. It is a high breaking capacity, quick-acting fuse, rated at 1.6A. The recommended type is BESWICK S501.

MAKE SURE THAT ONLY FUSES WITH THE REQUIRED RATED CURRENT AND OF THE SPECIFIED TYPE ARE INSERTED AS REPLACEMENTS.

AVOID THE USE OF MENDED FUSES AND DO NOT SHORT-CIRCUIT THE FUSE HOLDERS. SUCH PRACTICES WILL RENDER THE WARRANTY VOID.

Line Voltage

Voltage Selector and Line Fuses

If neither Option 80 nor Option 81 was specified at the time of ordering, the instrument is packed ready for use with 200V to 260V 50Hz supplies. '230' will be visible in the voltage selector window on the rear panel, and the fuse F1 will be rated at 630mA. If the 100V to 130V supply Option 80 or 81 was specified at the time of ordering; '115' will be visible in the window and the fuse rating will be 1.25A. Fuses of both ratings are supplied, the one which corresponds to the set line voltage will be fitted in the instrument, the other will be contained in the wallet.

Changing Supply Voltage Only

To change from one voltage to the other, it is necessary to move the voltage selector switch to the other position and fit the corresponding fuse, as noted under 'Fuses', earlier.

Line Frequency

Option 80 - 60Hz Status Inspection

For 115V 60Hz supplies, Option 80 should have been specified at the time of ordering, and then the instrument would have been set to 60Hz at manufacture. Once the instrument is switched on, the frequency to which it has been set can be displayed in a Status menu (refer to pages 3-41 and 3-43).

The frequency should have been set up, before delivery, for the line supply to be used. If for any reason this is not the case, contact your nearest Datron Service Center.

Section 2 - Installation and Operating Controls

Mounting

Bench Use:

The instrument is fitted with rubber-soled plastic feet and tilt stand. It can be placed flat on a shelf or tilted upwards for ease of viewing.

Rack Mounting:

Option 90 permits the instrument to be mounted in a standard 19 inch rack. The method of fitting this option is described below, the locations being shown in the diagram opposite.

N.B. The top or bottom cover should not be removed for this purpose.

Procedure

1. Remove each of the two rear corner blocks by undoing its single crosspoint screw, and store safely for possible future use.
2. Invert the instrument, and remove each handle as follows (detail 1):
 - a. Pull out the handle until the two 1.5mm socket-headed screws are visible in the handle locking bar.
 - b. Loosen the two locking screws using the 1.5mm hex key provided. Leave the screws in the bar.
 - c. Slide the whole handle assembly to the rear, out of the side extrusion.
 - d. Prize off the two catch plates from the extrusion, and place on the handle magnets as keepers.
3. Fit each front rack mounting ear as follows:
 - a. With its bracket to the front, slide the ear into the side extrusion from the rear.
 - b. Loosely fasten the ear to the extrusion at the front, using the four socket grubscrews provided.
 - c. Assemble the front plate and handle to the front ear as shown in the diagram, and clamp them together using the two counter-sunk screws provided.
 - d. Tighten all six screws.
4. Remove the feet and tilt stand as follows:
 - a. Prize off the rubber pads from the four feet.
 - b. Undo the two securing screws from each foot. This releases the feet, washers and tilt stand so that they can be detached and stored safely for possible future use.
5. Fit the instrument to the rack as follows:
 - a. Attach the two rear ears to the back of the rack, ready to receive the instrument.
 - b. With assistance, slide the instrument into the rack, locating the rear ears in the side extrusions. Push the instrument home, and secure the front ears to the front of the rack.

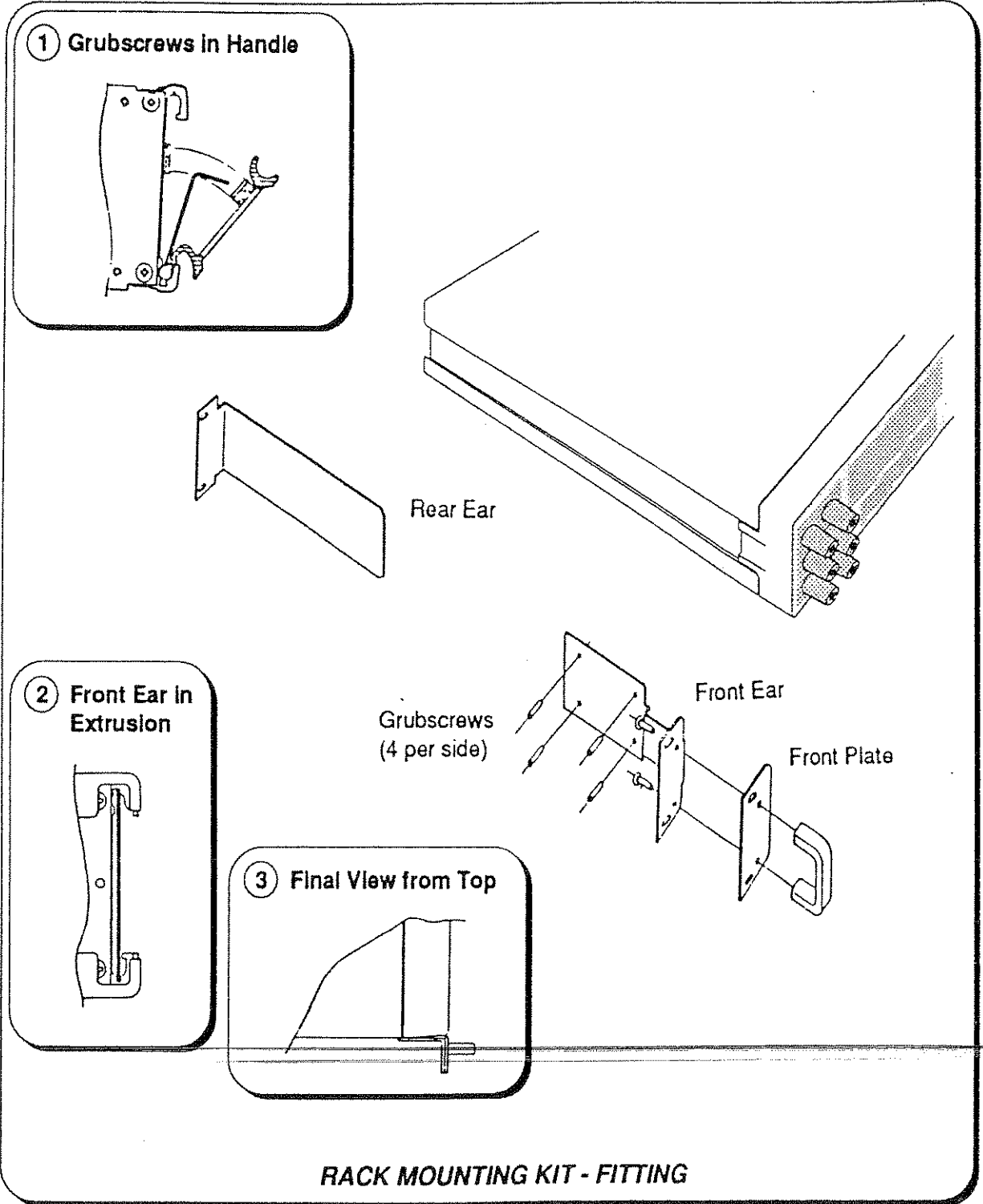

Connectors and Pin Designations

Front Terminals

Three pairs of 4mm 'banana' terminals are fitted on the left of the front panel. Their functions are as follows:

| | |
|---------------------------------|--|
| Guard | General Guard |
| ΩGuard | Ohms Guard |
| I+ | Ohms Current Source (4-Wire) Current Input High |
| I- | Ohms Current Sink (4-Wire) Current Input Low |
| HI | Voltage Input - High Ohms High (2-Wire) Ohms Sense High (4-Wire) |
| Lo | Voltage Input - Low Ohms Low (2-Wire) Ohms Sense Low (4-Wire) |

The block of terminals is extended forward by pressing the release catch at the top left-hand corner of the rear panel (viewing from the front). To retract the block for transit, hold the release catch pressed, slide the block back into the body of the instrument, then release the catch.

PL11 and PL12 - Rear Inputs

The two rear panel input channels incorporate two identical 50-way Cannon 'D' type plugs, each reduced to six pins, and fitted with screw locks for strain relief. Channel A is connected via PL12, and Channel B via PL11. The layout of the pins and their designations are shown below.

Two sets of socket parts are provided with the instrument, so that users can make up input sockets to fit these plugs to suit their own installations. Refer to Section 1, page 1-5.

Pin Layout and Designations

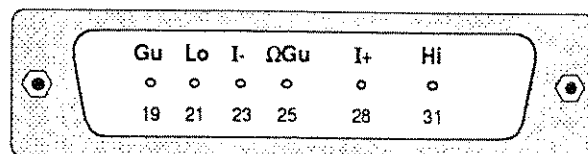

SK9 - External Trigger Input

This co-axial BNC socket can be used to trigger a measurement when external triggers are enabled. The single pin is pulled up internally to +5V, and requires a negative-going TTL edge to initiate the reading.

SK7 - IEEE 488 Input/Output

Compatibility

The IEEE input/output is a 24-way Amphenol connector which is directly compatible with the IEEE 488 interface and the IEC 625 Bus.

Note that the Bus Address is set from the front panel (refer to Section 5).

Pin Layout

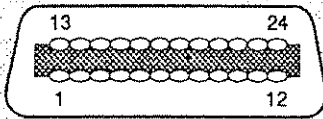

Pin Designations

| Pin No. | Name | Description |
|---------|--------|--|
| 1 | DIO 1 | Data Input/Output Line 1 |
| 2 | DIO 2 | Data Input/Output Line 2 |
| 3 | DIO 3 | Data Input/Output Line 3 |
| 4 | DIO 4 | Data Input/Output Line 4 |
| 5 | EOI | End or Identify |
| 6 | DAV | Data Valid |
| 7 | NRFD | Not Ready For Data |
| 8 | NDAC | Not Data Accepted |
| 9 | IFC | Interface Clear |
| 10 | SRQ | Service Request |
| 11 | ATN | Attention |
| 12 | SHIELD | Screening on cable (connected to 1271 safety ground) |
| 13 | DIO 5 | Data Input/Output Line 5 |
| 14 | DIO 6 | Data Input/Output Line 6 |
| 15 | DIO 7 | Data Input/Output Line 7 |
| 16 | DIO 8 | Data Input/Output Line 8 |
| 17 | REN | Remote Enable |
| 18 | GND 6 | Gnd wire of DAV twisted pair |
| 19 | GND 7 | Gnd wire of NRFD twisted pair |
| 20 | GND 8 | Gnd wire of NDAC twisted pair |
| 21 | GND 9 | Gnd wire of IFC twisted pair |
| 22 | GND 10 | Gnd wire of SRQ twisted pair |
| 23 | GND 11 | Gnd wire of ATN twisted pair |
| 24 | GND | 1271 Logic Ground (internally connected to 1271 Safety Ground) |

Section 2 - Installation and Operating Controls

SK8 - I/O Port

This is a 15-way Cannon 'D' type socket, fitted with screw locks for strain relief. It provides for inputs and outputs as listed below; for more information refer to Section 4.

A spare D type socket is provided with each new instrument, so that users can make up a connector to fit this plug to suit their own installations. Refer to Section 1, page 1-5.

Pin Layout

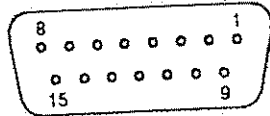

Pin Designations

| Pin | Name | Function |
|-----|------------------|------------------|
| 1 | SHIELD | |
| 2 | HIGH LIMIT_L | Flag - low true |
| 3 | LOW LIMIT_L | Flag - low true |
| 4 | DATA VALID_L | Flag - low true |
| 5 | SAMPLING_H | Flag - high true |
| 6 | TRIG. TOO FAST_L | Flag - low true |
| 7 | DIGITAL COMMON | |
| 8 | ANALOG OUTPUT | (Option 70 only) |
| 9 | OVERLOAD_L | Flag - low true |
| 10 | AN. O/P ENABLE_L | Input - low true |
| 11 | SPARE | |
| 12 | SPARE | |
| 13 | HOLD_L | Input - low true |
| 14 | DIGITAL COMMON | |
| 15 | ANALOG O/P 0V | (Option 70 only) |

SECTION 3 BASIC MEASUREMENTS

| | |
|---|------|
| The Measurement Task | 3-1 |
| Introduction to the Front Panel | 3-1 |
| Menu Keys | 3-2 |
| Numeric Keyboard | 3-3 |
| Major Function Keys: DCV, ACV, Ohms, DCI, ACI. | 3-4 |
| Instrument Options | 3-4 |
| Initial State at Power On | 3-5 |
| Soft Key Conventions | 3-6 |
| Quick Tour of the Major Function Menus | 3-7 |
| DCV Menu | 3-7 |
| AC Voltage (Options 10 & 12) | 3-10 |
| Resistance (Option 20) | 3-15 |
| DC Current (Option 30 with Option 20) | 3-28 |
| AC Current (Option 30 with Options 10 or 12 and 20) | 3-32 |
| 'Input ' and 'Status' Keys | 3-37 |
| Conclusion | 3-46 |

SECTION 3

Basic Measurements

This section introduces the basic 'User Interface' of the 1271, describing how to make straightforward measurements without recourse to the more advanced features of the instrument. Descriptions of these other features can be found in Part 2, Section 4.

The Measurement Task

With the external circuit properly connected, any measurement requires us to take two actions:

1. Configure the instrument;
2. Trigger the measurement and read the result.

The 1271 allows us to choose from many actions to control these processes. As an introduction, we shall concentrate on the selections for taking basic measurements of AC and DC Voltage, AC and DC Current; and Resistance. These are not complicated - all we need to do is to work through the instrument's selection menus.

Introduction to the Front Panel

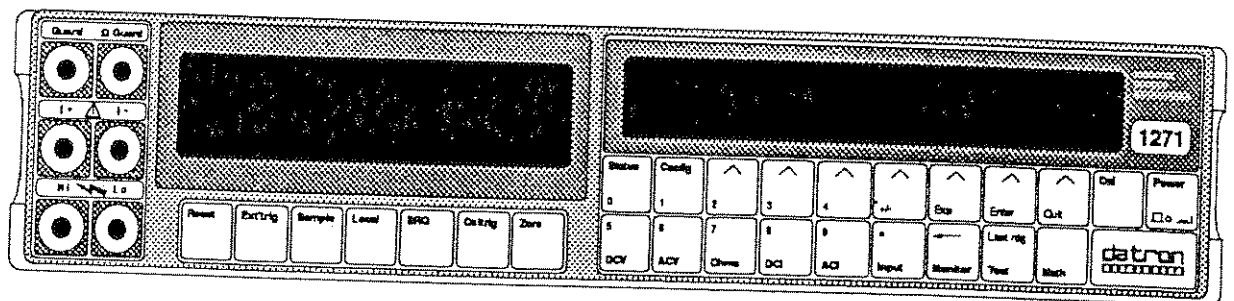

The two displays on the front panel deal with different aspects of operation. We set up the instrument's configuration using menus shown in the right-hand (dot-matrix) display, then readings appear in the left-hand (main) seven-segment display.

Beneath the dot matrix display, all keys other than the Power key are associated with menus. The keys beneath the main display are direct action keys, associated with triggers, remote control, and instrument reset.

Menu Keys

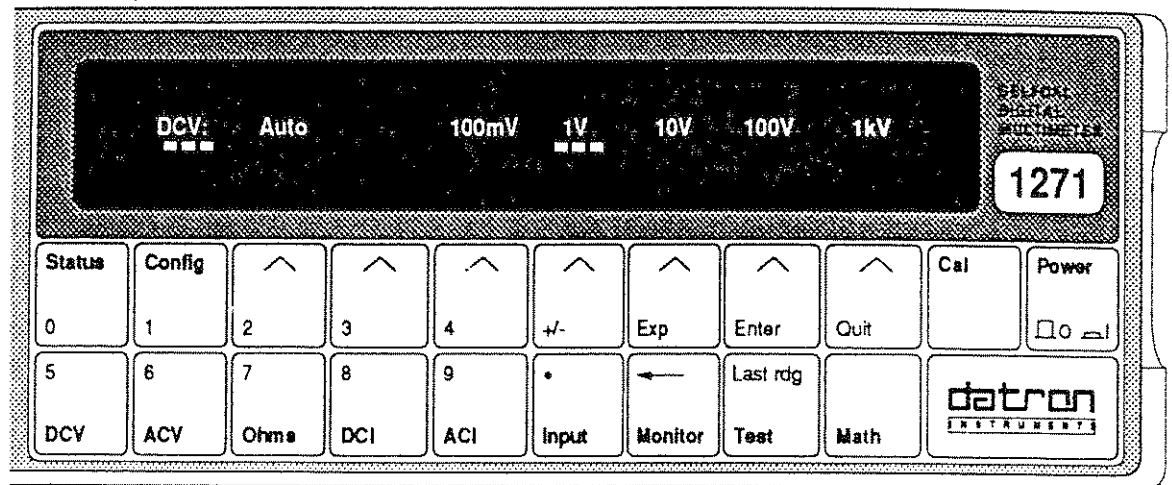

There are two classes of front panel menu keys; those that lead to an immediate change of instrument state (i.e the major function keys DCV, ACV, Ohms, DCI, ACI), and those that do not (Status, Config, Cal, Input, Monitor, Test, Math).

As well as the menu selection keys, there are seven soft function selection keys which have different actions depending on the selected menu. An arrowhead printed on each soft key lines up with a label which defines the action of the key (DCV menu version shown above).

Also, system messages (all in capitals) may appear, these assist to clarify operation.

The labelled soft keys have actions which fall into the following classes:

- Select another menu.
- Enable or disable a facility (e.g. 2 or 4-wire in Ohms). When enabled, the soft key label is underlined by a cursor.
- Trigger a direct action (e.g. 'Full' in the TEST menu activates a full selftest).

An error message appears if a selection cannot be executed (e.g. option not fitted).

Numeric Keyboard

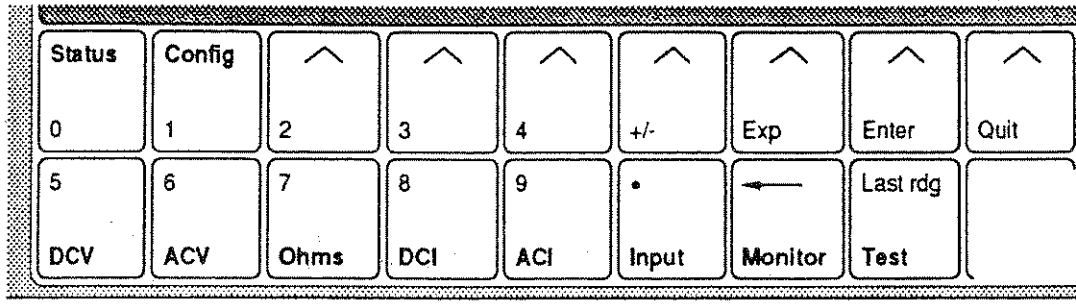

Some menu and soft function keys, shown above, also act as a keyboard for entry of parameters such as math constants, limits, bus address, etc. The data entered is purely numeric, and can consist of either a keyboard-entered value or the value of the most recent reading.

Exit from Menus

We can generally exit from any menu by selecting another menu key. For those menus where the keyboard is active, we can exit by pressing either Enter or Quit. For some menus, a special soft key permits exit by a single keystroke.

Section 3 - Basic Measurements

Major Function Keys: DCV, ACV, Ohms, DCI, ACI.

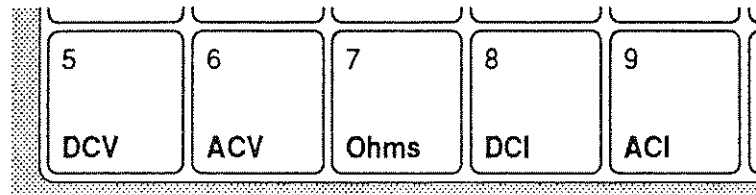

Each of these function keys defines a separate measurement state and activates its corresponding menu on the display. Changing a selection therefore commands a change of measurement state.

Each function has its associated CONFIG (Configuration) menu, which we can use to set up 'function-dependent' parameters such as resolution and filter settings. Once set up, the instrument remembers the pattern of parameter conditions in that function, so that when we reselect it on a later occasion, it remains set up as before until we change it or turn off the instrument power.

Instrument Options

Finally it is necessary to point out that although the keys for all the functions are present on the front panel, certain options (ACV, Ω or I) may not have been purchased. In these cases, the following tour is not disrupted by missing out a whole sequence related to one of those options. For this purpose a reminder is attached to the heading of each of the optional function sequences in the form of the option number.

Initial State at Power On

To see this condition, ensure that the instrument has been correctly installed in accordance with Section 2, and **Operate the Power switch** on the front panel.

The instrument is forced into the following state:

| | |
|---------------------|--------------------------------------|
| <i>Function</i> | DCV |
| <i>Range</i> | 1kV |
| <i>Resolution</i> | 6 ¹ / ₂ digits |
| <i>Input</i> | Front |
| <i>Filter</i> | Off |
| <i>Fast</i> | Off |
| <i>Remote Guard</i> | Off |
| <i>Ratio</i> | Off |
| <i>Monitor</i> | Off |
| <i>Math</i> | Off |

Observe the **DCV Menu**:

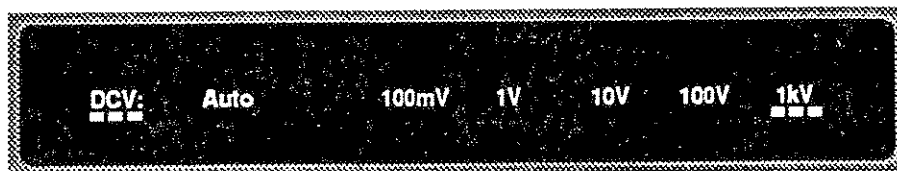

The 1kV range is underlined, showing the active selection. Autorange can be selected, the range it makes active also being underlined. It can be cancelled by any range selection, or by pressing the Auto key a second time (in this case it reverts to the auto-selected range). Ranges themselves cross-cancel.

Leave the power switched on. We have to distinguish between three main types of action built into the operation of the soft keys. These are defined overleaf, together with the shorthand conventions we use in the quick tour to refer to them.

Soft Key Conventions

Now look at the soft keys (the ones with the arrowheads) to make some distinctions in a little more detail. Each soft key's action is defined by the legend presented above it on the display. The legends usually define three different types of soft key:

Choice key Chooses one of several possible states. Deselection is by cross-cancelling, i.e. by selecting another state.

(The ranges on the DCV menu are *Choice* keys).

cursor underline indicates 'active',

no cursor indicates 'not active'.

Toggle key Activates a particular facility - a second press when its state is active will cancel it.

(‘Filt’ on the DCV CONFIG menu is a *Toggle* key).

cursor underline indicates 'active',

no cursor indicates 'not active'.

Menu key Activates another menu - cursor not used. The whole aim of branching via a menu is to gain access to further grouped state keys at an end of the branch.

(‘Res1’ on the DCV CONFIG is a *Menu* key).

N.B. When introducing soft keys in this text we shall differentiate between the three types (to avoid lengthy paragraphs) as follows:

| | | |
|-------------------|-------------------|-------------------------|
| <i>Choice key</i> | Underlined | e.g. <u>100mV</u> |
| <i>Toggle key</i> | Underlined italic | e.g. <u><i>Filt</i></u> |
| <i>Menu key</i> | Not underlined | e.g. Res1 |

Note that this is purely a short method of identifying the type, and bears no relation to its physical appearance on the instrument.

Quick Tour of the Major Function Menus

The following introduction takes the form of a quick tour of the main functions, starting from Power On. To relate the descriptions to the physical appearance, process through the sequence as indicated by the pointer ().

DCV Menu (See the figures on pages 3-2 and 3-5)

This menu defines the following *choice* keys.

Auto The range it makes active is also underlined. As well as being cancelled by any range selection, it can also be cancelled by re-pressing the Auto key itself (in this case the instrument reverts to the auto-selected range).

Ranges: 100mV 1V 10V 100V 1kV

DCV Configuration

(Resolution, LP Filtering and Fast)



Press the Config key to see the DCV CONFIG menu:

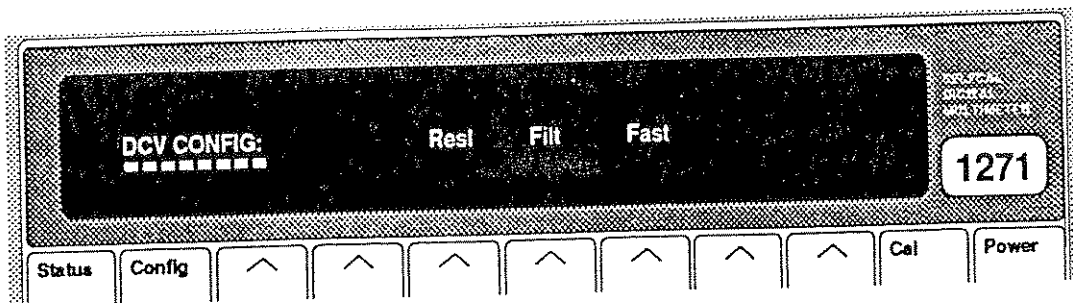

Resl: Displays the DCV RESL menu, to select the resolution for the reading.

Filt: Selects a two-pole analog filter for increased noise rejection; when active, the Filt annunciator is lit on the main display. Cancel by pressing the Filt key a second time. Filt is not selected at Power On.

Fast: Provides higher read rates at some increase in uncertainty due to noise. Cancel by pressing the Fast key a second time. Fast is not selected at Power On.

DCV Resolution



Press the Resl key to see the DCV RESL menu:

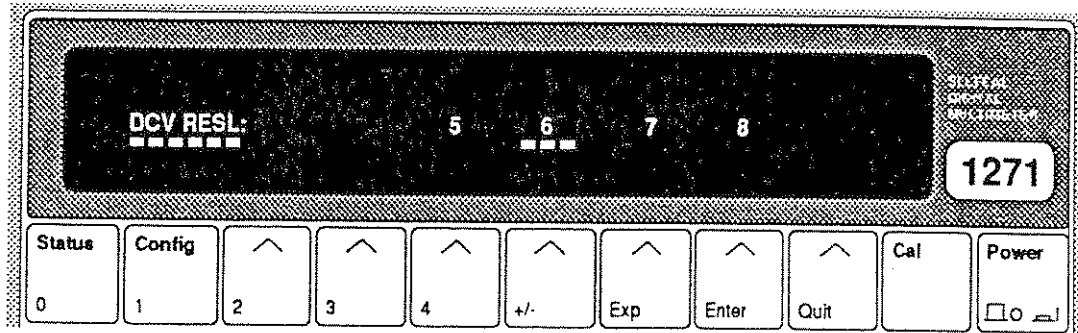

This menu defines the following *choice* keys:

- 5 5¹/₂ digits resolution
- 6 6¹/₂ digits resolution
- 7 7¹/₂ digits resolution
- 8 8¹/₂ digits resolution

As you can see, this permits the choice of any resolution between 5¹/₂ and 8¹/₂ digits. Power On setting is 6¹/₂ digits.

Transferring from the DCV RESL menu back to the DCV CONFIG menu is by pressing the Config key.

Transferring from either menu back to the DCV menu is by pressing the DCV key.

DC Voltage - Movement between Menus

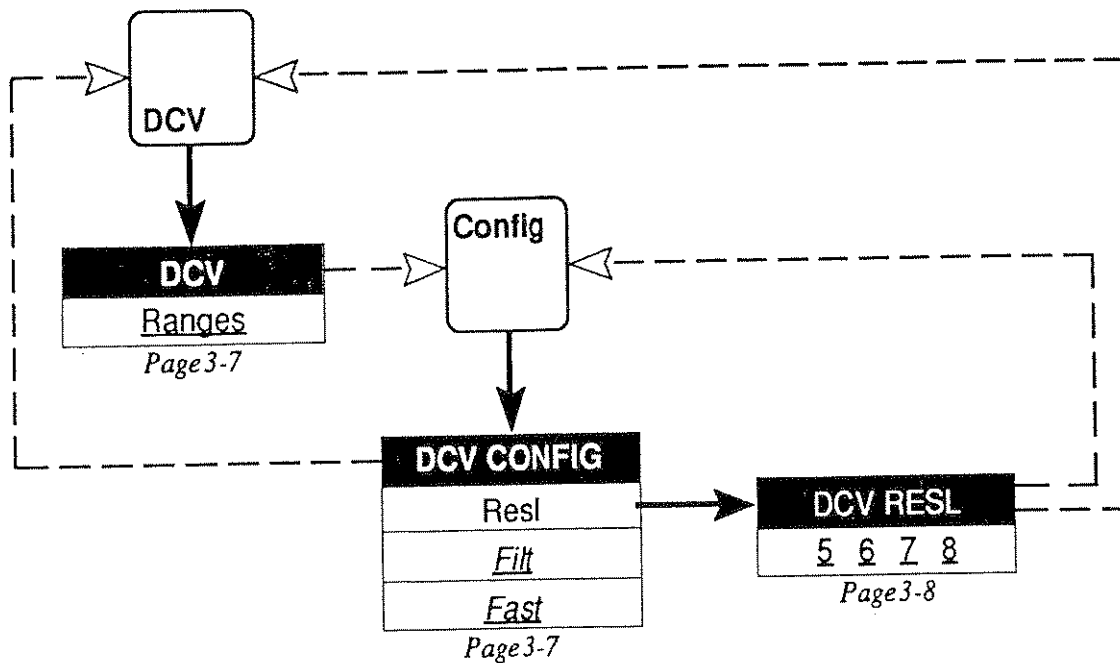

Broken lines indicate use of hard keys

Section 3 - Basic Measurements

AC Voltage (Options 10 & 12)



Press the ACV key to see the ACV menu:

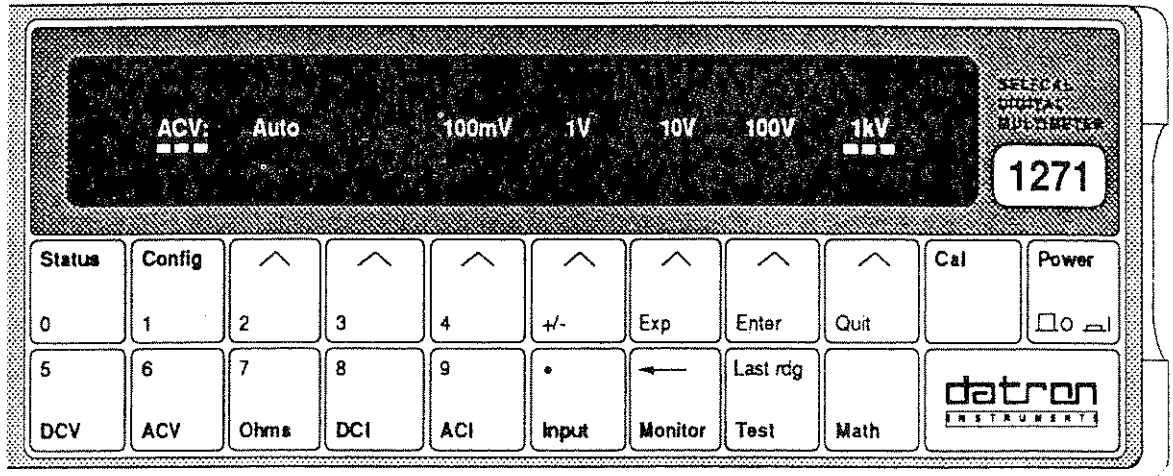

This menu defines the following *choice* keys.

Auto The range it makes active also being underlined.
As well as being cancelled by any range selection, it can also be cancelled by re-pressing the Auto key (in this case it reverts to the auto-selected range).

Ranges: 100mV 1V 10V 100V 1kV

ACV Configuration

(Resolution, LP Filtering, AC/DC Transfer, and DC Coupled)



Press the Config key to see the ACV CONFIG menu:

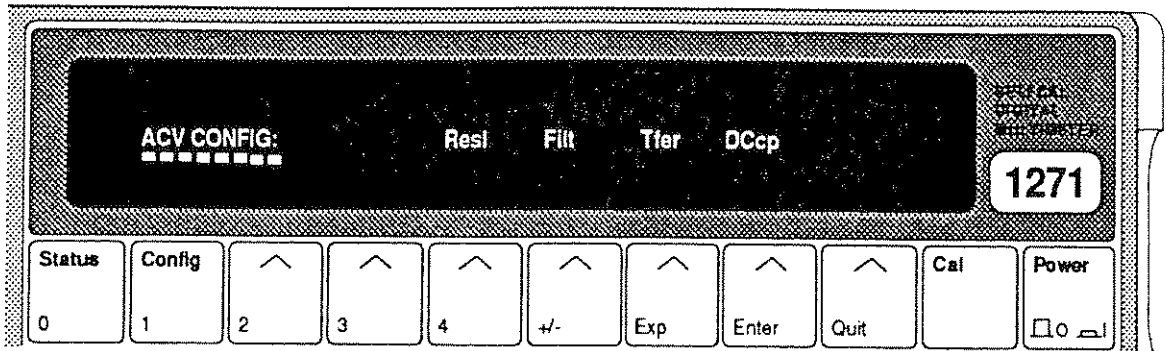

This menu defines the following soft keys.

Resl and Filt are *menu keys*, but Tfer and DCcp are *toggle keys*.

- Resl:** Displays the ACV RESL menu, where the resolution for the reading can be selected.
- Filt:** Displays the ACV FILT menu, to extend the LF bandwidth to the lowest frequency to be input.
- Tfer:** (Option 12 only) Selects electronic AC-DC transfer for AC measurement, improving linearity and temperature performance. Tfer is selected at Power On.
- DCcp:** Selects DC coupled measurement configuration. We can therefore choose to measure either the RMS of a combined AC and DC signal (DC Coupled - DCcp On), or just the RMS of the AC component (AC Coupled - DCcp Off). DCcp **must** be selected for any input of frequency less than 40 Hz. DCcp is not selected at Power On.

Section 3 - Basic Measurements

ACV Resolution



Press the Resl key to see the ACV RESL menu:

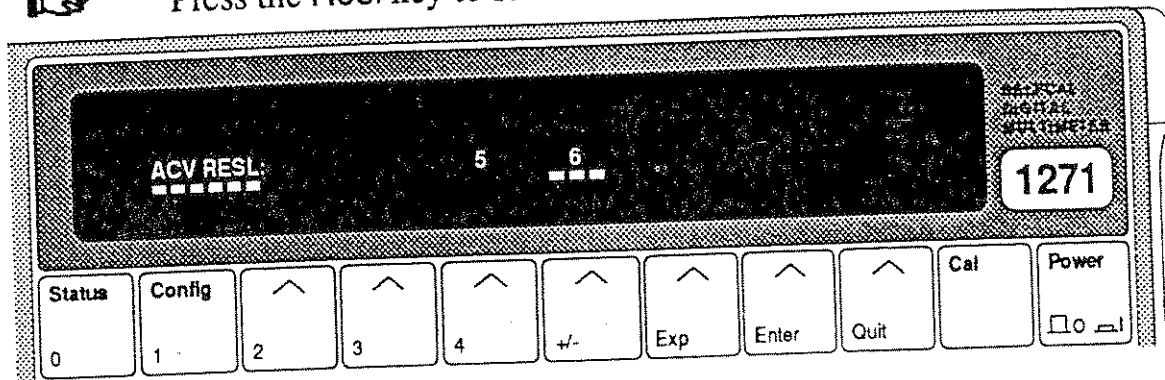

This menu defines the following *choice* keys:

- 5 5¹/₂ digits resolution
- 6 6¹/₂ digits resolution

Power On setting is 6¹/₂ digits.



Transfer back to the ACV CONFIG menu by pressing the Config key.

ACV Filter (Option 10)



Press the Filt key to see the ACV FILTER menu:

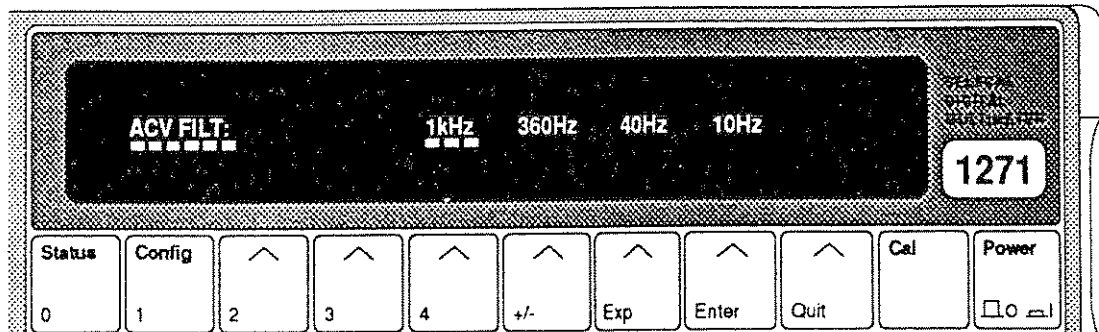

This menu permits any one of four LF filters to be used for AC Voltage measurement. Each *choice* key selects a filter whose lowest pass frequency is as shown.

Power On setting is 1kHz.

ACV Filter (Option 12)

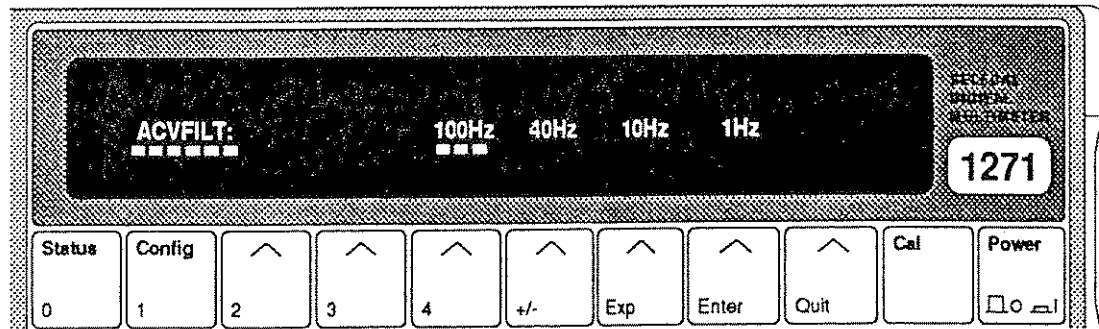

This menu permits any one of four LF filters to be used for AC Voltage measurement. Each *choice* key selects a filter whose lowest pass frequency is as shown.

Power On setting is 100Hz.

Section 3 - Basic Measurements

AC Voltage - Movement between Menus

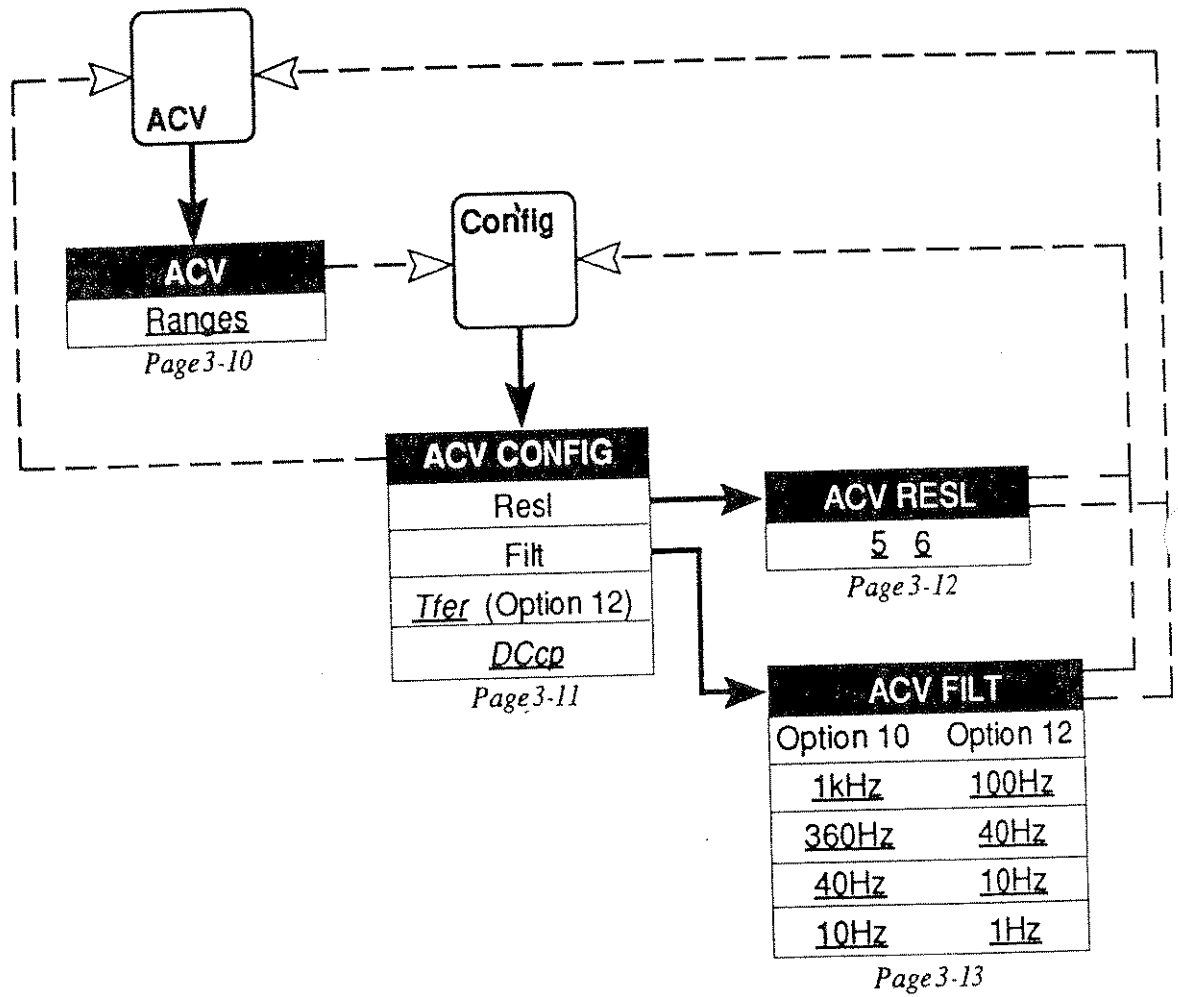

Broken lines indicate use of hard keys

Resistance (Option 20)



Transfer to the OHMS menu by pressing the Ohms key.

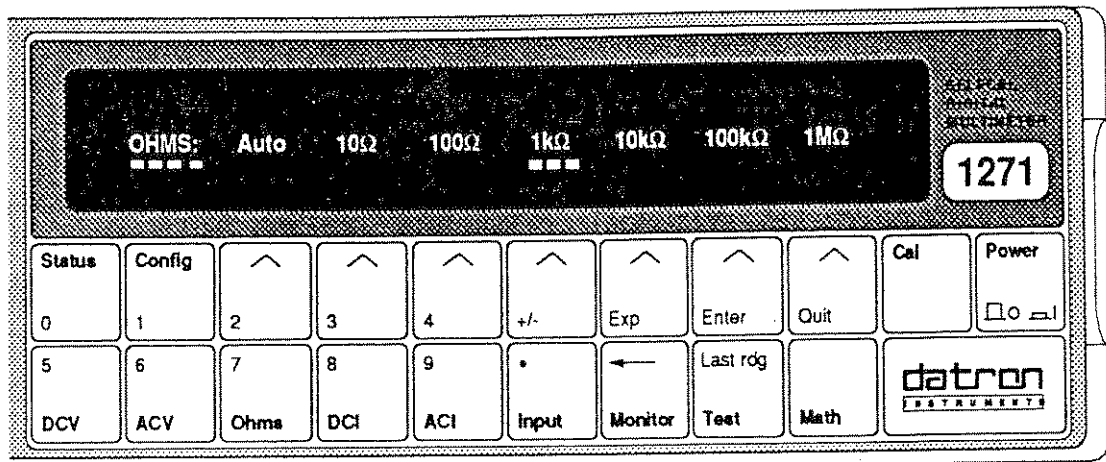

One of three possible menus will be displayed by pressing this key, depending on the most recent earlier selection in the Ohms function.

OHMS This is the normal resistance mode, offering both 2-wire and 4-wire measurements, in decade ranges from 10Ω to 1MΩ. The higher ranges 1MΩ to 1GΩ are the subject of the HIΩ menu, and a TRUΩ menu is included, both are described later.

Auto The range it makes active is also underlined. As well as being cancelled by any range selection, Auto can also be cancelled by re-pressing the Auto key (in this case it reverts to the auto-selected range).

The OHMS menu is selected On at Power On.

OHMS Configuration

(Change Ω Mode, Resolution, Filter, Fast, Low Current and 4-Wire Operation)



Press the Config key to see the OHMS CONFIG menu:

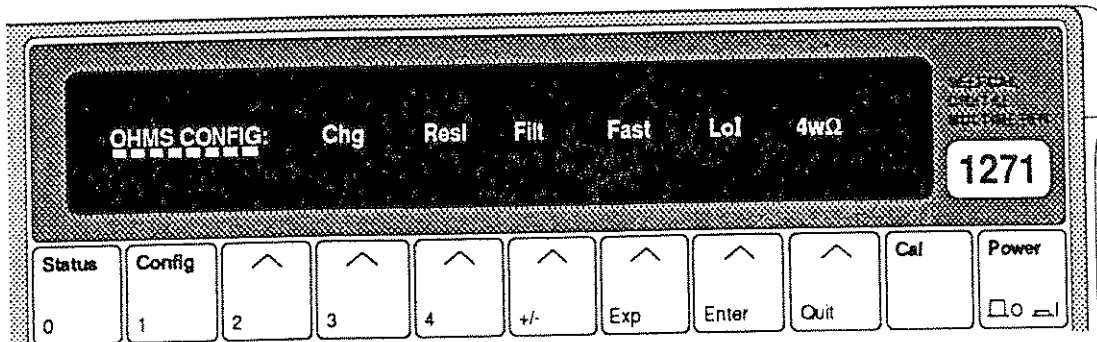

Chg and Resl are *menu* keys, but Filt, Fast, LoI, and 4w Ω are *toggle* keys.

- Chg:** Displays the CHANGE menu, which gives the choice of selecting either the OHMS, HI Ω or TRU Ω menus.
- Resl:** Displays the OHMS RESL menu, where the resolution for the reading can be selected.
- Filt:** Selects a two pole analog filter for increased noise rejection. When selected, the Filt annunciator on the main display is lit. Filt is not selected at Power On.
- Fast:** Selects higher read rates at some increase in uncertainty due to noise. Fast is not selected at Power On.
- LoI:** Selects a set of lower value measurement currents necessary for certain applications such as PRTs. LoI is not selected at Power On.
- 4w Ω :** Selects 4-wire resistance measurements; where the constant current is fed through the test resistance from the instrument's I+ and I- terminals. The resulting potential difference is sensed by the Hi and Lo terminals. When selected, the 4w annunciator is lit on the main display. Otherwise all measurements are 2-wire, current being sourced from the Hi and Lo terminals. 4w Ω is not selected at Power On.

OHMS Resolution



Press the Resl key to see the OHMS RESL menu:

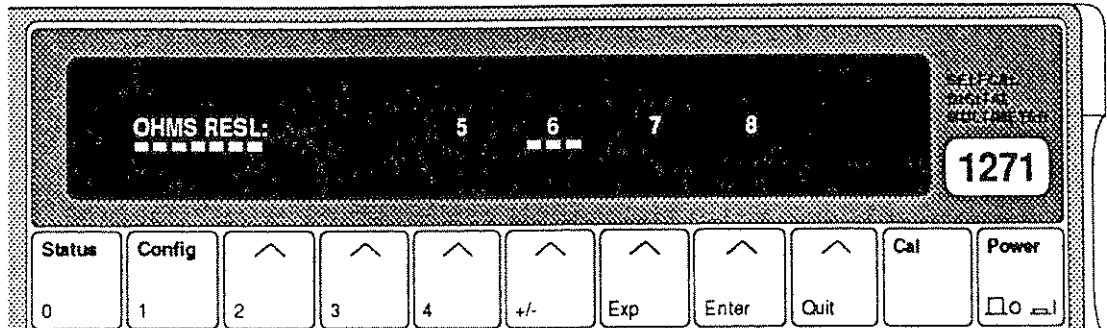

This menu defines the following *choice* keys:

- 5 5¹/₂ digits resolution
- 6 6¹/₂ digits resolution
- 7 7¹/₂ digits resolution
- 8 8¹/₂ digits resolution

This permits the choice of any resolution between 4¹/₂ and 8¹/₂ digits.
Power On setting is 6¹/₂ digits.



Transfer from the OHMS RESL menu back to the OHMS CONFIG menu by pressing the Config key.

CHANGE Ω Menu



Press the Chg key to see the CHANGE Ω menu:

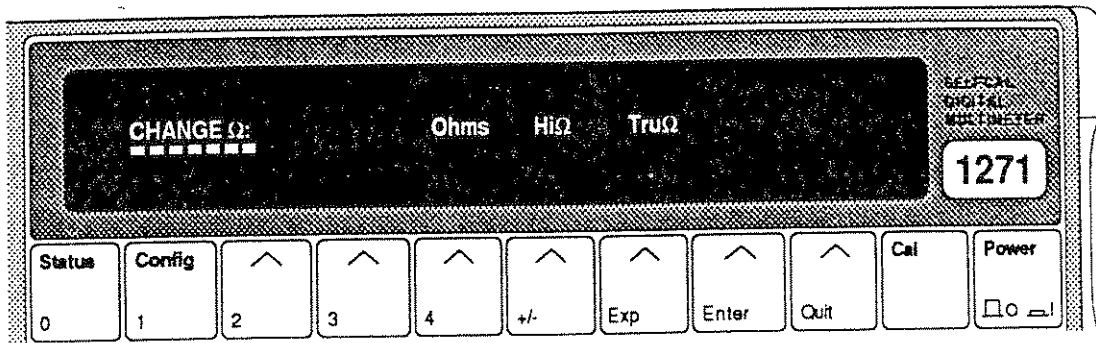

The CHANGE Ω menu is accessible from all three Ohms modes, and itself gives access to all three modes. It defines the following menu keys, each selecting a different Ohms mode menu:

- Ohms Selects the OHMS menu described above for the normal Ohms ranges.
- Hi Ω Selects the HI Ω menu.
- Tru Ω Selects the TRU Ω menu.

Ohms - Movement between Menus

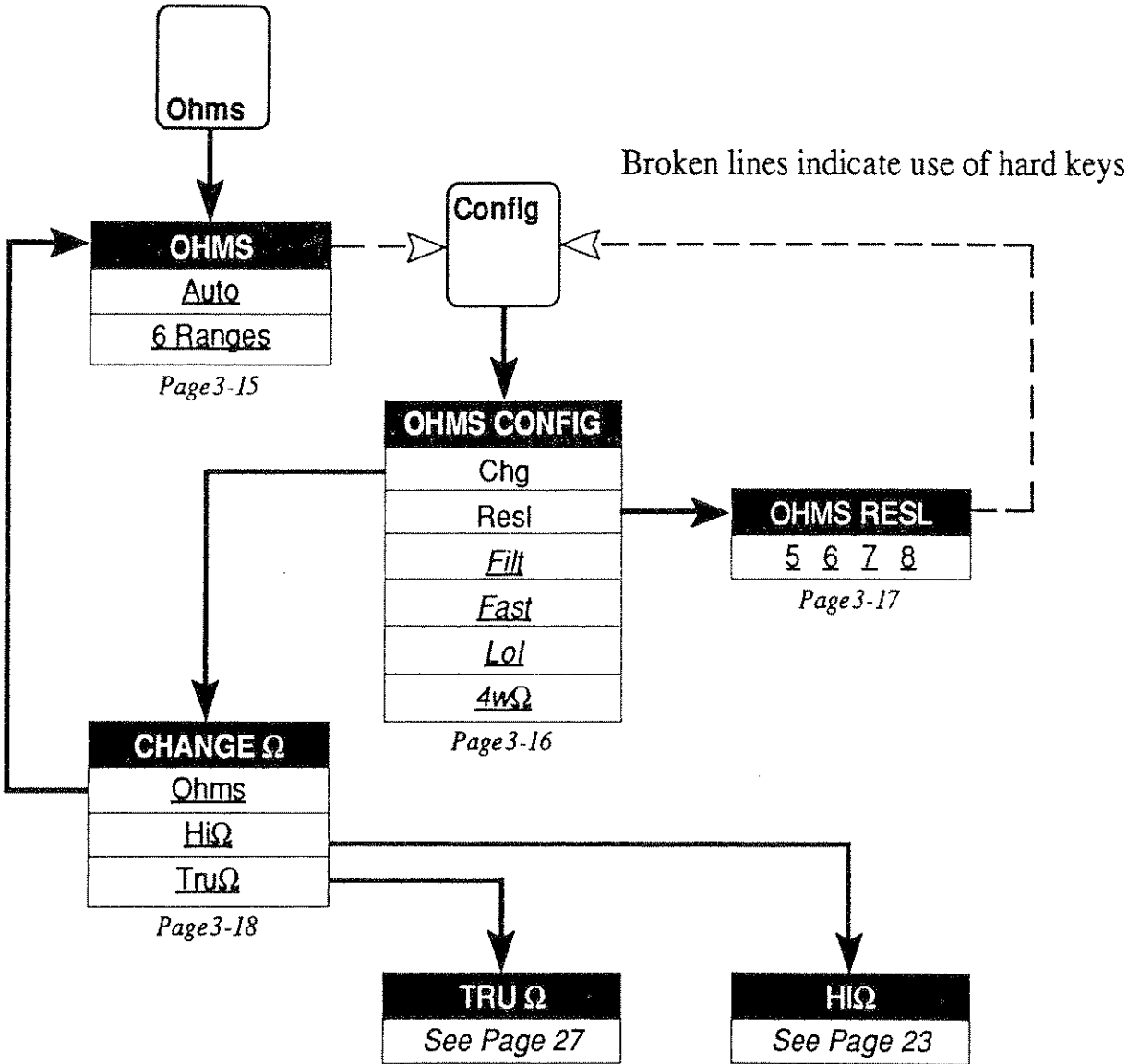

Section 3 - Basic Measurements

Higher Ohms Ranges ($10M\Omega$ to $1G\Omega$)



Press the Hi Ω key to see the Hi Ω menu:

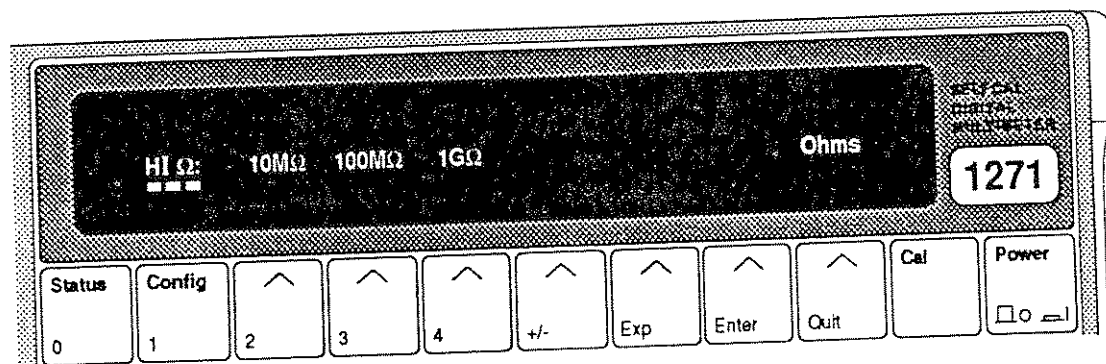

The Hi Ω menu gives access to the three higher ranges not present on the normal OHMS menu. The 'Autorange', 'Fast' and 'Low Current' facilities are not available, and the range of resolutions is restricted. It defines the following keys:

10M Ω , 100M Ω and 1G Ω are *choice* keys which each cause the instrument to enter the selected range, but Ohms is a *menu* key.

10M Ω Puts the instrument into its 10M Ω range.

100M Ω Puts the instrument into its 100M Ω range.

1G Ω Puts the instrument into its 1G Ω range.

Ohms Selecting Ohms in this menu causes the display to revert to the normal OHMS menu.

The Hi Ω menu is not selected at Power On.

N. B. Whenever Hi Ω is active, in any menu, pressing the hard Ohms function key will display this Hi Ω menu.

HIΩ Configuration

The HIΩ facility has its own configuration menu:



Press the Config key to see the HIΩ CONFIG menu:

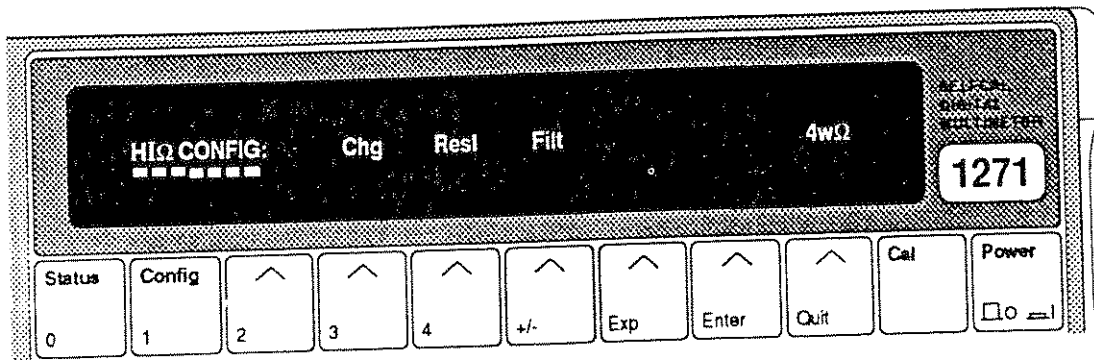

Chg and Resl are *menu* keys, but Filt and 4wΩ are *toggle* keys.

- Chg:** Displays the CHANGE menu, which gives the choice of selecting either the OHMS, HIΩ or TRUΩ menus, as described earlier.
- Resl:** Displays the HIΩ RESL menu, where the resolution for the reading can be selected.
- Filt:** Selects a two pole analog filter for increased noise rejection. When selected, the Filt annunciator on the main display is lit. Filt is not selected at Power On.
- 4wΩ:** Selects 4 wire resistance measurements; where the constant current is fed through the resistance-under-test from the I+ and I- terminals of the instrument, and the resulting potential difference is sensed by the Hi and Lo terminals. When selected, the 4W annunciator is lit on the main display. When not selected, all measurements are 2-wire with current being sourced from the Hi and Lo terminals. 4wΩ is not selected at Power On.

Section 3 - Basic Measurements

HI Ω Resolution



Press the Resl key to see the HI Ω RESL menu:

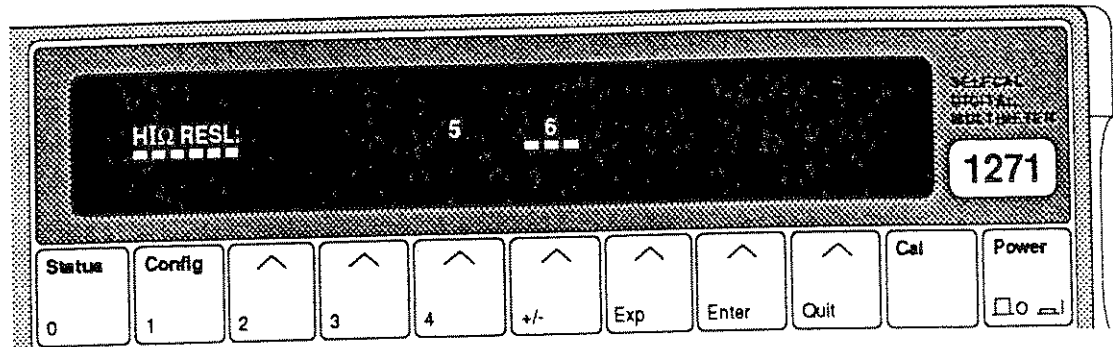

This menu defines the following *choice* keys:

- 5 5¹/₂ digits resolution
- 6 6¹/₂ digits resolution

Power On setting is 6¹/₂ digits.



Transfer from the HI Ω RESL menu back to the HI Ω CONFIG menu by pressing the Config key.

CHANGE to TRU Ω



Press the Chg key to see the CHANGE Ω menu:



Press the Tru Ω key to see the TRU Ω menu:

HIΩ - Movement between Menus

Broken lines indicate use of hard keys

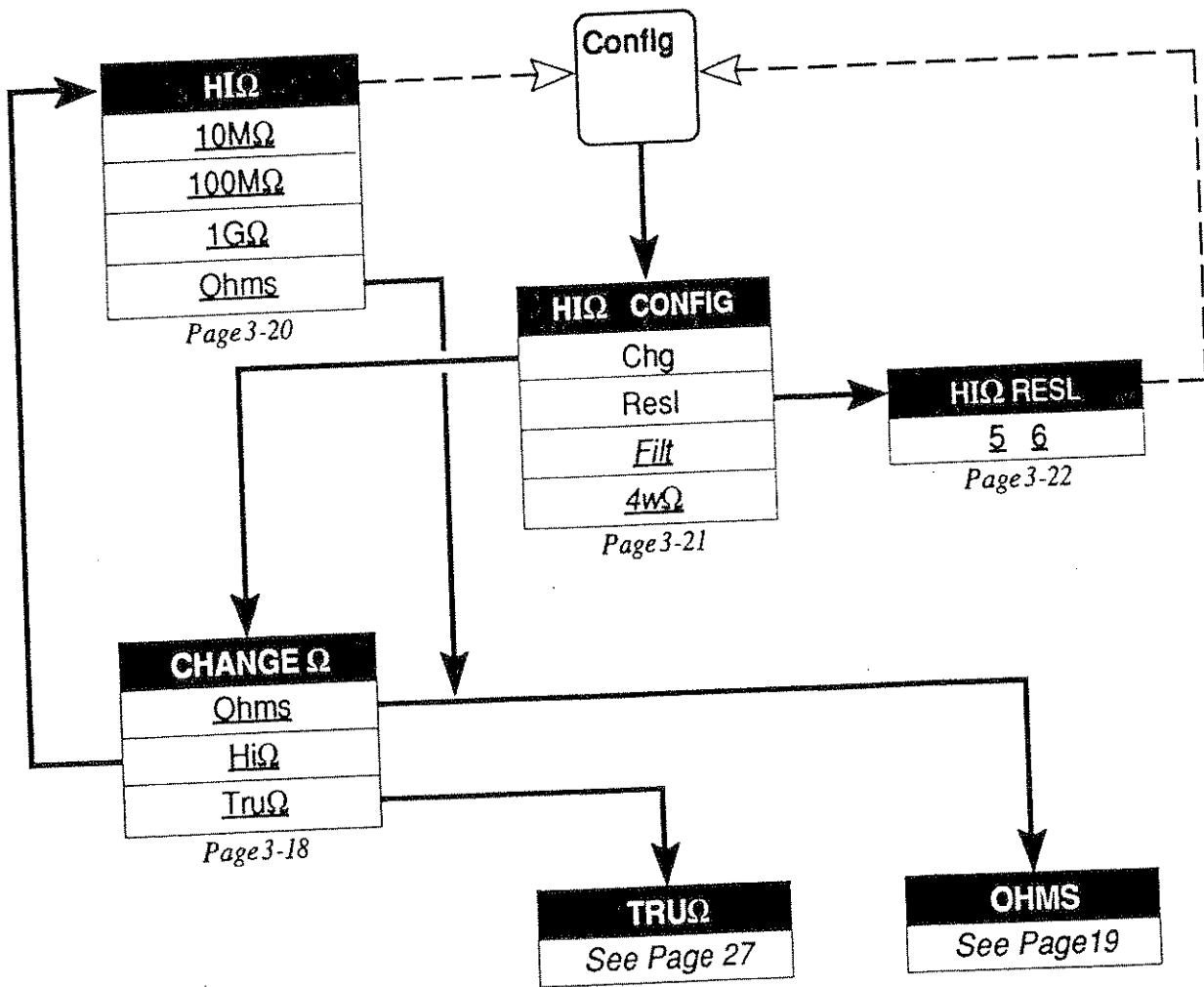

Section 3 - Basic Measurements

True Ohms Facility

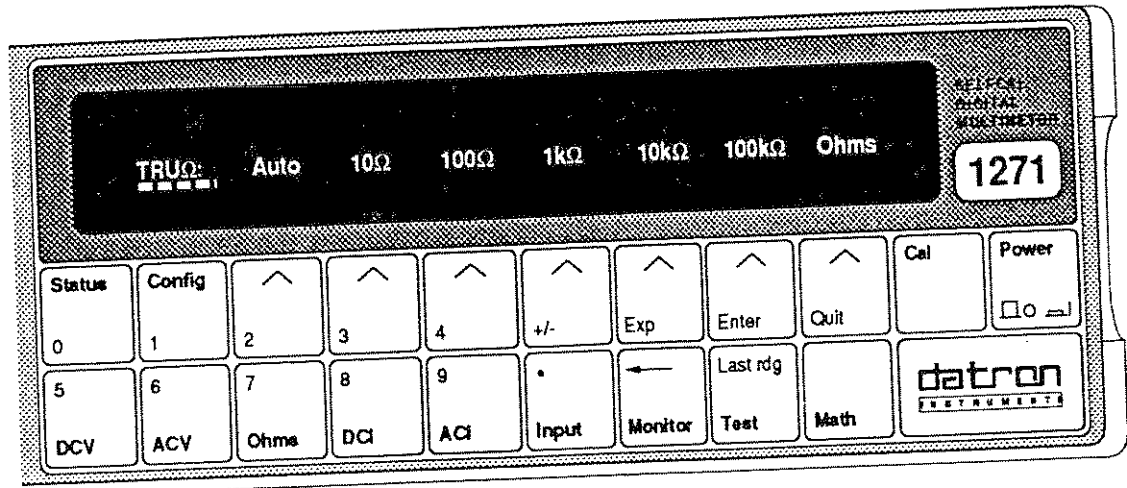

The TRUΩ mode generates two readings per measurement. The first is taken with the constant current flowing; the second without the current, measuring any external EMFs that may be present. The difference between the two readings is then calculated, giving an offset-corrected measurement.

The menu defines the following keys:

The Range keys are *choice* keys, but Ohms is a *menu* key.

Auto, and the 10Ω - 100kΩ range keys act normally to set the instrument range.

Ohms Selecting Ohms in this menu causes the display to revert to the normal OHMS menu.

The TRUΩ menu is not selected at Power On.

N. B. Whenever TruΩ is active, in any menu, pressing the hard Ohms function key will display this TRUΩ menu.

TRUΩ Configuration



Press the Config key to see the TRUΩ CONFIG menu:

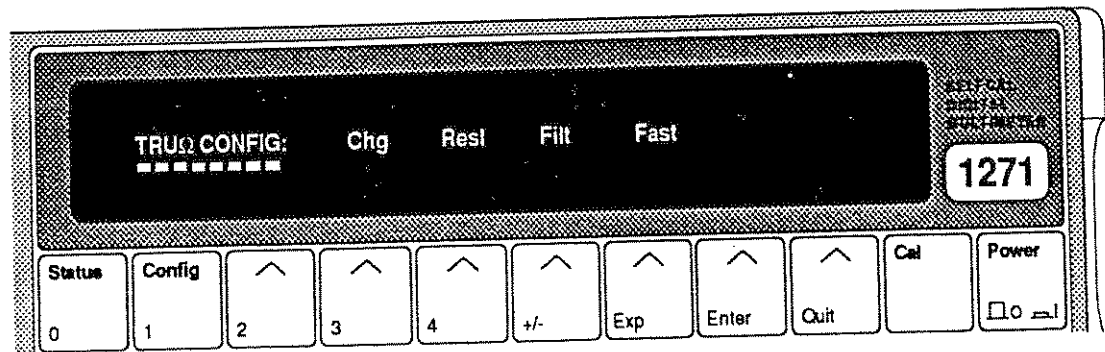

This menu defines the following keys:

Chg and Resl are *menu keys*, but Filt and Fast are *toggle keys*.

- Chg:** Displays the CHANGE menu, which gives the choice of selecting either the OHMS, HIΩ or TRUΩ menus, as described earlier.
- Resl:** Displays the TRUΩ RESL menu, where the resolution for the reading can be selected.
- Filt:** Selects a two pole analog filter for increased noise rejection. When selected, the Filt annunciator on the main display is lit. Filt is not selected at Power On.
- Fast:** Selects higher read rates at some increase in uncertainty due to noise. Fast is not selected at Power On.

Section 3 - Basic Measurements

TRU Ω Resolution



Press the Resl key to see the TRU Ω RESL menu:

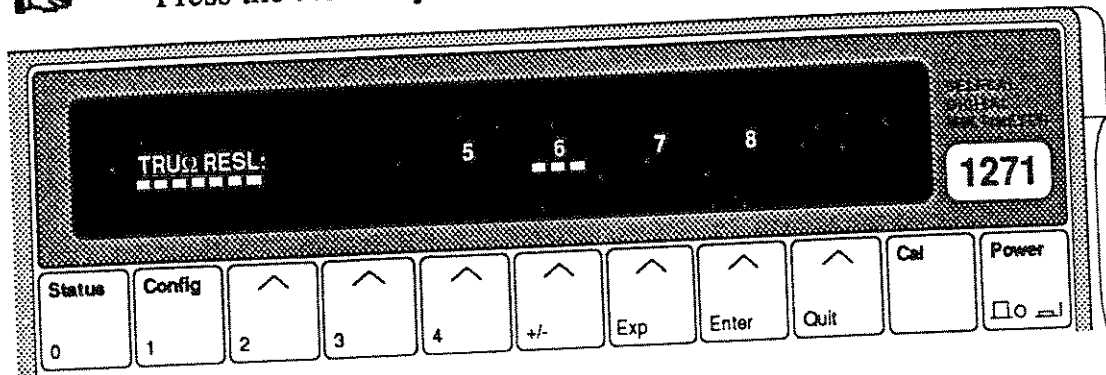

This menu defines the following *choice* keys:

- 5 5¹/₂ digits resolution
- 6 6¹/₂ digits resolution
- 7 7¹/₂ digits resolution
- 8 8¹/₂ digits resolution

This permits the choice of any resolution between 5¹/₂ and 8¹/₂ digits.
Power On setting is 6¹/₂ digits.



Transfer from the TRU Ω RESL menu back to the TRU Ω CONFIG menu by pressing the Config key.

CHANGE back to Ohms



Press the Chg key to see the CHANGE Ω menu:



Press the Ohms key to revert to the OHMS menu:

We have now moved through all the resistance menus, and back to the basic OHMS menu.

TRUΩ - Movement between Menus

Broken lines indicate use of hard keys

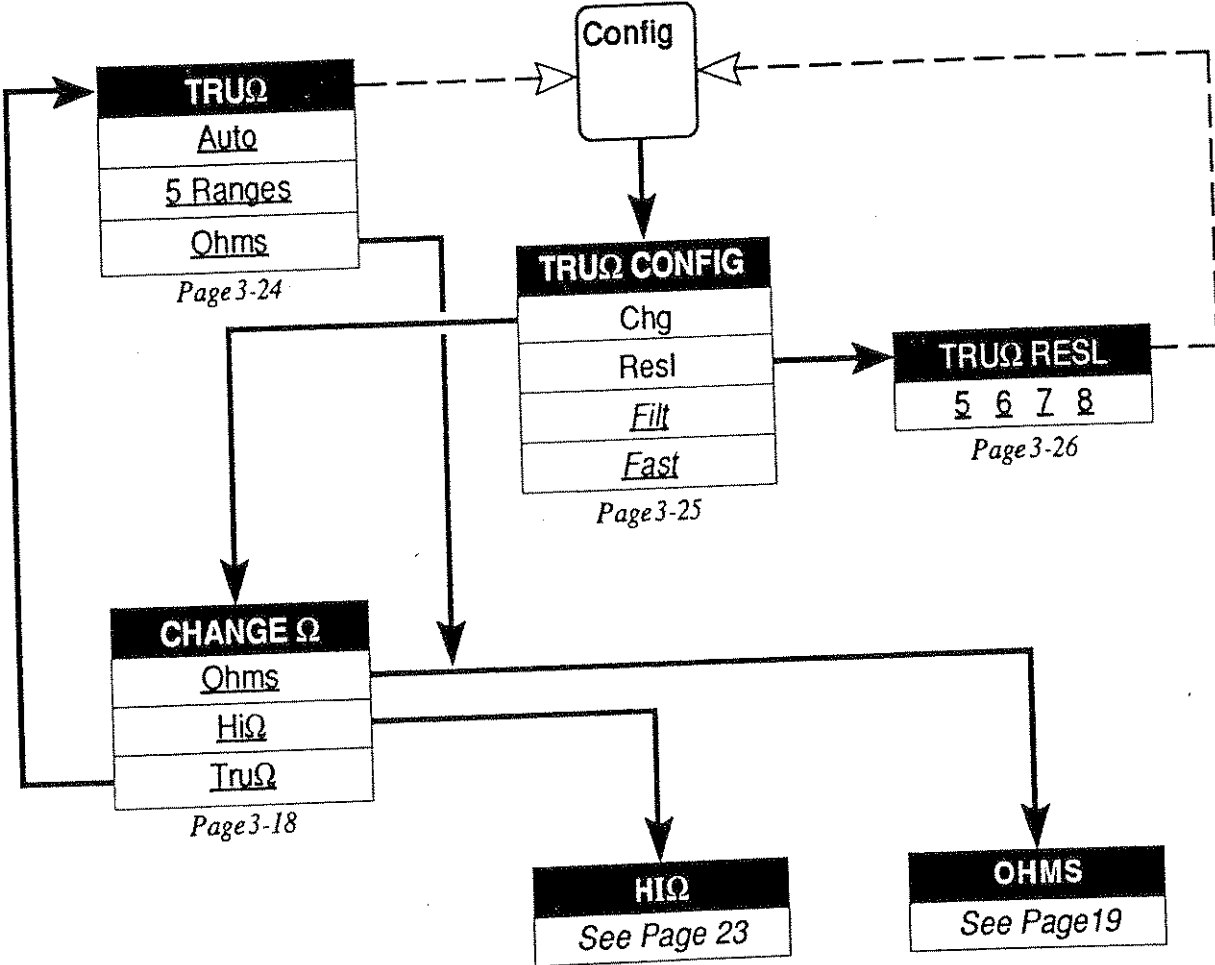

Section 3 - Basic Measurements

DC Current (Option 30 with Option 20)

 Press the DCI key to Transfer from OHMS to the DCI menu.

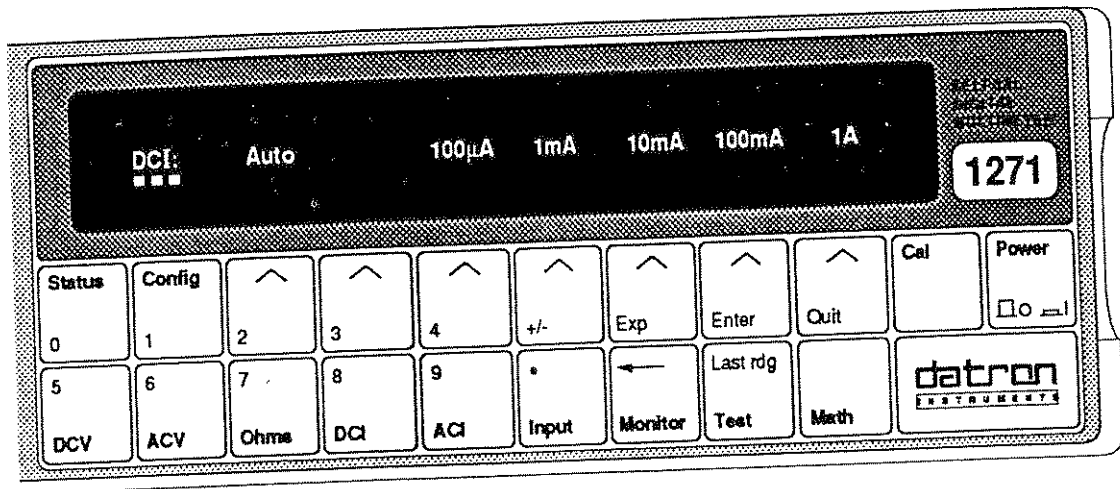

DCI Menu

This menu defines the following *choice* keys.

Auto The range it makes active also being underlined.
As well as being cancelled by any range selection, it can also be cancelled by re-pressing the Auto key (in this case it reverts to the auto-selected range).

Ranges: 100µA 1mA 10mA 100mA 1A

DCI Configuration

(Resolution, LP Filtering and Fast)

 Press the Config key to see the DCI CONFIG menu:

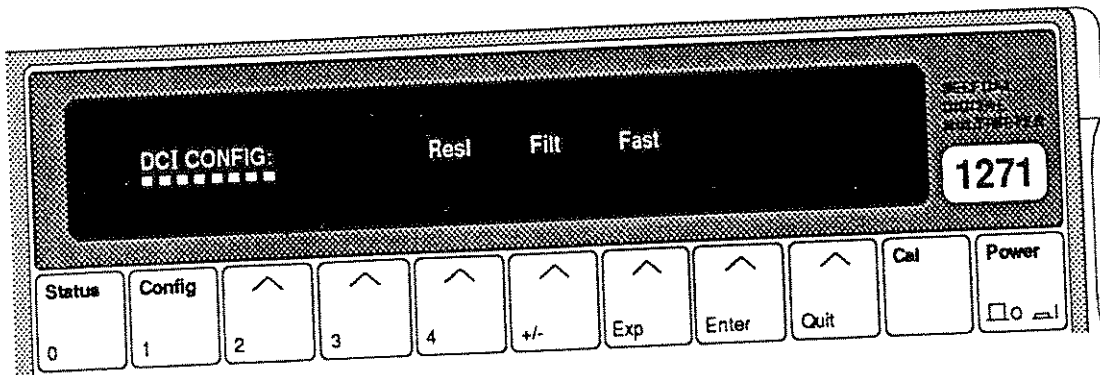

- Resl:** Displays the DCI RESL menu, where the resolution for the reading can be selected.
- Filt:** Selects a two pole analog filter for increased noise rejection. When selected, the Filt annunciator on the main display is lit. Filt is not selected at Power On.
- Fast:** Selects higher read rates at some increase in uncertainty due to noise. Fast is not selected at Power On.

Section 3 - Basic Measurements

DCI Resolution



Press the Resl key to see the DCI RESL menu:

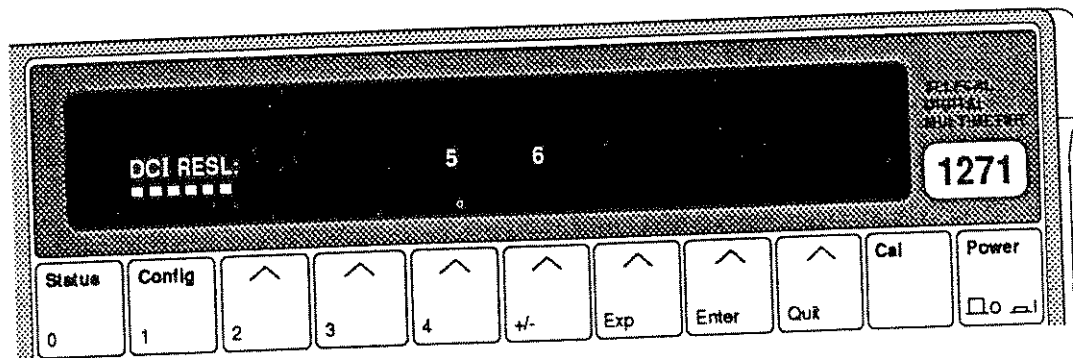

This menu defines the following *choice* keys:

- 5 5¹/₂ digits resolution
- 6 6¹/₂ digits resolution

As you can see, this permits the choice of any resolution between 5¹/₂ and 6¹/₂ digits. Power On setting is 6¹/₂ digits.

Transferring from the DCI RESL menu back to the DCI CONFIG menu is by pressing the Config key.

Transferring from either menu back to the DCI menu is by pressing the DCI key.

DC Current - Movement between Menus

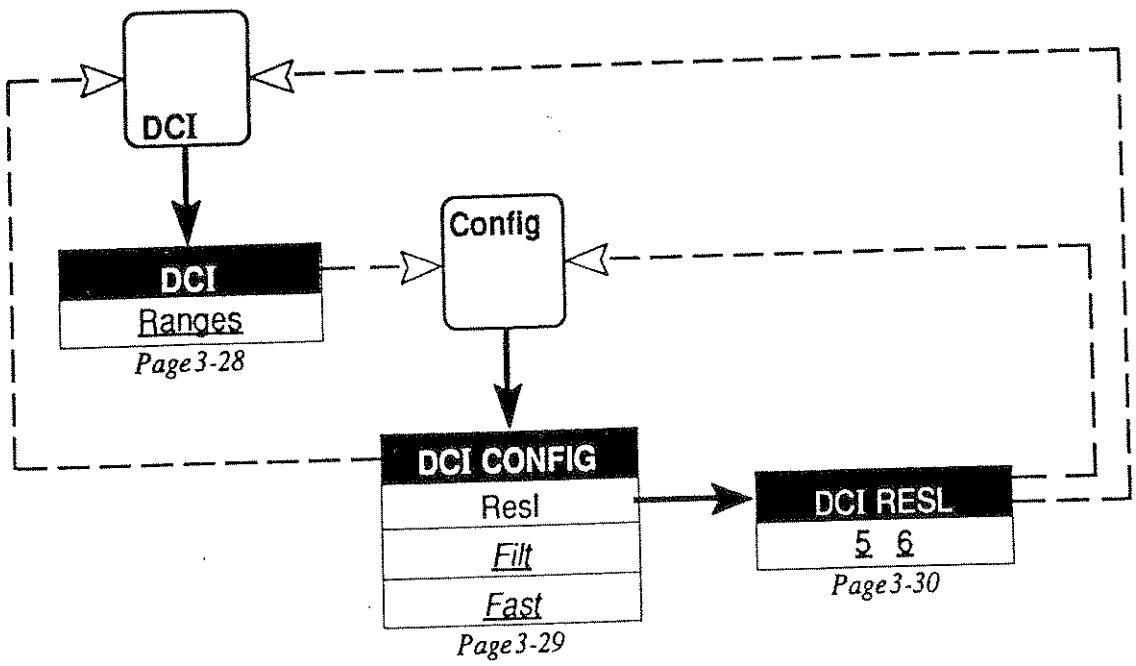

Broken lines indicate use of hard keys

AC Current (Option 30 with Options 10 or 12, and 20)



Press the ACI key to see the ACI menu:

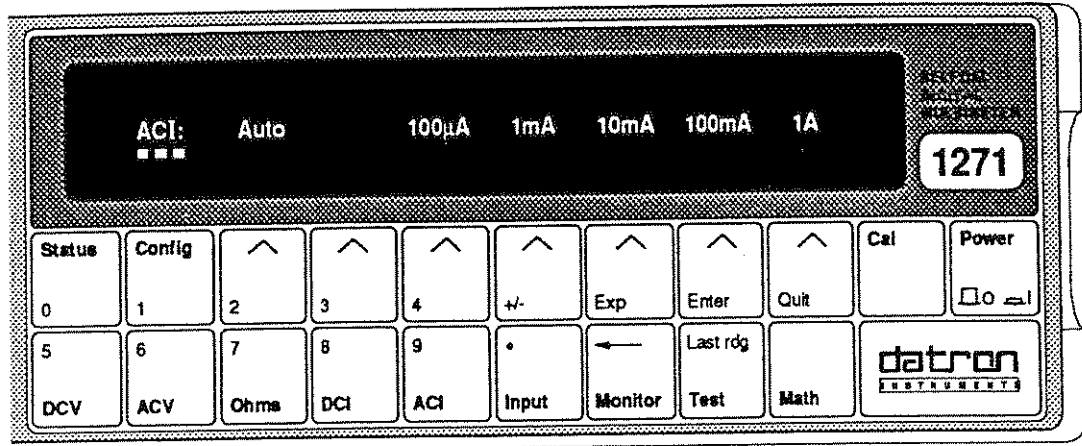

This menu defines the following *choice* keys.

Auto The range it makes active also being underlined.
As well as being cancelled by any range selection, it can also be cancelled by re-pressing the Auto key (in this case it reverts to the auto-selected range).

Ranges: 100µA 1mA 10mA 100mA 1A

ACI Configuration

(Resolution, LP Filtering and DC Coupled)



Press the Config key to see the ACI CONFIG menu:

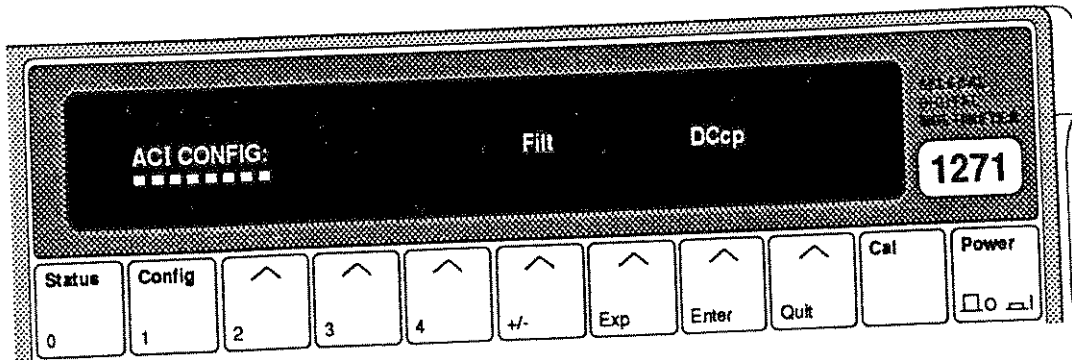

This menu defines the following keys.

Filt is a *menu* key, but DCcp is a *toggle* key.

- Filt:** Displays the ACI FILT menu, where the integration filter appropriate to the signal frequency can be selected.
- DCcp:** Selects DC coupled measurement configuration. We can therefore choose to measure either the RMS of a combined AC and DC current (DC Coupled - DCcp On), or just the RMS value of the AC component (AC Coupled - DCcp Off). DCcp **must** be selected for any input of frequency less than 40Hz. DCcp is not selected at Power On.

Section 3 - Basic Measurements

ACI Filter (Option 10)

 Press the Filt key to see the ACI FILT menu:

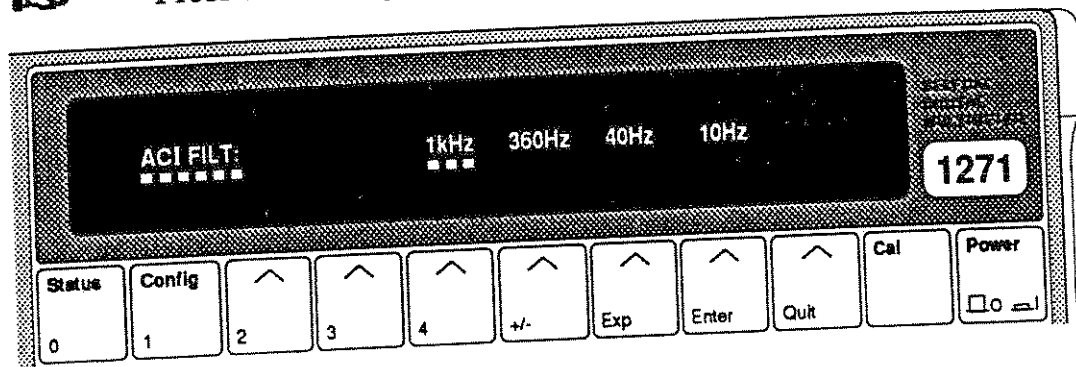

This menu permits any one of four integration filters to be used for the AC Current measurement. It defines the following *choice* keys, each selecting a filter with recommended lowest frequency as shown below and on the dot-matrix display:

1kHz, 360Hz, 40Hz and 10Hz

Power On setting is 1kHz.

ACI Filter (Option 12)



Press the Filt key to see the ACI FILT menu:

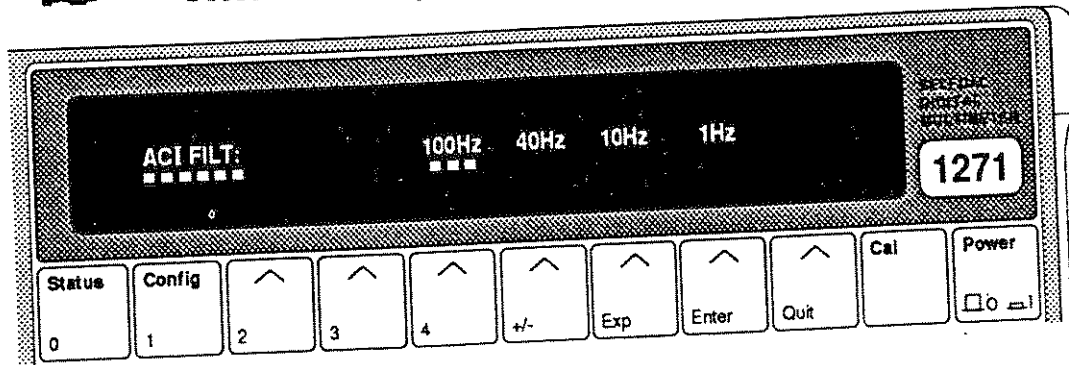

This menu permits any one of four integration filters to be used for the AC Current measurement. It defines the following *choice* keys, each selecting a filter with recommended lowest frequency as shown below and on the dot-matrix display:

100Hz, 40Hz, 10Hz and 1Hz

Power On setting is 100Hz.

AC Current - Movement between Menus

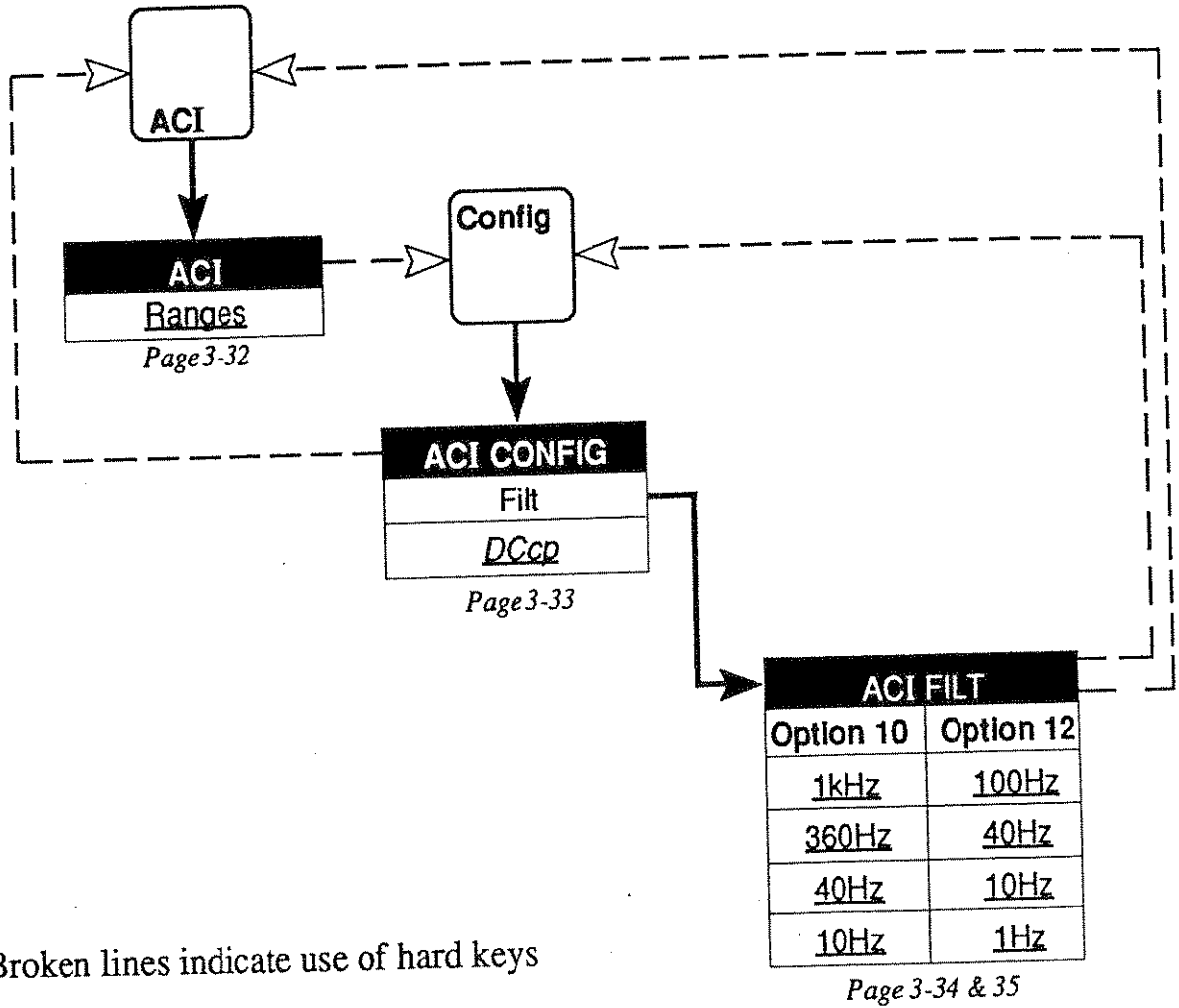

Broken lines indicate use of hard keys

'Input' and 'Status' Keys

So far in this section, we have concentrated on the menus of the keys which select the type of physical quantity to be measured - we call them the Main Function keys. With these, we can configure the functions so that basic measurements conform to our requirements. Obviously the instrument is capable of more sophisticated operation than just taking straightforward measurements.

These are discussed in subsequent sections, but there are two keys which are relevant to basic measurements.

Input Key

The Input key and its menu permit us to select any one of the three external connections into the multimeter. These are: the Front terminals; and the two input connectors on the back panel: Channel A and Channel B. The Input key also allows us to scan Channels A and B alternately, performing two simple calculations on the resulting readings:

A-B: the absolute difference between the two readings, is useful to compare an unknown signal at Channel A with a reference signal at Channel B.

A/B: the ratio between the two readings, permits such measurements as AC-to-DC transfers at speeds well in excess of those attainable by thermal transfer.

We can also combine the two calculations. With both selected, the result of the normalized 'deviation' calculation $((A-B)/B)$ is produced on the Main display.

Status Key

Using the Status key, we can review the instrument parameters which are currently set up, over and above those indicated by the annunciators on the main display.

In addition, the IEEE 488 bus address can be displayed and changed if required.

Section 3 - Basic Measurements

INPUT Menu



Press the Input key to see the INPUT menu:

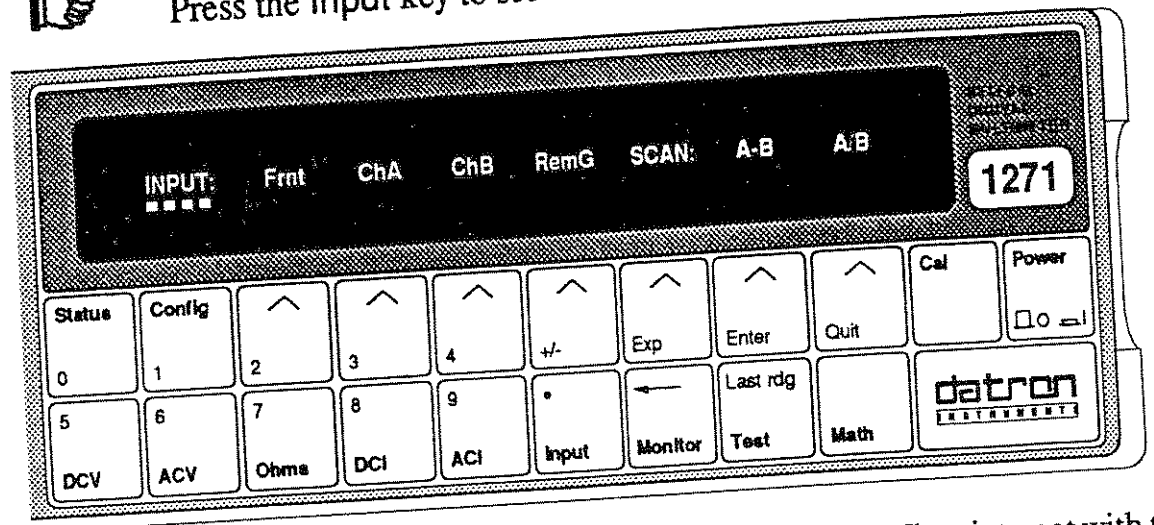

SCAN is a menu which defines only the two keys A-B and A/B. They interact with the other keys of the INPUT menu, so six soft keys are defined. When all six are unselected, an isolated-input state is defined. There is **no** INPUT CONFIG menu.

RemG is a straightforward *toggle* key. The other five interact (see the opposite page) but first here are their facilities:

- Frnt Activates Front Input terminals only.
- ChA Activates Rear Input Channel A only.
- ChB Activates Rear Input Channel B only.
- RemG This activates Remote Guard configuration, decoupling the internal guards from LO and connecting them to the Guard terminal. It can be applied to any of the other selections in the two menus. When selected the RemG annunciator on the main display is lit.
- A-B Activates the Rear Input Channels A and B. Readings are taken alternately from each channel; then the Channel B reading value is subtracted from the Channel A value to produce the measurement shown on the main display.

A/B Activates the Rear Input Channels A and B. Readings are taken alternately from each channel; then the Channel A reading value is divided by the Channel B value to produce the measurement shown on the main display.

A-B with A/B Activates the Rear Input Channels A and B. Readings are taken alternately from each channel; the Channel B value is subtracted from the Channel A value; then the Result is divided by the Channel B value to produce the measurement shown on the main display. This is the normalized 'deviation' value: $[(A - B) + B]$.

Power-On Input Default

Frnt (Front Input) is selected **On** at Power on. All other selections are **Off**.

Soft Keys - Interaction

Frnt, ChA and ChB act as *choice* keys, also cross-cancelling A-B and A/B. However; when one of these three inputs is selected, a second press will deselect it, as if its key were a *toggle* key.

A-B and A/B act as *toggle* keys, as a second press cancels and they can both be selected together. However; either will cross-cancel Frnt, ChA or ChB.

RemG is a normal *toggle* key.

Total Isolation State

All facilities on these two menus can be deselected, whereupon the DMM has no input. This state is useful in a remote control system, to isolate the DMM from the system's analog bus.

Instrument Status Reporting



Press the Status key to see the STATUS report:

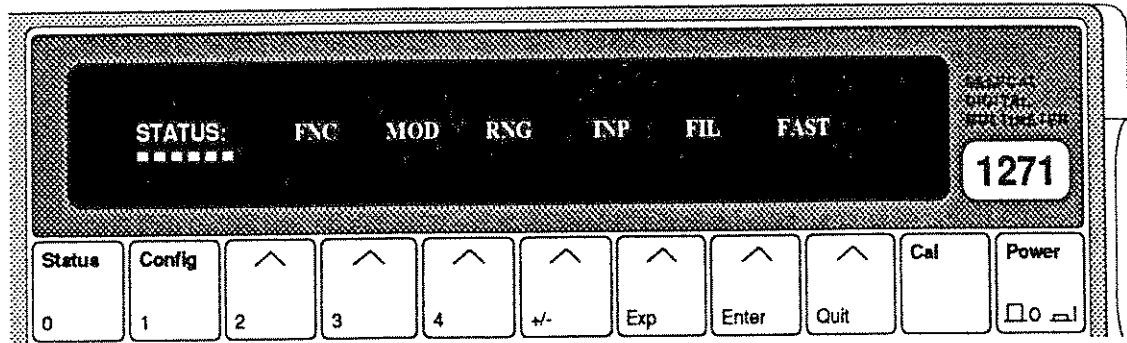

Status is a complete report of the most recent selections made using any of the various menus. It can be used at any time as a fast means of checking that the DMM selections are suitable for the measurement being made.

The legends shown in the above diagram do **not** actually appear, they only mark the approximate positions for legends which can appear. Each is an abbreviation which merely acts as a key to the list below. The meaning and possible parameters which appear in each position are given in the list:

Abbr. Meaning Possible Parameters

| | | |
|------|----------|---|
| FNC | Function | DCV, ACV, OHMS, TRUΩ, HIΩ, DCI, ACI, SPOTF. |
| MOD | Modifier | DCcp, LoI. |
| RNG | Range | Auto; 100mV, 1V, 10V, 100V, 1kV; 10Ω, 100Ω, 1kΩ, 10kΩ, 100kΩ, 1MΩ, 10MΩ, 100MΩ, 1GΩ; 100μA, 1mA, 10mA, 100mA, 1A. |
| INP | Input | Frnt, ChA, ChB, Open, A-B, A/B, Devn. |
| FIL | Filter | 1kHz, 360Hz, 100Hz, 40Hz, 10Hz, 1Hz. |
| FAST | Fast | Fast. |

Status Configuration

(IEEE 488 Bus Address, Power Line Frequency, Serial Number/Software Issue)



Press the Config key to see the STATUS CONFIG menu:

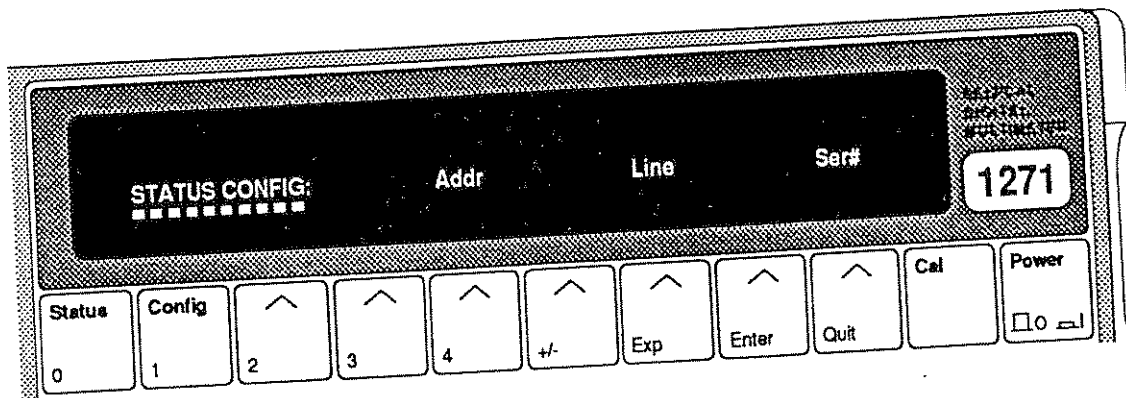

This is a menu, defining the following *menu* keys.

- Addr: displays the ADDRESS menu, to review and change the IEEE-488 bus address of the instrument.
- Line: displays the LINE menu, to review the power line frequency setting for the instrument.
- Ser#: displays the SER# menu, to review the serial number and software issue of the instrument.

Section 3 - Basic Measurements

IEEE 488 ADDRESS



Press the Addr key to see the IEEE 488 ADDRESS:

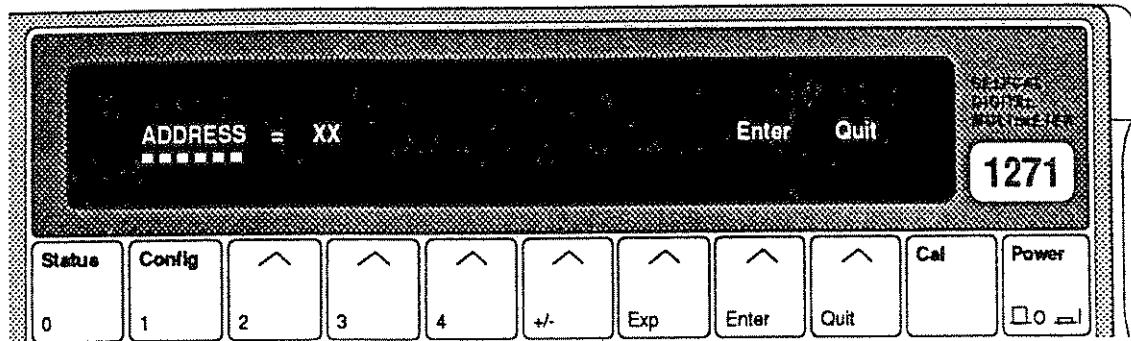

This menu permits entry of a value to be used as an IEEE-488 bus address.

Initially, the menu displays the present address value, and the numeric-keyboard keys are activated. Any valid numeric value (0-30) may be entered.

Pressing Enter stores the new value (or restores the old value if unchanged), but pressing Quit leaves the old value intact.

Either Enter or Quit causes exit back to the STATUS CONFIG menu.



Transfer from the ADDRESS menu back to the STATUS CONFIG menu by pressing the Config key.

LINE Frequency



Press the Line key to see the LINE frequency:

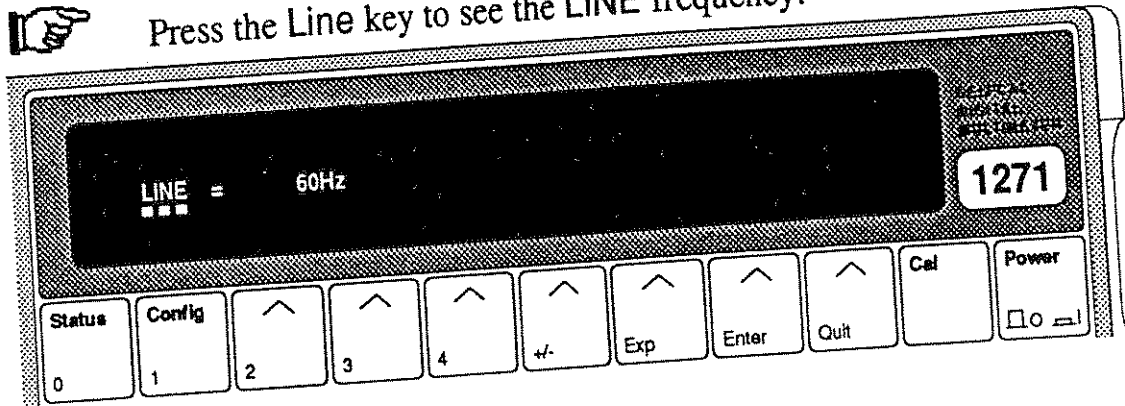

This displays the power-line frequency to which the instrument has been adapted. Only two settings are possible: 50Hz or 60Hz. The adaptation cannot be altered except in one of the calibration menus. Once adapted, the setting is not lost when the instrument power is turned off.

Section 3 - Basic Measurements

SER# Display



Press the Ser# soft key to see the SER# display.

Inspect the instrument serial number and software issue number (the latter is given by the last four digits).

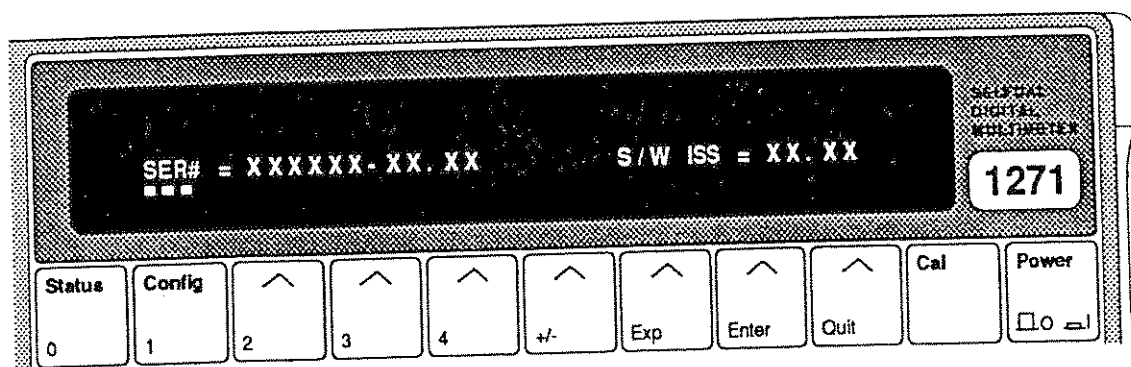

This display is for information only. The serial number cannot be altered except in one of the calibration menus, and this facility is only provided for use during manufacture. Once changed, the number is not lost when the instrument power is turned off. The software issue number (last four digits) is embedded in the software itself, and is not user-alterable.

Status Reporting - Movement between Menus

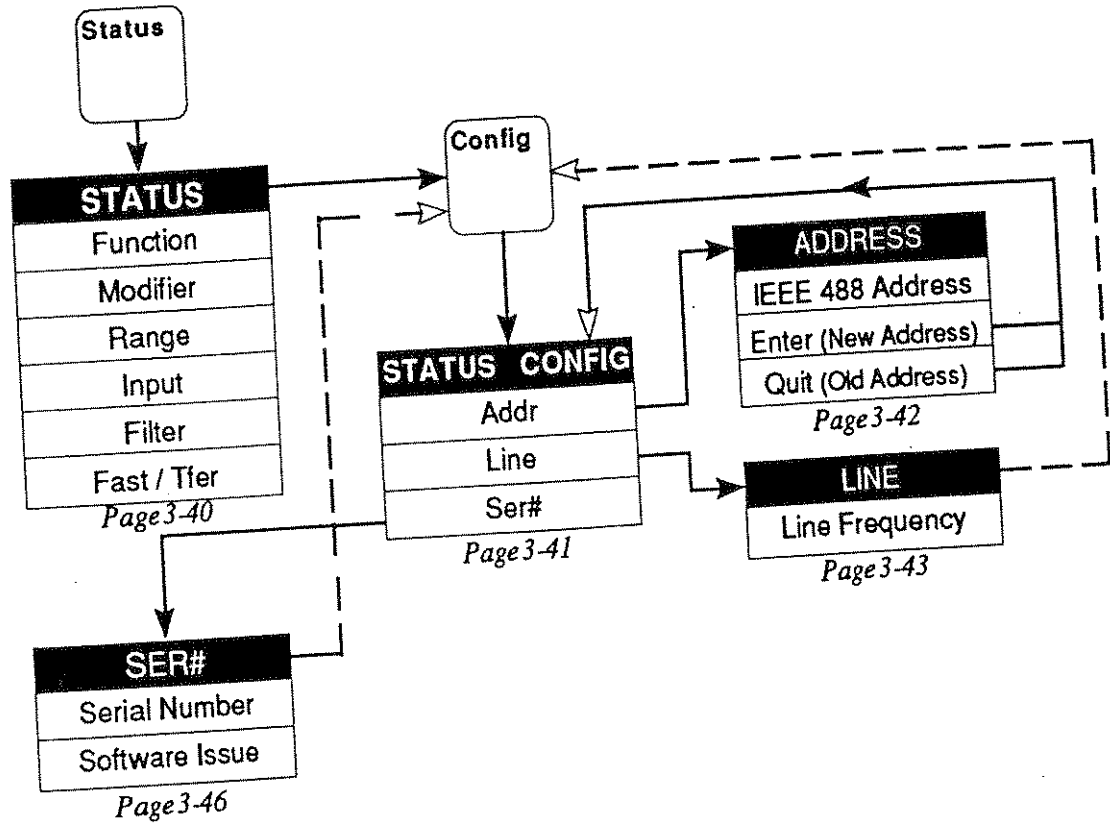

Conclusion

We have now come to the end of our introductory tour of the main menu keys. This is, however, far from the end of the instrument's facilities. Now you are more familiar with the operation of the front panel, it is not necessary to continue in the same sort of programmed way.

You will find that the information in Part 2 is presented in a more concise and accessible form than here in Section 3. Your familiarity with the instrument will allow you to progress rapidly to the facilities you wish to investigate.

In Part 2, Section 4 deals with the manual selection of the facilities not covered here, and Section 5 is devoted to the operation of the instrument via the IEEE 488 Interface.

PART 2

Operation of the 1271

Section 4 Using the 1271

**Section 5 Systems Application via the IEEE 488
Interface**



DANGER
HIGH VOLTAGE



**THIS INSTRUMENT IS CAPABLE
OF DELIVERING
A LETHAL ELECTRIC SHOCK !
when connected to a high voltage source**

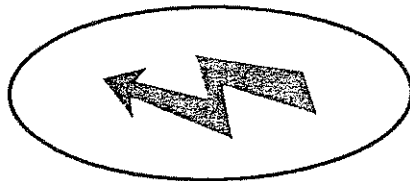

FRONT or REAR terminals
carry the Full Input Voltage
THIS CAN KILL !

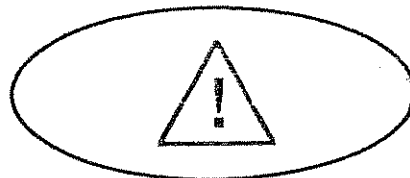

Guard terminal is sensitive
to over-voltage
**It can damage
your instrument !**

Unless **you** are **sure** that it is **safe** to do so,
DO NOT TOUCH
the **I+ I- Hi or Lo leads and terminals**

DANGER

SECTION 4 Using the 1271

| | |
|--|------|
| Preliminaries | 4-1 |
| Safety | 4-1 |
| Interconnections - General Guidelines | 4-2 |
| Functions | 4-4 |
| DC Voltage | 4-8 |
| AC Voltage (Options 10 & 12) | 4-11 |
| Resistance (Option 20) | 4-17 |
| DC Current (Option 30 with Option 20) | 4-19 |
| AC Current (Option 30 with Options 10 or 12, and 20) | 4-19 |
| Facilities | 4-21 |
| Input Control | 4-22 |
| Status Reporting | 4-23 |
| Monitoring | 4-30 |
| Test | 4-32 |
| Math | 4-40 |
| Calibration | |
| See Index on page 4-40 | |
| Direct Action Keys | 4-61 |
| Keys | 4-62 |
| SK8 - Input/Output Port | 4-64 |
| Numeric Keyboard | |
| Appendix A: Error Detection and Messages | 4-A1 |

SECTION 4

Using the 1271

Preliminaries

This section details the methods of using the instrument, divided so as to provide an easy reference for particular functions and facilities. The divisions are as follows:

Functions

DC Voltage,
AC Voltage,
Resistance,
DC Current,
AC Current

Facilities

Input Control,
Status Reporting,
Monitoring,
Math, Test,
Calibration

The descriptions include: methods of connection, input limits, types of configurations, methods of access to facilities, and calculations available.

Where appropriate, examples of procedures are given in a format similar to that used in Section 3. Although the menus for external and self calibration are shown, all routine calibration should be referred to Section 8; or Section 1 of the Calibration and Servicing Handbook.

Installation

Before using the instrument, it is important that it has been correctly installed as detailed in Section 2.

Limiting Characteristics

Maximum inputs are detailed in Section 6.

Safety

The 1271 is designed to be Class 1 equipment as defined in IEC Publication 348, and meets the safety requirements of UL 1244, ANSI C39.5 (Draft 5) and BSI 4743. Protection is provided by a direct connection via the power cable from ground to exposed metal parts and internal ground screens. The power cable line connection must only be inserted in a socket outlet provided with a protective ground contact, and continuity of the ground conductor must be assured between the socket and the instrument.

WARNING:

Any interruption of the protective ground conductor inside or outside the instrument, or disconnection of the protective ground terminal may make the apparatus dangerous. Intentional interruption is prohibited. The terminals marked with the  symbol carry the input to the 1271. These terminals and any other connections to the source under test could carry lethal voltages. Under no circumstance should users touch any of the front or rear panel terminals unless they are first satisfied that no dangerous voltage is present.

CAUTION:

The  symbol is used to remind users of special precautions detailed in this handbook, and is placed next to terminals that are sensitive to overvoltage conditions.

Interconnections - General Guidelines

Importance of Correct Connections

When calibrated, the 1271 is capable of providing highly accurate traceable measurements. To attain this, it is necessary to make connection to any

external circuitry or load, correctly. A few general guidelines for correct external connection are given in the following paragraphs.

Sources of Error

Thermal EMFs

These can give rise to series (Normal) mode interference, particularly where large currents have a heating effect at junctions. In otherwise thermoelectrically-balanced measuring circuits, cooling caused by draughts can upset the balance.

The disturbances can be magnified by the user's hand capacitance. Electrical interference has greatest effect in high impedance circuits. Separation of leads and creation of loops in the circuit can intensify the disturbances.

E-M Interference

Noisy or intense electric, magnetic and electromagnetic effects in the vicinity can disturb the measurement circuit. Some typical sources are:

- Proximity of large static electric fields.
- Fluorescent lighting.
- Inadequate screening, filtering or grounding of power lines.
- Transients from local switching.
- Induction and radiation fields of local E-M transmitters.
- Excessive common mode voltages between source and load.

Lead Resistance

The resistance of the connecting leads can drop significant voltages between the source and load, especially at high load currents.

Lead Insulation Leakage

This can cause significant errors in measurement circuits at high voltages. Some insulating materials suffer greater losses than others, e.g. PVC has more leakage than PTFE.

Avoidance Tactics

Thermal EMFs:

- Screen thermal junctions from draughts.
- Allow time for thermal equilibrium to be reached before taking readings.
- Use conductors, joints and terminals with a good margin of current-carrying capacity.
- Avoid thermoelectric junctions where possible:
 - Use untinned single-strand copper wire of high purity.
 - Avoid making connections through Nickel, Tin, Brass and Aluminium. If oxidation is a problem use gold-plated copper terminals, and replace the terminals before the plating wears off.
 - If joints must be soldered, low-thermal solders are available, but crimped joints are preferred.
 - Use low-thermal switches and relays where they form part of the measuring circuit.
 - Balance one thermal EMF against another in opposition, where possible. (Switch and relay contacts, terminals etc.)

E-M Interference:

- Choose as "quiet" a site as possible (a screened cage may be necessary if interference is heavy). Suppress as many sources as possible.
- Always keep interconnecting leads as short as possible, especially unscreened lengths.
- Run leads together as twisted pairs in a common screen to reduce loop pick-up area, but beware of leakage problems and excessive capacitance.
- Where both source and load are floating, connect Lo to ground at the source to reduce common mode voltages.

Lead Resistance:

- Keep all leads as short as possible.
- Use conductors with a good margin of current-carrying capacity.
- Use Remote Guard or 4-wire connections where necessary.

Lead Insulation Leakage:

Choose low loss insulated leads - PTFE is preferred to PVC. When running leads together in screened pairs, avoid large voltages between leads in the same screen, especially if using PVC insulation.

Functions

Measurement of DC Voltage

Generalized Procedure

DCV Key and Menus

A description of the User Interface is given in Section 3 for the main functions. If you are unfamiliar with the front panel controls, you should complete the quick tour which starts on Page 3-5. Specific reference to DC Voltage measurement

appears on Pages 3-5 to 3-9. If you are familiar with the controls, but need a reminder of the way a particular facility can be selected; movement among the DCV group of menus is described by the following diagram:

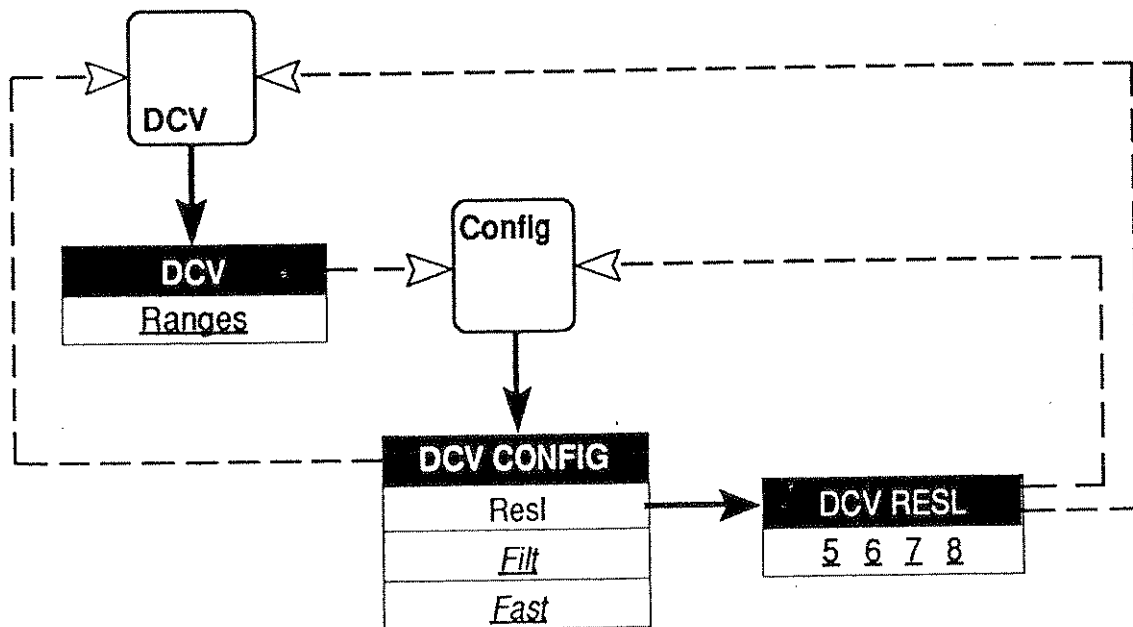

Setup Sequence

The sequence of operations below is arranged to configure a DC voltage measurement rapidly from the power on default state. In general, it is quicker to use toggle or choice soft keys on one menu before selecting another menu key.

Obviously, once the instrument has been set up to one configuration, that becomes the starting point.

- Press the DCV key - the power-on default range state is shown on the DCV menu.



- Select a range or Auto, as required.
- Press the Config key.
- Choose Filt and/or Fast, if required.



- Press the Resl key if you wish to change the resolution of the Main display.



The display changes to DCV RESL menu showing '6', the power-on default state.

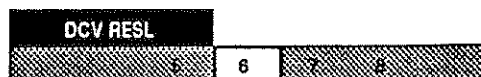

- Press the soft key for the required resolution.

Input Connections

Simple Lead Connection

For the majority of applications the simple lead connection shown (without selecting remote guard) will be adequate. The disadvantage of this simple arrangement is that the connecting leads form a loop. If a stray alternating magnetic field (e.g. from the line transformer of a neighbouring instrument) passes through the loop, it will behave as a single turn secondary winding inducing unwanted AC voltages into the measuring circuit.

Use of a twisted pair will reduce the loop area and adjacent twists will cancel any induced voltages. If problems with stray pick-up are encountered, it is recommended that a screened twisted-pair cable be used with the screen connected to the LO terminal.

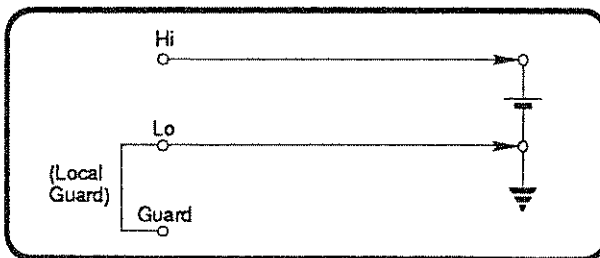

Common Mode Rejection - Use of Remote Guard Connection

The Guard terminal should be used with Remote Guard selected when the source to be measured presents an unbalanced impedance to the measuring terminals, and common mode voltages are present. Regardless of how the Hi and Lo terminals are connected, the Guard terminal should be referred to the source of common mode voltage, as shown in the examples below. This ensures that errors caused by common mode currents in the measuring circuit are minimized by providing a separate common mode current path.

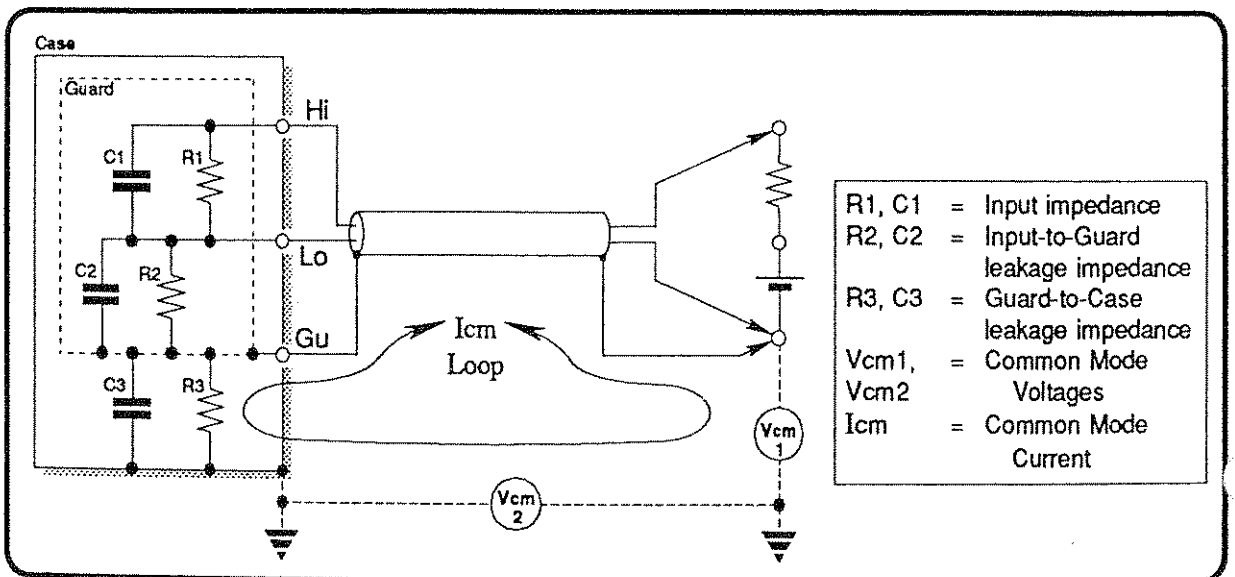
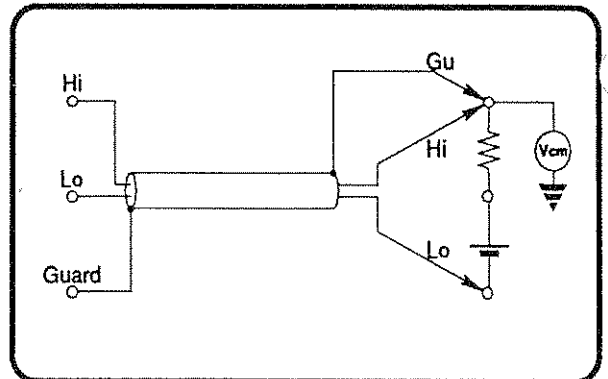

Internal Guard Connections

Remote Guard not selected: All Guard inputs are internally connected to Lo. This includes the Guard terminal on the front panel and pin 19 of each of the two rear input plugs, as connected using the Input menu.

Remote Guard selected: The shields and tracks are disconnected from Lo and connected to the Guard terminal, or pin 19 of one or both of the rear input plugs, whichever combination is in use.

The simplified diagram below illustrates the switching arrangement:

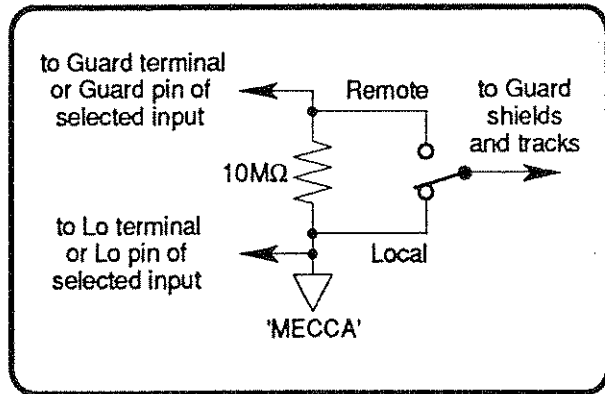

Selection of Remote Guard (RemG)

To switch to Remote Guard, we enter the INPUT menu:

- Press the Input key. The INPUT menu is displayed:



- Press the soft key under RemG on the menu display to set the instrument into Remote Guard.



The key acts as a toggle, so a second press deselects RemG, reverting to Local Guard.

Measurement of AC Voltage (Options 10 & 12)

Generalized Procedure

ACV Key and Menus

A description of the User Interface is given in Section 3 for the main functions. If you are unfamiliar with the front panel controls, you should complete the quick tour which starts on Page 3-5. Specific reference to AC Voltage measurement appears on Pages 3-10 to 3-14. If you are familiar with the controls, but need a reminder of the way a particular facility can be selected; movement among the ACV group of menus is described by the following diagram:

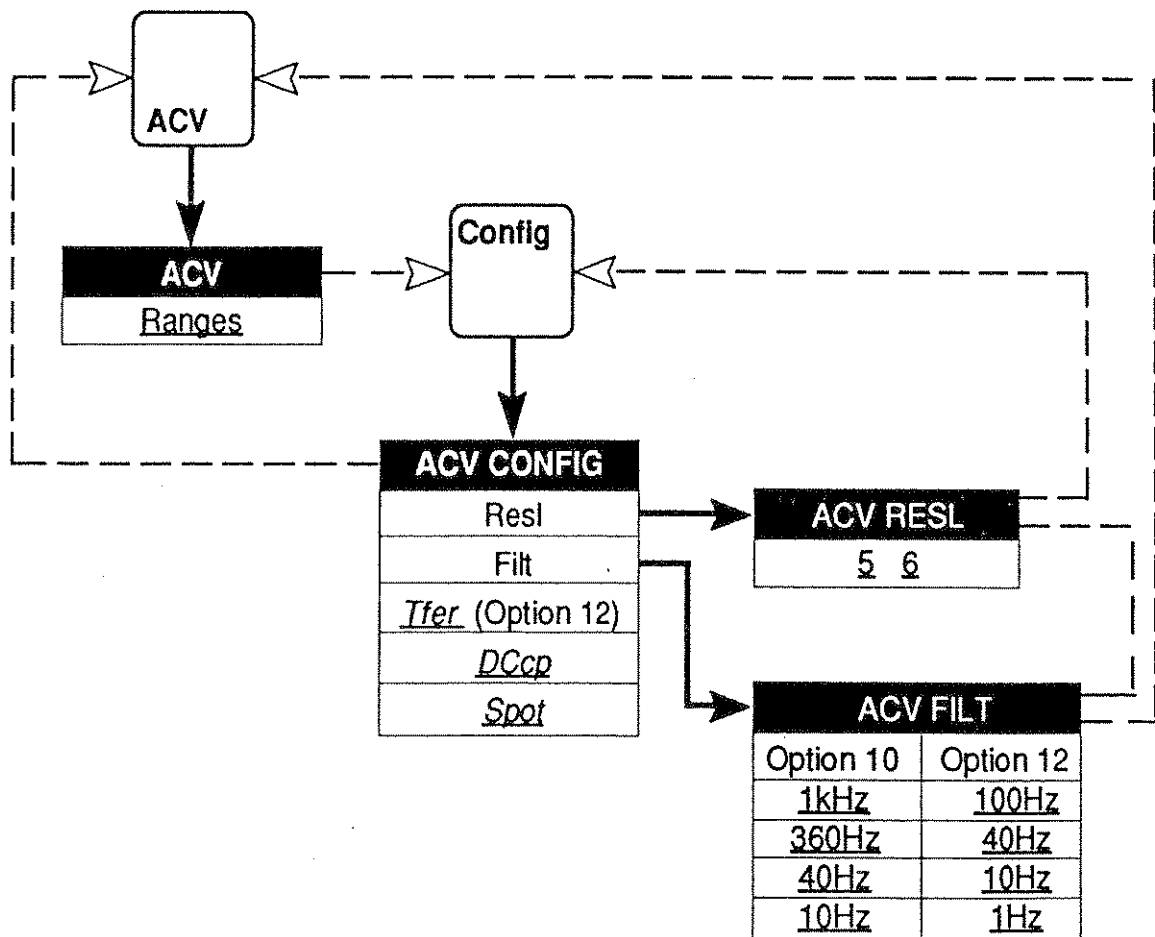

Setup Sequence

The following sequence of operations is arranged so as to configure an AC voltage measurement rapidly from the power on default state. In general, it is quicker to use toggle or choice soft keys on one menu before selecting another menu key.

Obviously, once the instrument has been set up to one configuration, that is the starting point.

- Press the ACV key - the power-on default range state is shown on the ACV menu.



- Choose a range or Auto, as required.
- Press the Config key - Tfer is already selected. (Option 12 only)



- Deselect Tfer if not required. Select DCcp if required.
- DCcp must be selected for input frequencies less than 40Hz

To Alter the Main Display Resolution:

- Press the Resl key.



The display changes to ACV RESL menu showing '6', the power-on default state.

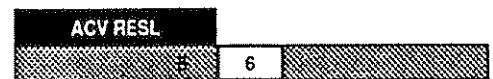

- Press one soft key to choose the required resolution.

To Alter the Filter Frequency:

- Press the Config key.
- Press the Fil key.



The display changes to ACV FILT menu showing '1kHz' (Option 10) or '100Hz' (Option 12), the power-on default state.

Option 10



Option 12



- Press one soft key to choose the required filter frequency.

Input Connections

Lead Capacitance

Whereas for DC voltage measurement the resistance of the connecting lead is generally unimportant; with AC voltage measurement the capacitance can give rise to an appreciable shunting effect, causing source loading as well as voltage drop in the leads. In the Datron 1501 Lead Kit, the approximate Hi and Lo capacitance of the low thermal emf lead with spade terminals is 65pF; for other leads it is 160pF. In extreme cases, using separate leads can reduce capacitance (dependent upon spacing but typically 4pF) but at the risk of adding induced signals.

Induced Interference

With DC measurement, any induced (normal or 'series' mode) component can usually be removed by low-pass filtering. But with AC measurement, the relative frequencies of both the required and induced signals carry more significance, as any filtering must be selective to avoid degrading the required signal. It is generally more effective to reduce the interference before it is induced, by operating in a quiet environment, e.g a screened cage, if possible.

Common Mode Rejection

The principles of remote guarding, outlined in the description of DC voltage measurement, apply generally to AC voltage measurement. But for AC, a further advantage can be gained by using the remote guard as a screen for the input leads, if the source impedance is low enough not to be shunted by the extra capacitance.

Lead Length

In all cases, AC voltage measurement accuracy is enhanced by shortening the leads to the minimum practicable length, to reduce lead capacitance and loop area.

Lead Impedances

The table below gives the approximate impedances of the leads in the kit at different frequencies:

| Frequency | Impedance for lead capacitance = | | |
|-----------|----------------------------------|---------------|---------------|
| | 4pF | 65pF | 160pF |
| 100Hz | 400M Ω | 20M Ω | 10M Ω |
| 1kHz | 40M Ω | 2M Ω | 1M Ω |
| 10kHz | 4M Ω | 200k Ω | 100k Ω |
| 100kHz | 400k Ω | 20k Ω | 10k Ω |
| 1MHz | 40k Ω | 2k Ω | 1k Ω |

Measurement of Resistance

Ohms Key and Menus

A description of the User Interface is given in Section 3 for the main functions. If you are unfamiliar with the front panel controls, you should complete the quick tour which starts on Page 3-5. Specific reference to Resistance measurement appears on Pages 3-15 to 3-27. If you need a reminder of the way a particular facility can be

selected; movement among the Ohms group of menus is described by the diagram below.

Note: Once activated, a resistance mode (normal Ohms, TruΩ or HiΩ) stays active until it is changed, or the instrument power is removed. Thus the Ohms key always selects the active mode's title menu; and the Config key selects the active CONFIG menu.

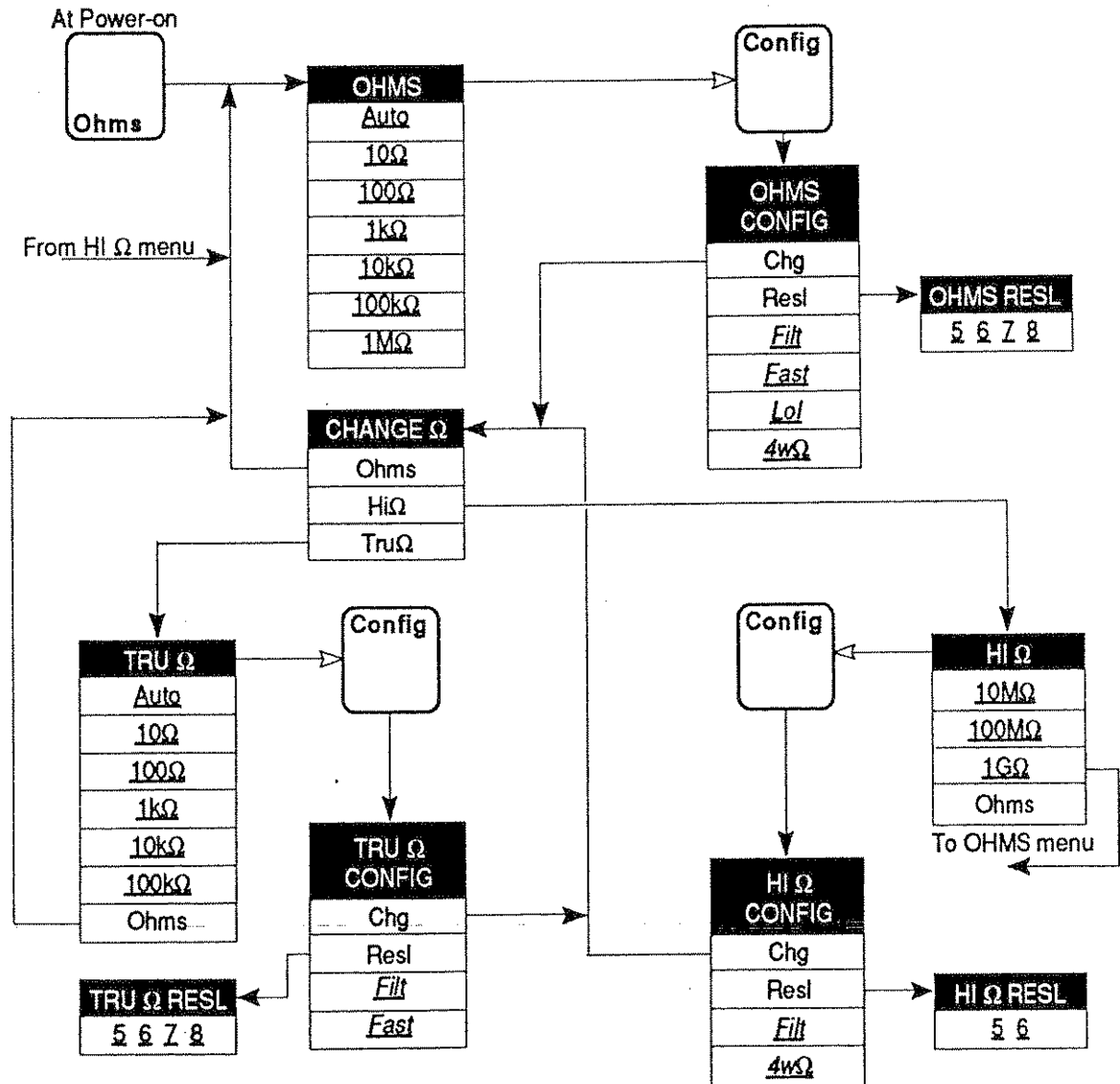

Setup Sequence

The following three sequences of operations are arranged so as to configure a Resistance measurement rapidly from the power on default state. In general, it is quicker to use toggle or choice soft keys on one menu before selecting another menu key. Obviously, once the instrument has been set up to one configuration, that is the starting point.

Three modes are available for resistance measurements: normal Ohms; Hi Ω for the two highest ranges; or Tru Ω in which two successive readings are taken (the second with no activation current flowing, being subtracted from the first to cancel thermal EMFs in the measuring circuit). Each of these has different ranges and facilities available, hence each also has its own Config menu.

First decide which mode to use, then choose the applicable setup sequence from the following three.

To operate in normal Ohms mode

- Press the Ohms key - the power-on default range state (1k Ω) is shown on the OHMS menu.



- Choose a range or Auto, as required.
- Press the Config key.



- Select any of Filt, Fast, LoI and/or 4w Ω , if required.

To Alter the Main Display Resolution:

- Press the Resl key.



The display changes to OHMS RESL menu showing '6', the power-on default state.



- Press one soft key to choose the required resolution.

To operate in Hi Ω mode

- Press the Ohms key - the power-on default range state (1k Ω) is shown on the OHMS menu.



- Press the Config key.
- Select Chg.



The display changes to the CHANGE Ω menu.

- Press the Hi Ω soft key.



- Select the required higher range.



Functions - Resistance

- Press the Config key.
- Select Filt and/or 4wΩ, if required.



To Alter the Main Display Resolution:

- Press the Resl key.



The display changes to HIΩ RESL menu showing '6', the power-on default state.

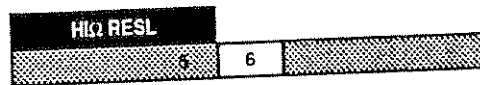

- Press one soft key to choose the required resolution.

To operate in TruΩ mode

- Press the Ohms key - the power-on default state (1kΩ) is shown on the OHMS menu.



- Press the Config key.
- Select Chg.



- Press the TruΩ soft key.

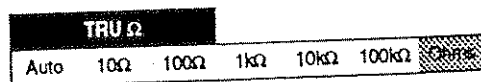

- Choose a range or Auto, as required.
- Press the Config key.
- Select Filt or Fast, (or both) if required.



To Alter the Main Display Resolution:

- Press the Resl key.



The display changes to TruΩ RESL menu showing '6', the power-on default state.

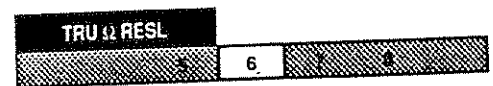

- Press one soft key to choose the required resolution.

Subsequent Reselection of 'Ohms' and 'Config' keys

If after operating in either HiΩ or TruΩ mode, a measurement is carried out in another (non-Resistance) function; then if the instrument has not meanwhile been powered off, it will reactivate the previously-selected HiΩ or TruΩ when the Ohms key is next pressed. Moreover, once the mode is activated pressing the Config key will show the mode to be configured as before.

Reverting to normal Ohms mode

When operating in HiΩ or TruΩ, pressing the Ohms hard key does not revert to normal Ohms mode. But each has 'Ohms' as a selection on its Config menu. By first pressing the Config key then selecting Ohms from the Config menu, it is unnecessary to pass through the Chg menu to reactivate the normal Ohms mode.

External Connections

2-Wire Measurements

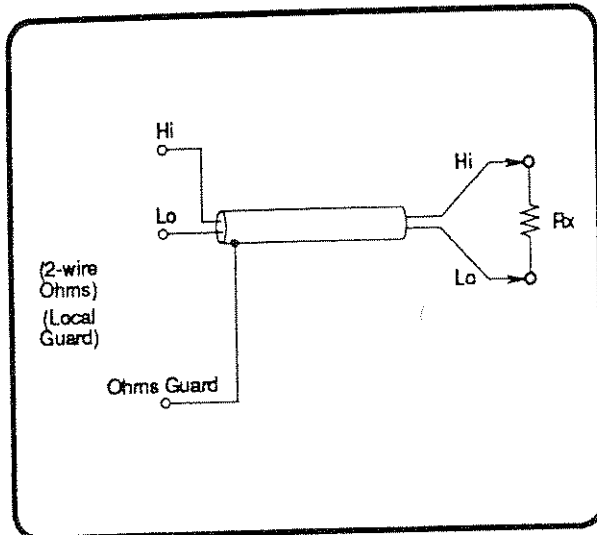

4-wire Measurements

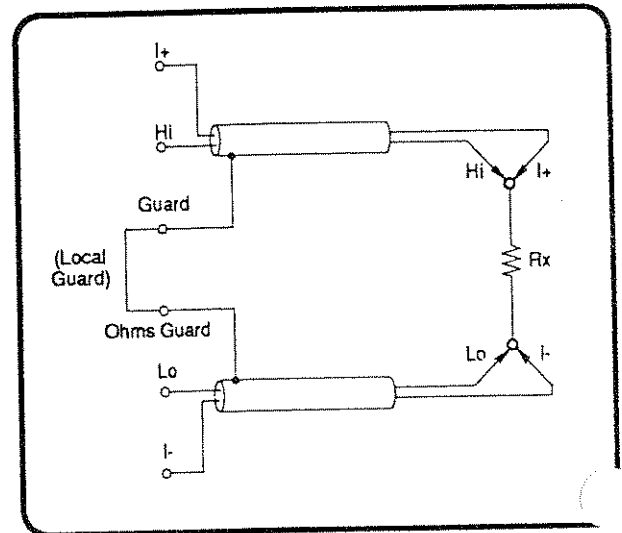

For the majority of applications the simple 2-wire arrangement will be adequate. However, the value displayed will include the resistance of the connecting leads.

Use a screened twisted pair cable to reduce induced voltages, particularly where R_x is high.

2-wire resistance measurements are not available when in Tru Ω mode.

With a 4-wire connection the lead resistances have negligible effect and only the value of R_x is displayed. The 4-wire connection, as shown above, is also suitable for measuring high resistances with long cables since the effects of leakage and capacitance between leads are eliminated.

4-wire High Resistance Measurements

True 4-wire Zero

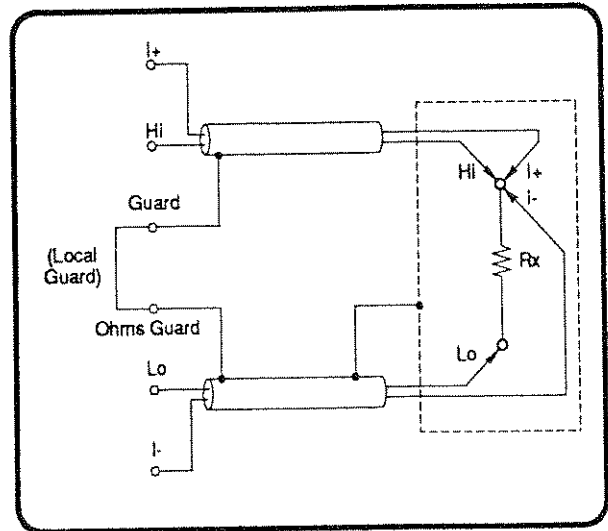
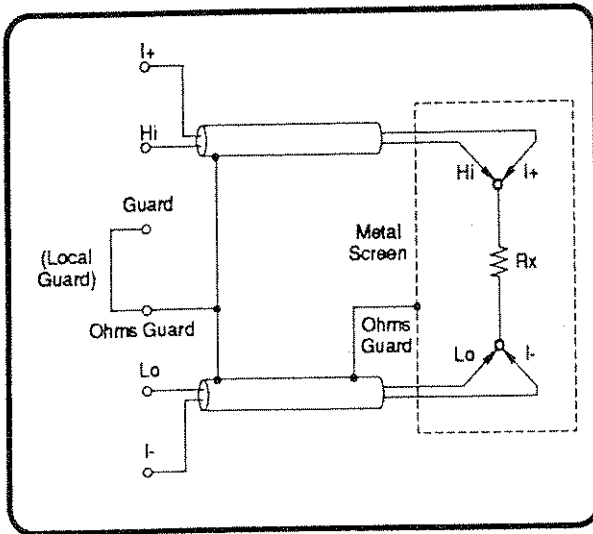

When making very high resistance measurements above about $1\text{M}\Omega$, a metal screen can be wrapped around the resistor to reduce noise. Connecting the Ω Guard terminal to the screen (in parallel with the unknown resistor). The resistor under test should not be grounded, as this will make the measurement noisier.

For accurate measurements of resistance it is **Essential** that a correctly connected zero source be used when operating the ZERO key before making a series of measurements. The preferred arrangement, shown above, ensures that thermal and induced EMF effects, and bias current effects, are eliminated.

Ω Guard

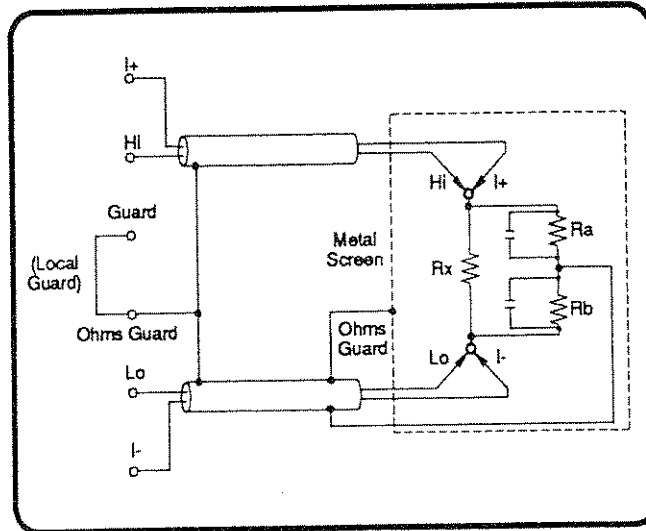

' Ω Guard' can be used to make 'in-circuit' resistance measurements by guarding out parallel resistance paths so that only the value of R_x will be displayed.

Deviation fraction 'E' can be found within 1% by the simplified formula:

$$E = \frac{(R_d \cdot R_g)}{(R_a \cdot R_b)}$$

Similarly, ' Ω Guard' can be used to reduce the settling time if R_x is shunted by any capacitance and a suitable tapping point is available.

(Where R_g is the Ω Guard lead-resistance from the junction of R_a and R_b)

Example:

Providing that R_a and R_b are no less than $1k\Omega$ ($10k\Omega$ on $1M\Omega$ range and above), and the Ω Guard resistance (R_g) is less than 1Ω ; the actual value can be calculated from the displayed value R_d by:

If $R_d = 100\Omega$, $R_g = 1\Omega$, $R_a = R_b = 10k\Omega$, then the value of E is given by:

$$E = \frac{(100 \cdot 1)}{(10k \cdot 10k)} = 10^{-6} \text{ (1ppm of reading);}$$

$$R_x = R_d \times (1 + E)$$

The value of R_x is thus given by:

$$\begin{aligned} R_x &= 100 \cdot (1 + 10^{-6}) \text{ Ohms,} \\ &= 100.0001 \text{ Ohms} \end{aligned}$$

Measurement of DC Current (Option 30 with Option 20)

Generalized Procedure

DCI Key and Menus

A description of the User Interface is given in Section 3 for the main functions. If you are unfamiliar with the front panel controls, you should complete the quick tour which starts on Page 3-5. Specific reference to DC Current measurement appears on Pages 3-28 to 3-31.

If you are familiar with the controls, but need a reminder of the way a particular facility can be selected; movement among the DCI group of menus is described by the following diagram:

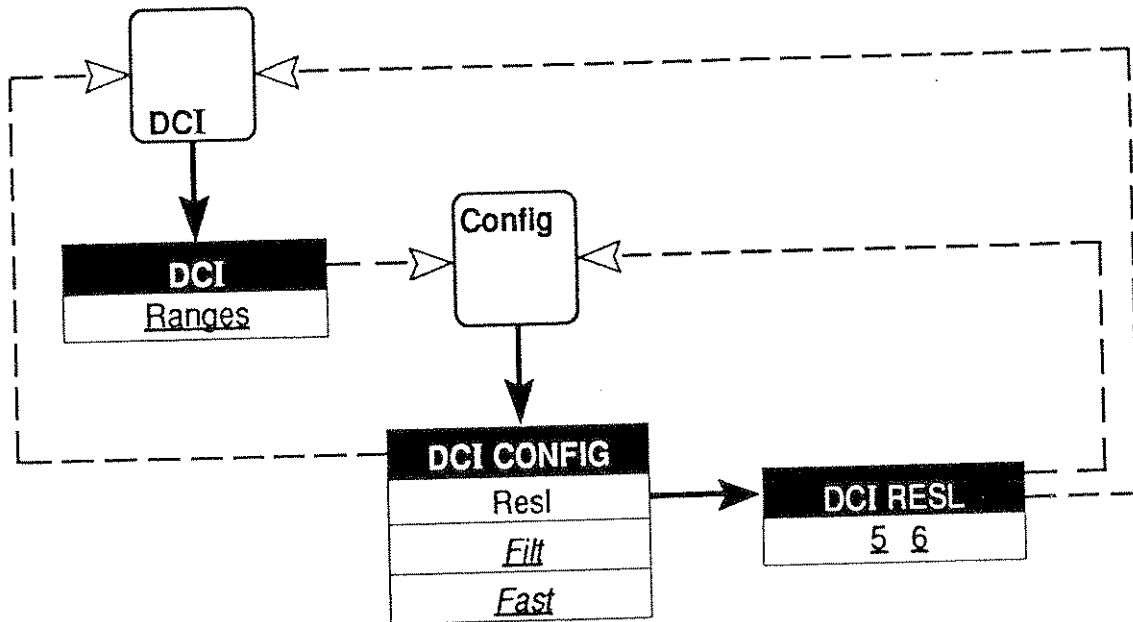

Input Connections

Setup Sequence

The following sequence of operations is arranged so as to configure a DC voltage measurement rapidly from the power on default state. In general, it is quicker to use toggle or choice soft keys on one menu before selecting another menu key.

Obviously, once the instrument has been set up to one configuration, that is the starting point.

- Press the DCI key - the power-on default range state is shown on the DCI menu.

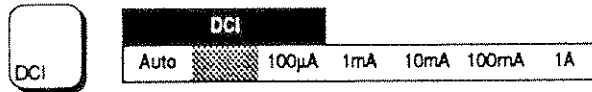

- Choose a range or Auto, as required.
- Press the Config key.
- Select FilT and/or Fast, if required.



To Alter the Main Display Resolution:

- Press the Resl key.



The display changes to DCI RESL menu showing '6', the power-on default state.

- Press one soft key to choose the required resolution.

Lead Connection

The instrument is inserted into the current path via its I+ and I- terminals, so that conventional current flows from +ve into the instrument's I+ terminal, and to -ve out of the I- terminal.

Similar connection considerations are required for DC current measurement as for DC voltage measurement. Use screened twisted pair cable to reduce induced voltages, and connect Guard to the source of common mode voltage, to provide a separate common mode current path.

Measurement of AC Current (Option 30 with Options 10 or 12 and 20)

Generalized Procedure

ACI Key and Menus

A description of the User Interface is given in Section 3 for the main functions. If you are unfamiliar with the front panel controls, you should complete the quick tour which starts on Page 3-5. Specific reference to AC Current measurement appears on Pages 3-32 to 3-36.

If you are familiar with the controls, but need a reminder of the way a particular facility can be selected; movement among the ACI group of menus is described by the following diagram:

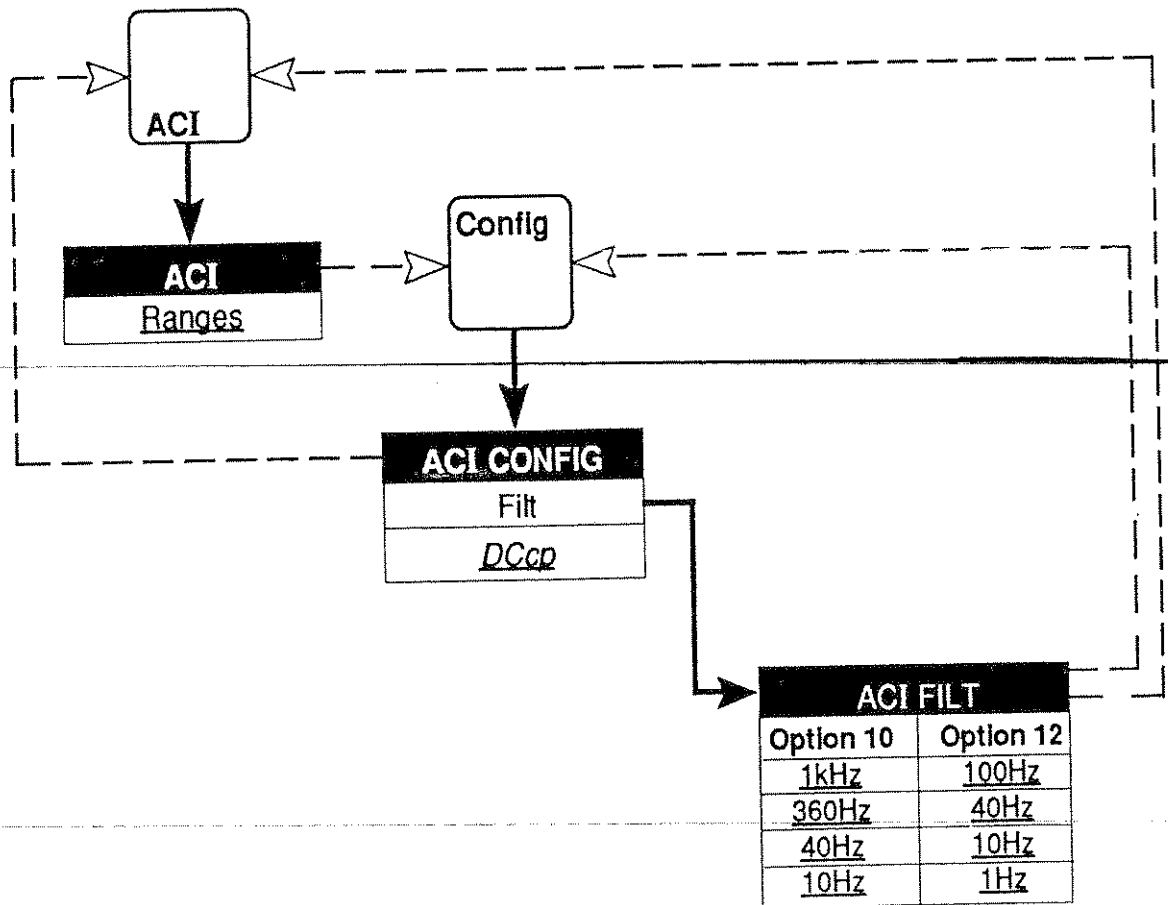

Setup Sequence

The following sequence of operations is arranged so as to configure an AC current measurement rapidly from the power on default state. In general, it is quicker to use toggle or choice soft keys on one menu before selecting another menu key.

Obviously, once the instrument has been set up to one configuration, that is the starting point.

- Press the ACI key - the power-on default range state is shown on the ACI menu.



- Choose a range or Auto, as required.
- Press the Config key.
- Select DCcp if required.



- DCcp must be selected for input frequencies less than 40Hz.

To Alter the Filter Frequency:

- Press the Config key.
- Press the Filt key.

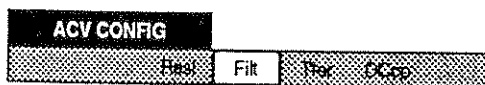

The display changes to ACV FILT menu showing '1kHz' (Option 10) or '100Hz' (Option 12), the power-on default state.

Option 10



Option 12



- Press one soft key to choose the required filter frequency.

Input Connections

The instrument is inserted into the current path via its I+ and I- terminals.

Similar connection considerations are required for AC current measurement as for AC voltage measurement. Use screened twisted pair cable to reduce induced voltages, and connect Guard to the source of common mode voltage via the screen, to provide a separate common mode current path.

Lead Impedance

When making AC current measurements pay particular attention to the lead impedance (see AC voltage measurement) especially at high frequencies on the lower current ranges.

Facilities

Input Control Facilities

Input Key

Pressing the Input key activates the INPUT menu (see pages 3-38 to 3-39 for available selections).

Front Panel Terminals

Three pairs of 4mm 'banana' terminals are fitted on the left of the front panel. Their functions are as follows:

| | |
|---------------------------------|--|
| Guard | General Guard |
| ΩGuard | Ohms Guard |
| I+ | Ohms Current Source (4-Wire) Current Input High |
| I- | Ohms Current Sink (4-Wire) Current Input Low |
| Hi | Voltage Input - High Ohms High (2-Wire) Ohms Sense High (4-Wire) |
| Lo | Voltage Input - Low Ohms Low (2-Wire) Ohms Sense Low (4-Wire) |

The block of terminals is extended forward by pressing the release catch at the top left-hand corner of the rear panel (viewing from the front). To retract the block, hold the release catch pressed, push the block back into the body of the instrument, then release the catch.

PL11 and PL12 - Rear Inputs

The two input channels on the rear panel incorporate two identical 50-way Cannon 'D' type plugs, each with only six pins present, and fitted with screw locks for strain relief. Channel A is connected via PL12, and Channel B via PL11. The layout of the pins and their designations are given in Section 2.

Maximum Input Limits

Refer to Section 6.

Status Reporting Facilities

This subject is adequately described in Section 3, pages 3-40 to 3-46. If you are unfamiliar with the front panel controls, you should complete the quick tour which starts on Page 3-5.

Specific reference to Status Reporting appears on Pages 3-40 to 3-46. If you are familiar with the controls, but need a reminder of the way a particular facility can be selected; movement among the STATUS group of menus is described by the following diagram:

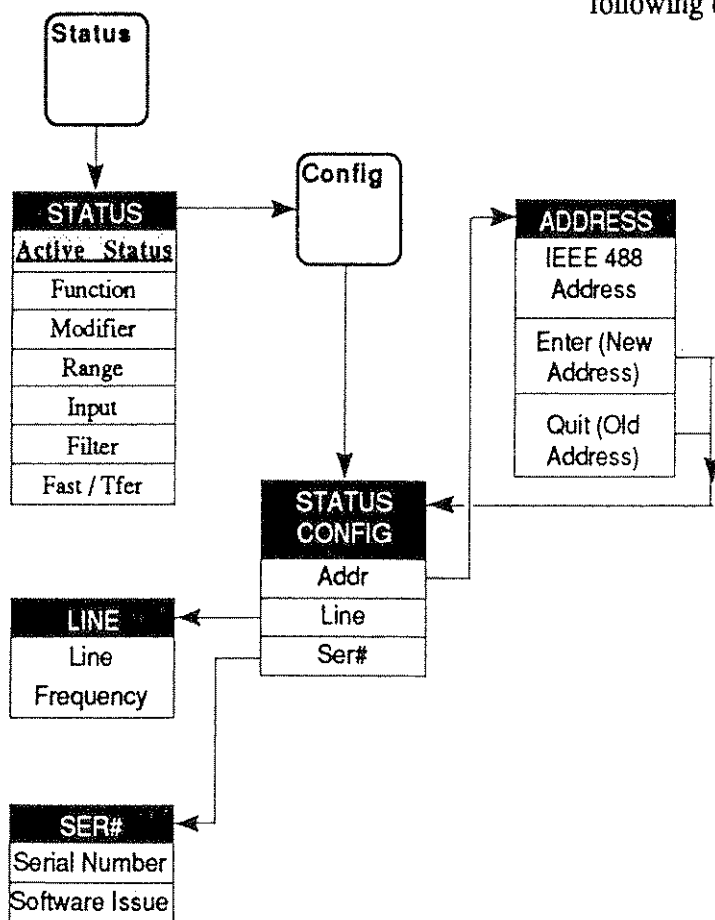

Monitoring Facilities

Monitor Menus

A description of the User Interface is given in Section 3 for the main functions.

If you are unfamiliar with the front panel controls, you should complete the quick tour which starts on Page 3-5.

The Monitoring facilities are not covered specifically in Section 3, so to give an overall view of the monitoring facilities, movement among the MONITOR group of menus is described by the following diagram:

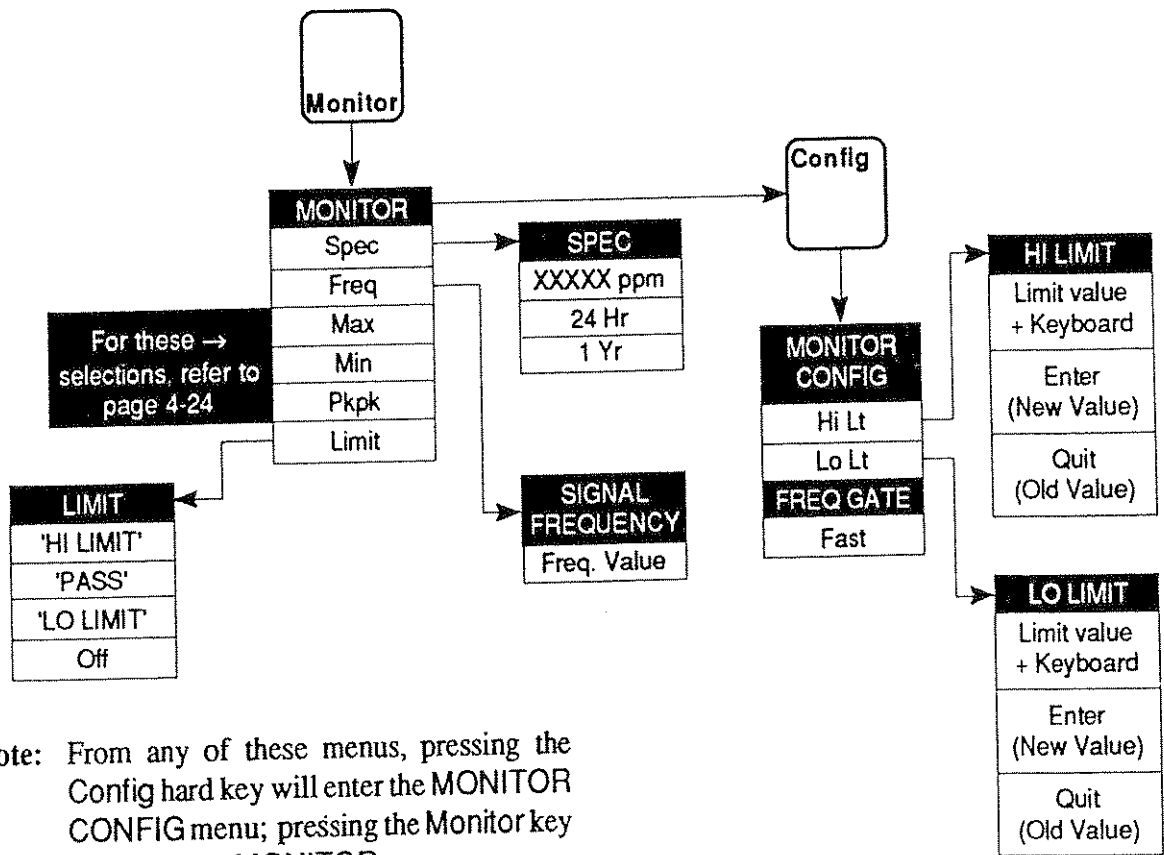

Monitor Key

Pressing the Monitor front panel key causes the MONITOR menu to be displayed:

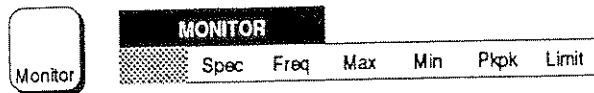

This menu defines six *menu* keys:

- Spec:** The SPEC menu presents a readout of the uncertainty associated with the particular measurement being taken.
- Freq:** Displays the SIGNAL FREQUENCY if ACV or ACI function has been selected. This shows the frequency corresponding to the RMS measurement shown in the main display. If ACV or ACI is not selected an error message results. For frequencies <40Hz the message NOT VALID appears in place of the frequency value.
- Max:** The MAX menu indicates the maximum value for any reading taken since the Max store was last reset.
- Min:** The MIN menu indicates the minimum value for any reading taken since the Min store was last reset.
- Pkpk:** The PKPK menu indicates the peak to peak (ie Max minus Min) value for any reading taken since the Max and Min stores were last reset.
- Limit:** Indicates whether the current reading has exceeded the user-defined high and low limits.

SPEC Menu

Selected by the Spec key in MONITOR, this menu displays the uncertainty associated with the current reading shown on the main display. Two selections are available to indicate the type of specification relevant to the user's application.



This menu defines two *choice* keys:

- 24Hr** Displays the instrument uncertainty, calculated on the basis of the instrument's 24 hour $\pm 1^{\circ}\text{C}$ spec, relative to calibration standards. The default and Power-On selection is 24Hr.
- 1Yr** Displays the instrument uncertainty, calculated on the basis of the instrument's 1 year specification, including whatever uncertainty has been entered in the EXT CAL SPEC ENTRY menus (see 'Calibration' later in this section). 1Yr is not selected at Power On.

SIGNAL FREQUENCY Display

Selected by the Freq key in MONITOR and ACV, this gives the frequency corresponding to the RMS value shown on the main display.



There are no selections to be made, exit is by pressing a hard key.

MAX, MIN, and PKPK Menus

These three menus share the same format, presenting information derived from measurements taken since the individual facility was last reset.

Once one of the three menus has been entered, a user can select either of the other two without recourse to the MONITOR menu.

Within the MAX or MIN menu, its own memory store can be cleared by its own Reset soft key; but the PKPK menu Reset soft key clears both the Max and Min memory stores.

There is no Pkpk store except as a result of calculating max minus min. Thus if only one of the max or min stores is cleared independently, the PKPK menu value is cleared until the first measurement enters the cleared store. After this, the PKPK menu value reflects the change by showing the new difference between the two stores.

To avoid confusion, the instrument has been programmed not to clear the max or min stores for Function, Range etc. changes. They can be cleared only by pressing the appropriate Reset key.

MAX Menu

Selected by the Max key in MONITOR, this menu displays the 'maximum' value for all readings taken since the Max store was last reset.



It shows the maximum measurement value attained during all the measurements taken since the Reset key in this menu was pressed.

'Maximum' is defined, for all the measurements which qualify, as:

for DCV and DCI:

The most positive (or least negative) measurement.

for ACV and ACI:

The largest RMS value measurement.

for Ohms:

The largest resistance measurement.

Three menu keys and a soft *direct-action* key have the following effects:

Max: No change - the MAX menu continues.

Min: Causes the MIN menu to be displayed.

Pkpk: Causes the PKPK menu to be displayed.

'Reset' Pressing Reset in the MAX menu clears the Max store. The instrument then begins searching for a new maximum.

MIN Menu

Selected by the Min key in MONITOR, this menu displays the 'minimum' value for all readings taken since the Min store was last reset.

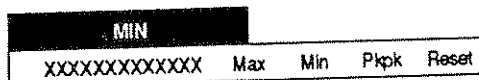

It shows the minimum measurement value attained during all the measurements taken since the Reset key in this menu was pressed.

'Minimum' is defined, for all the measurements which qualify, as:

for DCV and DCI:

The most negative (or least positive) measurement.

for ACV and ACI:

The smallest RMS value measurement.

for Ohms:

The smallest resistance measurement.

Three *menu* keys and a soft *direct-action* key have the following effects:

Max: Causes the MAX menu to be displayed.

Min: No change - the MIN menu continues.

Pkpk: Causes the PKPK menu to be displayed.

'Reset' Pressing Reset in the MIN menu clears the Min store. The instrument then begins searching for a new minimum.

PKPK Menu

Selected by the Pkpk key in MONITOR, this menu displays the 'max minus min' value.

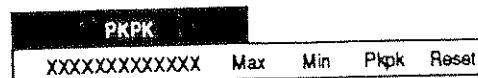

It shows the difference between the maximum and minimum measurement values, attained during all the measurements taken since a Reset key in any of the three menus was pressed.

'PKPK' is defined, for all the measurements which qualify, as:

for DCV and DCI:

The difference between the most positive (or least negative), and the least positive (or most negative) measurement.

for ACV and ACI:

The difference between the largest and smallest RMS value measurements.

for Ohms:

The difference between the largest and smallest resistance measurements.

Three *menu* keys and a soft *direct-action* key have the following effects:

Max: Causes the MAX menu to be displayed.

Min: Causes the MIN menu to be displayed.

Pkpk: No change - the PKPK menu continues.

'Reset' Pressing Reset in the PKPK menu clears both the Max and Min stores. The instrument then begins calculating a new difference between max and min.

MONITOR CONFIG Menu

LIMIT Menu

Selected by the Limit key in MONITOR, this displays whether high and low limits (previously entered via the MONITOR CONFIG menu) have been crossed by the most recent measurement. The display indicates accordingly:

HI LIMIT, LO LIMIT, or PASS.

The reading is updated as soon as each measurement is complete.

If the Hi Limit is crossed:



If the Lo Limit is crossed:



If no Limit is crossed:



Only one *state toggle* key is provided in this menu.

Off: This determines whether limits-checking is activated or not. Selection turns limits-checking off. It is automatically selected Off at Power On.

When in MONITOR, selection of the Config key causes the MONITOR CONFIG menu to be displayed. This permits entry of Hi and Lo limits and selection of frequency gate settings for the ACV function frequency measurements.



This menu defines two *menu* keys and Fast, which is a *toggle* key:

Hi Lt: Displays the HI LIMIT menu. This permits entry of a value to be used as the high limit for when limits-checking is activated.

Lo Lt: Displays the LO LIMIT menu. This permits entry of a value to be used as the Low limit for when limits-checking is activated.

Fast: Causes all frequency measurements to be made with a 50ms gate at 4.5 digits resolution.

With Fast not selected the frequency measurements are made with a 1 second gate at 6.5 digits resolution. The 1s gate mode will slow the ACV read rate down.

Fast is selected On at Power On.

HI LIMIT Menu

Selection of Hi Lt in MONITOR CONFIG will cause the HI LIMIT menu to be displayed. This permits entry of a value to be used as the high limit when limits-checking is activated.

| | | | |
|--------------|--|-------|------|
| HI LIMIT = | | Enter | Quit |
| XXXXXXXXXXXX | | | |

On entry to the menu, the last Hi Limit value is shown and the keyboard is activated. The most-recent reading can be entered by pressing the Last Rdg keyboard key, or a numeric value can be entered.

This menu also defines two *menu* keys:

- Enter: Causes the new value to be stored (or restore the old value if unchanged).
- Quit:: Leaves the old value intact.

Either Enter or Quit causes exit from the menu back to the MONITOR CONFIG menu.

LO LIMIT Menu

Selection of Lo Lt in MONITOR CONFIG will cause the Lo LIMIT menu to be displayed. This permits entry of a value to be used as the high limit when limits-checking is activated.

| | | | |
|--------------|--|-------|------|
| LO LIMIT = | | Enter | Quit |
| XXXXXXXXXXXX | | | |

On entry to the menu, the last LO Limit value is shown and the keyboard is activated. The most-recent reading can be entered by pressing the Last Rdg keyboard key, or a numeric value can be entered.

This menu also defines two *menu* keys:

- Enter: Causes the new value to be stored (or restore the old value if unchanged).
- Quit:: Leaves the old value intact.

Either Enter or Quit causes exit from the menu back to the MONITOR CONFIG menu.

Example of Limit-Setting Sequence

The following sequence of operations commences with the DMM set to measure DC Voltage, with the DCV menu showing on the display. It continues first to set up a high limit, then a low limit, and finally to view the results of inputting a DC Voltage.

- Press the Monitor key.



- Press the Config key.



- Press the Hi Lt key.



The HI LIMIT menu is displayed.

- Use the keyboard keys to set an upper limit value, and then press Enter.



The display reverts to the Monitor Config menu.

- Press the Lo Lt key.



The LO LIMIT menu is displayed.

- Use the keyboard keys to set a lower limit value, and then press Enter.



The display reverts to the Monitor Config menu.

- Press the Monitor hard key.

The MONITOR display appears.

- Press the Limit key.



The display changes to the LIMIT menu.

- Activate limit-checking by pressing the Off key (at power-on, Off is selected).

By adjusting the input to the DMM above and below the limits, it is possible to view each of the following versions of the LIMIT menu.



Test Facilities

Test Menus

A description of the User Interface is given in Section 3 for the main functions.

If you are unfamiliar with the front panel controls, you should complete the quick tour which starts on Page 3-5.

The Test facilities are not covered specifically in Section 3, so to give an overall view, movement among the TEST group of menus is described by the following diagram:

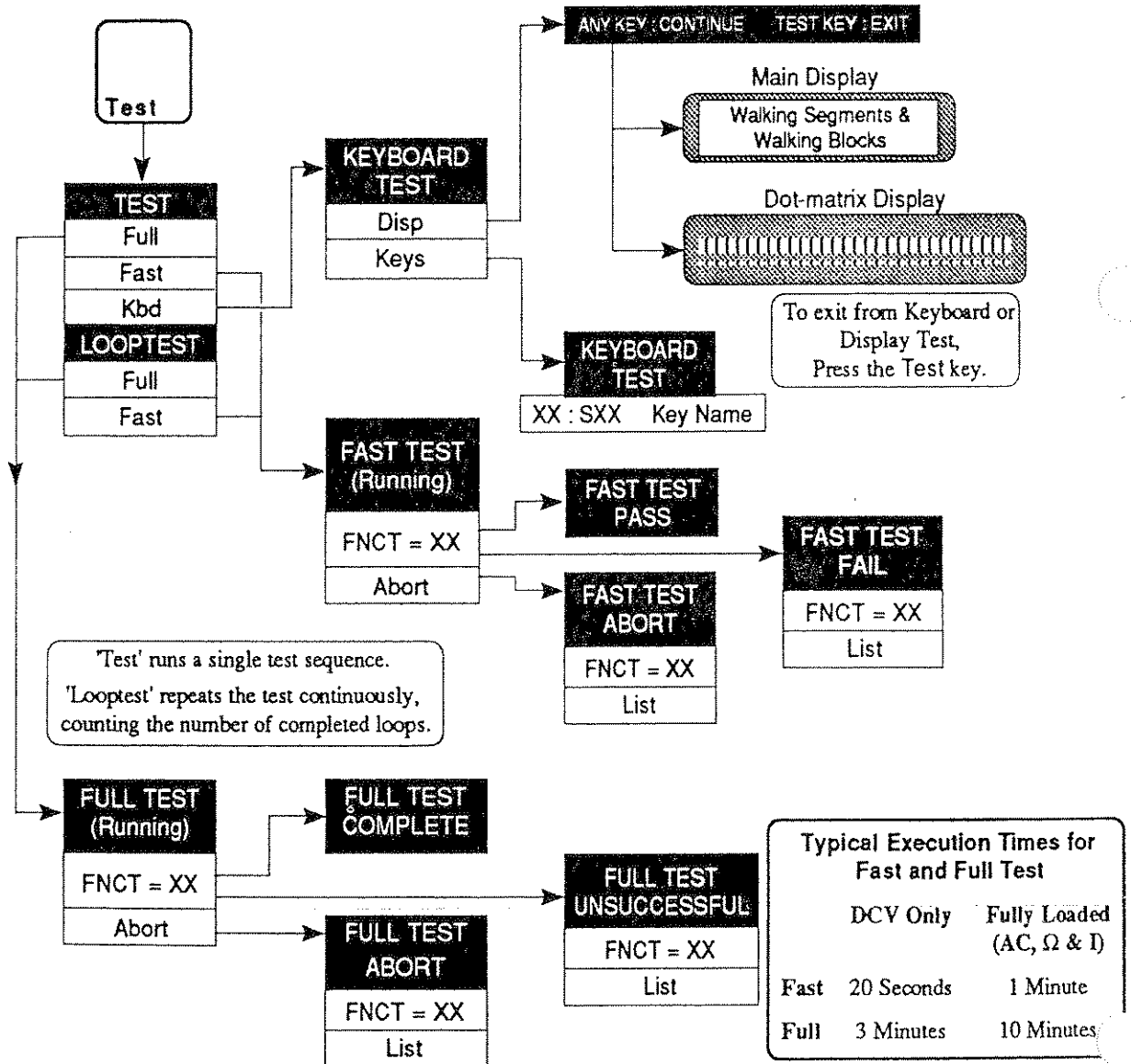

Test Key

The front panel Test key causes the TEST menu to be displayed. Different types of selftest can be chosen from this menu.



LOOPTEST defines the two succeeding keys, therefore the TEST menu defines four *test initiation* keys and kbd, which is a *menu* key:

N.B.

Full Selftest cannot be selected unless a successful 'Internal Source Calibration' has been carried out since the most-recent External Calibration.

Caution

The success of Full Selftest can be inhibited by:

- temperature not in the range: 13°C to 33°C;
- more than 1 year since the most-recent external calibration; or
- presence of excessive RFI or power-line noise.

Full

Full starts a full selftest, disabling all other function keys, signal inputs and normal trigger sources. This test includes a calibration memory check..

While full selftest is running, the display shows a reference number, the test currently being performed, plus a pass or fail comment. Once a failure is noted, the comment persists to the end of the test sequence.

Pressing the ABORT key aborts the test.

List

In the FULL TEST ABORTED and FULL TEST UNSUCCESSFUL menus, repeated pressing of the List key reads out the failures in turn. The memory of each failure is destroyed as it is read.

Appendix A to this section contains a list of the failure-message numbers.

Fast

A more rapid check begins. This is similar to a full selftest operation but the resolution of readings is cut to 5.5 digits, and the check limits are widened to increase the speed of testing. Fast test also carries out a calibration memory check.

Kbd

Displays the KBD TEST menu, where checks can be made on the displays and front panel keys.



Disp

A reminder menu appears first, noting the actions of the keys. Repeatedly pressing any key other than Test increments both displays through a sequence of 'walking strobes', which allow a user to inspect segments and complete blocks.

Keys

All keys other than the Test key can be tested by pressing. The key's hexadecimal matrix position appears to the left of a colon, an 'S' is followed by the key's switch number, and the name of the key is given on the right of the display.

Exit

During 'Disp' or 'Keys' checks, pressing the Test key terminates the sequence.

LOOPTEST (Full or Fast)

Causes the selected selftest to begin and keep repeating until either the user aborts the process, or a failure is noted. In all other respects it is identical to Full or Fast selftest.

The number of completed tests is shown on the right of the dot-matrix display. This number increments to 99, and then starts again.

Mathematical Facilities

Math Menus

A description of the User Interface is given in Section 3 for the main functions.

If you are unfamiliar with the front panel controls, you should complete the quick tour which starts on Page 3-5.

The Math facilities are not covered specifically in Section 3, so to give an overall view, movement among the MATH group of menus is described by the following diagram:

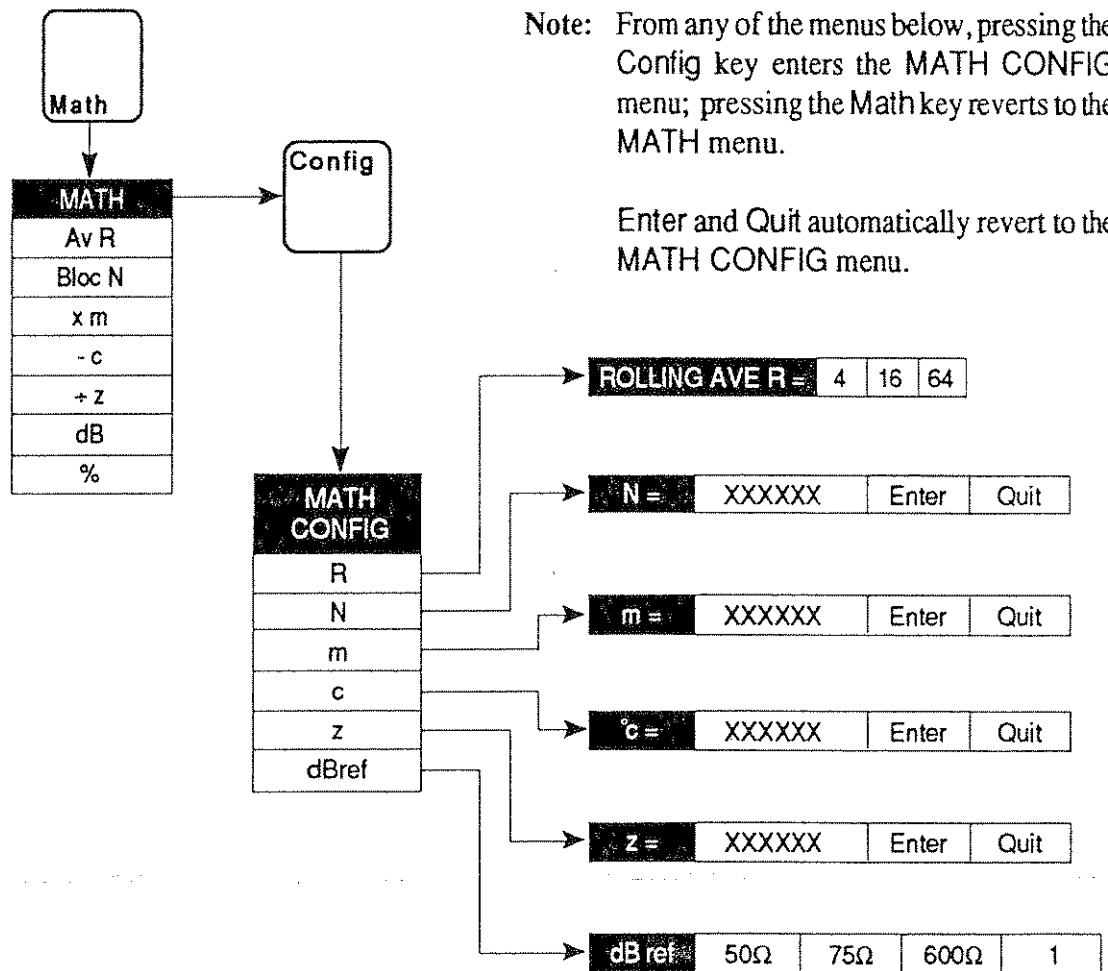

Note: From any of the menus below, pressing the Config key enters the MATH CONFIG menu; pressing the Math key reverts to the MATH menu.

Enter and Quit automatically revert to the MATH CONFIG menu.

Math Key

The Math front panel key causes the MATH menu to be displayed. This menu can activate a wide choice of linear and logarithmic calculations, as well as averaging in rolling or block modes.

All constants used in the operations are entered via the MATH CONFIG menu.

Operations are performed on the readings obtained from the main measurement function in strict left to right order.

All operations are independently selectable; any activated operation causes the Math annunciator on the main display to be lit.

MATH Menu

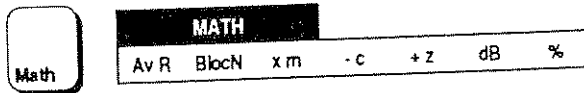

This menu defines seven *toggle* keys, all keys are not selected at Power On. Except for $\%$, the constants are defined via the MATH CONFIG menu.

- AvR Causes a rolling average of R readings to be made. AvR cross-cancels with BlocN.
- $BlocN$ Causes a block average of N readings to be made. BlocN cross-cancels with AvR.
- $x m$ The measurement is multiplied by a constant m.
- $-c$ A constant c is subtracted from the measurement.
- $+z$ The measurement is divided by constant z.
- dB The measurement is expressed in dB relative to 1, or to z, or to dBref. Constants dBref and z are defined via the MATH CONFIG menu.
- $\%$ The measurement is multiplied by 100. For this selection the % annunciator on the main display is also lit.

Rolling Averaging

MATH CONFIG Menu

Selection of the Config key in MATH will cause this menu to be displayed. This menu allows the user to access the various stores for the constants used by the math operations.



The MATH CONFIG menu defines six *menu* keys:

- R Displays the ROLLING AV menu, where the number of readings for the 'moving window' used in rolling average can be selected.
- N Displays N, a numeric entry menu, where the value for N can be entered.
- m Displays m, a numeric entry menu, where the value for m can be entered.
- c Displays c, a numeric entry menu, where the value for c can be entered.
- z Displays Z, a numeric entry menu, where the value for z can be entered.
- dBref Causes the dBREF menu to be displayed, where the reference used for dB calculations can be selected.

ROLLING AV Menu

This menu is obtained by selecting R from the MATH CONFIG menu.



It gives access for selection of the number of readings for the 'moving window' used in rolling average (AvR). The last selected value is underlined with a cursor.

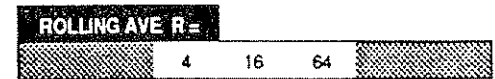

This menu defines three *choice* keys:

- 4 Selects a rolling average of 4 readings. 4 is selected On at Power On.
- 16 Selects a rolling average of 16 readings. 16 is not selected at Power On.
- 64 Selects a rolling average of 64 readings. 64 is not selected at Power On.

Block Averaging

N Menu

This menu is obtained by selecting N from the MATH CONFIG menu. It permits entry of a value to be used as N when BlocN is activated.



On entry to the menu, the most-recent N value is shown and the keyboard is activated.



The required size for the block can be changed by changing the block number, using the keyboard.

This menu also defines two *menu* keys:

- Enter: Causes the new value to be stored (or restore the old value if unchanged).
- Quit: Leaves the old value intact.

Both Enter and Quit cause exit from the menu back to the MATH CONFIG menu.

DeciBel Reference

dBREF Menu

This menu is obtained by selecting dBref from the MATH CONFIG menu.



It allows the reference used for dB calculations to be selected. The last selected value is underlined with a cursor.

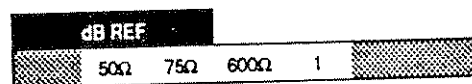

This menu defines four *choice* keys, which can also be cancelled by re-pressing the selected key:

50Ω: Selects a reference of 1mW in 50Ω.
50Ω is not selected at Power On.

75Ω: Selects a reference of 1mW in 75Ω.
75Ω is not selected at Power On.

600Ω: Selects a reference of 1mW in 600Ω.
600Ω is not selected at Power On.

1: Selects a unity reference value.
1 is selected On at Power On.

Math Constants

m, c, or z Menus

The math constant menus are obtained by selecting m, c, or z from the MATH CONFIG menu. It permits entry of a value, to be used when the corresponding constant is activated on the MATH menu.

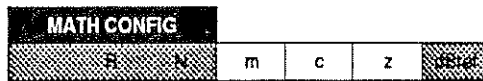

On entry to one of the menus, the most recent value is shown and the keyboard is activated.



The most-recent reading can be entered by pressing the Last Rdg keyboard key, or a numeric value can be entered.

These menus also define two *menu* keys:

Enter: Causes the new value to be stored (or restore the old value if unchanged).

Quit: Leaves the old value intact.

Both Enter and Quit cause exit from the menu back to the MATH CONFIG menu.

Example using Math Facility

Dimensional Flexibility

To obtain greater flexibility when performing calculations, it is assumed that the user is aware of the nature of the calculation being programmed. No dimensional checking is incorporated in the operations.

For instance: it is possible to enter a number as z in the MATH CONFIG menu and program + z on the MATH menu; then the reading on the main display is the input divided by z, with the legend on the main display indicating the units of the input.

But if the % key on the MATH display is pressed as well, then it is assumed that the user intends the number z to be in the same units as the input. The result is that the '%' legend is lit on the main display, and the units legend is deleted. The calculated measurement is multiplied by 100 and reverts to a dimensionless number, which represents the input as a percentage of z.

In the following sequence of operations, a reading (x) is multiplied by 1.5 (m), then 10 (c) is added and the whole is divided by 7 (z). This represents a linear equation of the form:

$$y = \frac{mx + c}{z}$$

The sequence starts with the DMM set to measure DC Voltage, and the DCV menu showing on the display. It continues first to set the values of math constants, then to set up a math formula, and finally to view the results of inputting a DC Voltage.

- Press the Math key.



- Press the Config key.
- Press the m key.



The M menu is displayed.

- Press the keyboard keys: '1'; '.'; '5'; and then press Enter.



The display reverts to the MATH CONFIG menu.

- Press the c key.



The C menu is displayed.

- Press the keyboard keys: '±'; '1'; and '0'; (the '±' because the 'minus' operation is included in the selection of - c in the MATH menu formula) and then press Enter.



The display reverts to the MATH CONFIG menu.

- Press the z key.



The Z display appears.

- Press the keyboard key: '7'; and then Enter.



The constants for our formula are now established. The next stage is to program the formula itself, using the MATH menu.

- Press the Math key.

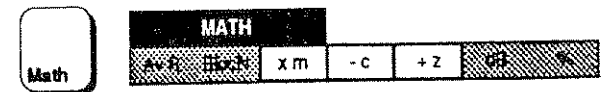

- Press the soft x m, - c and + z keys (the order of pressing does not matter, as each operation can only be performed in left-to-right sequence, and we have constructed our formula to correspond).

The values appearing successively on the main display give the results of operating on each measurement input with the formula. This will continue until we cancel the x m, - c and + z selections on the MATH menu.

The generalized sequence above is developed overleaf to provide a specific application; the percentage deviation of a series of readings from a previously-noted single reading.

A simpler method is used, and the constants refer to the earlier measurement.

- Press the Z key.



The Z menu appears.

- Press the Last Rdg key, then press Enter.



The constants for our formula are now established. The next stage is to program the formula itself, using the MATH menu.

- Press the Math key.



- Press the soft - C, + Z and % keys (the order of pressing does not matter, as each operation can only be performed in left-to-right sequence, and we have constructed our formula to correspond).

- Repress the Ext' Trig key for internal triggers, taking successive readings.

The values appearing successively on the main display give the results of operating the formula on each reading. They will appear as percentage deviations of the earlier single input, changing as the source voltage is varied. This will continue until we cancel the selections on the MATH menu.

Calibration Facilities

Caution

This description is intended only as a guide to the menus and facilities available to calibrate the instrument. It contains no examples nor calibration routines, and should NOT be used directly as a basis for calibrating any part of the instrument.

For routine calibration refer to Section 8 of this handbook.

Calibration Menus

A description of the User Interface is given in Section 3 for the main functions. If you are unfamiliar with the front panel controls, you should complete the quick tour which starts on Page 3-5.

To give an overall view of the calibration facilities, movement among the CAL group of menus is described by the diagrams on the following pages.

Index to Calibration Menus and Descriptions

| Menus | Page | Descriptions (contd) | Page |
|---------------------------------------|------|----------------------------------|------|
| Calibration Overview | 4-41 | Menus Originating from Ext. Cal. | 4-50 |
| External Calibration | 4-42 | Line Frequency | 4-50 |
| 'Spec' | 4-43 | Serial Number | 4-50 |
| Special Calibration and 'Lock' | 4-46 | SET Value | 4-51 |
| | | STD Value | 4-51 |
| | | SPEC (DCV, DCI or Ohms) | 4-54 |
| | | Freq Band | 4-54 |
| | | SPEC (ACV, ACI) | 4-55 |
| | | 'LOCK' (Access Protection) | 4-55 |
| | | Passnumber | 4-57 |
| | | Self Calibration | 4-58 |
| | | CAL Menu | 4-58 |
| | | PASS # = ? Menu | 4-58 |
| | | SELFCAL Menu | 4-59 |
| | | SELFCAL Running Menu | 4-59 |
| | | SELFCAL ABORTED Menu | 4-60 |
| | | SELFCAL UNSUCCESSFUL Menu | 4-60 |
| | | SELFCAL COMPLETE Menu | 4-60 |
| Descriptions | | | |
| Entry into the Calibration Menus | 4-47 | | |
| Protection for the Calibration Memory | 4-48 | | |
| External Calibration | 4-49 | | |
| Internal Source Calibration | 4-49 | | |
| EXT CAL DUE? (date setting) | 4-49 | | |

Section 4 - Using the 1271

External Calibration

Cardinal points - all ranges.

Non-Cardinal Points: **Set**

Std - Only DCV 1V or 10V Range recommended.

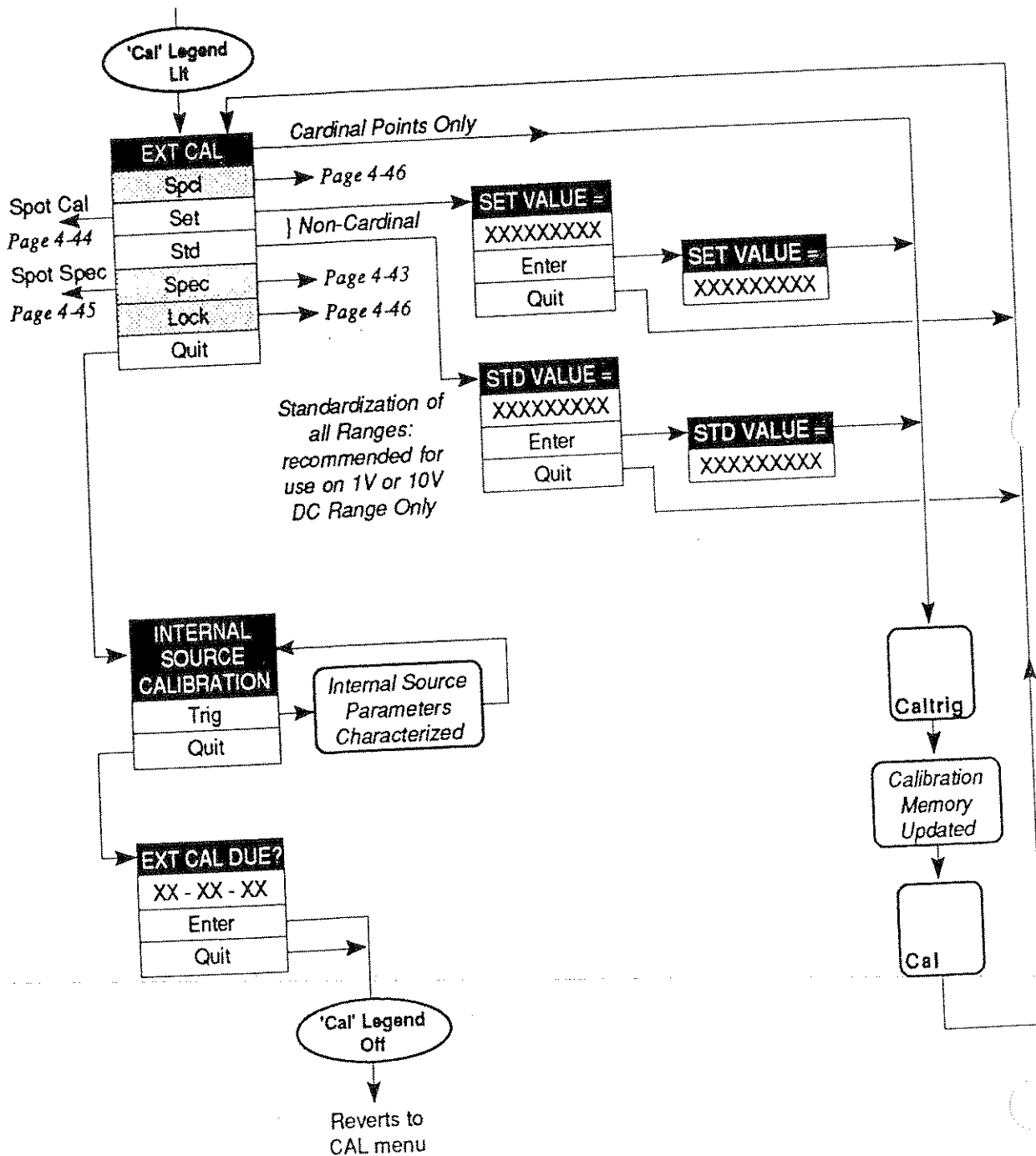

'Spec'

Entry of calibration uncertainties.

Menu route after pressing Spec key is automatically determined by Function selection.

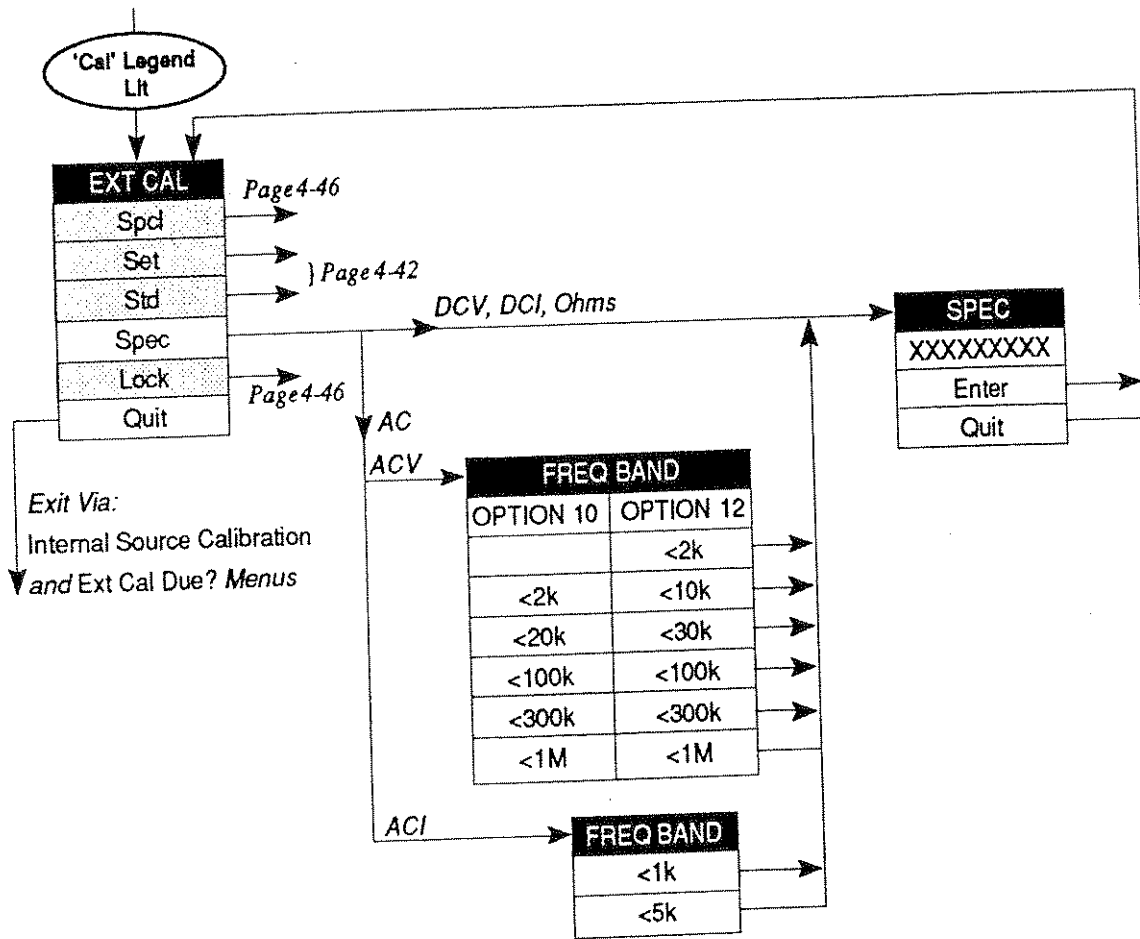

Section 4 - Using the 1271

Page 4-44 is deliberately left blank

Section 4 - Using the 1271

Page 4-45 is deliberately left blank

Special Calibration and 'Lock' Menu

'SPCL' permits the main ADC, the Analog-Output DAC and the frequency sensor to be calibrated. It also allows a section of the Non-Volatile RAM to be cleared for test purposes.

here for completeness; operations are described in the Calibration and Servicing Handbook.

The menu also allows line frequency to be set; and a serial number for the instrument to be registered.

These facilities are used in the factory for initial pre-calibration processes, and should need no further access during the life of the instrument unless repairs have been carried out. They appear

'LOCK' is used to set physical and/or passnumber restraints on access to external and self calibration, to protect the calibration memories.

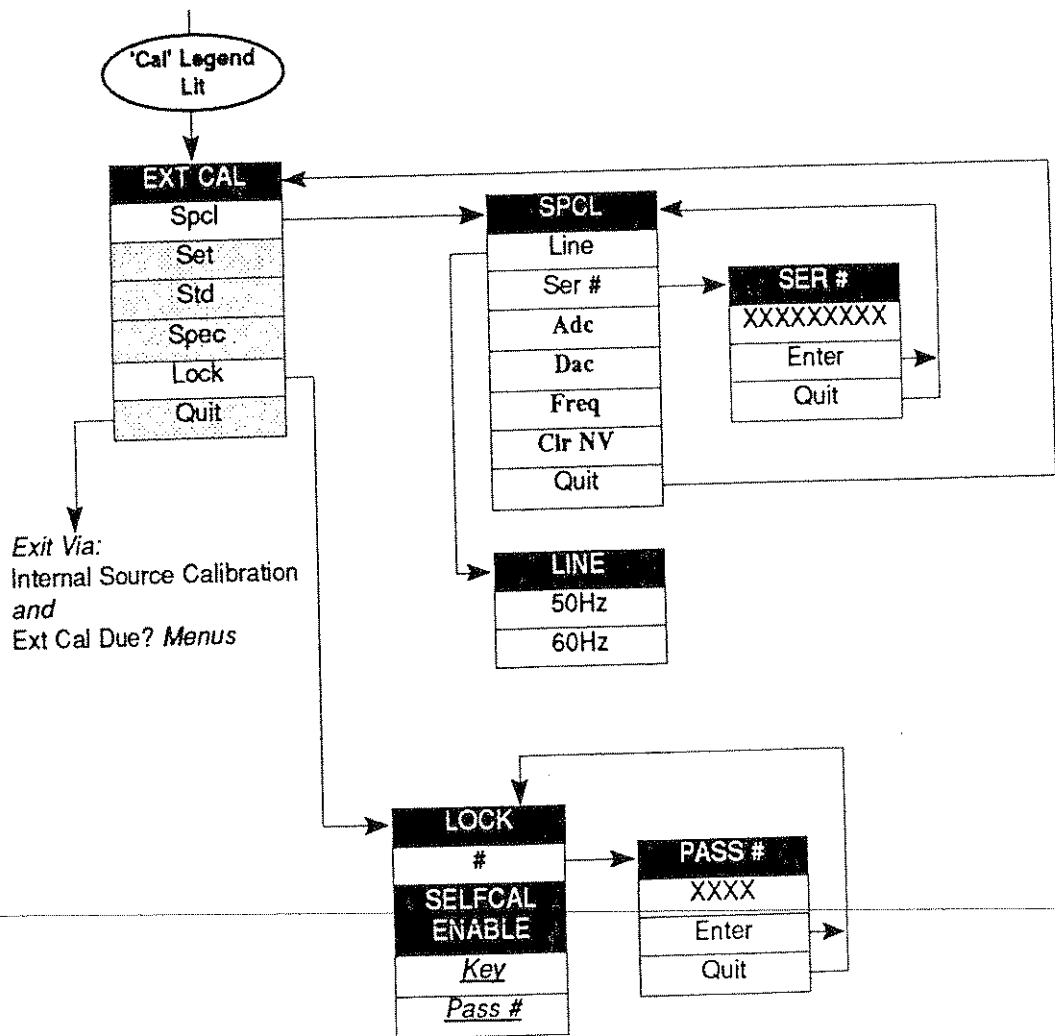

Entry into the Calibration Menus

Front Panel Cal Key

The Cal key on the front panel causes the CAL menu to be displayed in the dot matrix display, so long as the instrument is not already in Cal mode. This menu provides access to the external calibration menus, the selfcal menus, and the calibration due date menu. It also indicates whether the current set of selfcal corrections are being applied to the instrument's readings.

CAL Menu

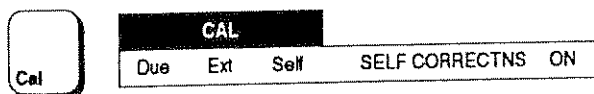

This menu defines three *menu* keys, all keys are not selected at Power On:

- Due** Displays the EXT CAL DUE menu. This shows the user-entered recommended date for recalibration of the instrument.
- Ext** This key, in conjunction with the correct rear panel key lock position, displays the EXT CAL menu; which allows a user to proceed with calibration of the instrument.
- Self** This key, in conjunction with the correct combination of passnumber and rear panel key lock position, displays the SELFCAL menu; from which the user can then activate selfcal.

EXT CAL DUE menu

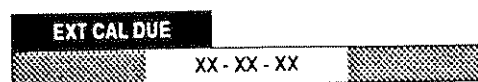

This menu is obtained by pressing the Due key from the CAL menu, showing the recommended date for recalibration of the instrument. It is accessible without using the calibration keyswitch or the passnumber, but the due date cannot be changed. After quitting the EXT CAL menu following a calibration, the menu is presented again, this time for possible alteration.

Protection for the Calibration Memory

Access Conditions

Access to the non-volatile calibration memory is restrained by two devices:

- A key-operated switch on the rear panel, always required for external calibration, and optionally installed for selfcal.
- A user-installed passnumber, which can be enabled for selfcal.

When the instrument is delivered new from Datron, access to selfcal is by keyswitch alone - the passnumber requirement has been disabled.

The options for selfcal can only be set or cleared from the LOCK menu, which is unavailable until access has been gained to the EXT CAL menu.

Once a passnumber is enabled, the passnumber menu (PASS # =) denies access to the SELFCAL menu to anyone who does not know the correct number. The locks can be set to protect the SELFCAL menu by either the keyswitch or passnumber (or both), or to leave it unprotected, at the authorizer's discretion.

PASS # = ? Menu

If the passnumber option has been selected for selfcal in the LOCK menu; then this menu appears when Self is selected in the CAL menu.

On entry to the menu the keyboard is activated and a numeric value (6 digits maximum) can be keyed in. None of the digits are displayed. Unless the number is the same as was installed, no further access to calibration menus is possible.



This menu also defines two *menu* keys:

Quit: Reverts to the CAL menu.

Enter: The passnumber is checked.

If it is invalid, an error message appears on the PASS# = ? menu, and entry to the SELFCAL menu is prohibited.

If it is valid, the keyboard is deactivated and effect is given to the Self command given in the CAL menu.

Caution:

A valid Enter command also lights the 'Cal' legend on the main display, and enables the Caltrig key, which when pressed can alter the calibration memory.

External Calibration

EXT CAL Menu

This menu allows direct zero and full range cardinal point calibration, or selection of the non-cardinal point calibration operations of Set and Std. It also offers a means of entering user-defined calibration uncertainties, which are applied to the spec readout function. Finally it allows access to define the passnumber and the selfcal access restraints.

Caution:

In this menu the Caltrig-key is enabled, and when pressed alters the calibration memory. To reduce the possibility of inadvertently obliterating the previous calibration, the menu should only be used during a genuine recalibration. Refer to Section 8.

Once the 'Cal' legend is lit, the major function hard keys can be selected and the various ranges calibrated at zero and full range cardinal points, using the Caltrig direct action key. If the full range values are not exactly at the cardinal points, then Set in the EXT CAL menu can be used to inform the instrument of the exact value. For as long as the 'Cal' annunciator remains lit, the front panel Cal key accesses the EXT CAL menu directly - not forcing the repeated use of the passnumber.

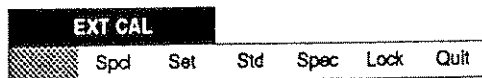

This menu defines six *menu* keys:

Spcl: Both the Cal and Spcl annunciators on the main display are lit. The SPCL menu is displayed which allows pre-calibration of the instrument. Refer to Section 1 of the Calibration and Servicing handbook.

Set: Displays the SET VALUE menu. Both these menus provide a means to calibrate the instrument against non-cardinal calibration points.

Std: Displays the STD VALUE menu. This permits restandardization of the instrument's reference to a new value.

Spec: If the DMM is in DCV, DCI, or Ohms, the SPEC menu is activated. If in ACV or ACI then the FREQ BAND menu is displayed. All of these menus lead to entry of user-defined calibration uncertainties which are applied to the spec readout function.

Lock: Displays the LOCK menu. It allows access to change both the passnumber and the selfcal enable conditions.

Quit: Exits from the EXT CAL mode; the Cal legend on the main display turns off.

Quit from the EXT CAL menu exits via the INTERNAL SOURCE CALIBRATION menu, where by pressing Trig, the Selfcal source can be characterized if required.

From the INTERNAL SOURCE CALIBRATION menu, quitting exits via the EXT CAL DUE ? menu, where the recommended next calibration date can be entered, before finally quitting to the CAL menu.

Menus Originating from the EXT CAL Menu



SPCL Menu

This menu is obtained by pressing the Spcl key in the EXT CAL menu.

It permits special calibration of the DMM's different analog to digital converter resolutions, the DAC used for analog output, the frequency detector device, and also provides a means to set up the instrument's line frequency and serial number. A 'ClrNv' facility clears a section of the non-volatile RAM for 'test purposes only'. Refer to Section 1 of the Calibration and Servicing handbook.

The SPCL menu defines three *menu* keys and three *toggle* keys:

- Line:** Displays the LINE menu, where the line frequency can be set.
- Ser#:** Permits entry of the instrument's serial number.
- Adc:** This key calibrates the different resolutions which are available from the instrument's main analog-to-digital converter, so that there are no significant differences in readings seen when changing resolutions with a constant input value.
- Dac:** Calibrates the digital-to-analog converter used in the analog output option.
- Freq:** Calibrates the frequency counter against an external source.
- ClrNv:** Clears a section of the non-volatile RAM for 'test purposes only'.
- Quit:** Reverts to the EXT CAL MODE menu.

LINE Menu

This menu is obtained by pressing Line in the SPCL menu. It permits selection of either 50Hz or 60Hz operation.

This setting is not lost at power down.



This menu defines two *choice* keys:

50Hz: Causes line operation to be set at 50Hz nominal.

60Hz: Causes line operation to be set at 60Hz nominal.

To exit from the Line menu it is necessary to select another function or facility hard key.

SER # = Menu

This menu is obtained by pressing Ser# in the SPCL menu. On entry to the menu, the most-recently entered serial number is shown and the keyboard is activated. A numeric value can be entered. The last four characters (the instrument's software issue) cannot be changed.



This menu also defines two *menu* keys:

Enter: Stores the new serial number, de-activates the keyboard, and reverts to the SPCL menu.

Quit: Reverts to the SPCL menu, leaving the old serial number intact.

Page 4-53 is deliberately left blank

SET VALUE Menu

This menu is obtained by pressing the Set key in the EXT CAL menu on all functions.

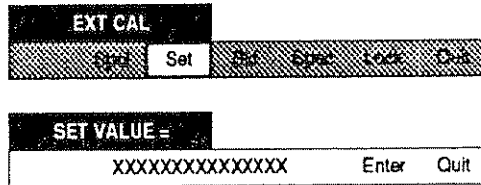

When this menu appears, it shows the nominal full range value. It provides a means to calibrate the DMM against non-cardinal calibration points. The keyboard is activated (locking out all other keys) so that a new set value can be used to represent the calibration source value. It must be keyed in as a decimal fraction of full range, followed by an exponent to convert it to units of volts, amps or ohms. The Caltrig key has no effect until the set value is stored by pressing the Enter key. The DMM always chooses the most-recently stored Set value when calibrating.

The menu also defines the two soft keys:

Caution:

Pressing the Enter key enables the Caltrig key.

Enter: The new value is stored and the keyboard is deactivated. The set value remains on the dot-matrix display for comparison with the reading on the main display after the Caltrig key has been pressed.

Quit: Reverts to the EXT CAL menu, deleting the set value from store.

STD VALUE Menu

This menu is obtained by selection of the Std key in the EXT CAL menu. It provides a means of restandardizing all ranges of the DMM against a single non-cardinal calibration point.

It is recommended that this be carried out only on DCV 1V and 10V ranges.

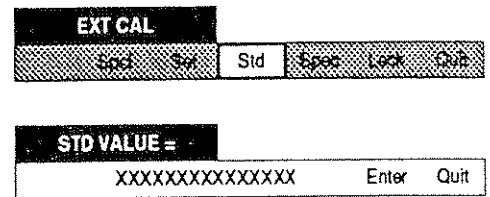

When this menu appears, it shows the nominal full range value. It activates the keyboard (locking out all other keys) so that a new Std value can be used to represent the calibration source value. This must be keyed in as a decimal fraction of full range, followed by an exponent to convert it to volts. The Caltrig key is inactive until the Std value is stored by pressing the Enter key. The DMM always chooses the most-recently stored Std value for the Std calibration.

The menu also defines the two soft keys:

Caution:

Pressing the Enter key enables the Caltrig key.

Enter: The new value is stored and the keyboard is deactivated. The Std value remains on the dot-matrix display for comparison with the DMM reading on the main display after pressing the Caltrig key.

Quit: Reverts to the EXT CAL menu, not storing any new Std value.

Page 4-53 is deliberately left blank

SPEC Menu (DCV, DCI or Ohms)

For these functions the SPEC menu is obtained directly by pressing the Spec key in the EXT CAL menu. It permits entry of calibration uncertainties which are used in the Spec readout calculations.

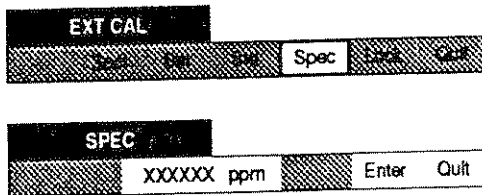

On entry to the menu, the most-recently entered calibration uncertainty value is shown and the keyboard is activated. A numeric value can be entered.

This menu also defines two *menu* keys:

Enter: Stores the new value, de-activates the keyboard, and reverts to the EXT CAL menu.

The new calibration uncertainty value is subsequently incorporated, instead of the previous one, into the CPU's calculations of DMM accuracies for the (MONITOR) SPEC menu display.

Quit: Reverts to the EXT CAL menu, leaving the old spec value intact.

FREQ BAND

This menu is obtained by selecting the Spec key from the EXT CAL menu when the DMM is in either ACV, or ACI function. It permits selection of the various frequency bands relevant to the entry of calibration uncertainties which are used in the spec readout calculations.



If ACI is selected:

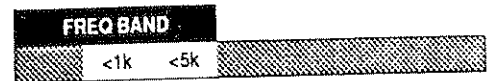

This menu defines two keys: <1k; <5k: For each of these selections, the SPEC menu is displayed, and the calibration uncertainty for this frequency range can be entered.

If ACV is selected

Option 10



Option 12



The table shows how the uncertainties will be applied over the frequency bands.

| Selection Key | Frequency Band | |
|---------------|------------------|----------------------------------|
| | OPTION 10 | OPTION 12 |
| <2k | 40Hz to 2kHz | 100Hz to 2kHz |
| <10k | | { 2kHz to 10kHz 40Hz to 100Hz |
| <20k | 2kHz to 20kHz | |
| <30k | | 10kHz to 30kHz |
| <100k | 30kHz to 300kHz | 30kHz to 100kHz |
| <300k | 100kHz to 300kHz | 100kHz to 300kHz |
| <1M | 300kHz to 1MHz | 300kHz to 1MHz |

For each selection, the calibration uncertainty can be entered in the SPEC menu, which appears next.

Note that when an uncertainty value is entered via the <10k key for the 2kHz to 10kHz band; the same value is applied both when the input frequency is between 2kHz and 10kHz, and when it is between 40Hz and 100Hz.

SPEC Menu - ACV or ACI -

Frequency Band Specifications

For these functions the SPEC menu is obtained by pressing a band selection key in the FREQ BAND menu when the DMM is in either ACV (not Spot) or ACI function. It permits entry of calibration uncertainties to be used for Spec calculations.

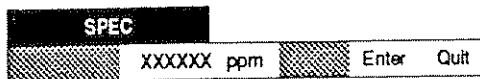

On entry to the menu, the most-recently entered calibration uncertainty value is shown and the keyboard is activated. A numeric value can be entered.

This menu also defines two *menu* keys:

Enter: Stores the new value, de-activates the keyboard, and reverts to the FREQ BAND menu.

The new calibration uncertainty value is subsequently incorporated, instead of the previous one, into the CPU's calculations of DMM accuracies for the (MONITOR) SPEC menu display.

Quit: Reverts to the EXT CAL menu, leaving the old spec value intact.

LOCK Menu

This menu is obtained by pressing Lock in the EXT CAL menu. It provides access to define the passnumber, and is also used to set the selfcal enable conditions.



This menu defines one *menu* key and two *state toggle* keys:

Note that the rear panel key lock must always be turned to CAL ENABLE before External Calibration can proceed. New instruments are shipped with Key selected; # and Pass # not selected.

#: Displays the PASS # menu, where the DMM's passnumber can be defined.

Key: When selected, the rear panel key lock must be turned to the CAL ENABLE position before a selfcal can proceed. This setting is not lost at Power Off.

Pass #: When selected, a passnumber must be entered before a selfcal can proceed. This setting is not lost at Power Off.

Section 4 - Using the 1271

Page 4-56 is deliberately left blank

PASS # Menu

This menu is obtained by pressing # in the LOCK menu. On entry to the menu, the most recently entered passnumber is shown and the keyboard is activated. A numeric value can be entered.

| | |
|----------|------------|
| PASS # = | |
| XXXXXX | Enter Quit |

This menu also defines two *menu* keys:

Enter: Stores the new passnumber, de-activates the keyboard, and reverts to the LOCK menu.

Quit: Reverts to the LOCK menu, leaving the old passnumber intact.

Self Calibration

CAL Menu

Self-calibration starts by pressing the hard Cal key.



This menu defines three *menu* keys, all keys are not selected at Power On. For self-calibration we are interested in the soft Self key:

- Due** Displays the EXT CAL DUE menu. This shows the user-entered recommended date for the recalibration of the instrument.
- Ext** This key, in conjunction with the correct combination of passnumber and rear panel key lock position, displays the EXT CAL MODE menu; which allows a user to proceed with calibration of the instrument.
- Self** This key, in conjunction with the correct combination of passnumber and rear panel key lock position, displays the SELFCAL menu; from which the user can then activate selfcal.

Rear Panel Keyswitch

If access to selfcal has been protected during external calibration (LOCK menu) by activating the **ENABLE/DISABLE** keyswitch on the rear panel; then to access the selfcal menus the switch must be turned to the **ENABLE** position.

PASS # = ? Menu

If a passnumber is installed to protect the selfcal operation, this menu appears prior to the SELFCAL menu, when Self is selected from the CAL menu.



On entry to the menu the keyboard is activated and a numeric value (6 digits maximum) can be entered. None of the digits are displayed as they are keyed in.

This menu also defines two *menu* keys:

Enter: The passnumber is checked.

If it is valid, the keyboard is deactivated and the Self command given in the CAL menu is effected by displaying the SELFCAL menu.

If invalid, an error message appears on the PASS # = ? menu, and entry to the SELFCAL menu is prohibited.

Quit: Reverts to the CAL menu.

Caution:

The next menu enables the soft trigger key Trig, which when pressed alters the calibration memory.

SELF CAL Menu

This menu is obtained by pressing the Self key in the CAL menu, in conjunction with the correct combination of passnumber and key lock setting. It permits activation of a Selfcal operation.



This menu defines one *direct action/menu* soft key and two *choice* keys:

N.B. Self Calibration is valid within $\pm 15^{\circ}\text{C}$ (DCV & ACV) on $\pm 5^{\circ}\text{C}$ (other functions) of the Autocal (external calibration) temperature, assuming Autocal is in the range $23^{\circ}\text{C} \pm 5^{\circ}\text{C}$.

Trig: Causes a complete selfcal operation to begin, progress being indicated.

Typical durations are:

- 1 minute (DCV-only instrument);
- 10 minutes (When fully loaded with DCV, ACV, Ohms, DCI and ACI).

CORRECTNS On:

Applies selfcal corrections to the DMM's readings. This setting is not lost at power down, and new instruments are shipped with corrections On.

CORRECTNS Off:

Causes the selfcal corrections to be disabled and not applied to the DMM's readings.

SELF CAL (Running)

This display results from pressing the Trig key in the SELF CAL menu. It indicates that a Selfcal operation is in progress, with a note of the current test being performed followed by a pass or fail comment.



Once any failure is noted, the fail message remains on the display to the end of the test sequence.

This menu also defines one *direct action/menu* key:

Abort: The Selfcal operation is aborted, and transfers the dot-matrix display to the SELF CAL ABORTED menu.

If the Abort key is not pressed, the Selfcal operation will run to its conclusion, and then transfer to either the SELF CAL COMPLETE menu, or the SELF CAL UNSUCCESSFUL menu, depending on whether any failures were noted during the test.

SELCAL ABORTED Menu

This menu is obtained by pressing the Abort key in the running SELFCAL menu, to stop the Selfcal operation. It permits a list of any failures to be viewed.

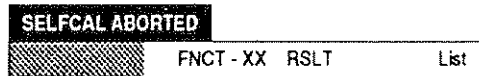

This menu defines one soft key:

List: Any failures during the test are noted in software, and these can be listed out on the dot matrix display by repeatedly pressing the List key.

N.B! Repeated pressing of the List key reads out the failures in turn. The memory of each failure is destroyed as it is read.

Appendix A to this section contains a list of the failure-message numbers.

To exit, press any function hard key.

SELCAL UNSUCCESSFUL Menu

If the completed Selfcal operation has detected a failure (ie the Selfcal operation has not been not aborted), the SELFCAL UNSUCCESSFUL menu appears after the running SELFCAL menu. It permits a list of any failures to be viewed.



his menu defines one soft key:

List: Any failures during the test are noted in software, and these can be listed out on the dot matrix display by repeatedly pressing the List key.

N.B! Repeated pressing of the List key reads out the failures in turn. The memory of each failure is destroyed as it is read.

Appendix A to this section contains a list of the failure-message numbers.

To exit, press any function hard key.

SELCAL COMPLETE Display

This display merely registers the completion of selfcal. It appears after the running SELFCAL menu when the Selfcal operation has not been aborted, if the operation has detected no failures.



No soft keys are defined. To exit from this display, press any function hard key.

Direct Action Keys

These seven keys are located beneath the main display. They allow the operator to act as follows:

Reset

Provides a quick means of resetting the instrument to the power-up state, as far as local operation is concerned.

The instrument default states for Power On are given in Appendix B to Section 5. Pressing **Reset** provides the same result, except that any settings directly concerned with remote operation are not altered.

Ext'trig

Disables internal triggers, and enables all external trigger sources.

The 'Ext' annunciator on the main display is lit.

Ext'trig can be self-cancelled by a second press, to enable internal triggers. The Ext annunciator is turned off when internal triggers are enabled.

Sample

Triggers a single-shot measurement if the DMM is in Ext'trig mode. All 'Sample' measurements are subject to the standard internal time delays before A-D conversion. These are listed on page 5-71 of Section 5.

During the measurement the 'Busy' annunciator on the main display is lit.

Local

Returns the DMM to front panel control when operating on the IEEE-488 bus, provided that it is not disabled by remote command. It will cause the Rem annunciator on the main display to turn off.

While in Local, any delays set up during remote programming are suspended, and the standard internal delays are reinstated.

Local can be disabled by a controller using the LLO (Local Lockout) function.

SRQ

If set to remote in IEEE 488 system operation, with 'URQ' and 'ESB' bits enabled; manually generates a Service Request (SRQ) on the IEEE 488 bus and causes the SRQ annunciator on the main display to light, and remain lit until the request is serviced.

SRQ can be disabled via the IEEE 488 bus using the 'Event Status Enable' or 'Service Request Enable' register commands.

For further information refer to Section 5.

Caltrig

This key is only active when the Cal annunciator is lit in the main display. It is used for all zero, gain, and AC hf cal triggers.

Zero

Causes an Input Zero operation to take place, ending with a corrected reading being shown on the main display. If Auto-range is selected, then each range for the selected function will be zeroed in turn, one after the other. The main display will track each range change. Independent zero corrections are available for Front, Channel A, and Channel B inputs. Neither Power On nor Reset affect the settings stored in the input zero memory.

Section 4 - Using the 1271

SK8 - Input/Output Port

This is a 15-way Cannon 'D' type socket, fitted on the Rear Panel. It provides for the following inputs and outputs:

Analog Output (Option 70 only)

Analog Output is only available when Option 70 is fitted, and the Analog Output Enable line (SK8 - pin 10) is shorted to Digital Common (SK8 - pin 7). When enabled, the Analog Output signal on pin 8 can vary between +2V and -2V, with a source impedance of 1k Ω , referred to pin 15.

When measuring normally, or scanning Channel A minus Channel B, the signal expresses the displayed reading as a fraction of Full Range.

e.g. -500V on the 1kV range codes to -0.5V DC of Analog Output.

When SCAN A/B, (A - B)/A or MATH is selected, then the output is as follows:

| | | |
|-------|----------|----------------------|
| 100% | = +1V DC | } Linear with dBs |
| 0% | = 0V DC | |
| 100dB | = +1V DC | |
| 0dB | = 0V DC | |

No Units:

+1.000000E0 = +1V
-0.500000E0 = -0.5V

Any reading which codes to >+2V or <-2V is represented by +2V or -2V as appropriate.

HOLD_L

This input at pin 13, when *true*, inhibits external triggers from any source, including Hi-Lo transitions on the Ext Trig. line. The pin is pulled to +5V via 10k Ω , and responds to TTL levels, being *false* when high, and *true* when low.

Flags

The outputs at pins 2 to 6 are typically at +3V when high, and at +0.5V when low. Maximum drive available via pins 2, 3, 4, 6 and 9 (when low) is 24mA. Maximum drive via pin 5 is 3mA.

HIGH LIMIT_L

This flag output at pin 2 is at low level (*true*) only when the most-recent measurement was above the limit programmed via the front panel or remote command.

LOW LIMIT_L

This flag output at pin 3 is at low level (*true*) only when the most-recent measurement was below the limit programmed via the front panel or remote command.

DATA VALID_L

This flag output at pin 4 goes to low level (*true*) to indicate that both the HIGH LIMIT_L and LOW LIMIT_L flag states are valid, and are not an invalid hangover from an earlier trigger.

When a valid trigger is received DATA VALID_L is asserted *false* (high level).

SAMPLING_H

This flag output at pin 5 goes to high level (*true*) when a valid trigger is received to start a measurement, returning to low level (*false*) when the measurement is complete.

TRIGGER TOO FAST_L

This flag output at pin 6 is latched to low level (*true*) when any trigger originating as EXT TRIG, REMOTE COMMAND or 'SAMPLE' (front panel key) is received; **and** the measurement cycle initiated by the previous such trigger is in progress.

Under normal circumstances, the second trigger will be implemented when the measurement is complete.

This flag line is reset to high level (*false*) when HOLD_L is asserted; or when any Function, Range, Resolution, Filter or Trigger Mode change is implemented.

OVERLOAD_L

The flag output at pin 9 goes to low level (*true*) when an overscale signal is applied to the input, returning to low level (*false*) when the overload is removed. This flag represents the 'Error OL' message given on the front panel.

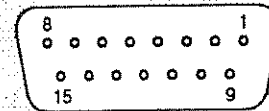
Pin Layout**Pin Designations**

| Pin | Name | Function |
|-----|------------------|------------------|
| 1 | SHIELD | |
| 2 | HIGH LIMIT_L | Flag - low true |
| 3 | LOW LIMIT_L | Flag - low true |
| 4 | DATA VALID_L | Flag - low true |
| 5 | SAMPLING_H | Flag - high true |
| 6 | TRIG. TOO FAST_L | Flag - low true |
| 7 | DIGITAL COMMON | |
| 8 | ANALOG OUTPUT | (Option 70 only) |
| 9 | OVERLOAD_L | Flag - low true |
| 10 | AN. O/P ENABLE_L | Input - low true |
| 11 | SPARE | |
| 12 | SPARE | |
| 13 | HOLD_L | Input - low true |
| 14 | DIGITAL COMMON | |
| 15 | ANALOG O/P 0V | (Option 70 only) |

SHIELD**DIGITAL COMMON****ANALOG O/P 0V**

Pins 1, 7, 14 and 15 are internally connected together.

'Numeric Keyboard' keys

Keyboard Facility

Seventeen of the menu keys double as numeric keyboard keys when certain menus appear on the dot-matrix display, and in most cases all other keys are locked out. As well as the numbers 0 to 9, the decimal point and the polarity changeover (+/-) keys, five other functions are represented.

Exp

The number appearing on the numeric display to the right of 'E' is a power of ten, by which the number to the left of the E is multiplied. The Exp key is used to enter E into the expression.

Enter

After assembling the number within a menu, the Enter key is pressed to confirm that it is to be used. Usually the word Enter also appears in the menu. In some cases the Enter command enables another key, or presents another menu.

Quit

For a few menus (associated with 'Cal') the Quit key is provided for convenient exit, without activating any process.

When a selftest or selfcal operation is in progress, the word Abort appears above the Quit key to exit from the process.

← ('Monitor' key)

Deletes the previous numerical character.

Last rdg

When a reading from the main display is required to be incorporated into a process, the Last rdg key can be used to enter the value of the most-recent measurement on to the dot-matrix menu.

Note to users: For the sake of completeness, this appendix collects together the error codes which might be generated either on the instrument front panel, or via the IEEE 488 system bus.

Error Detection

All errors which cannot be recovered without the user's knowledge, result in some system action to inform the user via a message, and where possible restore the system to an operational condition. Errors are classified by the method with which they are handled. Recoverable errors report the error and then continue. System errors which cannot be recovered cause the system to halt with a message displayed. Restarting the instrument from Power On may clear the error, but generally such messages are caused by hardware or software faults, which require user action.

Error Messages

Fatal System Errors

For all fatal system errors, the error condition is reported only via the front panel. The processor stops after displaying the message. A user must respond by retrying operation from power on, and initiate repair if the fault persists. The following is a list of error numbers displayed, with their associated fault descriptions:

- 9000 - System Kernel Fault
- 9001 - Run Time System Error
- 9002 - Unexpected Exception
- 9003 - PROM Sumcheck Failure
- 9004 - RAM Check Failure
- 9005 - Serial Interface Fault
- 9006 - Option Test Failure
- 9007 - Unknown Engine Instruction
- 9099 - Undefined Fatal Error

Recoverable Errors

These consist of **Command Errors**, **Execution Errors** and **Device-Dependent Errors**. Command Errors can only be generated due to incorrect remote programming. Some Execution Errors and all Device-Dependent Errors can all be generated by manual operation as well. Each of the reportable Execution and Device-Dependent Errors are identified by a code number.

Command Errors (CME)

(Remote operation only)

Command Errors are generated when the remote command does not conform, either to the device command syntax, or to the IEEE 488.2 generic syntax. The CME bit (5) is set *true* in the Standard-defined Event Status Byte, but there is no associated queue.

The error is reported by the mechanisms described in the sub-section of Section 5 which deals with status reporting.

Errors generated due to incorrect front panel manipulation are not reported to the bus; and vice versa.

Execution Errors (EXE)

An Execution Error is generated if a received command cannot be executed because it is incompatible with the current device state, or because it attempts to command parameters which are out-of-limits.

In remote operation, the EXE bit (4) is set *true* in the Standard-defined Event Status Byte, and the error code number is appended to the Execution Error queue.

The error is reported by the mechanisms described in the sub-section of Section 5 which deals with status reporting, and the queue entries can be read destructively as LIFO by the Common query command *EXQ?.

There is no queue when execution errors are generated during manual operation, the description of the error being presented directly on the Menu display.

The Execution Error numbers are given on the opposite page, with their associated descriptions.

List of Execution Errors

- 1000 - EXE queue empty when recalled
- 1001 - Option not installed
- 1002 - Calibration disabled
- 1003 - Ratio/Function combination not allowed
- 1004 - Filter incompatible with Function
- 1005 - Input Zero not allowed in Ratio
- 1006 - Calibration not allowed in Ratio
- 1007 - Data entry error
- 1008 - Must be in AC Function
- 1009 - Pass Number entry error
- 1010 - Divide-by-zero not allowed
- 1012 - No more errors in list
- 1013 - Data out of limit
- 1014 - Illegal Range/Function combination
- 1015 - Command allowed only in Remote
- 1016 - Not in Special Calibration
- 1017 - Calibration not allowed with Math
- 1018 - Key not in the Cal Enabled position
- 1019 - Spec not compatible with Function
- 1020 - Internal Source Cal required
- 1021 - Test not allowed when Cal enabled
- 1022 - No parameter for this Function
- 1023 - Input zero not allowed in ACI

Recoverable Errors (contd)**Device-Dependent Errors (DDE)**

A Device-Dependent Error is generated if the device detects an internal operating fault (eg. during self-test). The DDE bit (3) is set *true* in the Standard-defined Event Status Byte, and the error code number is appended to the Device-Dependent Error queue.

In Remote, the error is reported by the mechanisms described in the sub-section of Section 5 which deals with status reporting, and the queue entries can be read destructively as LIFO by the Common query command *DDQ?.

In Local, the DDE status is checked at the end of the operation (eg. Cal, Zero, Test). If *true*, an error has occurred, and the content of the last entry in the queue is displayed on the front panel.

If both bus and front panel users attempt to read the queue concurrently, the error data is read out destructively on a first-come, first-served basis. Thus one of the users cannot read the data on one interface as it has already been destroyed by reading on the other. This difficulty should be solved by suitable application programming to avoid the possibility of a double readout. Ideally the IEEE 488 interface should set the instrument into REMS or RWLS to prevent confusion. The bus can ignore the queue, but the front panel user will have to read it to continue.

Device-Dependent Error Lists

Device-dependent errors are associated mainly with test and calibration operations. The error numbers in the following pages are therefore listed in these categories. There is some overlap.

The error list for external calibration operations, with their associated descriptions, are given on the opposite page. The self-calibration and internal source calibration error list commences overleaf.

External Calibration Operations

Correction Errors

- 2000 - Zero Correction Error
- 2001 - Gain+ Correction Error
- 2002 - Gain- Correction Error
- 2003 - HF trim Correction Error
- 2004 - Input Correction Error
- 2005 - LoI Zero Correction Error
- 2006 - LoI Gain Correction Error
- 2008 - A to D Correction Error
- 2009 - Reference Error
- 2010 - Frequency Correction Error
- 2011 - DAC Correction Error
- 2012 - Standardise Error

Corruptions

- 2013 - Key/Pass# flags Corrupt
- 2014 - Serial Number Corrupt
- 2015 - Cal Due Date Corrupt
- 2016 - Self-corrections Flag Corrupt
- 2017 - Bus Address Corrupt
- 2018 - Line Frequency Corrupt
- 2020 - Measurement Corrections Corrupt
- 2021 - Measurement Corrections Invalid
- 2022 - NV RAM Write Failure

Non-volatile RAM Checksum Errors

- 2100 - Primary NV Checksum Error
- 2101 - Secondary NV Checksum Error
- 2102 - Input Zero NV Checksum Error
- 2103 - Frequency NV Checksum Error

Others

- 2104 - Switches not optimum
- 2105 - Requires internal source calibration
- 2106 - NV RAM Protection Failure
- 2109 - Bad data from analog sub-system

Self Calibration and Internal Source Calibration Operations

The codes for these operations are related to steps in the sequence of calibrations implemented by the processor. They will appear only if the calibration has not been successful, and should be reported for interpretation to your local Datron service center, so that the fault can be analyzed.

In the following table, the error allocated to each step appears against its step number. A short description of the test step is also given.

For measurements of noise and magnitude, a series of readings is taken. Some early readings are discarded to allow for settling; and of the others, the highest and the lowest readings are also discarded. The remainder are used to calculate:

- the standard deviation for noise measurement, and
- the mean for magnitude measurement.

* All the steps are included in 'Full Selftest', 'Selfcal' and 'Internal Source Cal'. But not all are included in 'Fast Selftest'; so to distinguish those that are, their step numbers in the sequence are followed by an asterisk (*). For these steps, the Fast Selftest limits are wider than for Full Selftest, Selfcal or Internal Source Cal. Also, because of the lower resolution in Fast Selftest, more readings can be taken in the same number of line cycles.

The methods of reporting unsuccessful tests are described under the paragraphs dealing with the tests or self calibrations. The generation of an error code accompanies an unsuccessful test. Its results will be, at the least, out of test limits.

Step Function**Fuse Tests**

- 2101* Fuse is open circuit.
- 2102* Fuse fault other than o/c

Memory Tests

The following NV memory checksums do not agree with their stored values.

- 2110* Primary.
- 2111* Secondary.

- 2112* Input Zero.
- 2113* Frequency.

Reference Ratio Tests

- 2121* Reference zero noise.
- 2122* Reference zero magnitude.

- 2131* Ref 2 noise.
- 2132* Ref 2 magnitude.

- 2141* Ref 1 noise.
- 2142* Ref 1 magnitude.
- 2143* Ref 1 : Ref 2 Magnitude Ratio drift.

- 2151* Positive Reference noise.
- 2152* Positive Reference magnitude.
- 2153* Negative Reference noise.
- 2154* Negative Reference magnitude.
- 2155 Ref+ : Ref- Magnitude Ratio.
- 2156 Ref+ : Ref- Magnitude Ratio drift.

DC Voltage Tests**True Zero Measurements**

- 2161 DC 10V range zero noise.
- 2162 DC 10V range zero magnitude.
- 2163 DC 10V range zero drift.

- 2171 DC 1V range zero noise.
- 2172 DC 1V range zero magnitude.
- 2173 DC 1V range zero drift.

- 2181* DC 100mV range zero noise.
- 2182* DC 100mV range zero magnitude.
- 2183 DC 100mV range zero drift.

- 2191 DC 100V range zero noise.
- 2192 DC 100V range zero magnitude.
- 2193 DC 100V range zero drift.

- 2201 DC 1000V range zero noise.
- 2202 DC 1000V range zero magnitude.
- 2203 DC 1000V range zero drift.

Negative Gain Measurements

(Offsets {Zero} and References)

- 2211 -1V offset noise.
- 2212 -1V offset magnitude.
- 2213 -1V reference noise.
- 2214 -1V reference magnitude.
- 2215 -10V offset noise.
- 2216 -10V offset magnitude.

Positive Gain Measurements

(Offsets {Zero} and References)

- 2221 10V offset noise.
- 2222 10V offset magnitude.
- 2223 10V loaded offset noise.
- 2224 10V loaded offset magnitude.

- 2231 1V offset noise (atten. 10V).
- 2232 1V offset magnitude (atten. 10V).

- 2233 100mV offset noise (atten. 10V).
- 2234 100mV offset magnitude (atten. 10V).

- 2241 1V offset noise.
- 2242 1V offset magnitude.

- 2251 10V +Ref noise.
- 2252 10V +Ref magnitude.
- 2253 10V +Ref magnitude drift.

- 2261 10V loaded gain noise.
- 2262 10V loaded gain magnitude.
- 2263 10V loaded gain magnitude drift.

- 2271 1V Range - 100mV signal noise.
- 2272 1V Range - 100mV signal magnitude.
- 2273 1V Range - 100mV signal magnitude drift.

- 2281 100mV Range - 100mV signal noise.
- 2282 100mV Range - 100mV signal magnitude.
- 2283 100mV Range - 100mV signal magnitude drift.

- 2291 1V reference noise.
- 2292 1V reference magnitude.
- 2293 1V reference drift.

* = Also included in Fast Test

AC Voltage Tests**1V AC Range Selected**

- 2301 1VAC Input noise.
- 2302 1VAC Input magnitude.

- 2311* 1VAC preamp output noise.
- 2312* 1VAC preamp output magnitude.

- 2321* +RMS output noise.
- 2322* +RMS output magnitude.

100mV AC Range Selected

- 2331 100mVAC Input noise.
- 2332 100mVAC Input magnitude.

- 2341* 100mVAC preamp output noise.
- 2342* 100mVAC preamp output magnitude.

10V AC Range Selected

- 2351 10VAC Input noise.
- 2352 10VAC Input magnitude.

- 2361 10VAC preamp output noise.
- 2362 10VAC preamp output magnitude.

100V AC Range Selected

- 2371 100VAC Input noise.
- 2372 100VAC Input magnitude.

- 2381 100VAC preamp output noise.
- 2382 100VAC preamp output magnitude.

1kV AC Range Selected

- 2391 1kVAC Input noise.
- 2392 1kVAC Input magnitude.

- 2401 1kVAC preamp output noise.
- 2402 1kVAC preamp output magnitude.

* = Also included in Fast Test

1V AC Range Selected

- 2411 1VAC Input noise.
- 2412 1VAC Input magnitude.

- 2421* 1VAC preamp output noise.
- 2422* 1VAC preamp output magnitude.

- 2431* -RMS output noise.
- 2432* -RMS output magnitude.
- 2433 1V offset magnitude.
- 2434 1V preamp gain drift.
- 2435 +RMS gain.
- 2436 +RMS gain drift.
- 2437 -RMS gain.
- 2438 -RMS gain drift.

100mV AC Range Selected

- 2441 100mVAC Input noise.
- 2442 100mVAC Input magnitude.

- 2451 100mVAC preamp output noise.
- 2452 100mVAC preamp output magnitude.
- 2453 100mV preamp gain drift.

10V AC Range Selected

- 2461 10VAC Input noise.
- 2462 10VAC Input magnitude.

- 2471* 10VAC preamp output noise.
- 2472* 10VAC preamp output magnitude.
- 2473 10V preamp gain drift.

100V AC Range Selected

- 2481 100VAC Input noise.
- 2482 100VAC Input magnitude.

- 2491* 100VAC preamp output noise.
- 2492* 100VAC preamp output magnitude.
- 2493 100V preamp gain drift.

1kV AC Range Selected

- 2501 1kVAC Input noise.
- 2502 1kVAC Input magnitude.

- 2511* 1kVAC preamp output noise.
- 2512* 1kVAC preamp output magnitude.
- 2513 1kV preamp drift.

* = Also included in Fast Test

DC Current Tests**10mA DC Range Selected**

- 2521 10mA range zero noise.
- 2522 10mA range zero magnitude.
- 2523 10mA range zero magnitude drift.
- 2524 10mA range zero offset drift.
- 2525 10mA range zero offset magnitude drift.

- 2531* 10mA range gain noise.
- 2532* 10mA range gain magnitude.
- 2533 10mA range gain drift.

100mA DC Range Selected

- 2541 100mA range zero noise.
- 2542 100mA range zero magnitude.
- 2543 100mA range zero drift.

- 2551* 100mA range gain noise.
- 2552* 100mA range gain magnitude.
- 2553 100mA range gain drift.

1A DC Range Selected

- 2561 1A range zero noise.
- 2562 1A range zero magnitude.
- 2563 1A range zero drift.

- 2571* 1A range gain noise.
- 2572* 1A range gain magnitude.
- 2573 1A range gain drift.

1mA DC Range Selected

- 2581 1mA range zero noise.
- 2582 1mA range zero magnitude.
- 2583 1mA range zero drift.

- 2591* 1mA range gain noise.
- 2592* 1mA range gain magnitude.
- 2593 1mA range gain drift.

100µA DC Range Selected

- 2601 100µA range zero noise.
- 2602 100µA range zero magnitude.
- 2603 100µA range zero drift.

- 2611* 100µA range gain noise.
- 2612* 100µA range gain magnitude.
- 2613 100µA range gain drift.

* = Also included in Fast Test

AC Current Tests

10mA AC Range Selected

- 2621 10mA range gain noise (10mA Input).
- 2622 10mA range gain magnitude (10mA Input).

- 2631 100mA range gain noise (100 μ A Input).
- 2632 100mA range gain magnitude (100 μ A Input).

Resistor Ratio Tests

**1k Ω Standard Resistor Tests
True Zero**

- 2721 1k Ω resistor true zero noise.
- 2722 1k Ω resistor true zero magnitude.
- 2723 1k Ω resistor true zero drift.

Normal measurement

- 2724 1k Ω resistor gain noise.
- 2725 1k Ω resistor gain magnitude.
- 2726 1k Ω resistor gain drift.

100k Ω Standard Resistor Tests

True Zero

- 2731 100k Ω resistor true zero noise.
- 2732 100k Ω resistor true zero magnitude.
- 2733 100k Ω resistor true zero drift.

Normal measurement

- 2734* 100k Ω resistor gain noise.
- 2735* 100k Ω resistor gain magnitude.
- 2736 100k Ω resistor gain drift.

Standard Resistors Ratio

Ratio-Drift Calculation

- 2737 Standard resistor ratio drift.

* = Also included in Fast Test

Normal and LOI Ohms Ranges Tests**100Ω Range Selected**

- 2741 100Ω range high-current true zero noise.
 2742 100Ω range high-current zero magnitude.
 2743 100Ω range high-current zero drift.
- 2751* 100Ω range high-current gain offset noise.
 2752* 100Ω range high-current offset magnitude.
 2753* 100Ω range high-current gain noise.
 2754* 100Ω range high-current gain magnitude.
 2755 100Ω range high-current gain drift.
- 2761 100Ω range low-current true zero noise.
 2762 100Ω range low-current zero magnitude.
 2763 100Ω range low-current zero drift.

1kΩ Range Selected

- 2771 1kΩ range high-current true zero noise.
 2772 1kΩ range high-current zero magnitude.
 2773 1kΩ range high-current zero drift.
- 2781* 1kΩ range high-current gain noise.
 2782* 1kΩ range high-current gain magnitude.
 2783 1kΩ range high-current gain drift.

10kΩ Range Selected

- 2791 10kΩ range high-current true zero noise.
 2792 10kΩ range high-current zero magnitude.
 2793 10kΩ range high-current zero drift.
- 2801 10kΩ range low-current true zero noise.
 2802 10kΩ range low-current zero magnitude.
 2803 10kΩ range low-current zero drift.

100kΩ Range Selected

- 2811 100kΩ range low-current true zero noise.
 2812 100kΩ range low-current zero magnitude.
 2813 100kΩ range low-current zero drift.
- 2821* 100kΩ range low-current gain noise.
 2822* 100kΩ range low-current gain magnitude.
 2823 100kΩ range low-current gain drift.

1MΩ Range Selected

- 2831 1MΩ range high-current true zero noise.
 2832 1MΩ range high-current zero magnitude.
 2833 1MΩ range high-current zero drift.
- 2841 1MΩ range high-current gain offset noise.
 2842 1MΩ range high-current offset magnitude.
 2843* 1MΩ range high-current gain noise.
 2844* 1MΩ range high-current gain magnitude.
 2845 1MΩ range high-current gain drift.
- 2851 1MΩ range low-current true zero noise.
 2852 1MΩ range low-current zero magnitude.
 2853 1MΩ range low-current zero drift.
- 2861 1MΩ range low-current gain noise.
 2862 1MΩ range low-current gain magnitude.
 2863 1MΩ range low-current gain drift.

* = Also included in Fast Test

Section 4 - Using the 1271**Hi Ohms Ranges Tests****10M Ω Range Selected**

2871 10M Ω range high-current true zero noise.
2872 10M Ω range high-current zero magnitude.
2873 10M Ω range high-current zero drift.

2881 10M Ω range low-current true zero noise.
2882 10M Ω range low-current zero magnitude.
2883 10M Ω range low-current zero drift.

2891 10M Ω range low-current gain noise.
2892 10M Ω range low-current gain magnitude.
2893 10M Ω range low-current gain drift.

100M Ω Range Selected

2901 100M Ω range true zero noise.
2902 100M Ω range zero magnitude.
2903 100M Ω range zero drift.

1G Ω Range Selected

2911 1G Ω range true zero noise.
2912 1G Ω range zero magnitude.
2913 1G Ω range zero drift.

SECTION 5 SYSTEMS APPLICATION via the IEEE 488 INTERFACE

| | |
|---|----------|
| Alphabetical Index of IEEE 488.2 Codes used in the 1271 | Overleaf |
| Introduction | 5-1 |
| Interface Capability | 5-1 |
| Interconnections | 5-3 |
| Typical System | 5-4 |
| Using the 1271 in a System | 5-6 |
| Addressing the 1271 | 5-6 |
| Remote Operation | 5-7 |
| Programming Guidance | 5-8 |
| Message Exchange | 5-14 |
| Service Request | 5-18 |
| Retrieval of Device Status Information | 5-19 |
| The 1271 Status Reporting Structure | 5-19 |
| 1271 Status Reporting - Detail (see also pages 5-78) | 5-23 |
| 1271 Commands and Queries - Syntax Diagrams | 5-30 |
| DC Voltage | 5-30 |
| AC Voltage (Options 10 & 12) | 5-32 |
| Resistance (Option 20) | 5-36 |
| DC Current (Option 30 with Option 20) | 5-42 |
| AC Current (Option 30 with Options 10, 12 and 20) | 5-44 |
| Input Control | 5-46 |
| Monitor Messages | 5-48 |
| Math | 5-54 |
| Test | 5-64 |
| Triggers and Readings | 5-68 |
| Delay and Default Tables | 5-71 |
| Internal Operations | 5-76 |
| Status Reporting (see also page 5-23) | 5-78 |
| Instrument I/D and Setup | 5-86 |
| Calibration Commands and Messages | 5-88 |
| <hr/> | |
| (See Notes on page 5-88) | |
| Internal Buffer | 5-109 |
| Appendix A: IEEE 488.2 Device Documentation Requirements | 5-A1 |
| Appendix B: 1271 Device Settings at Power On | 5-B1 |

Section 5 - System Operation

| Command/Query Code | Description | Page 5- |
|--------------------|---|-----------------------|
| ACCP | Selects AC-coupled measurements | 32; 44 |
| ACI | Selects AC Current function | 44 |
| ACV | Selects AC Voltage function | 32 |
| AUTO | Automatic range selection | 30; 32; 36; 40;42; 44 |
| AVG AV4/8/16/32/64 | Rolling average | 54 |
| AVG BLOC_N | Block Averaging of N readings | 54 |
| AVG OFF | Deselects averaging mode | 54 |
| BLOCK (Nrf) | Sets and arms Block mode & stores (Nrf) readings | 109 |
| BLOCK? (Nrf),(Nrf) | Recalls stored readings between (Nrf),(Nrf) | 111 |
| C (Nrf) | Sets subtraction constant to Nrf value | 58 |
| C LAST_RDG | Puts most-recent reading to C store | 58 |
| C? | Recalls subtraction constant C | 59 |
| CAL? | Triggers external calibration to nominal or zero | 90 |
| CAL? Nrf | Triggers external 'SET' gain calibration | 90 |
| CHSE? ADC | Triggers special calibration of the A-D converter | 96 |
| CHSE? DAC | Triggers special calibration of the analog output | 96 |
| CHSE? FREQ | Triggers special calibration of the frequency counter | 96 |
| CLR MAX | Clears MAX store | 51 |
| CLR MIN | Clears MAX store | 51 |
| CLR PKPK | Clears MAX and MIN stores | 51 |
| CLRMEM ALL | Clears all calibration memories | 106 |
| CLRMEM EXT | Clears external calibration memories only | 106 |
| CLRMEM HFTRIM | Clears AC HF calibration memories only | 106 |
| CLRMEM SELF | Clears self-calibration memories only | 106 |
| CNFTST? | Fast Test: returns '0' if OK, otherwise '1' | 65 |
| COUNT? | Recalls number of readings in Block mode store | 110 |
| DB OFF | Cancel dB calculations | 62 |
| DB ON | Selects dB calculation for subsequent readings | 62 |
| DB_REF R50 | Sets reference level of 1mW in 50Ω | 62 |
| DB_REF R75 | Sets reference level of 1mW in 75Ω | 62 |
| DB_REF R600 | Sets reference level of 1mW in 600Ω | 62 |
| DB_REF UNITY | Sets reference level of unity | 62 |
| DB_REF? | Recalls the set reference level | 63 |
| DCCP | Selects (DC+AC)-coupled measurements | 32; 44 |
| DCI | Selects DC Current Function | |
| DCV | Selects DC Voltage function | 30 |
| DDQ? | Recalls most-recent device error from queue | 66 |
| DELAY DFLT | Sets default delay for reading | 70/71 |
| DELAY Nrf | Sets settle delay of Nrf seconds | 70 |
| DIV_Z OFF | Cancel division of readings by Z | 60 |
| DIV_Z ON | Divides subsequent readings by Z | 60 |

Alphabetical Index of IEEE 488.2 Codes used in the 1271

| Common Command/Query Code | Description | Page 5- |
|------------------------------|---|------------|
| *CAL? | Performs 1271 Selfcal: returns '0' if OK, otherwise '1' | 98 |
| *CLS | Clears event registers and Queues (not O/P queue) | 83 |
| *ESE Nrf | Enables standard-defined event bits | 81 |
| *ESE? | Returns ESE register mask value | 81 |
| *ESR? | Reads Event Status register | 81 |
| *IDN? | Reports manufacturer, model, etc. | 86 |
| *OPC | Conforms, but not relevant to 1271 application | 77 |
| *OPC? | Conforms, but not relevant to 1271 application | 77 |
| *OPT? | Recalls option configuration information | 87 |
| *PSC 0/1 | Sets/resets power-on status control flag | 84 |
| *PSC? | Returns power-on status control flag value | 84 |
| *PUD | Allows entry of user data to protected store | 94 |
| *PUD? | Recalls user-entered data | 95 |
| *RST | Resets instrument to power on condition | 76 / App B |
| *SRE Nrf | Enables Service Request Byte bits | 82 |
| *SRE? | Returns Service Request Byte mask value | 82 |
| *STB? | Non-destructively reads Service Request Byte | 83 |
| *TRG | Causes a single reading to be taken | 69 |
| *TST? | Full Selftest: returns '0' if OK, otherwise '1' | 64 |
| *WAI | Conforms, but not relevant to 1271 application | 73 |

Section 5 - System Operation

| Command/Query Code | Description | Page 5- |
|----------------------------|--|--------------------|
| ENBCAL EXTNL,Nrf | Enables external calibration | 89 |
| ENBCAL SELF,Nrf | Checks Selfcal interlocks | 89 |
| ENBCAL SPECIAL,Nrf | Accesses special calibration mode | 89 |
| EXITCAL (date string) | Exits external cal with due date option | 99 |
| EXQ? | Recalls most-recent execution from queue | 85 |
| EXT_DUE? | Recalls calibration-due date | 93 |
| FAST_OFF | Deselects fast mode | 30; 36; 40; 42 |
| FAST_ON | Selects fast mode | 30; 36; 40; 42 |
| FILT1000HZ/360HZ/40HZ/10HZ | Inserts analog filter (Option 10) | 32; 44 |
| FILT100HZ/40HZ/10HZ/1HZ | Inserts analog filter (Option 12) | 32; 44 |
| FILT_OFF | Removes analog filter (DC & Ω) | 30; 36; 38; 40; 42 |
| FILT_ON | Inserts analog filter (DC & Ω) | 30; 36; 38; 40; 42 |
| FREQ? (ACV & ACI only) | Recalls frequency of most-recent reading | 75 |
| FWR | Selects four-wire ohms connection | 36; 38 |
| GATE FAST_OFF (AC only) | Selects gate width (Freq rdgs) 1s | 49 |
| GATE FAST_ON (AC only) | Selects gate width (Freq rdgs) 50ms | 49 |
| GUARD LCL | Selects Local Guard | 47 |
| GUARD REM | Selects Remote Guard | 47 |
| HI_OHMS | Selects High Ohms Function | 38 |
| HILT (Nrf) | Sets high limit, (Nrf) to 8.5 digits | 52 |
| HILT? | Returns value of high limit | 52 |
| INPUT CH_A | Selects Rear Input Ch A only | 46 |
| INPUT CH_B | Selects Rear Input Ch B only (Opt 40) | 46 |
| INPUT DEVTN | Selects Rear Input Chs A & B with (A-B)/B (Opt 40) | 46 |
| INPUT DIV_B | Selects Rear Input Chs A & B with A/B (Opt 40) | 46 |
| INPUT FRONT | Selects Front Input only | 46 |
| INPUT OFF | Isolates all inputs | 46 |
| INPUT SUB_B | Selects Rear Input Chs A & B with A-B (Opt 40) | 46 |
| LIMIT OFF | Disables limit checking | 53 |
| LIMIT ON | Enables limit checking | 53 |
| LINEF 50 | Selects 50Hz line frequency operation | 97 |
| LINEF 60 | Selects 60Hz line frequency operation | 97 |
| LINEF? | Recalls line frequency operation setting | 97 |
| LOCK NUM_ON/OFF,KEY_ON/OFF | Determines interlocks required for Selfcal | 104 |
| LOI_OFF | Deselects low current Ohms mode | 36 |
| LOI_ON | Selects low current Ohms mode | 36 |
| LOLT (Nrf) | Sets low limit, (Nrf) to 8.5 digits | 52 |
| LOLT? | Returns value of low limit | 52 |

Codes in **Bold** type are Command Program Headers; those in normal type are Program Data Elements

| Command/Query Code | Description | Page 5- |
|------------------------------|---|------------|
| M (Nrf) | Sets multiplier M to Nrf value | 56 |
| M LAST_RDG | Puts most-recent reading into M store | 56 |
| M? | Recalls multiplier M | 57 |
| MAX? | Recalls maximum reading | 50 |
| MESE Nrf | Enables measurement event bits | 79 |
| MESE? | Returns MESE register mask value | 79 |
| MESR? | Reads Measurement Event Status register | 80 |
| MIN? | Recalls minimum reading | 50 |
| MUL_M OFF | Cancel multiplication of readings by M | 56 |
| MUL_M ON | Multiplies subsequent readings by M | 56 |
| N (Nrf) | (Nrf) is No. of rdgs for AVG BLOC_N | 55 |
| N? | Recalls active No. of rdgs for AVG BLOC_N | 55 |
| OHMS | Selects Normal Ohms function | 36 |
| PASS_NUM Nrf | Pass number entry for calibration | 104 |
| PKPK? | Recalls MAX?-MIN? difference | 50 |
| RDG? | Recalls most-recent reading | 74 |
| RESL5/6 (ACV; Hi Ω) | Sets A-D mode and resolution | 32; 38; 42 |
| RESL5/6/7/8 (DCV; OHMS; DCI) | Sets A-D mode and instrument resolution | 30; 36; 40 |
| SELF CORR OFF | Cancel selfcal corrections | 107 |
| SELF CORR ON | Applies selfcal corrections | 107 |
| SERIAL (12 ASCII chars) | Allows access to change the serial number | 105 |
| SPEC_DAY? | Recalls 24 hour spec. for reading | 48 |
| SPEC_YR? | Recalls 1 year spec. for reading | 48 |
| SRCE_CAL? | Triggers intl source char: returns '0' if OK, or else '1' | 108 |
| STD? Nrf | Triggers 'Standardize' external calibration | 92 |
| SUB_C OFF | Cancel subtraction of C from readings | 58 |
| SUB_C ON | Subtracts C from subsequent readings | 58 |
| TFER_OFF | ACV: Disables Transfer mode | 32 |
| TFER_ON | ACV: Enables Transfer mode | 32 |
| TRG_SRCE EXT | Enables external triggers as source | 68 |
| TRG_SRCE INT | Selects internal interval counter as source | 68 |
| TRUE_OHMS | Selects True Ohms function | 40 |
| TWR | Selects two-wire ohms connection | 36; 38 |
| UNC FREQ... | Allows entry of user's calibration uncertainty | 100 |
| UNC? | Recalls calibration uncertainty for the reading | 102 |
| X? | = *TRG;RDG? | |
| Z (Nrf) | Sets divisor Z to Nrf value | 60 |
| Z LAST_RDG | Puts most-recent reading into Z store | 60 |
| Z? | Recalls divisor Z | 61 |
| ZERO? | Initiates 'Input Zero' and response (not ACI) | 72 |

