

# TOSHIBA MOS MEMORY PRODUCTS

8,192 WORD × 8 BIT CMOS STATIC RAM

TC5564APL-15, TC5564APL-20  
TC5564AFL-15, TC5564AFL-20

PRELIMINARY

## DESCRIPTION

TC5564APL is 65536 bits static random access memory organized as 8192 words by 8 bits using CMOS technology, and operates with a single 5V power supply.

Advanced circuit techniques provides low power feature with a maximum operating of 5mA/MHz. Operation current depends on cycle time.

TC5564APL has three control inputs. Two chip enables ( $\overline{CE1}$ ,  $\overline{CE2}$ ) allow for device selection and data retention control. Output enable ( $\overline{OE}$ ) input provides fast memory access. When device is placed in standby mode with chip off state, standby current

is typically  $0.01\mu\text{A}$ . So the TC5564APL is suitable for use in various microprocessor application systems where low power and battery back up are required. Ultra low standby power allow not only battery but capacitance backup.

Pin assignment of TC5564APL is pin-compatible with the 64K bits EPROM (TMM2764D). RAM and EPROM are then interchangeable in the same socket, resulting in flexibility in the definition of the quantity of RAM versus EPROM in microprocessor application systems.

TC5564APL is offered in both a standard dual-in-line 28 pin plastic package (0.6 inch width) and small-out-line plastic flat package.

## FEATURES

- Low Power Dissipation  
5mA/MHz (MAX.) Operating  
 $0.2\mu\text{A}$  (MAX.) at  $T_a=25^\circ\text{C}$  Standby  
 $1.0\mu\text{A}$  (MAX.) at  $T_a=60^\circ\text{C}$  Standby
- 5V Single Power Supply
- Fully Static Operation
- Data Retention Voltage : 2.0~5.5V
- Plastic DIP and Plastic Flat Package
- Pin Compatible with 2764 type EPROM

## ● Access Time

	TC5564APL-15 TC5564AFL-15	TC5564APL-20 TC5564AFL-20
Address Access Time (MAX.)	150ns	200ns
$\overline{CE1}$ Access Time (MAX.)	150ns	200ns
$\overline{CE2}$ Access Time (MAX.)	150ns	200ns
$\overline{OE}$ Access Time (MAX.)	70ns	100ns

- Directly TTL Compatible : All Inputs and Outputs
- Wide Temperature Operation :  $-40\sim 85^\circ\text{C}$

## PIN CONNECTION (TOP VIEW)

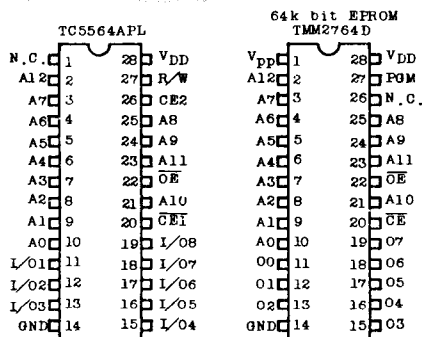

## BLOCK DIAGRAM

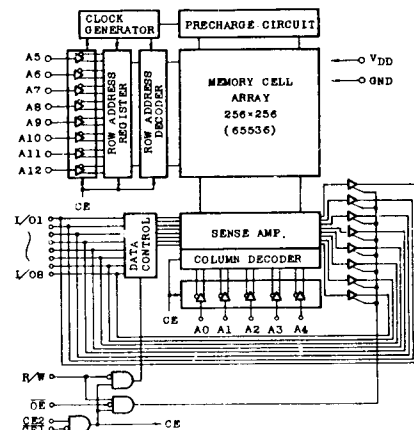

# TC5564APL-15, TC5564APL-20

## TC5564AFL-15, TC5564AFL-20

### PIN NAMES

A <sub>0</sub> ~A <sub>12</sub>	Address Inputs
R/W	Read/Write Control Input
$\overline{OE}$	Output Enable Input
$\overline{CE1}$ , CE2	Chip Enable Inputs
I/O1~I/O8	Data Input/Output
V <sub>DD</sub>	Power (+5V)
GND	Ground
N. C.	No Connection

### OPERATING MODE

Operation Mode	$\overline{CE1}$	CE2	$\overline{OE}$	R/W	I/O1~I/O8	Power
Read	L	H	L	H	D <sub>OUT</sub>	I <sub>DD0</sub>
Write	L	H	*	L	D <sub>IN</sub>	
Output Deselect	*	*	H	*	High-Z	I <sub>DD5</sub> I <sub>DD5</sub>
Standby	H	*	*	*	"	
	*	L	*	*	"	

### MAXIMUM RATINGS

SYMBOL	ITEM	RATING	UNIT
*V <sub>DD</sub>	Power Supply Voltage	-0.3~7.0	V
V <sub>IN</sub>	Input Voltage	-0.3**~V <sub>DD</sub>	V
V <sub>I/O</sub>	Input and Output Voltage	-0.5~V <sub>DD</sub> +0.5	V
P <sub>D</sub>	Power Dissipation	1.0(0.6)***	W
T <sub>solder</sub>	Soldering Temperature	260·10	°C·sec
T <sub>stg</sub>	Storage Temperature	-55~150	°C
T <sub>opr</sub>	Operating Temperature	-40~85	°C

\* 8.5V at 100ns.

\*\* -3.0V Pulse width 50ns

\*\*\* SOP

(Ta = -40~85°C)

SYMBOL	PARAMETER	MIN.	TYP.	MAX.	UNIT
V <sub>DD</sub>	Power Supply Voltage	4.5	5.0	5.5	V
V <sub>IH</sub>	Input High Voltage	2.2	—	V <sub>DD</sub> +0.3	V
V <sub>IL</sub>	Input Low Voltage	-0.3*	—	0.8	V
V <sub>DH</sub>	Data Retention Supply Voltage	2.0	—	5.5	V

\* -3.0V Pulse width 50ns

(Ta = -40~85°C, V<sub>DD</sub> = 5V ± 10% Unless other wise noted)

SYMBOL	PARAMETER	CONDITIONS	MIN.	TYP.	MAX.	UNIT
I <sub>IN</sub>	Input Leakage Current	V <sub>IN</sub> = 0~V <sub>DD</sub>	—	—	±1.0	μA
I <sub>OH</sub>	Output High Current	V <sub>OH</sub> = 2.4V	-1.0	—	—	mA
I <sub>OL</sub>	Output Low Current	V <sub>OL</sub> = 0.4V	4.0	—	—	mA
V <sub>OH</sub>	Output High Voltage	I <sub>OH</sub> = -20μA	V <sub>DD</sub> -0.1	—	—	V
V <sub>OL</sub>	Output Low Voltage	I <sub>OL</sub> = 20μA	—	—	0.1	V
I <sub>LO</sub>	Output Leakage Current	$\overline{CE1}$ = V <sub>IH</sub> or CE2 = V <sub>IL</sub> or R/W = V <sub>IL</sub> or $\overline{OE}$ = V <sub>IH</sub> , V <sub>OUT</sub> = 0~V <sub>DD</sub>	—	—	±1.0	μA

# TC5564APL-15, TC5564APL-20 TC5564AFL-15, TC5564AFL-20

SYMBOL	PARAMETER	CONDITIONS		MIN.	TYP.	MAX.	UNIT	
I <sub>DD01</sub>	Operating Current	$\overline{CE1} = V_{IL}$ and $CE2 = V_{IH}$ Other Input = $V_{IH}/V_{IL}$ $I_{OUT} = 0mA$	$t_{cycle} = 1\mu s$	—	—	10	mA	
			MIN CYCLE	TC5564APL-15 TC5564AFL-15	—	—		40
				TC5564APL-20 TC5564AFL-20	—	—		35
I <sub>DD02</sub>	Operating Current	$\overline{CE1} = 0.2V$ and $CE2 = V_{DD} - 0.2V$ , Other Input = $V_{DD} - 0.2V/0.2V$ $I_{OUT} = 0mA$ duty 100%	$t_{cycle} = 1\mu s$	—	—	5	mA	
			MIN CYCLE	TC5564APL-15 TC5564AFL-15	—	—		35
				TC5564APL-20 TC5564AFL-20	—	—		30
I <sub>DD01</sub>	Standby Current	$\overline{CE1} = V_{IH}$ or $CE2 = V_{IL}$		—	—	2	mA	
I <sub>DD02</sub>	Standby Current	$\overline{CE1} = V_{DD} - 0.2V$ or $CE2 = 0.2V$ $V_{DD} = 2.0 \sim 5.5V$	Ta = 25°C	—	0.01	0.2	μA	
			Ta = 60°C	—	—	1.0		

Note : (1) In standby mode with  $\overline{CE1} \geq V_{DD} - 0.2V$ , these specification limits are guaranteed under the condition of  $CE2 \geq V_{DD} - 0.2V$  or  $CE2 \leq 0.2V$ .  
(2) All voltage is measured from GND.

## CAPACITANCE (Ta = 25°C, f = 1MHz)

SYMBOL	PARAMETER	CONDITIONS	MAX.	UNIT
C <sub>IN</sub>	Input Capacitance	V <sub>IN</sub> = GND	10	pF
C <sub>OUT</sub>	Output Capacitance	V <sub>OUT</sub> = GND	10	pF

Note : This parameter is periodically sampled and is not 100% tested.

# TC5564APL-15, TC5564APL-20 TC5564AFL-15, TC5564AFL-20

## A. C. CHARACTERISTICS

### READ CYCLE

SYMBOL	PARAMETER	TC5564APL-15 TC5564AFL-15		TC5564APL-20 TC5564AFL-20		UNIT
		MIN.	MAX.	MIN.	MAX.	
t <sub>RC</sub>	Read Cycle Time	150	—	200	—	ns
t <sub>ACC</sub>	Address Access Time	—	150	—	200	
t <sub>CO1</sub>	$\overline{CE1}$ Access Time	—	150	—	200	
t <sub>CO2</sub>	CE2 Access Time	—	150	—	200	
t <sub>OE</sub>	Output Enable to Output in Valid	—	70	—	100	
t <sub>COE</sub>	Chip Enable to ( $\overline{CE1}$ , CE2) Output in Low-Z	10	—	10	—	
t <sub>OEE</sub>	Output Enable to Output Low-Z	5	—	5	—	
t <sub>OD</sub>	Chip Enable ( $\overline{CE1}$ , CE2) Output in High-Z	—	70	—	100	
t <sub>ODO</sub>	Output Enable to Output High-Z	—	60	—	80	
t <sub>OH</sub>	Output Data Hold Time	20	—	20	—	

### WRITE CYCLE

SYMBOL	PARAMETER	TC5564APL-15 TC5564AFL-15		TC5564APL-20 TC5564AFL-20		UNIT
		MIN.	MAX.	MIN.	MAX.	
t <sub>WC</sub>	Write Cycle Time	150	—	200	—	ns
t <sub>WP</sub>	Write Pulse Width	100	—	150	—	
t <sub>CW</sub>	Chip Selection to End of Write	120	—	180	—	
t <sub>AS</sub>	Address Set up Time	0	—	0	—	
t <sub>WR</sub>	Write Recovery Time	0	—	0	—	
t <sub>ODW</sub>	R/W to Output High-Z	—	70	—	100	
t <sub>OEW</sub>	R/W to Output Low-Z	10	—	10	—	
t <sub>DS</sub>	Data Set Up Time	60	—	80	—	
t <sub>DH</sub>	Data Hold Time	0	—	0	—	

### A. C. TEST CONDITIONS

- Input Pulse Levels : 2.4V/0.6V
- Timing Measurement Reference Levels : 2.2V/0.8V
- Output Reference Levels : 2.2V/0.8V
- Input Pulse Rise and Fall Times : 5ns
- Output Load : See Fig. 1

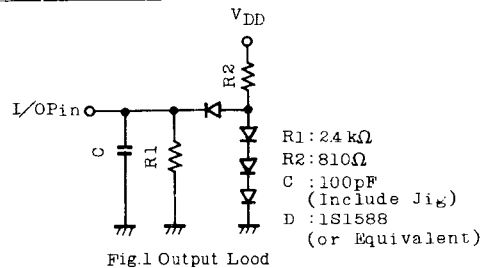

**TC5564APL-15, TC5564APL-20**  
**TC5564AFL-15, TC5564AFL-20**

**TIMING WAVEFORMS**

READ CYCLE (1)

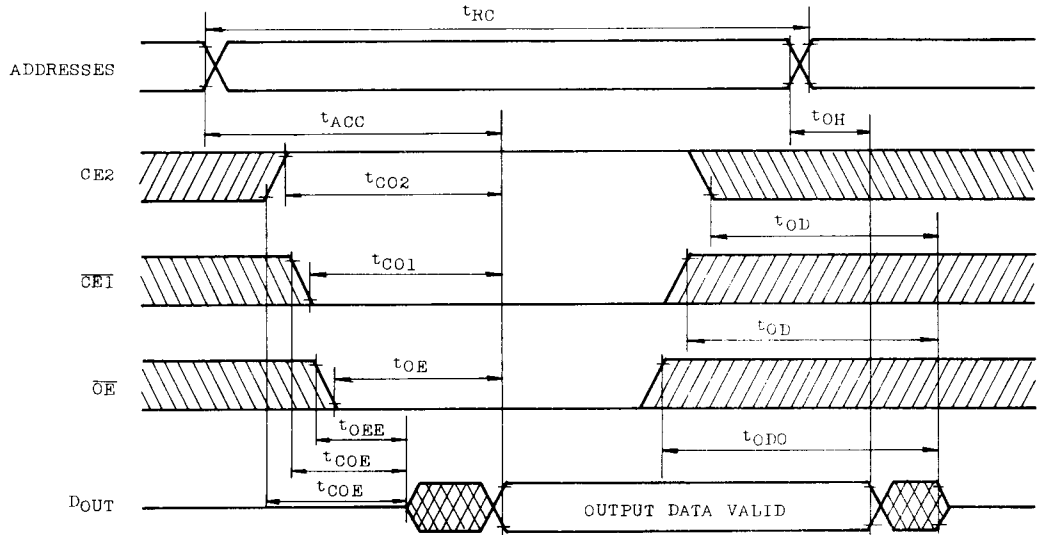

WRITE CYCLE (R/W Controlled Write)

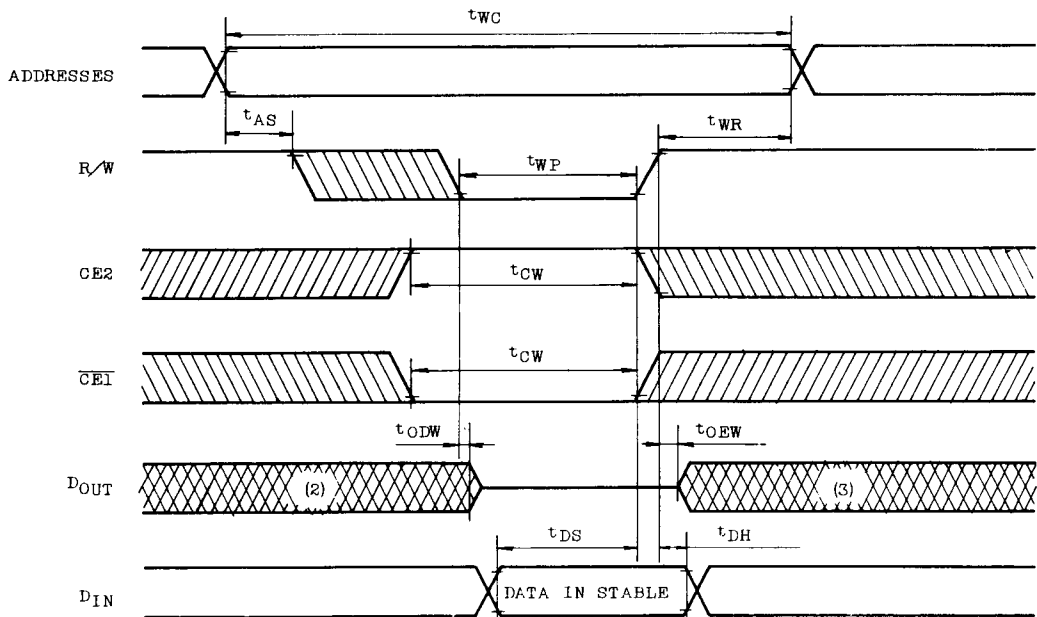

**TC5564APL-15, TC5564APL-20**  
**TC5564AFL-15, TC5564AFL-20**

**WRITE CYCLE 2 (4) ( $\overline{CE1}$  Controlled Write)**

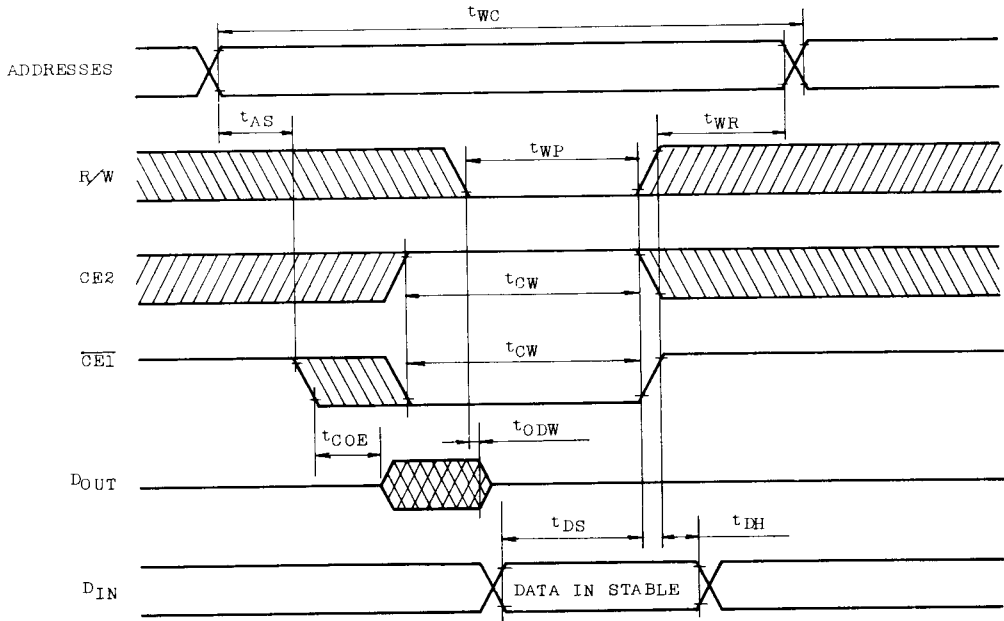

**WRITE CYCLE 3 (4) (CE2 Controlled Write)**

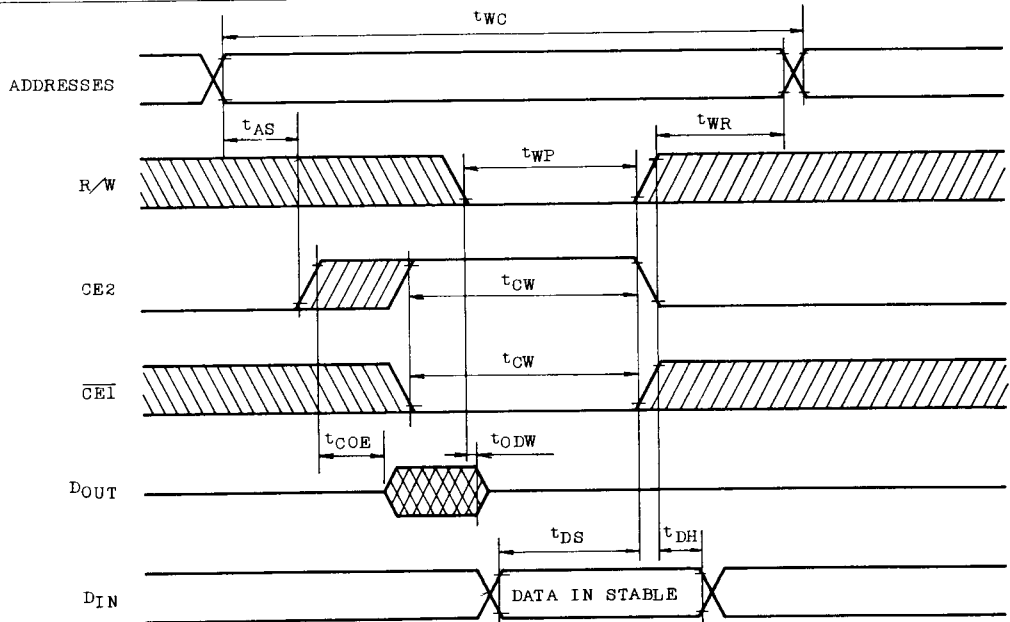

# TC5564APL-15, TC5564APL-20 TC5564AFL-15, TC5564AFL-20

Note : (1) R/W is High for Read Cycle. (2) Assuming that  $\overline{CE1}$  Low transition or CE2 High transition occurs coincident with or after R/W low transition, Outputs remain in a high impedance state. (3) Assuming that  $\overline{CE1}$  High transition or CE2 Low transition occurs coincident with or prior to R/W High transition, outputs remain in a high impedance state. (4) Assuming that  $\overline{OE}$  is High for Write Cycle, Outputs are in high impedance state during this period.

## DATA RETENTION CHARACTERISTICS (Ta = -40 ~ 85°C)

SYMBOL	PARAMETER	MIN.	TYP.	MAX.	UNIT	
V <sub>DH</sub>	Data Retention Supply Voltage	2.0	—	5.5	V	
I <sub>DD52</sub>	Standby Current	Ta = 25°C	—	0.01	0.2	μA
		Ta = 60°C	—	—	1.0	
t <sub>CDR</sub>	Chip Deselection to Data Retention Mode	0	—	—	μs	
t <sub>R</sub>	Recovery Time	t <sub>RC(1)</sub>	—	—	μs	

### CE1 Controlled Data Retention Mode (2)

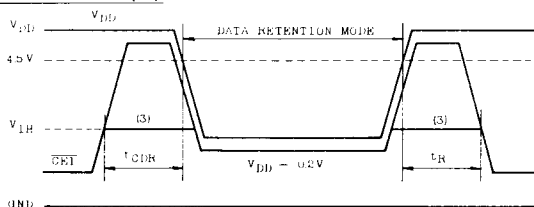

### CE2 Controlled Data Retention Mode (4)

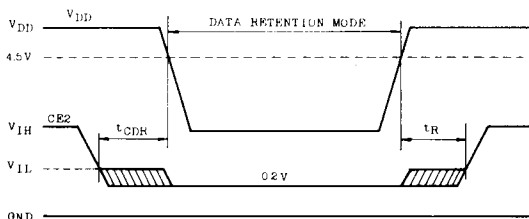

Note : (1) T<sub>RC</sub> : Read Cycle Time (2) In  $\overline{CE1}$  controlled data retention mode, minimum standby current mode is achieved under the condition of CE2 ≤ 0.2V or CE2 ≥ V<sub>DD</sub> - 0.2V. (3) If the V<sub>IH</sub> of  $\overline{CE1}$  is 2.2V in operation, during the period that the V<sub>DD</sub> Voltage is going down from 4.5 to 2.4V, I<sub>DD51</sub> current flows. (4) In CE2 controlled data retention mode, minimum standby current mode is achieved under the condition of CE2 ≤ 0.2V.

## DEVICE INFORMATION

The TC5564APL is an asynchronous RAM using address activated circuit technology, thus the internal operation is synchronous. Then once row address change occur, the precharge operation executed by internal pulse generated from row address transient. Therefore the peak current flows

after only row address change, as is shown in the following figure.

This peak current may induce the noise on V<sub>DD</sub>/GND line. Thus the use of about 0.1μF decoupling capacitor every device is recommended to eliminate such noise.

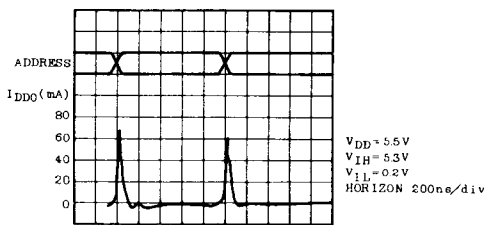
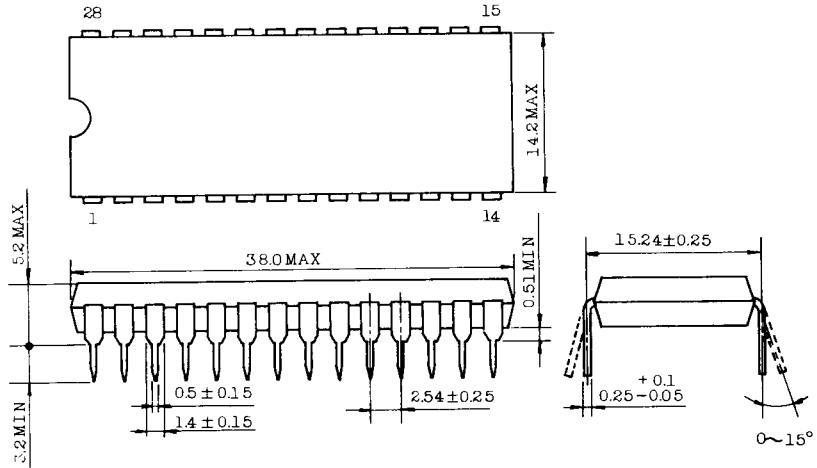

Fig. TYPICAL CURRENT WAVEFORMS

**TC5564APL-15, TC5564APL-20**  
**TC5564AFL-15, TC5564AFL-20**

DIP 28 PIN OUTLINE DRAWING (6D28A-P)

Unit in mm



Note : Lead pitch is 2.54 and tolerance is  $\pm 0.25$  against theoretical center of each lead that is obtained on the basis of No. 1 and No. 28 leads.

MFP 28 PIN OUTLINE DRAWINGS (F28GA-P)

Unit in mm

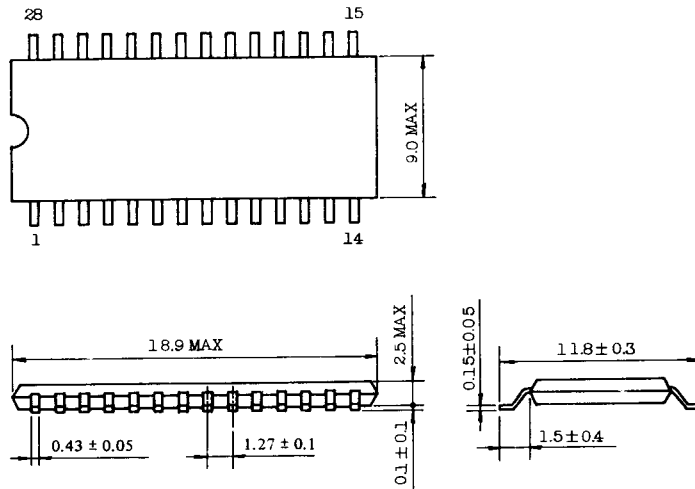

Note : Lead pitch is 1.27 and tolerance is  $\pm 0.12$  against theoretical center of each lead that is obtained on the basis of No.1 and No.28 leads.

Note : Toshiba does not assume any responsibility for use of any circuitry described : no circuit patent licenses are implied, and Toshiba reserves the right, at any time without notice, to change said circuitry.  
 © May, 1986 Toshiba Corporation