

Product:	Xilinx Zynq UltraScale+ MPSoC power and timing Stable FPGA MPSoC power solutions	RENESAS AVNET Reach Further™
Description:	<ul style="list-style-type: none"> • 64-bit processor scalability while combining real-time control with soft and hard engines for graphics, video, waveform and packet processing • Built on a common real-time processor and programmable logic-equipped platform 	 Download Datasheet

EEVblog Electronics Community Forum

A Free & Open Forum For Electronics Enthusiasts & Professionals

Hello volvo_nut_v70

Show unread posts since last visit.
Show new replies to your posts.
November 16, 2020, 08:08:23 pm

This topic

[Home](#) [Help](#) [Search](#) [Profile](#) [About us](#) [My Messages](#) [Calendar](#) [Links](#) [Members](#) [Logout](#)



EEVblog Electronics Community Forum » Electronics » Metrology » Is the Fluke 5440B really an artifact CAL instrument?



Power Up Your Bench!
30% off Used E36300 Series triple output power supplies

[SHOP NOW](#)



« previous next »

Pages: 1 2 [All] [Go Down](#)

[REPLY](#) [NOTIFY](#) [MARK UNREAD](#) [SEND THIS TOPIC](#) [PRINT](#) [SEARCH](#)

 **Author**

Topic: Is the Fluke 5440B really an artifact CAL instrument? (Read 10607 times)

volvo_nut_v70 and 0 Guests are viewing this topic.

e61_phil
Frequent Contributor



Posts: 883

Country: 



 **Is the Fluke 5440B really an artifact CAL instrument?**

« on: September 16, 2016, 01:14:45 pm »

[Say Thanks](#) [Reply](#) [Quote](#)

Hi,

again Fluke 5440B questions, sorry..

I wonder if the Fluke 5440B is an artifact calibration instrument which can calibrate all ranges from only one 10V source.

The manual will guide you to all ranges within the external calibration procedure and you can make adjustments in all of the ranges. Therefore, I think this calibration will tell the 5440B the real factors. After this the 5440B can compare the actual measured factors with the factors measured at calibration and compensate for it. It seems to be more like the AutoCAL function of the 34470A for example. Which can correct for temperature and some drift, but you have to calibrate the instrument in all ranges.

If I'm correct the 5440B can't be calibrated only with 10V if the unit has lost all of the calibration data. And if anyone has entered bad calibration values for example in the 1000V range this will not be corrected, if you calibrate only to an external standard (732x) with 10V.

Is my understanding correct?

Thanks
Philipp

[Report to moderator](#)  Logged

zlymex

 **Re: Is the Fluke 5440B really an artifact CAL instrument?**

[Say Thanks](#) [Reply](#) [Quote](#)

Frequent Contributor



Posts: 556

Country:



« Reply #1 on: September 16, 2016, 04:34:28 pm »

The internal calibration removes offsets and gain errors for 10V, 20V, 250V and 1000V ranges. But, internal calibration cannot remove Vref error just like any other DMM(34470A included). Also, the internal calibration has a small flaw(at least for 250V and 1000V range) that the calibration voltage is much smaller than working voltage for the sample string(of ten 200k). That ten 200k string is in a way a Hamon that can be paralleled to 20k during internal calibration.

There are several steps in the external calibration and the procedure is semi-automatic(semi-manual). **Only one voltage standard(10V) is required for external calibration for all ranges.** However, a voltage divider(752A) and a null meter are also required.

Report to moderator Logged

 e61_phil

Frequent Contributor



Posts: 883

Country:



Re: Is the Fluke 5440B really an artifact CAL instrument?

Say Thanks Reply Quote

« Reply #2 on: September 16, 2016, 05:00:22 pm »

Thus, just like the AutoCal of the 34470A (or any other AutoCal).

If these gain factors were factors against any artificial internal voltage which is created out of the 13V reference and the 10V calibration, then the calibration for all other ranges are only needed once in a lifetime. However, I'm afraid that the gain factors are related to the 13V reference. That will mean, if the 5440B has drifted to like say +10ppm isn't enough to do a calibration within the 10V range. You need to calibrate all ranges with a voltage divider, to get the new gain factors matching the actual 13V:(

10V is much easier to get than a 752A.

Unfortunately, I misunderstood Dr. Frank here:

"The internal 13V reference is calibrated via an external 10V standard. The scale factors of the 4 main ranges are determined by an auto cal process, which can be repeated at any time. An internal resistor divider delivers 220mV and 2.2V ranges, which have to be calibrated against external transfer standards (i.e. 752A or 3458A)." (amplifier.cd)

I hoped I get away with only 10V and without a Fluke 752A if I use the ranges 22V and above only.

« Last Edit: September 16, 2016, 05:05:10 pm by e61_phil »

Report to moderator Logged

 e61_phil

Frequent Contributor



Posts: 883

Country:



Re: Is the Fluke 5440B really an artifact CAL instrument?

Say Thanks Reply Quote

« Reply #3 on: September 16, 2016, 05:59:44 pm »

I'm with you DiligentMinds.

My (wrong) understanding from the text on amplifier.cd was: You need do compare the 10V and the rest is done by the instrument. An external nullmeter is imho okay to name it "artifact calibration". But if you need more instruments (like Fluke 752A) it is of course not an artifact calibrating unit.

Report to moderator Logged

 RobK_NL

Frequent Contributor



Posts: 250

Country:



Re: Is the Fluke 5440B really an artifact CAL instrument?

Say Thanks Reply Quote

« Reply #4 on: September 16, 2016, 07:41:00 pm »

Quote from: e61_phil on September 16, 2016, 05:00:22 pm

10V is much easier to get than a 752A.

I want to get rid of mine, so if you're interested, drop me a PM.

Report to moderator Logged

Tell us what problem you want to solve, not what solution you're having problems with

 Dr. Frank

Super Contributor



Posts: 1905

Country:

Re: Is the Fluke 5440B really an artifact CAL instrument?

Say Thanks Reply Quote

« Reply #5 on: September 16, 2016, 09:29:19 pm »

Well, the 5440/5442 is in fact an artifact calibration (AUTOCAL) instrument, with some limitations: - 0.1ppm resolution (of gain shift)



- small gain shifts only
- ranges 11V, 22V, 250V and 1100V only (cannot autocal 2.2V and 220mV ranges)

Fluke did not yet (at about 1986) call it clearly an artifact calibration instrument, maybe because they were not self-confident about this, and as the conservative metrology community would have grilled them.

When they introduced the artifact calibration with the 5700A, (early 1990-ties) they initially had a lot of trouble to be accepted by the NBS, and others, and a lot of additional verification had to be performed, before this 57xxA series became the artifact instrument standards, as of to-day.

The 3458A ACAL was accepted much easier, as somebody reported here, due to the close cooperation of NBS and HP on the JJ array research.

Anyway, if you read the service manual very carefully, especially paragraph 3-27, 3-28 about internal / external calibration, and the appendix "Recent innovations in DCV calibrator design", page A-11, it's quite evident, that the 544x acts exactly as an artifact instrument. (In fact the manuals are quite odd to read, it took me a while to discover this fact, between the lines, or out of what is NOT said)

One decisive hint is, that during calibration, you can always omit the complete external calibration, of course except the 10V calibration, that is the 10V (ext) to 13V (int) transfer.

After this initial step, you are allowed to take the short cut, and only do the internal calibration, for the above mentioned 4 higher ranges, w/o any specified penalty.

So up to this point, you only need an external 10V reference, but no 752A.

In the whole manual there is no restriction for that abbreviated procedure, so it should bring all ranges to their 24h limits, provided the internal 13V reference is still in cal.

Maybe, if the internal resistors had drifted too much, these small correction gain factors would get too big, and a complete external calibration would be necessary.

But as old instruments probably do not drift that much any more, this does also not occur. (Never got an internal cal error the last 7 years..)

Maybe also, that an extensive external calibration would provide greater resolution than 0.1ppm (see A-11), but this is not relevant for an ~0.5ppm grade instrument.

The internal/external cal uncertainty is also not clearly specified for neither case, and the Fluke 752A also provides 0.2 and 0.5ppm transfer uncertainties only.

The 5440B and the 57x0A both have a similar internal transfer / ACAL system inside, especially both have ovenized divider resistors.

This allows precise gain calibration of all DCV ranges, at low bridge excitation voltages, even for the High Voltage ranges.

Hint @ zlymex: the 5440B has no design flaw in this sense at all, because the temperature of the divider resistors is always constant, either with the 1000V burden (30sec stabilization required), or with the -13V bridge configuration. Other HV effects can be neglected, I think. Also, if that would be a design flaw, the 57xx instruments would have the very same, which is accepted to not be the case. Also, the 752A is calibrated at 20V level, even for the 100:1 / 1kV range, generating exceptional uncertainty, by T.C. matching, instead of ovenizing.

The 544x is even superior over the 57xx, as it uses the Hamon configuration, which is more precise (like the 752A) than the A/D or D/A dependent 10:1 transfers inside the 3458A (~0.3ppm) and the 57xx (< 1ppm 😊).

The 544x is superior over the 3458A at least in the 1000V range, as the 3458A lacks all kind of thermal compensation methods.

I also have compared the internal calibration function of my 5442A, against the 3458A and my Hamon type 100:1, 10:1 divider, and never found a contradiction to the assumed artifact calibration functionality of the 5442B.

All three agree always within about typ. 0.2ppm, whereas the 3458A is off by about -3ppm at 1000V, compared to the other instruments.

As a conclusion, the 544xB is definitely an artifact predecessor of the accepted 57xx instruments, but FLUKE maneuvered verbally around that fact, these days.

Frank

PS for e61_phil: Like all other ACAL instruments, this internal calibration is necessary once a day, at least, to compensate for short termed drifts.

Also, you interpreted my statements on amplifier.cd correctly, I think, maybe the German text is even more precise.



« Last Edit: September 16, 2016, 10:32:32 pm by Dr. Frank »

Report to moderator Logged

The following users thanked this post: klaus11, Henrik_V

 **e61_phil**
Frequent Contributor



Posts: 883
Country: 

 **Dr. Frank**
Super Contributor

Posts: 1905
Country: 

 **Re: Is the Fluke 5440B really an artifact CAL instrument?**

Say Thanks Reply Quote

« **Reply #6 on:** September 16, 2016, 09:41:44 pm »

I hopped you will answer here, thanks Dr. Frank 😊

If I understand you correct, I can stop the calibration after the 10V range and the other ranges will follow the "new" 13V?

What about a little experiment?

I got a "new" 5440B from singer at work. I don't have any calibration history and it seems to be about 6ppm down. The unit will go to the calibration lab in about two weeks. So, why not do a small test? I could start a 10V calibration and use 9,99V as "standard". After this step I will stop the calibration procedure. If the unit is able to do an artifact calibration, the 100V Range should give 99,9V.

What do you think?

Report to moderator  Logged

 **Re: Is the Fluke 5440B really an artifact CAL instrument?**

Say Thanks Reply Quote

« **Reply #7 on:** September 16, 2016, 10:21:45 pm »

Quote from: e61_phil on September 16, 2016, 09:41:44 pm

If I understand you correct, I can stop the calibration after the 10V range and the other ranges will follow the "new" 13V?

See page 3-21: No, you do not stop the calibration after step 12 or 13, in this sense, as you initially have already initiated the internal calibration, in step 1.

Quote from: e61_phil on September 16, 2016, 09:41:44 pm

What about a little experiment?

I got a "new" 5440B from singer at work. I don't have any calibration history and it seems to be about 6ppm down. The unit will go to the calibration lab in about two weeks. So, why not do a small test? I could start a 10V calibration and use 9,99V as "standard". After this step I will stop the calibration procedure. If the unit is able to do an artifact calibration, the 100V Range should give 99,9V.

What do you think?

Not good an idea, as this deviation will be too big, and maybe spoil completely the calibration of your own instrument.. because the internal calibration can handle "small" deviations only (whatever 'small' is, it's not specified). And what do you want to check, anyhow?

Principally, you need to compare each of the 4 ranges/ratios against an independent ratio instrument. If you use the calibrated Singer instrument as such, you might detect or confirm this ratio scaling effect to some degree of precision.

The Singer instrument should be calibrated completely with a 752A (extended calibration), otherwise you compare identical methods. (That's not independent from each other)

In the end, as soon as you engage the internal cal procedure, this will virtually overwrite the preceding calibration of the lab, won't it?

I would suggest instead to use a 3458A, or a 752A, to cross check these 4 ratios, up to 300V (which does not yet yield thermal non-linearities on the 3458A).

Frank

« *Last Edit: September 16, 2016, 10:34:29 pm by Dr. Frank* »

Report to moderator  Logged

 **e61_phil**
Frequent Contributor

 **Re: Is the Fluke 5440B really an artifact CAL instrument?**

Say Thanks Reply Quote

« **Reply #8 on:** September 16, 2016, 10:33:22 pm »

The singer 5440B will be calibrated with a 732A and a 752A in two weeks. Therefore, I thought it doesn't matter to play around with the singer unit before calibration. Everything I will mess up should



Posts: 883

Country:



be fixed after the calibration.

My intention was to verify, if the unit does really an artifact calibration if I will only calibrate the 10V range against a 732A. Ok, 9,99V is very much. I can also try to use a "standard" which is only about 10-20ppm shifted against the actual value. I need a deviation which I can measure for sure in another range (with a 34470A or 3458A).

1. measure 100V for example with a 3458A
2. "calibrate" the 10V of the 5440B to +20ppm
2. measure 100V again

If the unit will perform an artifact calibration, the 100V should also shifted by +20ppm.

« Last Edit: September 16, 2016, 10:44:09 pm by e61_phil »

Report to moderator Logged

Dr. Frank

Super Contributor



Posts: 1905

Country:



Re: Is the Fluke 5440B really an artifact CAL instrument?

Say Thanks

Reply

Quote

« Reply #9 on: September 16, 2016, 10:45:51 pm »

Quote from: e61_phil on September 16, 2016, 10:33:22 pm

The singer 5440B will be calibrated with a 732A and a 752A in two weeks. Therefore, I thought it doesn't matter to play around with the singer unit before calibration. Everything I will mess up should be fixed after the calibration.

My intention was to verify, if the unit does really an artifact calibration if I will only calibrate the 10V range against a 732A. Ok, 9,99V is very much. I can also try to use a "standard" which is only about 10-20ppm shifted against the actual value. I need a deviation which I can measure for sure in another range.

Both instruments might have the very same systematic deviation in their internal cal procedure, so you won't detect this by comparing identical techniques..

But you might do this test, without any re-calibration of your own unit; the freshly calibrated Singer box will very probably deviate sufficiently (a few ppm maybe) in the 10V range, and so will all other ranges do, ratio-wise.

Therefore, you only will have to compare each of these four ranges and calculate the ratios, should be exactly be 1:2:25:100, within < 1ppm.

Frank

Report to moderator Logged

e61_phil

Frequent Contributor



Posts: 883

Country:



Re: Is the Fluke 5440B really an artifact CAL instrument?

Say Thanks

Reply

Quote

« Reply #10 on: September 16, 2016, 10:53:00 pm »

What do you mean with "both instruments"? My test setup will only include a 3458A (or 34470A) and the singer 5440B. I will only change the calibration of the 10V (singer 5440B) and measure the 100V (out of the singer 5440B) before and after this "calibration" of the 10V range.

Sorry, for the confusions due to my bad english...

Report to moderator Logged

Dr. Frank

Super Contributor



Posts: 1905

Country:



Re: Is the Fluke 5440B really an artifact CAL instrument?

Say Thanks

Reply

Quote

« Reply #11 on: September 16, 2016, 11:23:34 pm »

Quote from: e61_phil on September 16, 2016, 10:53:00 pm

What do you mean with "both instruments"? My test setup will only include a 3458A (or 34470A) and the singer 5440B. I will only change the calibration of the 10V (singer 5440B) and measure the 100V (out of the singer 5440B) before and after this "calibration" of the 10V range.

Sorry, for the confusions due to my bad english...

Your English is fine, I think..

In first instance, you did not mention 3458A, or 34470A. So I thought, you would compare two 5440Bs against each other..

Anyhow, if you have a 3458A, you can rely on its de facto ratio / ACAL functionality (precise to about 0.02ppm / 0.3ppm), and simply determine the ratio values between the 11V, 22V, 250V and 1100V

ranges at first w/o de-calibrating anything. Choose clever values, to check range-ratios of the 5440B on the same 3458A range, and avoid self-heating effect of 3458A HV divider.
The precise ratio values, expected to be within < 1ppm (non-linearity of the D/A included) should be a first proof.

Then you might simulate a full external calibration of the 5440B, with slightly wrong ratios in the upper 3 ranges (leaving the 11V as it is), maybe 20ppm off, again using the 3458A.
After an internal cal of the 5440B, the ratios should be precise again.

I think, the 34470A may only be suitable to detect that sufficiently well, if it had been adjusted (not only calibrated!) recently, to <1ppm range / ratio uncertainty, like in the initial test report.
Although I assume, and also have measured, that its ACAL function now works very precisely with the latest FW 2.14 (*), this is not specified at all. Specification says something of +/-20ppm between ranges, within 24h..

Frank

(*) The 34465A/34470A had a FW flaw, so that the 100V and 1kV calibration were off by up to 20ppm, from the initial test report, and therefore also the ratio relative to the 10V range was off by that amount. So if your 34470A had been calibrated with FW < 2.14, you can forget that experiment.

« Last Edit: September 16, 2016, 11:43:09 pm by Dr. Frank »

[Report to moderator](#)  Logged

 **zlymex**

Frequent Contributor



Posts: 556

Country: 



 **Re: Is the Fluke 5440B really an artifact CAL instrument?**

« Reply #12 on: September 17, 2016, 01:31:22 am »

[Say Thanks](#)

[Reply](#)

[Quote](#)

Quote from: e61_phil on September 16, 2016, 05:00:22 pm

10V is much easier to get than a 752A.

That's true in a way now days, but in the old days 732A was the only decent 10V available from Fluke and had similar physical size as 752A, 732A probably costed not much less than 752A. Any one got the original list price for those two?

Also, 752A is self-calibratable at 0.2ppm and 0.5ppm while 732B must be externally calibrated and rated at 3ppm per year(old: 6 ppm per year), that will make the 10V more troublesome than 752A divider.

[Report to moderator](#)  Logged

 **zlymex**

Frequent Contributor



Posts: 556

Country: 



 **Re: Is the Fluke 5440B really an artifact CAL instrument?**

« Reply #13 on: September 17, 2016, 01:39:52 am »

[Say Thanks](#)

[Reply](#)

[Quote](#)

Quote from: Dr. Frank on September 16, 2016, 09:29:19 pm

Hint @ zlymex: the 5440B has no design flaw in this sense at all, because the temperature of the divider resistors is always constant, either with the 1000V burden (30sec stabilization required), or with the -13V bridge configuration. Other HV effects can be neglected, I think. Also, if that would be a design flaw, the 57xx instruments would have the very same, which is accepted to not be the case.

'Calibration at working voltage' has been a golden rule(at least here in China) for critical voltage dividers to overcome non-linearity.

It's true that wire-wound resistors show negligible voltage non-linearity especially thermally stabled, but there are other factors such as leakage on bare PCB tracks and relays. Leakage current has very severe non-linearity especially at high voltage. For sub-ppm grade 1000V voltage dividers without internal guarding, it IS a design flaw.

[Report to moderator](#)  Logged

 **e61_phil**

Frequent Contributor



Posts: 883

Country: 



 **Re: Is the Fluke 5440B really an artifact CAL instrument?**

« Reply #14 on: September 17, 2016, 08:25:34 am »

[Say Thanks](#)

[Reply](#)

[Quote](#)

Quote from: Dr. Frank on September 16, 2016, 11:23:34 pm

I think, the 34470A may only be suitable to detect that sufficiently well, if it had been adjusted (not only calibrated!) recently, to <1ppm range / ratio uncertainty, like in the initial test report.

My first intention was to measure 100V before and after this 10V decalibration only. To detect a 10ppm shift even my 3456A at home (3ppm transfer spec@100V) should be suitable.
However, your ratio measurement suggestions are much nicer to check the ability of the 5440.

Quote from: zlymex on September 17, 2016, 01:31:22 am

Quote from: e61_phil on September 16, 2016, 05:00:22 pm

10V is much easier to get than a 752A.

That's true in a way now days, but in the old days 732A was the only decent 10V available from Fluke and had similar physical size as 752A, 732A probably costed not much less than 752A.

As a hobbyist volt-nut it is even hard to get an 732A/B. Nevertheless, many people (like me) has access to calibrated instruments (for example a few 3458A with calibration data) and use these instruments immediately after calibration to transfer the 10V from the calibrated instruments to the DIY 10V standard. (Many people are not allowed to take the instruments with them and don't want to carry the 35kg monster to the workplace).

Therefore, I think the 5440B is great because of the autocal ability and the only need for 10V to calibrate the whole instrument except the DIV ranges. I had a Fluke 343A before, but such a calibrator is nearly useless without the whole calibration equipment (except as a stable and tuneable voltage source).

Quote from: zlymex on September 17, 2016, 01:39:52 am

'Calibration at working voltage' has been a golden rule(at least here in China) for critical voltage dividers to overcome non-linearity.

I read a lot of the voltage dividers for the KATRIN experiment (18kV). The PTB uses their 100kV divider to calibrate the KATRIN divider at working voltage. The design of the KATRIN divider is well described in some german PHD theses. But how can one make such measurements at working voltage without a second divider to compare?

[Report to moderator](#) [Logged](#)

Dr. Frank

Super Contributor



Posts: 1905

Country:



Re: Is the Fluke 5440B really an artifact CAL instrument?

[Say Thanks](#) [Reply](#) [Quote](#)

« **Reply #15 on:** September 17, 2016, 09:12:15 am »

Quote from: zlymex on September 17, 2016, 01:39:52 am

'Calibration at working voltage' has been a golden rule(at least here in China) for critical voltage dividers to overcome non-linearity.

It's true that wire-wound resistors show negligible voltage non-linearity especially thermally stabled, but there are other factors such as leakage on bare PCB tracks and relays. Leakage current has very severe non-linearity especially at high voltage. For sub-ppm grade 1000V voltage dividers without internal guarding, it IS a design flaw.

Hello zlymex,
do you want to tell, that you, in China, calibrate the 752A, or the 720A, or whatever < 1ppm ratio instruments at 'working voltage', i.e. at 1000V?
I really doubt that..

The 544x and the 57xx also are not specified and intended as a sub-ppm grade instrument @ 1000V, (that's the 752A only, which achieves 0.5ppm) but the HV ranges of the 544x and 57xx in relation to the basic 11V range are accurate by this internal cal routine to 1ppm, obviously.

I can't reproduce, whether or not a dedicated guarding mechanism is foreseen in these instruments, to mitigate leakage effects, but obviously the design is sufficient to meet the spec.

Strange, that you still call instruments with these very good characteristics a design flaw.

Frank

« *Last Edit:* September 17, 2016, 09:14:42 am by Dr. Frank »

[Report to moderator](#) [Logged](#)

zlymex

Frequent Contributor



Re: Is the Fluke 5440B really an artifact CAL instrument?

[Say Thanks](#) [Reply](#) [Quote](#)

« **Reply #16 on:** September 17, 2016, 10:15:29 am »

Hello Dr. Frank,

Firstly, there is no guarantee for Fluke specs. For instance, there are many 742A and 732B are out of



Posts: 556

Country:



spec.

Secondly, rule is a rule, people observe it or not, that is another matter. The head of Division of Electricity and Magnetism at NIM(Mr. Shao) had written and spoken that rule(calibrate at working voltage) many times.

Thirdly, at NIM(National Institute of Metrology, China NIST equivalent), they don't use 752A and 720A as serious dividers, they use 4902S, and better still, they build their own true guarded divider, and all calibrated at working voltage.

Fourthly, the input resistance of 720A is 100k(at 1.0 input) which is not very large and thus the leakage probably less significant. However, the divider string of 5440B is 2 Meg(for 1000V range), making it more vulnerable for leakage on the not very short bare PCB tracks and relay contacts that easily get dirty because of the circulation.

Lastly, if something is good, doesn't necessarily mean it must be flawless.

To get to my point, calibrating at non-working voltage is a small flaw, and no guarding on ppm-level divider for 1000V at mega-ohm string is another flaw.

BTW, there is a guarding circuit inside 752A, but not true guarding.

Report to moderator Logged

 zlymex

Frequent Contributor



Posts: 556

Country:



Re: Is the Fluke 5440B really an artifact CAL instrument?

Say Thanks

Reply

Quote

« **Reply #17 on:** September 17, 2016, 10:50:12 am »

Quote from: e61_phil on September 17, 2016, 08:25:34 am

Therefore, I think the 5440B is great because of the autocal ability and the only need for 10V to calibrate the whole instrument except the DIV ranges. I had a Fluke 343A before, but such a calibrator is nearly useless without the whole calibration equipment (except as a stable and tuneable voltage source).

True, I think 5440B is great too, otherwise I wouldn't brought the second one.

Quote from: e61_phil on September 17, 2016, 08:25:34 am

Quote from: zlymex on September 17, 2016, 01:39:52 am

'Calibration at working voltage' has been a golden rule(at least here in China) for critical voltage dividers to overcome non-linearity.

I read a lot of the voltage dividers for the KATRIN experiment (18kV). The PTB uses their 100kV divider to calibrate the KATRIN divider at working voltage. The design of the KATRIN divider is well described in some german PHD theses. But how can one make such measurements at working voltage without a second divider to compare?

Yes, calibration at working voltage requires a second(and better) divider. Picture below is the Chinese regulation(JJG 1007-2005) for calibration high voltage dividers where B is the high voltage generator.

JJG 1007—2005



图 2 采用补偿法检定直流高压分压器的原理图

B—直流高压电源及调压控制和保护装置；

JJG1007-2005.gif (8.4 kB, 842x628 - viewed 407 times.)

Report to moderator Logged

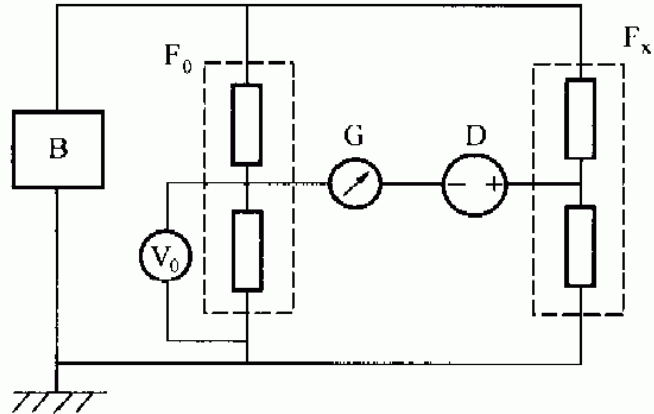
e61_phil
Frequent Contributor



Posts: 883
Country:

zlymex
Frequent Contributor



Posts: 556
Country:

Re: Is the Fluke 5440B really an artifact CAL instrument?

Say Thanks Reply Quote

« Reply #18 on: September 17, 2016, 11:20:35 am »

Quote from: zlymex on September 17, 2016, 10:50:12 am

Yes, calibration at working voltage requires a second(and better) divider. Picture below is the Chinese regulation(JJG 1007-2005) for calibration high voltage dividers where B is the high voltage generator.

But how do you get such a better divider in the first place?

Report to moderator Logged

Re: Is the Fluke 5440B really an artifact CAL instrument?

Say Thanks Reply Quote

« Reply #19 on: September 17, 2016, 11:36:55 am »

Quote from: e61_phil on September 17, 2016, 11:20:35 am

Quote from: zlymex on September 17, 2016, 10:50:12 am

Yes, calibration at working voltage requires a second(and better) divider. Picture below is the Chinese regulation(JJG 1007-2005) for calibration high voltage dividers where B is the high voltage generator.

But how do you get such a better divider in the first place?

There is this Datron 4902S available that specified as 0.2ppm for 1000V:10V divider. They use tons of hermetic foil resistors(from Vishay), matched, guarded, compensated.

More still, NIM said there are some limitations for 4902S so they built one of their own and claimed to be better than 4902S.

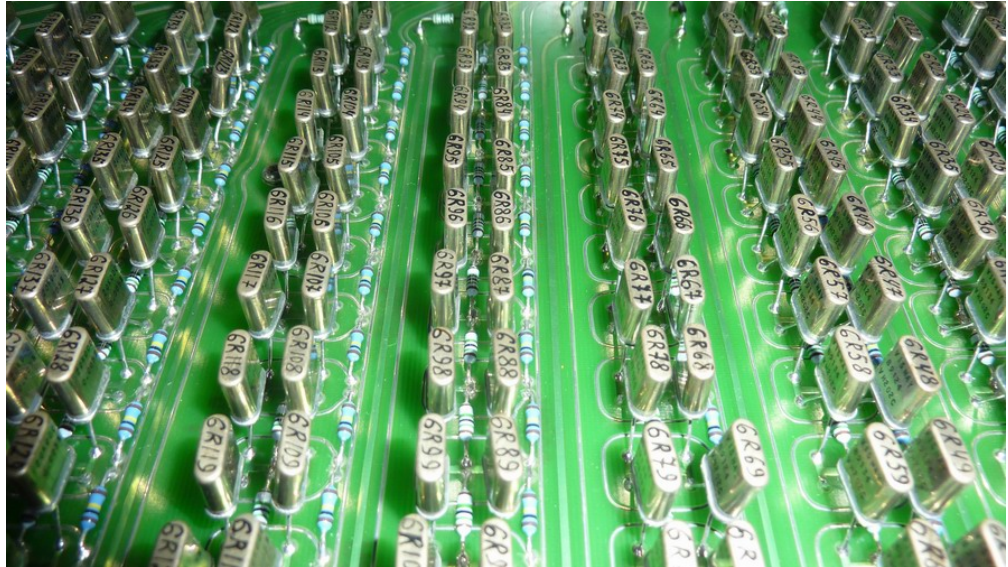

4902S-P1060511.jpg (212.83 kB, 893x506 - viewed 528 times.)

Report to moderator  Logged

The following users thanked this post: bck

 **Dr. Frank**

Super Contributor



Posts: 1905

Country: 



 **Re: Is the Fluke 5440B really an artifact CAL instrument?**

Say Thanks

Reply

Quote

« Reply #20 on: September 18, 2016, 08:39:42 am »

Quote from: zlymex on September 17, 2016, 10:15:29 am

Hello Dr. Frank,

Firstly, there is no guarantee for Fluke specs. For instance, there are many 742A and 732B are out of spec.

This is a trivia, I think.

You always have a statistical distribution of the specified parameters. At a typical confidence level of 95%, about 5% of the instruments fall out of the limits.

Fluke published a study about 732A and 732B references, showing exactly this, but this included also the drift of the SZA263 in typically positive, and the LTFU in typically negative direction.

It's also trivial, that calibration instruments may drift out of specification over time, and even earlier than the specified 1 year.

If the design and verification is done correctly, this should also cover the 95% confidence level.

Quote from: zlymex on September 17, 2016, 10:15:29 am

Secondly, rule is a rule, people observe it or not, that is another matter. The head of Division of Electricity and Magnetism at NIM(Mr. Shao) had written and spoken that rule(calibrate at working voltage) many times.

Sorry, I don't know Mr. Shao, but he for sure also cannot overrule the laws of electrical engineering, or physics.

It's not possible to calibrate a 752A or other Hamon type dividers at 'working level', for obvious reasons, e.g. that would destroy the divider resistors.

A different story would be, to use a very different technique of calibrating reference / decade dividers, so that each of the resistors also sees the same voltage burden during calibration, as during usage.

Quote from: zlymex on September 17, 2016, 10:15:29 am

Thirdly, at NIM(National Institute of Metrology, China NIST equivalent), they don't use 752A and 720A as serious dividers, they use 4902S, and better still, they build their own true guarded divider, and all calibrated at working voltage.

Well, I don't know the adjustment technique of the 4902S, as I did not yet find a manual, or a description of the circuitry.

If you have that available, please share.

If it's a Hamon type calibration technique again, it's also not possible to do the adjustment on working voltage.

If it's more a technique like in the 720A, where each of the about 100 resistors may be adjusted at 10V, by comparing it in a bridge configuration, you would only get the mediocre ratio specifications for 10:1, 100:1, like the 720A, for sure.

Please, share the NIM technique, how to achieve Hamon type uncertainty (or better) at working voltage adjustment.. I really can't figure out, how this works..

Quote from: zlymex on September 17, 2016, 10:15:29 am

Fourthly, the input resistance of 720A is 100k(at 1.0 input) which is not very large and thus the leakage probably less significant. However, the divider string of 5440B is 2 Meg(for 1000V range), making it more vulnerable for leakage on the not very short bare PCB tracks and relay contacts that easily get dirty because of the circulation. Lastly, if something is good, doesn't necessarily mean it must be flawless.

Yes, that's also already known about the 720A; but in practical terms, the 720A is anyhow not suitable for very precise 10:1 or 100:1 ratios.

Leakage currents are taken into account for the 720As specification also, like in the 752A ones.

The 5440B may suffer from leakage currents, but obviously it meets or exceeds its specifications anyhow.

Would be interesting, instead, if you had some experience or research results about older 5440B instruments, how and where to possibly clean the instrument, to mitigate such leakage effects and restore its initial performance.

In the end, the 5440B is not intended as a sub-ppm ratio instrument, like the 752A, or like any other of your superior NIM dividers, so your criterion of 'design flaws' in the 5440B is a bit academic, in this case.

Quote from: zlymex on September 17, 2016, 10:15:29 am

To get to my point, calibrating at non-working voltage is a small flaw, and no guarding on ppm-level divider for 1000V at mega-ohm string is another flaw.

BTW, there is a guarding circuit inside 752A, but not true guarding.

Do you have any reference, or documents, how such ratio dividers standards are built, so that they achieve the Hamon type uncertainty, but were really also adjusted at working level voltages?

That would be really helpful.

Btw.: In the 752A manual, they summarized and evaluated all possible sources of errors, which leads to the theoretically calculated specification, which again is good metrological practice.

I also assume, that all these institutions also make an evaluation of their self-built dividers, at first.

I also know about several ratio divider comparison papers from different National Standards Institutes, where they really do a ring-comparison of 752As vs. 4902S, vs. self-built versions under working voltage conditions, i.e. at 1000V:10V mode.

But that comparison again is a different story than the different adjustment methods, I think.

I really would appreciate your practical guidance about designing more precise ratio divider standards!

Frank

[Report to moderator](#)  [Logged](#)

The following users thanked this post: TIN

 **zlymex**

Frequent Contributor



Posts: 556

Country: 



 **Re: Is the Fluke 5440B really an artifact CAL instrument?**

[Say Thanks](#)

[Reply](#)

[Quote](#)

« **Reply #21 on:** September 18, 2016, 04:53:46 pm »

Hello Dr. Frank,

This time I won't explain correspondingly, but I'll say what ever I know about precision dividers, limited only by the verbal agreement to one of my friend who shared me with something divider related that I promised not to disclose.

1. I have 4902/S manual(of 31 pages) in electronic(scanned) form, but I cannot share it because the one who gave it to me obtained it not in a legitimate way.

I'll attach the 2nd content page anyway, this will explain a little about how 4902/S is calibrated: by using the dedicated 4901 thru 4904, allowing 4902/S to be calibrated at full working voltage(1000V max).

There is an Fluke article 'Migrating from dc voltage dividers to modern reference multimeters'

http://support.fluke.com/calibration-sales/Download/Asset/2114953_6200_ENG_A_W.pdf

Bottom-right photo of the first page is the Datron 4900 system, top is 4901, middle is 4903, bottom is 4902/S, left is 4904.



2. There are three basic principle types for precision dividers, namely KVD(as in 720A), Hamon(as in 752A) and the type that 4902/S uses, which I think is called cascade(by translation from Chinese, the manual didn't say it). There are many dividing ratios, not 2 as for 752A, not near infinite as for 720A, but all fixed voltages and marked on the panel. For instance, 600V:10V can be used, but this range cannot be used for 60V:1V. This will make sure that the divider is working on exact the same voltage as calibrated for every possible ranges.

3. There are some photos of 4902/S here: <http://bbs.38hot.net/thread-7032-1-1.html>

Yes, I once get hold of that unit for a while, teardown and tested. I could keep it if I like, but gave up in the end. The same unit is now on sale here: <https://world.taobao.com/item/42045355947.htm>

4. I don't have the schematics, it is not included in the manual, it is a separate file called Circuit Diagram 430582.

I haven't draw the diagram myself either. It actually very simple, just nine 100V 4-W strings, plus ten 10V, all fully guarded. The bottom part of the PCB photo is attached, anyone can figure it out together with the photo of the panel and the top PCB.

5. The DIY divider by NIM

There was an early article 'Calibration of High Correctness DC Resistance Voltage Divider', where they compared 4902S with their own divider called TH12 at working voltage(1000V max) and obtained a compatible results: <http://gfjl.org/thread-8073-1-1.html>

The article is in Chinese but the abstract is in English. It is this article that saying there are three types and 4902S belongs to cascade type.

Later, NIM build another divider, the photo is still on their website: <http://www.nim.ac.cn/divisions/4>

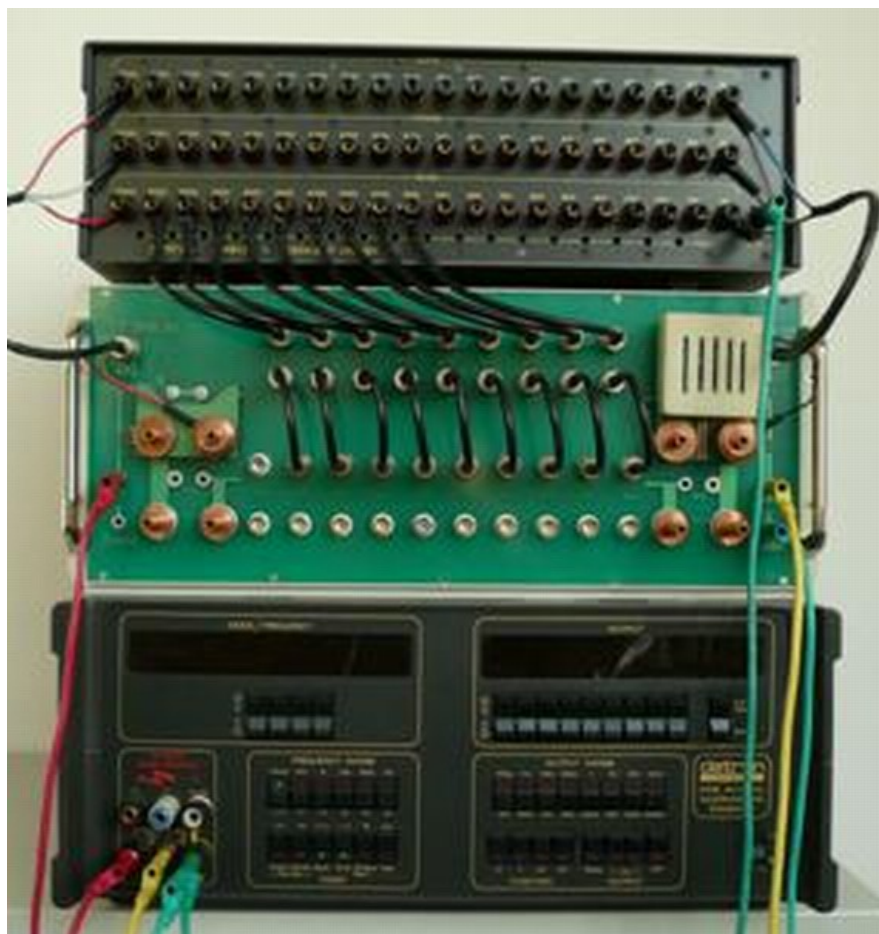

Top part is of course 4902S, bottom is 4000A, middle part is their DIY.

I have the report of the DIY at hand, again I cannot share it which in Chinese anyway. It is also a cascade type, but with an auxiliary divider and 9 high CMRR wireless-data-link null meters inside, to facilitates the calibration by 'two step shift method'. The divider string is made up of some matched 400 Vishay resistors of untold type. Looking at the scattered diagram of the tested TCR, most of the TCR fall in -1.5ppm/K to 2.0ppm/K band. Also, unlike 4902/S that use common film resistors, they use very high precision resistor for guarding network thus keep any voltage differences to within 10mV. The result, thru uncertainty analysis, they claimed to be 5 time better than the previous one, 20 to 50 ppb type A uncertainty and 80ppb combined uncertainty for 1000V:10V. In the last part of the report, they compared 752A with it and said there were two weaknesses for 752A: only two ratios and calibrate at low voltage.

Edit, there is probably a fourth type of precision divider, Binary Voltage Divider, like MI's 8000B, with an 20 Channel Scanner, Accuracy $<0.05\text{ ppm}$, Range to 1200 Volts, able to Calibration of Fluke 5700A/5720A, and Self Calibration.

<http://www.mintl.com/media/pdfs/8000B.pdf>

SECTION 5 USING THE 4902/4902S

- 5.1 Introduction
- 5.1.1 Specification Differences
- 5.2 Interconnections
- 5.2.1 Sources of Error
- 5.2.2 Avoidance Tactics
- 5.2.3 Internal Connections
- 5.2.4 Division by 10 (100V to 10V)
- 5.2.5 Division by 100 (1000V to 10V)
- 5.2.6 Other Division Ratios

SECTION 6 USING THE 4901 CALIBRATION BRIDGE

- 6.1 Introduction
- 6.2 Interconnections
- 6.2.1 'Rx' Connections
- 6.2.2 Null Detector Connections
- 6.2.3 Bridge Power Connection
- 6.3 Bridge Supply Requirements
- 6.3.1 10V Sections
- 6.3.2 100V Sections
- 6.3.3 Four-wire Connection
- 6.4 Operation
- 6.4.1 Null Detector Zeros
- 6.4.2 Settling Times
- 6.4.3 Null Detector Selection
- 6.4.4 Initial Lead Compensation
- 6.4.5 Standardizing the Bridge
- 6.4.6 Calibration by Substitution
- 6.5 Calibration of 4902/4902S
- 6.5.1 10V Sections
- 6.5.2 100V Sections
- 6.6 Using External Bridge Elements
- 6.6.1 User's Standards
- 6.6.2 'LV DIV'

4902Man-content2.gif (32.17 kB, 346x505 - viewed 241 times.)



4900system.jpg (37.69 kB, 609x492 - viewed 3806 times.)

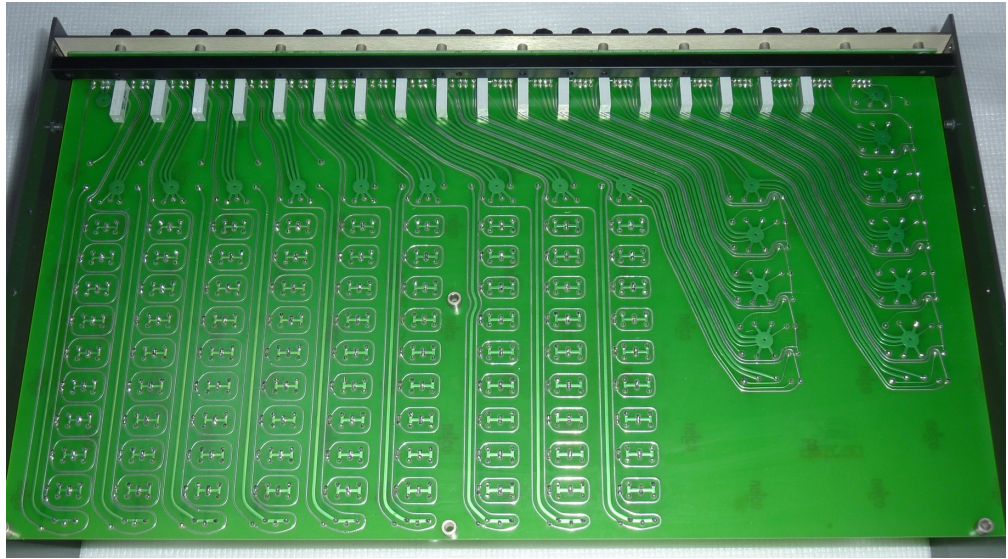

4902S-PCB-bot.jpg (551.35 kB, 1823x1013 - viewed 305 times.)

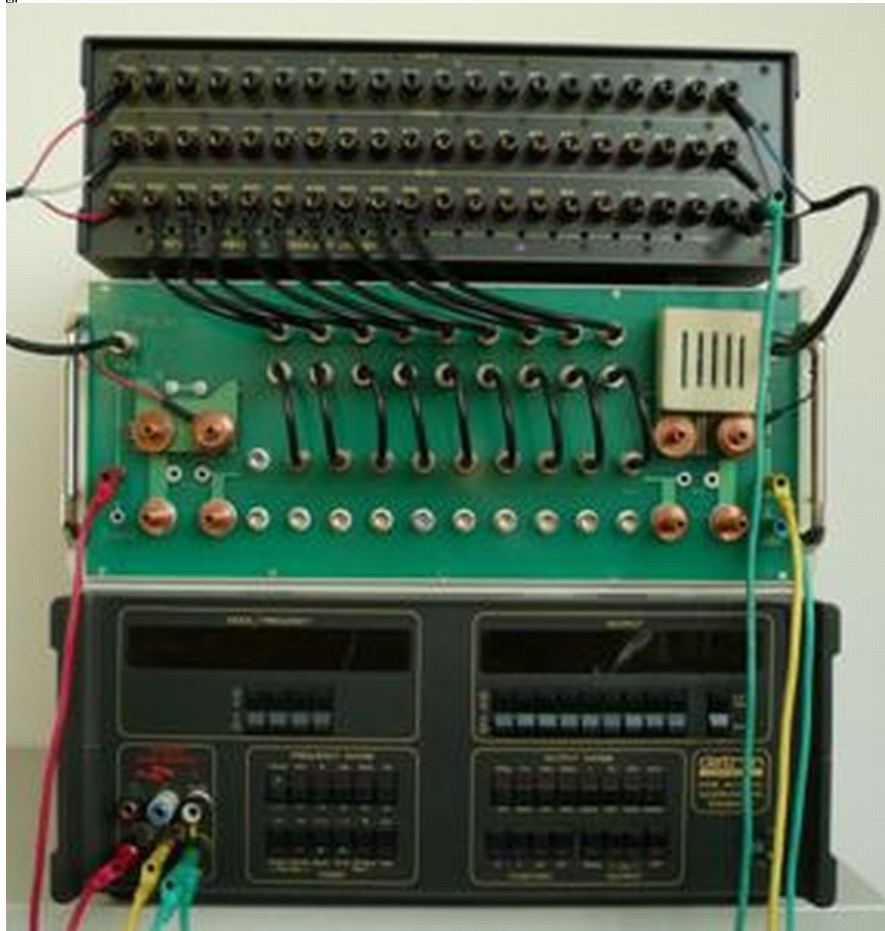

NIM-divider.jpg (77.79 kB, 574x602 - viewed 3852 times.)

« Last Edit: September 19, 2016, 05:38:06 am by zlymex »

Report to moderator Logged

The following users thanked this post: TiN

Vgkid
 Super Contributor

Re: Is the Fluke 5440B really an artifact CAL instrument?

Say Thanks Reply Quote

« Reply #22 on: September 18, 2016, 10:44:36 pm »



Posts: 2599
Country:

The method employed by the Datron4902s, and the NIM divider. Remind me of the Voot Boxes produced by L&N/ Guildline/(possibly others). Which used strings of resistors in an ovenized oil bath, to act as a voltage divider.

Report to moderator Logged



e61_phil

Frequent Contributor



Posts: 883

Country:



If you own any North Hills Electronics gear, message me. L&N Fan

Re: Is the Fluke 5440B really an artifact CAL instrument?

Say Thanks

Reply

Quote

« Reply #23 on: September 19, 2016, 02:59:01 pm »

Today I played with the 5440B and a 3458A:

EXT CAL 10V + 10ppm no other calibrations
After this calibration the 100V output was also shifted by +10ppm

-> artifact calibration possible q.e.d.

For further tests I "calibrated" the Fluke 5440B to match the 10V from the 3458A.

Ratio error in 100V Range between 10V and 100V seems to be about 1ppm

Edit:

99,999677 against 9,999979 results in 1,13ppm error

But why is the reading in the 100V range about 3,2ppm low? Is this the sum of errors? 2ppm from the Autocal of the 3458A and 1,13ppm from the 5440B = 3,2ppm?

I wouldn't expect 2ppm error from the Autocal (this is the difference between the ranges in the specs). And the last calibration certificate (last month) showed 10V about 0,2ppm to low and 100V about 0,9ppm low.

« Last Edit: September 19, 2016, 03:51:38 pm by e61_phil »

Report to moderator Logged

e61_phil

Frequent Contributor



Posts: 883

Country:



Re: Is the Fluke 5440B really an artifact CAL instrument?

Say Thanks

Reply

Quote

« Reply #24 on: September 20, 2016, 10:09:47 pm »

If anybody is interested, I've done some linearity measurements in the 10V range of the 3458A

Fluke 5440B	HP 3458A
0	-0,00000008
1	1,0000048
2	2,0000065
3	3,0000083
4	4,000009
5	5,0000096
6	6,0000098
7	7,0000105
8	8,0000102
9	9,0000106
10	10,0000106

Report to moderator Logged

VintageNut

Frequent Contributor



Posts: 523

Country:



Re: Is the Fluke 5440B really an artifact CAL instrument?

Say Thanks

Reply

Quote

« Reply #25 on: September 30, 2016, 02:00:41 am »

Quote from: Dr. Frank on September 18, 2016, 08:39:42 am

Quote from: zlymex on September 17, 2016, 10:15:29 am

Hello Dr. Frank,

Firstly, there is no guarantee for Fluke specs. For instance, there are many 742A and 732B are out of spec.

This is a trivia, I think.

You always have a statistical distribution of the specified parameters. At a typical confidence level of 95%, about 5% of the instruments fall out of the limits.

Fluke published a study about 732A and 732B references, showing exactly this, but this included also the drift of the SZA263 in typically positive, and the LTFLU in typically negative direction.

It's also trivial, that calibration instruments may drift out of specification over time, and even earlier than the specified 1

year.

If the design and verification is done correctly, this should also cover the 95% confidence level.

Quote from: zlymex on September 17, 2016, 10:15:29 am

Secondly, rule is a rule, people observe it or not, that is another matter. The head of Division of Electricity and Magnetism at NIM(Mr. Shao) had written and spoken that rule(calibrate at working voltage) many times.

Sorry, I don't know Mr. Shao, but he for sure also cannot overrule the laws of electrical engineering, or physics. It's not possible to calibrate a 752A or other Hamon type dividers at 'working level', for obvious reasons, e.g. that would destroy the divider resistors.

A different story would be, to use a very different technique of calibrating reference / decade dividers, so that each of the resistors also sees the same voltage burden during calibration, as during usage.

Quote from: zlymex on September 17, 2016, 10:15:29 am

Thirdly, at NIM(National Institute of Metrology, China NIST equivalent), they don't use 752A and 720A as serious dividers, they use 4902S, and better still, they build their own true guarded divider, and all calibrated at working voltage.

Well, I don't know the adjustment technique of the 4902S, as I did not yet find a manual, or a description of the circuitry. If you have that available, please share.

If it's a Hamon type calibration technique again, it's also not possible to do the adjustment on working voltage. If it's more a technique like in the 720A, where each of the about 100 resistors may be adjusted at 10V, by comparing it in a bridge configuration, you would only get the mediocre ratio specifications for 10:1, 100:1, like the 720A, for sure.

Please, share the NIM technique, how to achieve Hamon type uncertainty (or better) at working voltage adjustment.. I really can't figure out, how this works..

Quote from: zlymex on September 17, 2016, 10:15:29 am

Fourthly, the input resistance of 720A is 100k(at 1.0 input) which is not very large and thus the leakage probably less significant. However, the divider string of 5440B is 2 Meg(for 1000V range), making it more vulnerable for leakage on the not very short bare PCB tracks and relay contacts that easily get dirty because of the circulation. Lastly, if something is good, doesn't necessarily mean it must be flawless.

Yes, that's also already known about the 720A; but in practical terms, the 720A is anyhow not suitable for very precise 10:1 or 100:1 ratios.

Leakage currents are taken into account for the 720As specification also, like in the 752A ones.

The 5440B may suffer from leakage currents, but obviously it meets or exceeds its specifications anyhow. Would be interesting, instead, if you had some experience or research results about older 5440B instruments, how and where to possibly clean the instrument, to mitigate such leakage effects and restore its initial performance. In the end, the 5440B is not intended as a sub-ppm ratio instrument, like the 752A, or like any other of your superior NIM dividers, so your criterion of 'design flaws' in the 5440B is a bit academic, in this case.

Quote from: zlymex on September 17, 2016, 10:15:29 am

To get to my point, calibrating at non-working voltage is a small flaw, and no guarding on ppm-level divider for 1000V at mega-ohm string is another flaw.

BTW, there is a guarding circuit inside 752A, but not true guarding.

Do you have any reference, or documents, how such ratio dividers standards are built, so that they achieve the Hamon type uncertainty, but were really also adjusted at working level voltages?

That would be really helpful.

Btw.: In the 752A manual, they summarized and evaluated all possible sources of errors, which leads to the theoretically calculated specification, which again is good metrological practice. I also assume, that all these institutions also make an evaluation of their self-built dividers, at first.

I also know about several ratio divider comparison papers from different National Standards Institutes, where they really do a ring-comparison of 752As vs. 4902S, vs. self-built versions under working voltage conditions, i.e. at 1000V:10V mode.

But that comparison again is a different story than the different adjustment methods, I think.

I really would appreciate your practical guidance about designing more precise ratio divider standards!

Frank

Hello Dr. Frank

I have looked at the 4902 circuit board and read the discussion by Zlymex and looked at the front panel of the Datron 4902.

It looks to me that the divider is set up so that the bottom is calibrated to 10V and then a succession of transfers happens up the ladder using a null meter to null the higher sections to be identical to the

golden bottom 10v. When all of the 10V ladder rungs are finished, there is now a golden 100V at the top of all of the 10V sections that are all identical to the bottom golden 10v.

The 100V section adjustments are a repeat of the procedure of 10V sections to arrive at 1000V.

I think that golden 1000V, 100V and 10V would be helpful for this to work but may not be absolutely necessary.

Every section of every decade requires an adjustment potentiometer.

Your version of the 752A could be modified to do exactly this if you place an adjustment pot between every stage of every decade making exact voltages of
10,20,30,40,50,60,70,80,90,100,200,300,400,500,600,700,800,900.

It would be meticulous to adjust but might be worth the effort as an academic exercise.

[Report to moderator](#)  Logged

working instruments :Keithley 260,261,2750,7708, 2000 (calibrated), 2015, 236, 237, 238, 147, 220, Rigol DG1032 PAR Model 128 Lock-In amplifier, Fluke 332A, Gen Res 4107 KVD, 4107D KVD, Fluke 731B X2 (calibrated), Fluke 5450A (calibrated)

 **e61_phil**

Frequent Contributor



Posts: 883

Country: 



Re: Is the Fluke 5440B really an artifact CAL instrument?

[Say Thanks](#)

[Reply](#)

[Quote](#)

« **Reply #26 on:** December 22, 2017, 11:28:04 am »

I managed to bring my private Fluke 5440B to the calibrated Fluke 5440B and the two 3458As. I am very confident about the 10V of my Fluke 5440B, but I can't really verify the other voltages at home.

First measurements showed (after ACAL on every instrument):

10V -> +0,6ppm
100V -> +3,6ppm
1000V -> +8,4ppm

All the readings agree with the second 3458A and both 3458A are within 1ppm of the calibrated 5440B.

I didn't expect something like that. The service manual says: "The principal function of External Calibration is to correct for any shift in the Calibrator's internal voltage reference. A second function is to correct for long-term drift in the internal voltage divider resistors used for the 2.0V and 0.2V divided output ranges. All other time- and temperature-dependent changes in the calibrator are corrected by the Internal Calibration procedure.

An abbreviated External Calibration procedure ("10V Cal") may be used following Internal Calibration to complete the calibration of **all ranges** except the 0.2V and 2.0V ranges...."

If this is really the case, why are 100V and 1000V not within the 24h specification against the 10V output? And for what reason is it possible to calibrate 20V, 100V and 1000V?

In the next step I run the external calibration procedure through all the steps (including 100V and 1000V). That brought my 5440B exactly to the 3458A (no surprise). After that I ran the Internal Calibration. I wasn't sure what will happen then. I thought the Internal calibration will bring all ratios back to the state before the external calibration, because 10V were already spot on. But that doesn't happen. After the internal calibration everything stayed like it was after the external calibration.

I also found in the service manual, that the internal ADC of the 5440B is able to switch the input gain. If the input is out of range with a gain of 1000x the gain will switch to 100x and the section is nulled. After that it runs again with 1000x. Therefore, I think this cannot be the reason why the calibrator can't find the right ratios. And even if this will be the case I would expect an error message.

The DIV output was spot on, by the way.

[Report to moderator](#)  Logged

The following users thanked this post: Dr. Frank

 **Dr. Frank**

Super Contributor



Posts: 1905

Country: 



Re: Is the Fluke 5440B really an artifact CAL instrument?

[Say Thanks](#)

[Reply](#)

[Quote](#)

« **Reply #27 on:** December 22, 2017, 01:34:28 pm »

Hi e61_phil,
At first, well done, hope that you didn't break your back, 2 days before Christmas..

The 3458As are not reliable @ 1kV, as the divider is not compensated for self heating effects. Mine measures about -6.5ppm, verified by a Hamon type divider.

The acal feature of the 5440B works only for small deviations from a foregoing external calibration, so you should have identified that by comparing the internal ratio coefficients, which will be printed by a certain front panel menu . If I remember correctly, these factors are near zero for my instrument. Actually, these are the gain shift values, all being +0.2 ppm.

Maybe your private unit was way off initially, that would explain the different behaviour after external calibration.

I also sometimes encounter greater deviation than 1ppm at 100V, compared to my 3458A, but that's related to the ACAL uncertainty of both instruments, and also to sufficient warm up time. After another acal of both instruments, this difference might vanish.

Using the Hamon divider, there's mostly agreement within 1ppm for 100V and 1kV, referenced to 10V

Frank

« Last Edit: December 22, 2017, 01:39:07 pm by Dr. Frank »

Report to moderator  Logged

 **e61_phil**

Frequent Contributor



Posts: 883

Country: 



 **Re: Is the Fluke 5440B really an artifact CAL instrument?**

Say Thanks

Reply

Quote

« Reply #28 on: December 22, 2017, 10:05:49 pm »

Hi Frank,

you're absolutely right, the 3458A isn't that great for 1kV. One of the two 3458As drifts several ppm after applying 1kV. To calibrate my own 5440B I connected the 3458A to the calibrated 5440B with 1kV. Afterwards, I waited some minutes and let the 3458A stabilize, then I transferred the shown value to my 5440B. A proper Hamon Divider is on my list 😊

Unfortunately, I build the serial cable after the external calibration. But, I think +8ppm isn't way off. Therefore, I thought the 5440B should correct for this.

Perhaps I missed the table in the manuals, but I compared the serial output with the output of the GCAL command. And this is what I found out:

GCAL 0 -> 10V Range Gain
 GCAL 1 -> 20V Range Gain
 GCAL 2 -> 250V Range Gain
 GCAL 3 -> 1000V Range Gain
 GCAL 4 -> 2V Range Gain
 GCAL 5 -> .2V Range Gain
 GCAL 6 -> +10V Offset
 GCAL 7 -> +20V Offset
 GCAL 8 -> +250V Offset
 GCAL 9 -> +1000V Offset
 GCAL 10 -> -10V Offset
 GCAL 11 -> -20V Offset
 GCAL 12 -> -250V Offset
 GCAL 13 -> -1000V Offset
 GCAL 14 -> 10V Gain Shift (?)
 GCAL 15 -> 20V Gain Shift (?)
 GCAL 16 -> 250V Gain Shift (?)
 GCAL 17 -> 1000V Gain Shift (?)
 GCAL 18 -> Resolution Ratio
 GCAL 19 -> A/D Gain

I think this is helpful, if you don't want to make a serial connection (or write it down by hand). I'm not absolutely sure about the sequence of the Gain Shifts, because they all have the same value at the moment.

Now, I should dive deeper into the meaning of those numbers. At the moment I have no idea why a gain is measured in Volts and what is meant by "Resolution ratio". And I'm also not sure what is meant by Gain Shift? Is this the shift against the last external calibration?

Edit: I attached the calibration list. This list was read after the first internal calibration, after external calibration.

```

COM1 - PuTTY
JOHN FLUKE MFG. CO., INC.                                5440 CALIBRATION DATA
-----
CONSTANT          10V RANGE          20V RANGE          250V RANGE          1000V RANGE
Gain              +.54155970 mV        +1.0831170 mV        +13.539080 mV        +54.156163 mV
2V Gain           +.08311851 mV
.2V Gain          +1.0831256 mV
+Offset           +5.0226496 mV        +10.039317 mV        +125.30446 mV        +501.39519 mV
-Offset           +5.4179807 mV        +10.841301 mV        +135.67201 mV        +542.61198 mV
Gain Shift        -.0 ppm                -.0 ppm                -.2 ppm                -.2 ppm
-----
Resolution ratio: 7270          A/D gain: +.2635 mV

```

ICAL_nach_erneutem_ECAL_Tag2.PNG (13.17 kB, 706x311 - viewed 126 times.)

« Last Edit: December 22, 2017, 10:08:44 pm by e61_phil »

Report to moderator Logged

Pipelie
Regular Contributor

Posts: 166
Country:

Re: Is the Fluke 5440B really an artifact CAL instrument?

Say Thanks Reply Quote

« Reply #29 on: December 23, 2017, 05:17:02 am »

This is what i got from the RS-232 COM Port after I repaired and calibrated my 5440.

5440B- CALIBRATION&ANALOG DIAGNOSTICS DATA_2017_7_2_22-13-46.TXT (2.91 kB - downloaded 104 times.)

« Last Edit: January 02, 2018, 06:18:00 am by Pipelie »

Report to moderator Logged

e61_phil
Frequent Contributor



Posts: 883
Country:

Re: Is the Fluke 5440B really an artifact CAL instrument?

Say Thanks Reply Quote

« Reply #30 on: January 06, 2018, 10:05:53 pm »

After some reading in the service manual (thx to Echo88) I eventually understand the internal calibration process of the Fluke 5440B.

I know many people here also know how it works, but I wanted to give the topic here an answer. The answer is: **NO, the F5440B isn't an artifact CAL instrument!**

The 5440B internal calibration process is only able to measure a DRIFT in the resistor ratios and correct for this drift. To determine the absolute ratio an external calibration is needed. This will explain why one is able to calibrate all ranges which isn't possible on a 3458A for example (which is a real artifact CAL instrument). Therefore, it is possible to adjust some ranges off by several ppm. The 5440B internal calibration process will not notice that and keep this wrong ratio stable.

For the internal calibration, the 5440B will configure the feedback resistors of the used range in a way that the resulting value will be 20k. 20k is also the value of the "front" resistor of the voltage amplifier. The feedback loop will be opened and one of this 20k resistors is fed by the reference voltage and the other one is fed by the negative voltage reference. If both values are exactly the same the voltage of the junction between the resistors should be zero. Because this resistors aren't exactly equal one can measure a voltage. This voltage is measured with an ADC. The measured voltage is then stored on every internal calibration and will be used to calculate the ratio shift of the divider. This calculated shift will be added to the stored ratio from the external calibration. Therefore, it is necessary to run an internal calibration directly before the external calibration.

This is only the very short story. Before determining the ratios the offsets will be nulled and so on..

I played around with Excel to understand the process. I attached this Excel file. You can change the values in the yellow fields and the "internal calibration process" will calculate the correct drift.

ICAL.PNG (17.29 kB, 1071x201 - viewed 108 times.)
 F5440B_CALI.xls (30.5 kB - downloaded 40 times.)

Report to moderator Logged

The following users thanked this post: Mickle T., alm

e61_phil

Frequent Contributor



Posts: 883

Country:



Re: Is the Fluke 5440B really an artifact CAL instrument?

Say Thanks

Reply

Quote

« Reply #31 on: January 07, 2018, 08:01:06 pm »

I've attached the linearity measurement in the 11V Range against a HP3458A.

My Fluke 5440B is more linear, than my best 34401A.

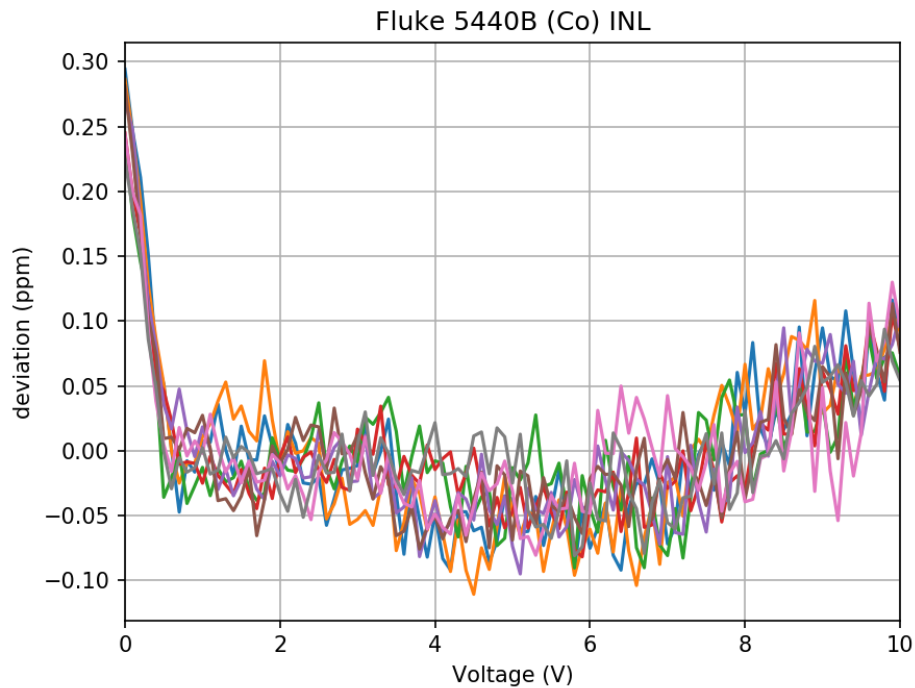

F5440B_linearity.png (164.2 kB, 960x720 - viewed 162 times.)

Report to moderator Logged

The following users thanked this post: Pipelie

Pipelie

Regular Contributor



Posts: 166

Country:



Re: Is the Fluke 5440B really an artifact CAL instrument?

Say Thanks

Reply

Quote

« Reply #32 on: January 08, 2018, 03:31:53 am »

Quote from: e61_phil on January 07, 2018, 08:01:06 pm

I've attached the linearity measurement in the 11V Range against a HP3458A.

My Fluke 5440B is more linear, than my best 34401A.

Thank you! very impressed.

are you control the 5440 via GPIB? if so, could you share the script? I would like to run some test on my 5440.

thanks in advance!

Report to moderator Logged

e61_phil

Frequent Contributor



Posts: 883

Country:

Re: Is the Fluke 5440B really an artifact CAL instrument?

Say Thanks

Reply

Quote

« Reply #33 on: January 08, 2018, 11:30:36 am »

Quote from: Pipelie on January 08, 2018, 03:31:53 am

are you control the 5440 via GPIB? if so, could you share the script? I would like to run some test on my 5440.

Yes, everything is controled via GPIB (pyvisa). It is more or less the same script as used here:

<https://www.eevblog.com/forum/metrology/dmm-linearity-comparison/msg1352735/#msg1352735>

The script simply takes 4 measurements and if all measurements are within 1µV the measurement is



accepted.

The data is stored in an ExcelSheet, but you don't need Excel for that.

It would be very interesting to compare a few 5440B in linearity.

[lin_meas.py.txt](#) (2.01 kB - downloaded 92 times.)

[Report to moderator](#) Logged

The following users thanked this post: Pipelie

Pages: 1 2 [**All**] **Go Up**

[REPLY](#) [NOTIFY](#) [MARK UNREAD](#) [SEND THIS TOPIC](#) [PRINT](#) [SEARCH](#)
« previous next »

Share me



[EEVblog Electronics Community Forum](#) » [Electronics](#) » [Metrology](#) » [Is the Fluke 5440B really an artifact CAL instrument?](#)

[LINK TO CALENDAR](#)

Jump to:

Quick Reply

RIGOL
Possibilities and More

Check Out the Latest Promotion Now

- Free Options
- Free Upgrade
- Price Discount

BUDGET MULTIMETERS !!
ANENG, UNI-T and more...

[EEVblog Main Site](#)

[EEVblog on Youtube](#)

[EEVblog on Twitter](#)

[EEVblog on Facebook](#)

[EEVblog on Library](#)