

USER'S
HANDBOOK

4708

datron
INSTRUMENTS

**autocal multifunction
standard**

USER'S HANDBOOK

for

THE DATRON 4708 AUTOCAL MULTIFUNCTION STANDARD

50245

Issue 1 (DECEMBER 1988)

Due to our policy of continuously updating our products, this handbook may contain minor differences in specification, components and circuit design to the instrument actually supplied. Amendment sheets precisely matched to your serial number are available on request.

© 1988 Datron Instruments



DANGER

HIGH VOLTAGE



**THIS INSTRUMENT IS CAPABLE
OF DELIVERING
A LETHAL ELECTRIC SHOCK !**
when connected to a high voltage source

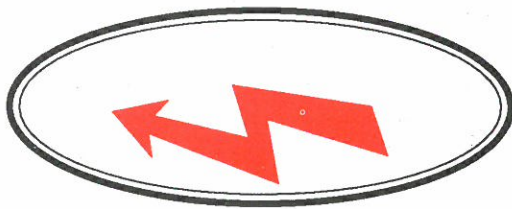

FRONT or REAR terminals
carry the Full Input Voltage

THIS CAN KILL !



Guard terminal is sensitive to
over-voltage

**It can damage your
instrument !**

Unless **you** are **sure** that it is **safe** to do so,
DO NOT TOUCH
the **I+ I- Hi** or **Lo leads** and **terminals**

DANGER

CONTENTS

	Page
SECTION 1 THE DATRON 4708 AUTOCAL MULTIFUNCTION STANDARD	1-1
Introduction	1-1
Standard and Optional Facilities	1-2
SAFETY	1-3
Optional Facilities	1-3
Accessories	1-3
Additional Documentation	1-3
Principles of Operation	1-4
SECTION 2 INSTALLATION	2-1
Unpacking and Inspection	2-1
Preparation for Operation	2-1
Bench Mounting	2-2
Rack Mounting	2-2
Connectors and Pin Designations	2-2
SECTION 3 OPERATING CONTROLS	3-1
Front Panel	3-1
Front Panel Keys	3-1
Power Switch	3-1
OUTPUT Switching	3-2
FUNCTION Keys	3-3
OUTPUT RANGE Keys	3-3
OUTPUT Display and $\uparrow \downarrow$ Keys	3-4
Frequency	3-6
MODE Selection Keys	3-9
I+, I-, Hi, Lo, Guard and Ground Terminals	3-10
Rear Panel	3-11
SECTION 4 USING THE DATRON 4708	4-1
Preliminaries	4-1
Limiting Characteristics	4-1
SAFETY	4-1
Interconnections	4-1
Typical Lead Connections	4-4
General Sequence of Operations	4-6
Display Messages	4-6
Operating Routines	4-7
DC Voltage Outputs	4-7
AC Voltage Outputs	4-7
DC Current	4-9
AC Current	4-9
Resistance	4-9
Additional Facilities	4-9
Frequency Store	4-9
Spot Frequency	4-10
'Spec' Mode	4-11
'Error' and 'Offset' Modes	4-12
Combining Offset and Error Modes	4-15
Test Key	4-16
Test Sequence	4-16
Warnings and Messages	4-19

SECTION 5 SYSTEMS APPLICATION VIA THE IEEE 488 INTERFACE	5-1
Introduction	5-1
Interface Capability	5-1
Bus Addresses	5-2
Interconnections	5-2
Typical System	5-3
Using the 4708 in a System	5-3
Programming Instructions	5-4
Programming of Operational Functions	5-8
Programming of Bus Transmissions	5-10
Activation of Commands	5-13
Multiple Commands	5-13
Operational Sequence Guidelines	5-15
SECTION 6 SPECIFICATIONS	6-1
General	6-1
DC Voltage	6-2
AC Voltage	6-4
Voltage/Frequency Constraints	6-6
Capacitive Loading Constraints	6-7
DC Current	6-8
AC Current	6-10
Resistance (Option 30)	6-12
SECTION 7 SPECIFICATION VERIFICATION	7-1
Introduction	7-1
DC Voltage	7-2
DC Current	7-8
AC Voltage	7-12
AC Current	7-24
Resistance	7-26
Report Sheet RS1	7-30
APPENDICES TO SECTION 7:	
1. Validity Tolerance Calculation	7-A1-1
2. Uncertainty and Traceability	7-A2-1
3. General Procedural Information	7-A3-1
4. Alternative Procedure for AC Millivolt Ranges	7-A4-1
5. Alternative Procedure for AC Current Verification	7-A5-1
SECTION 8 ROUTINE AUTOCALIBRATION	8-1
The 4708 Autocal Feature	8-1
DC Calibration	8-2
Autocal Availability	8-2
Zero Calibration	8-3
Equipment Required for DC Calibration	8-3
Interconnections	8-3
DC Calibration Sequence	8-3
4708 DC Voltage Calibration	8-4
4708 DC Current Calibration	8-7
4708 Resistance Calibration	8-8

AC Calibration	8-10
AC Calibration Sequence	8-11
4708 AC Voltage Calibration (1V - 1000V)	8-13
4708 AC Millivolts (LF) Calibration (1mV - 100mV)	8-14
4708 AC Millivolts (HF) Calibration (1mV - 100mV)	8-15
4708 AC Current Calibration (1mA - 1A)	8-18

APPENDIX TO SECTION 8:	
4708 AC Current Calibration (100 μ A - 1A)	8-A1-1

DATRON SALES REPRESENTATIVES WORLDWIDE

Inside Rear
Cover

Note to Readers

This handbook has been designed for you to get the best use from your 4708. The sections are put together in a sequence flowing logically from one subject to another, so that understanding increases as the text is read naturally from front to rear. Here is an alternative (explanatory !) version of the Section Titles:

- Section 1: Introduction and a brief account of the internal design.**
- Section 2: Physical connections and mounting — getting it installed.**
- Section 3: A brief scan of the available controls — where they are and what they do.**
- Section 4: The correct procedures for making the 4708 perform for you.**
- Section 5: How your 4708 can operate within an IEEE 488 system — the device dependent codes you will need to use.**
- Section 6: Specifications — what accuracy you can expect to get from your instrument.**
- Section 7: Verification that your 4708 matches the high specification it had when it left the factory.**
- Section 8: How to restore your 4708 to its original specification after it has suffered the ravages of time and temperature.**

We are confident that your 4708 will give you many years of accurate and reliable service, and hope that you will use this handbook to obtain maximum benefit from its many facilities.

SECTION 1

THE DATRON 4708

AUTOCAL MULTIFUNCTION STANDARD



General View of Datron 4708 Autocal Multifunction Standard

Introduction

The Datron 4708 Autocal Multifunction Standard is a high-precision calibrator which features exceptionally high stability and full systems capability. It is characterized by a wide-range coverage of DC Voltage, AC Voltage, DC Current, AC Current and Resistance functions in a single unit.

The basic instrument consists of a mainframe to which the various output options may be added.

Option 10 (factory-fitted) provides a DC Voltage function.

Option 20 (factory-fitted) provides an AC Voltage function.

Option 30 (factory-fitted) adds calibration sources of DC Current, AC Current and Resistance.

The 4708 incorporates a reference module which maintains a high accuracy specification over the ambient temperature range of $23^{\circ}\text{C} \pm 10^{\circ}\text{C}$. A high level of stability is achieved by use of super-selected reference components and ultra-stable gain-defining resistors. The 'Autocal' feature ensures that its 24-hour specifications are usable; not merely figures of merit.

The 4708 uses a microprocessor for control management, simplifying its use in complex manual operations, such as calibration of high-quality digital multimeters. The IEEE 488 interface provides a comprehensive remote programming capability, allowing programmed calibration of the 4708 itself.

Standard and Optional Facilities

DC Voltage Ranges

By fitting Option 10, the instrument provides DC Voltage calibration facilities in eight decade ranges from $\pm 100\mu\text{V}$ to $\pm 1000\text{V}$. 100% overrange is incorporated, except on the $\pm 1000\text{V}$ range (see page 3-3), when the output is limited to 1100V.

AC Voltage Ranges

By fitting Option 20, the instrument provides AC Voltage calibration facilities in seven decade ranges from 1mV to 1000V. 100% overrange is incorporated, except on the 1000V range (see page 3-3), when the output is limited to 1100V.

DC Current Ranges

By fitting Option 30, in conjunction with Option 10, the instrument can be used to calibrate DC Current in five decade ranges from $100\mu\text{A}$ to 1A. The Datron Model 4600 may be used to extend DC Currents to 11A.

AC Current Ranges

By fitting Option 30, in conjunction with Option 20, the instrument can be used to calibrate AC Current in five decade ranges from $100\mu\text{A}$ to 1A. The Datron Model 4600 may be used to extend AC Currents to 11A.

Resistance

By fitting Option 30, in conjunction with Option 10, the instrument can be used to calibrate resistance in eight decade ranges from 10 ohm to 100M ohm.

Frequency

The output frequency of the 4708 extends from 10Hz to 1MHz in five overlapping decade ranges, at a resolution of 1% of nominal Frequency Range. Any five frequency values within the range of the instrument can be stored in volatile memory. For higher accuracy, five 'Spot Calibrated' frequency values per Output Range can be recalled from non-volatile memory storage.

Autocal

All Datron AUTOCAL instruments are designed to make the removal of the covers for calibration unnecessary, as full routine calibration of all ranges and functions can be carried out from the front panel or over the IEEE 488 bus. Accidental or unauthorized use of the calibration routine is prevented by a key operated switch on the instrument rear panel. The procedure for calibrating this instrument is contained in Section 8.

Resolution and Accuracy

The maximum resolution is 7.5 digits with a facility for displaying the specified accuracy of any output voltage. The 4708 specifications are shown in Section 6.

Resolution and Accuracy

The maximum resolution is 6.5 digits with a facility for displaying the specified accuracy of any output voltage. The 4708 specifications are shown in Section 6.

Resolution and Accuracy

The maximum resolution is 6.5 digits with a facility for displaying the specified accuracy of output current. The 4708 specifications are shown in Section 6.

Resolution and Accuracy

The maximum resolution is 6.5 digits with a facility for displaying the specified accuracy of output current. The 4708 specifications are shown in Section 6.

Resolution and Accuracy

The maximum resolution is 7.5 digits with a facility for displaying the specified accuracy of any output resistance. The 4708 specifications are shown in Section 6.

Output Deviation

A user may deviate the output voltage from the output display value by introducing a gain 'Error' within the general range $\pm 10\%$. Additionally, for DC functions, the output may be 'offset' by up to $\pm 2\%$ of the range in use, or $200\mu\text{V}$, whichever is greater.

Remote Sense

The specified output voltage may be sensed at the load, using 4-wire connections. Remote or Local Sense is selectable from the front panel.

Remote Guard

This facility allows the instrument's internal guard shields to be externally connected.

Self-test

On power-up, the internal calibration memory is automatically checked. At any time when the output is off and not under remote control, a user may conduct a sequenced test of the displays, keyboard, safety circuitry and Reset function.

Message Readout

Messages to the user are presented on the MODE display:
The two main groups are:

Fail

An internal fault condition has been detected.

Error

A user has selected a task which is outside the instrument's capability.

Systems Use

The instrument can form part of a system by means of the IEEE 488 standard digital interface. The method of connecting to the system controller and the command codes are described in Section 5.

Safety

For protection of the user, safety trip circuits are incorporated to switch the OUTPUT OFF, in the event of instrument failures which might generate dangerous output voltages.

**UNDER NO CIRCUMSTANCES SHOULD
USERS TOUCH ANY OF THE OUTPUT, SENSE OR
GUARD TERMINALS UNLESS THEY ARE FIRST SATIS-
FIED THAT NO DANGEROUS VOLTAGE IS PRESENT.**

Optional Facilities

The available options for the 4708 are as follows:

- Option 10: DCV function
- Option 20: ACV function
- Option 30: DC Current, AC Current and Resistance functions
- Option 42: Rear output terminals
(as a factory-fitted alternative to front panel terminals).
- NB:** The rear output option is not recommended for best performance in calibrating high bandwidth, low level instruments.
- Option 90: Rack mounting kit.

Accessories:

The instrument is supplied with the following accessories:

Description	Part Number
Power Cable	920012
Set of Calibration keys	700068
User's Handbook	850245
Calibration and Servicing Handbook (2 volumes)	(Volume 1) 850246 (Volume 2) 850247

In addition the following accessories are available for use with the 4708 instrument:

Description	Part Number
RMK Rack Mounting kit (Option 90)	440094
Special Lead Kit	440070
Model 4600 Transconductance Amplifier	
Slave Mode Lead Kit (4600)	440151
Analog Lead Kit (4600)	440154

Additional Documentation

The Calibration and Servicing Handbook contains information required to adjust and service the 4708 instrument. It contains detailed descriptions of the circuits, trouble shooting and calibration procedures, parts lists, layout drawings and circuit diagrams.

Principles of Operation

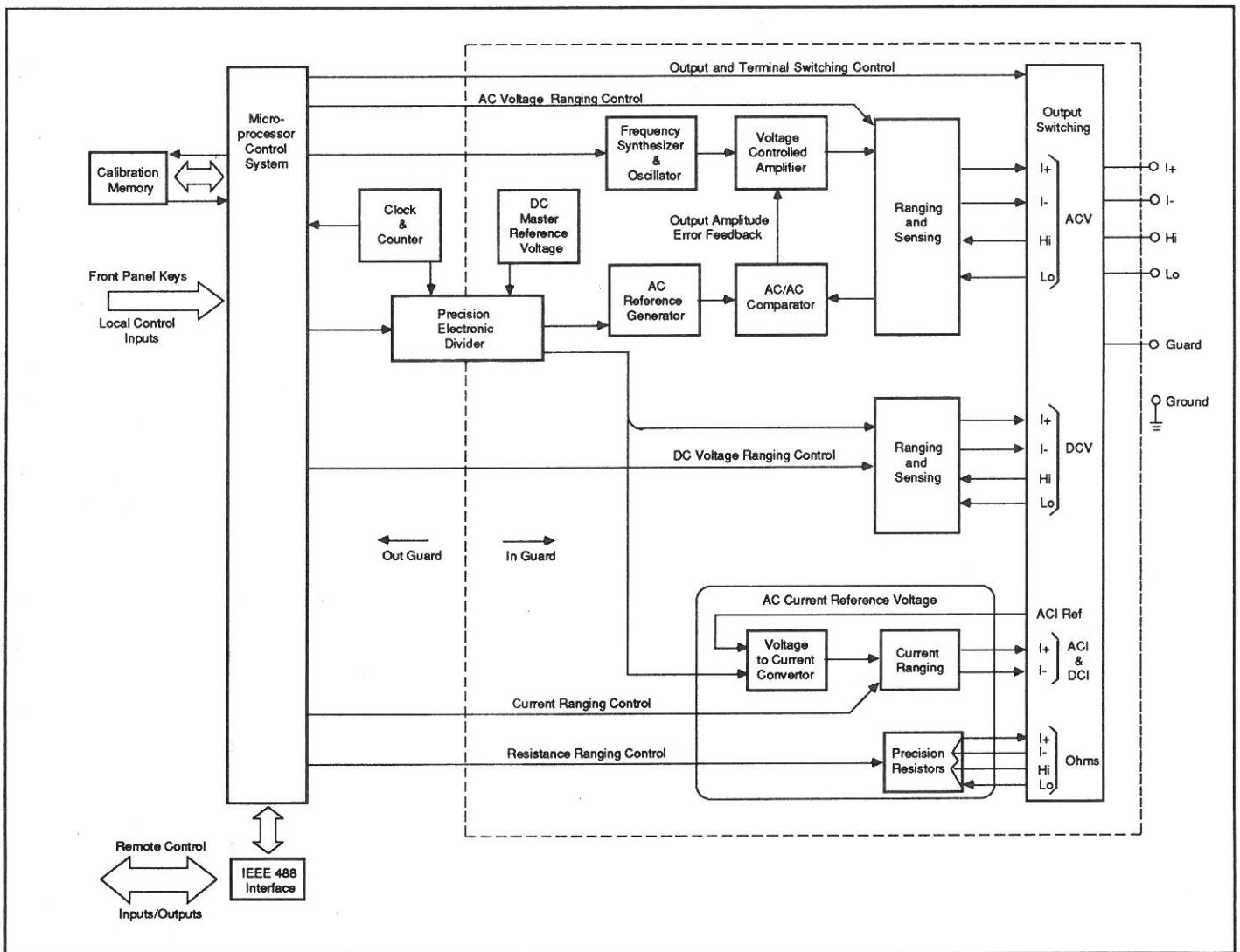

Simplified Functional Diagram. This shows the division and flow of functions within the 4708

Inputs

The 6802 microprocessor controls the output in response to three main inputs:

- i) Front panel keys
- ii) IEEE 488 bus messages in 'Remote' operation
- iii) Corrections placed in non-volatile memory during 'Autocalibration'. These modify the values which control the output.

After processing, the computing system changes the output of the instrument to respond to the input instructions.

Reference Voltages

A 20V DC 'Master' Voltage Reference establishes the fundamental accuracy of the instrument. From this 20V, a precision electronic divider derives an adjustable 'Working' reference voltage between 0V and 20V, whose value depends on digital inputs from front panel keys and calibration memory.

Precision Electronic Divider

In the out-guard section the selected output value, including calibration corrections, is set into a digital comparator as a 25-bit number. This is counted out by a crystal controlled binary counter, resulting in a 125Hz square wave whose mark : period ratio accurately represents the output value selection. When transferred into guard, it chops the Master Reference voltage. A 7-pole active low-pass filter integrates the chopped reference, to generate the ripple-free DC Working Reference voltage.

DC Voltage Output

The working reference for DC Voltage Output is a stable DC voltage, accurately variable at high resolution between 0 and +20V.

DC Voltage Ranging

Low Voltage Ranges (100 μ V - 10V FR). The basic range of the 4708 is ± 10 V Full Range (± 19.999999 V Full Scale), derived directly from the working reference. The 1V and 100mV ranges are achieved by attenuation:

The 100mV range attenuator is also used for 10mV, 1mV and 100 μ V ranges, and the digital input to the precision divider is scaled to provide the correct working reference values.

Range	Working reference values
10mV	-2V \rightarrow +2V
1mV	-200mV \rightarrow +200mV
100 μ V	-20mV \rightarrow +20mV

High Voltage Ranges (100V and 1000V)

The 100V range is a direct amplification of the working reference. The 1000V range employs step-up AC transformation.

Output Switching.

In addition to switching between functions, the output switching circuits isolate terminals on OUTPUT OFF. Remote/Local Sense and Guard switching is incorporated.

AC Voltage Output

The working reference for AC Voltage Output is a stable DC voltage, accurately variable at high resolution between +0.1V and +2V DC.

AC Reference Generator

The higher accuracy of AC/AC comparison (over AC/DC) is exploited by converting the DC Working Reference into a stepped waveform whose characteristics match those of a sine-wave. The amplitude of this 'Quasi-sine-wave' is precisely controlled by the DC Working Reference value.

Sine-wave Source

Frequency Synthesizer

From the frequency value set into the MODE/FREQUENCY display, the processor controls the synthesizer using an encoded 9-bit command. The synthesizer translates the command into a pulse train at a crystal-derived frequency between 240kHz and 4MHz, to be divided down for use as phase-reference for the Quadrature Oscillator.

N.B. If required, the Frequency Synthesizer, can be locked to an externally supplied 1MHz or 10MHz frequency, input via J53 on the rear panel.

Quadrature Oscillator

The oscillator's output frequency is set close to any demand, between 10Hz and 1MHz, by selecting the RC time constants of its dual integrators; and then by correcting to the actual demand by phase-comparison with the output from the synthesizer. The

output sine-wave purity and constant amplitude are precisely defined by a sophisticated control loop, and the RMS value of the sine-wave is adjusted to be roughly proportional to the demanded output voltage or current. Timing data is output from the source to synchronize the actions of the AC Reference Generator and AC/AC Comparator.

Voltage-Controlled Amplifier (VCA)

This has variable gain, amplifying the output from the Sine-wave Source and providing a buffered drive to the output circuits. Its gain is determined by the measured difference between the RMS values of the sensed calibrator output and the AC Reference; so the VCA provides the correcting fine adjustment for the output amplitude loop.

AC Voltage Ranging

1V Range

This is the basic AC voltage range of the 4708. As the AC working reference is variable between 0.1V and 2V RMS, it is compared in 1:1 ratio with the sensed output. The 1V Buffer output is thus passed directly to the output I+ and I- terminals.

100mV, 10mV and 1mV Ranges

The 1V Buffer output is reduced by precision attenuators before being connected to the terminals, the level being sensed before attenuation.

10V, 100V and 1000V Ranges

The 1V Buffer output is amplified on each of these ranges. A separate amplifier is provided for the 10V range, the output sense signal being obtained at the terminals and attenuated before comparison with the reference. A common power amplifier is used for both 100V and 1000V ranges. On the 100V Range the output is fed directly to the terminals, on the 1000V Range the output is stepped up by a transformer. On both ranges, the sensed terminal voltage is reduced to the reference level by precision attenuators.

Output Sensing

On the 1V range and above, the output is sensed at the front panel Hi and Lo terminals. With Remote Sense selected, these are isolated from I+ and I-, but in Local Sense Hi is internally connected to I+, and Lo to I-. As described above, the 10V, 100V and 1000V ranges' sense signal is attenuated before comparison with the reference.

AC/AC Comparator

The comparator generates an error voltage proportional to the difference between the RMS values of the AC reference and the sensed output. It alternately samples a number of cycles from its 'Ref' and 'Sense' inputs, computes and integrates the squares of their instantaneous values, and uses a 'Sample and Hold' technique to subtract one from the other, this being the 'error' voltage to control the VCA. The loop thus controls the 4708 output so that the RMS value of the comparator's sense input equates to that of its reference input.

DC Current

On changing functions to DC Current, the Working Reference voltage is switched to drive a voltage-to-current converter, and the **OUTPUT** display legend is changed to μA , **mA** or **A**. Over-voltage protection is provided, and the Output lines are fused.

AC Current

An AC Current output is produced by the voltage-to-current converter. The $100\mu\text{A}$ and **1A** ranges are driven directly from the basic **1V** range, and the others from the **10V** range. Range selection is achieved by switching internal shunts. Output protection against over-voltage is provided, and the output lines are fused. The **OUTPUT** display legend is altered to μA , **mA** or **A**.

Resistance

Remote Sense.

One of a set of eight precision resistors is internally 4-wire connected to the **I+**, **I-**, **Hi** and **Lo** terminals by operation of each **RANGE** key. Simultaneously the 4-wire calibrated value of the resistor is displayed (**OUTPUT** display). Pressing the **OUTPUT Zero** key connects a true 4-wire short to the terminals, and the **OUTPUT** display indicates zero. This zero display value cannot be recalibrated.

Local Sense (Remote Sense LED Unlit).

The connections to the resistor remain the same, but the display value includes the resistance of the connections from the **Hi** and **Lo** terminals to the resistor. The arrangement provides a calibrated 2-wire facility with external connection to the **Hi** and **Lo** terminals. The **Zero** key shorts the **Hi** and **Lo** terminals, in this case the resistance between the terminals is displayed and may be recalibrated. When Ω is selected from any other function, the 4708 is forced into **Remote Sense**, but this may be deselected for 2-wire operation.

Autocalibration

By setting the **CAL ENABLE** security keyswitch on the rear panel to **ENABLE**, the 4708 can be calibrated. (Refer to Section 8). The output value is measured and the microprocessor is activated, to add any new corrections to factors already retained in non-volatile memory. The updated correction factors are applied in the normal **RUN** mode.

Processor

A 6802-series microprocessor controls the internal performance of the instrument, employing 26k bytes of program memory.

2k bytes of memory are used for stack and work space, and 2k bytes are made non-volatile by a battery-powered back-up supply, storing calibration correction factors.

With the exception of the Power **ON/OFF** switch, each front and rear panel control provides an input to the microprocessor

system, which translates the information to command the 4708 analog and calibration functions.

The processor also controls the display, the IEEE 488 Interface Bus and the operation of the restart and error circuitry.

SECTION 2 INSTALLATION

This section contains information and instructions for unpacking and installing the Datron 4708.

Unpacking and Inspection

Every care is taken in the choice of packing materials to ensure that your equipment will reach you in perfect condition.

If the equipment has been subject to excessive mishandling in transit, the fact will probably be visible as external damage to the shipping carton. In the event of damage, the shipping container and cushioning material should be kept for the carrier's inspection.

Unpack the equipment and check for external damage to the case, sockets, keys, etc. If damage is found, notify the carrier and your sales representative immediately.

Standard accessories supplied with the instrument are as described in Section 1.

Preparation for Operation

DANGER

THIS INSTRUMENT IS CAPABLE OF DELIVERING A LETHAL ELECTRIC SHOCK. THE I+, I-, Hi AND Lo TERMINALS ARE MARKED WITH ⚡ SYMBOL TO WARN USERS OF THIS DANGER.

UNDER NO CIRCUMSTANCES SHOULD USERS TOUCH ANY OF THE FRONT TERMINALS UNLESS THEY ARE FIRST SATISFIED THAT NO DANGEROUS VOLTAGE IS PRESENT.

Power Input

The recess **POWER INPUT** plug, **POWER FUSE** and **LINE VOLTAGE SELECTOR** are contained in an integral filtered module at the center of the rear panel.

The protective window allows the fuse rating and line voltage selection to be inspected with the power socket connected. This window slides to the left once the socket has been disconnected, for access to the fuse and voltage selector printed circuit board.

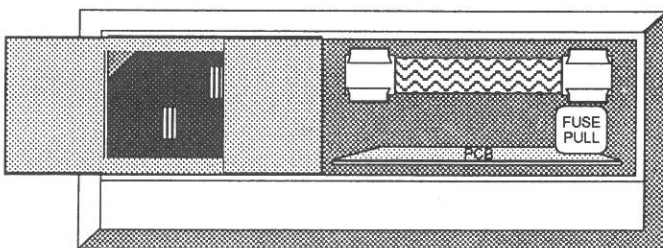

Power Cable

The detachable supply cable, comprising two meters of 3-core PVC sheath cable permanently moulded to a fully-shrouded 3-pin socket, fits in the **POWER INPUT** plug recess, and should be pushed firmly home.

The supply lead should be connected to a grounded outlet ensuring that the ground lead is connected. Connect Black lead to Line, White lead to Neutral and Green lead to Ground. (European: Brown lead to Line, Blue lead to Neutral, and Green/Yellow lead to Ground).

Line Voltage

The 4708 is operative within the line voltage ranges 100/115/120/220/230/240V $\pm 10\%$, 50 or 60Hz. To accommodate the ranges, a small PC selector board is housed beneath the **POWER FUSE**.

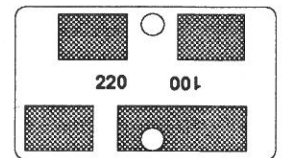
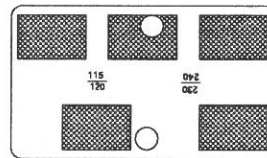

Operating Voltage Selection

FIRST ensure the **POWER CABLE** is removed. Slide the window to the left to reveal the fuse and PC selector board. Draw the fuse-extractor to the left and remove the fuse. Remove the PC selector board and rotate until the desired voltage is on the left of the upper surface. Reinsert the selector board firmly into the module slot. The desired voltage is visible in the cutout below the fuse. Return the fuse extractor to the normal position. Insert the appropriate **POWER FUSE** (see below). Slide the window to the right and insert the **POWER CABLE**.

Power Fuse

The fuse rating is:

3.15A for 220/240V line supply

6.25A for 100/120V line supply

It is located behind the window in the **POWER INPUT** module on the rear panel, and should be of the anti-surge or **SLO BLO** type.

WARNING

MAKE SURE THAT ONLY FUSES WITH THE REQUIRED RATED CURRENT AND OF THE SPECIFIED TYPE ARE USED FOR REPLACEMENT. THE USE OF MENDED FUSES AND

THE SHORT CIRCUITING OF FUSE-HOLDERS SHALL BE AVOIDED, AND RENDERS THE WARRANTY VOID.

Bench Mounting

The instrument is fitted with six plastic feet. It is intended to stand flat on a bench, positioned so that the cooling-air inlet and exhaust apertures are not obstructed. It is recommended that at least 30cm (12 inches) of free space is at the rear.

Rack Mounting

Option 90 permits the instrument to be mounted in a standard 19 inch cabinet.

To fit Option 90

CAUTION

Note that the 4708 is designed to be supported at front and rear. **AT NO TIME** should the 4708 be supported only by the front brackets. On no account should the upper and lower covers be removed.

Remove the two rear spacers from the case sides by releasing six screws. Fit the two rack-mounting slides to the rear of the case sides and secure using six of the shorter screws in the option kit. N.B. The slides may be reversed to give rearward extension.

Fit the two rear rack-mounting ears to the rear of the cabinet, with tongues facing forward. In shallow cabinets it may be necessary to trim the tongue.

CAUTION

Assistance is required to fit the 4708 into the cabinet.

Lift the 4708 into position in the cabinet, locate the tongues in the slides, and carefully slide backwards until the front ears butt up against the cabinet front. Secure the front ears to the cabinet. Also clear ventilation for fan cooling to operate properly.

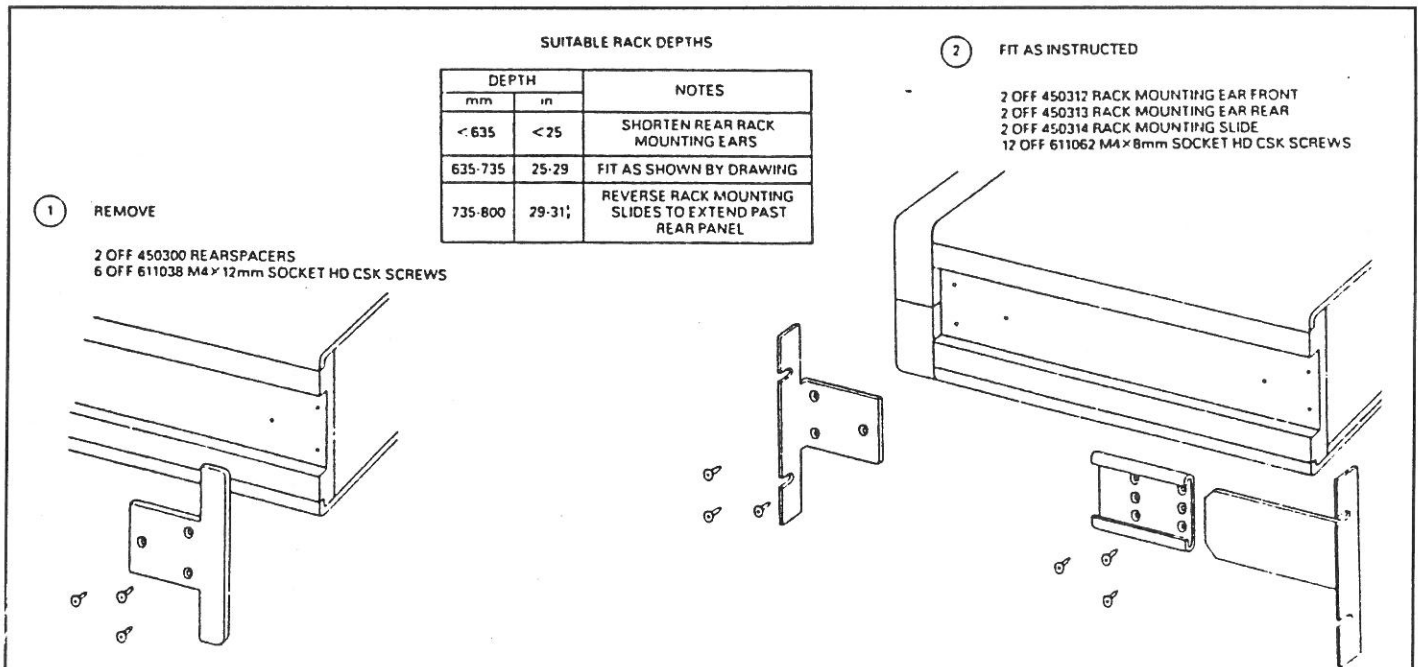

Connectors and Pin Designations

IEEE 488 Input/Output Socket J27

The IEEE input/output is a 24-way connector that is directly compatible with the IEEE 488 interface and the IEC 625 Bus.

Pin Layout

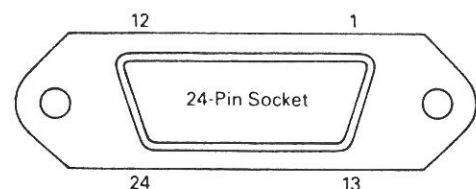

Pin Designations

J27 Pin No	Name	Description
1	DIO 1	Data Input Output Line 1
2	DIO 2	Data Input Output Line 2
3	DIO 3	Data Input Output Line 3
4	DIO 4	Data Input Output Line 4
5	EOI	End or Identify
6	DAV	Data Valid
7	NRFD	Not ready for Data
8	NDAC	Not Data Accepted
9	IFC	Interface Clear
10	SRQ	Service Request
11	ATN	Attention
12	SHIELD	Screening on cable (connected to 4708 Safety Ground)
13	DIO 5	Data Input Output Line 5
14	DIO 6	Data Input Output Line 6
15	DIO 7	Data Input Output Line 7
16	DIO 8	Data Input Output Line 8
17	REN	Remote Enable
18	GND 6	Gnd wire of twisted pair with DAV
19	GND 7	Gnd wire of twisted pair with NRFD
20	GND 8	Gnd wire of twisted pair with NDAC
21	GND 9	Gnd wire of twisted pair with IFC
22	GND 10	Gnd wire of twisted pair with SRQ
23	GND 11	Gnd wire of twisted pair with ATN
24	GND	4708 Logic Ground (Internally connected to 4708 Safety Ground)

External Reset Socket & 4600 Digital Connector J54

Pin Layout

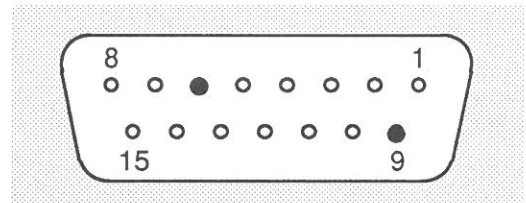

Pin Designation

Pin	Name	Function
1	SHIELD	Case Ground
2	0V_6	Digital Common
3	IWR_R	Write Strobe (Rising Edge)
4	0V_6	Digital Common
5	0V_6	Digital Common
6	ICAL_RST_L	Not used on 4600
7	IA_H_D_L	Address/Data on AD0-AD4
8	IRD_L	Read Strobe (Active Low)
9	IDIGBUSON_H	+5V (5k) when 4708 is on.
10	0V_6	Digital Common
11	IAD0	Bi-directional Address/Data Lines, controlled by Strokes and IA_H_D_L
12	IAD1	
13	IAD2	
14	IAD3	
15	IAD4	

Rear Output Terminals (Option 42)

The 4708 is fitted with either six front panel output terminals or six rear output terminals. The Rear Output alternative is fitted at the customer's request only at manufacture.

The 4708 cannot be fitted with both front and rear output terminals.

The functions of the six terminals are identical to those normally fitted on the front panel, and the external leads are connected in the same way. (See Section 4 for details).

External Reference Frequency Input Socket J53.

This BNC socket is located next to the cooling air intake filter. It enables the frequency synthesizer to be locked to a customer's own frequency standard provided that it meets the following criteria:

Voltage: 500mV to 15V peak-to-peak
 Frequency: 1MHz \pm 1% or 10MHz \pm 1%

N.B. The socket has an input resistance of approximately 50 Ω

External Reset Switch Wiring

This D-type socket located next to the optional rear output connectors may be used to input an external reset to restore the 4708 to its power-up state (DCV, 1V Range).

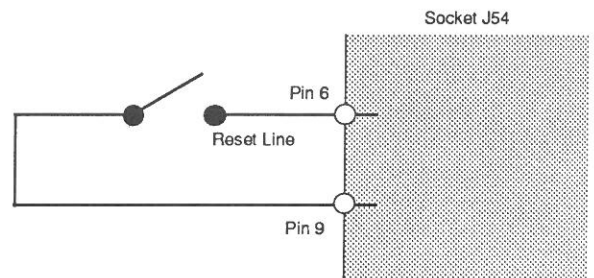

4600 Analog Connect or J56 Pin Layout and Designations

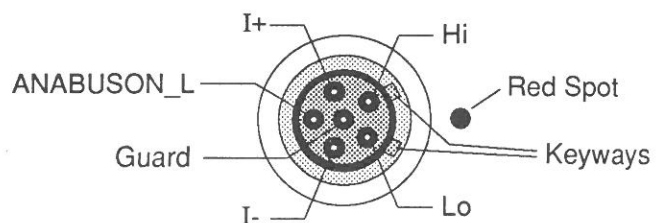



DANGER

HIGH VOLTAGE



**THIS INSTRUMENT IS CAPABLE
OF DELIVERING
A LETHAL ELECTRIC SHOCK !**
when connected to a high voltage source

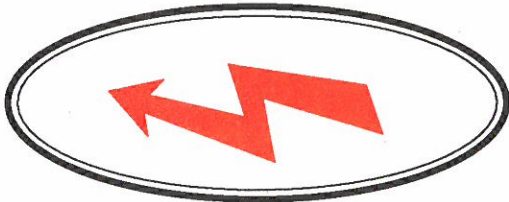

FRONT or REAR terminals
carry the Full Input Voltage

THIS CAN KILL !



Guard terminal is sensitive to
over-voltage

**It can damage your
instrument !**

Unless **you** are **sure** that it is **safe** to do so,
DO NOT TOUCH
the **I+ I- Hi** or **Lo leads** and **terminals**

DANGER

SECTION 3 OPERATING CONTROLS

This section summarizes the main operating features of the 4708. For detailed operating procedures refer to Section 4.

Front Panel

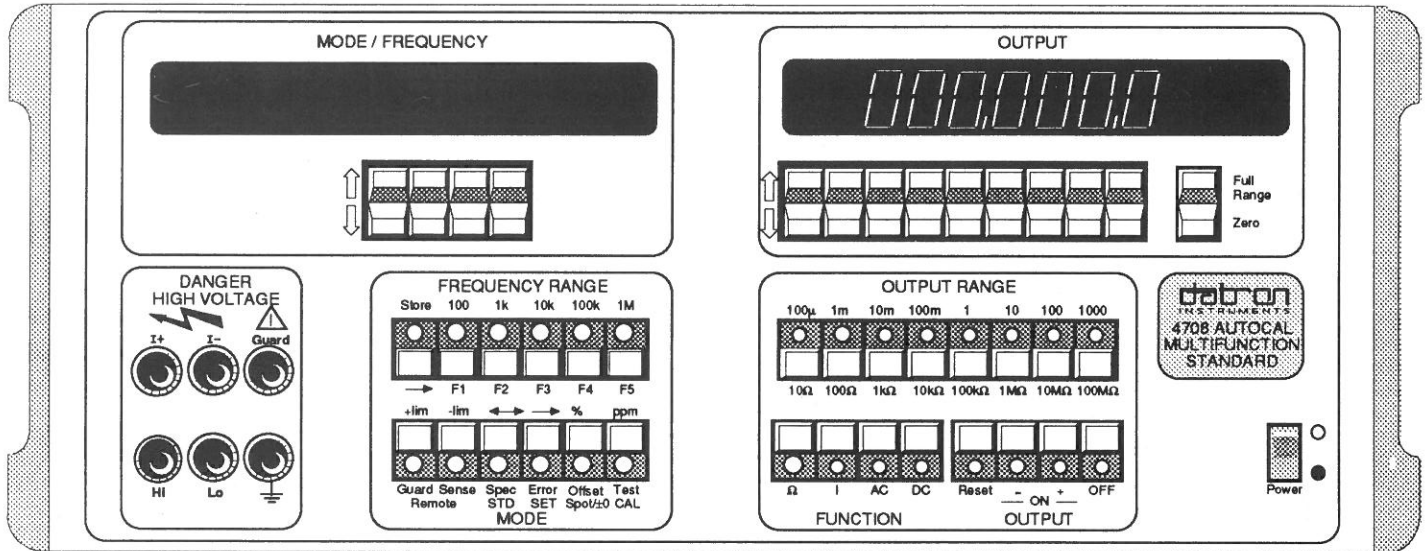

Power-up State

The controls are outlined in blocks, left and right, associated with the appropriate display. The right-hand blocks generally deal with function and output definition, whereas the left-hand blocks are concerned with frequency, mode and terminal configurations.

Front Panel Keys

All user commands from front panel keys are executed through main program firmware. A Key LED lit signifies that conditions are valid for the selected operation, and not merely that the key has made contact.

At any time, the instrument status is described by the combination of LED states, display values and display messages.

Generally, if an invalid condition is selected, an error message will be displayed and a buzzer will sound, the command is ignored and the 4708 remains in its previous state.

Power Switch

WARNING

THE POWER SWITCH SHOULD NOT BE SET TO ON UNTIL THE LINE VOLTAGE AND POWER FUSE RATING HAVE BEEN SELECTED AS DETAILED IN SECTION 2 (INSTALLATION)

When set to the OFF position, the 2-pole Power switch isolates the instrument from the supply.

When switched to ON, the instrument powers up, runs a self-test program and is configured into the following state:

OUTPUT	OFF
FUNCTION	DC
OUTPUT RANGE	1
OUTPUT DISPLAY	.000,000,V
FREQUENCY RANGE	Not selected
MODE/FREQUENCY DISPLAY	Blank
MODE	Not selected
Guard	Local connection (unlit)
Sense	Local connection (unlit)
Key LEDs Lit	OUTPUT OFF, DC, 1

OUTPUT Switching

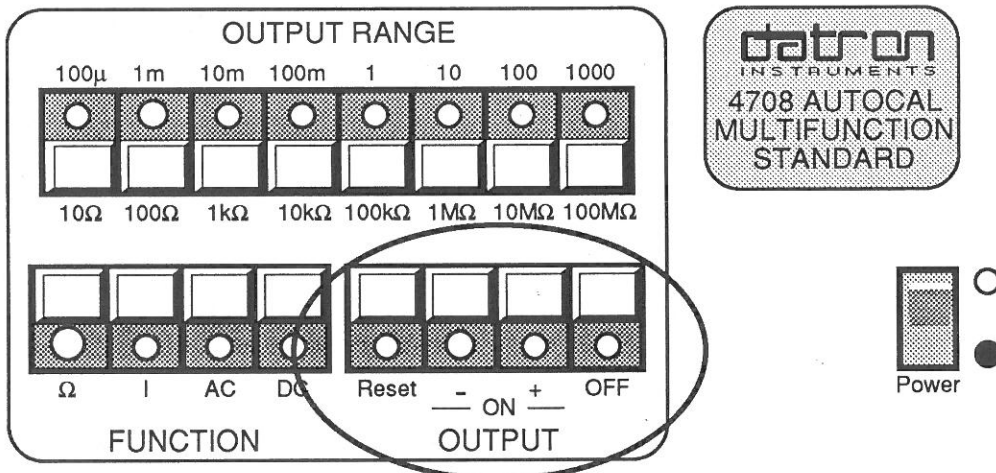

OUTPUT ON/OFF

The 4708 should normally be connected and set up with its **output off**. This isolates the **I+**, **I-**, **Hi** and **Lo** terminals from their internal circuitry regardless of **RANGE**, **FUNCTION**, **FREQUENCY** or **MODE** selections. The **OUTPUT OFF** LED is lit.

Pressing the **OUTPUT ON** key connects the **I+**, **I-**, **Hi** and **Lo** terminals to their energized internal circuits.

OUTPUT OFF Default

Certain instrument states are prohibited, and some transfers between states are restricted by program firmware. For safety reasons some of these transfers result in the output being switched off. Refer to Section 4, Operating Routines.

OUTPUT ON - +

On DC Voltage or Current, the polarity at the Output terminals is determined by the Key used to switch the output on, as labelled. In addition, polarity may be reversed by using the **↑ ↓** keys to step the output across zero value. The **ON** LEDs describe the polarity **AT THE OUTPUT TERMINALS**, not on the **OUTPUT** display. (In "error" and "offset" modes these two could be opposite).

In AC Voltage, AC Current and Resistance functions, the **ON +** key will cause the selected outputs to appear at the output terminals. The **ON -** key will cause the error buzzer to sound and **Error 8** to appear in the **MODE/FREQUENCY** display.

OUTPUT OFF Trip - Fail 5 Message

Under certain abnormal conditions which might compromise

safety, the 4708 output will trip off, accompanied by a **FAIL 5** message on the **MODE** display. Control is removed from the front panel keys.

If the **FAIL 5** message is present, there is **no** automatic recovery from the tripped state whether internal conditions have or have not returned to normal.

Reset Key

The **Reset Key** has two functions:

1. It allows the user to reset the safety trip to test whether conditions have returned to normal. If they have; the **FAIL** message will disappear, the previous instrument state will be restored but with **OUTPUT OFF**, and front panel control will be returned to the user. If conditions are still abnormal the **FAIL** state will persist, and a further attempt may be made after a suitable interval. The **Reset LED** is inoperative except in 'TEST' mode.
2. It returns the instrument to power-up conditions in all cases except the following:
 - Self-test mode
 - FAIL conditions
 - In remote control mode (where it is inoperative).

Other Messages

A full list of 4708 messages appears in Section 4. The fault conditions which generate Fail messages are analyzed in the Calibration and Servicing Handbook.

FUNCTION Keys

When changing from one function to another the output is automatically set to OFF. When changing from Ω , to AC or DC, the OUTPUT value is automatically set to zero. If the corresponding OUTPUT RANGE or value is not available on the new function, the 4708 displays Error 8 and sounds its error buzzer.

Ω selection forces the 4708 into Remote Sense for 4-wire operation.

Selected Function	Specified Output	
DC	DC Voltage	} or Error 9 and buzzer if any of the Options are not fitted
AC	AC Voltage	
Ω	Resistance	
DC and I	DC Current	
AC and I	AC Current	

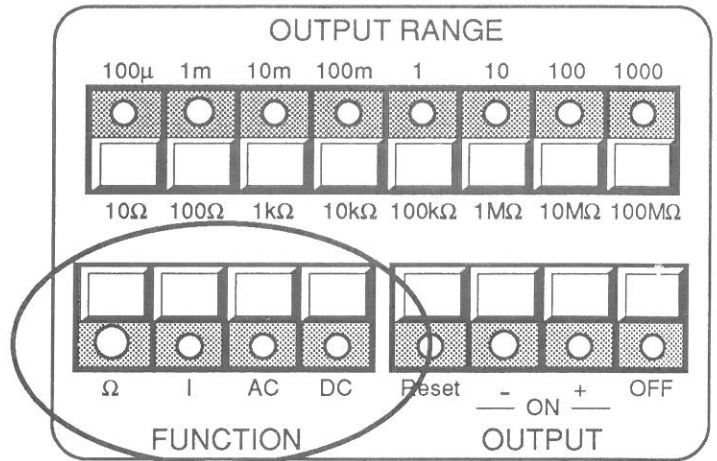

OUTPUT RANGE Keys

Each OUTPUT RANGE key scales the output as selected by the user, setting the legend and decimal point on the OUTPUT display to match. Full range values for voltage and current are marked above the keys. Nominal values of each precision resistor for the Ω function are marked below the keys. Voltage and current ranges are selectable as follows, the actual output value being selected by use of the OUTPUT display $\uparrow \downarrow$ keys.

DC Voltage	:	100 μ V to 1000V
AC Voltage	:	1mV to 1000V RMS
DC Current	:	100 μ A to 1A
AC Current	:	100 μ A to 1A RMS
Resistance	:	10 Ω to 100M Ω

If OUTPUT is ON when changing ranges, it remains on unless the change is to 1000V range, or ranging up to more than 75V RMS in AC or 110V in DC on 100V range. In these cases OUTPUT defaults to OFF. Any range selection which would exceed the internally defined voltage-frequency limit is automatically inhibited. These limits are described on page 3-7.

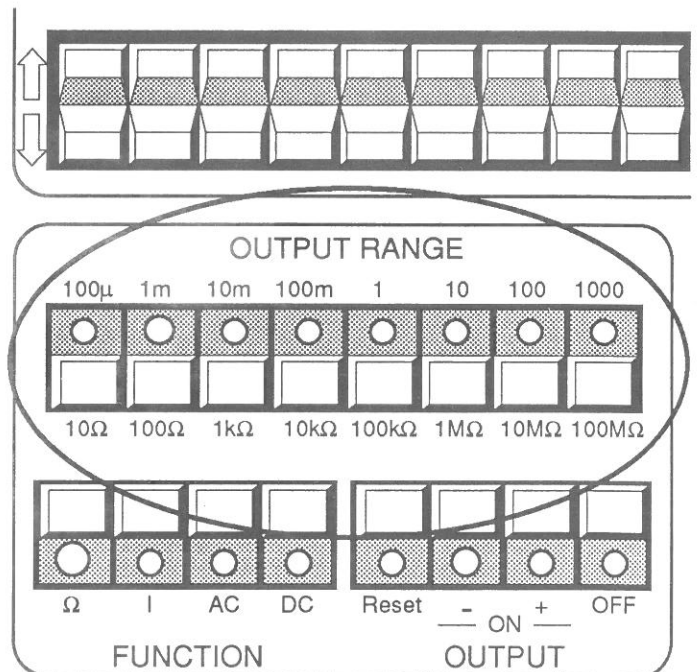

Key Selections	100μ 10	1m 100	10m 1k	100m 10k	1 100k	10 1M	100 10M	1000 100M
DC Voltage	100μA	1mV	10mV	100mV	1V	10V	100V	1000V
AC Voltage	*	1mV	10mV	100mV	1V	10V	100V	1000V
DC Current	100μA	1mA	10mA	100mA	1A	10A ^[1]	*	*
AC Current	100μA	1mA	10mA	100mA	1A	10A ^[1]	*	*
Resistance	10Ω	100Ω	1kΩ	10kΩ	100kΩ	1MΩ	10MΩ	100MΩ

*Error 8

[1] Error 8 if 4600 not connected in slave mode configuration

OUTPUT Display and ↑ ↓ Keys

Output Resolution

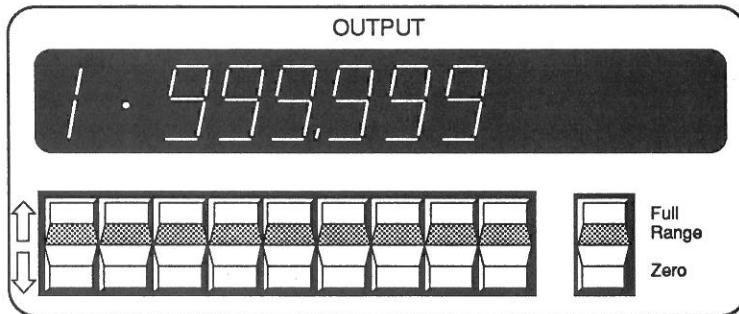

The Output and display are resolved as follows:

Range	100μ 10	1m 100	10m 1k	100m 10k	1 100k	10 1M	100 10M	1000 100M
DCV	4.5	5.5	6.5	7.5	7.5	7.5	7.5	7.5
ACV	-	4.5	5.5	6.5	6.5	6.5	6.5	6.5
DCI	6.5	6.5	6.5	6.5	6.5	6.5	-	-
ACI	6.5	6.5	6.5	6.5	6.5	6.5	-	-
Ω (2-wire)	4.5	5.5	6.5	7.5	7.5	7.5	7.5	7.5
Ω (4-wire)	7.5	7.5	7.5	7.5	7.5	7.5	7.5	7.5

The OUTPUT display is supplemented by legends, which always indicate the correct units for the Range and Function selected

Output and Display Control

Each vertical pair of ↑ ↓ keys is assigned to the display digit above it. Thus the value registered on the display may be set within the range permitted by the function selected. Each momentary press of the ↑ key adds 1 to its digit; pressing the ↓ key subtracts 1. If OUTPUT is ON, the Output terminal value is also changed by the same increments as the display (subject to the instrument interlocks).

On Ω ranges, only the overrange (leftmost pair of) ↑ ↓ keys are

operative. These duplicate the action of the Full Range/Zero Keys.

The Resistance value displayed is the calibrated value of the standard internal resistor selected (not the nominal value). This may be updated during periodic calibration. The value displayed depends on the selection of Local (2-wire) or Remote (4-wire) Sense, and should be recalibrated in the correct Sense mode (See Section 8).

Auto-Increment/Decrement

When a $\uparrow\uparrow$ key is pressed for more than 1/2 second, its digit is increased or decreased at a rate of approximately 3 digits per second until the key is released.

Overflow and Underflow

As a digit is stepped from 9 to 0, the value of the next higher-order digit is increased by 1. Stepping from 0 to 9 decreases the value by 1. The whole display therefore acts as a counter, with full 'carry' and 'borrow' action.

Range of Adjustment for DC Functions

The $\uparrow\uparrow$ keys adjust the readings between a minimum of 00000000 and 19999999 full scale on 100mV - 100V and between 00000000 and 19999999 for Current Ranges. The 1000V Range has a Full Scale of 1100.0000; on the 100 μ V, 1mV and 10mV ranges the resolution is truncated.

Range of Adjustment for AC Functions

The $\uparrow\uparrow$ keys adjust the reading between a minimum of 0090000 (9% of Nominal Range), and maximum of 1999999 full scale on 100mV - 100V and Current Ranges. The 1000V Range has a Full Scale of 1100.000; on the 1mV and 10mV ranges the resolution is truncated.

N.B. There is no range of adjustment on Resistance functions.

Leading Zeroes

For fractional readings, a leading zero is presented to the left of the decimal point to emphasise its position, except for **OUTPUT RANGE** selections 1m and 1.

DC ZERO and polarity. On DC voltage and current, a polarity sign is present except at zero. The numerical display represents the magnitude of the output.

As the display value is stepped to zero, the polarity sign disappears, and the opposite sign appears as stepping continues in the same direction. If the **OUTPUT** is **ON** during the sequence, the change in output polarity is signalled by a change-over from one polarity **ON** LED to the other.

N.B. If the 4708 is in **Offset Mode**, with an offset present, the display and output zeroes do not coincide. It is therefore possible to have a **positive** sign on the display, and the **ON** - LED lit; and vice-versa.

When using the $\uparrow\uparrow$ keys or **Zero** key to obtain a zero, the polarity is not changed over and the same **OUTPUT ON** LED remains lit. The polarity LEDs change over only when the opposite polarity appears at the output terminals.

Full Range Key

When the **Full Range** key is pressed, the display reverts to the nominal value of the range selected. If **OUTPUT** is already **ON**, the terminal value follows the display value unless:

1. The combination of output voltage and frequency would exceed the instrument's internally defined limits. (Refer to Section 6).
2. **OFFSET** or **ERROR** Mode is selected: the user-input offset or gain error is not cancelled from the output.

Zero Key

This reduces the display value to zero. If **OUTPUT** is **ON**, the terminal value is also set to zero:

DC Voltage — an active zero is presented to the output terminals.

AC Voltage — an internal short circuit is connected across the output terminals.

DC and AC Current — output terminals are open-circuited.

On Ω ranges in **Remote Sense** with **OUTPUT ON**, the **Zero** key connects a true 4-wire internal short circuit to the **OUTPUT** terminals as shown below. With **Remote Sense LED UNLIT**, the same short is connected, but the actual resistive value of this short may be calibrated (See Section 8 and diagram below).

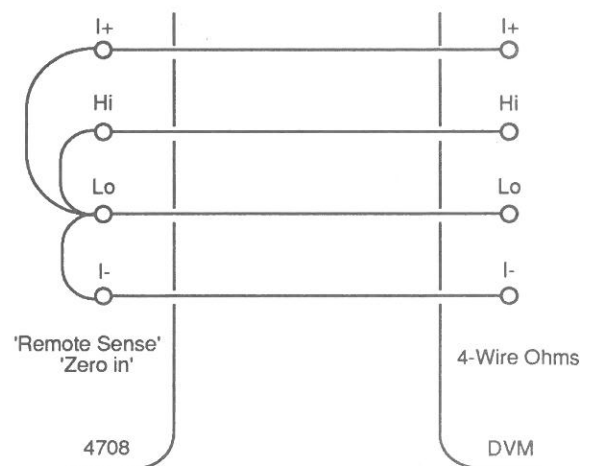

True 4 - Wire Ohms Zero

Deselection of Zero in AC Functions

The size of the characters on the 'Zero' display is significant. A half-size '0' above any $\uparrow\downarrow$ key indicates that it cannot be used to deselect Zero, because it increments values which are less than 10% of nominal range. Any \uparrow key with a full size '0' above it (and any key to its left) deselects Zero and adds its increment.

Selection of High Voltage Outputs

The 4708 is capable of delivering **LETHAL** output voltages so program interlocks are used to ensure that users do not inadvertently select outputs in excess of 110V in DC or 75V RMS in AC. Details of the High Voltage selection procedure are given in Section 4.

Frequency

The AC voltage output of the 4708 extends from 10Hz to 1MHz in five overlapping decade ranges, at a resolution of 1% of nominal Frequency Range. Any five frequency values within the range of the instrument can be stored in volatile memory.

FREQUENCY RANGE keys

Decade Ranging

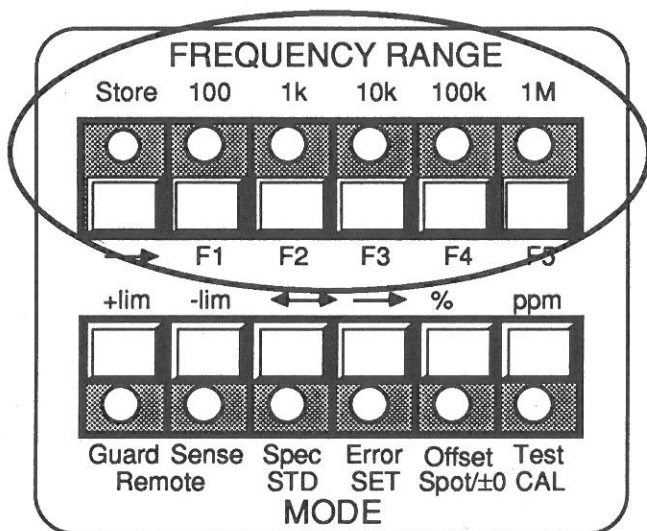

Generally, selection of a new range changes the frequency by a whole number of decades; but ranging-up from a frequency between 10Hz and 30Hz, or ranging-up to the 1MHz range when the decade frequency would have been higher, causes **Error 7** to be displayed and buzzer to sound.

Selection of Nominal Range Value

Once a Frequency Range has been selected, the frequency can be set to the nominal value of the range by re-pressing its key.

FREQUENCY DISPLAY

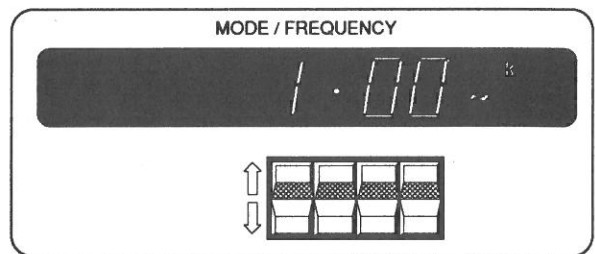

Resolution

The output frequency is adjustable in steps of 1% of the selected **FREQUENCY RANGE** nominal value, matching the display resolution. Legends are appended on the display as appropriate, and a leading zero is presented to the left of the decimal point for fractional values.

FREQUENCY $\uparrow\downarrow$ Control Keys

Each vertical pair of $\uparrow\downarrow$ keys is assigned to the display digit above it. The frequency registered on the display is adjusted by manipulation of these keys. Each momentary press of the \uparrow key adds 1 to its digit, and each \downarrow key subtracts 1. If **OUTPUT** is ON, the output frequency is also changed by the same increments as the display (subject to the instrument interlocks). Keys below decimal points are inactive.

Auto-Increment/Decrement

When a $\uparrow\downarrow$ key is pressed for more than 1/2 second its digit is increased or decreased at a rate of approximately 3 digits per second until the key is released.

Overflow and Underflow

As a digit is stepped from 9 to 0, the value of the next higher-order digit is increased by 1. Stepping from 0 to 9 decreases the value by 1. The whole display therefore acts as a counter, with full 'carry' and 'borrow' action.

Autoranging

Stepping the frequency beyond the span of a range automatically switches range up or down, but further steps are inhibited until the \uparrow or \downarrow key is released (the key could be below a decimal point). When the range-change occurs, the alarm buzzer sounds and the **FREQUENCY** display is blanked for approx. 1 second.

When the display is reinstated, the 4708 has remembered the last frequency on the old range, and sets the new range to its next increment frequency in the original direction. After releasing the original key, stepping can be continued to any increments of the new range.

Autorange Limits

The 4708 displays an Error 7 and sounds its buzzer when any attempted frequency increment or decrement is made which would produce an invalid combination of **FUNCTION**, **OUTPUT RANGE** or **FREQUENCY**. Neither will it increment or decrement to a frequency beyond the limits of the next frequency range up or down.

OUTPUT/FREQUENCY CONSTRAINTS

AC Voltage and Frequency

Under most conditions, the output amplitude and frequency are adjustable throughout their full scales:

Voltages — from 90 μ V to 1100V RMS

Frequencies — from 10Hz to 1MHz

On the 100V and 1000V Ranges, certain combinations of voltage and frequency cannot be selected. The diagram below illustrates the boundaries.

The 10V Range span is also shown for comparison.

The 4708 refuses to select any Voltage/Frequency combination outside these constraints. The temporary message Error 7 is displayed for approximately 1 second before reverting to the original display.

AC Current and Frequency

AC Current is adjustable between 9 μ A and 2A RMS at frequencies from 10Hz to 5kHz. Currents from 2A to 11A are available (10Hz - 20kHz). Error 7 indicates an invalid Current/Frequency selection.

FREQUENCY MEMORY

This facility allows storage of up to five user-selected frequencies. Once stored, each can easily be retrieved or changed from the front panel. They are retained until power is removed from the instrument or reset key is depressed.

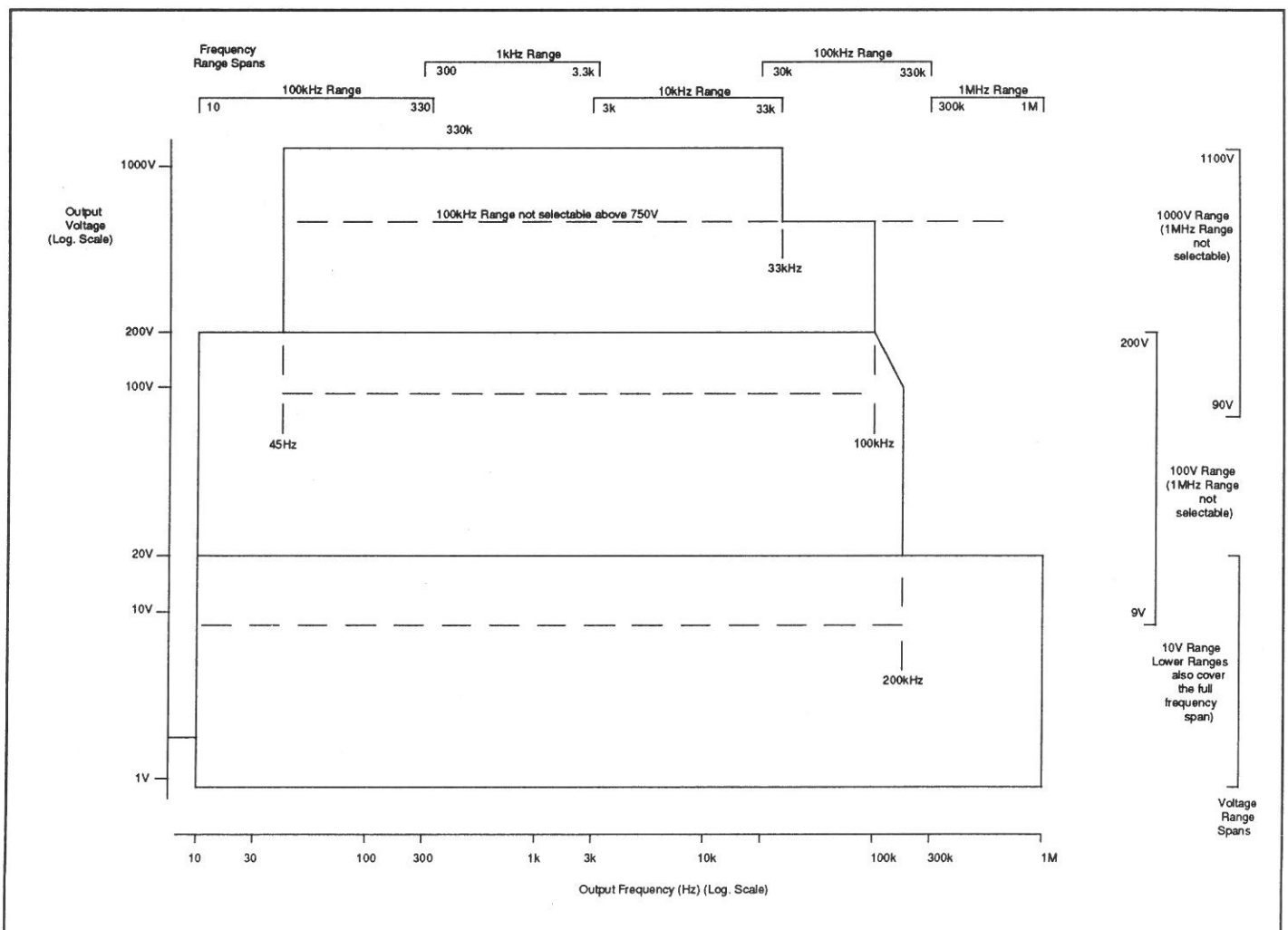

Store Key

Only five of the **FREQUENCY RANGE** keys select ranges. The first press of the sixth key, **Store**, reassigns the other five as frequency memories. It has toggle action: a second press deselects the memory function.

F1-F5 Memory keys

When the **Store** LED is ON, these keys select individual memory locations.

N.B. Although the **FREQUENCY RANGE** keys double as memory selectors, this does not imply that a particular memory can only accept frequencies from its key's range. It is emphasized that any displayable frequency can be stored in any of the five locations.

Power-up Default

Because the stores are volatile, the following default frequencies are stored in the five memory locations each time the 4708 is powered-up:

F1	30Hz
F2	300Hz
F3	3kHz
F4	30kHz
F5	300kHz

Details of storage and retrieval procedures are described in Section 4.

SPOT F FREQUENCY MEMORY

When in Calibration Mode, five user-selected 'Spot' calibrated frequencies can be stored in non-volatile calibration memory, for each of the seven Output Ranges. At these frequencies the 4708 output can be specially Auto-calibrated. Each spot calibrated frequency can then be subsequently recalled when in Run Mode by two key depressions.

Spot Key

This is used to reassign the F1-F5 memory keys so that they access the non-volatile memory.

'Recall' procedures are detailed in Section 4.
 'Store' procedures are detailed in Section 8.

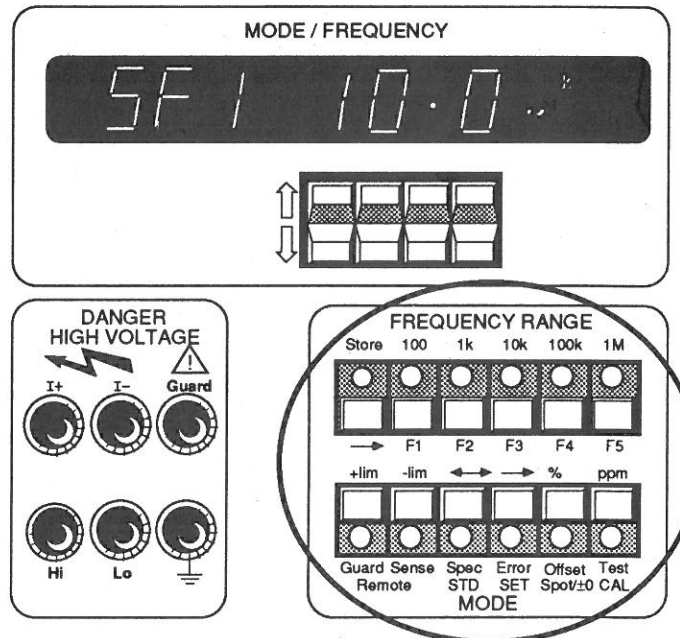
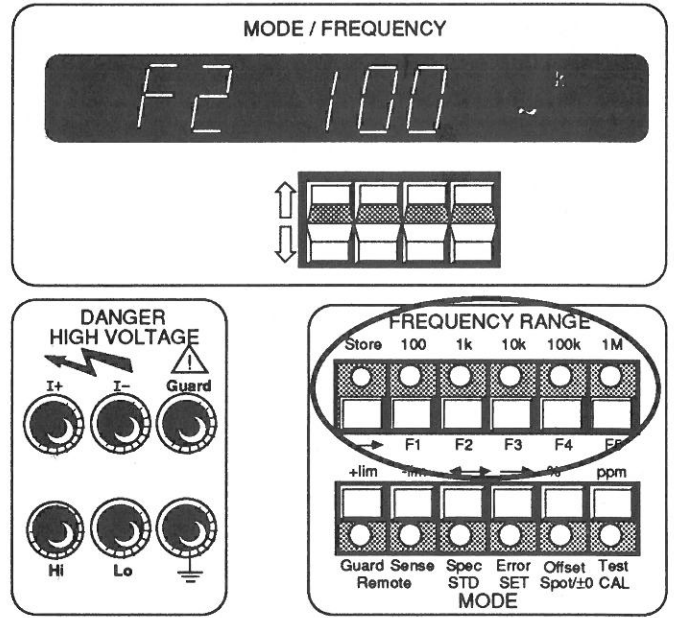

MODE Selection keys

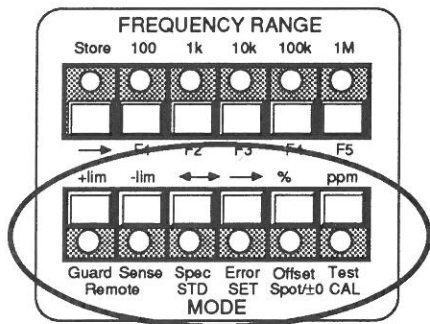

The **MODE** selection keys are located on the lower left of the front panel. The Remote Guard and Remote Sense keys are described under 'I+, I-, Hi, Lo, Guard and $\frac{1}{2}$ '.

STD, SET, ±0 and **CAL** are calibration modes, printed in red and described in Section 8.

SPEC MODE

The **Spec** key controls the toggle-action 'Specification' function. By pressing the key, the 4708 specification tolerances are displayed on the **MODE** display, referred to its current **FUNCTION, OUTPUT, FREQUENCY** and **CALIBRATION INTERVAL** selection. A second press cancels the function. For 24-hour calibration intervals, the 'accuracy relative to calibration standards' figures are displayed but for 90 days and 1 year intervals they are 'Traceable' accuracy figures which include Datron's Calibration Uncertainty.

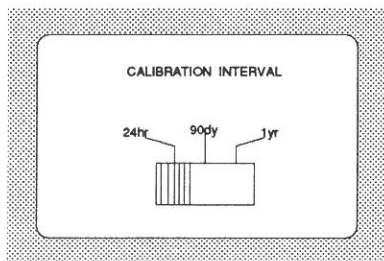

Rear Panel CALIBRATION INTERVAL switch

While in **Spec** mode, all primary functions of the other **MODE** keys are cancelled (although the selected Guard and Sense connections remain). The keys are reassigned to their secondary functions: **+lim**, **-lim**, **%** and **ppm** become active. When **Spec** mode is initiated, the magnitude of the specification tolerance itself determines whether **ppm** or **%** is selected. The double-ended arrow above the **Spec** key shows that all four secondary modes are available.

Full details of the operation of Specification mode are given in Section 4.

ERROR AND OFFSET MODES

These keys are used to deviate the output at the terminals from the value on the **OUTPUT** display. The two modes may be selected together.

Error and Offset Modes NOT Selected

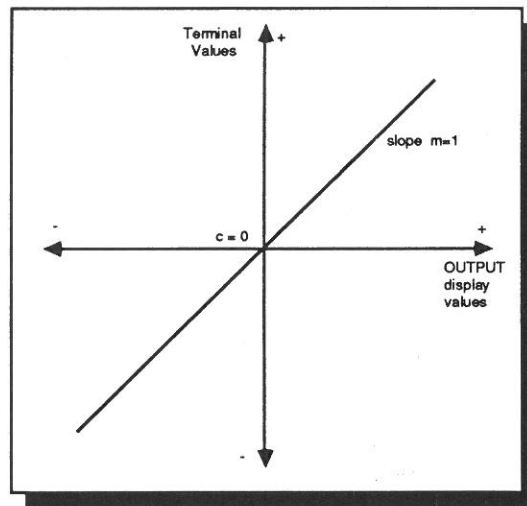

The terminal value is a linear function of the **OUTPUT DISPLAY** value:

Error mode selected

This mode allows a gain error deviation of up to $\pm 10\%$ of displayed value to be applied to the terminals. Full details are given in Section 4.

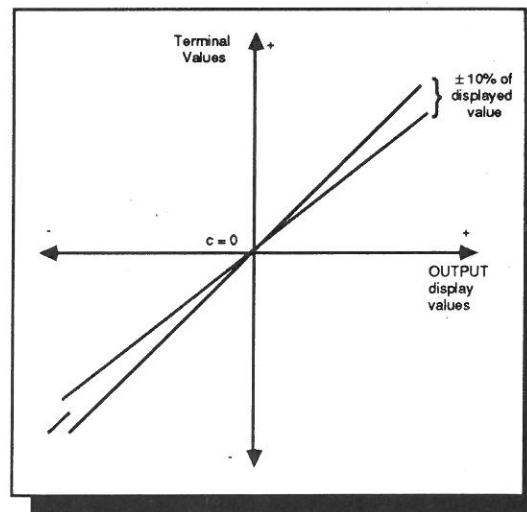

Offset mode selected (DC Functions only)

In Offset mode, the intercept (c) may be adjusted to any value within the Offset limit.

Offset Limits: 100 μ V and 1mV Ranges: $\pm 200\mu$ V
Other Ranges: $\pm 2\%$ of Full Range value

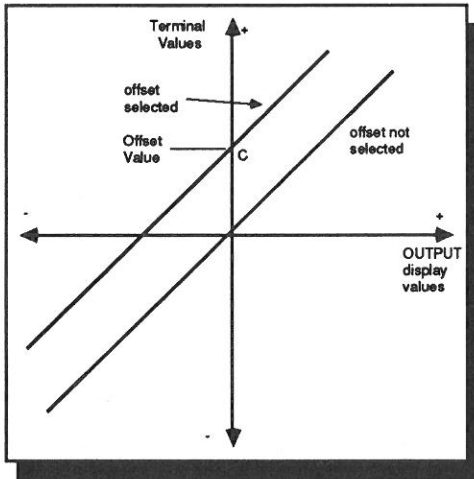

Offset and Error Mode Combination

Offset cannot be selected or deselected when the 4708 is already in Error Mode.

The intercept (c) is established first in Offset mode, then the slope (m) is adjusted in Error mode.

Full details of the operation of Error, Offset and the combined mode are given in Section 4.

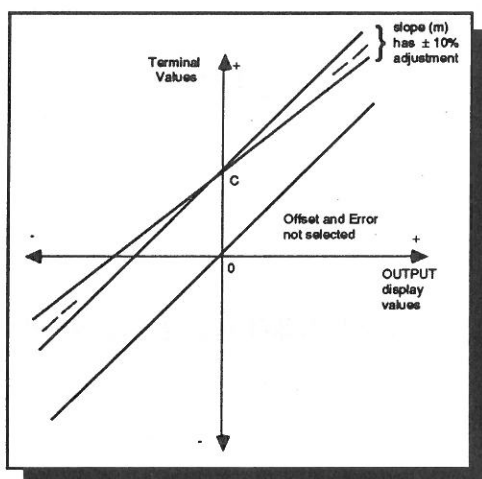

Test mode selected.

Full details of the operations in Test mode are given in Section 4.

I+, I-, Hi, Lo, Guard and \perp (Ground) Terminals

Local and Remote Switching

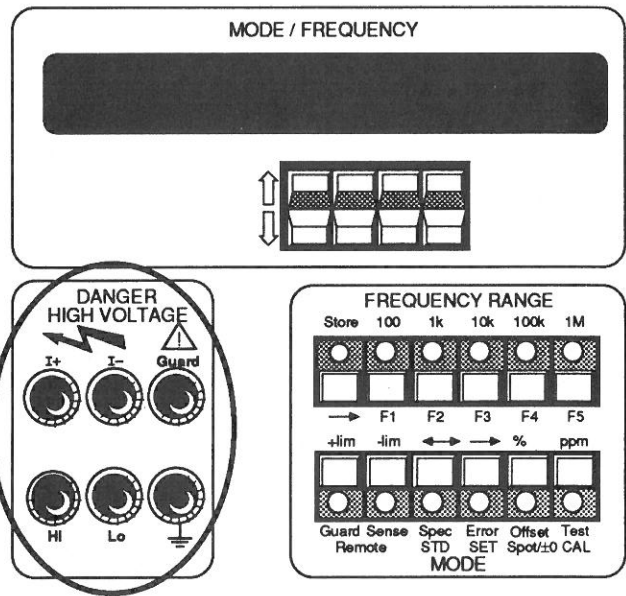

These terminals are located on the lower left of the Front Panel.

I+ and I- Terminals

The output from the internal power circuits is delivered to the I+ terminal, I- being its Return Analog Common.

Hi and Lo Terminals

These terminals provide a differential input to the amplitude sensing circuitry.

Remote Sensing

The Remote Sense key has 'toggle' action. Successive presses alternate between ON and OFF.

N.B. Sense Connections can only be switched with OUTPUT OFF.

The specified voltage output of the 4708 may be produced either at its output terminals (Local Sense for high impedance loads) or at the load terminals (Remote Sense for cases in which lead resistance and load impedance produce a significant effect).

With remote Sense OFF, the I+ terminal is isolated, and the voltage output is fed to the Hi terminal.

With **Remote Sense ON**, the output voltage is fed across the **I+** and **I-** terminals only, and must be sensed externally, using leads connected to the **Hi** and **Lo** terminals.

Remote Sense is not available on 100 μ V - 100mV ranges. It is not applicable to Current outputs.

On **Ohms** ranges, **Local Sense** is used for 2-wire connections, and **Remote Sense** for 4-wire. (Changing **FUNCTION** into Ω forces the 4708 into **Remote Sense**, but this may be deselected for 2-wire operation). The **Remote Sense LED** always indicates the true connection:

- Lit = Remote;
- Unlit = Local

Guard Terminal

The **Guard** terminal is permanently connected to the internal guard shields:

Remote Guard

The **Remote Guard** key has 'toggle' action. Successive presses alternate between **ON** and **OFF**.

With **Remote Guard OFF**, **Guard** is internally connected to the **I-** terminal.

With **Remote Guard ON**, the internal link to **I-** is removed. The **Guard** terminal can then be connected externally to reduce common mode interference.

Ground Terminal

The ⏏ **Ground** terminal connects directly to the 4708 internal Ground shields and to Safety Ground via the power cable.

Output Connections

Connections to the output terminals may be made either with leads or via a shrouded connector.

For Voltage outputs in local sense the two leads should be attached to the **Hi** and **Lo** terminals.

Various configurations of 4708 load connections are detailed in Section 4.

REAR PANEL

(Shown with alternative Rear Output terminals)

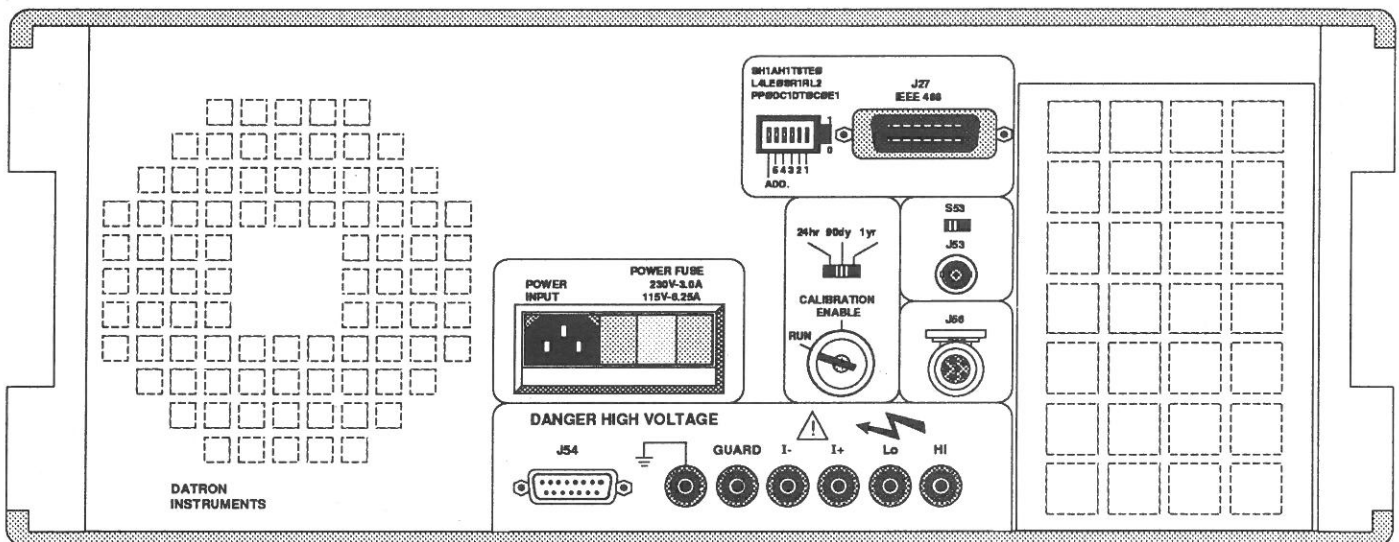

POWER INPUT

The recessed **POWER INPUT** plug, **POWER FUSE** and **LINE VOLTAGE SELECTOR** are located in the center of the rear panel, contained within a single moulded unit. Details of connections, selection of line voltage and fuse are given in Section 2.

REAR OUTPUT ALTERNATIVE (Option 42)

This can be incorporated at manufacture, to provide six output terminals on the rear panel instead of the six on the front. Their functions and connections are identical.

SOCKET J53 (External Reference Frequency Input)

This BNC socket is located next to the cooling air intake filter. It may be used to lock the internal frequency synthesizer to a customer's own frequency standard. Voltage and frequency criteria are given in Section 2. An on-off switch, **S53**, located above this socket is provided to enable this facility. If the switch is on and an external frequency is not present, error message 'Error EF' is displayed.

SOCKET J54 (External Reset & 4600 Digital Connector)

This D-type socket is located next to the optional rear output connectors and provides digital control signals between the 4708 and a 4600 Transconductance Amplifier. It may also be used to input an external reset to restore the 4708 to its power-up state of DCV, 1V Range etc., if required. Pin Layout, Pin Designation and Switch Wiring details are given in Section 2.

This connector is specifically designed to accept the digital control cable supplied as part of the 4600 slave lead kit (Part number 440151)

SOCKET J27 (IEEE 488 Input/Output)

The IEEE 488 Input/Output (D-type) socket J27 is a 24-way micro-ribbon connector that is directly compatible with the IEEE 488 interface and the IEC-defined system.

J27 is located at the top of the rear panel, outlined with the IEEE 488 address switch. The pin layout and designations appear in Sections 2 and 5.

IEEE 488 ADDRESS SWITCH

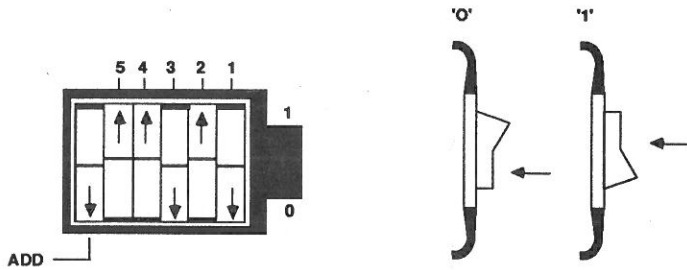

The 4708 may be addressed for use on the IEEE 488 interface bus. The address settings are given in Section 5.

SOCKET J56 (4600 Analog Connector)

Situated beneath J53, Socket J56 provides analog connections between the 4708 and a 4600 Transconductance Amplifier. This connector is specifically designed to accept the analog control cable supplied as part of the 4600 slave mode lead kit (Part number 440151).



DANGER

HIGH VOLTAGE



**THIS INSTRUMENT IS CAPABLE
OF DELIVERING
A LETHAL ELECTRIC SHOCK !**
when connected to a high voltage source

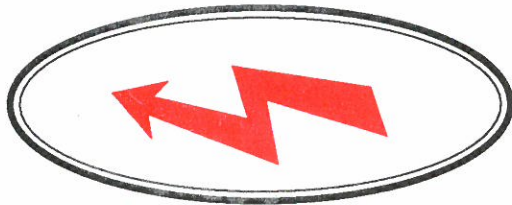

FRONT or REAR terminals
carry the Full Input Voltage

THIS CAN KILL !



Guard terminal is sensitive to
over-voltage

**It can damage your
instrument !**

Unless **you** are **sure** that it is **safe** to do so,
DO NOT TOUCH
the **I+ I- Hi** or **Lo leads** and **terminals**

DANGER

SECTION 4 USING THE DATRON 4708

Preliminaries

Before using the instrument it is important that it has been correctly installed as detailed in Section 2.

Limiting Characteristics

The following details are given in Section 6:

Function	Characteristics
All functions	Peak terminal voltages
DC Voltage	Output resistance and current limit
AC Voltage	Output resistance and current limit; capacitive loading limits
DC Current	Maximum load resistance and maximum compliance
AC Current	Maximum load resistance and maximum compliance
Resistance	Maximum currents and accuracy de-rating factors

THE TERMINALS MARKED WITH THE ⚡ SYMBOL CARRY THE OUTPUT OF THE 4708. THESE TERMINALS AND ANY OTHER CONNECTIONS TO THE LOAD UNDER TEST COULD CARRY LETHAL VOLTAGES.

UNDER NO CIRCUMSTANCES SHOULD USERS TOUCH ANY OF THE FRONT (OR REAR) PANEL TERMINALS UNLESS THEY ARE FIRST SATISFIED THAT NO DANGEROUS VOLTAGE IS PRESENT.

CAUTION;

THE ⚠ SYMBOL IS USED TO REMIND THE USER OF SPECIAL PRECAUTIONS DETAILED IN THIS HANDBOOK AND IS PLACED ADJACENT TO TERMINALS THAT ARE SENSITIVE TO OVERVOLTAGE CONDITIONS.

REFER TO SECTION 6.

SAFETY

The 4708 is designed to be Class 1 equipment as defined in IEC Publication 348 and UL 1244, concerning safety requirements.

Protection is provided by a direct connection via the power cable from ground to exposed metal parts and internal ground screens.

The line connection must only be inserted in a socket outlet provided with a protective ground contact, and continuity of the ground conductor must be assured between the socket and the instrument.

WARNING:

ANY INTERRUPTION OF THE PROTECTIVE GROUND CONDUCTOR INSIDE OR OUTSIDE THE INSTRUMENT, OR DISCONNECTION OF THE PROTECTIVE GROUND TERMINAL MAY MAKE THE APPARATUS DANGEROUS. INTENTIONAL INTERRUPTION IS PROHIBITED.

Interconnections

Importance of Correct Connections

The 4708 has been designed for use as an accurate source for precision calibration. To match the external circuitry to its superior specification, it is essential to take great care in making connections to the load.

Sources of Error

Thermal EMFs

These can give rise to series (normal) mode interference, particularly for low voltage outputs, and where large currents have a heating effect at thermo-electric junctions. Draughts can cause unbalanced cooling in an otherwise thermo-electrically balanced measuring circuit.

E-M Interference

Noisy or intense electric, magnetic and electromagnetic effects in the vicinity can disturb the measurement circuit.

Some typical sources are:

- Proximity of large electric fields
- Fluorescent lighting
- Inadequate screening, filtering or grounding of power lines
- Transients from local switching
- Induction and radiation fields of local E-M transmitters
- Excessive common mode voltages between source and load

The disturbances may be magnified by the user's hand capacitance. Electrical interference has greatest effect in high impedance circuits. Separation of leads and creation of loops in the circuit can intensify the disturbances.

Lead Impedance

The impedance of the connecting leads can drop significant voltages between the source and load, and generate adverse phasing effects particularly if the leads are long or the current in them is high.

Lead Insulation Leakage

This can cause significant errors in measurement circuits at high voltages. Some insulating materials suffer greater losses than others e.g. PVC has more leakage than PTFE.

AVOIDANCE TACTICS

Thermal EMFs

Screen thermal junctions from draughts.

Allow time for thermal equilibrium to be reached before taking readings.

Use conductors, joints and terminals with a good margin of current-carrying capacity.

Avoid thermo-electric junctions where possible.

e.g. Use untinned single-strand copper wire of high purity. Avoid making connections through Nickel, Tin, Brass and Aluminium. If oxidation is a problem use gold-plated copper terminals, and replace the terminals before the plating wears off. If joints must be soldered, low-thermal solders are available, but crimped joints are preferred. Use low-thermal switches and relays where they form part of the measuring circuits.

Balance one thermal EMF against another in opposition, where possible (switch and relay contacts, terminals, etc.).

E-M Interference

Choose as 'quiet' a site as possible (a screened cage may be necessary if interference is heavy).

Suppress as many sources as possible.

Always keep interconnecting leads as short as possible, especially unscreened lengths.

Run leads together as twisted pairs in a common screen to reduce loop pick-up area, but beware of leakage problems and excessive capacitance.

Where both source and load are floating, connect I- to ground at the source to reduce common mode voltages.

Lead Impedance

Keep all leads as short as possible. Use conductors with a good margin of current-carrying capacity. Use Remote Sense and 4-wire connections where necessary to establish the 4708 output specification at the load. Use 4-wire connections for values of resistance below $1k\Omega$.

Lead Insulation Leakage

Choose low-loss insulated leads - PTFE is preferred to PVC. When running leads together in screened pairs, avoid large voltages between leads in the same screen, especially if using PVC insulation.

Remote/Local Sense Configurations

The 4708 terminals are configured as follows:

Voltage ranges 100 μ V, 1mV, 10mV, 100mV

- Local sense only.

1V, 10V, 100V, 1000V

- user selects Local or Remote sense

All Current ranges - Local sense only.

All Resistance ranges

- Remote Sense gives 4-wire connection

- Local Sense provides 2-wire connection capability

The key LED indicates the true connection:

Lit = Remote, Unlit = Local

N.B. When changing to Ω function, the 4708 is automatically forced into Remote Sense for 4-wire operation.

4708 - CONNECTIONS TO THE LOAD

General Considerations

The choice of connection method is influenced by several factors:

a. Loading Effects

4-wire connections should be used for low load impedances. For high impedance loads, 2-wire connections can be employed.

The ratio : $\frac{\text{Total Lead Resistance}}{\text{Load Resistance}}$

gives the approximate error for 2-wire connection at low frequencies.

e.g. Two 1/2 Ohm leads with a load of $100k\Omega$ to produce an error of approx. 10ppm.

At frequencies higher than about 100kHz, the error is also modified by reactive effects.

b. Noise and Output Level

Providing the E-M environment is reasonably quiet, interference due to noise pick-up in the load connection is

insignificant for outputs of more than about 100mV, so unscreened leads can be used. But at lower signal levels, or in noisier environments, it is advisable to use screened cable.

c. Common Mode Disturbances

When in Local Guard, the guard shields and tracks for the Sense circuitry are connected internally to 'I-', the low impedance terminal of the 4708 output power source. This classical connection effectively guards out internal common mode disturbances. To reduce external disturbances it is advisable to make only one ground connection to the measurement circuit, and in the case of a guarded DMM, to make use of its external guard facilities. Also, where a line-powered load (such as a DMM being calibrated) has a ground connection, it should be to the same line ground as the 4708.

d. High Frequency Effects

i. Voltage. Up to about 100kHz, for outputs above 100mV, it is possible to use pairs of unscreened wires, provided that the E-M environment is quiet. Twist or run leads together; keep length less than 1 meter.

Above 100kHz, both lead and load capacitances reduce the load impedance. Similarly, lead and load inductances combine to increase the load impedance with frequency (but heavily reactive loads should be avoided). It is therefore advisable to make leads from low-capacitance coaxial or twin-axial cable. To avoid mutual coupling, Sense and Power leads should not run together in the same screen.

ii. Current. Above about 1kHz, with low output currents, high lead capacitance can introduce shunt errors. To reduce these errors, the leads should be kept as short as possible, and be of low-capacitance.

e. DANGER
THE 4708 OUTPUT CIRCUITS ARE NOT INTERNALLY CONNECTED TO GROUND. USERS ARE STRONGLY ADVISED TO CONNECT L_o OR I- EXTERNALLY TO GROUND (PREFERABLY AT THEIR COMMON JUNCTION), WHEN THE 4708 IS TO BE USED ON THE 100V OR 1000V RANGE. THIS ELIMINATES THE RISK OF L_o AND I- FLOATING TO HIGH VOLTAGE.

b. the extensive set of combinations of outputs from the instrument, and
c. the accuracy required;
it is unrealistic to describe a definitive 'best' general method of connection to the load.

Combinations of the above factors can lead to conflicting requirements, and users may be faced with a choice between methods. In these cases it is sometimes necessary to arrive at a compromise solution by setting priorities.

Suggested Lead Connections for the 4708

Six suggestions for connecting the 4708 to its load are illustrated in the following pages 4-4 and 4-5. Each has found use with the combination of factors described, and together they cover the majority of predicted requirements.

Setting Priorities

Because of:

a. the variety of environmental conditions and loads likely to be encountered when using the 4708,

Typical Lead Connections

Voltage and Resistance Outputs

CAUTION: All leads and cables must be proofed to at least 2kV.

NOTE: Refer also to reactive load specifications in Section 6.

Simple 2-wire Connection

Use for many applications where:

- The voltage drop in the leads is insignificant.
- The E-M environment is 'quiet'.
- External common-mode voltages are insignificant.

Use for measurements in the following ranges:

- Voltage DCV $\geq 100\text{mV}$
ACV $\geq 100\text{mV}$
- Frequency $F < 100\text{kHz}$
- Resistance $1\text{k}\Omega \leq R < 1\text{M}\Omega$

N.B. After selecting Ω , Remote Sense must be cancelled for 2-wire operation.

Select Local Sense and Local Guard.

Keep leads as short as possible, (not longer than 1 meter-twisted pair is preferable).

4708
Terminals

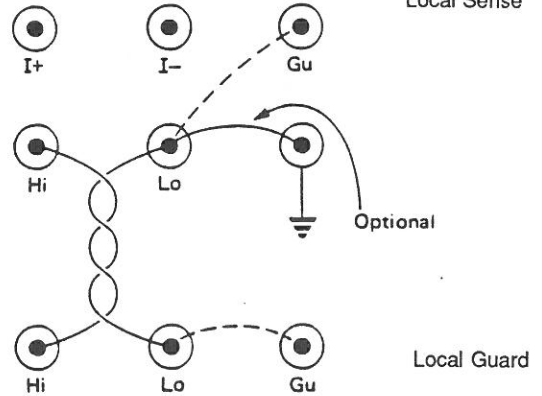

Load
Terminals

On 100V/1000V Ranges, Ground the Lo line for Safety.

Screened 2-wire Connection

Use where:

- Sensitive measurements are being made.
- The E-M environment is relatively 'noisy'.
- External common-mode voltages are significant.

Use for measurements in the following ranges:

- Voltage DCV $\geq 10\mu\text{V}$
ACV $> 90\mu\text{V}$
- Frequency $F \leq 1\text{MHz}$
- Resistance $1\text{k}\Omega \leq R < 1\text{M}\Omega$

After selecting Ω , Remote Sense must be cancelled for 2-wire operation.

Select Local Sense and Local Guard.

Keep leads as short as possible, (not longer than 1 meter).

4708
Terminals

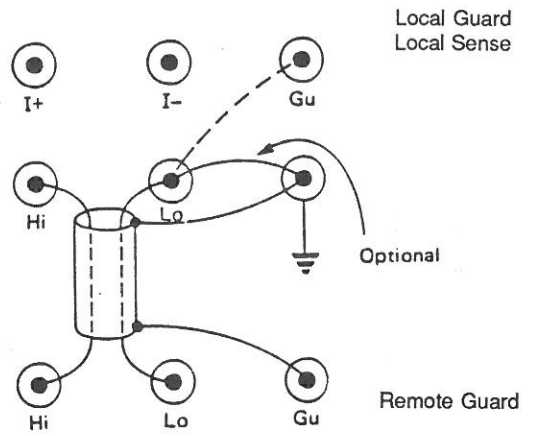

Load
Terminals

On 100V/1000V Ranges, Ground the Lo line for Safety.

Screened 4-wire Connection using Coaxial cable.

Use where:

- The load resistance is low enough to cause a significant voltage drop in the output connection.
- Sensitive measurements are being made.
- The E-M environment is relatively noisy.
- External common-mode voltages are significant.

Use for measurements in the following ranges:

- Voltage DCV $\geq 90\text{mV}$
ACV $\geq 90\text{mV}$
- Frequency $F \leq 1\text{MHz}$
- Resistance Not appropriate

Select Remote Sense and Local Guard.

Keep leads as short as possible, (not longer than 1 meter).

4708
Terminals

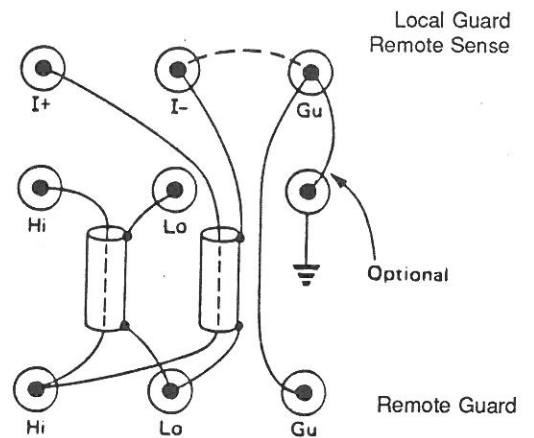

Load
Terminals

Typical Lead Connections

Voltage and Resistance Outputs

Screened 4-wire Connection.

Alternative using Twin-axial cable.

On 100V/1000V Ranges, Ground the Lo line for Safety.

4708
Terminals

Load
Terminals

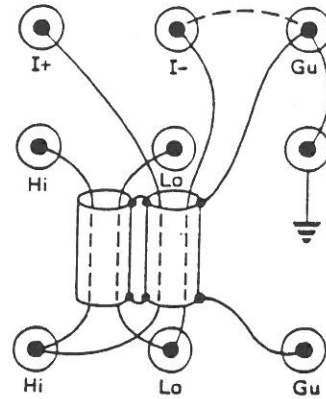

Current Outputs

Simple 2-wire Connection

Use for the majority of applications where:

The E-M environment is 'quiet'.

External common-mode is insignificant.

Use for measurements in the following ranges:

Current DCI > 1mA
ACI > 100mA

Frequency F < 5kHz

Local Sense selected automatically.

Select Local Guard.

Keep leads as short as possible, (not longer than 1 meter - twisted pair is preferable).

NOTE: Refer also to reactive load specifications in section 6.

4708
Terminals

Load
Terminals

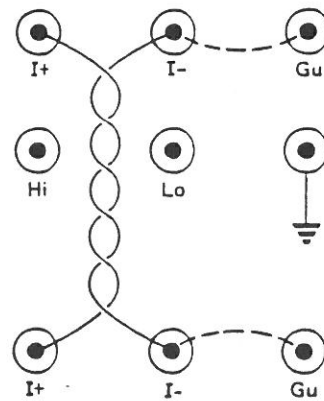

Local Guard

Local Guard

Screened 2-wire Connection

Use where:

Sensitive measurements are being made.

The E-M environment is relatively 'noisy'.

External common-mode is significant.

Use for measurements in the following ranges:

Current DCI > 9μA
ACI > 9μA

Frequency F < 5kHz

Local Sense selected automatically.

Select Local Guard.

Keep leads as short as possible, (not longer than 1 meter - Co-ax. or Twin-ax. is preferable).

4708
Terminals

Load
Terminals

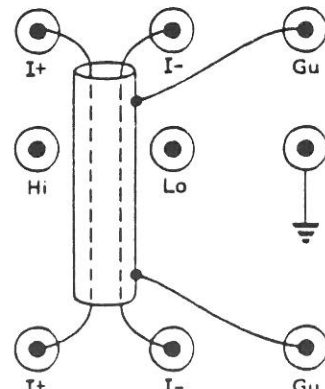

Local Guard

Remote Guard

General Sequence Of Operation

DANGER
VOLTAGE

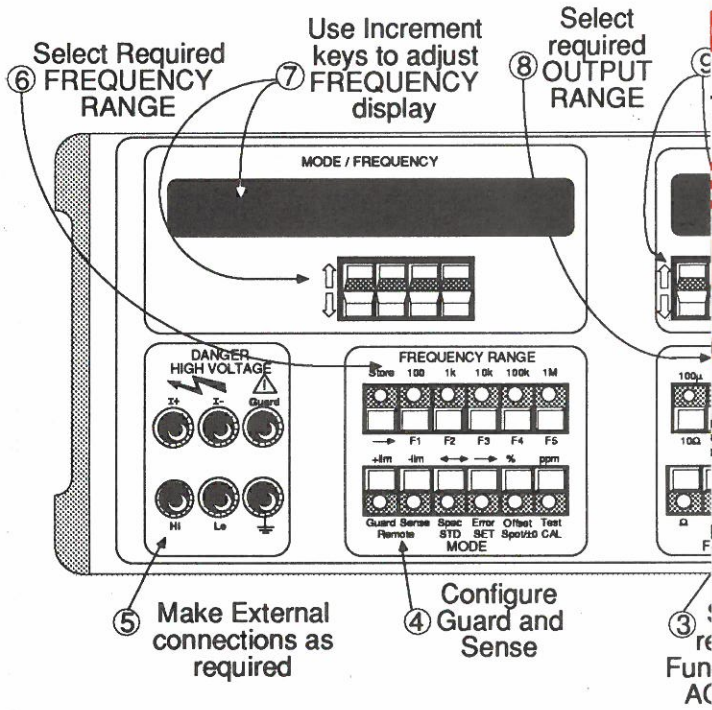

INSTRUMENT IS CAPABLE
OF DELIVERING
LETHAL ELECTRIC SHOCK !
as a high voltage source

FRONT or REAR terminals carry the Full Input Voltage

THIS CAN KILL !

Guard terminal is sensitive to over-voltage

It can damage your instrument !

that it is **safe** to do so,

DO NOT TOUCH
LEADS and terminals

DANGER

Display Messages

(See full list at end of this Section)

- Error 1 : Spec. mode - % : Uncertainty > 100%
- ±lim : Off-scale limit
- Error 2 : Cal. mode : Output not ON.
- Error 3 : Cal. mode : Incorrect range or function for mode.
- Error 4 : Cal. mode : Correction exceeds store capacity.
- Error 5 : Offset or Error Mode : Requested output would have been off-scale.
- Error 6 : Cal. mode : Resistance exceeded.
- Error 7 : 100V /1000V : Selected output exceeds voltage/frequency constraints.
- Error 8 : Select error : The operation requested by the user is not possible in present machine configuration.
- Error 9 : Option not fitted. : The requested range or function option is not fitted.

Operating Routines

The following operating routines are subdivided into two main types:

- Standard Operating Sequences
- Additional Facilities

Standard Operating Sequences

There are many common elements in the selection routines for both Voltage and Current operation. The diagram opposite shows the general sequence of operations. It should be used as the basis of any operating procedure, in conjunction with the individual selections detailed in the following pages.

DC Voltage Outputs

There are two overlapping voltage states. The 20V overlap allows $\pm 10\%$ adjustment about the typical full range value of 100V without changing state.

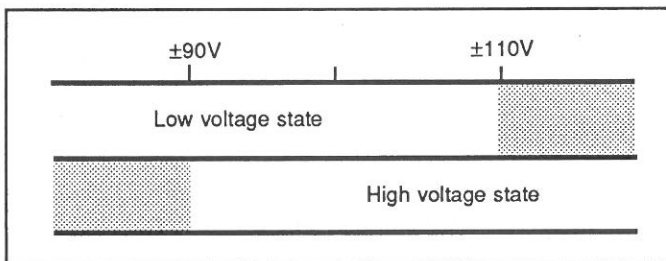

In the Low voltage state, the output may be switched ON directly but to transfer from Low to High Voltage state, deliberate user-actions are required.

N.B. The 4708 switches its output voltage OFF every time the 1000V RANGE is selected and when 1000V RANGE polarity is reversed.

Low Voltage selections (up to $\pm 110V$). Use the general sequence:

- At operation (3) : Select DC.
- At operation (4) and (5) : No Remote Sense on 100 μ ; 1m, 10m and 100m ranges.

High Voltage selections (above $\pm 110V$). Use the general sequence:

- At operation (3) : Select DC
- At operation (9) : RANGE LED flashes for selections above $\pm 110V$
- At operation (11) : Audible warning - 5 pulses/sec for 3 secs.
: After 3 second warning - 4708 switches OUTPUT ON.

Whilst OUTPUT ON - Audible reminder pulses at approx. 1 sec. intervals, and RANGE LED continues flashing. If OUTPUT OFF or ON switching is attempted during the 3 sec. delay the 4708 reverts to OUTPUT OFF.

Transfer into High Voltage State with OUTPUT ON.

By changing RANGE:

- the OUTPUT is switched OFF, and the selected RANGE LED flashes.

User reselects OUTPUT ON:

- 3 sec audible warning
- 4708 switches OUTPUT ON
- Audible reminder whilst OUTPUT ON
- RANGE LED flashing

By use of $\uparrow \downarrow$ keys in 100V or 1000V range:

- OUTPUT remains ON at previous voltage
- OUTPUT display shows selected (High Voltage) value
- RANGE and OUTPUT ON LEDs flash.

User reselects OUTPUT ON:

- 3 sec audible warning
- 4708 increases OUTPUT voltage to OUTPUT display value
- Audible reminder whilst in High Voltage state
- RANGE LED flashing
- OUTPUT ON LED lit continuously

Transfer out of High Voltage state with OUTPUT ON

By pressing OUTPUT OFF key:

ON+ or ON- LED remains lit until the OUTPUT Voltage has decayed into Low Voltage State (Approx. 1 sec from 1000V).

By use of $\uparrow \downarrow$ keys or by changing RANGE down:

Transfer to Low Voltage State is automatic when the OUTPUT Voltage falls below 90V.

- RANGE LED stops flashing - stays lit
- OUTPUT ON LED stays lit
- Audible reminder is silent

Changing voltage state when in Error or Offset Mode

For safety reasons, the thresholds are always defined with respect to voltage levels at the OUTPUT terminals. Therefore, if the instrument is in Error or Offset mode, the threshold indications may not coincide with 110V and 90V on the OUTPUT display.

AC Voltage Outputs

Zero Output

Zero AC Voltage output from the 4708 can be obtained only by pressing the Zero key. Internal relay contacts short I+ and I, and Hi to Lo.

Increment from Zero

The smallest AC output available on any range is 9% of full range, so any attempt to reduce the output below 9% is refused. Thus the smallest possible increment from Zero is to 10% of full range, using the appropriate key (any key to the right of this would attempt to increment to 1% or less, and be refused,

causing 'Error 8' and buzzer to sound). Half-size zeroes on the Zero display show which keys cannot be used to increment from Zero; full-size zeroes show those which can.

When the display is correctly incremented with OUTPUT ON, the output terminals are internally reconnected to the voltage output circuitry.

Zero Displays

Range	Zero Display
1mV	.000,0 mV
10mV	0.000,0 mV
100mV	00.000,0 mV
1V	.000,000 V
10V	0.000,00 V
100V	00.000,0 V
1000V	000.000 V

Output Voltage Selection

There are two overlapping AC voltage states. The 15V overlap allows some adjustment without changing state.

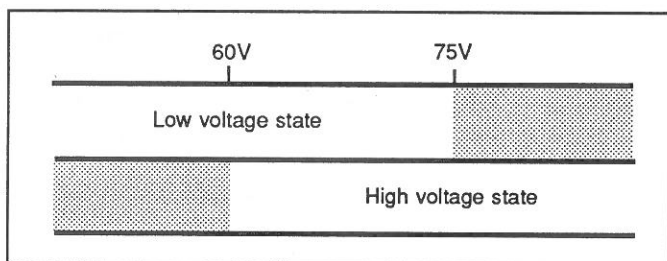

In the Low Voltage state, the output can be switched ON directly, but deliberate user-actions are required to transfer from Low to High Voltage state.

N.B. The 4708 switches its output voltage OFF each time the 1000V RANGE is selected.

Low Voltage Selections (up to 75V RMS).

Using the general sequence:

- At operation (3) : Select AC
- At operations (4) and (5) : No Remote Sense on 1m, 10m and 100m ranges.

High Voltage selections (above 75V RMS).

Using the general sequence:

- At operation (3) : Select AC
- At operation (9) : OUTPUT RANGE LED flashes for selections above 75V RMS.
- At operation (11) : Audible warning - 5 pulses/sec for 3 secs.
- After 3 sec. warning : 4708 sets OUTPUT ON.

While OUTPUT is ON : Audible reminder pulses continue at approx. 1 sec. intervals, and RANGE LED continues flashing.

If OUTPUT OFF OR ON switching is attempted during the 3 sec. delay the 4708 reverts to OUTPUT OFF.

OUTPUT ON Transfers

If OUTPUT is already switched ON in Low Voltage State when an attempt is made to select a voltage in excess of 75V RMS, the 4708 safety interlocks prevent the selection. Certain deliberate actions, detailed below, are then required by the operator to effect the selection.

Transfer from Low into High Voltage State, by manual upranging:

- 4708 switches OUTPUT OFF,
- Selected RANGE LED flashes,

Operator reselects OUTPUT ON:

- 3 sec audible warning
- 4708 switches OUTPUT ON
- Audible reminder while OUTPUT is ON
- RANGE LED continues flashing
- OUTPUT ON LED lit continuously.

Transfer from Low into High Voltage State, by incrementing the OUTPUT display:

- OUTPUT remains ON at previous voltage
- OUTPUT display shows selected value
- RANGE and OUTPUT ON LEDs flash.

Operator reselects OUTPUT ON:

- 3 sec audible warning
- 4708 increases output voltage to the OUTPUT display value
- Audible reminder while OUTPUT is ON
- RANGE LED flashing
- OUTPUT ON LED lit continuously.

Transfer from High into Low Voltage State, by pressing OUTPUT OFF key:

- ON LED remains lit until the output voltage has decayed (approx. 1 sec from 1kV).

Transfer from High into Low Voltage State, by decrementing the OUTPUT display, or by manual downranging:

- Transfer to Low Voltage State is automatic when the Output Voltage falls below 60V RMS.
- RANGE LED stops flashing - stays lit
- OUTPUT ON LED stays lit
- Audible reminder is silent

Changing Voltage State when in Error Mode

For safety reasons, the thresholds are always defined with respect to the voltage at the output terminals. When the instrument is in Error mode the displayed output voltage is modified by the gain error, so the threshold indications may not coincide exactly with 75V and 60V on the OUTPUT display.

Frequency Control

Refer to pages 3-6 to 3-8.

DC Current

Use the General Sequence:

- At operation (3) : Select DC followed by I
- At operations (4) and (5) : Remote Sense not available

N.B. Maximum compliance 3V on all ranges except with Model 4600 Transconductance Amplifier when compliance is limited to 2V.

AC Current

Zero Output

Zero AC Current output from the 4708 can be obtained by pressing the **Zero** key. This causes the internal software to isolate the **I+** and **I-** terminals from the internal circuitry, physically interrupting the Output Current.

Increment from Zero

The smallest AC output available on any range is 9% of full range, so any attempt to reduce the output below 9% is refused. Thus the smallest possible increment from Zero is to 10% of full range, using the appropriate key (any key to the right of this would attempt to increment to 1% or less, and be refused). Half-size zeroes on the Zero display show which keys cannot be used to increment from Zero; full-size zeroes show those which can.

When the display is correctly incremented with **OUTPUT ON**, the **I+** and **I-** terminals are internally reconnected to the Current output circuits.

Zero Displays

Range	Zero Display
100 μ A	00.00 0,0 μ A
1mA	000,000 mA
10mA	0.000,00 mA
100mA	00.000,0 mA
1A	.000,000 mA
10A	0.000,00 mA

Current Outputs

To generate AC output currents, use the General Sequence:

- At operation (3) : select AC followed by I
- At operations (4) and (5) : No Remote Sense

N.B. Maximum compliance 3V on all ranges except with Model 4600 Transconductance Amplifier when compliance is limited to 2V.

Changing functions switches OUTPUT OFF.

Resistance

Use the General Sequence:

- At operation (3) : Select Ω - **Remote Sense** LED lights as 4708 is forced into 4-wire

- At operation (4) : If 2-wire Ohms is required, press **Remote Sense** to deselect

- At operation (5) : 4-wire Ohms - use **I+** and **I-** terminals for energizing current.
Measure at **Hi** and **Lo** terminals.
2-wire Ohms - use **Hi** and **Lo** terminals (**I+** and **I-** terminals internally fused at 1.0A, **Hi** and **Lo** terminals fused at 3.75mA; on Ω function).

- At operation (8) : **RANGE** key value is **nominal**.
OUTPUT display value is as previously calibrated (At Full Range only, for 4-wire; at Full Range and Zero for 2-wire).

- At operation (9) : Left hand (overrange) pair of $\uparrow \downarrow$ keys have the same functions as **Full Range/Zero** keys.
The other $\uparrow \downarrow$ keys are inoperative except in Calibration function (See Section 8).

Additional Facilities

Frequency Store

Store Key

This key controls the storage and recall of five user-selected frequencies. The memories are volatile in that their contents are lost when the 4708 is powered-down. At power-up, the following five decade frequencies are stored automatically.

F1	30Hz
F2	300Hz
F3	3kHz
F4	30kHz
F5	300kHz

ACCESS TO STORED FREQUENCIES

Recall a Stored Frequency

To set the 4708 to one of the five stored frequencies, simply:

Press and release the **Store** key

- Its green LED lights

Press and release the desired **F1-F5** key

- Its LED lights
- The Store LED remains lit
- The stored frequency is presented on the **FREQUENCY** display, accompanied by its store location (see illustration page 4-10).

Recall from a Different Memory

To switch to a different stored frequency:

Press and release the desired **F1-F5** key.

- The displayed indications change as appropriate.

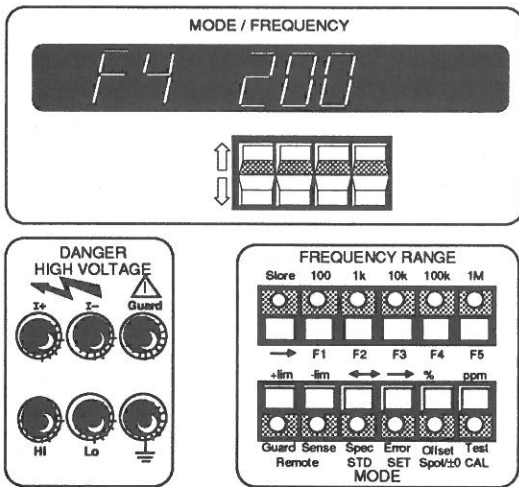

4708 Frequency selection panel

Deselect Store

To revert to normal frequency facility:

Press the **Store** key again

- Its LED goes out
- The F1-F5 LED goes out
- The stored frequency remains unchanged

Re-program a Frequency Memory Store

To change the Frequency of a Memory Store, the following procedure stores any displayable frequency in any of the five locations:

Select the required **FREQUENCY RANGE**.

Use the **FREQUENCY** display $\uparrow \downarrow$ keys to set the new frequency on display.

Press and hold the **Store** key

- Its green LED lights

Press and release the desired **F1-F5** key

- Its LED lights
- The store location is also present on the display

Release the **Store** key

- Its LED remains lit

If desired, deselect Store as above

STORE KEY - SUMMARY

Press and Release: Access F1-F5 for stored frequency retrieval.

Press and Hold: Allows displayed frequency to be stored in F1-F5 memories

Spot Frequency

This facility exists to provide rapid access to five user-selected spot calibrated frequencies on each output Voltage and Current range. As there are seven Voltage ranges, and five Current ranges, this makes a total of sixty spots in all.

Selecting a new **OUTPUT RANGE** also calls up its five spot frequencies, ready for selection.

The 4708 output can be calibrated at each spot frequency, thus achieving ultra-high accuracy by eliminating the 'Flatness' component.

By using non-volatile memory, these frequencies and their associated calibration constants are retained in store, even when the 4708 is powered-down.

In order to change the frequency setting of a spot and recalibrate at the new frequency, it is necessary to enter 'cal' mode (with the rear panel **CALIBRATION** key-switch set to 'ENABLE').

The output level span available for calibration of Spot frequencies is restricted to within 10% of nominal full range.

The calibration procedure is described, together with the other routine calibrations, in Section 8.

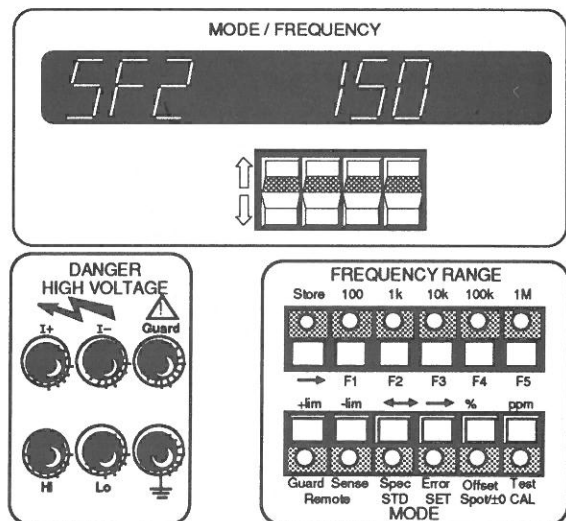

4708 Frequency control panel when used for the manipulation of spot frequency

Spot key

This reassigns the use of the **F1-F5** keys, to provide read-access to the non-volatile memory.

Recall

To set the 4708 to one of the existing spot frequencies, with output as previously calibrated, simply:

Press and release the **Spot** key

- Its LED lights
- The **Store** LED lights

Press and release the desired **F1-F5** key

- Its LED lights
- The **Store** and **Spot** LEDs remain lit
- The spot frequency is presented on the **FREQUENCY** display, accompanied by its store location (see illustration).

MODE/FREQUENCY $\uparrow \downarrow$ Keys

The terminal value is changed, without altering the OUTPUT display, by pressing the $\uparrow \downarrow$ keys beneath the MODE/FREQUENCY display. The gain compensation being applied is displayed as a percentage or ppm of the OUTPUT display value; with positive polarity for an increase of terminal value, and negative for a decrease.

The gain-compensation factor has a maximum possible resolution of $\pm 0.1\text{ppm}$ of Full Range (DCV).

Example of the use of "Error" mode

To measure the linearity of a DMM, a user needs to:

- Remove any zero offset.
- Detect and measure any inherent gain error ratio (usually from its response to a full range input).

Calculate compensating deviations for each of the inputs for the linearity measurement, based on the measured ratio,

and

Compensate each input to the DMM so that the linearity errors may be measured.

In "Error" mode, once the gain error has been measured, the 4708 automatically calculates and applies the compensating deviation to all its outputs on that range and function; whilst displaying both the nominal (uncompensated) value of output and the compensation ratio. Only if the DMM response is linear, will each DMM reading agree with the corresponding 4708 OUTPUT display value.

In the following sequence a DMM is checked for linearity. For purposes of explanation, it is assumed that linearity is correct, but the DMM has a gain error of +100.0 ppm.

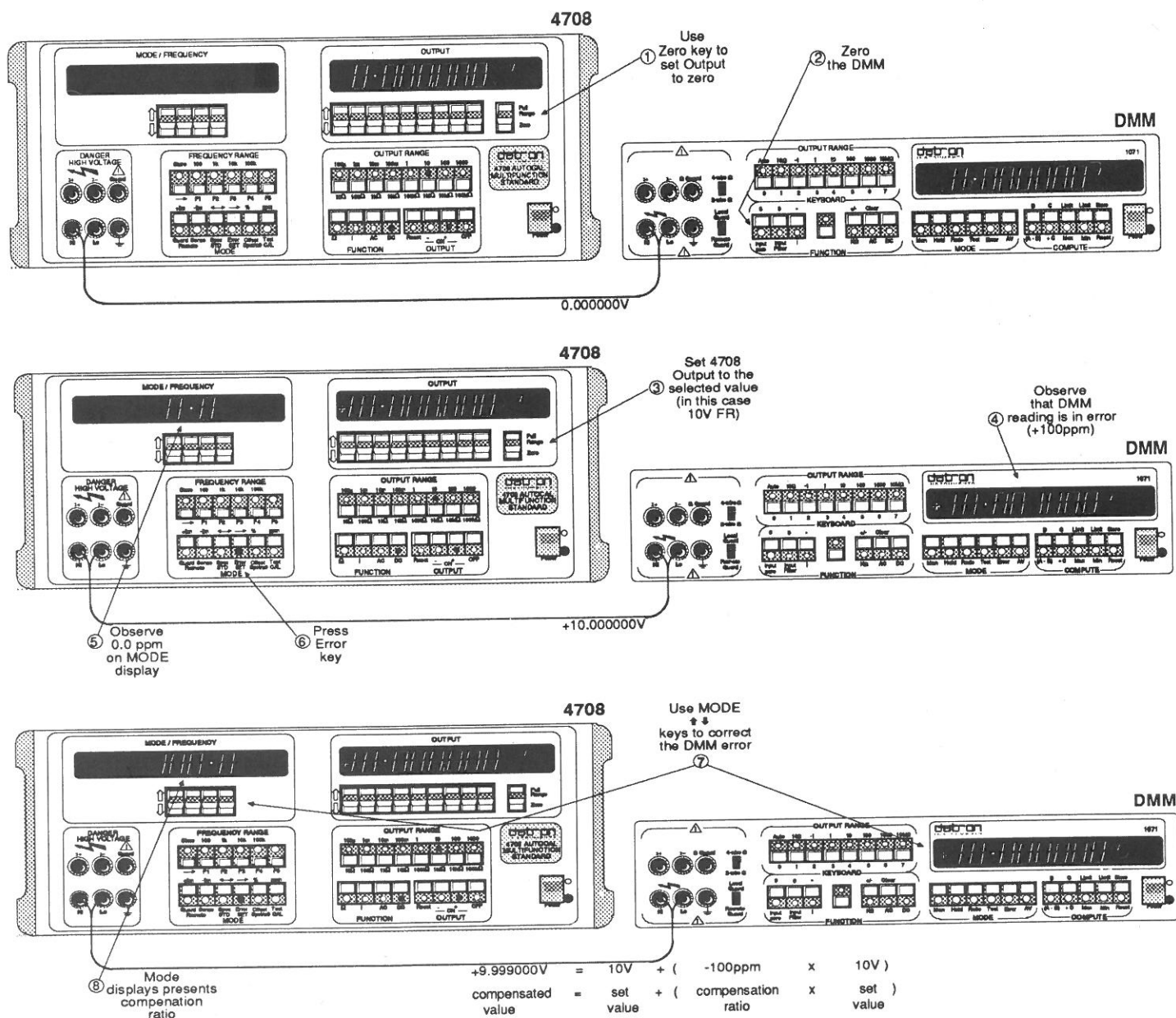

The 4708 output has now been compensated for the gain error of the DMM. All selected output values will be compensated in the same ratio on this range and function until either the ratio is changed or Error mode is selected. The Mode display presents the compensation ratio directly. Note that the compensation polarity is shown, not the error polarity, therefore the true output is the sum of both displayed values; in this case $+10.000000V - 100ppm = +9.999000V$.

The linearity of the DMM may now be checked by directly comparing its reading with the OUTPUT display settings.

e.g. at +5V on this range, both 4708 and DMM read +5.000000V, although the terminal voltages are +4.995000V.

Other linearity check values could be:

Nominal Check Point	4708 set Value	DMM Reading	Terminal Voltages
-0.5V	-0.500000V	-0.500000V	-0.499950V
+0.1V	+0.100000V	+0.100000V	+0.099990V
+0.01V	+0.010000V	+0.010000V	+0.009999V

Full Scale Limiting.

The OUTPUT display cannot be raised to a value which sets its overrange digit to greater than 1, and the Error MODE display cannot be raised about $\pm 9.9999\%$ ($\pm 999.9ppm$).

Nevertheless, a combination of OUTPUT display value and gain error could result in an off-scale value. The 4708 prevents this by rejecting any demand for an error-corrected Output Voltage in excess of full scale. The user is informed by Error

5 message on the MODE display with no change to the OUTPUT display.

Deselection of Error Mode

Deselection clears the MODE display, turns the green Error LED OFF and restores the 4708 gain factor to unity. Normally the mode is deselected by repressing the Error key, but it is also turned off by changing FUNCTION or RANGE.

'Offset' Mode (DC Functions only)

Offset key

A device being checked against the 4708 (say a DMM) may have an inherent zero offset error. Nevertheless, a user may wish to perform other measurements before removing the offset error. The 4708 'Offset' Mode is used for this purpose.

N.B. The MODE $\uparrow \downarrow$ keys have an automatic action: If a key is held pressed, the display will increment or decrement continuously until the key is released.

The value of output at the 4708 terminals is now the sum of the OUTPUT display value and the MODE display offset value.

The following example generates an offset of $-100\mu V$ on the 10V range of a DMM, for all set values (unless the 4708 would be driven off-scale).

Connect the DMM to the 4708, both set to 10V range, ensuring that 4708 Error and Offset LEDs are UNLIT.

Note that the negative polarity of the Offset value shown on the MODE display indicates that the Output voltage is more negative than the value on the OUTPUT display, i.e. the 4708 offset polarity is displayed, not the polarity of the DMM offset error.

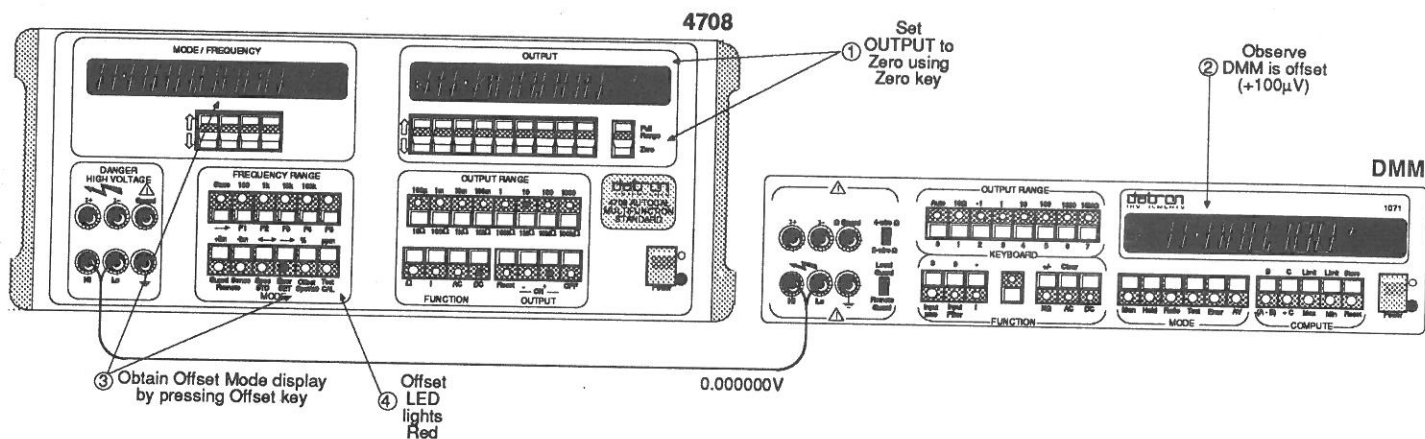

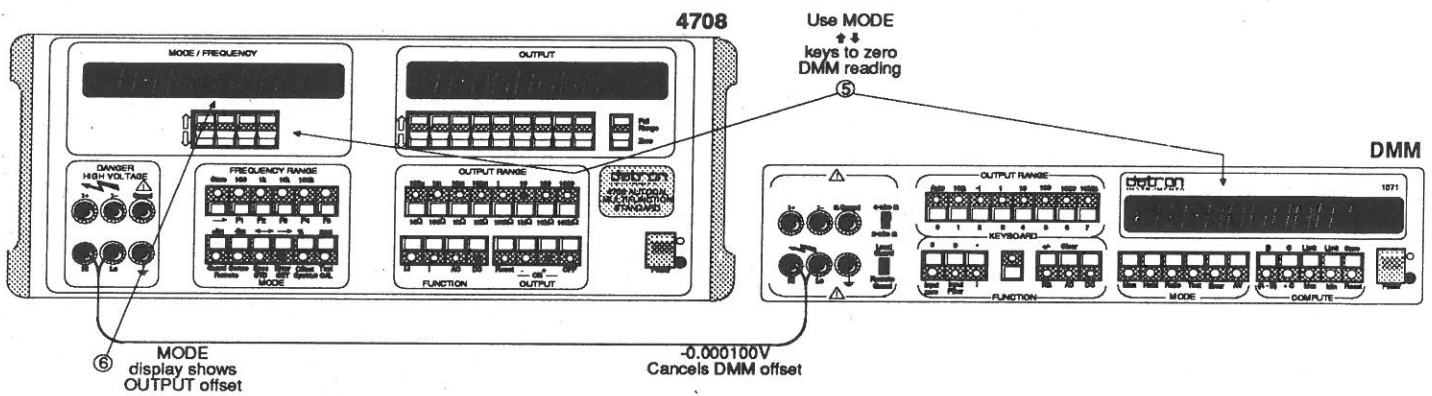

Now the DMM gain error may be measured

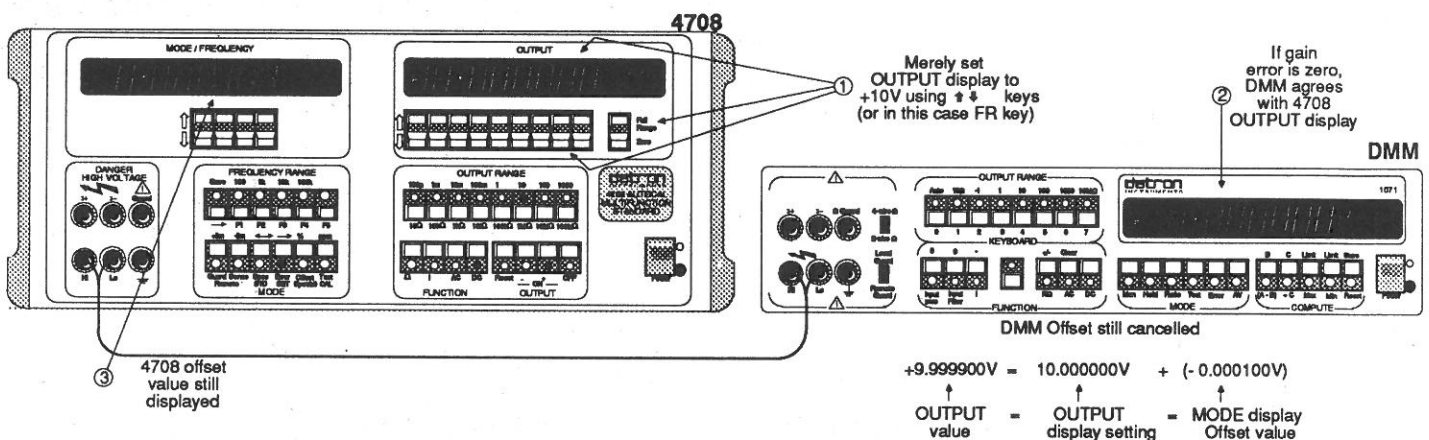

Full Scale Limiting.

The 4708 will reject any combination of set value and zero offset which would result in an off-scale output.

e.g. if -19.999950V is set together with -100 μ V offset, the user is requesting an offscale output of -20.000050V and the combination is invalid. The 4708 causes Error 5 to appear on the MODE display as a signal to the user, and continues to output its previous (valid) value.

The OUTPUT display cannot be set to a value greater than Full Scale. The Offset MODE display cannot be set to a value greater than the Offset span for the Range in use.

i.e. 100 μ V and 1mV Ranges: <200 μ V
Other Ranges: <2% of Full Range value

Deselection of Offset Mode

This clears the MODE display, turns the red Offset LED OFF and reduces the 4708 offset to zero. Normally the mode is deselected by repressing the Offset key, but it is also turned off by changing FUNCTION or RANGE.

Combining Offset and Error Modes (DC Functions only)

By combining Offset and Error modes it is possible to carry out a rapid analysis of a measuring instrument's linearity (e.g. for a DMM or A-D converter) without the need to correct its zero offset and gain errors.

This is done by using Offset Mode to compensate the 4708 output for the DMM's zero offset, and then using Error Mode to compensate for the DMM's gain error with the offset compensation still present.

In this condition, any residual deviations in DMM readings from the 4708 OUTPUT display settings represent non-linearities which would still be present if the DMM were corrected for offset and gain errors.

This facility also permits a user to quantify the linear response of the instrument to its input values in the form $y = mx + c$

in which y = instrument reading
 x = input value
 m = gain ratio
 c = zero offset value

e.g. for a DMM on its 10V range:

if $y = 9.999956x - 0.000084$,
then the DMM needs a gain compensation of +4.4ppm and a zero offset compensation of +84 μ V

These compensation figures can be read directly from the 4708 MODE display, during the following procedure.

Combination procedure (See Note below)

1. Use Offset-mode to compensate for input offset error and record the 4708 MODE display value at operation 6 \Rightarrow (γ) on page 4-15.
2. With Offset LED still lit, press Error key. Use Error mode to compensate for the instrument's gain error and record the 4708 MODE display value (ppm or %) at operation 8 \Rightarrow (μ) on page 4-13.
3. Use suitable values of **OUTPUT display** setting to check the linearity of the instrument under test. If the instrument has perfect linear response, then its readings will agree with those of the 4708 **OUTPUT display** and its linear transfer function is:

either: Instrument reading

$$= \left[1 - \frac{\mu \text{ (in ppm)}}{10^6} \right] \times \text{Input value} - \gamma \equiv y = mx + c$$

or:

$$= \left[1 - \frac{\mu \text{ (in \%)}}{100} \right] \times \text{Input value} - \gamma \equiv y = mx + c$$

4. Deselect in reverse sequence.

NOTE: For these equations to be varied, the procedure must follow the above sequence. Therefore the 4708 has been designed to inhibit any other sequence.

i.e. Offset mode cannot be selected or deselected when the Error LED is lit, and the Offset key operates in its secondary function of '%'.

Test Key

Tests available

There are two stages of 'Test' mode. The first stage, Safety and Memory checks, cannot be omitted from any 'Test' sequence.

Safety and Memory Checks

On first pressing the Test key, the 4708 carries out three checks:

1. Operation of the Safety trip, buzzer and reset circuitry.
2. Calibration Memory integrity.

3. Over-voltage check. (High voltage when not in HV state).

Messages appear on the **MODE display**, and completion is signalled by the **Test LED** going **OFF**. The second stage **Display and Key checks** may be omitted by pressing any key **other than Test**.

Display and Key Checks

If the **Test Key** is repressed before pressing any other **Key**, a visual sequence tests the front panel:

1. Gas discharge displays.
2. Key LEDs.
3. Key contacts (user-selected).

The 4708 remains in the key-contact mode until the **Zero Key** is pressed or test is deselected. It may then be used normally.

- N.B.
1. At any time during the second stage, the **Test** sequence may be aborted by pressing **Test Key** again.
 2. During self-test the instrument reset facility is not available.

Test Sequence

The **Front** or **Rear panel** terminals are not energized during **Test** sequence.

Safety and Memory Checks

1. Initial Conditions

Ensure that **OUTPUT OFF LED** is lit, **Error** and **Spec** LEDs are unlit. Check that **Test LED** is unlit.

2. Press Test Key:

Test LED lights as the checks begin.

3. Safety Trip Check

The 4708 tests the safety trip circuits. The **SAFETY** message appears on the **MODE display** and the buzzer will sound continuously when the trips have operated, and the **Reset LED** flashes.

4. Reset Check

The program ensures that user tests the **Reset** action.

Press **Reset Key**:

The **SAFETY** message is replaced by the **running** message and the buzzer stops sounding. Relay operation can be heard during the automatic checks which follow.

5. Calibration Memory Check

This is a sum-check of the **Non-volatile RAM**. If the check fails, the Message **FAIL 6** appears, otherwise no message.

6. Over-Voltage Checks

The 4708 automatically tests the over-voltage detector threshold levels in Low Voltage state.

If the check fails, the message **Fail 2** appears, otherwise **PASS** message indicates both tests completed successfully.

7. The Test LED goes OFF.

The following table summarizes the MODE display messages:

Message	Reason
SAFETy running	First stage of 'test' operative
PASS	No failure discovered.
FAIL 6 only	Parity error in Calibration Memory Check.
FAIL 2 only	High voltage can be present in Low Voltage state.

Any combination of these two **FAIL** messages can appear in sequence, replacing the **running** message.

8. To terminate Test before the Display and Key checks, press any key other than Test: **4708 returns to prior conditions.**

Display and Key Checks

Visual Check Sequence

Read this Note before pressing Test Key to start.

- NOTE: After pressing Test Key, the Visual Check sequence commences. During this sequence observe that:
- No display segments or blocks are missing or incomplete.
 - Segments and blocks do not appear spuriously.
 - Inter-digit and inter-segment 'streaming' does not occur.
 - All LEDs are lit in their correct sequence.
 - LEDs are not lit spuriously.

- Press Test key
 - Test LED lights
 - All other LEDs unlit
 - Displays cleared momentarily.

then:

- MODE** Display
 - Initial presentation:

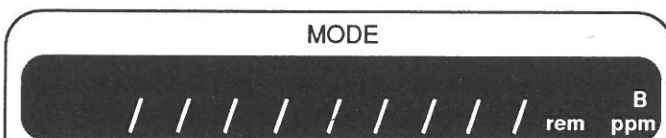

- Nine segments and legends are presented.
 (b) Progressively, all seven-segment digits and legends

are displayed segment by segment.

N.B. Commas are presented in the **MODE** display sequence.

- MODE** display cleared.

3. OUTPUT display

- Initial presentation:

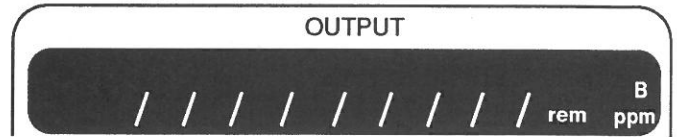

Nine segments and legends are presented.

(b) Progressively, all seven-segment digits and legends are displayed segment by segment.

(c) Final presentation: Nine commas are displayed on **OUTPUT** display then all 18 commas are displayed on **OUTPUT** and **MODE** displays.

- OUTPUT** and **MODE** displays cleared.

4. MODE Display

- Initial presentation:

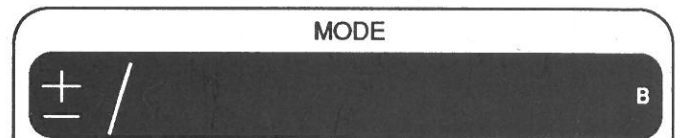

Polarity signs and overrange digit displayed.

(b) Progressively, seven-segment digits are presented digit by digit.

- Final presentation.

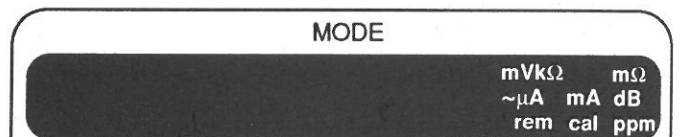

First, then second blocks of legends are displayed.

- MODE** display cleared.

- OUTPUT** display digits are presented next, in the same order as for the **MODE** display.

6. LED Check sequence commences:

(a) **Test** LED stays on, and other key LEDs are lit in Left to Right sequence starting at 100μ key and ending at **OFF**.

- MODE** display.

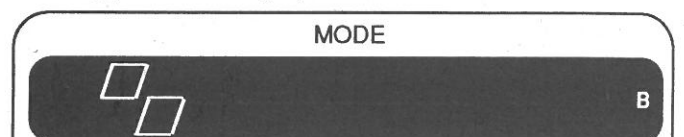

Symbol shown indicates that the keys are ready to be checked.

7. Key Checks

N.B. The Zero key should not be pressed until it is desired to terminate the Test Sequence.

(a) ↑ ↓ Keys

Each ↑ key should light the upper half of the digit immediately above it.

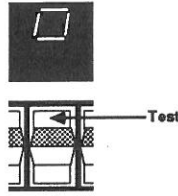

OUTPUT Display overrange digit ↑ key.

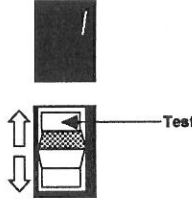

Each ↓ key should light the lower half of the digit immediately above it.

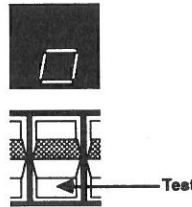

OUTPUT Display overrange digit ↓ key.

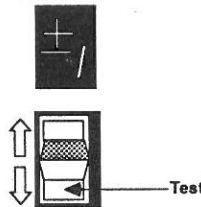

(b) **FREQUENCY RANGE, MODE, OUTPUT RANGE, FUNCTION** and **OUTPUT** keys should cause their LEDs to light, except:

- (i) **Reset** key, which is inoperative,
- and (ii) **Test** key, which aborts the test.

In these tests the key-press operates a latch so that the display or LED remains lit until another key is pressed. Only one key-press at a time is recognized.

(c) To Terminate the Test Sequence:

- Press Zero key to check its operation.
- 4708 reverts to initial conditions.
- Test LED goes OFF

(d) Operate 4708 normally.

Warnings and Messages

High Pitch Audible Warning

- (a) Sounds at approx 5 pulses per second during the 3 second delay between selection of **OUTPUT ON** and the High Voltage being connected to the terminals, when the **OUTPUT TERMINAL VOLTAGE WILL EXCEED 110V DC or 75V RMS AC**.
- (b) Sounds at approx 1 second intervals with **OUTPUT ON** in **High Voltage State**.
- (c) Sounds for 1 second with blank **FREQUENCY** display when frequency auto-ranges up or down.
- (d) Sounds continuously when **SAFETy** message is present on **MODE** display during self test.

Low Pitch Audible Warning

- (a) Sounds when any message is displayed on the **MODE/FREQUENCY** display (except recalled messages).
- (b) Sounds when any invalid bus command is received.

FREQUENCY/MODE display

Error 1	- Spec Mode: [%] :[+Lim, -Lim]	- Tolerance exceeds 100%. - The selected limit is off-scale.
Error 2	- Calibrate Mode	- OUTPUT OFF.
Error 3	- Calibrate Mode	- Incorrect FUNCTION, OUTPUT or FREQUENCY RANGE for this calibration mode.
Error 4	- Calibrate Mode	- Correction out of limits.
Error 5	- Offset or Error Mode	- Temporary message. The selected deviation would exceed the full scale value. Activation has been prevented.
Error 6	- Calibrate Mode (Resistance)	- The resistance value selected exceeds the calibration value.
Error 7	- 100V and 1000V Ranges	- Temporary message. The selected Voltage and Frequency exceeds the 4708 internal constraints. Activation has been prevented.
Error 8	- Selection error	- Temporary message. The operation requested by the user is not possible in present machine configuration.
Error 9	- Option not fitted	- Temporary message. The requested range or function option is not fitted.
Error EF	- External frequency	- The external frequency is not present, machine will perform out of specification.
Error OL	- Voltage Ranges - Current Ranges	- The output has been current-limited by an overload. (If in 100V or 1000V range, OUTPUT is automatically switched OFF). - The terminal voltage has been compliance-limited to 3V. (Load impedance too high).
FAIL 1	- Excessive internal temperature.	FAIL 7 - 400V power supply fault - this 'trip' may reset itself if no hardware fault exists and the Fail message is temporary.
FAIL 2	- Over-voltage	FAIL 8 - 38V power supply fault
FAIL 3	- Control data corrupted	FAIL 9 - 15V in-guard power supply fault
FAIL 4	- Precision divider fault	FAIL 10 - Model 4600 communication fault
FAIL 5	- Safety circuits tripped	
FAIL 6	- Calibration memory sumcheck non-parity	

SAFETy	- Test Mode	- Safety circuits tested by tripping: Press Reset key to continue test.
running	- Test Mode	- Indicates test in progress.
PASS	- Test Mode	- FAIL 6 did not occur during test of calibration memory parity, and FAIL 2 did not occur during test of over-voltage thresholds.

Recalled Messages

- ISS XX.XX - Firmware issue number (selected by pressing **Error** then **-Lim**).
- Addr XX - IEEE 488 Bus address as set on Address switch (selected by pressing **Error** then **+Lim**).

Processor 'Busy' (Keyboard Unreceptive)

The 4708 will not respond to commands while legend 'B' is present on the **MODE** and **OUTPUT** displays except to override during safety delay.

KEY LEDs

Basic Indications:

- Lit** - The labelled facility is selected and active.
- Unlit** - The labelled facility is not selected.
- Lit Green (Spec and Error only)** - Other **MODE** keys' facilities are reassigned to the secondary modes printed **ABOVE** their keys, as directed by the arrows.
- Lit Green (Store only)** - **FREQUENCY RANGE** keys are reassigned to select **F1-F5** memory stores.

Warnings with Function DC or AC Selected:

OUTPUT RANGE 100V or 1000V LED flashing

- A voltage in excess of **110V DC** or **75V RMS AC** has been selected (**OUTPUT ON** or **OFF**).

ON LED flashing while in Low Voltage State with OUTPUT ON

- An attempt to select output in excess of **110V DC** or **75V RMS AC** has been prevented.
- Repressing **OUTPUT ON** key will switch the **HIGH VOLTAGE ON**.



DANGER

HIGH VOLTAGE



**THIS INSTRUMENT IS CAPABLE
OF DELIVERING
A LETHAL ELECTRIC SHOCK !**
when connected to a high voltage source

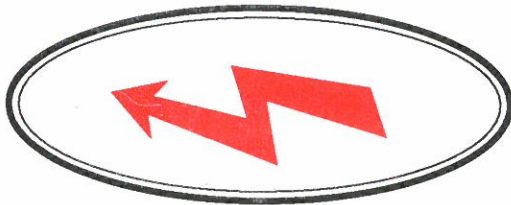

FRONT or REAR terminals
carry the Full Input Voltage

THIS CAN KILL !



Guard terminal is sensitive to
over-voltage

**It can damage your
instrument !**

Unless **you** are **sure** that it is **safe** to do so,
DO NOT TOUCH
the **I+ I- Hi** or **Lo leads** and **terminals**

DANGER

SECTION 5 SYSTEMS APPLICATION VIA THE IEEE 488 INTERFACE

Introduction

Section 5 gives the information necessary to put the 4708 into operation on the IEEE 488 bus. As some operators will be first time users of the bus, the text is pitched at an introductory level. For more detailed information, refer to the standard specification, which appears in the publication ANSI/IEEE Std. 488-1978.

Section Contents

The section is divided so as to group certain types of information together. These divisions are:

Interface Capability - the permitted options which have been implemented in the 4708.

Typical System - a brief view of a typical process using the 4708 to check a DMM calibration.

Using the 4708 in a System - implications of bus operation.

Programming Instructions - how the 4708 facilities have been transferred into remote commands.

Programming of Operational Functions - more detail about the codes which control 4708 operation.

Programming of Bus Transmissions - how to program the 4708 to obtain specific types of readout.

Service Request - why the 4708 needs the controller's attention and how it gets it.

Activation of Commands - what the 4708 does with the commands it receives.

Operational Sequence Guidelines - a little general help with programming sequences.

INTERFACE CAPABILITY

IEEE Standard 488

The 4708 conforms to the Standard specification IEEE 488-1978 - 'IEEE Standard Digital Interface for Programmable Instrumentation'.

It can be connected to the IEEE 488 Interface Bus and set into programmed communication with other bus-connected devices under the direction of a system controller.

Programming Options

The instrument can be programmed via the IEEE Interface, to:

- (1) Change its operational state (Range, Function, Frequency, Mode, Output, etc.)
- (2) Transmit its own status data to other devices on the bus.
- (3) Request service from the system controller.

Capability Codes

To conform to the standard specification, it is not essential for a compatible device to encompass the full range of bus capabilities.

The IEEE 488 document describes and codes each of the standard bus features, so that manufacturers can provide brief coded descriptions of their own interfaces' overall capability. A code string is often printed on the product itself.

The codes which apply to the 4708 are given in Table 5.1, together with short descriptions. They also appear on the rear of the instrument next to the interface connector.

Appendix C of the IEEE 488 document contains a fuller description of each code.

Code	Interface Function
SH1	Source Handshake Capability
AH1	Acceptor Handshake Capability
T6	Talker (basic talker, serial poll, unaddressed to talk if addressed to listen)
TEØ	No Address Extension Talker Mode
L4	Listener (basic listener, unaddressed to listen if addressed to talk)
LEØ	No Address Extension Listener Mode
SR1	Service Request Capability
RL2	Remote/Local Capability (without Local Lockout)
PPØ	No Parallel Poll Capability
DC1	Device Clear Capability
DTØ	No Device Trigger Capability
CØ	No Controller Capability
E1	Open-Collector Drivers

Table 5.1 IEEE Interface Capability

Bus Addresses

When an IEEE 488 system comprises several instruments, a unique 'Address' should be assigned to each to enable the controller to communicate with them individually.

One address is sufficient for a Datron instrument, as the controller can add information to it to define either 'talk' or 'listen'.

Interconnections

Instruments fitted with an IEEE 488 interface normally communicate through a set of interconnecting cables, specified in the IEEE 488-1978 Standard document.

The 4708 interface connector, J27, is fitted on its rear panel. It receives the specified connector, whose pin designations are also standardised and shown in Fig. 5.1 and Table 5.2.

Fig. 5.1 J27 Pin Layout

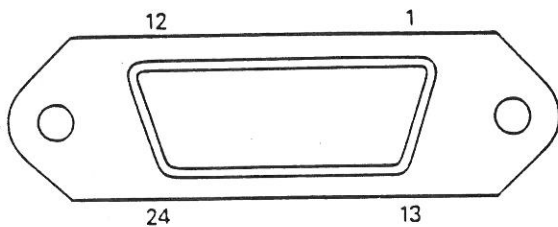

J27 Pin No.	Name	Description
1	DIO 1	Data Input Output Line 1
2	DIO 2	Data Input Output Line 2
3	DIO 3	Data Input Output Line 3
4	DIO 4	Data Input Output Line 4
5	EOI	End or Identify
6	DAV	Data Valid
7	NRFD	Not ready for Data
8	NDAC	Not Data Accepted
9	IFC	Interface Clear
10	SRQ	Service Request
11	ATN	Attention
12	SHIELD	Screening on cable (connected to Safety Ground)
13	DIO 5	Data Input Output Line 5
14	DIO 6	Data Input Output Line 6
15	DIO 7	Data Input Output Line 7
16	DIO 8	Data Input Output Line 8
17	REN	Remote Enable
18	GND 6	Gnd wire of twisted pair with DAV
19	GND 7	Gnd wire of twisted pair with NRFD
20	GND 8	Gnd wire of twisted pair with NDAC
21	GND 9	Gnd wire of twisted pair with IFC
22	GND 10	Gnd wire of twisted pair with SRQ
23	GND 11	Gnd wire of twisted pair with ATN
24	GND	4708 Logic Ground (Internally connected to 4708 Safety Ground)

Table 5.2 IEEE 488-1978 Connector - Pin Designations

Fig 5.2. Typical System

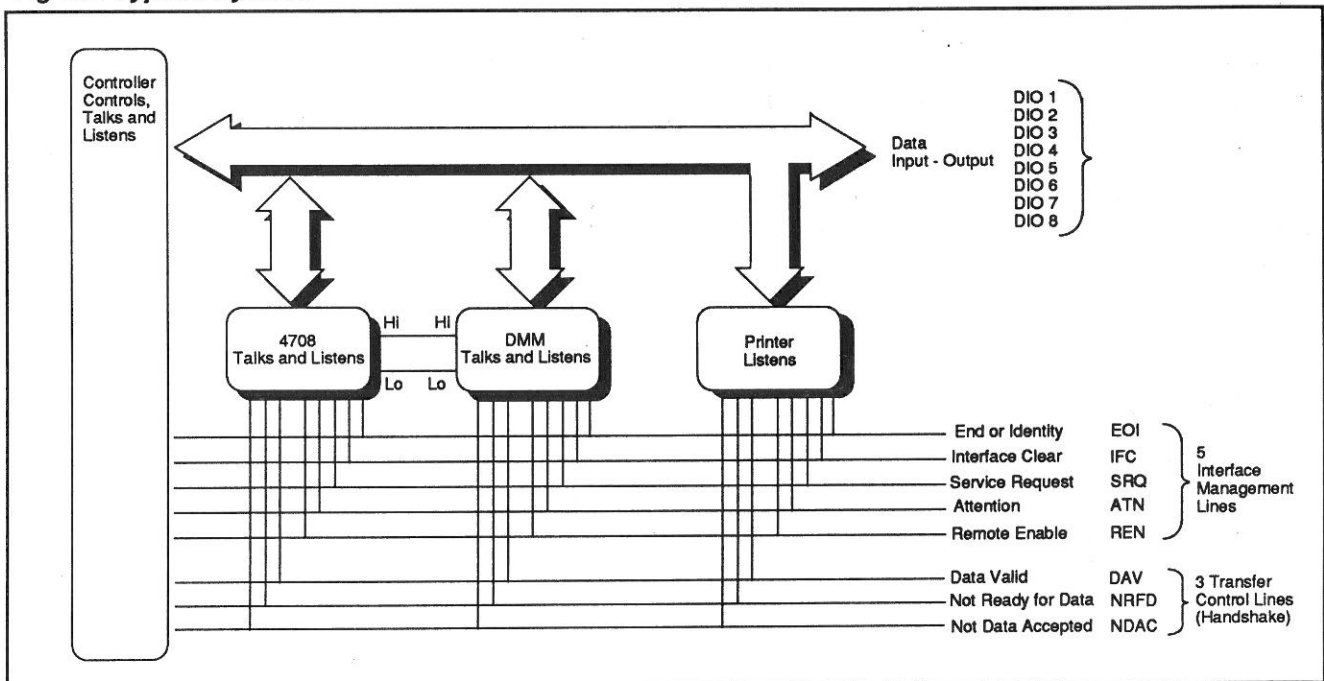

Typical System

A typical system is shown in Fig. 5.2. The system is directed by a controlling device able to:

- (a) **'Control'** (Issue commands)
- (b) **'Listen'** (Receive data)
- and (c) **'Talk'** (Transmit data)

EXAMPLE OF A SYSTEM IN OPERATION

In the system example (Fig. 5.2) the programme task could be to check the DMM calibration against the 4708, and print out the results. The following is a typical sequence of events:

- (1) The controller needs to instruct the 4708 to set its output to a calibration point for the DMM. These commands must not be received by the DMM or the printer and so the controller sends the general bus message **'Unlisten'**. When sending general messages, the controller makes all bus devices interpret any DIO-line data as configuration or data-flow commands, by holding the ATN line true.
- (2) The controller then sends the 4708 **listen** address to force it to receive, followed by 4708 configuration commands (including the **Output Disable** message, to prevent the DMM receiving an inappropriate analog input). The instructions are passed along the **DIO** (data input-output) lines as coded messages (bytes). The code is used in **ASCII** (American Std. Code for Information Interchange).
- (3) Although the 4708 accepts the instructions as they are passed, their implementation takes a short time. The controller would perform other tasks during this period. In the example, it would pass configuring commands to the DMM, after **'Unlisten'** and the DMM **listen** address have been sent.
- (4) The DMM also needs time to settle into stable operation, so the controller performs other tasks while waiting, such as configuring the printer.
- (5) The controller next generates **'Unlisten'**, addresses the 4708 as listener, and reconfigures its Analog Output On by an **Output Enable** message. If the 4708 has executed its previous instructions, it sets **OUTPUT ON** immediately, otherwise the **OUTPUT** is set **ON** as soon as they have been executed. In either case, the instrument sends a message back to the controller via the **SRQ** (Service Request) management line, if programmed to do so.
- (6) As the **SRQ** facility is available to all bus devices (**Wired-OR** function), the controller needs to discover which one sent the **'SRQ'**. It therefore asks all devices one by one (**'serial poll'**), finds out that the 4708 is the **SRQ** source and that its **OUTPUT** is **ON**.

- (7) It next addresses the DMM as a listener, and sends the **GET** message (Group Execute Trigger) via the **DIO** lines to initiate the reading. After a short delay for measurement, the DMM prepares output data and **SRQ**'s the controller when it is ready for transfer.
- (8) The controller identifies the DMM by a serial poll. Finding that the reading is available, it sends the DMM's talk address, and printer's listen address, to activate both devices.
- (9) The controller sets the **ATN** line false, thus releasing both devices to start the transfer. The DMM sends its data, byte by byte, via the **DIO** lines to the printer. This data must be in a form acceptable to the printer, and to ensure orderly transfer, each byte is transferred by **'Handshake'**, using the three Transfer-Control lines.
- (10) Usually the controller is also listening to this data transfer to determine when it is complete. As an aid to the controller and printer, the DMM can send another message with the last byte to be transferred (**EOI**-end or identify, using another bus management line).
- (11) The sequence is complete, and the controller can start again at another calibration point.

The controller holds the **REN** line true when taking remote control. It can send an addressed command **GTL**, or some controllers can set **REN** false, to permit temporary manual control of a device. The **IFC** line is used at the discretion of the controller, to clear any activity off the bus.

Sequences such as this are often assembled into programs to check DMMs at many calibration points; changing functions, ranges and output levels as designed by the user. The program would also include **'display'** messages to complete the printout in a recognizable form for the user's convenience. Programs must also cater for **FAIL** and **ERROR SRQs**.

Note that many of the individual steps detailed above will be transparent to the programmer. The level of transparency will be dependent on the controller. Refer to the relevant documentation for further information.

With a Datron Autocal DMM, other sequences can cause the DMM errors to be reduced until they are within specification, using its **'calibrate'** mode.

Using the 4708 in a System

ADDRESSING THE 4708

Bus Address

The instrument address is set manually using a six-way miniature switch near the interface connector on the rear panel. Five of the switches are used to set any address in the range 00 to 30, using a binary code.

e.g. Switch setting ; ADD 11010 = ADDRESS 26

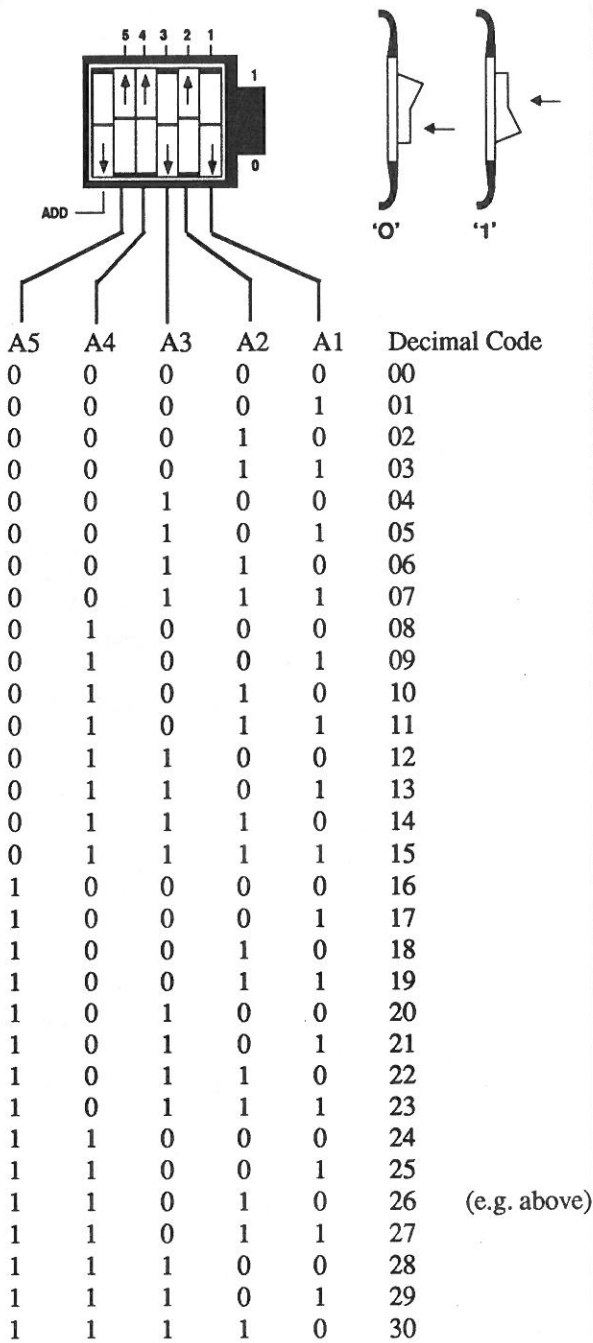

Table 5.3 Address Selection

'ADD'

The sixth switch is provided for possible future variants. In the 4708, the position of the ADD switch is immaterial, as the normal bus addresses can be selected at either setting.

Addresses 0-30

With an address selected in the range 0 to 30 the instrument may be controlled manually, or remotely as part of a system on the Bus. The address selected must be the same as that used in the controller program to activate the 4708.

N.B. The selected address can be temporarily displayed on the

front panel when in manual control, by touching Error and then Guard.

Remote Operation

When the 4708 is operating under the direction of the controller, the legend *rem* appears on the mode display, and all front panel controls are disabled except Power.

On entering, any earlier (manual) selection of Error mode is cancelled. During remote operation, the facilities of Error mode are excluded, as they can easily be programmed into the controller. Spec mode is also cancelled, but 'Spec' information can be obtained by bus command. There is no Spec mode display on the front panel during remote operation.

The 4708 power-up sequence is performed as for manual operation. After power-up, and on recovery from a power failure, the 4708 generates an SRQ and prepares an 'RQS Status Byte' for transmission to the controller as a response to its subsequent serial poll.

Calibration Enable

A 'Calibration Enable' command via the bus is required to set the instrument into its Remote Calibration mode (the CALIBRATIONENABLE keyswitch on the rear panel must already be set at ENABLE). Selection of any address 0-30 inhibits manual calibration from the front panel. In remote, calibration may be initiated with any address in range 0 - 30 selected.

Address 31 (illegal bus address)

This address configures manual operation only, inhibiting remote facilities. Address 31 must be selected (with CAL key set to ENABLE), for manual calibration to be carried out.

Temporary Transfer to Local Operation (GTL)

The 4708 can be programmed to switch into 'Local' operation (Command GTL), permitting a user to take manual control from the front panel. The system controller regains 'Remote' control by sending the following overriding commands:

LAD with REN True

The controller addresses the 4708 as a listener with the Remote Enable management line true (Low). This returns the 4708 from local to remote control. Any commands which had been sent during the period under local control will then be executed.

SDC

Specific 'Device Clear' commands are sent over the bus, returning the 4708 to a predetermined state (described later in this section).

Programming Instructions

Programming Strings

From the example given earlier in this section it is evident that the 4708 requires an address code followed by a series of device-dependent messages or commands to alter its configuration.

A series of these commands can be sent together as a 'program string', each programming instruction being position-dependent.

Each string will contain at least one programming instruction (detailed later in this section), but the 4708 must receive the string 'terminator' before it can activate any instructions. The required terminator for the 4708 is either the ASCII character '=' or EOI asserted coincident with the line feed character (decimal 10).

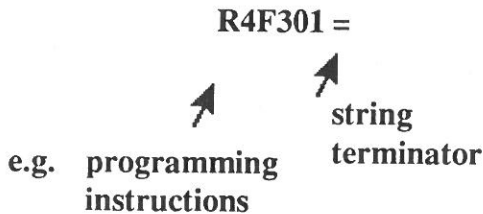

To assist in eliminating incorrect programming instructions, the 4708 checks for errors in the string, and generates a service request (SRQ) if a syntax error occurs or if an option is called for but not fitted. To ensure that the programming string does not set up a prohibited state, it also checks the whole string for validity. If it finds any errors in this phase, the whole command string is ignored.

For Example:

With the 4708 set in 10mV Range, a string is received which contains an unacceptable command to switch Sense connection ('S' command). The user needs to set up a completely new, valid string: so the whole string is discarded.

Device-dependent commands

To give maximum scope for system programming, the bus operation of the 4708 differs in detail from manual operation, which is organised for ease of front panel use. Some functions of the 4708 firmware are deleted for bus operation, as they are easily programmed into the system controller; and extra functions have been made available to take advantage of the controller's added computing power.

The following Alphabetic codes are used to establish the required functioning of the 4708 as a calibration source:

Full Range/Zero:	A
Safety Delay Override:	D
Output ON/OFF:	O
Function DCV, ACV, DCI, ACI, Ω:	F
Output Range in all Functions:	R
Output Value:	M
Frequency:	H
Spot Frequencies:	T
Sense:	S
Guard:	G
'Calibrate' trigger:	C
Calibration Mode Enable:	W

The following Alphabetic codes are used to select and configure the messages to be passed by the 4708 via the IEEE Bus:

User memory	I
Output string terminators:	K
Notation of output values:	L
Specification tolerances (relative: per unit):	P
Specification tolerances (absolute limits):	U
Recall/Verify (relative):	V
Service request origination:	Q
Diagnostic information:	X

Table 5.4 lists the range of device-dependent command codes available.

Fig. 5.3 summarises the way that front panel functions are transferred to system operation.

CONTROL	CODE	DESCRIPTION
Full Range/Zero	A0	Zero
	A1	+Full Range
	A2	-Full Range
Calibration Mode	C0	"CAL" (Calibration Trigger)
	C1	"SET"
	C3	"±0" (In DC)
	C4	"Precal" (In AC)
	C5	DC Coarse Linearity
Safety Delay	D0	Safety delay Active
	D1	Safety delay Over-Ridden
Function	F0	V (DC Voltage)
	F1	V~ (AC Voltage)
	F2	A (DC Current)
	F3	A~ (AC Current)
Guard	G0	Local Guard
	G1	Remote Guard
Frequency	H****	Numeric value of frequency
Memory (users Aide-Memoire)	I	Store next 16 ASCII Characters
Output String Terminators	K0	Cr followed by Lf with EOI
	K1	Cr followed by Lf
	K2	Cr with EOI
	K3	Cr
	K4	Lf with EOI
	K5	Lf
	K6	EOI with last character
Value Notation	L0	Scientific with legends
	L1	Scientific with no legends
	L2	Engineering with legends
	L3	Engineering with no legends
Main Register Value	M±***	Numeric value of 'Output' display
Output	O0	Output OFF
	O1	Output ON
Specification Tolerance	P0	24 hours
	P1	90 days
	P2	1 year
Service Request	Q0	SRQ on all specified states
	Q1	SRQ on Overload and Fail only
	Q2	No SRQs
Output Range	R0	Autorange
	R1	100μ
	R2	1m 100Ω
	R3	10m 100Ω
	R4	100m 1kΩ
	R5	1 10kΩ
	R6	10 100kΩ
	R7	100 1MΩ
	R8	1000 10MΩ
	R9	— 100MΩ
Sense	S0	Local Sense
	S1	Remote sense
Spot Frequencies	T0	Cancel Spot Frequency
	T1	SF1
	T2	SF2
	T3	SF3
	T4	SF4
	T5	SF5
Specification Tolerance (Absolute Limits of Uncertainty)	U0	24 hours
	U1	90 days
	U2	1 year
	U3	24 hours
	U4	90 days
U5	1 year	
Recall/Verify	V0	'OUTPUT' Value
	V1	'Frequency Setting'
	V2	4708 Status
	V3	Software Status (Part No/Issue)
	V4	F1
	V5	F2
	V6	F3
	V7	F4
V8	F5	
Calibration	W0	Calibration Mode Disable
	W1	Calibration Mode Enable
Diagnostic (The callstore values relate to the function set at the time) Refer to Calibration and Servicing Handbook for description of correct process	X0	Zero Cal Store
	X1	Gain Cal Store
	X2	STD Cal Gain Factor
	X3	Zero offset
	X4	Gain Offset
	X5	Linearity (not AC)
	X6	Reference Divider Setting
	X7	Not Used
X8	User Message Recall	

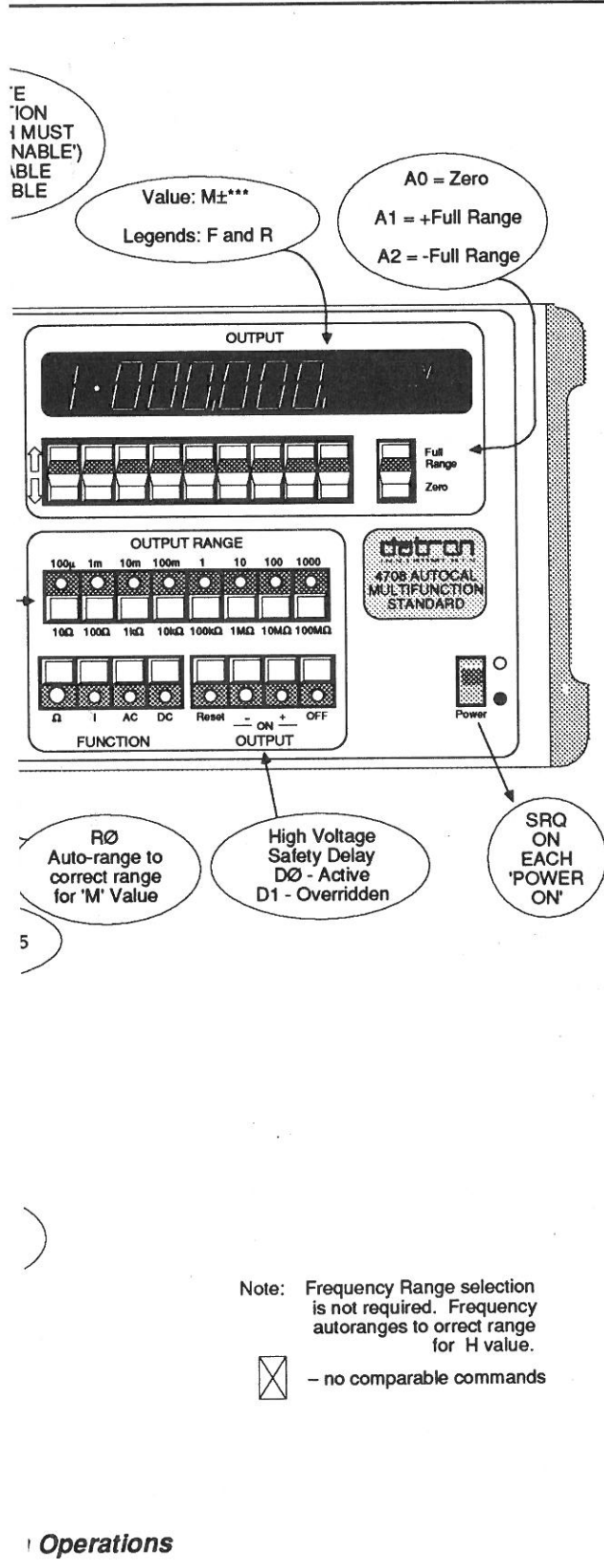
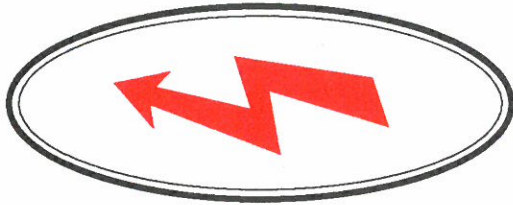

Table 5.4 4708 IEEE 488 Command Codes

Operations

DANGER HIGH VOLTAGE



FRONT or REAR terminals
carry the Full Input Voltage

THIS CAN KILL !

READ THIS: For manual operation, the 4708 High Voltage Interlocks ensure that users employ deliberate actions before voltages in excess of 100V DC or 75V RMS are generated at the output terminals.

In system applications, the same interlocks require the same deliberate commands to be received from the system controller. (But see Safety Delay Override command D1 in the text).

In manual operation the user who is exposed to danger from high voltage also has direct control of the 4708 output, but it is not possible to give the same degree of built-in protection to exposed users when the instrument is under remote programming, so it is **ESSENTIAL** that **WHENEVER THE 4708 IS BEING USED IN A SYSTEM TO GENERATE VOLTAGES IN EXCESS OF 75V, THERE MUST BE NO ACCESS TO THE 4708 FRONT PANEL OR REAR PANEL OUTPUT TERMINALS.**

Unless **you** are **sure** that it is **safe** to do so,
DO NOT TOUCH
the **I+ I- Hi** or **Lo leads** and **terminals**

DANGER

Programming of Operational Functions

OUTPUT ON/OFF

The analog OUTPUT is switched off by command 00 (output disable), and switched on to the selected value by 01. The amplitude and frequency of the output are derived from the 'M' code and 'H' code data used to set the 'Main' (OUTPUT display), and 'Auxiliary' (MODE/FREQUENCY display) registers.

Safety Delay

The High Voltage Safety delay (3 seconds) is normally active (D0). It can be overridden by the command D1, but the use of this command sets up potentially dangerous situations. D0 is enforced by any Function or Range change (including Autorange changes).

WARNING:

DO NOT USE D1 UNLESS IT IS ESSENTIAL FOR HIGH SPEED OPERATION. TAKE SAFETY PRECAUTIONS TO PROTECT PERSONNEL IN THE VICINITY.

Function

F0 (DC voltage), F1 (AC voltage), F2 (DC Current), F3 (AC Current) and F4 (Resistance) configure the instrument to the required function.

Output Range

R1 through to R9 configure the 4708 to specific ranges as shown earlier in Table 5.4. R0 puts the instrument in auto-range function, allowing the output value to be specified as a number without setting the actual range. Ranging down occurs at 20% of range, i.e. Full Scale value of next lower range. Ranging up occurs at Full Scale. In autorange, commands A0, A1 and A2 are invalid.

Output Display Value (Main Register)

In remote programming, the incremental $\uparrow\downarrow$ method of setting the output value is not used. Instead, Code M±*** is used to set the output value explicitly, either in numeric, scientific or

engineering notation (see examples below). If the resolution is too high, the value is truncated to the correct resolution and the controller is informed by SRQ and RQS Status byte (see RQS status byte formats later in this section).

High Voltage Outputs

The change from Low to High voltage state is controlled by the same interlocks which govern the manual changeover (Refer to Section 4, page 4-7). To effect the changeover, the command string:

'M (followed by voltage) 01 ='

should be used if OUTPUT is already on and a range change is not involved. If a range change is programmed to set the output into high voltage state (for instance in R0) the '01' should be sent as a separate string.

If the M code alone is attempted (M***...=) with OUTPUT already enabled (01), the new value is set in the Main Register (OUTPUT display); but the output voltage will not ramp to high voltage state until the enabling string '01 =' is received.

If the attempt had been made with OUTPUT disabled (00), the 01 would be required in any case.

It should also be remembered that the output circuitry needs time to settle to its final value, especially if a range-change is incurred. Delays should be included in the controller program to allow for this.

During these processes, the front panel warnings of flashing LEDs and pulsing tones operate as for manual operation. Nevertheless, access to the front panel should be restricted because the high speed of programming in the IEEE interface adds to the safety hazard.

Examples of valid M codes:

Required Output Value	Function	Range	M Code	Output Display
-153V	F0	R7	M-153	-153.000,0V
+1.621257V	F0	R5	M+1.6212574	+1.621,2574V
1.621257V RMS	F1	R5	M1621257E-6	1.621,257V ~
1.621257V RMS	F1	R0	M1621.257E-03	1.621,257V ~ (Autorange to R5 = 1V)
0.002563 RMS	F3	R0	M.002563	2.56300mA ~ (Autorange to R3 = 10mA)

Output Resolution

The output resolution conforms to the following number of digits:

Range	100μ	1m	10m	100m	1	10	100	1000	DCV, ACV DCI, ACI
	10	100	1k	10k	100k	1m	10m	100m	Ω
Range Code	R1	R2	R3	R4	R5	R6	R7	R8	
Functions:									
DC Voltage	FØ	4.5	5.5	6.5	7.5	7.5	7.5	7.5	7.5
AC Voltage	F1	-	4.5	5.5	6.5	6.5	6.5	6.5	6.5
DC Current	F2	6.5	6.5	6.5	6.5	6.5	-	-	-
AC Current	F3	6.5	6.5	6.5	6.5	6.5	-	-	-
Resistance and Local Sense	F4)) SØ)	4.5	5.5	6.5	7.5	7.5	7.5	7.5	7.5
Resistance and Remote Sense	F4)) S1)	7.5	7.5	7.5	7.5	7.5	7.5	7.5	7.5

Frequency Display Value (Auxiliary Register)

In remote programming, the incremental (↑↓) method of setting the frequency is not used. Instead, each auxiliary register value is input explicitly by Code **H****** in numeric, scientific or engineering notation.

The manual frequency 'Store' memories cannot be set via the bus, although their contents can be read using 'V' codes.

Frequency Resolution

Frequency is resolved to three significant digits (1% to 100ppm accuracy). On the display this occupies four digit spaces, to accommodate the decimal point. If the significance is greater than three digits, the value is truncated and the controller is informed by SRQ Status byte (see SRQ status byte formats later in this section).

Frequency and Voltage Constraints

On 100V and 1000V output ranges, the 4708 will refuse any command for an output which exceeds the limits defined on page 3-7. The controller is informed by 'Error 7' SRQ status byte (see SRQ status byte formats later in this section).

Spot Frequency Selection

Codes **T1-T5** select the spot frequencies stored in SF1-SF5 non-volatile memories. Sixty unique memory locations exist. Thirty five are allocated to the seven AC Voltage output ranges and twenty five to the five AC Current ranges: five for each range. The value of the frequency called up by any **T** command

is therefore dependent on the preselected **F** and **R** codes.

With spot active, sending a new **R** code selects the corresponding spot frequency in the new range. A new **F** code, sent to change function, cancels the **T** command: the 4708 frequency reverts to 1kHz.

The controller is able to command an uncalibrated spot. The 'uncalibrated' message is displayed as in manual operation, the 4708 frequency remaining as previously set. But in addition, the 4708 generates an SRQ to notify the controller. Code **TØ** cancels any earlier spot frequency selection: the 4708 frequency reverts to 1kHz.

N.B. The Spot Frequency facility is included to provide separate, ultra-accurately calibrated points in the 4708 output spectrum. Therefore, frequencies set into the 'spot frequency' memories can only be changed during the Autocal routine (See Section 8).

Guard and Sense

These are configured into Local or Remote by **G** or **S** codes respectively:

- GØ** - Local Guard
- G1** - Remote Guard
- SØ** - Local Sense (forced when F2 or F3 has been commanded and when F0, R1, R2, R3 and R4 or F1, R2, R3 and R4 have been commanded). Programs for 2-wire resistance in F4.
- S1** - Remote Sense (available only when F0 or F1 have been selected together with R5, R6, R7 and R8 or when F4 has been selected in all ranges). Programs for 4-wire resistance in F4.

These bus commands are subject to the constraints of the 4708 firmware. The instrument will reject and ignore invalid commands, such as **Remote Sense** when in **100mV** range.

Calibration Enable and Calibrate

(W and C codes)

These are available for automatic calibration of the 4708, under remote control via the IEEE bus. Refer to the Calibration and Servicing Handbook.

W0	-	Calibration disable	
W1	-	Calibration enable	
		(only if CALIBRATION ENABLE	
		keyswitch set to ENABLE).	
C0	-	Calibration Trigger -)
		equivalent to CAL key)
C1	-	As SET key) Refer to
C2	-	As STD key) Section 8.
C3	-	As ±0 key (in DC))

Programming of Bus Transmissions

Output String Formation

The 4708 can be commanded to output 'internal' information to the system via the IEEE-488 bus, by sending one of the specified 'recall' messages.

Only one recall command should be included in a terminated string.

As well as the information it contains, the string needs to be formatted correctly for acceptance by the system. Many variations of format are available; these can be programmed for the type of system in use.

The length and construction of the string both depend upon the type of information to be transmitted, and thus upon the codes used to program the 4708. The purpose of this explanation is to describe the effects of these codes on the output string format.

Figure 5.4 illustrates the construction of a typical string, such as the 4708 output value. Notice that numerical data is reduced to a standard form, and scaled by means of an exponent in base 10. All device dependent messages use the ASCII code.

Figure 5.4 Breakdown of a typical Output String
(This is a general example - two specific 4708 examples appears on page 5-12)

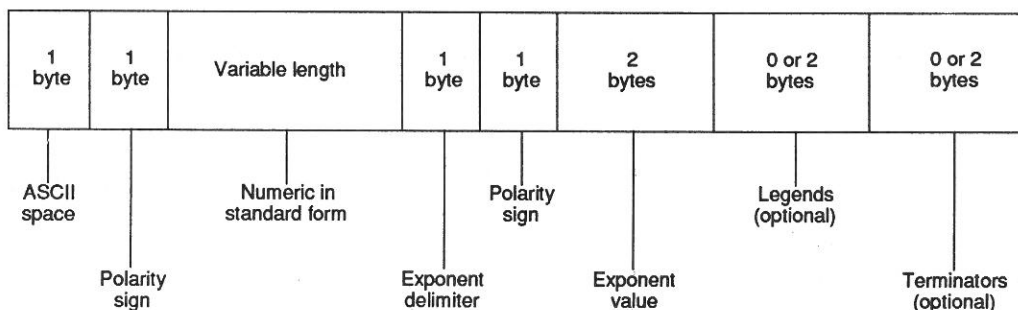

ASCII 'Space'

A format character to denote the beginning of an output string - not present for recall command **X8**.

Polarity Sign

Replaced by an ASCII space in AC Functions. For DC functions, the appropriate polarity sign is presented.

Numeric sub-string

Length depends on the resolution of the information to be transmitted, and form depends on the notation programmed by 'L' code.

Exponent delimiter 'E'

Signifies that the numeric has finished and the next three bytes form the exponent.

Exponent Value

The first of the three bytes is always '+' or '-'. Because the value is never greater than 9, the second byte is always 0, and the third is a single decimal digit.

Legends

Inclusion is optional, but if they are programmed in, two bytes are always present. The characters are appropriate to the programmed state of the 4708.

Terminators

Two terminating characters are available, as programmed by 'K' code. The EOI bus management line can optionally be programmed for simultaneous transmission with the last byte of the string.

Format Codes

The following pages list and describe the programming codes which determine the formation of the output string. The codes on this page select specific types of ASCII strings for retrieval.

Recall/Verify (code V)

By sending a V code the controller interrogates the 4708 to obtain information about its present status. Unless otherwise stated, the output strings are formatted as programmed by K and L codes. The V codes are as follows:

- V0 - The present Output value
- V1 - The present Frequency setting
- V2 - The present functional status.

The response to V2 is a standard ASCII string: (space R*F*O*G*S*W*Q*D*L*K terminator). The functions are represented by the same numerics as for programming. In addition, the Output Range is identified by a lower case 'r' if the 4708 is programmed in autorange.

- V3 - Software status

The software status is the part number and issue number of the internal program. This is formatted as follows, in response to command code V3:

(space 890077 - numeric terminator)

Part No. Issue No.

(This status report is also available manually by pressing Error key then Lim-. The firmware issue number is presented on the MODE display).

- V4-V8- 'Stored' Frequencies

Codes V4 to V8 recall each of the five frequencies held in volatile memory locations F1 to F5. These can only be set or selected manually. (Refer to pages 3-7 and 3-8).

The range of legends transmitted by the 4708 is listed under 'String Formatting Commands (K and L Codes)'.

I-code (Aide Memoire)

This allows the user to identify a specific calibrator with a designator up to 16 characters in length, stored in non-volatile memory. The 4708 must first be placed in the CAL mode by turning the CAL key to ENABLE and sending the W1 command. Sending the I command will store the subsequent 16 character string in memory. This string can be recalled using the X8 command.

N.B. The I-command and the W1 command must not be sent in the same string.

Specification Tolerance (Per unit - P codes)

The P commands give access to Spec mode over the bus, also setting the calibration interval:

P0 - 24 hour; P1 - 90 day; P2 - 1 year

On being commanded by P code, the 4708 calculates the Output Uncertainty of its current state (as a 'per unit' fraction of the output value) and generates an output string formatted by K and L codes. Legends are transmitted as pu (per unit).

Absolute Limits of Tolerance

In this case, the U commands cause the 4708 to calculate the high or low limit of uncertainty of its output value against the nominated calibration interval.

- U0 - Low limit 24 hour
- U1 - Low limit 90 day
- U2 - Low limit 1 year
- U3 - High limit 24 hour
- U4 - High limit 90 day
- U5 - High limit 1 year

On being commanded, the calculated value is output by the 4708 in an output string formatted by K and L codes.

Diagnostic Information

The X commands recall the contents of certain non-volatile calibration memory locations. The values recalled are calibration constants stored at the most recent Autocalibration. They are used in the computations which establish the 4708 output level, as corrections for long-term drift in the analog circuitry.

- X0 - Zero Cal. Store
- X1 - Gain Cal. Store in DC, LF gain + HF calibration in AC
- X2 - 'STD' calibration gain factor
- X3 - Zero offset)
- X4 - Gain error) factory established
- X5 - Linearity (not AC))
- X6 - Reference Divider setting
- X7 - Not used in 4708
- X8 - Recall message which was memorised earlier by the operator using Code I.

Activating the Recall Transmission

The 4708 assembles the appropriate output string in its output registers in response to the V, P, U or X command. It can subsequently be released onto the bus by addressing the 4708 as a talker.

String Formatting Commands (K and L Codes)

The output string can be formatted and terminated to adapt to user's requirements. Scientific or Engineering notation can be programmed, with or without descriptive legends. Two examples are given below.

Codes L0 to L3 configure the output string notation:

- L0 - Scientific notation with legends
- L1 - Scientific notation, no legends
- L2 - Engineering notation with legends
- L3 - Engineering notation, no legends

Two sorts of terminator are available:

- a. One or two bytes can be added to the end of the string. These contain either Carriage Return (Cr) or Line Feed (Lf); or both in the order: Cr followed by Lf.
- b. The EOI bus management line can be programmed to set true simultaneously with the last byte of the string. EOI can be used even if both Cr and Lf are suppressed.

The 4708 can also be programmed to transmit strings without terminators. To accommodate these variations, the system programmer uses the K codes:

- K0** - No suppression (Cr, Lf and EOI all present as terminators)
- K1** - Suppress EOI (Terminator Cr followed by Lf)
- K2** - Suppress Lf (Terminator Cr with EOI)
- K3** - Suppress Lf and EOI (Terminator Cr)
- K4** - Suppress Cr (Terminator Lf with EOI)
- K5** - Suppress Cr and EOI (Terminator Lf)
- K6** - Suppress Cr and Lf (Terminator EOI with last character)
- K7** - Suppress Cr, Lf and EOI (No terminators)

1. Scientific Notation (Codes L0 and L1).																		
Bytes -	1	2	3	4	5	6	7	8	9	10	11	12	13	14	15	16	17	18
	Sp	Sp +-	0/1	.	0-9	0-9	0-9	0-9	0-9	0-9	E	+/-	0	0-9	V A R	SpN	Cr	Lf
Two ASCII spaces or one space and polarity																		
Output Value Numeric: 0.000000 to 1.999999																		
Output Value Exponent: E± (0 to 9)																		
Legend(s): (In this case code L0 was programmed.)																		
Terminator(s): (Code K1 programmed)																		

1. Engineering Notation (Codes L2 and L3).															
Bytes -	1	2	3	4	5	6	7	8	9	10	11	12	13	14	
	Sp	Sp +-	0/1	0-9 / .	0-9 / .	0-9 / .	0-9	0-9	0-9	0-9	E	+/-	0	0 /3 /6	
Two ASCII spaces or one space and polarity														EOI	- EOI line set true with last byte
Output Value Numeric: 0.000000 to 199.9999															
Output Value Exponent: E± (10 10 10)															
Legend(s): (In this case L3 was programmed, i.e. no legends)															
Terminator(s): (Code K6 programmed)															

Descriptive Legends

The following Legends will be fitted into the string after the exponent, if programmed by codes L0 or L2:

Recall	Function	Legend	Meaning	
V0)	U0-U5	F0	V	DC Volts
V0)	U0-U5	F1	V	AC Volts
V0)	U0-U5	F2	A	DC Amps
V0)	U0-U5	F3	A	AC Amps
V0)	U0-U5	F4	R	Resistance
P0-P2		pu		per unit
Frequency		Hz		frequency

Service Request

the 4708 can asynchronously request service from the controller by putting the SRQ line true (low).

SRQ is always generated by the action of switching the 4708 power ON, as the power-up default mode is Q0.

A user can program the 4708 to generate SRQs (or not) using command code Q:

Code	Q0	-	SRQ on any of the states in Table 5.5
	Q1	-	SRQ on overload and any FAIL state in Table 5.5 (but not in Error states).
	Q2	-	No SRQs generated

Serial Poll and RQS Status Byte

If programmed for SRQ response, the bus controller will pause in its operation to attend to the service request. It first conducts a serial or parallel poll to determine which device initiated the SRQ. The 4708 does not react to parallel poll, but only to serial poll, during which each device is addressed in turn. The instrument responds to its serial poll address by releasing a prepared 'RQS Status Byte' onto the bus. The RQS Request Bit (bit B7 of its status byte) is asserted only if the 4708 has generated the SRQ. This validates the remainder of the byte, which describes the causal condition by the state codes listed in Table 5.5.

RQS Status Byte Composition

- bit b8: Indicates a syntax or option error when true.
- bit b7: The RQS request bit, when true, confirms that the 4708 was the SRQ originator. The RQS status byte is not valid unless bit b7 is true.
- bit b6 true: Each combination of bits b5-b1 represents a single state as listed in Table 5.5.
- bit b6 false: Bits b5-b1 each represent separate functional states within the 4708 and the RQS byte represents several states as listed in Table 5.5.

Example with bit b6 false:

RQS status byte 01000001 represents:

- 0 - No option or Syntax error
- 1 - This instrument originated the SRQ
- 0 - The following bits each represent separate states
- 0 - This bit is not used in the 4708
- 0 - No High Voltage warning
- 0 - Auxiliary register not at limit
- 0 - Main register not at limit
- 1 - Output is ON

The RQS status byte should not be confused with other status messages (e.g. 'calibrator' or 'software' status, described earlier under 'Recall/Verify') which are called up by the system controller's program.

DIO Line Transmissions

Providing Q0 or Q1 has been selected; when the 4708 has a message to transmit over the DIO lines, it sets the SRQ line true

QS status bytes which may be transmitted by the instrument in the byte is valid only if bit 7 (request bit) is true.

or
test-for-service bit

↓
register limit reached
Register limit reached
range Warning

message available
specification not displayable
AL mode: Output not ON
AL mode: Incorrect Range/Function
AL mode: Insufficient store span
error or Offset mode: Overscale output requested
AL mode: Resistance selected exceeds val. value
C Functions: Output has been limited by internal

constraints
general selection error
option not fitted
fault condition rectified
over-temperature

over-voltage
control data corrupted
precision divider fault
parity alarm

store sum check non-parity
12V power supply fault (automatically resets if temporary)
power supply fault

✓ In-guard power supply fault
model 4600 communication fault
instrument reset to power-up state
External frequency no present
frequency not calibrated
- Current or Voltage limit

(1V) S0 T0 W0

**power-up but K = and L = continue unchanged
activates preceding string.**

New commands are executed in this sequence:

K	Output terminator format
L	Output notation
Q	SRQ Mode
W	Remote Calibration Enable
I	User Message Input
OØ	OUTPUT OFF
G	Guard
D	Safety Delay override
F	Function
R	Range
M	Main Register Value (Output)
A	Full Range/Zero
S	Sense
H	Auxiliary Register Value (Frequency)
T	Spot Frequency
O1	OUTPUT ON
C	Calibrate Mode
P	Specification tolerance
U	Specification limits
V	Recall/Verify
X	Diagnostic information

A programmer may elect to change the sequence by inserting terminators between commands, but the basic constraints of the 4708 will still be imposed. For example, if the function is changed as a single command (e.g. F3=) the main program firmware will set **Output OFF** as a result, and it must then be re-programmed ON by the user.

Succession of Multiple Commands

If the input buffer is not full, new commands are accepted to await their turn for processing, and are extracted string by string. The input system design makes it extremely unlikely that the buffer will overflow, unless the 4708 is in Local Control and the command input is excessive. If this does cause the buffer to fill up, the 4708 places a hold on the IEEE bus handshake sequence. The command IFC can be used to release the hold, followed by DCL to clear the 4708 input buffer; but as a general principle, this situation should be avoided by suitable reprogramming.

Input Errors

Some unwanted commands are ignored. Others enter the input buffer and are rejected later.

'Read' commands

Before addressing the 4708 as a talker, it is essential that it has been programmed by a P, U, V or X command. Otherwise it will have no data to transmit.

Universal commands

- LLO** (Local Lockout) - ignored, no capability.
- PPU** (Parallel Poll Unconfigure) - ignored, no capability for parallel poll.
- SPE** (Serial Poll Enable) - sets the 4708 to serial poll state, which when addressed responds with the RQS status byte. This byte contains the condition of the request-service bit (bit 7). If the 4708 is requesting service; bit 7 will be true, the other bits describing the service required.
- SPD** (Serial Poll Disable) - returns the instrument to serial poll idle state.

Addressed commands

- PPC** (Parallel Poll Configure) - ignored, no capability.
- GET** (Group Execute Trigger) - ignored, no capability.
- TCT** (Take Control) - ignored, no capability.
- GTL** (Go To Local) - instrument returns to Manual Control. The controller regains remote control by addressing the 4708 as a listener with REN line true.

Clear Commands (DCL and SDC)

When the 4708 receives either of the two 'Clear' messages, (DCL is universal and SDC is addressed to a selected device) it will default to the predetermined state defined below. During the time taken to default, the IEEE interface handshake is held. These commands are effective even in 'Local' control.

A?	Not Active (see M code)
FØ	DC Volts
RØ	Autorange 1V default
MØ	Where value is zero
TØ	Cancel Spot Frequency
H (value)	Where value is 1kHz
GØ	Local guard
SØ	Local sense
OØ	OUTPUT OFF state
QØ	SRQ on all specified states
DØ	Safety delay active
WØ	Calibration disabled
C?	Not active - disabled by W0
P?	Not active
U?	Not active
V?	Not active
X?	Not active
K*	Unchanged
L*	Unchanged

The frequency values held in 'Store' volatile memory locations F1-F5 are reset to the default state described on page 3-8.

Operational Sequence Guidelines

Most interface communication tasks require sequences of coded messages to be sent over the interface. Many controllers assign a single programming instruction to a complete sequence, so it is advisable to study the available controller capabilities carefully before attempting to program a system. Because the IEEE Std 488 (1978) allows a certain latitude in bus protocol, considerable differences may be found between programming instructions and operating sequences from one make of controller to another. Consequently, the following sequences are recommendations only.

Data Transfer

- UNL** Inhibits all current listeners
- LAD₁** Each address sent enables a specific device to receive future data bytes.
- LAD_n** More than one address may be sent if multiple listeners desired.
- TAD** The address sent enables a specific device to send data. The 4708 must be already programmed to prepare data.
- DAB₁** Data bytes sent by currently-enabled talkers to all currently-enabled listeners.
- DAB_n**
- UNT** Disables the talker on receipt of the last character.

- | | | | | |
|---|------------|---|-----------------------------------|---|
| [| UNL | = | unlisten |] |
| [| LAD | = | listen address of specific device |] |
| [| TAD | = | talk address of specific device |] |
| [| DAB | = | data bytes |] |
| [| UNT | = | untalk |] |

Serial Poll

- UNL** Inhibits all current listeners
- SPE** Puts interface into serial poll mode during which all devices send status instead of data when addressed.
- TAD_n** Enables a specific device to send status. Within this loop, device should be sequentially enabled.
- SBN**) Status byte sent by enabled device:
 - or) If SBN, loop should be repeated. If SBA sent, the
- SBA**) enabled device is identified as having sent SRQ and will automatically remove it.
- SPD** Disables serial poll mode.
- UNT** Disable last talker

- | | | | | |
|---|------------|---|---|---|
| [| SPE | = | Serial poll enable |] |
| [| SPD | = | Serial poll disable |] |
| [| SBN | = | Status byte negative where bit 7 = 0 |] |
| [| SBA | = | Status byte affirmative where bit 7 = 1 |] |

Untalk

It is highly desirable that a sequence which causes a device to be addressed as a talker should be terminated by an 'untalk' command.



DANGER

HIGH VOLTAGE



**THIS INSTRUMENT IS CAPABLE
OF DELIVERING
A LETHAL ELECTRIC SHOCK !**
when connected to a high voltage source

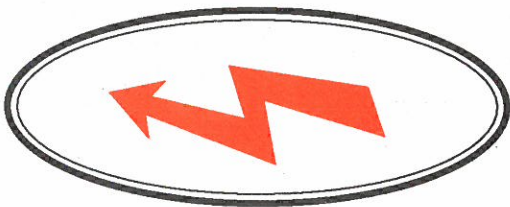

FRONT or REAR terminals
carry the Full Input Voltage

THIS CAN KILL !



Guard terminal is sensitive to
over-voltage

**It can damage your
instrument !**

Unless **you** are **sure** that it is **safe** to do so,
DO NOT TOUCH
the **I+ I- Hi** or **Lo leads** and **terminals**

DANGER

SECTION 6 SPECIFICATIONS

General

POWER SUPPLY

Voltage	:	100/120/220/240±10%
Line Frequency	:	48Hz to 62Hz
Consumption	:	370VA nominal 660VA full power
Fuses 220/240V	:	3.15A
100/120V	:	6.25A

MECHANICAL

Dimensions	:	Height 178mm (7") Width 455mm (17.9") Depth 564mm (22.2")
Weight	:	36kg (80lb)

SAFETY	:	The 4708 has been designed to meet BSI 4743, IEC 348 and UL 1244 specifications
--------	---	---

PEAK TERMINAL VOLTAGES

Guard to Ground	:	920V
Lo to Guard	:	920V
Lo to Ground	:	920V
Hi to Guard	:	1556V
Hi to Ground	:	1556V
Rear Panel Digital Inputs -		
to Hi	:	1556V
to Lo	:	920V
to Guard	:	920V
to Ground	:	0V to +5V

N.B.

Digital Common is internally connected to Ground

ENVIRONMENTAL CONDITIONS

Operating Temperature	:	0°C to +50°C
-----------------------	---	--------------

CAUTION

Above 30°C on 1kV Range max output power is derated.

Storage Temperature	:	-40°C to +70°C
Maximum Relative Humidity	:	75% at 40°C, non condensing
Warm-up Time	:	Two hours to meet all specifications

OPERATING INDICATIONS

Indication	:	Symbols lit on displays and illuminated keys
------------	---	--

Scale Lengths

Output Display	:	7.5 digits maximum
Frequency Display	:	3 digits plus store location
Mode Display	:	7.5 digits maximum

DC VOLTAGE (OPTION 10)

Accuracy

Range	Stability 24 hour \pm (ppm OUTPUT+ ppm FS) (1)(2)	Accuracy Relative to Calibration Standards \pm (ppm OUTPUT + ppm FS)(2)			Calibration Uncertainty (ppm)	Temperature Coefficient (\pm ppm OUTPUT/ $^{\circ}$ C) 13 $^{\circ}$ C - 18 $^{\circ}$ C 28 $^{\circ}$ C - 33 $^{\circ}$ C	Output Resistance	Output Compliance
		24 hour 23 $^{\circ}$ C \pm 1 $^{\circ}$ C	90 days 23 $^{\circ}$ C \pm 1 $^{\circ}$ C	1 year 23 $^{\circ}$ \pm 5 $^{\circ}$ C				
100.00 μ V to 100.00000mV	0.4 + 0.3 μ V	1.5 + 0.4 μ V	3 + 0.4 μ V	7 + 0.5 μ V	4	1.0	100 Ω	-
1.0000000V	0.3 + 0.25	1 + 0.4	2 + 0.4	5 + 0.5	2	0.5	<0.1m Ω	25mA
10.000000V	0.3 + 0.05	0.5 + 0.15	1 + 0.15	3 + 0.15	1.5	0.15	<0.1m Ω	25mA
100.00000V	0.5 + 0.1	1 + 0.25	2 + 0.25	5 + 0.25	2	0.5	<1m Ω	25mA
1000.0000V	0.5 + 0.1	1 + 0.25	3 + 0.25	7 + 0.25	2	0.5	<10m Ω	25mA

Noise (3)

Bandwidth Range	2.5kHz (RMS)	Average Over 1 Line Period (pk-pk)	Average Over 10 Line Periods (pk-pk)	DC-2Hz (Typical Null Detector) (pk-pk)
100 μ V-100mV	4 μ V	0.2 μ V	0.5 μ V	0.1 μ V
1V	4 μ V	2 μ V	0.5 μ V	0.5 μ V
10V	10 μ V	5 μ V	2 μ V	2 μ V
100V	120 μ V	50 μ V	25 μ V	25 μ V
1000V	2.5mV	600 μ V	200 μ V	150 μ V

Notes:

- (1) For same conditions between 18 $^{\circ}$ C and 28 $^{\circ}$ C.
- (2) FS = 2 x Range.
- (3) For 10kHz-wide band, multiply 2.5kHz figures by 2. For RMS, divide pk-to-pk figures by 6.

Other Specifications:

Output	True bipolar output capable of delivering 1100V with respect to Output Lo.
Oversrange	100% on 100 μ V to 100V ranges, 10% on 1000V range (1100V).
Voltage Sensing	Selectable remote or local voltage sensing on 1V to 1000V ranges.
Guarding	Selectable remote or local guard connection. Max Guard to Ground voltage of 650V rms (2.5kV flash test).
Common Mode Rejection	140dB at DC to 400Hz.
Settling Time	To 1ppm of step size <5s. To 10ppm of step size < 1s. To 100ppm of step size < 0.5s.



DANGER
HIGH VOLTAGE



**THIS INSTRUMENT IS CAPABLE
OF DELIVERING
A LETHAL ELECTRIC SHOCK !**
when connected to a high voltage source

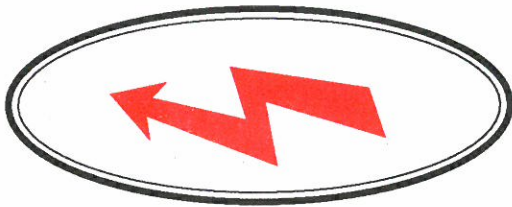

FRONT or REAR terminals
carry the Full Input Voltage

THIS CAN KILL !



Guard terminal is sensitive to
over-voltage

**It can damage your
instrument !**

Unless **you** are **sure** that it is **safe** to do so,
DO NOT TOUCH
the **I+ I- Hi** or **Lo leads** and **terminals**

DANGER

AC VOLTAGE (OPTION 20)

Accuracy

Range	Frequency (Hz)	Stability 24 hour ± (ppm OUTPUT + ppm FS (1) (2)	Accuracy Relative to Calibration Standards ± (ppm OUTPUT + ppm FS) (2)		
			24 hour 23°C ± 1°C	90 days 23°C ± 1°C	1 year 23°C ± 5°C
1.0000mV to 100.0000mV (7)	10 - 31	60 + 5 + 5µV	90 + 20 + 5µV	110 + 20 + 5µV	120 + 20 + 5µV
	32 - 330	30 + 5 + 5µV	50 + 20 + 5µV	60 + 20 + 5µV	70 + 20 + 5µV
	300 - 10k	20 + 5 + 5µV	40 + 20 + 5µV	50 + 20 + 5µV	60 + 20 + 5µV
	10k - 33k	20 + 5 + 5µV	50 + 20 + 5µV	60 + 20 + 5µV	70 + 20 + 5µV
	30k - 100k	30 + 5 + 5µV	200 + 20 + 5µV	250 + 20 + 5µV	300 + 20 + 5µV
	100k - 330k	80 + 10 + 5µV	550 + 50 + 10µV	750 + 50 + 10µV	1000 + 50 + 10µV
	300k - 1M	130 + 10 + 5µV	1250 + 500 + 20µV	1550 + 500 + 20µV	2000 + 500 + 20µV
1.000000V and 10.00000V	10 - 31	30 + 10	60 + 15	80 + 15	90 + 15
	32 - 330	10 + 5	30 + 10	40 + 10	50 + 10
	300 - 10k	7 + 2	20 + 5	30 + 5	40 + 5
	10k - 33k	7 + 2	20 + 5	30 + 5	40 + 5
	30k - 100k	15 + 5	50 + 10	60 + 10	80 + 10
	100k - 330k	30 + 10	150 + 50	180 + 50	250 + 50
	300k - 1M (6)	100 + 10	900 + 200	1100 + 200	1500 + 200
100.0000V	10 - 31	30 + 10	70 + 15	90 + 15	100 + 15
	32 - 330	10 + 5	40 + 10	50 + 10	60 + 10
	300 - 10k	10 + 2	30 + 5	40 + 5	50 + 5
	10k - 33k	10 + 2	40 + 10	50 + 10	60 + 10
	30k - 100k	15 + 5	70 + 15	90 + 15	120 + 15
	100k - 200k	30 + 10	250 + 50	280 + 50	400 + 50
1000.000V 750V Max	45 - 330	20 + 5	110 + 10	130 + 10	140 + 10
	300 - 10k	20 + 2	70 + 10	90 + 10	100 + 10
	10k - 33k	30 + 2	110 + 10	130 + 10	140 + 10
	30k - 100k	50 + 10	500 + 20	750 + 20	1000 + 20

Notes:

- (1) For same conditions between 18°C and 28°C.
- (2) FS = 2 x Nominal Range.
- (3) Estimated, not fully traceable.
- (4) Figures indicate pure THD only, excluding noise, which is included in the main specifications.
THD is predominantly second harmonic (negligible error on mean sensing equipment).
- (5) For Frequency Range or Output Range changes, Function changes, OFF/ON changes, and Frequency changes between 31 and 32Hz: the Settling times are doubled.
 - In remote operation via the IEEE 488 Interface, hardware switching occurs under the control of 'H' Frequency codes. Any transfer (up or down) between the undermentioned frequencies must be regarded as a frequency range change. Settling Time should be allowed as for 'Other Specifications'.
31 - 32 Hz 300 - 301Hz 3.00 - 3.01Hz 33.0 - 33.1Hz 330 - 331kHz
 - For settling to 10ppm of Step Size, multiply all times by 1.5.
- (6) For 1V and 10V ranges, 300kHz - 1MHz, load regulation from zero to half load included in accuracy specs.
- (7) Measurements at millivolt levels can often be susceptible to RFI pickup. Generally, care is needed where the measurement bandwidth is greater than 5MHz.
Rear output is not recommended for best performance in calibrating high bandwidth, low level instruments.

Calibration Uncertainty (ppm)	Temperature Coefficient (\pm ppm OUTPUT/ $^{\circ}$ C) 13 $^{\circ}$ C - 18 $^{\circ}$ C 28 $^{\circ}$ C - 33 $^{\circ}$ C	Total Harmonic Distortion (%) (4)	Output Impedance or Zero to Full Load Regulation	Output Compliance	Spot Frequency Accuracy Rel. to Stds. 1 Yr, \pm 5 $^{\circ}$ C
30 + 1 μ V 30 + 1 μ V 30 + 1 μ V 170 + 1 μ V 350 + 1 μ V 450 + 1 μ V (3) 450 + 1 μ V (3)	5 5 5 5 5 20 50	0.1 0.04 0.04 0.04 0.1 0.3 1.0	30 Ω at all frequencies		100 + 5 μ V 50 + 5 μ V 40 + 5 μ V 50 + 5 μ V 80 + 5 μ V 350 + 5 μ V 1000 + 5 μ V
20 20 20 20 50 100 300	3 3 3 3 3 10 50	0.1 0.04 0.04 0.04 0.1 0.3 1.0	Typically 0.001% FS to 33kHz increasing to 0.3% FS at 1MHz (2)	1V Range: 25mA 10V Range: 60mA	80 30 20(1V), 25(10V) 20(1V), 25(10V) 50 150 1000
20 20 20 20 50 200(3)	3 3 3 3 5 20	0.1 0.04 0.04 0.04 0.2 0.3	Typically 0.002% FS to 33kHz increasing to 0.02% FS at 100kHz (2)	120mA	80 30 30 40 60 200
30 30 50 50	5 5 5 7	0.2 0.1 0.1 0.5	Typically 0.002% FS (2)	<3.3kHz, 15mA >3.0kHz, 65mA	130 90 120 200

Other Specifications

Scale Length	9% to 200% of Range, 1mV to 100V ranges. 9% to 110% of Range, 1000V range (1100V).
Voltage Sensing	Selectable remote or local sensing on 1V to 1000V ranges, at all frequencies.
Guarding	Selectable remote or local guard connection. Maximum Guard to Ground voltage 650V RMS (2.5kV flash test).
Common Mode Rejection	140dB at DC to 400Hz.
Settling Time (5)	To 100ppm of step size (double for range changes); 10 - 32Hz - <10s. 32 - 330Hz - <3s. >330Hz - <1s.
Frequency Accuracy	<100ppm, typically <10ppm
Maximum Load Capacitance	1V to 100V ranges: 1000pF. 1000V range: 300pF

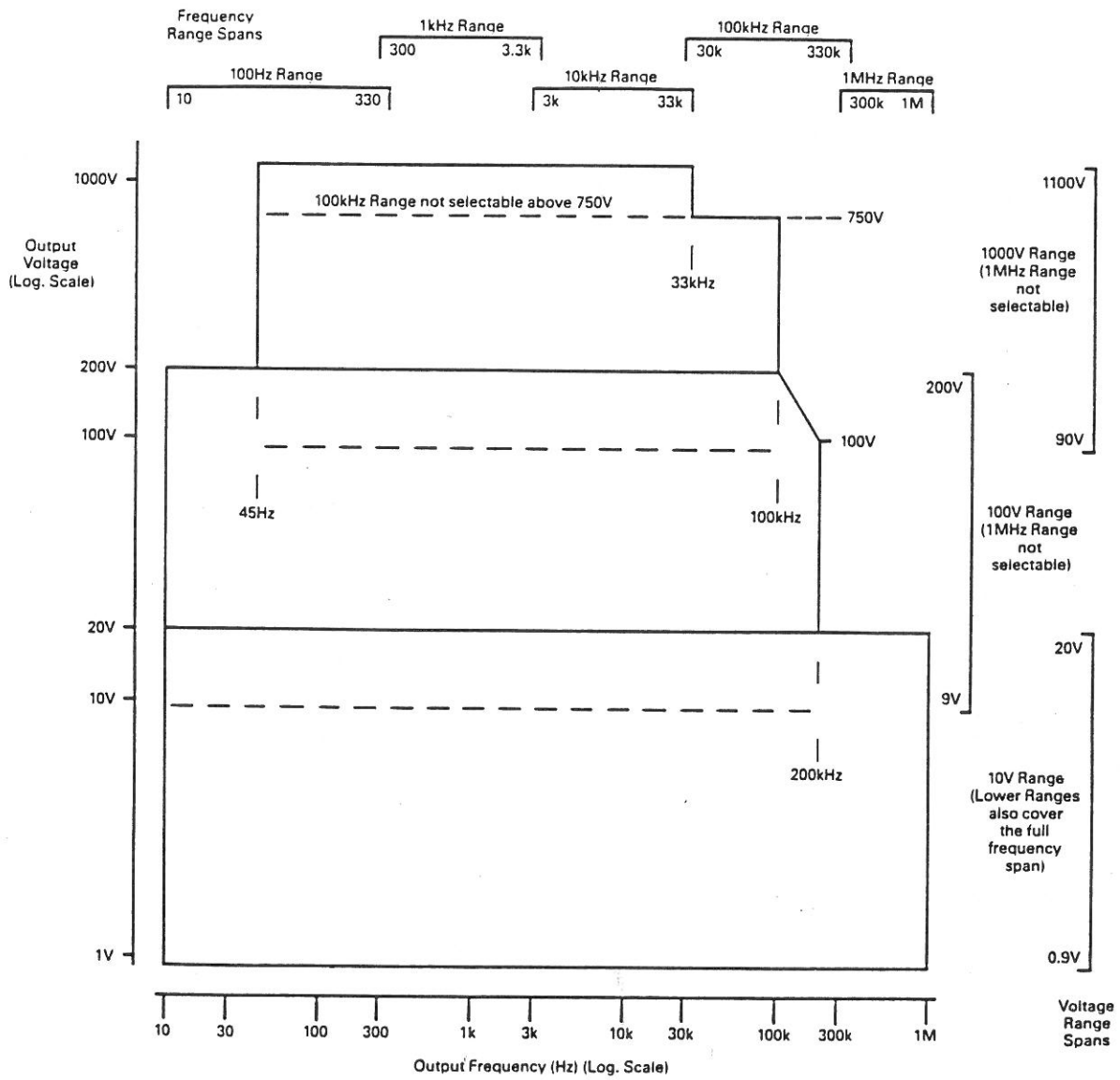

Capacitive Loading Constraints

Volt-Hertz Power Limit versus Capacitance Load (1kV Range)

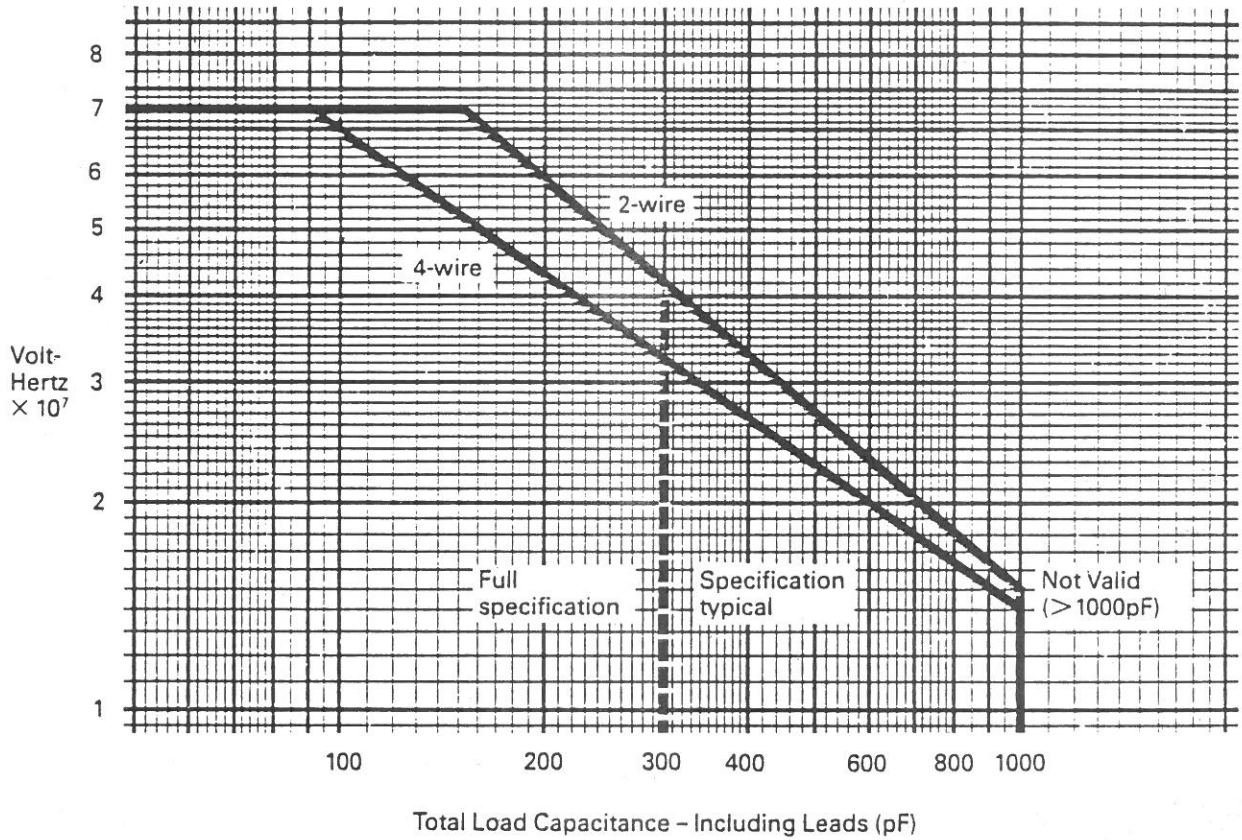

DC CURRENT (OPTION 30)

Accuracy

Range	Stability 24 hour \pm (ppm OUTPUT+ ppm FS) (1)(2)	Accuracy Relative to Calibration Standards \pm (ppm OUTPUT + ppm FS)(2)			Calibration Uncertainty (ppm)	Temperature Coefficient (\pm ppm OUTPUT/ $^{\circ}$ C) 13 $^{\circ}$ C - 18 $^{\circ}$ C 28 $^{\circ}$ C - 33 $^{\circ}$ C	Output Resistance	Output Compliance
		24 hour 23 $^{\circ}$ C \pm 1 $^{\circ}$ C	90 days 23 $^{\circ}$ C \pm 1 $^{\circ}$ C	1 year 23 $^{\circ}$ C \pm 5 $^{\circ}$ C				
100.0000 μ A	7 + 10	10 + 10	50 + 10	100 + 10	9	15	>2G Ω	3V
1.000000mA	3 + 4	5 + 5	20 + 5	40 + 5	9	6	>2G Ω	3V
10.00000mA	3 + 4	5 + 5	20 + 5	40 + 5	9	6	>200M Ω	3V
100.0000mA	3 + 4	5 + 5	20 + 5	40 + 5	9	6	>20M Ω	3V
1.000000A(3)	7 + 10	10 + 10	50 + 10	100 + 10	21	15	>1M Ω	3V

Noise

Range	2.5kHz (RMS)	Average Over 1 Line Period (pk-to-pk)	Average Over 10 Line Periods (pk-to-pk)
100 μ A	5nA	6nA	2nA
1mA	5nA	6nA	2nA
10mA	50nA	30nA	20nA
100mA	1 μ A	500nA	400nA
1A	25 μ A	30 μ A	20 μ A

Notes:

- (1) For same conditions between 18 $^{\circ}$ C and 28 $^{\circ}$ C.
- (2) FS = 2 x Range.
- (3) Typical above 1A.

Other Specifications

Output	True bipolar output capable of delivering \pm 2A
Overrange	100% on all ranges.
Settling Time	1s to full specification.
Sense	Local only.
Max. Reactive Load	100nF, 1mH (<1 μ s)



DANGER
HIGH VOLTAGE



**THIS INSTRUMENT IS CAPABLE
OF DELIVERING
A LETHAL ELECTRIC SHOCK !**
when connected to a high voltage source

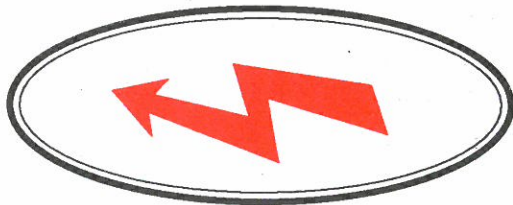

FRONT or REAR terminals
carry the Full Input Voltage

THIS CAN KILL !



Guard terminal is sensitive to
over-voltage

**It can damage your
instrument !**

Unless **you** are **sure** that it is **safe** to do so,
DO NOT TOUCH
the **I+ I- Hi** or **Lo leads** and **terminals**

DANGER

AC CURRENT (OPTION 30)

Range	Frequency (Hz)	Stability 24 Hour $\pm(\text{ppm OUTPUT} + \text{ppmFS})$ (1)(2)	Accuracy Relative to Calibration Standards $\pm (\text{ppmOUTPUT} + \text{ppm FS})$ (2)		
			24 hour 23°C \pm 1°C	90 days 23°C \pm 1°C	1 year 23°C \pm 5°C
100.0000 μ A	10 - 1k 1k - 5k	50 + 20 70 + 30	80 + 20 200 + 30(6)	120 + 30 250 + 40(6)	150 + 50 300 + 70(6)
1.000000mA	10 - 1k 1k - 5k	30 + 10 40 + 10	40 + 20 80 + 20	70 + 30 120 + 30	100 + 50 200 + 50
10.000000mA	10 - 1k 1k - 5k	30 + 10 40 + 10	40 + 20 80 + 20	70 + 30 120 + 30	100 + 50 200 + 50
100.0000mA	10 - 1k 1k - 5k	30 + 10 40 + 10	40 + 20 80 + 20	70 + 30 120 + 30	100 + 50 200 + 50
1.000000A(3)	10 - 1k 1k - 5k	50 + 20 70 + 30	200 + 20 350 + 30(6)	250 + 30 400 + 40(6)	300 + 50 450 + 70(6)

Notes:

(1) For same conditions between 18°C and 28°C.

(2) FS = 2 x Range.

(3) Typical above 1A.

(4) Predominantly second harmonic (negligible error on mean sensing equipment).

(5) For Frequency Range or Output Range changes, Function changes, OFF/ON changes, and Frequency changes between 31 and 32Hz: the Settling times are doubled.

- In remote operation via the IEEE 488 Interface, hardware switching occurs under the control of 'H' (Frequency) codes. Any transfer (up or down) between the undermentioned frequencies must be regarded as a frequency range change. Settling Time should be allowed as for 'Other Specifications'.

31 - 32 Hz 300 - 301Hz 3.00 - 3.01Hz

- For settling to 10ppm of Step Size, multiply all times by 1.5.

(6) Assumes similar load time constant to that at calibration.

(7) Specifications valid for compliance < 0.5Vrms. For > 0.5Vrms add the following:

100 μ A Range, 10Hz-1kHz: 50ppm FS
 1kHz-5kHz: 500ppm FS
 1mA to 1A Ranges, 10Hz-1kHz: 10ppm FS
 1kHz-5kHz: 50ppm FS

Calibration Uncertainty (ppm)	Temperature Coefficient (\pm ppm OUTPUT/ $^{\circ}$ C) 13 $^{\circ}$ C - 18 $^{\circ}$ C 28 $^{\circ}$ C - 33 $^{\circ}$ C	Total Harmonic Distortion (%) (4)	Typical Output Impedance	Output Compliance (7)
100	10	0.2	100M Ω *	3Vrms
100	20	0.5		
100	10	0.2	30M Ω	3Vrms
100	10	0.2		
100	10	0.2	3M Ω	3Vrms
100	10	0.2		
100	10	0.2	300k Ω	3Vrms
100	10	0.2		
100	20	0.2	30k Ω **	3Vrms
100	25	1.0		

* Typical effective output capacitance = 200pF

** Typical effective output capacitance = 0.5 μ F
Negligible on other ranges.

Other Specifications

Scale Length	9% to 200% of range, all ranges.
Settling Time (5)	To 100ppm of step size (double for range changes): 10-32Hz <10s 32-330Hz <3s >330Hz <1s
Frequency Accuracy	< \pm 100ppm, typically 10ppm.
Maximum Load Capacitance	10nF (<1 μ s).
Maximum Load Inductance	1mH (<1 μ s).
Sense	Local only.

RESISTANCE (OPTION 30)

Accuracy (2-wire or 4-wire sense)

Range (1)	Stability 24 hour $\pm(\text{ppm}$ OUTPUT+ ppm FS) (1)(2)	* Accuracy Relative to Calibration Standards $\pm(\text{ppm}$ OUTPUT + ppm FS)(2)			Calibration Uncertainty (ppm)	Temperature Coeff. ($\pm\text{ppm}$ OUTPUT/ $^{\circ}\text{C}$) 13 $^{\circ}\text{C}$ - 18 $^{\circ}\text{C}$ 28 $^{\circ}\text{C}$ - 33 $^{\circ}\text{C}$	Specified Current (Is)	Maximum Current (Im)	Additional Uncertainty for $I_s < I_m$ (ppm)
		24 hour 23 $^{\circ}\text{C} \pm 1^{\circ}\text{C}$	90 days 23 $^{\circ}\text{C} \pm 1^{\circ}\text{C}$	1 year 23 $^{\circ}\text{C} \pm 5^{\circ}\text{C}$					
10.000000 Ω	2	4	10	25	10	6	10mA	100mA	$(10 \times 10^2).I^2$
100.000000 Ω	1	1.5	3	9	5	2	10mA	25mA	$(8.5 \times 10^3).I^2$
1.0000000k	1	1.5	3	9	5	2	1mA	10mA	$(8.5 \times 10^4).I^2$
10.000000k	1	1.5	3	9	4	2	100 μA	2.5mA	$(8.5 \times 10^5).I^2$
100.00000k	1	1.5	3	10	6	2	100 μA	1mA	$(8.5 \times 10^6).I^2$
1.0000000M	2	4	10	25	12	6	10 μA	100 μA	$(10 \times 10^7).I^2$
10.000000M	2	10	25	50	17	10	1 μA	10 μA	$(15 \times 10^8).I^2$
100.00000M	3	15	30	70	50	20	1 μA	10 μA	$(15 \times 10^9).I^2$

* For 2-Wire Sensing:

24 hours stability	}	add $\pm 0.1\Omega$
24 hours accuracy		
90 days accuracy		
1 years accuracy		add $\pm 0.2\Omega$

Notes:

- (1) Range figures are nominal, actual calibrated values are displayed.
- (2) FS = 2 x Range.

Other Specifications

- Connection Selectable 2 or 4-wire connection to resistors.
2-wire displayed value includes internal lead resistance.
- Guarding Selectable remote or local guard connection.
- Protection All resistors fuse-protected to max applied voltage of 120V RMS.



DANGER
HIGH VOLTAGE



**THIS INSTRUMENT IS CAPABLE
OF DELIVERING
A LETHAL ELECTRIC SHOCK !**
when connected to a high voltage source

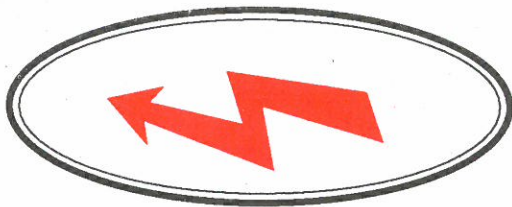

FRONT or REAR terminals
carry the Full Input Voltage

THIS CAN KILL !



Guard terminal is sensitive to
over-voltage

**It can damage your
instrument !**

Unless **you** are **sure** that it is **safe** to do so,
DO NOT TOUCH
the **I+ I- Hi** or **Lo leads** and **terminals**

DANGER

SECTION 7 SPECIFICATION VERIFICATION

Introduction

The factory calibration of the 4708 ensures traceable accuracy to national standards. Figures of performance are quoted in the specifications of Section 6, related to time since calibration.

This section deals with user-verification of the 4708 performance to specification, describing a recommended method of verifying each of the parameters listed below. Supplementary information is given in Appendices to the section.

Choice of Verification Method

The wide dynamic range of the 4708 makes it necessary to employ different verification methods for different groups of output and frequency ranges.

Naturally, the range, accuracy and traceability of users' standards affects the manner in which the performance of any new equipment can be verified.

Parameters to be Verified, with Recommended Methods

1. DC Voltage Ranges (100 μ V to 1000V).

- a. Full Range values are verified against a DC Voltage Standard, using a precision divider when necessary.
- b. DC Linearity is verified against the specification on the 10V range at $\pm 0V$, $\pm 1V$, $\pm 10V$ and $\pm 19V$, using the same method.

2. DC Current Ranges (100 μ A to 1A).

Full Range values are checked using standard shunts, against a DMM which is initially standardized to the instrument's DC Voltage accuracy.

3. AC Voltage Ranges (1V to 1000V).

- a. Full Range values are verified at LF and HF by direct thermal transfer against a DC Voltage Standard.
- b. AC Linearity is verified at 1V, 10V and 19V on the 10V range at LF, using the same method.

4. AC Millivolt Ranges (1mV to 100mV).

Full Range values are verified as follows:

- a. At LF:
Commercially available Inductive Voltage Divider, and standardized DVM transfer.
(Such "IVD"s are normally only suitable for LF verification, up to about 5kHz).
- b. At HF:
A 100%-to-10% of Range Transfer method, after verifying 10V range HF linearity and 1V HF Full Range value. A DMM is standardized and corrected for linearity error, then used as a transfer standard.

An alternative method is described at Appendix 4 using a Wideband (to 100kHz) Inductive Voltage Divider (WIVD).

5. AC Current Ranges (1mA to 1A).

- a. 10mA, 100mA and 1A Full Range values are checked using a Thermal Transfer Standard fitted with standard shunts at LF and HF, against a DC Current Standard.
- b. The 1mA Full Range value can be checked using the same method, provided that low-current shunts for the thermal transfer standard are available.

Alternatively, if calibrated AC current shunts are available, the 100 μ A - 1A AC Current Ranges can be verified by voltage measurement, using a standardized AC DMM, as described in Appendix 5.

6. Resistance Values (10 Ω to 100M Ω).

Resistors are checked against their 4-wire displayed values, and resistors plus internal wiring (2-wire) are checked against limits above the measured 4-wire values; using a precision DMM or other accurate ratiometric resistance-measuring equipment.

User's Uncertainty Calculations

Users will need to evaluate the effects of their own Standards' uncertainties, so calculations for total tolerance limits (Validity Tolerance) are given in Appendix 2.

DC Voltage Verification

(100 μ V-1000V Full Range Values; 10V Range Linearity)

Summary of Verification Procedures

1. Full Range Low Voltage (100 μ V - 10V Ranges)

The 4708, a Null Detector and a DC Voltage Standard are connected up and the 4708 is set to output a Full Range voltage. The DC Standard is adjusted to null with the 4708 Full Range voltage, and its output voltage is recorded. The accumulated uncertainties are also recorded, and the Validity Tolerance Limits are calculated. The 4708 is verified if the DC voltage is within the tolerance limits.

Details of the procedure are on pages 7-4/5.

2. Linearity (Performed on 10V Range)

Should be checked at $\pm 0V$, $\pm 10V$ and $\pm 19V$ in turn. Similar techniques are used as for Full Range voltages. For each check the results are recorded.

Details of the procedure are on pages 7-4/5.

3. Full Range High Voltage (100V & 1000V Ranges)

The 4708, a Precision Divider, a Null Detector and a DC Voltage Standard are connected up and the 4708 is set to output a Full Range voltage. The DC Standard is adjusted to null with the 4708 Full Range voltage, and its output voltage is recorded. The accumulated uncertainties are also recorded, and the Validity Tolerance Limits are calculated. The 4708 is verified if the DC voltage is within the tolerance limits.

Details of the procedure are on pages 7-6/7.

Interconnections

Interconnection instructions in this section are necessarily simple and basic, and are mainly intended to show connections to the 4708. It is recognized that they may need to be adapted to meet an individual user's requirements. It is assumed that users will possess knowledge of the operation and use of standards equipment such as that mentioned above.

Equipment Requirements

- A Standard DC Voltage Source of suitable accuracy.

Example: Series bank of 10 standard cells and Datron 4904 Standard Cell Buffer.

- A Precision Voltage Divider.

Example: Datron 4902 High Voltage Divider.

- A battery-operated Null Detector with variable sensitivity, able to withstand 1200V across its input terminals.

Example: Keithley Instruments Model 155.

N.B. Either the DC source or Precision Voltage Divider should be of a type which permits verification at Nominal Full Range values, and 19V.

Preparation

Before attempting any verification ensure that the following steps have been carried out.

1. Turn on the instrument to be checked and allow at least 2 hours warm-up in the specified environment.
2. Cancel any MODE keys, ensure OUTPUT OFF and check that 'cal' is not present on the MODE display. (If 'cal' is present, turn the Calibration Keyswitch on the Rear Panel to its RUN position).
3. Before connecting and operating any equipment, consult the manufacturers' handbooks.
4. Self-Test: Press the 'Test' key to carry out the test routine described in Section 4. Terminate the test routine.
5. If 'Spec' Mode is required, select either 24hr, 90day or 1yr on the Rear Panel CALIBRATION INTERVAL Switch. When received from Datron, 90day is the relevant selection. The report sheets hold figures for this interval.

DC Low Voltage Verification Procedure

Record results on Report Sheet 4708 RS 1 (Page 7-32).

Full Range Checks (100 μ V - 10V),

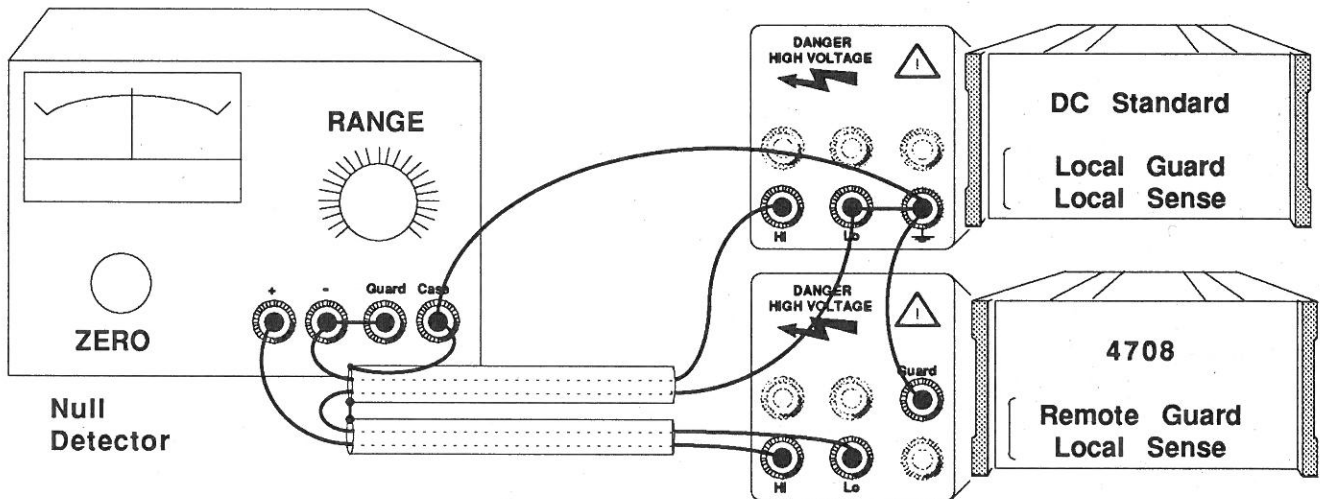

WARNING:

THE TERMINALS MARKED WITH THE  SYMBOL CARRY THE OUTPUT OF THE 4708. THESE TERMINALS AND ANY OTHER CONNECTIONS TO THE LOAD UNDER TEST COULD CARRY LETHAL VOLTAGES.

UNDER NO CIRCUMSTANCES SHOULD USERS TOUCH ANY OF THE FRONT (OR REAR) PANEL TERMINALS UNLESS THEY ARE FIRST SATISFIED THAT NO DANGEROUS VOLTAGE IS PRESENT.

Verify each range in the sequence of RS1 Table 1 (a) as follows:

- a. Appendix 3 Read the notes on the use of the Null Detector.
 - b. Both voltage sources Set output to zero.
 - c. Null Detector Set to low sensitivity.
 - d. With both outputs OFF, connect the DC Voltage Standard and the 4708 to the Null Detector as shown in the diagram for High Voltage, and allow the circuit to stabilize thermally. Ensure correct Guard and Sense selections.
 - e. DC Voltage Standard Set to the correct polarity and voltage (see RS1).
 - f. 4708 (see RS1) i. Ensure that DC and the correct OUTPUT Range are selected.

ii. With OUTPUT OFF, use the OUTPUT \updownarrow keys to set the correct polarity and voltage on the OUTPUT display.
- CAUTION:** In operation (iii), pressing the wrong ON key will result in approximately twice the output voltage being connected across the Null Detector.
- iii. Press the correct-polarity OUTPUT ON key.
 - g. DC Voltage Standard Set OUTPUT ON.
 - h. Null Detector Increase sensitivity to give an off-null reading.
 - j. DC Voltage Standard Adjust output voltage to give a null on the Null Detector.
 - k. Repeat (h) and (j) until the null lies between two consecutive values of DC Voltage Standard Output, at the same resolution as the 4708 OUTPUT display.

- l. DC Voltage Standard Record output voltage on RS1.
- m. Repeat (e) to (l) for all 4708 outputs on RS1 Table 1(a).
- n. DC Voltage Standard Set OUTPUT OFF.
- p. 4708 Set OUTPUT OFF.
- q. Sum the Verification setup uncertainties and record in the Us column as voltage deviations. (Refer to Appendix 2).

Validity Tolerance Limit Calculations

Refer to Appendix 1 page 7-A1-1, para 1.

- r. Calculate the two Validity Tolerance Limits:

Use Calculation A if the 4708 was last calibrated by Datron.

Use Calculation B if the 4708 was last calibrated against the standards being used for verification.

Each 4708 Full Range output is verified if the DC Voltage outputs recorded in (l) are at or between the corresponding Validity Tolerance Limits.

Linearity (10V Range)

- s. If the 10V Range verified correctly, repeat operations (e) to (r) for RS1 Table 1(b).

If the Low Voltage Ranges verified, proceed to High Voltage Ranges verification.

DC High Voltage Verification Procedure

Record results on Report Sheet 4708 RS 1 (Page 7-32).

Full Range Checks (100V - 1000V)

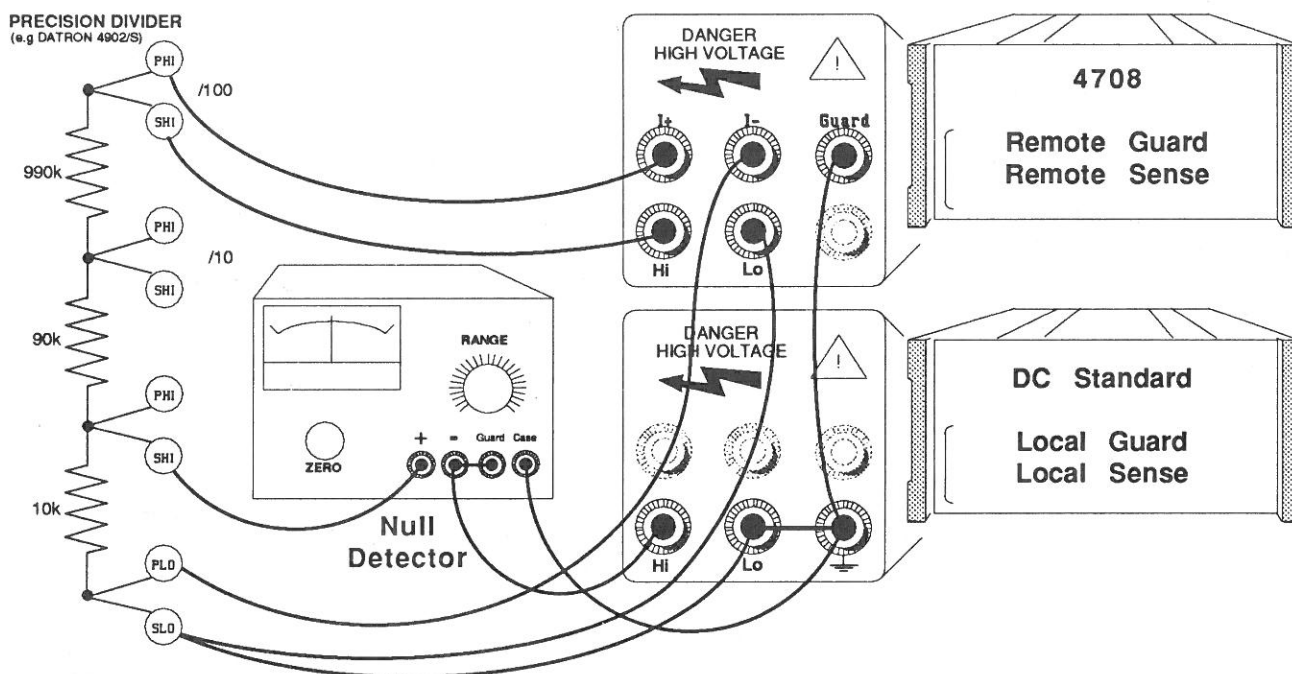

WARNING:

THE TERMINALS MARKED WITH THE  SYMBOL CARRY THE OUTPUT OF THE 4708. THESE TERMINALS AND ANY OTHER CONNECTIONS TO THE LOAD UNDER TEST COULD CARRY LETHAL VOLTAGES.

UNDER NO CIRCUMSTANCES SHOULD USERS TOUCH ANY OF THE FRONT (OR REAR) PANEL TERMINALS UNLESS THEY ARE FIRST SATISFIED THAT NO DANGEROUS VOLTAGE IS PRESENT.

Note: On the diagram, the terminals of the Precision Divider are marked 'PHI', 'PLO', 'SHI' and 'SLO'. These are terms which apply to the Datron 4902 and 4902S, referring to their Power Hi & Lo inputs, and Sense Hi & Lo pickoffs for true 4-wire connections (described in their User's Handbook).

For other dividers, it is important that true 4-wire connections are made directly to the elements of the divider, and that the divider has been calibrated at the connection points.

Verify each range in the sequence of RS1 Table 1 (c) as follows:

- | | | |
|--|---|--|
| <p>a. Appendix 3</p> <p>b. Both voltage sources</p> <p>c. Null Detector</p> <p>d. With both outputs OFF, connect the DC Voltage Standard and the 4708 to the Null Detector as shown in the diagram for High Voltage, and allow the circuit to stabilize thermally. Ensure correct Guard and Sense selections.</p> <p>e. DC Voltage Standard</p> <p>f. 4708 (see RS1)</p> | <p>Read the notes on the use of the Null Detector.</p> <p>Set output to zero.</p> <p>Set to low sensitivity.</p> <p>Set to the correct polarity and voltage (see RS1).</p> <p>i. Ensure that DC and the correct OUTPUT Range are selected.</p> <p>ii. With OUTPUT OFF, use the OUTPUT ↑ ↓ keys to set the correct polarity and voltage on the OUTPUT display.</p> <p>iii. Press the correct-polarity OUTPUT ON key.</p> | <p>j. DC Voltage Standard</p> <p>k. Repeat (h) and (j) until the null lies between two consecutive values of DC Voltage Standard output, at the same resolution as the 4708 OUTPUT display.</p> <p>l. DC Voltage Standard</p> <p>m. Repeat (e) to (l) for all 4708 outputs on Report Sheet RS1 Table 1(c).</p> <p>n. DC Voltage Standard</p> <p>p. 4708</p> <p>q. Sum the Verification setup uncertainties and record in the Us column as voltage deviations. (Refer to Appendix 2).</p> |
|--|---|--|
- CAUTION:** In operation (iii), pressing the wrong ON key will later result in approximately twice the output voltage being connected across the Null Detector!
- Note:** It is necessary to enter High Voltage State to verify the 1000V Full Range value (see page 4-7).
- | | |
|---|--|
| <p>g. DC Voltage Standard</p> <p>h. Null Detector</p> | <p>Set OUTPUT ON.</p> <p>Increase sensitivity to give an off-null reading.</p> |
|---|--|

Validity Tolerance Limit Calculations

Refer to Appendix 1 page 7-A1-1, para 1.

- r. Calculate the two Validity Tolerance Limits:

Use Calculation A if the 4708 was last calibrated by Datron.

Use Calculation B if the 4708 was last calibrated against the standards being used for verification.

Each 4708 Full Range output is verified if the DC Voltage outputs recorded in (l) are at or between the corresponding Validity Tolerance Limits.

DC Current Verification

(100 μ A-1A Full Range Values)

Summary of Verification Procedures

Full Range Current (Using Preferred Standard Shunts)

The 4708 is used on its 1V range to standardize the DMM at 1V. The 4708 is then set to its 100 μ A range, with its I+ and I- terminals connected across the 10k Ω shunt, and the DMM is connected to measure the voltage across the shunt.

The 4708 output current is adjusted until the DMM voltage reading represents nominal 100 μ A full range output into the 10k Ω shunt. At this setting the reading on the 4708 OUTPUT Display is recorded. The accumulated uncertainties are also recorded, and the Validity Tolerance Limits calculated. The 4708 is verified if the OUTPUT Display reading is within the tolerance limits.

For the 1mA, 10mA and 100mA ranges, the preferred shunts also require the DMM to be standardized at 1V; but for the 1A range the 0.1 Ω shunt is used to keep the output power at a low level, so the DMM is standardized at 100mV.

The procedure is detailed on pages 7-10/11.

Interconnections

Interconnection instructions in this section are necessarily simple and basic, and are mainly intended to show connections to the 4708. It is recognized that they may need to be adapted to meet an individual user's requirements. It is assumed that users will possess knowledge of the operation and use of standards equipment such as that mentioned above.

Equipment Requirements

- A DC Voltage Source, calibrated to suitable accuracy at 1V and 100mV.

Example: The verified DC Voltage ranges of the instrument under test.

- A set of Calibrated Current Shunts of suitable accuracy.

- A DMM of sufficient resolution and stability to measure the voltage across the set of shunts.

Example: A Datron 1281, 1081, 1071 or 1061A used as a transfer-measurement device.

N.B. To allow the same value to be set on the DC Voltage Source for the four lower ranges, the shunts may be of four decade values. Then the same DMM sensitivity can be used on each range.

CAUTION When choosing a set of current shunts, ensure that their power dissipation ratings are sufficient to avoid permanent degradation from the self-heating effects of the current being checked. This applies particularly to the 1 Amp shunt.

Preparation

Before attempting any verification ensure that the following steps have been carried out.

1. Turn on the instrument to be checked and allow at least 2 hours warm-up in the specified environment.
2. Cancel any MODE keys, ensure OUTPUT is OFF and check that 'cal' is not present on the MODE display. (If 'cal' is present, turn the Calibration Keyswitch on the Rear Panel to its RUN position).
3. Before connecting and operating any equipment, consult the manufacturers' handbooks.
4. Self-Test: Press the 'Test' key to carry out the test routine described in Section 4. Terminate the test routine.
5. If 'Spec' Mode is required, select either 24hr, 90dy or 1yr on the Rear Panel CALIBRATION INTERVAL Switch. When received from Datron, 90dy is the relevant selection. The report sheets hold figures for this interval.

DC Current Verification Procedure

Record results on Report Sheet 4708 RS 1, (Page 7-33).

Full Range Checks (100 μ A - 1A)

N.B. Values in square brackets [...] apply when the DMM is to be standardized for the 1A Range at 100mA, using the preferred transfer shunt value of 0.1 Ω .

Standardize the DMM at 1V [100mV]:

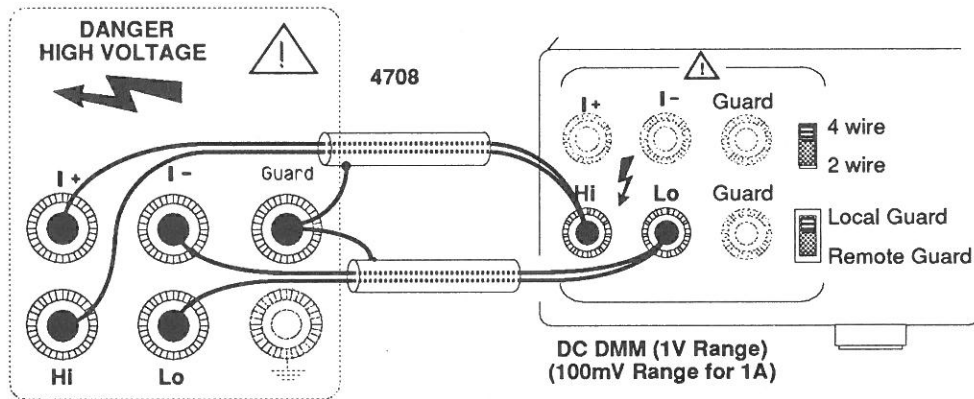

Ensure that the 4708 has already been verified on its 1V and 100mV ranges.

Ensure that the DMM has been recently calibrated, or that its zero-offsets have been removed, and its polarity turnover at 1V [100mV] is verified as accurate.

Standardize the DMM before verifying the ranges in the sequence of RS1 Table 2:

- a. 4708 Set OUTPUT OFF,
 FUNCTION to DC,
 OUTPUT RANGE to 1 [100m],
 Sense and Guard to Remote.
 OUTPUT Display to +1.000000V
 [+100.00000mV]
- b. Connect the DMM to read the 4708 output for standardization (no shunt). Observe the correct DMM Guard selections.
- c. DMM Set to measure 1V [100mV] DC.
- d. 4708 Set OUTPUT ON.
- e. DMM Note the reading as '+VI'.
- f. 4708 Set OUTPUT OFF.
- g. Disconnect the 4708 from the DMM.

To Verify the 4708 DC Current output:

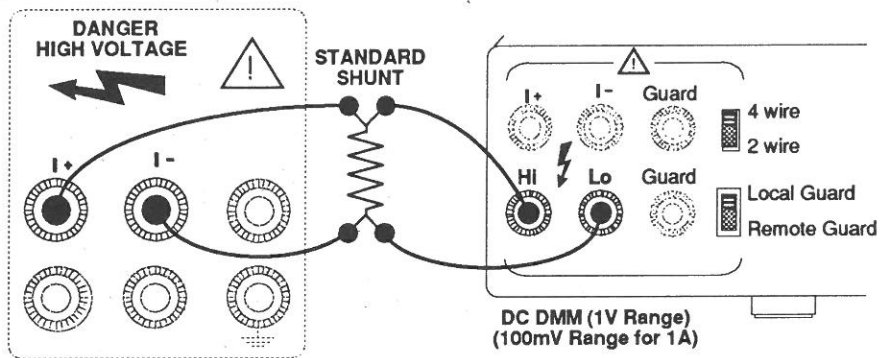

h. Connect the 4708, Shunt and DMM as shown in the diagram.

j. 4708

- i. Set FUNCTION to I,
- ii. Select the 100 μ A range,
- iii. Press the Full Range key.
- iv. Press the OUTPUT ON+ key.
- v. Adjust OUTPUT \updownarrow keys to obtain a reading on the DMM of $\pm V1$ noted in (e).
- vi. Record the 4708 OUTPUT Display reading on RS1 Table 2.

k. Repeat (h) and (j), but for 4708 -100 μ A, \pm 1mA, \pm 10mA, and \pm 100mA Full Range outputs, using the appropriate values of transfer shunt.

l. Repeat the standardization of the DMM (items a to g), but at 100mV.

m. Repeat (h) and (j), but for 4708 \pm 1A Full Range output, using the 0.1 Ω transfer shunt.

n. Sum the Verification setup uncertainties and record in the Us column as current deviations. (Refer to Appendix 2).

Validity Tolerance Limit Calculations

Refer to Appendix 1 page 7-A1-1.

p. Calculate the Lower and Upper Validity Tolerance Limits.

Use Calculation A if the 4708 was last calibrated by Datron.

Use Calculation B if the 4708 was last calibrated against the standards being used for verification.

Each 4708 Full Range output verifies if the OUTPUT display readings recorded in (j) are at or between the corresponding Validity Tolerance Limits.



DANGER

HIGH VOLTAGE



**THIS INSTRUMENT IS CAPABLE
OF DELIVERING
A LETHAL ELECTRIC SHOCK !**
when connected to a high voltage source

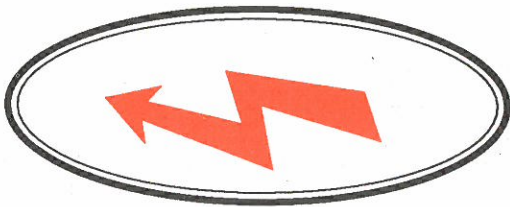

FRONT or REAR terminals
carry the Full Input Voltage

THIS CAN KILL !



Guard terminal is sensitive to
over-voltage

**It can damage your
instrument !**

Unless **you** are **sure** that it is **safe** to do so,
DO NOT TOUCH
the **I+ I- Hi** or **Lo leads** and **terminals**

DANGER

AC Voltage Verification

(1V - 1000V Full Range Values; 10V Range Linearity).

Summary of Verification Procedures

Full Range Voltage (1V - 1000V Ranges)

The 4708 is connected up and set to output a Full Range voltage at the required frequency. The Thermal Transfer is nulled against the 4708 Full Range voltage. The DC Standard is adjusted to null with the Thermal Transfer, and its output voltage recorded. Its uncertainty is also recorded, and the Tolerance Limits calculated. The 4708 is verified if the DC voltage is within the tolerance limits.

Details of the procedure are on pages 7-14/15.

2. Linearity (Performed on 10V Range)

Should be checked at 1V, 10V and 19V in turn. Similar techniques are used as for Full Range voltages. For each check the results are recorded.

See pages 7-14/15 for the procedure.

Interconnections

Interconnection instructions in this section are necessarily simple and basic, and are mainly intended to show connections to the 4708. It is recognized that they may need to be adapted to meet an individual user's requirements. It is assumed that users will possess knowledge of the operation and use of standards equipment such as that mentioned above.

Equipment Requirements

- An adjustable DC Voltage Source of suitable accuracy.

Example:

Datron 4000 or 4000A Autocal Standard.

- An AC/DC Thermal Transfer Standard capable of operating over the range 1V to 1100V RMS.

Preparation

Before attempting any verification ensure that the following steps have been carried out.

1. Turn on the instrument to be checked and allow at least 2 hours warm-up in the specified environment.
2. Cancel any MODE keys, ensure OUTPUT is OFF and check that 'cal' is not present on the MODE display. (If 'cal' is present, turn the Calibration Keyswitch on the Rear Panel to its RUN position).
3. Before connecting and operating any equipment, consult the manufacturers' handbooks.
4. Self-Test: Press the 'Test' key to carry out the test routine described in Section 4. Terminate the test routine.
5. If 'Spec' Mode is required, select either 24hr, 90dy or 1yr on the 4708 Rear Panel CALIBRATION INTERVAL Switch. When received from Datron, 90dy is the relevant selection. The report sheets hold figures for this interval.

AC Voltage Verification Procedure

Record results on Report Sheet 4708 RS1 (Page 7-34).

Full Range Checks (1V - 1000V)

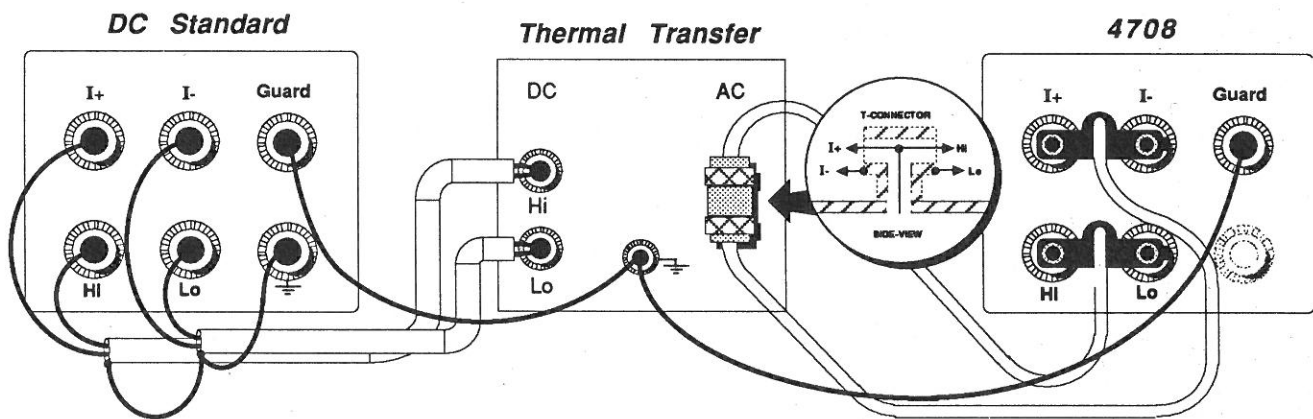

WARNING:

THE TERMINALS MARKED WITH THE  SYMBOL CARRY THE OUTPUT OF THE 4708. THESE TERMINALS AND ANY OTHER CONNECTIONS TO THE LOAD UNDER TEST COULD CARRY LETHAL VOLTAGES.

UNDER NO CIRCUMSTANCES SHOULD USERS TOUCH ANY OF THE FRONT (OR REAR) PANEL TERMINALS UNLESS THEY ARE FIRST SATISFIED THAT NO DANGEROUS VOLTAGE IS PRESENT.

Note: For the arrangement shown in the diagram, the coaxial T-connector provides true 4-wire connection to the AC coaxial input of the Thermal Transfer.

For Thermal Transfers with other AC terminations, it is important that true 4-wire connections are made directly to the AC input terminals, and that the device has been calibrated at the connection

- a. With OUTPUT OFF, connect the DC Voltage Standard to the Thermal Transfer DC input. Use 4-wire connection and Remote Sense if available.
- b. With OUTPUT OFF, connect the 4708 to the Thermal Transfer AC input. Use 4-wire connection and Remote Sense.
- c. Configure the Thermal Transfer for AC measurement at the required voltage.
- d. Set the 4708 OUTPUT Range, Voltage and Frequency (see RS1).
- e. Set 4708 OUTPUT ON, and null the Thermal Transfer to the 4708 AC OUTPUT.
- f. Configure the Thermal Transfer for DC nulling.
- g. Configure the DC Voltage Standard at the required voltage, set its OUTPUT ON and adjust its output voltage to null the Thermal Transfer. Record its output voltage on RS1.
- h. Repeat (c) to (g) for all 4708 outputs on RS1 Tables 1(a) and 1(b).
- j. Sum the Verification setup uncertainties and record in the Us column as voltage deviations. (Refer to Appendix 2).

For Validity Tolerance Limit Calculations Refer to Appendix 1 page 7-A1-1, para 1.

- k. Calculate the Lower and Upper Validity Tolerance Limits:
Use Calculation A if the 4708 was last calibrated by Datron.
Use Calculation B if the 4708 was last calibrated against the standards being used for verification.
- l. Each 4708 Full Range output is verified if the DC Voltage outputs recorded in (g) are at or between the corresponding Validity Tolerance Limits.

Linearity (10V Range)

- m. If the 10V Range verified correctly, repeat operations (c) to (j) for RS1 Table 1(c).
- n. If the 1V and 10V Ranges verified proceed to AC Millivolt verification.

AC Millivolts Verification

(1mV - 100mV Full Range Values).

Summary of Verification Procedures

Method 1

At LF, the 1V Full Range value is first verified using thermal transfer, then this voltage is divided via the standard IVD to standardize an AC DMM at the millivolt Full Range value. The 4708 millivolt range is then verified at this standardized value by DMM measurement.

See pages 7-18/19 for the procedure.

At HF, the 4708 is set to the 10V Range. Outputs are measured at 10V and 1V using thermal transfer, and a linearity correction factor is calculated for the 1V output.

The 1V Range is selected with output set to 100mV at HF. The output setting is changed by the correction factor and the output is used to standardize the AC DMM.

The 100mV Range is selected at HF Full Range, and the output measured on the DMM. The 100mV Full Range value verifies if the DMM reading is the corrected value, plus or minus the specified tolerances.

The DMM is standardized at 10mV on the 100mV Range, and used to verify the 10mV Full Range in the same way. The process is repeated to verify the 1mV Range.

See pages 7-20 to 7-23 for the procedure.

Method 2

At both LF and HF, the 1V Full Range value is first verified using thermal transfer, then this voltage is divided via the wideband IVD to standardize an AC DMM at the millivolt Full Range value. The 4708 millivolt range is then verified at this standardized value by DMM measurement.

See Appendix 4 for the procedure.

Interconnections

Interconnection instructions in this section are necessarily simple and basic, and are mainly intended to show connections to the 4708. It is recognized that they may need to be adapted to meet an individual user's requirements. It is assumed that users will possess knowledge of the operation and use of standards equipment such as that mentioned above.

Equipment Requirements

at LF;

- A commercially-available Inductive Voltage Divider tapped at 10:1, 100:1 and 1000:1 of suitable accuracy and frequency response.

at HF;

- The 4708 under test with the correction figure for 10% of its 10V Range at HF.

- The DC Voltage Source used for 1V - 1000V ranges

and at both LF and HF;

- The AC/DC Thermal Transfer used for 1V - 1000V ranges.

- A DMM of suitable accuracy and frequency response.

Example:

Datron 1281 or 1081.

Preparation

Before attempting any verification ensure that the following steps have been carried out.

1. Turn on the instrument to be checked and allow at least 2 hours warm-up in the specified environment.
2. Cancel any MODE keys, ensure OUTPUT is OFF and check that 'cal' is not present on the MODE display. (If 'cal' is present, turn the Calibration Keyswitch on the Rear Panel to its RUN position).
3. Before connecting and operating any equipment, consult the manufacturers' handbooks.
4. Self-Test: Press the 'Test' key to carry out the test routine described in Section 4. Terminate the test routine.
5. If 'Spec' Mode is required, select either 24hr, 90dy or 1yr on the Rear Panel CALIBRATION INTERVAL Switch. When received from Datron, 90dy is the relevant selection. The report sheets hold figures for this interval.

Millivolts (LF) Verification Procedure

(Using the verified 1V Range of the 4708, Inductive Voltage Divider (IVD) and AC DMM)
Record results on Report Sheet 4708 RS 1, Table 4(a) (Page 7-34).

Full Range Checks (1mV - 100mV at 1kHz)

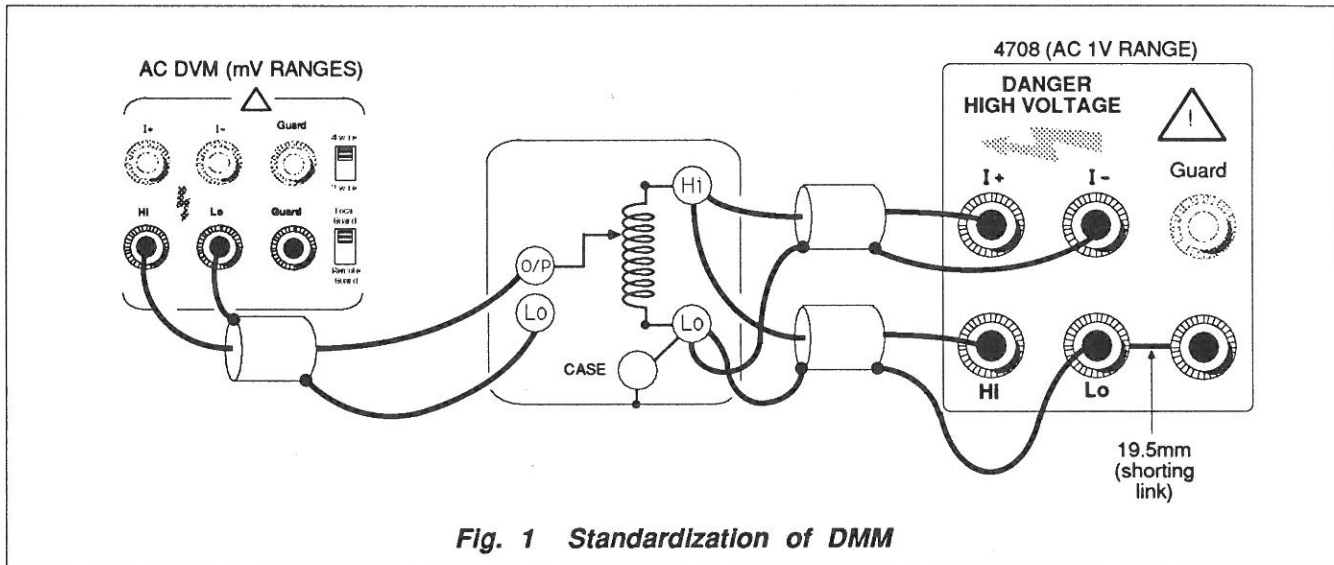
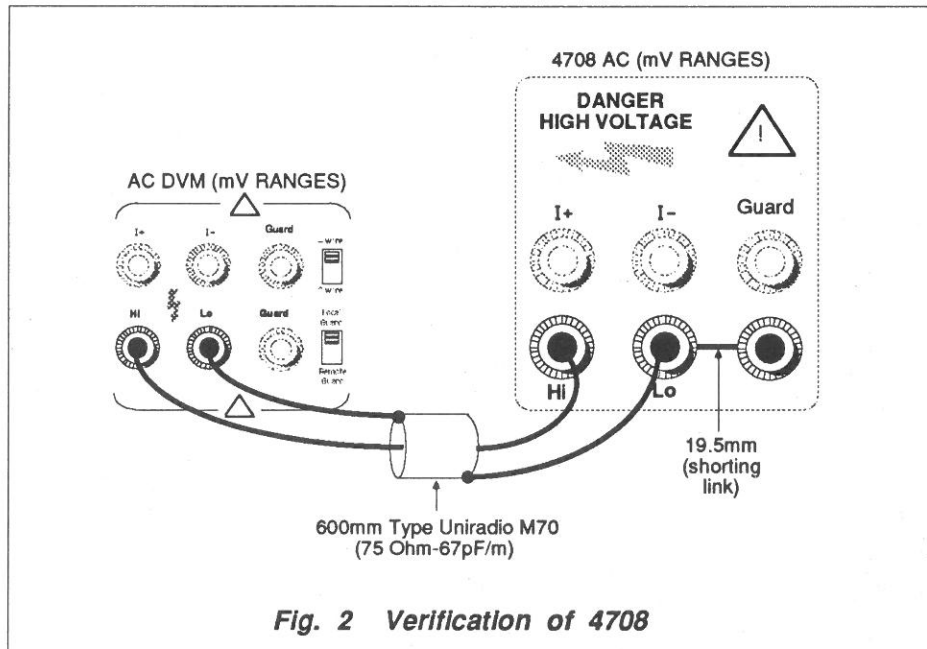

Fig. 1 Standardization of DMM

- With OUTPUT OFF, connect the 4708, IVD and DMM for Standardization (Fig. 1). Set the IVD ratio to 1:10, the AC DMM to measure 100mV.
- Set 4708 to 1V Range, 1kHz, and adjust 4708 output to value measured in RS 1 table 3(a).
- Set 4708 OUTPUT ON and note the DMM reading as 'V1'.



- d. Set 4708 OUTPUT OFF, and reconnect the test circuit for Verification (Fig. 2).
- e. Set the 4708 OUTPUT RANGE to 100mV and adjust the OUTPUT Display to 100.0000mV.
- f. Set 4708 OUTPUT ON.
Adjust OUTPUT \updownarrow keys for a DVM reading of V1.
- g. Record the 4708 OUTPUT Display setting in the last column of RS1 Table 4(a).
- h. Repeat (a) to (g), but setting the 4708, IVD ratio and DVM as required to verify the 10mV and 1mV Full Range outputs; still using the corrected 1V Full Range output at step (b). Record the results on RS1 Table 4(a).
- j. Sum the Verification setup uncertainties and record in the Us column as voltage deviations.
(Refer to Appendix 2).

Validity Tolerance Limit Calculations:
Refer to Appendix 1 page 7-A1-1, para 1.

- k. Calculate the Lower and Upper Validity Tolerance Limits:
Use Calculation A if the 4708 was last calibrated by Datron.
Use Calculation B if the 4708 was last calibrated against the standards being used for verification.
- l. The 4708 mV Full Ranges are verified if each of the 4708 OUTPUT Display settings recorded at (g) are at or between the corresponding Validity Tolerance Limits.

Millivolts (HF) Verification Procedure

(Using verified 4708 1V and 10V Ranges, 10% Range Correction Factor and AC DMM)
 Record results on Report Sheet 4708 RS 1, Table 4(b) (Page 7-34).

Full Range Checks (1mV - 100mV at 1MHz)

N.B. These verification checks are not fully traceable.

The verified output values of 1V on the 1V Range, and 10V on the 10V Range; are used to measure the 4708 linearity error at 1V on the 10V Range. From the linearity measurement a '10% of Range' Linearity and Scaling Factor 'C' is derived.

This factor is subsequently used to correct the 4708 output setting at 10% of range, to standardize a DVM for verification of the next range down.

Interconnections

FIG 1 (10V and 1V Ranges)

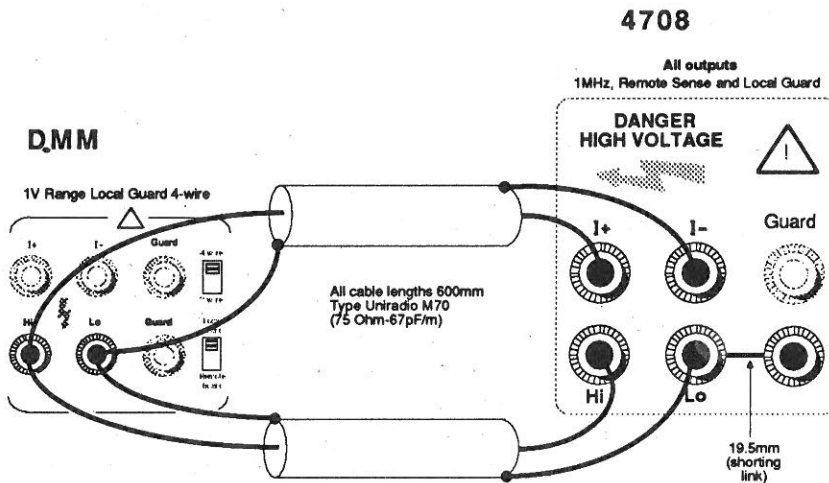
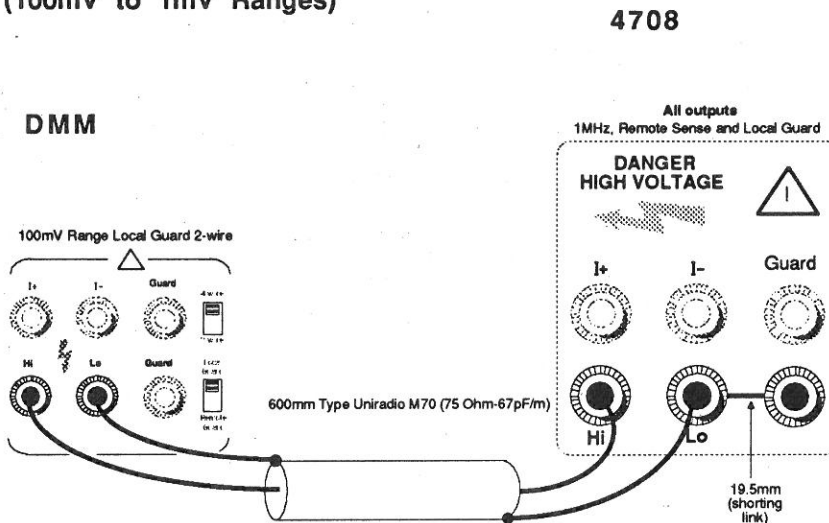

FIG 2 (100mV to 1mV Ranges)



Stage 1: Derive the Linearity and Scaling Factor 'C' as follows: (C is a number of value close to 0.1)

- a. Ensure that the Millivolts (LF) Verification has been completed.

Ensure that the 4708 has been verified at 10V and 1V HF (1MHz) Full Range (pages 7-14 and 7-15), and that the actual values are Registered on the Report Sheet RS1 Table 3(a) as 'User's DC Standard Value for Null'.

4708 10V FR setting - 10.000,00V
Actual output voltage - 'V1'

4708 1V FR setting - 1,000,000V
Actual output voltage - 'V2'

- b. Calculate 1V correction $V3' = \frac{1}{V2}$
- c. With OUTPUT OFF, connect a DVM to the 4708 terminals using the exact 4-wire connections as in Fig. 1. Set the DVM to measure AC on its 1V Range.
- d. On 4708, select the 1V Range and Remote Sense.
Set: FREQUENCY to 1MHz.
OUTPUT Display reading to V3
OUTPUT ON, and note the DVM reading as 'Vt'.
OUTPUT OFF.
- e. On 4708, select the 10V Range (Remote Sense).
Set 4708 OUTPUT Display reading to 1V.
Set OUTPUT ON.
Adjust the OUTPUT Display for a DVM reading of Vt.
- f. Note the 4708 OUTPUT Display reading as 'V4'.
Set OUTPUT OFF.
- g. From the values V1 and V4 calculate the 10V range linearity correction and scaling factor 'C' as follows:

$$C = \frac{V1 \times V4}{100}$$

Note:

The optimum resolutions quoted above the boxes in this column may not be achievable with the DVM in use. In these cases it is permissible to reduce the resolution by at most 1 digit.

Record in 6.5 digits resolution

V1 =

V2 =

V3 =

Vt is a transfer value

Vt =

Record in 6.5 digits resolution

V4 =

Calculate in 6.5 digits resolution

C =

Stage 2: To Verify the 100mV Range Full Range Output

a. Ensure that the DMM is still connected to the 4708 terminals as shown in Fig. 1.

b. Set the 4708 to the 1V Range.
Calculate the value ' $V_3 \times C$ '.
Set the OUTPUT Display to this value.

Calculate in 6.5 digits resolution

$$V_3 \times C =$$

c. Set the DMM to measure 100mV.

d. Set 4708 OUTPUT ON, allow the output to settle.
Note the DMM reading as ' $V(100t)$ '.

$V(100t)$ is a transfer value

$$V(100t) =$$

e. Set the 4708 OUTPUT OFF and reconnect the DMM to the 4708 terminals in 2-wire as shown in Fig. 2.

f. Set the 4708 to its 100mV Range.
(Remote Sense is automatically deselected.)
Set OUTPUT ON.
Adjust 4708 OUTPUT \updownarrow keys for a DMM reading of $V(100t)$.
Note the 4708 OUTPUT Display setting as ' $V(100m)$ '.

Record in 6.5 digits resolution

$$V(100m) =$$

Record this setting in the last column of RS1 table 4(b).

Stage 3: To Verify the 10mV Range Full Range Output

a. Ensure that the DMM is still connected to the 4708 terminals as shown in Fig. 2.

b. Ensure that the 4708 is set to the 100mV Range.
Calculate the value ' $V(100m) \times C$ '.
Set the OUTPUT Display to this value.

Calculate in 6.5 digits resolution

$$V(100m) \times C =$$

c. Set the DMM to measure 10mV.

d. Allow the output to settle.
Note the DMM reading as ' $V(10t)$ '.

$V(10t)$ is a transfer value

$$V(10t) =$$

e. Set the 4708 to its 10mV Range.
Adjust 4708 OUTPUT \updownarrow keys for a DMM reading of $V(10t)$.
Note the 4708 OUTPUT Display setting as ' $V(10m)$ '.

Record in 5.5 digits resolution

$$V(10m) =$$

Record this setting in the last column of RS1 table 4(b).

Stage 4: To Verify the 1mV Range Full Range Output

- a. Ensure that the DMM is still connected to the 4708 terminals as shown in Fig. 2.
- b. Ensure that the 4708 is set to the 10mV Range. Calculate the value ' $V(10m) \times C$ '. Set the OUTPUT Display to this value.
- c. Set the DMM to measure 1mV.
- d. Allow the output to settle. Note the DMM reading as ' $V(1t)$ '.
- e. Set the 4708 to its 1mV Range. Adjust 4708 OUTPUT \updownarrow keys to give a settled DMM reading of $V(1t)$. Note the 4708 OUTPUT Display setting as ' $V(1m)$ '.

Record this setting in the last column of RS1 table 4(b).

Calculate in 5.5 digits resolution

$V(10m) \times C =$

$V(1t)$ is a transfer value

$V(1t) =$

Record in 4.5 digits resolution

$V(1m) =$

Stage 5 Verification Against Limits

For Validity Tolerance Limit Calculations

Refer to Appendix 1 page 7-A1-1 para 1.

- a. Sum the Verification setup uncertainties and record in the Us column of RS1 table 2(b) as voltage deviations. (Refer to Appendix 2).
- b. Calculate the Lower and Upper Validity Tolerance Limits:
Use Calculation A if the 4708 was last calibrated by Datron.
Use Calculation B if the 4708 was last calibrated against the standards being used for verification.
- c. Each 4708 mV Full Range is verified if the 4708 OUTPUT Display settings recorded in RS1 Table 2(b) are at or between the corresponding Validity Tolerance Limits.

AC Current Verification

(100 μ A-1A Full Range Values)

Summary of Verification Procedures

Full Range Current (Using Standard Shunts)

The Thermal Transfer Current Shunt is fitted to the Shunt Input of the Thermal Transfer Standard and the 4708 set to output a Full Range current into the shunt at the required frequency (or Spot Frequency). The output current is split between the shunt and the transfer element. This is compared with the output from a Standard DC Current Source.

See Page 7-26 for the procedure.

Alternative Method

The 4708 is connected up and set to output a Full Range current into the calibrated AC Current Shunt at the required frequency (or Spot Frequency). The 4708 Current output develops a voltage across the shunt which is measured by the AC DMM, with care taken not to load the shunt.

The procedure is detailed in Appendix 5.

Interconnections

Interconnection instructions in this section are necessarily simple and basic, and are mainly intended to show connections to the 4708. It is recognized that they may need to be adapted to meet an individual user's requirements. It is assumed that users will possess knowledge of the operation and use of standards equipment such as that mentioned above.

Equipment Requirements

A DC Current Source of suitable accuracy and an AC/DC Thermal Transfer together with a set of Calibrated Thermal Transfer Current Shunts of suitable accuracy.

For the alternative method at Appendix 5, a set of calibrated AC Current Shunts of suitable value and accuracy.

Preparation

Before attempting any verification ensure that the following steps have been carried out.

1. Turn on the instrument to be checked and allow at least 2 hours warm-up in the specified environment.
2. Cancel any MODE keys, ensure OUTPUT is OFF and check that 'cal' is not present on the MODE display. (If 'cal' is present, turn the Calibration Keyswitch on the Rear Panel to its RUN position).
3. Before connecting and operating any equipment, consult the manufacturers' handbooks.
4. Self-Test: Press the 'Test' key to carry out the test routine described in Section 4. Terminate the test routine.
5. If 'Spec' Mode is required, select either 24hr, 90dy or 1yr on the Rear Panel CALIBRATION INTERVAL Switch. When received from Datron, 90dy is the relevant selection. The report sheets hold figures for this interval.

AC Current Verification Procedure

(Using Thermal Transfer, Current Shunts and DC Current Standard)

Record results on Report Sheet 4708 RS 1, Table 5 (Page 7-35).

Full Range Checks (1mA - 1A)

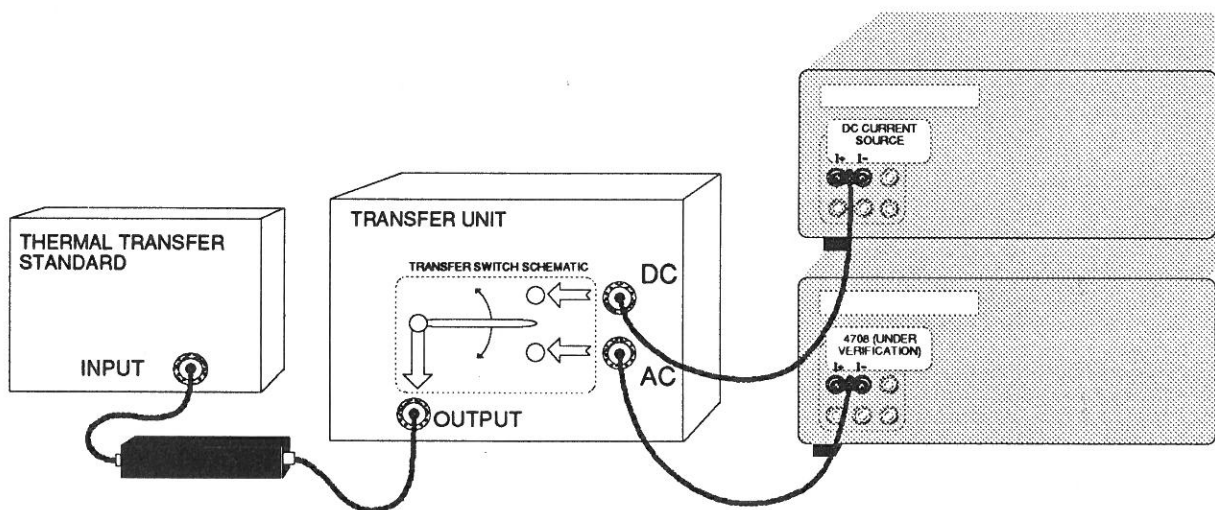

- a. With 4708 OUTPUT OFF, set the Function to I, OUTPUT RANGE to 10mA, OUTPUT Display to 10.00000mA at a Frequency of 300Hz.
- b. Configure the Thermal Transfer for 10mA Current measurement and connect the appropriate shunt between Transfer Unit and Thermal Transfer Standard.
- c. With OUTPUT OFF, connect the 4708 I+ and I- to the Transfer Unit AC input.
- d. Set the Transfer switch to 'AC'. Set 4708 OUTPUT ON, and null the Thermal Transfer to the 4708 AC OUTPUT. Set 4708 OUTPUT OFF.
- e. With OUTPUT OFF, configure the DC Current Standard for 10mA output, and connect to the Transfer Unit DC input. Set the Transfer switch to 'DC'.
- f. Set the DC Standard OUTPUT ON and adjust its output current to null the Thermal Transfer. Set its OUTPUT OFF. Record its output current on RS1 Table 5(a).
- g. Set 4708 Frequency to 5kHz, and repeat (c) to (f).
- h. Repeat (a) to (g), but for 4708 100mA and 1A Full Range outputs.
- j. If the Thermal Transfer has been adequately calibrated for 1mA transfers, repeat (a) to (g) for 4708 1mA Full Range outputs, recording the DC Standard output currents in RS1 table 5(b).
- k. Sum the Verification setup uncertainties and record in the Us column as current deviations. (Refer to Appendix 2).

Validity Tolerance Limit Calculations

Refer to Appendix 1 page 7-A1-1 Para 1

- l. Calculate the Lower and Upper Validity Tolerance Limits. Use Calculation A if the 4708 was last calibrated by Datron. Use Calculation B if the 4708 was last calibrated against the standards being used for verification.
- m. Each Full Range output verifies if the DC Current outputs recorded in (f) are at or between the corresponding Validity Tolerance Limits.

Resistance Verification

(10 Ω -100M Ω Fixed Values)

Summary of Verification Procedures

a. 4-Wire Values

The 4708 is set to 'Remote Sense'. Its four output terminals are connected to a suitable DMM, configured in '4-wire Resistance' mode. Each standard resistor is thus measured at its internal 4-wire terminals, and the DMM reading is recorded. The calibrated value present on the OUTPUT Display is also recorded; the specification tolerances and accumulated calibration uncertainties are added. The measured value is checked against this result.

The procedure is detailed on page 7-28.

b. 2-Wire Values

Remote Sense is deselected. The 4708 Hi and Lo terminals are connected to a suitable DMM, again configured in 4-wire resistance mode. Each standard resistor is thus measured at the 2-wire terminals of the 4708, and the reading is recorded. The difference between the 2-wire and 4-wire measured values is also recorded; and checked against the specification tolerances. The 2-wire zero values (including internal wiring) are similarly checked against specification tolerances.

The procedure is detailed on page 7-29.

Interconnections

Interconnection instructions in this section are necessarily simple and basic, and are mainly intended to show connections to the 4708. It is recognized that they may need to be adapted to meet an individual user's requirements. It is assumed that users will possess knowledge of the operation and use of standards equipment such as that mentioned above.

Equipment Requirements

- A DMM of sufficient accuracy, used to measure resistance.

Example: A Datron 1281 or 1081.

Alternatively:

- A ratiometric resistance-measuring device of suitable accuracy.

Preparation

Before attempting any verification ensure that the following steps have been carried out.

1. Turn on the instrument to be checked and allow at least 2 hours warm-up in the specified environment.
2. Cancel any MODE keys, ensure OUTPUT is OFF and check that 'cal' is not present on the MODE display. (If 'cal' is present, turn the Calibration Keyswitch on the Rear Panel to its RUN position).
3. Before connecting and operating any equipment, consult the manufacturers' handbooks.
4. Self-Test: Press the 'Test' key to carry out the test routine described in Section 4. Terminate the test routine.
5. If 'Spec' Mode is required, select either 24hr, 90dy or 1yr on the Rear Panel CALIBRATION INTERVAL Switch. When received from Datron, 90dy is the relevant selection. The report sheets hold figures for this interval.

Resistance Verification Procedure

Calibrated Values (10Ω to 100MΩ)

Record results on Report Sheet 4708 RS 1 (Page 7-36).

4-Wire Ohms Verification Routine:

Measurement of the values of internal resistors. This routine assumes that a DMM is used to measure the resistance values. It also assumes that if a DMM is not employed, users will have all the information required to operate their own resistance-measuring equipment.

Verification Sequence

Verify the resistors in the value sequences of RS1 Table 6, using the Verification Routine below. Refer to the diagrams for connections to the measuring equipment.

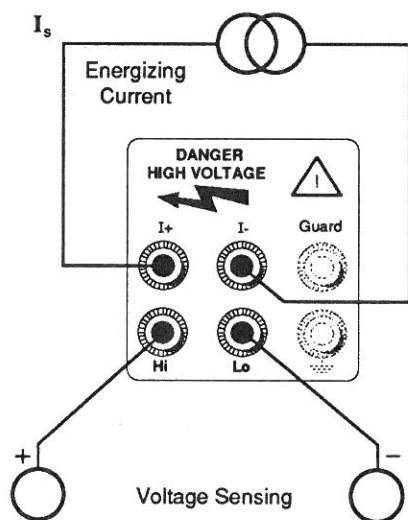

Routine for RS1 Table 6(a):

- a. 4707
 - i. Ensure OUTPUT is OFF.
 - ii. Select Ω .
 - iii. Select Remote Sense.
- b. Connect the DMM as shown in the above diagram, for direct 4-wire measurement of the value of the internal resistor only.
- c. 4707
 - i. Press the designated resistor (RANGE) key:
The previously calibrated value appears on the OUTPUT display
 - ii. Record on Table 6(a) as 'OUTPUT Display Reading (Rd)'
- d.4707 Press OUTPUT ON+.

e.DMM

- i. Measure the value of the internal resistor.
- ii. Record on Table 6(a) as 'Measured Value (Ω_m)'.

f.4708

Set OUTPUT OFF

g.Repeat (c) to (f) for each value of Table 6(a).

h.Report Sheet RS1:

- i. Sum the setup uncertainties in ppm, and record in the $\pm U_s(\text{abs})$ column (Refer to Appendix 2).
- ii. Enter any additional uncertainty due to $I_s < I < I_m$ in the $\pm U_a(\text{ppm})$ column.
- iii. Calculate and enter the Total Uncertainty in the $U_t(\text{ppm})$ column.
- iv. Calculate and enter the Upper and Lower Validity Tolerance Limits.

The 4708 verifies if each of the Measured Values (Ω_m) is at or between its Validity Tolerance Limits.

2-Wire Ohms Verification Routine:

Measurement of the values of internal resistors, plus internal wiring.

N.B. 4-wire Ω verification must be completed before verifying 2-wire Ω .

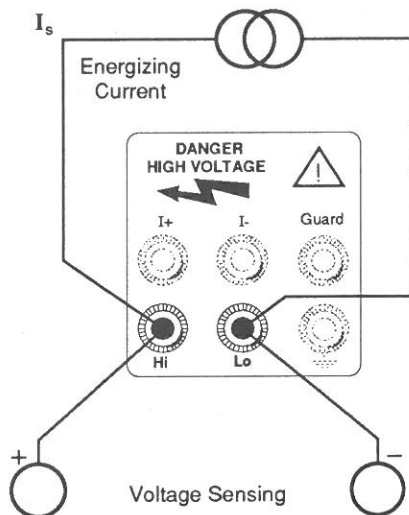

- e. 4708 Press 'Zero' key.
- f. DMM
 - i. Measure the resistance of the internal wiring.
 - ii. Record on RS1 Table 6(b) as '2-Wire Zero Value'.
- g. 4708 Set OUTPUT OFF.
- h. Repeat (c) to (g) for each value of Table 6(b).
- j. Report Sheet RS1:

Routine for RS1 Table 6(b).

- a. 4708
 - i. Ensure that OUTPUT is OFF.
 - ii. Select Ω .
 - iii. Deselect Remote Sense.
- b. Connect the DMM as shown in the above diagram, for a 4-wire measurement of the internal resistance between the Hi and Lo terminals.
- c. 4708
 - i. Press required resistor (RANGE) key.
 - ii Press OUTPUT ON+.
- d. DMM
 - i. Measure the value of the resistance between the Hi and Lo terminals.
 - ii. Record on RS1 Table 6(b) as '2-Wire Value: $\Omega_m(2)$ '.
- i. Enter the 4-Wire Measured Values (Ω_m) from Table 6(a), into their respective columns of Table 6(b), as '4-Wire Value: Ω_m '.
- ii. Calculate the 2-Wire - 4-Wire differences and enter in their corresponding columns of Table 6(b), opposite ' $[\Omega_m(2) - \Omega_m]$ '.

The 4708 2-wire Resistance Values verify if each Measured Difference is at or less than its Limit.

The 4708 2-wire Zero Values verify if each Measured Value is at or less than its Upper Limit.

Verification Report

4708 RS 1

Model 4708

Serial Number..... Calibration Interval --- 90days---... Specification --- Accuracy ---.....

Date..... Checked by..... Company/Dept.....

Note: On receipt of the instrument it is recommended to check at the values shown in the tables.

The 'Validity Tolerance'

Why is it necessary to calculate this tolerance?

It is impossible to verify the specification of an instrument with absolute certainty, even using the original calibration equipment to make measurements. All measurements carry a degree of uncertainty, this being quantified by the traceability of the measuring equipment.

The measurements attempt to verify that the instrument performs within its specification; ie. it operates within the tolerance of its accumulated uncertainties. But as the measurement itself has its own accumulated uncertainties, these must be added to those of the instrument in order to set a 'Validity Tolerance'.

If an instrument performs within its validity tolerances, all that can be assumed is that its verification is uncertain. For example; if results agree exactly with the instrument settings, the measurements are still at least as uncertain as the traceability (to absolute accuracy) of the

measuring equipment. The only certainty is that if one result exceeds its validity tolerance, then the instrument has failed to verify.

For a verification measurement to be acceptable, therefore, each validity tolerance must express a continuous trace of all the uncertainties from the instrument terminals, via 'Absolute Accuracy', to the measuring equipment connections to those terminals. The validity tolerance of the trace is obtained by adding together all the intervening uncertainties at the time the measurement is made. The specification sets out the worst-case allowances (relative tolerances) for the instrument performance. For the measuring equipment, worst-case tolerances must also be assumed. The full extent of the accumulation is illustrated below in the simplified diagram:

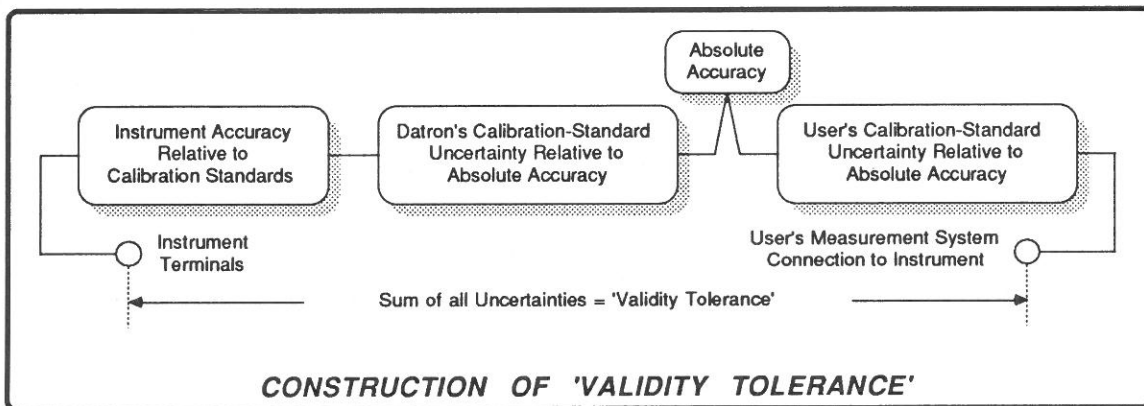

Implementation on Receipt of Instrument

The tables in this report document provide columns to enter both the relevant results of measurements and results of calculations from the measurements. Guidance is given in the form of calculation equations, where to obtain information, and tables to simplify the calculations.

Wherever appropriate and possible, the figures in the columns are already entered (90 day Specification). The recommended methods of setting up the equipment, and measuring the instrument outputs, are described in the body of Section 7.

Implementation after User-calibration

Once the instrument has been calibrated against the user's standards, then Datron's calibration-standard uncertainties can be removed from the validity tolerance calculation.

It is still necessary to include the worst-case user's calibration-standard uncertainties for the time period elapsed since the instrument was last verified or calibrated.

It is assumed that users will wish to employ their own standard report formats on these occasions.

1. DC VOLTAGE

a. Full Range Checks Validity Tolerance: Lower Limit = $L_r - U_d(\text{Abs}) - U_s(\text{Abs})$; Upper Limit = $U_r + U_d(\text{Abs}) + U_s(\text{Abs})$

4708 OUTPUT POLARITY/ RANGE	4708 OUTPUT Display Setting	Relative Accuracy Tolerance Limits		Datron Cal. Std. Uncert'y. $\pm U_d(\text{Abs})$	User's Cal. Std. Uncert'y. $\pm U_s(\text{Abs})$	Validity Tolerance Limits		User's DC Standard value for Null
		Lower(Lr)	Upper(Ur)			Lower	Upper	
+ 100 μ V	+100.00 μ V	+99.60	+100.40	0.00 μ V				
- 100 μ V	-100.00 μ V	-100.40	-99.60	0.00 μ V				
+ 1mV	+1.00000mV	+0.99960	+1.00040	.00000mV				
- 1mV	-1.00000mV	-1.00040	-0.99960	.00000mV				
+ 10mV	+10.00000mV	+9.99957	+10.00043	0.00004mV				
- 10mV	-10.00000mV	-10.00043	-9.99957	0.00004mV				
+ 100mV	+100.00000mV	+99.99930	+100.00070	0.00040mV				
- 100mV	-100.00000mV	-100.00070	-99.99930	0.00040mV				
+ 1V	+1.000000V	+9999972	1.0000028	.0000020V				
- 1V	-1.000000V	-1.0000028	-9999972	.0000020V				
+ 10V	+10.000000V	+9.999987	+10.000013	0.000015V				
- 10V	-10.000000V	-10.000013	-9.999987	0.000015V				

b. Linearity Validity Tolerance: Lower Limit = $L_r - U_d(\text{Abs}) - U_s(\text{Abs})$; Upper Limit = $U_r + U_d(\text{Abs}) + U_s(\text{Abs})$
(Performed on 10V Range)

4708 POLARITY/ NOMINAL VALUE	Relative Accuracy Tolerance Limits		Datron Cal. Std. Uncert'y. $\pm U_d(\text{Abs})$	User's Cal. Std. Uncert'y. $\pm U_s(\text{Abs})$	Validity Tolerance Limits		User's DC Standard value for Null
	Lower (Lr)	Upper (Ur)			Lower	Upper	
+ 0V	-0.000003V	+0.000003V	.000000V				
- 0V	-0.000003V	+0.000003V	.000000V				
+ 1V	+0.999996V	+1.000004V	.000002V				
- 1V	-1.000004V	-0.999996V	.000002V				
+ 10V	+9.999987V	+10.000013V	.000015V				
- 10V	-10.000013V	+9.999987V	.000015V				
+ 19V	+18.999978V	+19.000022V	.000029V				
- 19V	-19.000022V	-18.999978V	.000029V				

c. High Voltage Full Range Checks Validity Tolerance: Lower Limit = $L_r - U_d(\text{Abs}) - U_s(\text{Abs})$; Upper Limit = $U_r + U_d(\text{Abs}) + U_s(\text{Abs})$

4708 OUTPUT POLARITY/ RANGE	4708 OUTPUT Display Setting	Relative Accuracy Tolerance Limits		Datron Cal. Std. Uncert'y. $\pm U_d(\text{Abs})$	User's Cal. Std. Uncert'y. $\pm U_s(\text{Abs})$	Validity Tolerance Limits		User's DC Standard value for Null
		Lower(Lr)	Upper(Ur)			Lower	Upper	
+ 100V	+100.00000V	+99.99975	+100.00025	0.00020V				
- 100V	-100.00000V	-100.00025	-99.99975	0.00020V				
+ 1000V	+1000.0000V	+999.9965	+1000.0035	0.0020V				
- 1000V	-1000.0000V	-1000.0035	-999.9965	0.0020V				

2. DC CURRENT

Transfer Shunt Values

	100μA	1mA	10mA	100mA	1A
Preferred	10kΩ	1kΩ	100Ω	10Ω	0.1Ω

Full Range Checks

Validity Tolerance: Lower Limit = $L_r - U_d(\text{Abs}) - U_s(\text{Abs})$; Upper Limit = $U_r + U_d(\text{Abs}) + U_s(\text{Abs})$

4708 OUTPUT POLARITY/	DC Calibration Source Voltage	Relative Accuracy Tolerance Limits		Datron Cal. Std. Uncert'y.	User's Cal. Std. Uncert'y.	Calculated Total Tolerance Limits		OUTPUT Display Reading
+ 100μA		+99.9930	+100.0070	0.0009μA				
- 100μA		-100.0070	-99.9930	0.0009μA				
+ 1mA		+999970	+1.000030	.000009mA				
- 1mA		-1.000030	-.999970	.000009mA				
+ 10mA		+9.99970	+10.00030	0.00009mA				
- 10mA		-10.00030	-9.99970	0.00009mA				
+ 100mA		+99.9970	+100.0030	0.0009mA				
- 100mA		-100.0030	-99.9970	0.0009mA				
+ 1A		+999930	+1.000070	.000021A				
- 1A		-1.000070	-.999930	.000021A				

3. AC VOLTAGE (Using Adjustable DC Voltage Standard via Thermal Transfer)

4708 OUTPUT RANGE/ FREQUENCY	4708 Nominal OUTPUT Voltage	Wideband RelativeAccuracy Tolerance Limits		Datron Cal. Std. Uncert'y. ±Ud(Abs)	User's Cal. Std. Uncert'y. ±Us(Abs)	Validity Tolerance Limits		User's DC Standard value for Null
		Lower(Lr)	Upper(Ur)			Lower	Upper	

a. Full Range Checks - 1V to 1000V Ranges.

1V	1kHz	1.000000V	.999960	1.000040	.000020V			
1V	1MHz	1.000000V	.998500	1.001500	.000300V			
10V	1kHz	10.00000V	9.99960	10.00040	0.00020V			
10V	1MHz	10.00000V	9.98500	10.01500	0.00300V			
100V	1kHz	100.0000V	99.9950	100.0050	0.0020V			
100V	100kHz	100.0000V	99.9880	100.0120	0.0050V			
1000V	1kHz	1000.000V	999.890	1000.110	0.030V			
1000V	30kHz	1000.000V	999.850	1000.150	0.050V			

b. Linearity (Performed on 10V Range)

10V	1kHz	1.00000V	0.99987	1.00013	0.00002V			
10V	1kHz	10.00000V	9.99960	10.00040	0.00020V			
10V	1kHz	19.00000V	18.00933	19.00067	0.00038V			

4. AC MILLIVOLTS 1mV to 100mV Ranges

4708 OUTPUT RANGE/ FREQUENCY	4708 Nominal OUTPUT Voltage	Wideband RelativeAccuracy Tolerance Limits		Datron Cal. Std. Uncert'y. ±Ud(Abs)	User's Cal. Std. Uncert'y. ±Us(Abs)	Validity Tolerance Limits		4708 OUTPUT Display Setting
		Lower(Lr)	Upper(Ur)			Lower	Upper	

a. LF 1kHz (Using Verified 1V Full Range, Inductive Voltage Divider and AC DVM)

100mV	100.0000mV	99.9860	100.00140	0.0040mV			
10mV	10.0000mV	9.9941	10.0059	0.0013mV			
1mV	1.0000mV	.9950	1.0050	.0010mV			

b. HF 1MHz (Using Verified 1V and 10V Full Range, 10% Range Correction and AC DVM)

100mV	100.0000mV	99.7250	100.2750	0.0460mV			
10mV	10.0000mV	9.9545	10.0455	0.0055mV			
1mV	1.0000mV	.9774	1.0226	0.0015mV			

5. AC CURRENT

4708 OUTPUT RANGE/ FREQUENCY	Transfer Shunt Value	Wideband Relative Accuracy Tolerance Limits		Datron Cal. Std. Uncert'y. ±Ud (Abs)	User's Cal. Std. Uncert'y. ±Us (Abs)	Validity Tolerance Limits		User's DC Standard value for Null
		Lower (Lr)	Upper (Ur)			Lower	Upper	

Full Range Checks

Validity Tolerance: Lower Limit = $Lr - Ud(Abs) - Us(Abs)$; Upper Limit = $Ur + Ud(Abs) + Us(Abs)$
 [Us(Abs) must include the relative uncertainties of the DC Voltage Source, Transfer Shunt and Thermal Transfer]

a. 10mA to 1A Ranges. (Using Thermal Transfer, Current Shunts and DC Current Standard)

10mA 300Hz		9.99870	10.00130	0.00100mA				
10mA 5kHz		9.99820	10.00180	0.00100mA				
100mA 300Hz		99.9870	100.0130	0.0100mA				
100mA 5kHz		99.9820	100.0180	0.0100mA				
1A 300Hz		.999690	1.000310	.000100A				
1A 5kHz		.999520	1.000480	.000100A				

b. 1mA Range. (If Thermal Transfer is calibrated at this level)

1mA 300Hz		.999870	1.000130	.000100mA				
1mA 5kHz		.999820	1.000180	.000100mA				

6. RESISTANCE

a. 4-Wire 'Remote' Connection

Energizing Current Values	100MΩ	10MΩ	1MΩ	100kΩ	10kΩ	1kΩ	100Ω	10Ω
Specified (Is)	1μA	1μA	10μA	100μA	100μA	1mA	10mA	10mA
Maximum (Im)	10μA	10μA	100μA	1mA	2.5mA	10mA	25mA	100mA
Actual (I)								

Additional Uncertainties (Ua) for I: where Is < I < Im; are given on page 6-12.

Validity Tolerance: Total Uncertainty (Ut) = Ar + Ud(Abs) + Us(Abs) + Ua

$$\text{Lower Limit} = R_d - \frac{(R_d \times U_t)}{10^6}$$

$$\text{Upper Limit} = R_d + \frac{(R_d \times U_t)}{10^6}$$

4708 RANGE	Accuracy Rel. to Cal. Stds. (23°C ± 1°C) ±Ar (ppm)	Datron Cal. Std. Uncert'y ±Ud(Abs) (ppm)	User's Cal. Std. Uncert'y ±Us(Abs) (ppm)	Additional Uncert'y due to Is < I < Im ±Ua (ppm)	OUTPUT Display Reading Rd	Validity Tolerance			Measured Value
						Total Uncert'y ±Ut (ppm)	Lower Limit	Upper Limit	
100MΩ	30	50							
10MΩ	25	17							
1MΩ	10	12							
100kΩ	3	6							
10kΩ	3	4							
1kΩ	3	5							
100Ω	3	5							
10Ω	10	10							

b. 2-Wire 'Local' Connection

The additional resistance of the internal 2-wire connections should not exceed the following:

10Ω to 1MΩ Ranges: 1.999Ω

At 'Zero' on the 10Ω to 1MΩ Ranges: 0.900Ω

Thus the measured 2-wire resistance values should lie between Rd and the values given in the following table. The upper 2-wire zero limits are given in the lower table.

		1MΩ	100kΩ	10kΩ	1kΩ	100Ω	10Ω
2-Wire Value: Rd(2)	Measured						
4-Wire Value: Rd	Measured						
Difference [Rd(2) - Rd]	Limit	.000,001,9M	0.001,99k	0.001,999k	.001,999k	1.999Ω	1.999Ω
	Measured						

		1MΩ	100kΩ	10kΩ	1kΩ	100Ω	10Ω
2-Wire Zero Value	Upper Limit	.000,000,9M	0.000,90k	0.000,900k	.000,900k	0.900Ω	0.900Ω
	Measured						

Validity Tolerance Limit Calculations

Appendix 1 to:
4708 User's Handbook
Section 7

This appendix lists the calculations necessary to determine the Validity Tolerance Limits for each of the verification procedures. Reference to the appropriate calculation is given in each procedure.

1. Verification at Full Range Values

(where Upper and Lower Relative Accuracy Limits are given on the Report Sheet).

The abbreviations have the following meanings, expressed directly as voltages or currents.

Lr = Lower Wideband Accuracy Tolerance Limit, relative to Cal. Standards;

Ur = Upper Wideband Accuracy Tolerance Limit, relative to Cal. Standards;

Ud = Ud(Abs) = Datron Cal. Standard Uncertainty.

Us = Us(Abs) = User's Cal. Standard Uncertainty.

A. On Receipt from Datron:

For each 4708 OUTPUT Value/Frequency selection calculate the Validity Tolerance Limits as follows:

$$\begin{aligned}\text{Lower Limit} &= \text{Lr} - \text{Ud} - \text{Us} \\ \text{Upper Limit} &= \text{Ur} + \text{Ud} + \text{Us}\end{aligned}$$

Enter the results as Lower and Upper Validity Tolerance Limits respectively.

B. Following User Calibration:

For each 4708 OUTPUT Value/Frequency selection calculate the Validity Tolerance Limits as follows:

$$\begin{aligned}\text{Lower Limit} &= \text{Lr} - \text{Us} \\ \text{Upper Limit} &= \text{Ur} + \text{Us}\end{aligned}$$

Enter the results as Lower and Upper Validity Tolerance Limits respectively.

2. Post-Calibration Verification Calculation

(using the instrument Spec. Mode 'ppm' or '%' Readout).

This calculation can be used to verify the instrument after calibration, with the CALIBRATION INTERVAL switch on the rear panel set as detailed below. (The instrument provides a 24-hour 'Stability' readout in Spec Mode, under the same conditions used for calibration. At this interval, Datron's uncertainty is not included in the readout.)

Convert any '%' readout figures into ppm tolerance values before performing the calculation:

$$\text{Ur} = \text{Ur(ppm)} = \text{Tolerance in ppm} = 10^4 \times \text{Readout in \%}$$

Other abbreviations used for these calculations:

Us = Us(ppm) = User's Cal. Standard Uncertainty

Ud = Ud(ppm) = Datron's Cal. Standard Uncertainty (as quoted in the specifications of Section 6).

Ut = Ut(ppm) = Calculated Validity Tolerance in ppm.

V = Required instrument output Value of voltage or current.

A. For CAL. INTERVAL 24Hr

$$\text{Ut} = \text{Ur} + \text{Us}$$

B. For CAL. INTERVAL 90Dy or 1Yr

$$\text{Ut} = \text{Ur} + \text{Us} - \text{Ud}$$

C. Obtain Ut from (A) or (B)

and calculate the Validity Tolerance Limits:

$$\text{Lower Limit} = \frac{\text{V} - (\text{V} \times \text{Ut})}{10^6}$$

$$\text{Upper Limit} = \frac{\text{V} + (\text{V} \times \text{Ut})}{10^6}$$

Uncertainty and Traceability

Appendix 2 to:
4708 User's Handbook
Section 7

Cumulative Tolerances

If an instrument was correctly calibrated against the factory standard at its uncertainty limit, and then verified against a user's standard, also at its limit; there are two extremes to the range of traceable results which could be obtained. If, for example, both standards' traceable errors were equal and in the same sense, the instrument would appear to verify as absolutely accurate. But if the errors were in opposite sense, it could appear to be inaccurate by the sum of the two limits of uncertainty.

In the following numerical example, a 4708 is verified in the factory at 10V, on the 10V DC Range, and with 0ppm error against a 5ppm-high standard (relative to Absolute Accuracy):

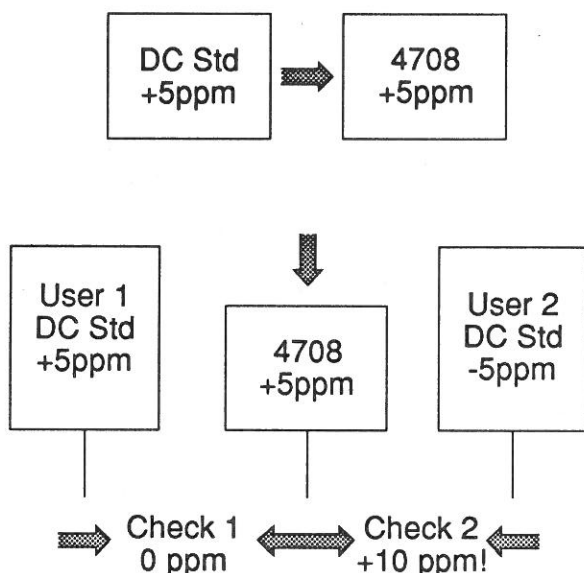

It remains correctly calibrated, and could be delivered to one of two users: one user's standard is 5ppm higher than Absolute, and the other's is 5ppm lower.

Despite the instrument sustaining its original accuracy of +5ppm, and the standards all being within 5ppm of Absolute; the first user would verify the 4708 as having 0ppm error, but the second would obtain an error of +10ppm.

The increased uncertainty is unavoidable unless the same standard is used for each verification. This is clearly not a practical proposition following delivery. But after the first autocalibration against the user's standard, Datron's calibration uncertainty no longer applies.

Verification Uncertainties

Each element in the calibration traceability chain (on the next page) contributes its uncertainty to influence the overall verification tolerance limits. All uncertainties must be accounted for when calculating the total tolerances.

In addition, if two separate systems are used, one for calibration and the other for verification, then the cumulative total tolerance ('Validity Tolerance') is the sum of those established for each system (as described earlier).

Thus on receipt of the 4708, Datron's uncertainties must be included in the total tolerance limits; but when verifying against the same Standards setup used to calibrate the instrument, they are excluded.

Two formulae for calculating the total tolerance limits are given for each procedure, covering the two types of verification occasions mentioned.

Validity Tolerance Limit Calculations

The 4707 is verified by comparing its output with the Validity (Total) Tolerance Limits. These are calculated by summing the appropriate uncertainties from the traceability chain, and expressing the result in upper and lower absolute deviations from the chosen verification value. The 4708 checks out if its measured output is between the limits.

Where possible, the 4708 specification and Datron calibration uncertainties are given in a form suitable for calculation (see Report Sheet RS1). Where this is not possible they can be assembled from the specifications in Section 6, and in some cases can be more easily obtained using Spec Mode (refer to Appendix 1).

User's uncertainties need to be assembled and included, expressed in the form appropriate to the calculations.

Whereas Datron's uncertainties are normally included in the calculations only once (on receipt), user's uncertainties must always be included. So it is sensible to provide a permanent record, eg on Report Sheets.

Once the relevant uncertainties have been entered on the Report Sheet, the Validity Tolerance Limits can be calculated. The correct calculations are identified in the individual procedures.

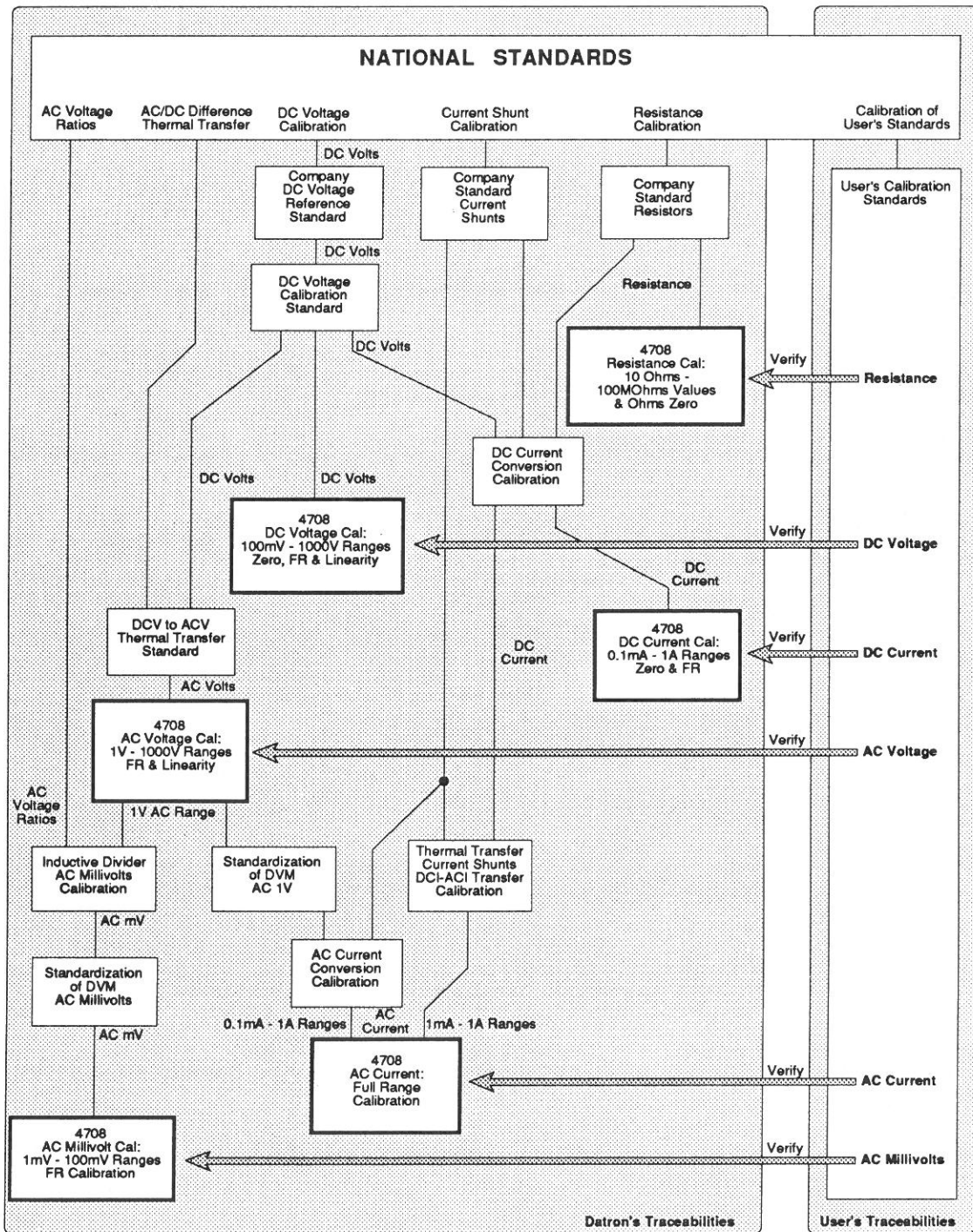

4708 - RECOMMENDED VERIFICATION PROCEDURES - Calibration Traceability Chart

General Procedural Information

Appendix 3 to:
4708 User's Handbook
Section 7

Notes on the use of the Null Detector (DC Voltage Ranges)

The null detector is normally connected in series with the 4708 Hi lead. A high-impedance-input device should be chosen to reduce off-null currents due to differences in the outputs of the DC voltage source and the 4708. A battery-operated instrument is preferred to ensure adequate isolation.

Some null detectors possess high input impedance only when their readings are on-scale, so care should be taken to ensure that drain currents from the DC Voltage source do not become excessive. This applies particularly if the DC source is a standard cell or a bank of cells. Six points are important:

1. The null detector should be connected to the 4708 (or 4708 load resistor) only when the 4708 OUTPUT OFF LED is lit. (With Output OFF, the I+, I-, Hi and Lo terminals are at high impedance).
2. Always set the null detector to its lowest sensitivity before connecting up, and increase sensitivity only when the voltages output by the DC Voltage source and the 4708 are close in value.
3. Do not change polarity of the 4708 or DC Voltage source without first switching the 4708 OUTPUT OFF. Care must be taken to ensure that the correct-polarity ON key is pressed, to avoid excessive voltages being connected across the null detector, particularly when checking the 4708 directly against a standard cell.
4. Most Null Detectors are equipped with a 'Self-zero' or 'Zero-check' facility. For maximum accuracy, the Null Detector range zero should be checked before each nulling operation is performed. However, when verifying the 4708 Voltage ranges, the zero offset of the DC Standard voltage source is nullified by adjustment of the Null Detector zero control. This setting should not be altered until the corresponding range gain has been verified.
5. **WARNING**
During Performance checks and calibration a common mode voltage equal to the full range voltage is present at the Null Detector input terminals. On 1000V checks this voltage is potentially lethal, so **EXTREME CAUTION** must be observed when making adjustments to the null detector sensitivity.
6. **CAUTION**
The Null Detector used must be able to withstand voltages up to 1200V between its input terminals. Such voltages will be present during the time that the 4708 is ramping from zero to 1000V Full Range after setting OUTPUT ON. Inadvertent disconnection of the Precision Divider terminals can transfer full output across the Null detector.

Thermal Transfer

(AC Voltage Ranges)

The Thermal Transfer Standard is connected between the DC Voltage Source and the 4708.



A 4-wire sense connection will reduce inaccuracies due to differences in the output impedances of the DC voltage source and the 4708.

Four points are important:

1. Start with OUTPUT OFF.

The 4708 should be connected to the Thermal Transfer Standard only when the 4708 OUTPUT OFF LED is lit. (With Output OFF, the I+, I-, Hi and Lo terminals are at high impedance).

2 Sensitivity.

Always set the Thermal Transfer Standard to its lowest sensitivity before connecting up. Increase sensitivity when necessary to obtain the required input level.

3 WARNING

During Performance checks and calibration the full range voltage is present at the Thermal Transfer Standard input terminals. On 1000V checks this voltage is potentially lethal, so **EXTREME CAUTION** must be observed when making adjustments to the Thermal Transfer Standard sensitivity.

4 CAUTION

The Thermal Transfer Standard used must be able to withstand peak voltages up to 1600V between its input terminals. Such voltages may be present during the time that the 4708 is ramping from zero to 1100V Full Scale after setting OUTPUT ON.

Notes on the 4708

1. Local/Remote Sense

Remote Sense is available as follows:

1V 10V 100V 1000V - Local/Remote Sense
1mV 10mV 100mV - Local Sense only
All Current Ranges - not applicable

Local = Remote Sense LED OFF - 2-Wire Sense
Remote = Remote Sense LED ON - 4-Wire Sense

OUTPUT must be OFF to change Sense connection (except that Remote changes automatically to Local when switching to Millivolt Ranges).

2. Up-ranging - OUTPUT OFF Default.

The 4708 cannot enter High-Voltage State (>75V) with OUTPUT ON. Consequently, when ranging-up, the operating system allows the up-ranging to occur, but defaults to OUTPUT OFF for two specific cases:

- a. When up-ranging to the 1000V Range,
- b. When up-ranging to the 100V Range to a voltage of 75V or more.

In H-V state an audible warning is provided.

Otherwise, OUTPUT remains ON when changing OUTPUT RANGE.

Other Useful Features

Although not essential to normal verification, the following additional facilities can sometimes simplify procedures:

FREQUENCY Store: Refer to Section 4 page 4-9,

'Spec' Mode: Refer to Section 4 page 4-10,

'Error' Mode: Refer to Section 4 page 4-12,

'Offset' Mode: Refer to Section 4 page 4-12.

Notes on Resistance Verification

Calibrated Values (10 Ω - 100M Ω)

For each resistance (RANGE) selection, three checks are required:

- a. 4-wire at Full Range (Resistor Value).
- b. 2-wire at Full Range (Resistor plus internal wiring)
- c. 2-wire at Zero (Internal wiring only)

Interconnections

For 4-wire connections in Remote Sense, only the value of the internal Standard Resistor is measured.

In Local Sense, a 4-wire method is used to exclude the resistance of the external leads from the measured value.

Calibration Memory

In Ω function, each RANGE key selects a nominal value standard resistor. Routine adjustment of the resistor is not necessary.

During calibration the actual value is measured and stored in the calibration memory to be displayed whenever that range is selected. Separate memory stores exist for Remote Sense (4-wire), Local Sense (2-wire) and Local Sense zero.

The displayed values were obtained at the most recent calibration, except for the 10M Ω and 100M Ω Zero and Full Range values in 2-wire, which because of their minute fraction merely repeat the 4-wire figures.

Use of HI and Lo Terminals In 2-Wire Ω .

For the Ω function, the Remote Sense key does not change any internal analog wiring, so with Remote Sense deselected, the I+ and I- terminals remain connected to the internal resistors. The key is thus used only to select the appropriate calibration memory, for data to display in 'Spec' Mode. To obtain the value entered when a resistor was calibrated in 4-wire, it is necessary for the key LED to be lit; but for 2-wire it must be unlit.

When values are entered during calibration, the 2-wire figures are the results of 4-Wire measurements at the Hi and Lo terminals, NOT the I+ and I- terminals. Verification check figures are therefore only valid if they are obtained from measurements under identical conditions; that is from 4-wire connections to the Hi and Lo terminals, with the Remote Sense LED unlit, as described in the procedures.

4-Wire Limits

The values measured in 4-wire Remote Sense do not include the resistance of internal or external wiring.

The 4708 accepts any value within ± 200 ppm of nominal as a valid calibration.

For verification, the measured values are not compared against the nominal value, but against the previously calibrated value presented on the OUTPUT Display.

2-Wire Limits

The values measured in 2-wire Local Sense are greater than for 4-wire Remote Sense, as they include the resistance of internal wiring and relay contacts.

The 4708 will not accept any 2-wire value less than the stored value for 4-wire, so the 4-wire Remote Sense calibration or verification is always carried out before attempting 2-wire Local Sense.

The extra internal resistance varies between Ranges, so the 4708 accepts values up to the limits as listed in RS1 Table 3 (b) as valid 2-wire calibrations.

When verifying, the measured 2-wire values are not compared against the displayed value, but against limits above the previously-measured 4-wire value.

Further Procedural Information

4708 Specification Formats

The specifications can be found in two forms:

a. Tabular layout as in Section 6.

In Section 6, the stability and relative accuracy specifications alone describe the true performance of the instrument in a form which can be made traceable to National Standards merely by adding in the uncertainty of the reference standard used for checking. Datron's calibration uncertainty is shown in a separate column. This must be added, to obtain true traceable accuracy for all instruments which were last calibrated by Datron. For instruments calibrated by other agencies, their own calibration uncertainty must be added instead.

b. Specifications stored within the instrument's non-volatile memory.

(Refer to Section 4 page 4-11 to 4-12)
The instrument's non-volatile memory figures can be accessed using 'Spec' Mode. These are compiled specifically for users without verification facilities, so that they can obtain the tolerance limits of the 4708 output, without referring to Section 6. The position of the CAL INTERVAL switch on the rear panel selects the readout for the intervals listed below. The '90-day' and '1-year' readouts always include Datron's own calibration uncertainty, giving traceable accuracies for instruments which were last calibrated by Datron.

24hr CALIBRATION INTERVAL
24 Hours Stability figure only, relative to Calibration Standards.

90dy CALIBRATION INTERVAL
90 Days Relative Accuracy figure plus Datron's Calibration Uncertainty.

1yr CALIBRATION INTERVAL
1 Year Relative Accuracy figure plus Datron's Calibration Uncertainty.

Verification Conditions

The **24-hour stability specifications** are relative to user's reference standards. In all cases validity depends on using the same standard as reference, under the same conditions, including temperature. Also, verification is valid only within 24 hours of calibration or within 24 hours of a previous verification. In the latter case, the specifications are relative to the figures obtained at the earlier verification.

On Receipt, the 90-day and 1-year tolerances can be calculated by adding both the user's reference standard absolute uncertainty and Datron's calibration uncertainty to the Relative Accuracy figure (See the Report Sheets).

Following User Calibration or a Previous Verification, add only the user's uncertainty to the Relative Accuracy figure.

Where ambient temperatures are outside the Specified range, temperature coefficient correction should be taken into account.

Appendix 2 describes the uncertainties inherent in any verification process. Worst-case figures must always be assumed, although accumulated uncertainty is generally much less than implied.

Report Sheets

Please use the printed report sheets as masters to generate duplicate copies, then record the instrument's performance on the duplicates (both on receipt from Datron and for future periodic checks).

The report sheets list the appropriate accuracy limits (relative to Calibration Standards) and Datron's calibration uncertainty at the verification points. Blank columns are provided for the user's calibration uncertainty, the cumulative 'Validity' tolerance limits, and the DC Voltage Standard's adjusted reading (for comparison with the tolerance).

Page 1 of Report Sheet RS1 is assigned to guidance for those users who are unfamiliar with the Verification process.

The appropriate limit calculations appear in Appendix 1.

Alternative AC Millivolts Verification

LF (1kHz) and HF (100kHz)

(1mV - 100mV Full Range Values).

Appendix 4 to:
4708 User's Handbook
Section 7

Summary of Verification Procedures

At both LF and HF, the 1V Full Range value is first verified using thermal transfer, then this voltage is divided via a wideband IVD to standardize an AC DMM at the millivolt Full Range value. The 4708 millivolt range is then verified at this standardized value by DMM measurement.

Equipment Requirements

- A Wideband Inductive Voltage Divider tapped at 10:1, 100:1 and 1000:1 of suitable accuracy and frequency response.
- The DC Voltage Source used for 1V - 1000V ranges
- The AC/DC Thermal Transfer used for 1V - 1000V ranges.
- A DMM of suitable accuracy and frequency response.

Example:
Datron 1281 or 1081.

Interconnections

Interconnection instructions in this section are necessarily simple and basic, and are mainly intended to show connections to the 4708. It is recognized that they may need to be adapted to meet an individual user's requirements. It is assumed that users will possess knowledge of the operation and use of standards equipment such as that mentioned above.

Preparation

Before attempting any verification ensure that the following steps have been carried out.

1. Turn on the instrument to be checked and allow at least 2 hours warm-up in the specified environment.
2. Cancel any MODE keys, ensure OUTPUT is OFF and check that 'cal' is not present on the MODE display. (If 'cal' is present, turn the Calibration Keyswitch on the Rear Panel to its RUN position).
3. Before connecting and operating any equipment, consult the manufacturers' handbooks.
4. Self-Test: Press the 'Test' key to carry out the test routine described in Section 4. Terminate the test routine.
5. If 'Spec' Mode is required, select either 24hr, 90dy or 1yr on the Rear Panel CALIBRATION INTERVAL Switch. When received from Datron, 90dy is the relevant selection. The report sheets hold figures for this interval.

Millivolts (LF & HF) Verification Procedure

(Using verified 4708 1V Range, Wideband Inductive Voltage Divider (WIVD) and AC DMM).
Record results on Report Sheet RS2, (Page 7-A4-2)

Full Range Checks (1mV - 100mV), LF (1kHz) and HF (100kHz).

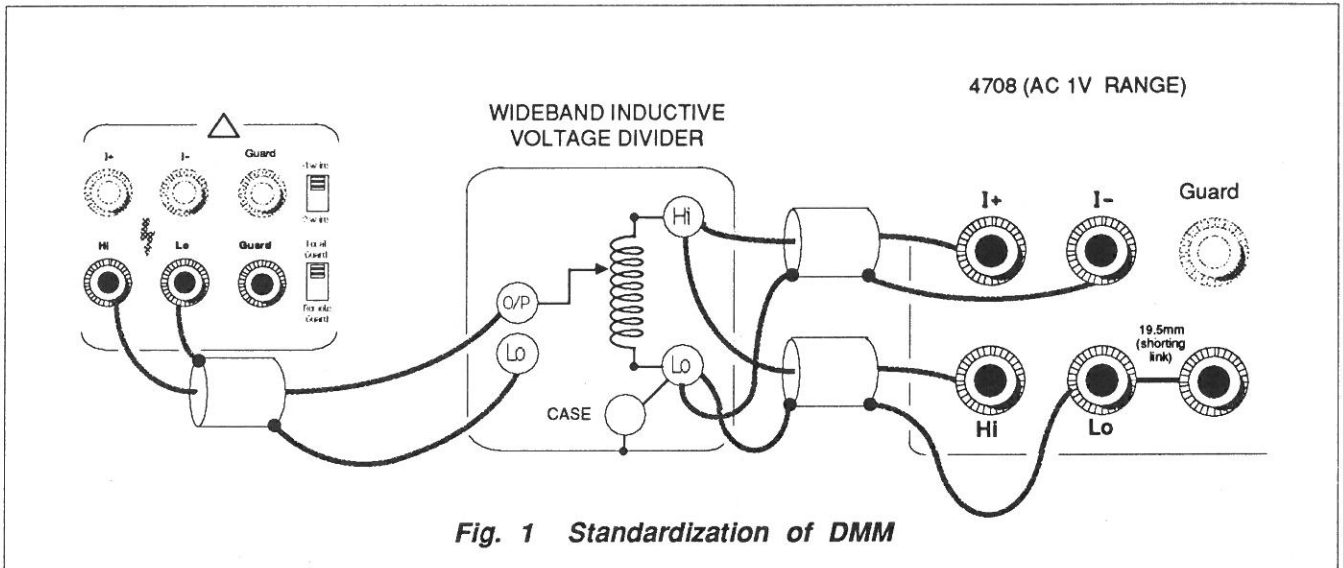

- With OUTPUT OFF, connect the 4708, WIVD and DMM for Standardization (Fig. 1). Set the WIVD ratio to 1:1000, the AC DMM to measure 1mV.
- Set 4708 to 1V Range, 1kHz, and adjust for corrected 1.000000V output.
- Set 4708 OUTPUT ON.
Note the DMM reading as V1.
- Set 4708 OUTPUT OFF.

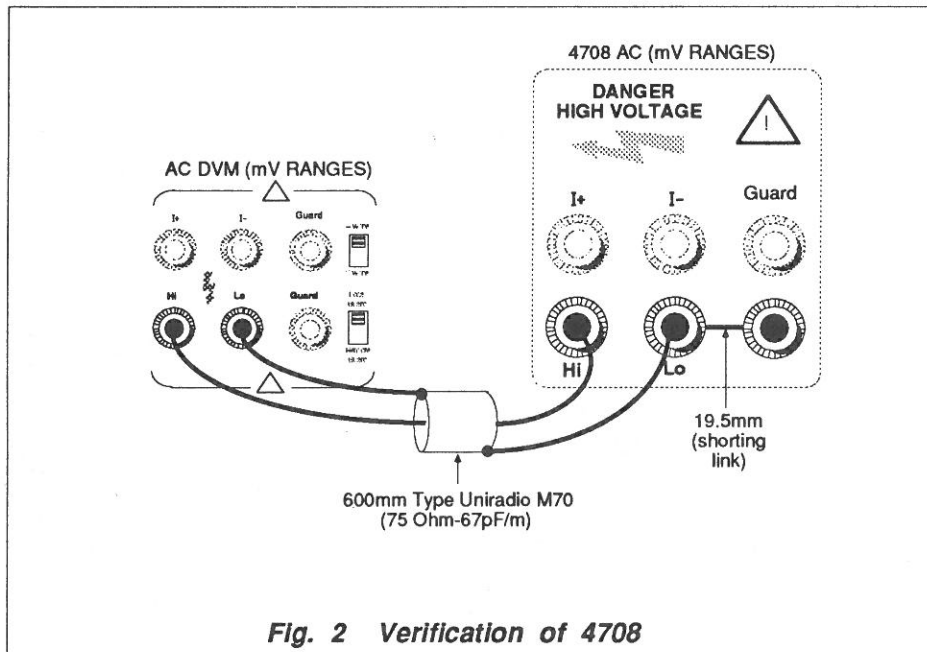

- e. Reconnect the test circuit for Verification. Set the 4708 OUTPUT RANGE to 1mV and adjust the OUTPUT Display to 1.0000mV.
- f. Set 4708 OUTPUT ON.
Adjust OUTPUT $\uparrow\downarrow$ keys for a DMM reading of V1.
- g. Record the 4708 OUTPUT Display setting in the last column of RS2.
- h. Repeat (a) to (g), but setting the 4708 frequency to 100kHz.
- j. Set the WIVD ratio and DMM as required to verify the 10mV and 100mV Full Range outputs; still using the corrected 1V Full Range output in (b). Record the results on RS2.
- k. Sum the Verification setup uncertainties and record in the Us column as voltage deviations.
(Refer to Appendix 2).

Total Tolerance Limit Calculations

Refer to Appendix 1 page 7-A1-1, para 1.

- l. Calculate the Lower and Upper Total Tolerance Limits:
Use Calculation A if the 4708 was last calibrated by Datron.
Use Calculation B if the 4708 was last calibrated against the standards being used for verification.
- m. Each 4708 mV Full Range verifies if the 4708 OUTPUT Display readings recorded in (g) are at or between the corresponding Validity Tolerance Limits.

Verification Report

4708 RS 2

Model 4708

Serial Number..... Calibration Interval --- 90days---... Specification --- Accuracy ---.....

Date..... Checked by..... Company/Dept.....

Notes: On receipt of the instrument it is recommended to check at the values shown in the tables.

For a description of 'Validity Tolerance' refer to Verification Report Sheet RS1.

AC MILLIVOLTS; Full Range Outputs 1mV to 100mV Ranges

Validity Tolerance: Lower Limit = $Lr - Ud(Abs) - Us(Abs)$; Upper Limit = $Ur + Ud(Abs) + Us(Abs)$

4708 OUTPUT RANGE/ FREQUENCY	4708 Nominal OUTPUT Voltage	Wideband RelativeAccuracy Tolerance Limits		Datron Cal. Std. Uncert'y. $\pm Ud(Abs)$	User's Cal. Std. Uncert'y. $\pm Us(Abs)$	Validity Tolerance Limits		4708 OUTPUT Display Setting
		Lower(Lr)	Upper(Ur)			Lower	Upper	
1mV 1kHz	1.0000mV	.9950	1.0050	0.0010mV				
1mV 100kHz	1.0000mV	.9947	1.0053	0.0013mV				
10mV 1kHz	10.0000mV	9.9941	10.0059	0.0013mV				
10mV 100kHz	10.0000mV	9.9921	10.0079	0.0045mV				
100mV 1kHz	100.0000mV	99.9860	100.0140	0.0040mV				
100mV 100kHz	100.0000mV	99.9660	100.0340	0.0360mV				

Alternative AC Current Verification

(100 μ A-1A Full Range Values)

Appendix 5 to:
4708 User's Handbook
Section 7

Summary of Verification Procedures

Full Range Current (Using Calibrated Standard Shunts)

The procedure is carried out first at LF (300Hz), then at HF (5kHz) for each range in turn, using the appropriate standard current shunt.

An AC DMM is standardized to the verified and corrected 1V Full Range output of the 4708, via a unity-gain buffer.

The 4708 is set to output a Full Range current into the calibrated AC Current Shunt at the required frequency. The current output develops a voltage across the shunt which is measured by the standardized DMM, using the same buffer to avoid loading the shunt.

After accounting for the setup uncertainties, the measured current is compared against the specification limits.

Interconnections

Interconnection instructions in this section are necessarily simple and basic, and are mainly intended to show connections to the 4708. It is recognized that they may need to be adapted to meet an individual user's requirements. It is assumed that users will possess knowledge of the operation and use of standards equipment such as that mentioned above.

Equipment Requirements

- A set of calibrated AC Current Shunts of suitable value and accuracy.
- A buffer with unity gain verified at 300Hz and 5kHz.
- A DMM of suitable accuracy.
Example: Datron 1281 or 1081, in 'Compute' Mode.

Preparation

Before attempting any verification ensure that the following steps have been carried out.

1. Turn on the instrument to be checked and allow at least 2 hours warm-up in the specified environment.
2. Cancel any MODE keys, ensure OUTPUT is OFF and check that 'cal' is not present on the MODE display. (If 'cal' is present, turn the Calibration Keyswitch on the Rear Panel to its RUN position).
3. Before connecting and operating any equipment, consult the manufacturers' handbooks.
4. Self-Test: Press the 'Test' key to carry out the test routine described in Section 4.
Terminate the test routine.
5. If 'Spec' Mode is required, select either 24hr, 90dy or 1yr on the Rear Panel CALIBRATION INTERVAL Switch. When received from Datron, 90dy is the relevant selection. The report sheets hold figures for this interval.

Alternative AC Current Verification Procedure

(Using verified 4708 1V Range, Calibrated Standard AC Shunts and AC DMM).
Record results on Report Sheet RS3 (Page 7-A5-4).

Full Range Checks (100 μ A - 1A)

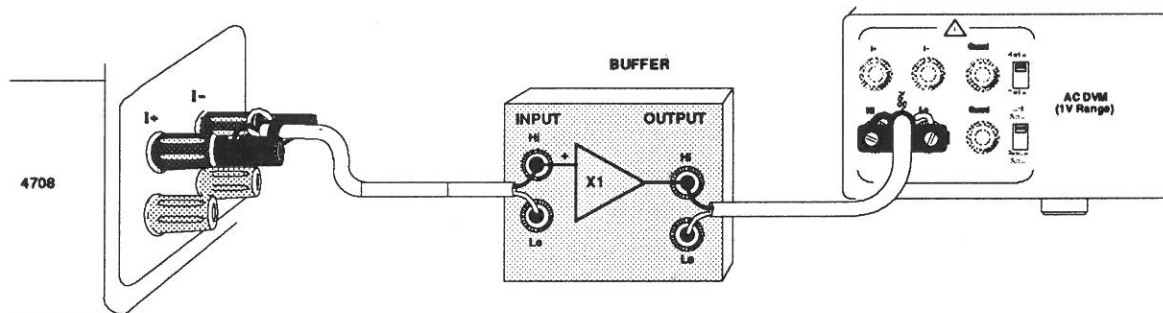

Standardization of DMM 1V Range

- a. Set the 4708 Frequency to 300Hz.
- b. With OUTPUT OFF, connect the 4708 and DMM for Standardization. Select 1V Range on the AC DMM.
- c. Set the 4708 to its 1V Range and adjust for corrected 1.000000V output as verified.
- d. Set 4708 OUTPUT ON and note the DMM reading as V1.
- e. Set 4708 OUTPUT OFF. Set its OUTPUT RANGE to 100 μ A and adjust the OUTPUT Display to 100.0000 μ A.

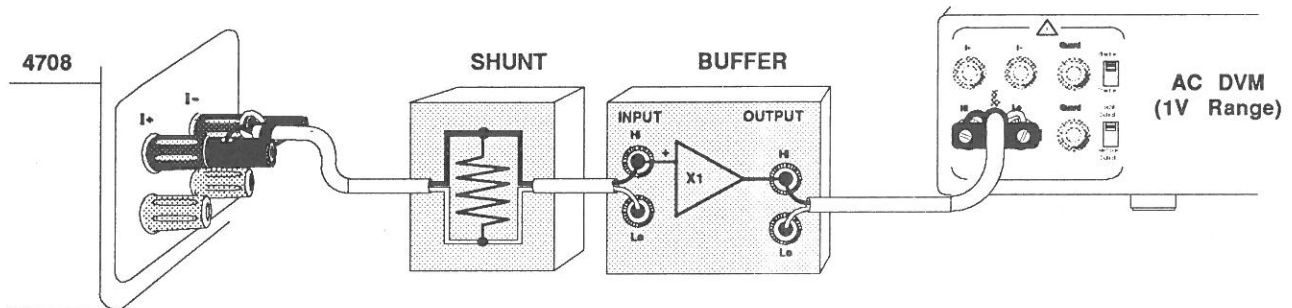

Verification of 4708 Current Ranges

- f. Reconnect the test circuit for Verification, using the appropriate Calibrated Standard Shunt.
- g. Set 4708 OUTPUT ON and note the DMM reading as V2.
- h. Calculate V3 as follows:

$$V3 = 1.000000V + (V2 - V1).$$
 Record V3 as 'Measured Shunt Voltage' on RS3.
- j. Divide V3 by the shunt resistance to convert to Current. Record as 'Calculated Current' on RS3.
- k. Reset the 4708 Frequency to 5kHz.
- l. Repeat (b) to (k) at 5kHz (HF).
- m. Repeat (a) to (l) for the four other 4708 Current Ranges on RS3, using appropriate shunts.
- n. Sum the Verification setup uncertainties and record in the Us column of RS3 as current deviations. (Refer to Appendix 2).

Validity Tolerance Limit Calculations

Refer to Appendix 1 page 7-A1-1 Para 1.

- p. Calculate the Lower and Upper Validity Tolerance Limits:
 Use Calculation A if the 4708 was last calibrated by Datron.
 Use Calculation B if the 4708 was last calibrated against the standards being used for verification.

Each 4708 Current Full Range output verifies if the Current outputs recorded in (j) are at or between the corresponding Validity Tolerance Limits.

Verification Report

4708 RS 3

Model 4708

Serial Number..... Calibration Interval --- 90days---... Specification --- Accuracy ---.....

Date..... Checked by..... Company/Dept.....

Notes: On receipt of the instrument it is recommended to check at the values shown in the tables.

For a description of 'Validity Tolerance' refer to Verification Report Sheet RS1.

AC CURRENT; Full Range Outputs 100µA to 1A Ranges
 (Using Verified 1V Full Range, Calibrated Standard AC Shunts and AC DMM)

Transfer Shunt Values

	100µA	1mA	10mA	100mA	1A
Preferred	10kΩ	1kΩ	100Ω	10Ω	1Ω
Actual LF					
HF					

Full Range Checks

Validity Tolerance: Lower Limit = $L_r - U_d(\text{Abs}) - U_s(\text{Abs})$; Upper Limit = $U_r + U_d(\text{Abs}) + U_s(\text{Abs})$
 [$U_s(\text{Abs})$ must include the uncertainties of the DMM, Buffer and Transfer Shunt]

4708 OUTPUT RANGE/ FREQUENCY	Measured Shunt Voltage	Wideband Relative Accuracy Tolerance Limits		Datron Cal. Std. Uncert'y. ±Ud(Abs)	User's Cal. Std. Uncert'y. ±Us(Abs)	Validity Tolerance Limits		Calculated Current
		Lower(Lr)	Upper(Ur)			Lower	Upper	
100µA 300Hz		99.9820	100.0180	0.0100µA				
100µA 5kHz		99.9670	100.0330	0.0100µA				
1mA 300Hz		.999870	1.000130	.000100mA				
1mA 5kHz		.999820	1.000180	.000100mA				
10mA 300Hz		9.99870	10.00130	0.00100mA				
10mA 5kHz		9.99820	10.00180	0.00100mA				
100mA 300Hz		99.9870	100.0130	0.0100mA				
100mA 5kHz		99.9820	100.0180	0.0100mA				
1A 300Hz		.999690	1.000310	0.000100A				
1A 5kHz		.999520	1.000480	0.000100A				

Harmonic Distortion Measurement

Appendix 6 to:
4708 User's Handbook
Section 7

The measurement of True Harmonic Distortion is not detailed as part of the verification procedure. However, some users may wish to check this feature from time to time, so one or two points need to be clarified.

The very low noise content of the 4708 output is included in its accuracy specifications, but not in its TOTAL HARMONIC DISTORTION specifications on pages 6-5 and 6-11. The latter relate to true harmonic distortion only.

If the 4708 distortion specification is to be verified, the measurement equipment must be selected with care. Some distortion meters merely suppress the fundamental and measure the remainder over a specific bandwidth. The readings obtained include wideband noise integrated over the full bandwidth, introducing measurement errors which increase the apparent harmonic distortion (particularly at low fundamental levels, where the harmonic envelope rapidly descends into the noise floor).

Measurement of true harmonic distortion only, in any signal, can be a laborious process. To measure the value of each single frequency harmonic, (as would be required to verify the 4708 THD specification), any wideband noise must be filtered out. Very selective bandpass notch filtering is required; this is usually achieved by phase-locking the measurement circuitry to the signal, as performed by a selective signal level meter.

A modern automatic spectrum analyser is more satisfactory. The harmonic amplitudes can be displayed on a screen against a grid, the noise levels can also be seen, or a cursor can be used to set a bandpass notch filter to the harmonic frequency required, to give a direct digital readout. THD measurement is simplified and speeded up by this method.

It is therefore recommended that either a spectrum analyser or selective level meter be employed. Suitable instruments are:

Hewlett-Packard HP3585 Spectrum Analyser,
or HP3586 Selective Level Meter.



DANGER

HIGH VOLTAGE



**THIS INSTRUMENT IS CAPABLE
OF DELIVERING
A LETHAL ELECTRIC SHOCK !**
when connected to a high voltage source

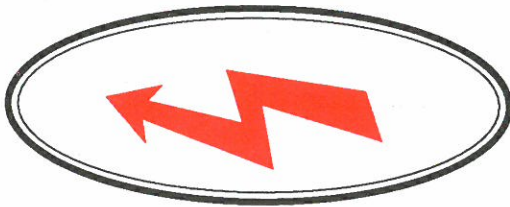

FRONT or REAR terminals
carry the Full Input Voltage

THIS CAN KILL !



Guard terminal is sensitive to
over-voltage

**It can damage your
instrument !**

Unless **you** are **sure** that it is **safe** to do so,
DO NOT TOUCH
the **I+ I- Hi** or **Lo leads** and **terminals**

DANGER

SECTION 8 ROUTINE AUTOCALIBRATION

Users requiring to verify the specification without adjustment to the instrument's calibration status refer to Section 7. For full information on calibration of the 4708 refer to the Calibration and Servicing Handbook, Section 1.

The 4708 Autocal Feature

Using the standard 'Autocal' feature, the 4708 is calibrated entirely from the front panel (or remotely via the IEEE 488 Interface). Because it is not necessary to remove the covers, thermal disturbance is avoided and the 4708 can be put back into service immediately after calibration.

Users wishing to maintain the highest specification (24 Hours) can recalibrate daily, on a regular basis, if desired. The procedures contained in this Section provide the essential information for setting up such routines. It is not necessary to update all ranges, as it is possible to calibrate one output range.

During the Autocal process, the microprocessor adjusts correction factors which are already stored in non-volatile memories. After adjustment, the updated factors are continuously applied to correct the 4708 output amplitude.

Special keys are used in the Autocal mode. They are illustrated below:

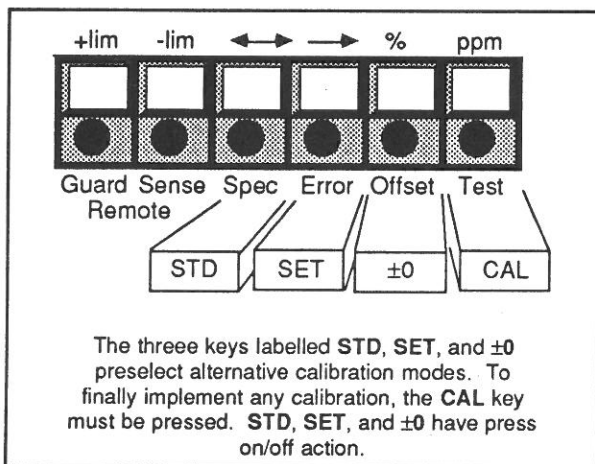

These keys are activated by a simple procedure. On the rear panel there are two switches: the IEEE address switch, and a security key switch labeled RUN/CAL ENABLE. By setting the address switch to 31 (ADD 11111) for Front Panel calibration and the key switch to CAL ENABLE, four of the front panel MODE keys are reassigned to calibration functions, permitting access to the correction memories.

The activation procedure is illustrated below:

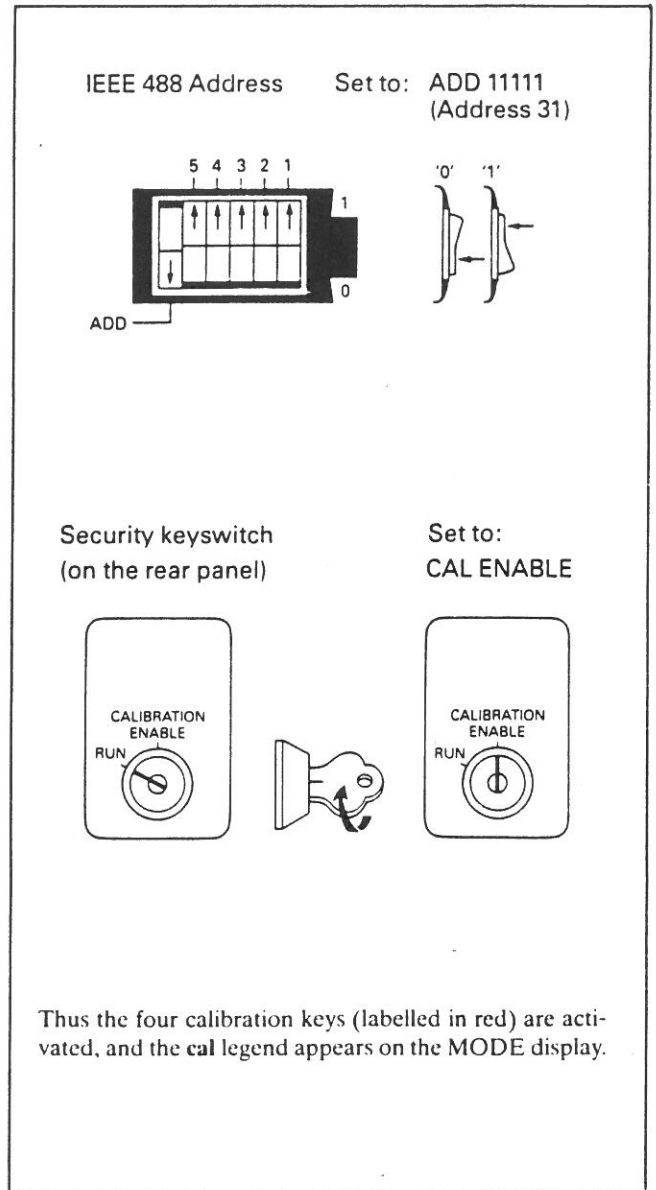

Once the keys are activated, up to four modes of calibrating the 4708 become available. The meanings of the modes differ slightly for DC and AC Calibration.

The meanings of the names, and the detailed procedures for using the modes, are described overleaf.

DC Calibration

STD key STD calibration is carried out on the 1V or 10V range, and differs from the "SET" procedure only in the use of the STD key instead of the SET key.

It changes the DC gain of all voltage and current ranges in the same ratio, and thus performs the same function as trimming the internal Master Reference voltage. The facility can be used to avoid a full recalibration of the 4708 when Laboratory References have been re-standardized (or for instance when a 4708 has been moved from one country to another). In DC mode it does not affect AC or Ohms.

SET key The SET key allows calibration to any value in the selected Range (e.g. at a standard cell voltage):

SET key Before selecting SET, the $\uparrow\downarrow$ keys are operated to place the Calibration Standard value on the OUTPUT display and set the 4708 output level. Pressing SET then informs the 4708 that calibration is to be carried out at this value. The instrument acknowledges by duplicating the value on the MODE display.

Next the $\uparrow\downarrow$ keys are manipulated to null the 4708 output against the Calibration Standard (the OUTPUT display changes during this adjustment).

Pressing the CAL key executes the calibration. The 4708 memorizes the difference between the two display values and exits from SET mode. This is shown by transfer of the Standard value from the MODE display to the OUTPUT display.

The instrument uses the difference to modify stored constants, which in "RUN" mode correct both positive and negative outputs on the calibrated range only.

If the Calibration Standard value is below 2% of Full Range, the 4708 assumes a request for "Offset" correction; but if at 2% or above, "Gain" correction is assumed.

± 0 key The ± 0 key is used to align the ON+ and ON-zeros of all voltage and current ranges by a 2-part calibration on the 10V range. The ± 0 Alignment Routine on Page 8-6 is necessary only when the ON+ and ON- zeros on the 10V range do not coincide at the same null.

CAL Key The CAL key executes the preselected Autocal facility, as described in "SET" above. Alternatively, it can be used without first pressing SET, ± 0 or STD to calibrate Voltage or Current ranges, but only at Zero or Nominal Full Range values:

Before selecting CAL, the Zero or Full Range key is pressed to set the 4708 output level.

Next the $\uparrow\downarrow$ keys are manipulated to null the 4708 output against the Calibration Standard (the OUTPUT display changes during this adjustment).

Pressing CAL commands the 4708 to calibrate. The instrument decides on "Zero Offset" or "Full Range Gain" from the OUTPUT display value (defined by the same limits as for "SET"), and executes the calibration. The difference between the OUTPUT display value and the value chosen by the 4708 is used to modify the stored constants mentioned in "SET" above.

Autocal Availability

As the Autocal keys perform specific DC tasks, they are available only as defined by Table 8.1. The message "Error 3" appears on the MODE display for any attempt to select an inappropriate mode.

Table 8.1
Autocal availability
for DC Calibration

AUTOCAL DC Mode		DC Voltage (DC)	DC Current (I)	Resistance (Ω)	
				Local Sense (2-wire)	Remote Sense (4-wire)
SET and CAL	Zero offset for range at User's selected value	100mV - 1000V Ranges only	All Ranges		
	Gain for range at User's standard value	100mV - 1000V Ranges only			
± 0 and CAL	Alignment of internal ON+ and ON- zeros	10V Range only			
STD and CAL	Internal Reference gain at User's Standard value	1V and 10V Range only			
CAL Only	Zero offset for range	All Ranges	All Ranges	10 Ω - 1M Ω Ranges only	All Ranges
	Gain for range at Full Range Value	10mV - 1000V Ranges only			

Zero Calibration

It is common practice to accept a small offset in the output of a voltage calibration standard, providing that the same offset is present at all output values, including zero.

The output of the 4708 is fully floating, so its output may be referred to any common mode voltage within the range specified on page 6.1. In particular, its zero may be aligned to absolute zero in Local Sense by calibration to a null across its Hi and Lo (Sense) terminals. But if it is then gain-calibrated against an offset standard without re-zeroing to that standard's offset zero, normal mode gain errors will result.

It is therefore essential that each voltage and current range zero is first calibrated to a standard's zero before using that standard to calibrate the range gain.

If the 4708 zero output is to be regarded as absolute Laboratory Reference Zero, then AFTER range gain calibration its range zero output may be recalibrated to a null across the Hi and Lo (Sense) terminals.

Equipment Required for DC Calibration

- DC Voltage - A Standard DC Voltage source of suitable accuracy:
Example:
Series bank of 10 standard cells and Datron 4904 Standard Cell Buffer.
- A Precision Divider:
Example:
Datron 4902 High Voltage Divider
- A battery-operated null detector with variable sensitivity, able to withstand 1200V across its input terminals:
Example:
Keithley Instruments Model 155
- DC Current - A DC Voltage source, calibrated to suitable accuracy at approximately 1V and 100mV:
- The battery-operated null detector used for DC Voltage
- A set of calibrated current shunts of suitable accuracy.

N.B. To allow the same value to be set on the DC Voltage source for each range, the shunts may be of five decade values. Then the same Null Detector sensitivity can be used on each range.

CAUTION When choosing a set of current shunts ensure that their power dissipation ratings are sufficient to avoid permanent degradation from the self-heating effects of the current being checked. This applies particularly to the 1 Amp shunt.

- alternatively, a DMM of sufficient accuracy may be used to measure the voltage across the set of calibrated current shunts.
Example:

Datron 1281 using "compute" mode.

- Resistance - a set of standard resistors covering 10 Ω to 100M Ω . The 10 Ω to 10k Ω should be 4-wire type.
- an accurate resistance bridge, or other ratiometric device for measuring resistance to the required accuracy.
- a Datron 1281 used as a transfer-measurement device.

Interconnections

Interconnection instructions in this section are necessarily simple and basic, and are mainly intended to show connections to the 4708. It is recognized that they may need to be adapted to meet an individual user's requirements. It is assumed that users will possess knowledge of the operation and use of standards equipment such as that mentioned above.

DC Calibration Sequence

The sequence of operations for DC calibration of a 4708 is given below:

Preparation
DC Voltage
DC Current
Resistance
Return to Use

If only a partial recalibration is to be done, step 1 of the DC Voltage sequence should be carried out immediately after the preparation.

WARNING: During Performance checks and calibration a common mode voltage equal to the full range voltage may be present at the Null Detector input terminals. On ± 1000 V checks this voltage is potentially lethal, so **EXTREME CAUTION** must be observed when making adjustments to the null detector sensitivity.

CAUTION The Null Detector used must be able to withstand voltages up to 1200V between its input terminals. Such voltages will be present during the time that the 4708 is ramping from zero to 1000V Full Range after setting OUTPUT ON. Inadvertent disconnection of the Precision Divider terminals can transfer full output across the Null detector.

Preparation: Before any calibration from the front panel is carried out, prepare the 4708 as follows:

1. Turn on the instrument to be checked and allow minimum of 2 hours to warm-up in the specified environment.
2. IEEE 488 Address switch:
Set to ADD 11111 as shown (Address 31).

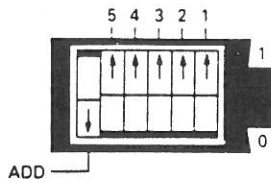

3. CALIBRATION ENABLE key switch:
Insert Calibration Key and turn to ENABLE.

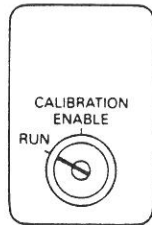

These actions activate the four calibration modes (labeled in red) and present the 'cal' legend on the MODE display.

4. Ensure that OUTPUT OFF LED is lit.

Return to use: When any calibration is completed, return the 4708 to use as follows:

1. Ensure that OUTPUT OFF LED is lit.
2. CALIBRATION ENABLE key switch:
Turn to RUN and withdraw calibration key.

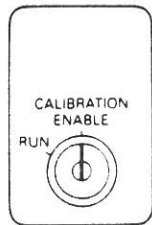

3. IEEE 488 Address switch:
Restore to correct address if the 4708 is to be used in an IEEE 488 system.

4708 DC VOLTAGE CALIBRATION

1. Initial Set up.

CAUTION: First read the Notes on the use of the Null Detector in Section 7, page 7-A3-1 (Appendix 3).

Carry out the Preparation as detailed on Page 8-4.

Select DC and connect the DC Voltage Calibration Source and Null Detector to the 4708 terminals as shown in Fig. 8.1(a).

Use short leads, ensure that the Calibration Source voltage is set to zero and that the inter-connecting circuit has thermally stabilized.

2. Calibrate as follows:

a) Full Calibration

Calibrate the DC Voltage ranges in the step sequence of Table 8.2, using the Calibration Routine at each step (except steps 2 and 3). For steps 10 - 13, reconnect as Fig. 8.1(b).

b) Partial Calibration

Carry out Step 1 of Table 8.2. Proceed with the desired steps of Table 8.2, using the Calibration Routine at each step (except steps 2 and 3). For steps 10 - 13, reconnect as Fig. 8.1(b).

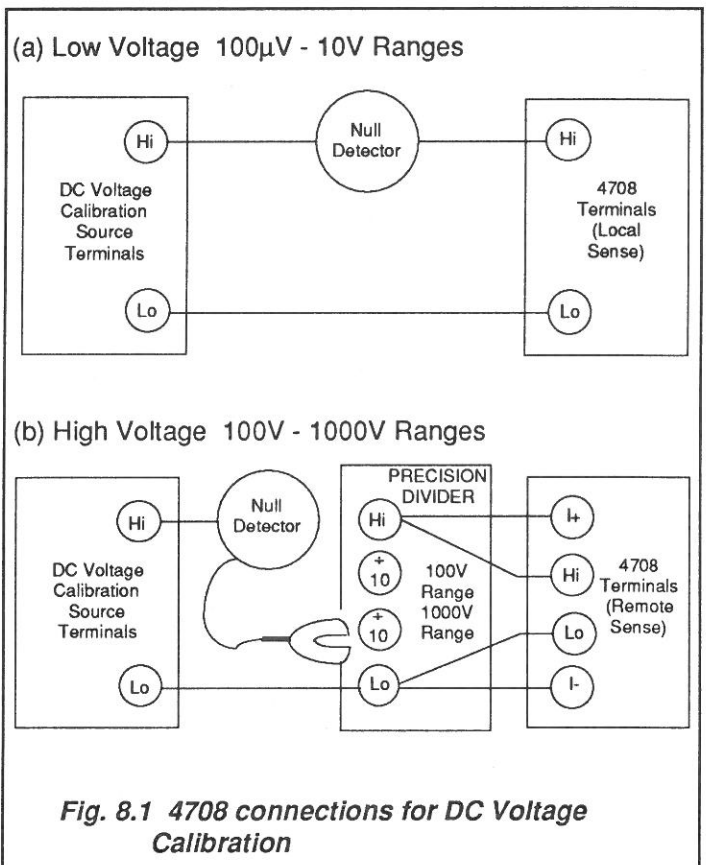

Fig. 8.1 4708 connections for DC Voltage Calibration

- c) Re-standardizing using "STD"
To re-standardize all DC Voltage and Current ranges in the same ratio, carry out steps 1, 2, 3, then either 6 and 7, or 8 and 9. In operation (g) of the Calibration Routine, substitute "STD" for "SET". (Refer to earlier description of "STD").

3. Calibration Routine:

Calibration of DC Voltage to a Standard voltage calibration source.

- NOTES:**
- A For calibration at any value, this routine may be used as printed.
 - B For calibration at zero or positive nominal Full Range only, operation (g) may be omitted.
 - C In Table 8.2(a), use interconnections as Fig. 8.1(a) (Low Voltage), obtaining the correct calibration voltage from the source.

In Table 8.2(b), use interconnections as Fig. 8.1(b) (High Voltage) selecting + 10 at steps 10 and 11, + 100 at steps 12 and 13.

CAUTION: Below 2% of Range, the 4708 corrects for an assumed offset error, at 2% of Range and above the correction is for an assumed gain error.

- a) Null Detector Set to **Low** sensitivity.
- b) 4708 Ensure **OUTPUT OFF**.
- c) DC Source Set to the required polarity and value.
- d) 4708 Select correct **FUNCTION** and **RANGE**.
- e) 4708 Use **Full Range, Zero** or **OUTPUT** $\uparrow\downarrow$ keys to set the required polarity and value on **OUTPUT** display.

N.B. Operation (f) must be carried out before operation (g).

- f) 4708 Press the correct-polarity **ON** key.

Omit Operation (g) if calibrating at **zero** or **Full Range** value.

- g) 4708 Press **SET** key:
SET LED lights green.
OUTPUT display reading also appears on **MODE** display.
- h) Null Detector Increase sensitivity to give an off-null reading and use 4708 **OUTPUT** $\uparrow\downarrow$ keys to back off to null. Repeat until null lies between two values of the **OUTPUT** display least-significant digit.

- j) Null Detector Set to **LOW** sensitivity.

- k) 4708 Press **CAL** key:
CAL LED flashes once.
MODE display is transferred to **OUTPUT** display.
MODE display is cleared.
SET LED goes **OFF**.
- Not applicable if operation (g) omitted

The 4708 is now calibrated at this value.

± 0 Alignment Routing:

Alignment of 10V Range positive and negative zeros if necessary at step 3 of Table 8.2.

- a) Null Detector Set to low sensitivity.
- b) 4708 Ensure **OUTPUT OFF** on **DC 10V** Range.
- c) Calibration Source Ensure set to **zero** and thermally stable.
- d) 4708 Press **OUTPUT Zero** Key.
Press **ON+** Key.
Press ± 0 Key:
 ± 0 **LED** lights, **OUTPUT** display at zero.
- e) Null Detector Increase sensitivity to give an off-null reading and use 4708 **OUTPUT** $\uparrow\downarrow$ keys to back off to null. Repeat until null lies between two values of the **OUTPUT** display least-significant digit.
- f) 4708 Press **CAL** key:
CAL LED lights.
No change to **OUTPUT** display.
Press **ON-** key.
- g) 4708 Obtain accurate null as in (e)
- h) Null Detector above.
- j) 4708 Press **CAL** key:
CAL LED goes **OFF**.
 ± 0 **LED** goes **OFF**.
OUTPUT display falls to zero.

The 4708 positive and negative zeros are now both aligned to the Calibration Source zero.

Table 8.2 STEPS in DC VOLTAGE CALIBRATION
(a) Low Voltage – connect as Fig. 8.1(a)

Step	Calibration Operation	4708 Range	Calibration Source Voltage	4708 Output Setting (Nominal Value) [1]	AUTOCAL Key Used [2]
1	10V Range ON- zero	10	0.000000V	(ON+) 0.000000V	—
2	10V Range ON- zero check only - do not calibrate	10	0.000000V	(ON-) 0.000000V	Check only 0.000000V
3	±0 Alignment	10	0.000000V	Refer to ±0 Alignment Routine	'±0'
4	100mV Range Zero	100m	0.000000mV	(ON+) 0.00000mV	—
5	100mV Range gain	100m	+100.00000mV	(ON+) 100.00000mV	'SET' for non-nominal
6	1V Range zero	1	.000000V	(ON+) .0000000V	—
7 [3]	1V Range gain	1	+1.0000000V	(ON+) 1.0000000V	'SET' for non-nominal
8	10V Range zero	10	0.000000V	(ON+) 0.000000V	—
9	10V Range gain	10	+10.0000000V	(ON+) 10.000000V	'SET' for non-nominal

(b) High Voltage – connect as Fig. 8.1(b)

Step	Calibration Operation	4708 Range	Calibration Source Voltage	Precision Divider Select	4708 Output Setting (Nominal Value) [1]	AUTOCAL Key Used [2]
10	100V Range zero	100	0.000000V	+ 10	(ON+) 0.00000V	—
11	100V Range gain	100	+10.000000V	+ 10	(ON+) 100.00000V	'SET' for non-nominal
12	1000V Range Zero	1000	0.0000V	+ 100	(ON+) 0.0000V	—
13	1000V Range gain LETHAL VOLTAGE	1000	+10.000000V	+ 100	(ON+) 1000.0000V Enter High Voltage state using interlock procedure (User's Handbook Sect. 4)	'SET' for non-nominal

NOTES

- [1] It is expected that many users will wish to calibrate Range gains at values other than the nominals shown. In these cases set the Calibration Source voltage and 4708 OUTPUT display to in-house standard values near nominal.
- [2] Except for Step 2, use CAL key as trigger (Refer to Calibration Routine).
- [3] To trim the internal Master Reference voltage, substitute 'STD' for 'SET' for 1V or 10V Range (Refer to Calibration Routine and description of 'STD').

4708 DC Current Calibration

1. Ensure that the 4708 OUTPUT OFF LED is lit. Select DC and connect the DC Voltage calibration source, null detector and calibrated current shunt to the 4708 OUTPUT terminals as shown below. Do not connect null detector to shunt until the voltage across the the shunt and the source voltage are close in value.

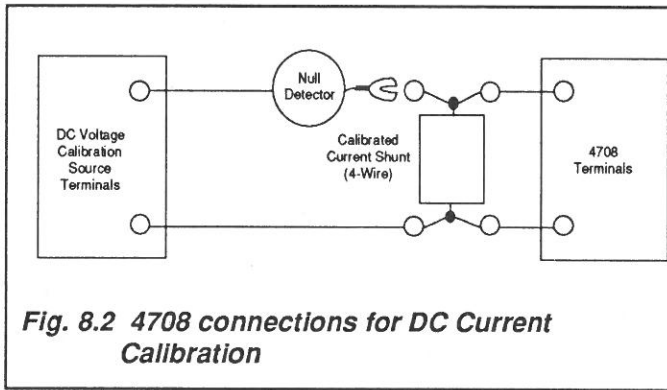

Fig. 8.2 4708 connections for DC Current Calibration

Preferred shunt values are as follows:

Value	Power Dissipation Capability	Calibration Source Output Voltage for Full Range
100μA range- 10kΩ	1mW min	1V
1mA range- 1kΩ	10mW min	1V
10mA range- 100Ω	100mW min	1V
100mA range- 10Ω	1W min	1V
1A range- 0.1Ω	1W min	100mV

Ensure that the calibration source voltage is set to zero and that the interconnecting circuit has thermally stabilized.

2. Calibrate the DC Current ranges in the step sequence of Table 8.3, using the Calibration Routing at each step.

Table 8.3 STEPS in DC CURRENT CALIBRATION

Step	Calibration Operation	Shunt Value	Calibration Source Voltage ^[1]	4708 Output Current		AUTOCAL Key Used ^[2]
				Range	OUTPUT Setting ^[1]	
1	100μA Range zero	10kΩ	.0000000V	100μ	0.0000μA	—
2	100μA Range gain	10kΩ	+1.0000000V	100μ	+100.0000μA	'SET' for non-nominal
3	1mA Range zero	1kΩ	.0000000V	1m	.000000mA	—
4	1mA Range gain	1kΩ	+1.0000000V	1m	+1.000000mA	'SET' for non-nominal
5	10mA Range zero	100Ω	.0000000V	10m	0.00000mA	—
6	10mA Range gain	100Ω	+1.0000000V	10m	+10.00000mA	'SET' for non-nominal
7	100mA Range zero	10Ω	.0000000V	100m	0.0000mA	—
8	100mA Range gain	10Ω	+1.0000000V	100m	+100.0000mA	'SET' for non-nominal
9	1A Range zero	0.1Ω	0.00000V	1	.000000A	—
10	1A Range gain	0.1Ω	+100.00000V	1	+1.000000A	'SET' for non-nominal

NOTES:

[1] It is expected that most users will wish to calibrate Range gains at values other than the nominals shown. In these cases set the Calibration Source voltage and the 4708 OUTPUT display to in-house standard values near nominal.

[2] At each step, use CAL key trigger (Refer to Calibration Routines).

3. Calibration Routine:

Calibration of DC Current using a DC Voltage Source and a series of calibrated current shunts.

- NOTES: A. For calibration at any value, the routine may be used as printed.
B. For calibration at zero or positive nominal Full Range only, operation (g) may be omitted.

CAUTION: Below 2% of Range, the 4708 corrects for an assumed offset error, at 2% of Range and above the correction is for an assumed gain error.

- a) Null Detector Set to Low sensitivity
b) 4708 Ensure OUTPUT OFF
c) DC Source Set to the required polarity and value
d) 4708 Select correct FUNCTION and RANGE
e) 4708 Use Full Range, Zero or OUTPUT $\uparrow \downarrow$ keys to set the required polarity and value on OUTPUT display

N.B. Operation (f) must be carried out before operation (g)

- f) 4708 Press the correct polarity ON key
CAUTION: Pressing the wrong ON key will result in twice the OUTPUT being connected across the null detector.

Omit operation (g) if calibrating at Zero or Full Range value.

- g) 4708 Press SET key:
SET LED lights green.
OUTPUT display reading also appears on MODE display.
- h) Null Detector Increase sensitivity to give an off-null reading and use 4708 OUTPUT $\uparrow \downarrow$ keys to back off to null. Repeat until null lies between two values of the OUTPUT display least-significant digit.
- j) Null Detector Set to LOW sensitivity
k) 4708 Press CAL key

Not applicable if operation (g) omitted

CAL LED flashes once.
MODE display value is transferred to OUTPUT display.
MODE display is cleared.
SET LED goes OFF.

4708 Resistance Calibration

1. Calibration Memory

In Ω function, each RANGE key selects a nominal-value standard resistor. Routine adjustment of the resistor is not necessary. During calibration the actual value is measured and stored in the calibration memory to be displayed whenever that range is selected. Separate memory stores exist for Remote Sense (4-wire), Local Sense (2-wire) and Local Sense zero.

2. 4-Wire Calibration Limits

The value measured in 4-wire Remote Sense does not include the resistance of internal or external wiring. The 4708 accepts any value within ± 200 ppm of nominal as a valid calibration.

3. 2-Wire Calibration Limits

The value measured in 2-wire Local sense is greater than for 4-wire Remote Sense, as it includes the resistance of internal wiring and relay contacts. The 4708 will not accept a 2-wire value less than the stored value for 4-wire, so the 4-wire Remote Sense calibration must be carried out before attempting 2-wire Local Sense. The extra internal resistance depends on Range, so the 4708 accepts the following values (x) as valid 2-wire calibrations:

Zero calibrations:
 10Ω — $1M\Omega$ Ranges
 $0 \leq x < 0.900\Omega$

Value calibrations:
 10Ω — $1M\Omega$ Ranges:
 $4\text{-wire value} \leq x < (4\text{-wire value} + 1.999\Omega)$

4. "Error 6" Message

"Error 6" appears on the MODE display for any attempt to enter a value outside the 4-wire or 2-wire limits quoted above.

NOTE: When resistance is calibrated in Remote Sense, the 4708 overwrites the Local Sense, calibration memory with the new 4-wire value.

5. 4-Wire and 2-Wire Connections

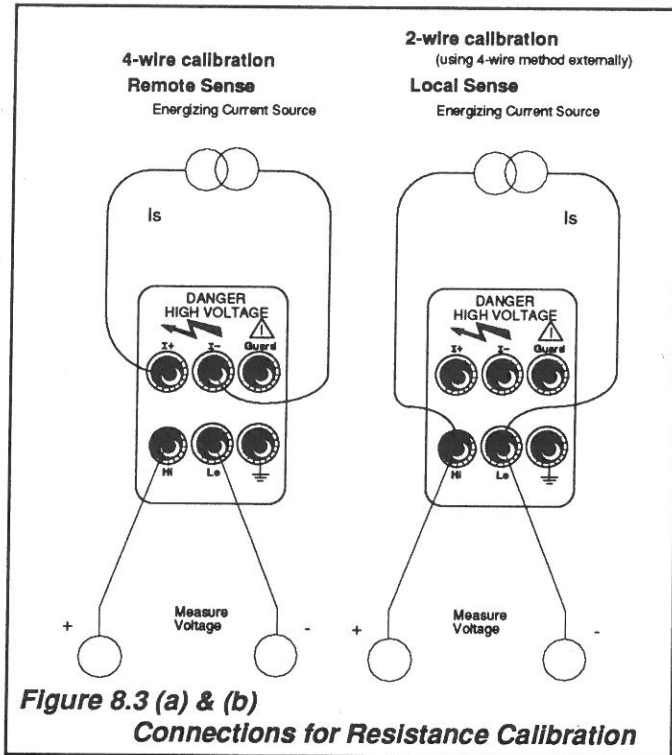

6. Calibration sequence

Press Ω key and calibrate the resistors in the step sequence of Table 8.4 (a) and (b), using the Calibration Routine at para 7 (a) or (b). Refer to para 5 for connections in Remote Sense (Fig 8.3(a)) - only the value of the internal Standard Resistor is measured. In Local Sense (Fig 8.3 (b)) a 4-wire method is used to exclude the resistance of the external leads from the measured value.

7. Calibration Routine:

Measurement and Storage of the values of an internal resistor.

a) **Remote Sense** (Internal 4-wire, connected as Fig 8.3(a))

Full Range values — Routine for Table 8.4(a)

- (i) 4708 Select OUTPUT OFF and Ω
Select Remote Sense
- (ii) 4708 Press required resistor (RANGE) key:
The previously-calibrated value appears
on the OUTPUT display
- (iii) 4708 and resistance-measuring equipment Press OUTPUT ON+ and measure the
value of the internal resistor.
- (iv) 4708 Set the measured value on the OUTPUT
OUTPUT display $\downarrow \uparrow$ KEYS.
- (v) 4708 CAL Key Press to store OUTPUT display value.
- (vi) 4708 Set OUTPUT OFF.
- (vii) Repeat operations (ii) to (v) for each step of
Table 8.4(a).

b) **Local sense** (Internal 2-wire, connected as Fig 8.3(b),
Remote Sense OFF)
Full Range and Zero values — Routine for Table 8.4(b)

- (i) 4708 Select OUTPUT OFF and Ω
Deselect Remote Sense.
- (ii) 4708 Press required resistor (RANGE) key:
The previously-calibrated value appears
on the OUTPUT display.
- (iii) 4708 and resistance-measuring equipment Press OUTPUT ON+ and measure the
value of the internal resistance.
- (iv) 4708 Set the measured value on the output
OUTPUT display $\downarrow \uparrow$ Keys
- (v) 4708 CAL Key Press to store OUTPUT display value.
- (vi) 4708 Zero Key Press and repeat operations (iii) to (v)
for this RANGE selection.
- (vii) 4708 Set OUTPUT OFF.
- (viii) Repeat operations (ii) to (viii) for each step of Table
8.4(b).

Table 8.4 STEPS IN RESISTANCE CALIBRATION
(Internal resistor value measurement and storage)

a) **Remote Sense**
(Internal 4-wire, connected as Fig. 8.3a)
Calibration at Full Range. Resolution 7.5 digits, Tolerance ± 199.9 ppm (± 1999 digits).

Step	Range	Measured resistance value, Calibration Limits		
1	100M Ω	99.980,01	to	100.019,99 M Ω
2	10M Ω	9.998,001	to	10.001,999 M Ω
3	1M Ω	.9998,001	to	1.000,199,9 M Ω
4	100k Ω	99.980,01	to	100.019,99 k Ω
5	10k Ω	9.998,001	to	10.001,999 k Ω
6	1k Ω	.9998,001	to	1.000,199,9 k Ω
7	100 Ω	99.980,01	to	100.019,99 Ω
8	10 Ω	9.998,001	to	10.001,999 Ω

b) **Local Sense**
(Internal 2-wire, connect as Fig 8.3(b), Remote Sense OFF)
Calibration at Full range and Zero. Resolution as listed in Table.
Tolerances $-\Omega + 1.999\Omega$ on 10 Ω – 1M Ω Ranges, $-\Omega + 0.900\Omega$ for zero on 10 Ω – 1M Ω Ranges.

Step	Range	Resolution (digits)	Resistance value Limits	Zero Limits
9	1M Ω	7.5	Step 3 value, -0 +19 digits	.000,000,0 to .000,000,0 M Ω
10	100k Ω	7.5	Step 4 value, -0 +199 digits	0.000,00 to 0.000,90 k Ω
11	10k Ω	7.5	Step 5 value, -0 +1999 digits	0.000,000 to 0.000,900 k Ω
12	1k Ω	6.5	Step 6 value, -0 +1999 digits	.000,000 to .000,900 k Ω
13	100 Ω	5.5	Step 7 value, -0 +1999 digits	0.000 to 0.900 Ω
14	10 Ω	4.5	Step 8 value, -0 +1999 digits	0.000 to 0.900 Ω

AC Calibration

'Wideband' Calibration

When CAL is pressed without preselecting SET, ± 0 or STD; the 4708 makes the assumption that each OUTPUT Range is to be calibrated at the exact Full Range value, at either LF or HF, or both.

This allows two correction values to be stored for each output range. From their difference, the microprocessor calculates a compensation factor, which affects the corrections applied at all subsequently-selected frequencies on that output range. In this

way, the 4708 can be calibrated to meet its 'Wideband' specification.

To ensure that the selected Low and High frequencies have sufficient separation for the compensation to be effective over the full frequency range, calibration is automatically prohibited in an 'excluded' band of frequencies for each output range. Because of the extended frequency range of lower Voltage ranges, and the Voltage/Frequency constraints on higher Voltage ranges, the exclusion band can differ from one output range to another. If an excluded frequency is selected, the calibration is cancelled and Error 3 is displayed. The following diagram illustrates the mid-frequency exclusions:

AC Calibration Sequence

INTRODUCTION

Because most users will calibrate the 4708 via thermal transfer standards, the calibration procedures assume that this method will be employed. However, details of setting up a thermal transfer standard are not included, as there are several different models, each with its own methods of connection and procedures.

Instead it is assumed that users will be able to operate their own equipment correctly, according to the manufacturer's instructions. The procedures which follow therefore concentrate on the operation of the 4708 during calibration, accepting that the required thermal transfer will be set up to a DC source of suitable accuracy.

GENERAL PROCEDURE

WARNING! During Performance checks and calibration the Full Range voltage is preset at the Thermal Transfer Standard input terminals. On 1000V checks this voltage is potentially lethal, so **EXTREME CAUTION** must be observed when adjusting the Thermal Transfer Standard sensitivity.

Voltage Calibration using a Thermal Transfer

Select AC and the desired frequency (or Spot frequency), set the 4708 OUTPUT display to the Calibration Standard value, and switch the 4708 OUTPUT ON. If calibrating a non-nominal voltage value, SET needs to be selected. Adjust the 4708 output to obtain a null at the Calibration Standard value, and press the Cal key to execute the calibration.

LF Millivolt Calibration

Because 'Flatness' data is passed on to the millivolt ranges from the 1V Range calibration, the 1V Range must be calibrated first. A DVM is then standardized at the required millivolt value and frequency, using the calibrated 1V Range and an Inductive Voltage Divider (IVD). The desired frequency (or Spot frequency) is selected, the OUTPUT display set to Full range, and incremented or decremented to give the required value on the DVM. If calibrating at a non-nominal value SET must be selected. The CAL key is pressed to execute the calibration.

HF Millivolt Calibration

From the 10V Range a 10% Range correction is calculated. This is applied at 100mV on the 1V Range to standardize a DVM, which is subsequently used to calibrate the 100mV Full Range. The process is extended to calibrate the 10mV Range from 10% of the 100mV Range, and 1mV Range from 10% of the 10mV Range.

Current Calibration

(Using Thermal Transfer Standard Current Shunts)

The method employs a DC Current Standard, so that the shunt

(Shaded areas show forbidden calibration zones)

Voltage Ranges:

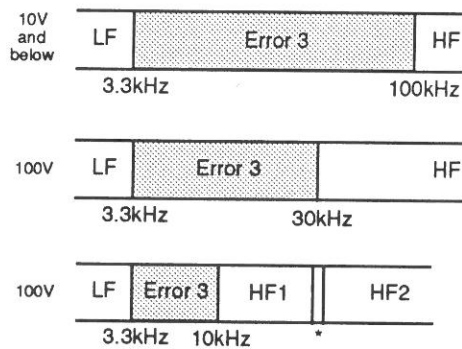

* HF1/HF2 cross-overs are Frequency-Range dependent:
 HF1 is available up to 33kHz on the 10kHz Range.
 HF2 is only available above 30kHz on the 100kHz Range.
 (Note for 700V HF2 SET mode must be used)

All Current Ranges:

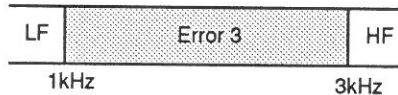

SET Calibration

If Calibration is to be carried out with sources which are not exactly at Full Range, then the SET preselection key allows the 4708 to be prepared for calibration at other than its full range values. In this way the 4708 can be calibrated between 20% and 200% of full range, except for 1000V Range (20% to 110% - max. 1100V).

Set can also be used as a means of compensating for known errors in the Measurement System.

SPOT Calibration

For each Output Range, a user may select five frequencies for SPOT calibration. The 4708 stores frequencies and their amplitude corrections, in memories which are separate from those used for wideband corrections. Enhanced accuracy is obtained at these spots, as any flatness errors in the wideband correction are eliminated.

Procedural Notes

When SPOT is pressed the 4708 assumes that the spot frequency is to be changed, and so defaults frequency to 1kHz. When used with SET, SPOT calibration can be carried out within 10% of full range, but when SPOT is used without SET, the 4708 assumes that the calibration is to be at Full Range.

Spot achieves best specification if used at the calibrated value. Accuracy tables are given in Section 6, with an example showing Spot linearity on page 6-5. For Recall procedures see Section 4, 4-10.

remains connected for both AC and DC nulling the Thermal Transfer Standard.

Otherwise the procedure is similar to that for DC Voltage Calibration.

Alternative Current Calibration

(Using Calibrated Standard AC Current Shunts)

This method required Standard Current Shunts which have been designed to give a flat frequency response. Each current range requires its own specific value of shunt, calibrated to develop either 1V or 100mV Full Range at LF and HF. An AC DVM is standardized to the appropriate voltage, and the Current range is calibrated when the voltage across its shunt is correct. The method is detailed in Appendix 1 to this section (page 8-19).

Standardization

To 'Standardize' all Ranges: The Voltage procedure is used, but pressing STD instead of SET on the 1V/10V Range.

CAUTION! Do not 'Standardize' unless it is necessary for the reasons quoted on page 8-2.

GENERAL NOTES

Remote Sense is available as follows:

1V 10V 100V 1000V - Local/Remote Sense

1mV 10mV 100mV - Local Sense only

All current ranges - not applicable

(Local: 2-wire sense, Remote: 4-wire sense)

Output must be OFF to change sense connection (except that Remote changes automatically to Local when switching to Millivolt Ranges).

Upgrading - OUTPUT OFF Default

The 4708 cannot enter High-Voltage state (>75V RMS) with OUTPUT ON. Consequently, when ranging-up, the operating system allows the upgrading to occur, but defaults to OUTPUT OFF for two specific cases:

- When upgrading to the 1000V Range,
- When altering the output on the 100V Range to a voltage of 75V or more.

Otherwise, OUTPUT remains ON when changing OUTPUT RANGE (refer to Section 4, pages 4-8 to 4-9).

High Frequency Calibrations

Several passes may be required to achieve satisfactory calibration, particularly if the initial errors are large or the calibration takes longer than required by the Transfer System in use. Repeat procedure as required.

1000V Range Calibration Sequence

LF calibration must be completed first. However HF1/HF2 bands may, if the user requires, be calibrated in reverse order. SET mode must be used for 700V/HF2.

SPOT Memory Erasure

To prevent unwanted calibrations at obsolete spot frequencies, it is possible to 'Uncalibrate' any spot frequency on any range. The procedure is:

Select Zero Output, set Output ON and Press CAL.

When the CAL ENABLE /RUN switch is set to RUN, any selection of that particular Spot F will cause the uncalibrated message 'SFX —' to be shown on the MODE/FREQUENCY display.

Preparation

Before any calibration is carried out, prepare the 4708 as follows:

- Turn on the instrument to be checked and allow minimum of 2 hours to warm up in the specified environment.
- Ensure familiarity with normal operation of the 4708 described in this Handbook.
- Refer to 'Equipment Requirements' in Section 7; the same equipment and techniques used for verification are also applicable to calibration.
- Consult the manufacturer's handbooks before connecting and operating the Thermal Transfer Std, DC Voltage Std., Inductive Voltage Divider, AC DVM, and Thermal Transfer Standard Current Shunts.
- Interconnection and Guarding: Refer to Section 4, pages 4-1 to 4-3.
- Cancel any MODE keys, ensure OUTPUT set to OFF.
- IEEE 488 Address switch:
Set to ADD 11111 (Address 31) unless the 4708 is to be calibrated via the IEEE 488 interface.
- CALIBRATION ENABLE key switch:
Insert Calibration Key and turn ENABLE.
- Set the Calibration Interval Switch to 24 hr.

WARNING

During the Full range voltage is present at the Thermal Transfer Standard input terminals. On 1000V checks this voltage is potentially lethal, so EXTREME CAUTION must be observed when making adjustments to the Thermal Transfer Standard sensitivity.

4708 AC Voltage Calibration (1V - 1000V)

(Using Thermal Transfer Standard and DC Calibration Standard)

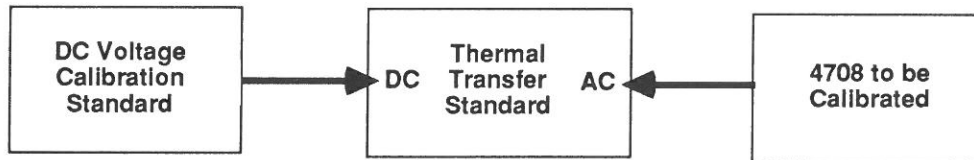

Calibrate the 4708 at or close to the calibration points in the table, selecting SET as required as part of the following procedure:

Display reading to obtain a null on the Thermal Transfer.

g. Execute the calibration by pressing the CAL key.

WARNING:

THE TERMINALS MARKED WITH THE ⚡ SYMBOL CARRY THE OUTPUT OF THE 4708. THESE TERMINALS AND ANY OTHER CONNECTIONS TO THE LOAD UNDER TEST COULD CARRY LETHAL VOLTAGES. UNDER NO CIRCUMSTANCES SHOULD USERS TOUCH ANY OF THE FRONT (OR REAR) PANEL TERMINALS UNLESS THEY ARE FIRST SATISFIED THAT NO DANGEROUS VOLTAGE IS PRESENT.

1. 4708 & DC Voltage Standard

With OUTPUT OFF, connect to the Thermal Transfer AC and DC inputs, respectively.

2. Thermal Transfer Standard

Configure for DC measurement at the required Calibration Voltage.

3. DC Voltage Calibration Standard.

Set to the Cal Voltage, OUTPUT ON.

4. Thermal Transfer Standard

- Adjust for Null at the Cal. Voltage
- Configure for AC measurement at the Calibration Voltage

5. 4708

- On AC FUNCTION, select the required OUTPUT RANGE.
- Select the required FREQUENCY RANGE.
- Use FREQUENCY $\downarrow \uparrow$ keys to display the required Cal. Frequency
- Use OUTPUT $\downarrow \uparrow$ keys to display the required Cal. Voltage (if at Nominal Full Range, merely press the Full Range key).
- Set 4708 OUTPUT ON (and if NOT at Nominal Full Range, Select SET.)
- Use the OUTPUT $\downarrow \uparrow$ keys to adjust the OUTPUT

Nominal Cal. Points for 1V to 1000V Ranges.

DC Standard OUTPUT Voltage	4708 OUTPUT RANGE/ FREQUENCY	4708 Nominal OUTPUT Voltage	Freq. Band set by 4708
1.000000V	1V 1kHz	1.000000V	LF
1.000000V	1V 1MHz	1.000000V	*HF
10.00000V	10V 1kHz	10.00000V	LF
10.00000V	10V 1MHz	10.00000V	*HF
100.0000V	100V 1kHz	100.0000V	LF
100.0000V	100V 100kHz	100.0000V	HF
1000.000V	1000V 1kHz	1000.000V	LF
1000.000V	1000V 30kHz	1000.000V	HF1
700V at 100kHz:			
‘SET’ Calibration must be employed			
700.000V	1000V 100kHz	700.000V	HF2

*6. 2-wire HF Calibration (1V and 10V ranges - see table above)

NOTE: It is important that 4-wire and 2-wire calibrations are carried out in the correct sequence. Two stores are used, one for 4-wire (which sets the master HF cal), and the other containing the corrections to the 4-wire figures for 2-wire. The correct procedure is:

- Select 1V or 10V range.
- Select Remote Sense
- Do a 4-wire HF calibration as normal. This changes the numbers in the 4-wire calstore and clears the 2-wire calstore to zero.
- Deselect Remote Sense
- Do the 2-wire HF calibration. This sets the correction numbers into the 2-wire calstore. If steps b and c are omitted, only the 2-wire calibration is performed.

4708 AC Millivolts (LF) Calibration (1 mV - 100mV)

(Using calibrated 4708 1V Range, Inductive Voltage Divider (IVD) and AC DVM)

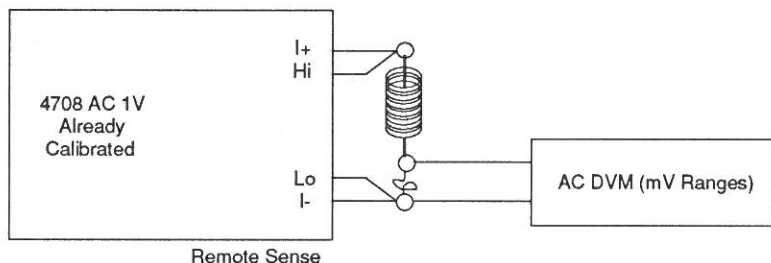

Standardization of DVM Millivolt Ranges

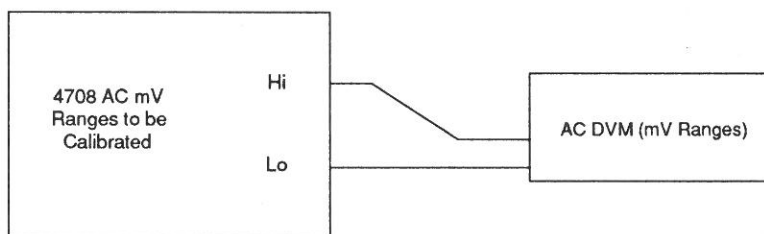

Calibration of 4708 LF Millivolt Ranges

Calibrate the 4708 at or close to the calibration points in the table, selecting SET as part of the following procedure:

1. 4708 IVD and AC DVM

With OUTPUT OFF, connect the circuit for Standardization.

2. IVD

Set ratio as required for the Millivolt Range to be calibrated.

3. AC DVM

Configure for measurement at the required Calibration Point.

4. 4708

- On AC FUNCTION, select 1V RANGE.
- Select the required Frequency Range.
- Use Frequency $\downarrow \uparrow$ keys to display the required Cal. Frequency.
- Use OUTPUT $\downarrow \uparrow$ keys to display the required IVD input voltage (if at Nominal Full range, merely press the Full range key).

- Set OUTPUT ON; note DVM reading as V1.
- Set OUTPUT OFF, and reconnect the circuit for Calibration.
- Select the required Millivolt OUTPUT RANGE.
- Use OUTPUT $\downarrow \uparrow$ keys to display the Cal. Voltage on the OUTPUT Display (if at Nominal Full range, merely press the Full range key).
- Set 4708 OUTPUT ON (and if NOT at Nominal Range, Select SET).
- Use the $\downarrow \uparrow$ keys to adjust the OUTPUT Display reading to obtain V1 on the DVM.
- Execute the calibration by pressing the CAL key. Set OUTPUT OFF.

Nominal Cal. Points for Millivolt Ranges.

IVD Ratio (1V Range to mV Range)	4708 OUTPUT RANGE/ FREQUENCY	4708 Nominal OUTPUT Voltage	Freq. band set by 4708
10 : 1	100mV 1kHz	100.0000mV	LF
100 : 1	10mV 1kHz	10.0000mV	LF
1000 : 1	1mV 1kHz	1.0000mV	LF

4708 AC Millivolts (HF) Calibration (1mV - 100mV)

(Using verified 4708 AC 1V and 10V Ranges, 10% Range Correction Factor and AC DVM).

Summary

The verified AC output values of 1V on the 1V Range; and 10V on the 10V Range are used to measure the 4708 linearity error at 1V on the 10V range. From the linearity measurement, a 10% of range Linearity and Scaling Factor 'C' is derived.

This factor is subsequently used to correct the 4708 output setting at 10% of range, to standardize a DVM for calibration of the next range down.

Calibrate the 4708 at or close to the calibration points in the table.

N.B. These calibrations are not fully traceable.

Note:

It is assumed that the 1V and 10V ranges have been calibrated at the required HF calibration points. It is also assumed that the Millivolt (LF) Calibration has been completed.

Interconnections

FIG 1 (10V and 1V Ranges)

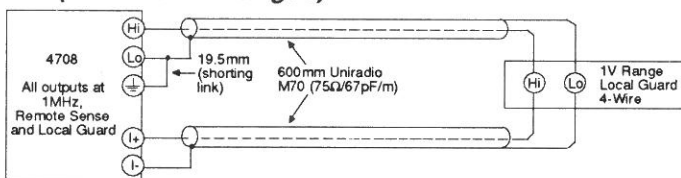
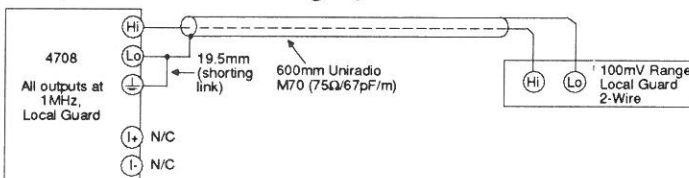

FIG 2 (100mV to 1mV Ranges)



Nominal Cal. Points for HF Millivolt Ranges

4708 AC OUTPUT RANGE/ FREQUENCY	4708 Nominal OUTPUT Voltage	Freq. Band set by 4708
100mV 1MHz	100.0000mV	HF
10mV 1MHz	10.0000mV	HF
1mV 1MHz	1.0000mV	HF

Stage 1 Derive the Linearity and Scaling Factor 'C' as follows (C is a number of value close to 0.1)

- Ensure that the Millivolts (LF) Calibration has been completed.
Ensure that the 4708 has been calibrated and verified at AC 10V and 1V HF (1MHz) Full Range. Record the measured values as follows:

4708 10V FR setting – 10.000,00V

Actual output voltage – 'V1'

4708 1V FR setting – 1.000,000V

Actual output voltage – 'V2'

- Calculate 1V correction 'V3' = 1/V2
- With OUTPUT OFF connect a DVM to the 4708 terminals using the exact 4-wire connections as in Fig.1. Set the DVM to measure AC on its 1V range.
- On 4708, select the 1V range and Remote Sense, Set Frequency to 1MHz.
Set OUTPUT display reading to V3.
Set OUTPUT ON, and note the DVM reading as 'V1'.
Set OUTPUT OFF.
- On 4708, select the 10V range (Remote Sense).
Set 4708 OUTPUT display reading to 1V.
Set OUTPUT ON
Adjust the OUTPUT display reading as 'Vt'.
- Note the 4708 OUTPUT display reading as 'V4'.

Set OUTPUT OFF.

- g. From the values V1 and V4 calculate the 10V range linearity correction and scaling factor 'C' as follows:

$$C = (V1 \times V4) / 100$$

Note:

The optimum resolution quoted above the boxes in this column may not be achievable with the DVM in use. In these cases it is permissible to reduce the resolution by a maximum of 1 digit only.

Record in 6.5 digits resolution

V1 =

V2 =

V3 =

Vt is a transfer value

Vt =

Record in 6.5 digits resolution

V4 =

Calculate in 6.5 digits resolution

C =

N.B. The following calibration from the front panel can only be carried out if the IEEE Address switch on the rear panel is set to Address 31 (11111).

Stage 2 To Calibrate the AC 100mV Range Full Range Output

- Insert the Calibration security key into the 'Calibration Enable' switch on the rear panel, and turn to 'ENABLE'.
- Ensure that the DVM is still connected to the 4708 terminals as shown in Fig. 1.
- Set the 4708 to the AC 1V range. Calculate the value 'V3 x C'.

Set OUTPUT display to this value.

- Set the AC DVM to measure 100mV
- Set 4708 OUTPUT ON, allowing the output to settle. Note the DVM reading as 'V(100t)'.
- Set 4708 OUTPUT OFF and reconnect the DVM to the 4708 terminals in 2-wire as shown in Fig. 2.
- Set 4708 to its AC 100mV range. (Remote Sense is automatically deselected.) Set OUTPUT ON and adjust the 4708 Output for a DVM reading of V(100t). Press the 'CAL' pushbutton and observe the DVM reading.
- Repeat operation (g) until the post-CAL DVM reading is within 1µV of V(100t). (If calibrating a Spot Frequency, re-press the SPOT key to deselect).

Stage 3 To Calibrate the AC 10mV Range Full Range Output

- Ensure that the DVM is still connected to the 4708 terminals as shown in Fig. 2. Reselect the Spot Frequency if required.
- Ensure that the 4708 is set to the AC 100mV range. Calculate the value '100mV x C' Set OUTPUT display to this value.
- Set the AC DVM to measure 10mV.
- Allow the output to settle. Note the DVM reading as 'V(10t)'.
- Set 4708 to its AC 10mV range.
- Adjust the 4708 Output for a DVM reading of V(10t). Press the 'CAL' pushbutton and observe the DVM reading.
- Repeat operation (f) until the post-CAL DVM reading is within 1µV of V(10t). Deselect the Spot Frequency if selected at (a).

Calculate in 6.5 digits resolution

V3 x C =

V(100t) is a transfer value

V(100t) =

Calculate in 6.5 digits resolution

$100\text{mV} \times C =$

$V(10t)$ is a transfer value

$V(10t) =$

Stage 4 To Calibrate the 1mV Range Full Range Output

- a. Ensure that the DVM is still connected to the 4708 terminals as shown in Fig. 2.
- b. Ensure that the 4708 is set to the 10mV range.
Calculate the value ' $10\text{mV} \times C$ '
Set OUTPUT display to this value.
- c. Set the DVM to measure 1mV.
- d. Allow the output to settle.
Note the DVM reading as ' $V(1t)$ '.
- e. Set 4708 to its 1mV range.
- f. Adjust the 4708 Output to give a settled DVM reading of $V(1t)$.
Press the 'CAL' pushbutton and observe the DVM reading.
- g. Repeat operation (f) until the post-CAL DVM reading is within $1\mu\text{V}$ of $V(1t)$.
Calculate in 5.5 digits resolution

$10\text{mV} \times C =$

$V(1t)$ is a transfer value

$V(1t) =$

Stage 5 Calibration Disable

Turn the Calibration security key, inserted in the 'CALIBRATIONENABLE' switch on the rear panel, to 'RUN'. Remove the key.

4708 AC Current Calibration (1mA - 1A)

(Using Thermal Transfer, Current Shunts and DC Current Standard)

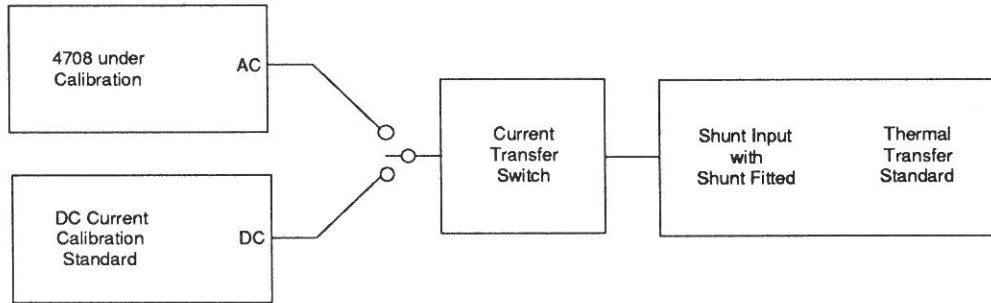

Calibrate the 4708 at or close to the calibration points in the table, selecting SET as required as part of the following procedure:

Calibrate 1mA Range only if the Thermal Transfer is adequately calibrated at these levels.

- g. Use the OUTPUT $\downarrow \uparrow$ keys to adjust the OUTPUT display reading to obtain a null on the Thermal Transfer.
- h. Execute the calibration by pressing the CAL key. Set OUTPUT OFF.

1. Thermal Transfer Standard

Configure for DC measurement at the required Cal. Current and connect the appropriate shunt.

2. DC Current Standard

- a. With OUTPUT OFF, connect across the Thermal Transfer shunt, and set to the required Cal. Current.
- b. Set OUTPUT ON.

3. Thermal Transfer Standard.

Adjust for null at the Cal. Current.

4. DC Current Standard

- a. Set OUTPUT OFF.
- b. Disconnect from the shunt.

5. 4708

- a. With OUTPUT OFF, connect the I+ and I- terminals across the Shunt.
- b. On ACI FUNCTION, select the required OUTPUT RANGE.
- c. Select the required FREQUENCY RANGE.
- d. Use FREQUENCY $\downarrow \uparrow$ keys to display the required Cal. Frequency.
- e. Use OUTPUT $\downarrow \uparrow$ keys to display the required Cal. Current (if at Nominal Full Range, press the Full Range key).
- f. Set 4708 OUTPUT ON (and if NOT at Nominal Full Range, Select SET).

Nominal Cal. Points for 1mA to 1A Ranges.

DC Standard OUTPUT Current	4708 OUTPUT RANGE/ FREQUENCY	4708 Nominal OUTPUT Current	Freq. band set by 4708
1.000000mA	1mA 300Hz	1.000000mA	LF
1.000000mA	1mA 5kHz	1.000000mA	HF
10.000000mA	10mA 300Hz	10.000000mA	LF
10.000000mA	10mA 5kHz	10.000000mA	HF
100.000000mA	100mA 300Hz	100.000000mA	LF
100.000000mA	100mA 5kHz	100.000000mA	HF
1.000000A	1A 300Hz	1.000000A	LF
1.000000A	1A 5kHz	1.000000A	HF

APPENDIX 1 4708 AC Current Calibration (100 μ A - 1A)

(Using verified 4708 1V Range, Calibrated Standard AC Shunts and AC DVM)

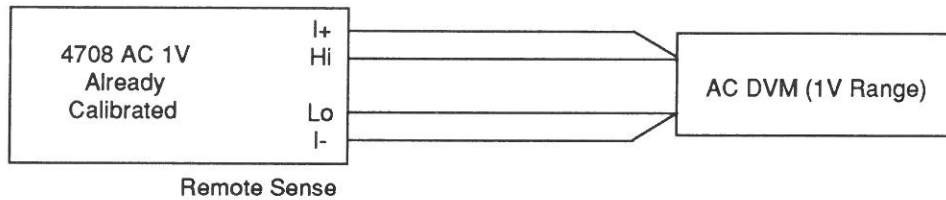

Standardization of DVM 1V Range

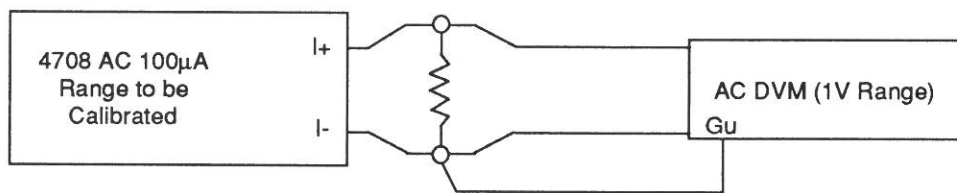

Calibration of 4708 Current Ranges

Calibrate the 4708 at or close to the calibration points in the table, selecting SET as required as part of the following procedure:

1. 4708 and AC DVM

With OUTPUT OFF, connect the 4708 and DVM for Standardization. Select 1V Range on the AC DVM.

2. 4708

- a. Set to 1V Range at the Calibration Frequency and adjust for calibrated 1.000000V output.
- b. Set OUTPUT ON and note the DVM reading as V1
- c. Set OUTPUT OFF, and reconnect the test circuit for Calibration, using the correct shunt for the range to be calibrated.
- d. On ACI Function, select the required OUTPUT RANGE.
- e. Select the required FREQUENCY RANGE.
- f. Use FREQUENCY $\downarrow \uparrow$ keys to display the required Cal. Frequency.
- g. Use OUTPUT $\downarrow \uparrow$ keys to display the required Cal. Current (if at Nominal Full Range, press the Full Range key).
- h. Set 4708 OUTPUT ON (and if NOT AT Nominal Full Range, Select SET).
- j. Use the OUTPUT $\downarrow \uparrow$ keys to adjust the OUTPUT Display reading to obtain a DVM reading of V1.
- k. Execute the calibration by pressing the Cal key. Set OUTPUT OFF.

Nominal Cal. Points for 100 μ A to 1A Ranges.

4708 OUTPUT RANGE/ FREQUENCY	4708 Nominal OUTPUT Current	Freq. Band set by 4708
100 μ A 300Hz	100.0000 μ A	LF
100 μ A 5kHz	100.0000 μ A	HF
1mA 300Hz	1.000000mA	LF
1mA 5kHz	1.000000mA	HF
10mA 300Hz	10.00000mA	LF
10mA 5kHz	10.00000mA	HF
100mA 300Hz	100.0000mA	LF
100mA 5kHz	100.0000mA	HF
1A 300Hz	1.000000A	LF
1A 5kHz	1.000000A	HF



Datron Sales and Service Representatives Worldwide

COUNTRY and REPRESENTATIVE	Telephone	Telex	Fax
AUSTRALIA			
Scientific Devices Pty. Ltd 2 Jacks Road, South Oakleigh, Victoria 3167	3 579 3622	AA32742	3 579 0971
AUSTRIA			
Walter Rekirsch Elektronisch Geraete GmbH & Co. Obachgasse 28, A-1220 Wien	222 253626	134759	222 2572 75
BELGIUM			
Air-Parts International B. V. Avenue Huart-Hamoir, 1-Box 19, 1030 Bruxelles	2 241 6460	25146 AP1 B	2 241 8130
BRAZIL			
Comercial Goncalves Rua Deocleciana, 77, Cep 01106 Ponte Pequena, Sao Paulo SP	11 2294044	22104 34272	----
CHINA			
Tianjin Zhong Huan Scientific Instruments Corp. No. 59 Zhao Jia Chang Street, Hong Qiao Section, Tianjin	Tianjin 251941	----	----
DENMARK			
Instrutek A/S, Christiansholmsgade 8700 Horsens	5 611100	61656	5 615 658
EASTERN EUROPE			
Amtest Associates Ltd Amtest House, 75-79 Guildford Street, Chertsey, Surrey KT16 9AS, England	0932 568355	928855	0932 561919
EGYPT & MIDDLE EAST			
EPIC 20-22 Ashmoun St, PO Box 2682, Horriya, Heliopolis	2 661767 2 669861	23033 CHAKA UN 23315 EPIC UN	2 662839 2 668924
FINLAND			
Profelec OY PO Box 67, 00421 Helsinki 42	0 566 4477	125225 PROFE SF	0 566 2998

COUNTRY and REPRESENTATIVE	Telephone	Telex	Fax
FRANCE			
M. B. Electronique 606 Rue Fourny, Zi de Buc, 78530 Buc	1 39 568131	695414	1 39 565344
WEST GERMANY			
Wavetek Electronics GmbH Hans-Pinsel Strasse 9-10, 8013 Haar bei München	89 461090	841 5211296 WVTKD	89 463223
GREECE			
American Technical Enterprises SA PO Box 3156, 48 Patission Street, Athens 147	1 8219470	216046 ATE GR	-----
HONG KONG			
Eurotherm (Far East) Ltd 21/F Kai Tak Commercial Building 317-321 Des Voeux Road C, Hong Kong	5 411268	72449 EFELD HX	5 8151540
INDIA			
Technical Trade Links 42, Navketan Estate, Mahakali Caves Road, Andheri (East), Post Box No. 9447, Bombay 400 093	22 6322412	11 79261 TTL IN	9122 634 2204
IRELAND			
Euro Instruments & Electronics Euro House, Swords Road, Santry, Dublin 9	0001 425 666	318121	0001 425 497
ISRAEL			
Racom Electronics Co. Ltd 7 Kehilat Saloniki St., P. O. Box 21120, Tel-Aviv 61210	3 491922	33808 RACEL IL	3 491 576
ITALY(1)			
Sistrel SPA Via Pellizza da Volpedo 59 20092 Cinisello Balsamo, Milano	02 618 1893	334643	02 618 2440
ITALY(2)			
Sistrel SPA Viale Erminio Spalla 41 00142 Roma	06 504 0273	625857	06 504 0067
ITALY(3)			
Sistrel SPA Via Cintia Parco S. Paolo 35 80126 Napoli	081 767 9700	-----	081 766 1361
JAPAN			
G & G Japan Inc No. 406, 12-14, 4-Chome, Hongoh, Bunkyo-ku, Tokyo	3 8130971	2722884 ICHAIN J	3 8159216
KOREA			
Sama Trading Corporation CPO Box 2447, Seoul	2 733 9336	K26375 SAMATR	2 733 8481

COUNTRY and REPRESENTATIVE	Telephone	Telex	Fax
MALAYSIA			
Mecomb Singapore Ltd Sime Darby Centre, 895 Dunearn Road, 04-2 Singapore 2158	469 8833	RS 23178	467 1905
NETHERLANDS			
Air Parts International BV PO Box 255, 12 Kalkovenweg, 2400 AG Alphen aan den Rijn	1720 43221	39564	1720 20651
NEW ZEALAND			
G. T. S. Engineering Ltd 5 Porters Avenue, Eden Terrace, PO Box 9613 Newmarket AUCKLAND	9 392 464	-----	9 392 968
NORWAY			
Morgenstjerne & Co. Konghellegaten 3/5, 0569 Oslo 5	2 356110	71 719 MOROF	2 381457
PORTUGAL			
Decada-Espectral Av. Bombeiros Voluntarios, Lote 102b Miraflores/Algee 1495 Lisboa	1 4103420	15515 ESPEC P	1 4101844
SINGAPORE			
Mecomb Singapore Ltd Sime Darby Centre, 895 Dunearn Road, 04-2 Singapore 2158	469 8833	RS 23178	467 1905
SOUTH AFRICA			
Altech Instruments (Pty) Ltd PO Box 39451, Wynberg 2018	11 887 7455	422033	-----
SPAIN			
ESSA (Equipos y Systemas SA) C/Apolonio Morales 13-B, Madrid 16	1 458 0150	831 42856	-----
SWEDEN			
Ferner Electronics AB Snormakarvagen 35, Box 125, S-16126 Stockholm-Bromma	8 802540	10312 FERNER S	8 250226
SWITZERLAND			
Kontron Electronic AG Bernstrasse-Süd 169, 8048 Zurich	1 435 4111	822196 + KOEL CH	1 432 2464
TAIWAN			
Evergo Corporation Room A, 9th Floor, 305 Section, 3 Nan King East Road, P. O. Box 96-546, Taipei	2 7150283/4/5	27027 EVERGOEC	2 7122466

COUNTRY and REPRESENTATIVE	Telephone	Telex	Fax
UNITED KINGDOM			
Datron Instruments Ltd Hurricane Way, Norwich Airport, Norwich, Norfolk NR6 6JB, England	0603 404824	975173	0603 483670
UNITED STATES of AMERICA			
Datron Instruments Inc c/o Wavetek RF Products Inc. 5808 Churchman Bypass, Indianapolis, Indiana 46203	(317) 787 3915	TWX (810) 341 3226	(317) 788 5999
Wavetek Northeast Area Sales 1 Executive Blvd. Suite 206, Suffern New York 10901	(914) 357 5544	----	(914) 357 5609
Wavetek Western Area Sales 9045 Balboa Avenue, San Diego, California 92123	(619) 565 9234	TWX (910) 335 2007	(619) 565 9558

For customers in countries not listed please contact DATRON INSTRUMENTS in the United Kingdom:

Datron Instruments Ltd Hurricane Way, Norwich Airport, Norwich, Norfolk NR6 6JB, England	0603 404824	975173	0603 483670
---	-------------	--------	-------------